

Test Report of FCC CFR 47 Part 15 Subpart C

On Behalf of

Graupner CO.,Ltd

FCC ID: SNL-16006200
Product Description: 2.4GHz Radio Control Computer Receiver
Model No.: X-8N
Supplementary Model: N/A

Prepared for: **Graupner CO.,Ltd**
8th F,202 Dong,Chunui Techno-Park2,18, Bucheon-ro 198beon-gil,Wonmi-gu,Bucheon-shi,Kyungki-do, South Korea

Prepared by: **Bontek Compliance Testing Laboratory Co., Ltd**
1/F, Block East H-3, OCT Eastern Ind. Zone, Qiaocheng East Road, Nanshan, Shenzhen, China
Tel: 86-755-86337020
Fax: 86-755-86337028

Report No.: BCT14ER204E
Issue Date: June 10, 2014
Test Date: May21~ June 10, 2014

Tested by:



Jiankuai.Li

Reviewed by:

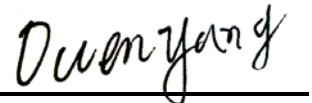

Owen Yang

Approved by:

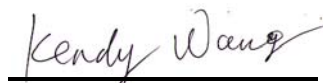

Kendy Wang

TABLE OF CONTENTS

1. GENERAL INFORMATION4

1.1 PRODUCT DESCRIPTION FOR EQUIPMENT UNDER TEST (EUT)4

1.2 RELATED SUBMITTAL(S) / GRANT (S) AND TEST METHODOLOGY5

1.3 TEST FACILITY5

FCC – REGISTRATION No.: 9703185

2. SYSTEM TEST CONFIGURATION6

2.1 EUT CONFIGURATION6

2.2 EUT EXERCISE6

2.3 GENERAL TEST PROCEDURES6

2.4 MEASUREMENT UNCERTAINTY6

2.5 TEST EQUIPMENT LIST AND DETAILS7

3. SUMMARY OF TEST RESULTS7

4. TEST OF AC POWER LINE CONDUCTED EMISSION8

4.1 APPLICABLE STANDARD8

4.2 TEST SETUP DIAGRAM8

4.3 TEST RESULT8

5. TEST OF HOPPING CHANNEL BANDWIDTH9

5.1 APPLICABLE STANDARD9

5.2 EUT SETUP9

5.3 TEST EQUIPMENT LIST AND DETAILS9

5.4 TEST PROCEDURE9

5.5 TEST RESULT9

6. TEST OF HOPPING CHANNEL SEPARATION12

6.1 APPLICABLE STANDARD12

6.2 EUT SETUP12

6.3 TEST EQUIPMENT LIST AND DETAILS12

6.4 TEST PROCEDURE12

6.5 TEST RESULT12

7. TEST OF NUMBER OF HOPPING FREQUENCY15

7.1 APPLICABLE STANDARD15

7.2 EUT SETUP15

7.3 TEST EQUIPMENT LIST AND DETAILS15

7.4 TEST PROCEDURE15

7.5 TEST RESULT15

8. TEST OF DWELL TIME OF EACH FREQUENCY17

8.1 APPLICABLE STANDARD17

8.2 EUT SETUP17

8.3 TEST EQUIPMENT LIST AND DETAILS17

8.4 TEST PROCEDURE17

8.5 TEST RESULT17

9. TEST OF MAXIMUM PEAK OUTPUT POWER21

9.1 APPLICABLE STANDARD21

9.2 EUT SETUP21

9.3 TEST EQUIPMENT LIST AND DETAILS21

9.4 TEST PROCEDURE21

9.5 TEST RESULT21

10. TEST OF BAND EDGES EMISSION24

10.1 APPLICABLE STANDARD24

10.2 EUT SETUP24

10.3 TEST EQUIPMENT LIST AND DETAILS24

10.4 TEST PROCEDURE24

10.5 TEST RESULT25

11. TEST OF SPURIOUS RADIATED EMISSION27
11.1 APPLICABLE STANDARD 27
11.2 EUT SETUP 27
11.3 TEST EQUIPMENT LIST AND DETAILS..... 28
11.4 TEST PROCEDURE 28
11.5 TEST RESULT 29

12. ANTENNA REQUIREMENT42
12.1 STANDARD APPLICABLE 42
12.2 ANTENNA CONNECTED CONSTRUCTION 42

1. GENERAL INFORMATION

1.1 Product Description for Equipment Under Test (EUT)

Client Information

Applicant:	Graupner CO.,Ltd
Address of applicant:	8 th F,202 Dong,Chunui Techno-Park2,18, Bucheon-ro 198beon-gil,Wonmi-gu, Bucheon-shi,Kyungki-do, South Korea
Manufacturer 1:	SJ Technology(Shenzhen)Co.,Ltd
Address of manufacturer:	F6, 1 Bldg, A Area, Yintianxifa Industrial Area, Xixiang Town, Baoan District Shenzhen, Guangdong Province, China
Manufacturer 2:	Graupner CO.,Ltd
Address of manufacturer:	8 th F,202 Dong,Chunui Techno-Park2,18, Bucheon-ro 198beon-gil,Wonmi-gu, Bucheon-shi,Kyungki-do, South Korea

General Description of E.U.T

Items	Description
EUT Description:	2.4GHz Radio Control Computer Receiver
Model No.:	X-8N
Trade Name:	HoTT
Supplementary Model:	N/A
Frequency Band:	2403.920~2472.056MHz
Channel Spacing:	2 MHz
Number of Channels:	35
Type of Modulation:	FHSS
Antenna Gain	1.2dBi
Antenna Type:	Integral Antenna
Rated Voltage:	Input: DC 3.6V~6V

Remark: * The test data gathered are from the production sample provided by the manufacturer.

1.2 Related Submittal(s) / Grant (s) and Test Methodology

The tests were performed based on the Electromagnetic Interference (EMI) tests performed on the EUT. Both conducted and radiated testing were performed according to the procedures in ANSI C63.4 - 2003 Radiated testing was performed at an antenna to EUT distance 3 meters.

The tests were performed in order to determine compliance with FCC Part 15, Subpart C, and section 15.203, 15.207, 15.209 and 15.247 rules. Test was carried out according to the above mentioned FCC rules and the FCC publication notice DA 00-705: Filing and Measurement Guidelines for Frequency Hopping Spread Spectrum Systems

1.3 Test Facility

All measurement required was performed at laboratory of Shenzhen CTL Testing Technology Co., Ltd. at Floor 1-A, Baisha Technology Park, No.3011, Shahexi Road, Nanshan District, Shenzhen, China 518055.

The test facility is recognized, certified, or accredited by the following organizations:

FCC – Registration No.: 970318

Shenzhen CTL Testing Technology Co., Ltd. EMC Laboratory has been registered and fully described in a report filed with the (FCC) Federal Communications Commission. The acceptance letter from the FCC is maintained in our files. Registration 970318, December, 2013.

2. SYSTEM TEST CONFIGURATION

2.1 EUT Configuration

The EUT configuration for testing is installed on RF field strength measurement to meet the Commissions requirement and operating in a manner that intends to maximize its emission characteristics in a continuous normal application.

2.2 EUT Exercise

The calibrated antennas used to sample the radiated field strength are mounted on a non-conductive, motorized antenna mast 3 or 10 meters from the leading edge of the turntable.

2.3 General Test Procedures

Conducted Emissions: The EUT is placed on the turntable, which is 0.8 m above ground plane. According to the requirements in Section 7.1 of ANSI C63.4-2003 Conducted emissions from the EUT measured in the frequency range between 0.15 MHz and 30MHz using CISPR Quasi-Peak detector mode.

Radiated Emissions: The EUT is a placed on as turntable, which is 0.8 m above ground plane. The turntable shall rotate 360 degrees to determine the position of maximum emission level. EUT is set 3m away from the receiving antenna, which varied from 1m to 4m to find out the highest emission. And also, each emission was to be maximized by changing the polarization of receiving antenna both horizontal and vertical. In order to find out the maximum emissions, exploratory radiated emission measurements were made according to the requirements in Section 13.1.4.1 of ANSI C63.4-2003.

2.4 Measurement Uncertainty

Where relevant, the following measurement uncertainty levels have been estimated for tests performed on the apparatus:

Parameter	Uncertainty
Power Line Conducted Emission	+/- 2.3 dB
Radiated Emission	+/- 3.4 dB

Uncertainty figures are valid to a confidence level of 95%.

2.5 Test Equipment List and Details

Test equipments list of Shenzhen CTL Testing Technology Co., Ltd.

No.	Instrument no.	Equipment	Manufacturer	Model No.	S/N	Last Calculator	Due Calculator
1	BCT-EMC001	EMI Test Receiver	R&S	ESCI	100687	2014-4-25	2015-4-24
2	BCT-EMC002	EMI Test Receiver	R&S	ESPI	100097	2013-11-1	2014-10-31
3	BCT-EMC003	Amplifier	HP	8447D	1937A02492	2014-4-25	2015-4-24
4	BCT-EMC018	TRILOG Broadband Test- Antenna	SCHWARZBECK	VULB9163	9163-324	2014-4-25	2015-4-24
5	BCT-EMC021	Triple-Loop Antenna	EVERFINE	LLA-2	711002	2013-11-1	2014-10-31
6	BCT-EMC026	RF POWER AMPLIFIER	FRANKONIA	FLL-75	1020A1109	2014-4-25	2015-4-24
7	BCT-EMC029	6DB Attenuator	FRANKONIA	N/A	1001698	2014-4-25	2015-4-24
8	BCT-EMC032	10dB attenuator	ELECTRO- METRICS	EM-7600	836	2014-4-25	2015-4-24
9	BCT-EMC036	Spectrum Analyzer	R&S	FSP	100397	2013-11-1	2014-10-31
10	BCT-EMC037	Broadband preamplifier	SCHWARZBECK	BBV9718	9718-182	2014-4-25	2015-4-24
11	BCT-EMC039	Horn Antenna	SCHWARZBECK	BBHA 9120D	0437	2014-4-25	2015-4-24
12	BCT-EMC038	Horn Antenna	SCHWARZBECK	BBHA9170	0483	2014-4-25	2015-4-24

3. SUMMARY OF TEST RESULTS

FCC Rules	Description of Test	Result
FCC §15.207	AC Power Line Conducted Emission	Not Application
FCC §15.247(a)(1)	Hopping Channel Bandwidth	Pass
FCC §15.247(a)(1)	Hopping Channel Separation	Pass
FCC §15.247(a)(1)	Number of Hopping Frequency Used	Pass
FCC §15.247(a)(1)(iii)	Dwell Time of Each Frequency	Pass
FCC §15.247(b)(1)	Maximum Peak Output Power	Pass
FCC §15.247(d)	Band Edges Emission	Pass
FCC §15.247(d)	Spurious Radiated Emission	Pass
FCC §15.203/15.247(b)/(c)	Antenna Requirement	Pass

4. TEST OF AC POWER LINE CONDUCTED EMISSION

4.1 Applicable Standard

Refer to FCC §15.207.

For a Low-power Radio-frequency Device is designed to be connected to the AC power line, the radio frequency voltage that is conducted back onto the AC power line on any frequency or frequencies within the band 150 kHz to 30 MHz shall not exceed below limits table.

Frequency Range (MHz)	Limits (dBuV)	
	Quasi-Peak	Average
0.150~0.500	66~56	56~46
0.500~5.000	56	46
5.000~30.00	60	50

4.2 Test Setup Diagram

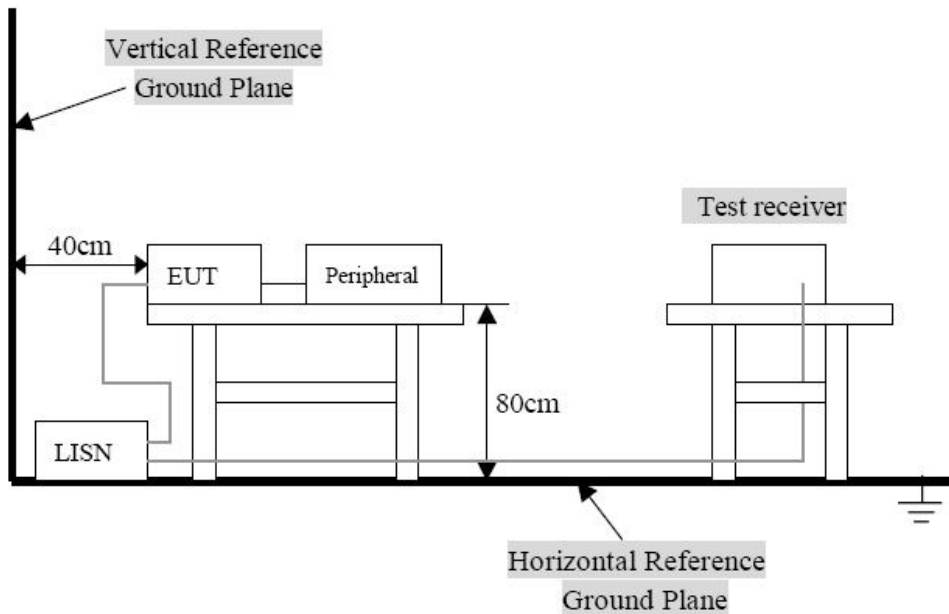

Remark: The EUT was connected to a 120VAC/ 60Hz power source.

4.3 Test Result

Notes: The EUT is powered by battery without AC mains(with battery),this test is not applicable.

5. Test of Hopping Channel Bandwidth

5.1 Applicable Standard

Section 15.247(a)(1): Frequency hopping systems shall have hopping channel carrier frequencies separated by a minimum of 25 kHz or the 20 dB bandwidth of the hopping channel, whichever is greater.

5.2 EUT Setup

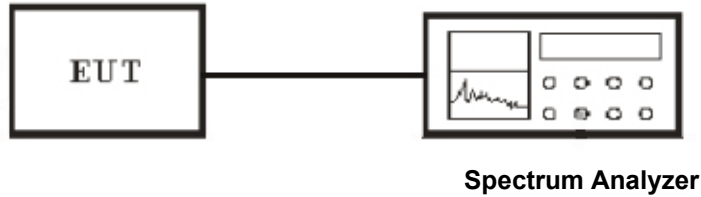

5.3 Test Equipment List and Details

See section 2.5.

5.4 Test Procedure

1. The transmitter output was connected to the spectrum analyzer through an attenuator.
2. Use the following spectrum analyzer settings:
 Span = approximately 2 to 3 times the 20 dB bandwidth, centered on a hopping channel
 RBW \geq 1% of the 20 dB bandwidth, VBW \geq RBW
 Sweep = auto
 Detector function = peak
 Trace = max hold
3. The spectrum width with level higher than 20dB below the peak level.
4. Repeat above 1~3 points for the middle and highest channel of the EUT.

5.5 Test Result

Temperature (°C) : 22~23	EUT: 2.4GHz Radio Control Computer Receiver
Humidity (%RH) : 50~54	M/N: X-8N
Barometric Pressure (mbar) : 950~1000	Operation Condition: Tx Mode

Modulation Type	Channel No.	Frequency (MHz)	20dB Bandwidth (kHz)	Min. Limit (kHz)
FHSS	Low	2403.920	936	>25
FHSS	Middle	2435.989	910	>25
FHSS	High	2472.056	930	>25

Channel Low:

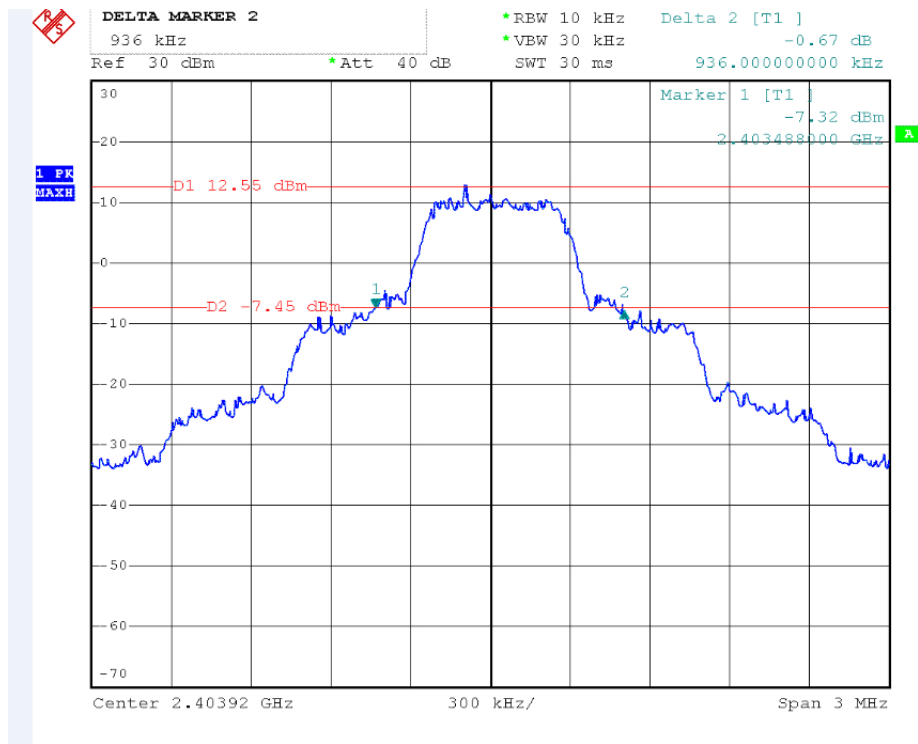

Channel Middle:

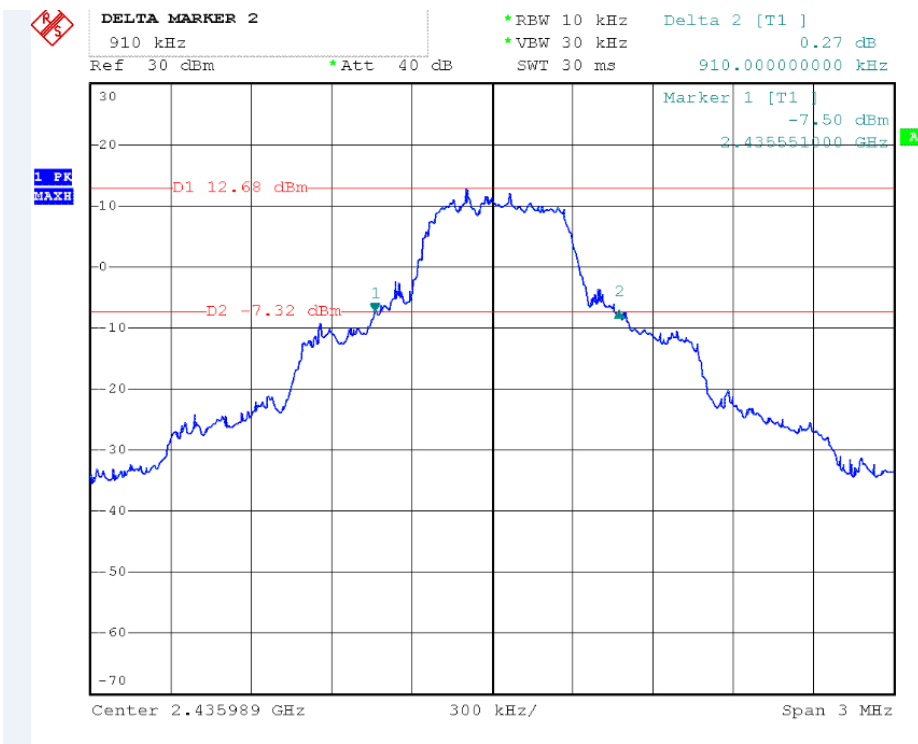

Channel High:

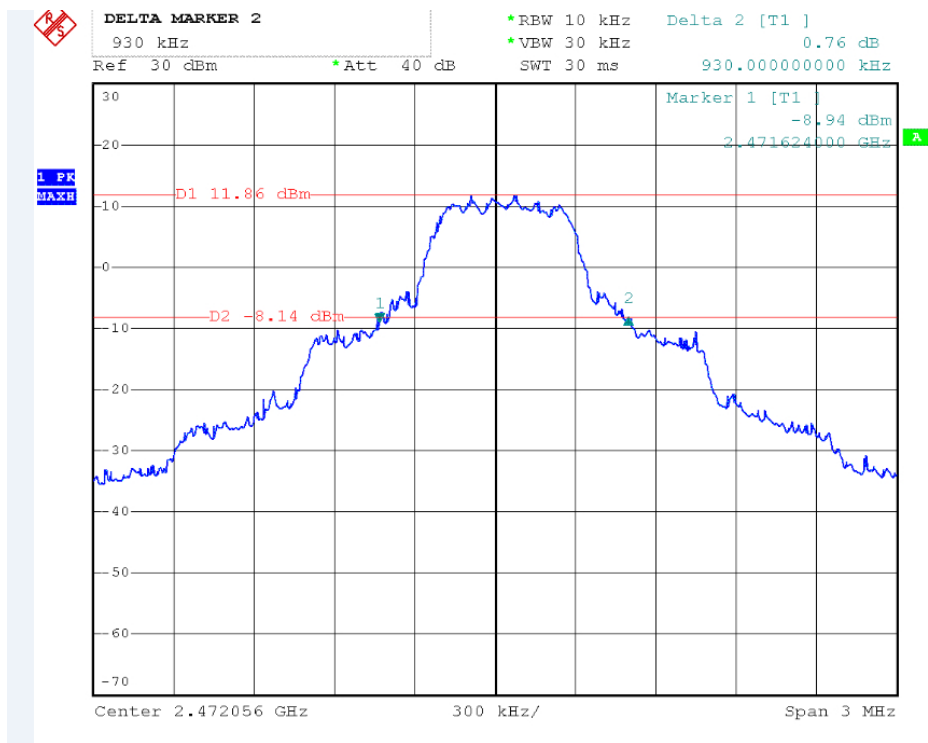

6. Test of Hopping Channel Separation

6.1 Applicable Standard

Section 15.247(a)(1): Frequency hopping systems shall have hopping channel carrier frequencies separated by a minimum of 25 kHz or the 20 dB bandwidth of the hopping channel, whichever is greater.

6.2 EUT Setup

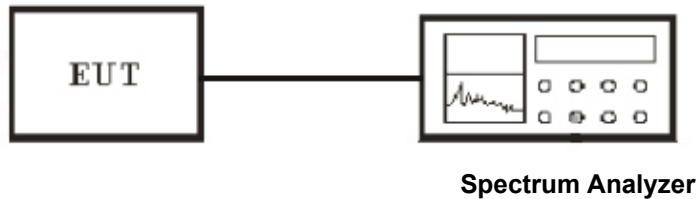

6.3 Test Equipment List and Details

See section 2.5.

6.4 Test Procedure

1. The transmitter output was connected to the spectrum analyzer through an attenuator.
2. Set RBW of spectrum analyzer to 100KHz and VBW to 100KHz.
3. Set Detector to Peak, Trace to Max Hold and Sweep Time is Auto.
4. The Hopping Channel Separation is defined as the separation between 2 neighboring hopping frequencies.
5. Repeat above 1~3 points for the middle and highest channel of the EUT.

6.5 Test Result

Temperature (°C) : 22~23	EUT: 2.4GHz Radio Control Computer Receiver
Humidity (%RH) : 50~54	M/N: X-8N
Barometric Pressure (mbar) : 950~1000	Operation Condition: Tx Mode

Modulation Type	Frequency (MHz)	Channel Separation (MHz)	Min. Limit (kHz)
FHSS	2403.920~2405.920	2.008	>25
FHSS	2435.989~2437.989	2.008	>25
FHSS	2470.056~2472.056	2.008	>25

Channel Low:

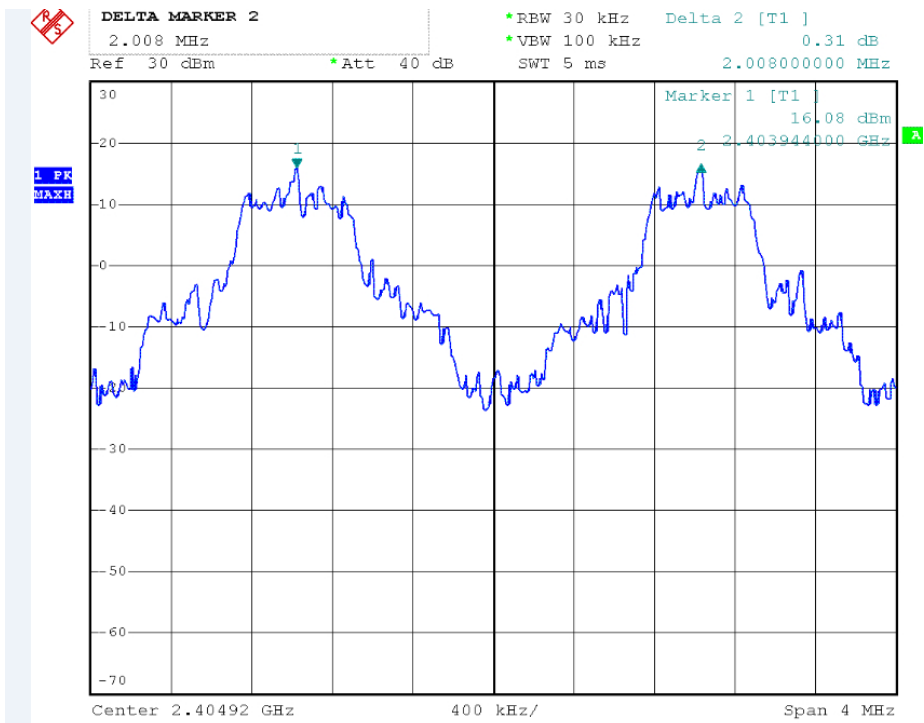

Channel Middle:

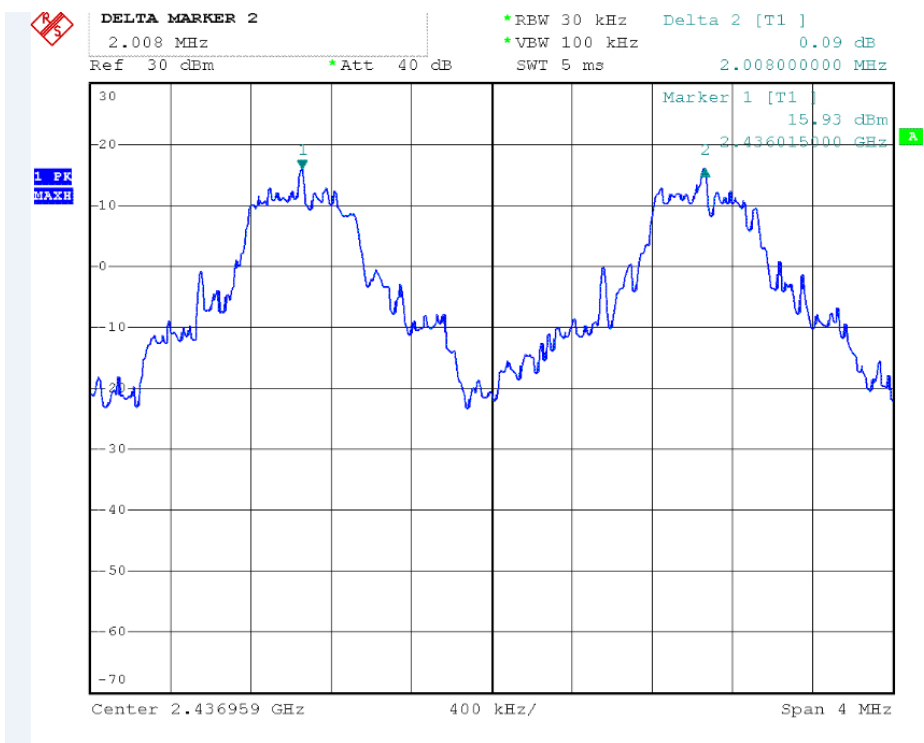

Channel High:

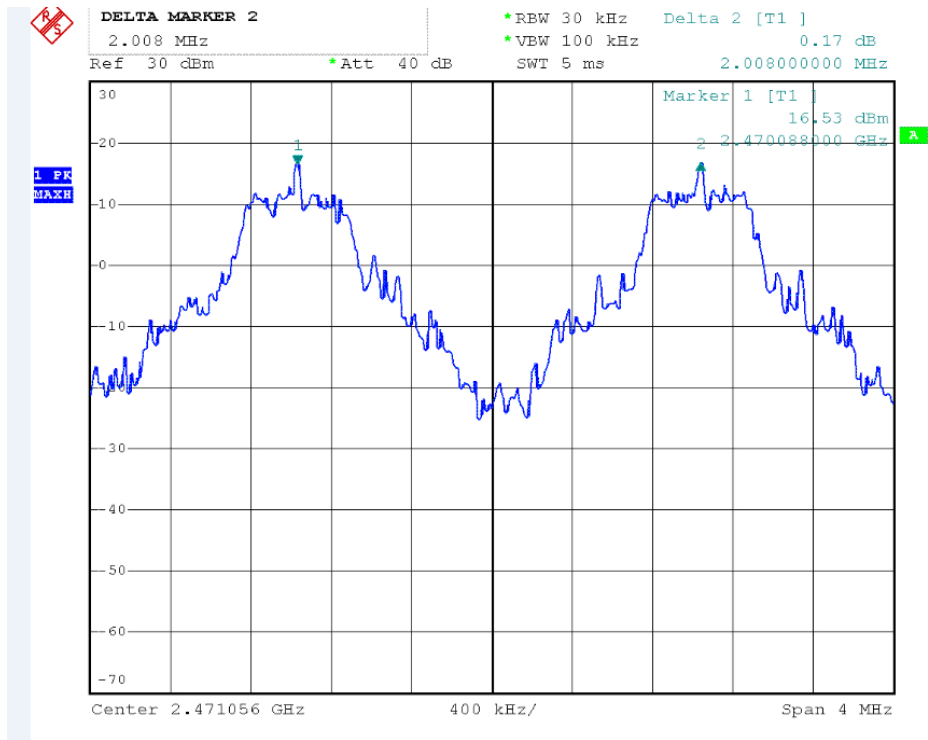

7. Test of Number of Hopping Frequency

7.1 Applicable Standard

Section 15.247(a)(1)(iii): For frequency hopping systems operating in the 2400-2483.5 MHz band employing at least 15 non-overlapping hopping channels. Frequency hopping system which use fewer than 75 hopping frequencies may employ intelligent hopping techniques to avoid interference to other transmissions. Frequency hopping system may avoid or suppress transmissions on a particular hopping frequency provided that a minimum of 15 non-overlapping channels are used.

7.2 EUT Setup

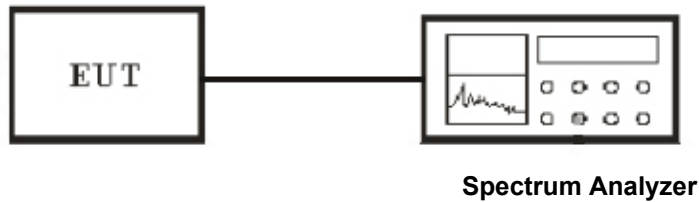

7.3 Test Equipment List and Details

See section 2.5.

7.4 Test Procedure

1. The transmitter output was connected to the spectrum analyzer through an attenuator.
2. Set RBW of spectrum analyzer to 100KHz and VBW to 100KHz.
3. Set Detector to Peak, Trace to Max Hold and Sweep Time is Auto.
4. Observe frequency hopping in 2400MHz~2483.5MHz, there are at least 32 non-overlapping channels.
5. Repeat above 1~3 points for the middle and highest channel of the EUT.

7.5 Test Result

Temperature (°C) : 22~23	EUT: 2.4GHz Radio Control Computer Receiver
Humidity (%RH) : 50~54	M/N: X-8N
Barometric Pressure (mbar) : 950~1000	Operation Condition: Tx Mode

Modulation Type	Frequency (MHz)	Number of Hopping Channels	Min. Limit
FHSS	2403.920~2472.056	35	≥ 15



DELTA MARKER 2
68.108 MHz
Ref 30 dBm *Att 40 dB

*RBW 100 kHz Delta 2 [T1]
*VBW 300 kHz -0.99 dB
SWT 10 ms 68.108000000 MHz

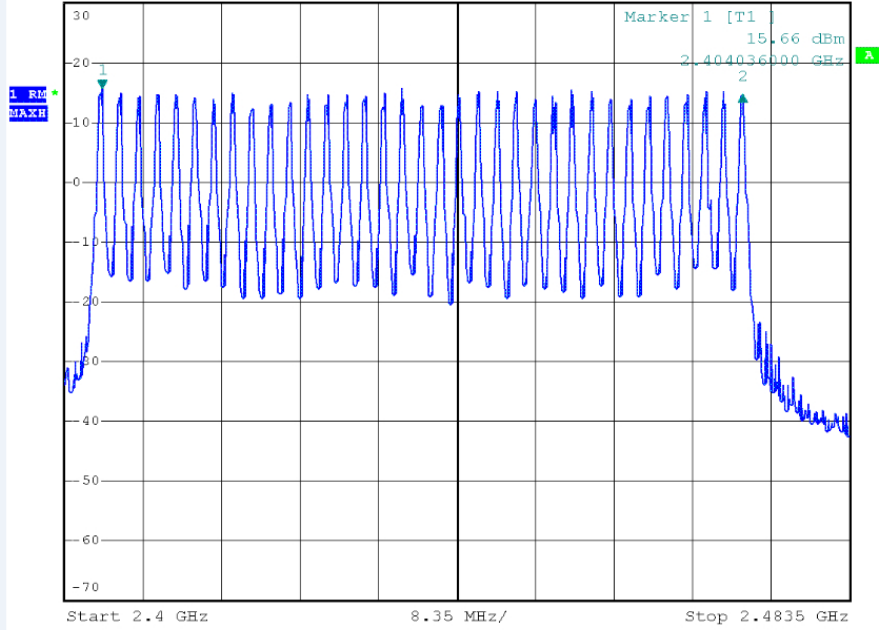

8. Test of Dwell Time of Each Frequency

8.1 Applicable Standard

Section 15.247(a)(1)(iii): For frequency hopping systems operating in the 2400-2483.5 MHz band The average time of occupancy on any channel shall not be greater than 0.4 seconds within a period of 0.4seconds multiplied by the number of hopping channels employed.

8.2 EUT Setup

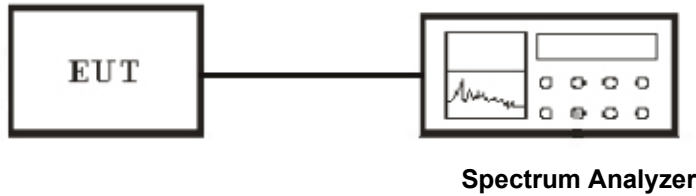

8.3 Test Equipment List and Details

See section 2.5.

8.4 Test Procedure

1. The transmitter output was connected to the spectrum analyzer through an attenuator.
2. Set RBW of spectrum analyzer to 1000kHz and VBW to 1000kHz.
3. Set Detector to Peak, Trace to Max Hold and Sweep Time is more than once pulse time.
4. Set the center frequency on any frequency would be measure and set the frequency span to zero span.
5. Measure the maximum time duration of one single pulse.

8.5 Test Result

Temperature (°C) : 22~23	EUT: 2.4GHz Radio Control Computer Receiver
Humidity (%RH) : 50~54	M/N: X-8N
Barometric Pressure (mbar) : 950~1000	Operation Condition: Tx Mode

Modulation Type	Channel No.	Frequency (MHz)	Dwell Time (ms)	Limit (ms)
FHSS	Low	2403.920	0.844	400
FHSS	Middle	2435.989	0.844	400
FHSS	High	2472.056	0.844	400

A period time = 0.4 (ms) * 35 = 14 (s)
N=40
CH Low:
Time slot = 0.844(ms)
Dwell time=N*T= 40* 0.844=33.76(ms)

CH Mid:
Time slot = 0.844 (ms)
Dwell time= N*T= 40* 0.844=33.76 (ms)

CH High:
Time slot = 0.844(ms)
Dwell time= N*T= 40* 0.844=33.76 (ms)

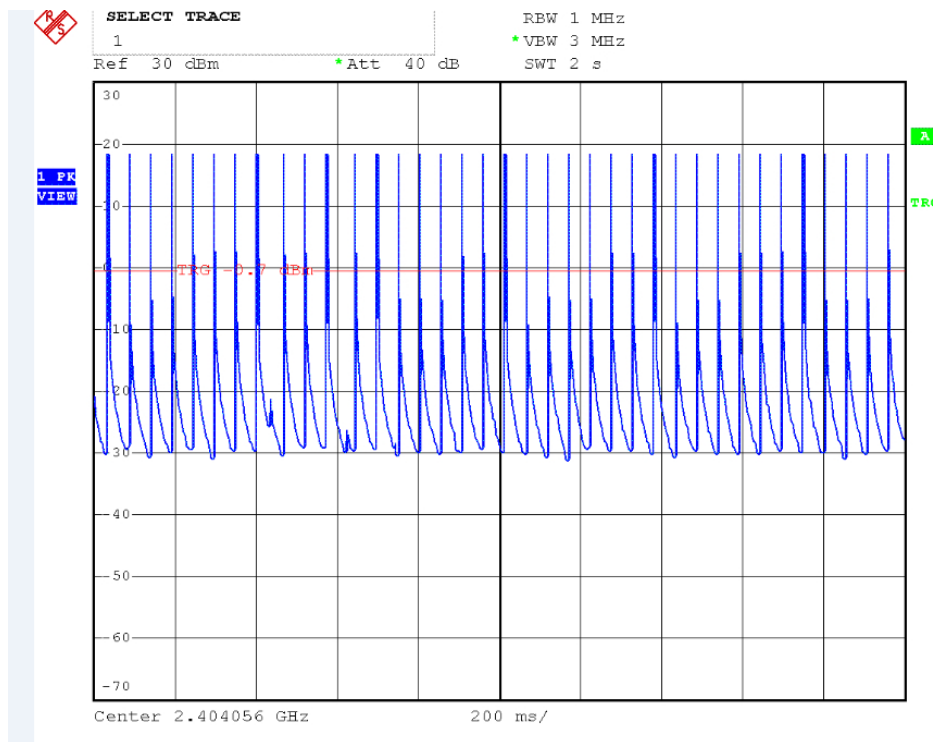

Channel Low:

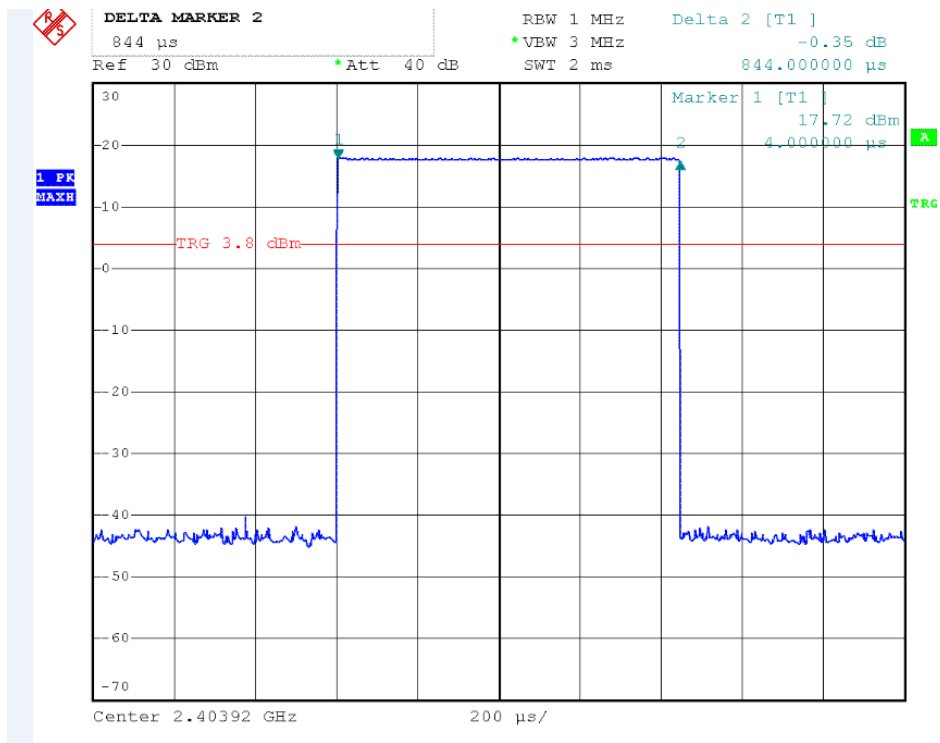

Channel Middle:

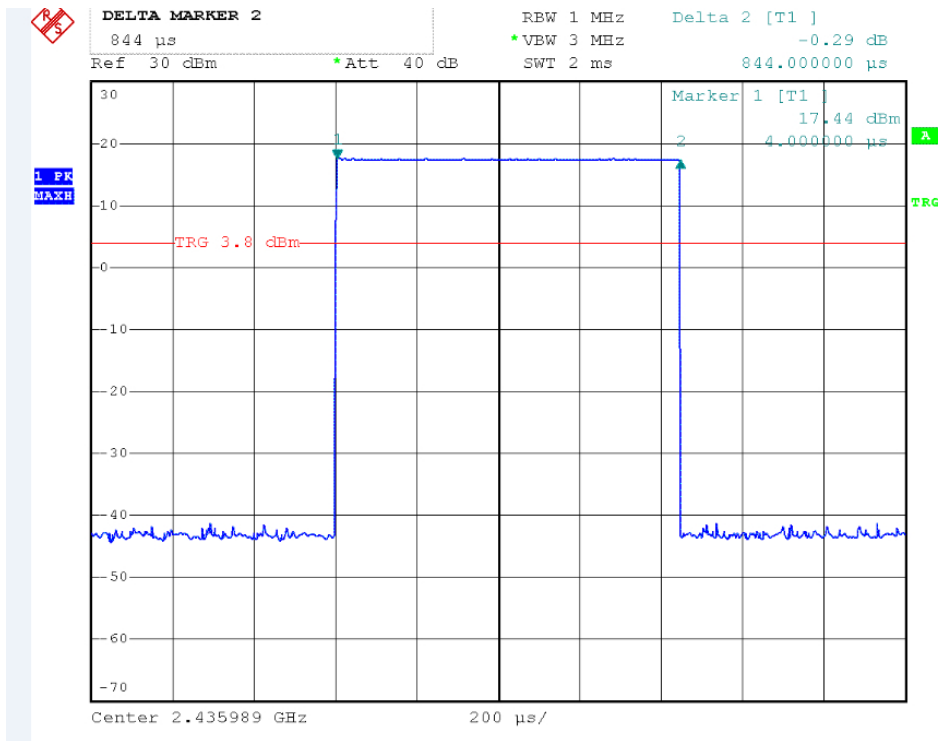

Channel High:

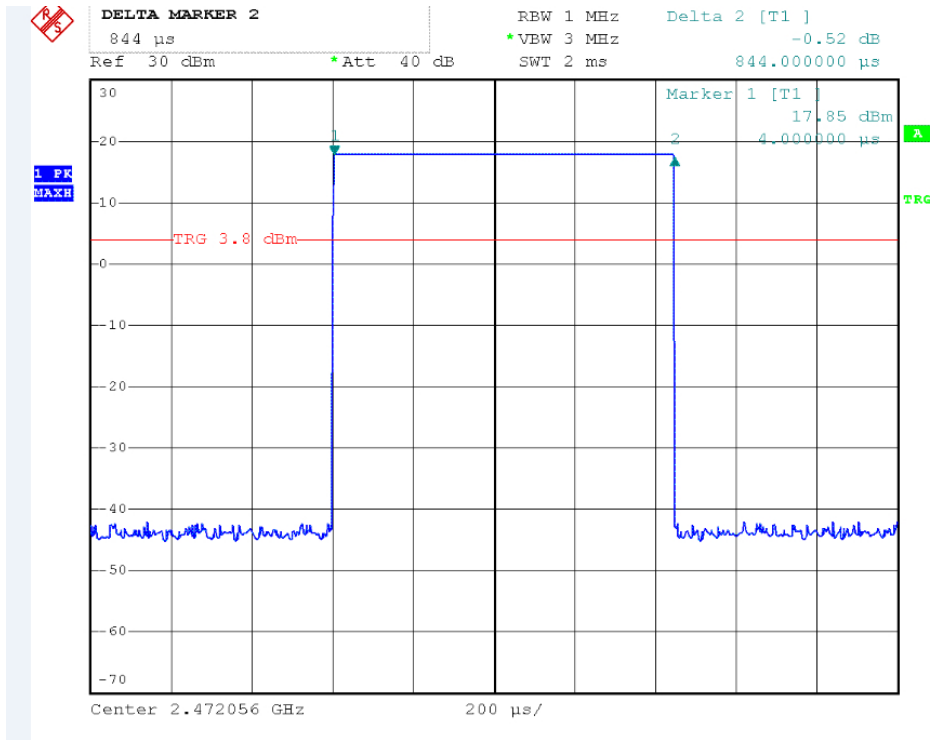

9. Test of Maximum Peak Output Power

9.1 Applicable Standard

Section 15.247(b)(1): For frequency hopping systems operating in the 2400-2483.5 MHz band employing at least 75 non-overlapping hopping channels and The maximum peak output power shall not exceed 1 watt. For all other frequency hopping systems in this frequency band, The maximum peak output power shall not exceed 0.125 watt.

9.2 EUT Setup

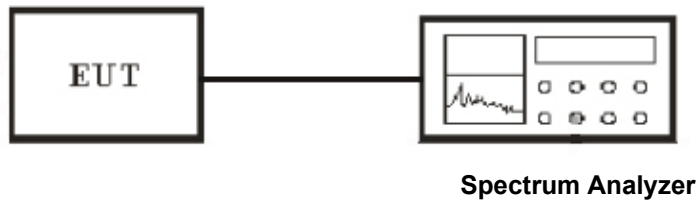

9.3 Test Equipment List and Details

See section 2.5.

9.4 Test Procedure

1. The transmitter output was connected to the peak power meter and recorded the peak value.
2. Peak power meter parameter set to auto attenuator and filter is the same as.
3. Repeated the 1 for the middle and highest channel of the EUT.

9.5 Test Result

Temperature (°C) : 22~23	EUT: 2.4GHz Radio Control Computer Receiver
Humidity (%RH) : 50~54	M/N: X-8N
Barometric Pressure (mbar) : 950~1000	Operation Condition: Tx Mode

Modulation Type	Channel No.	Frequency (MHz)	Output Power (dBm)
FHSS	Low	2403.920	18.17
FHSS	Middle	2435.989	17.61
FHSS	High	2472.056	17.99

Channel Low:

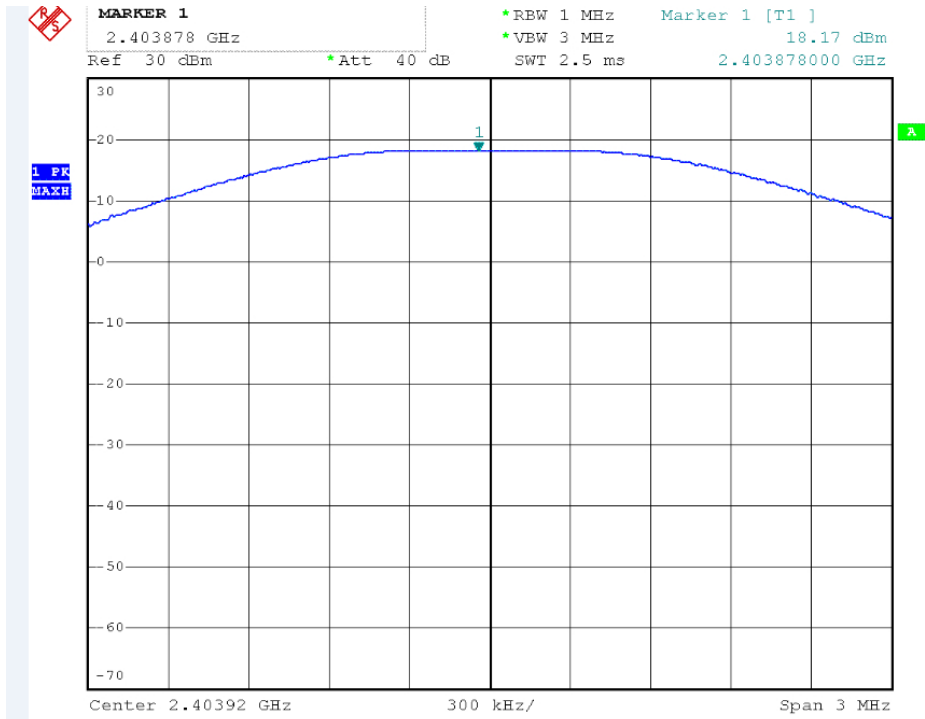

Channel Middle:

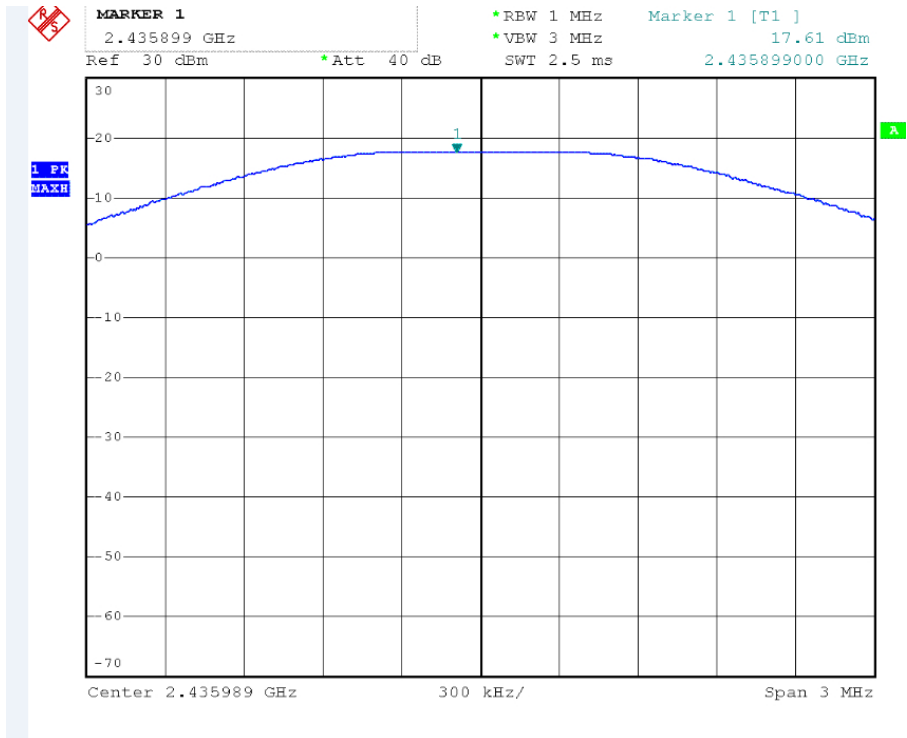

Channel High:

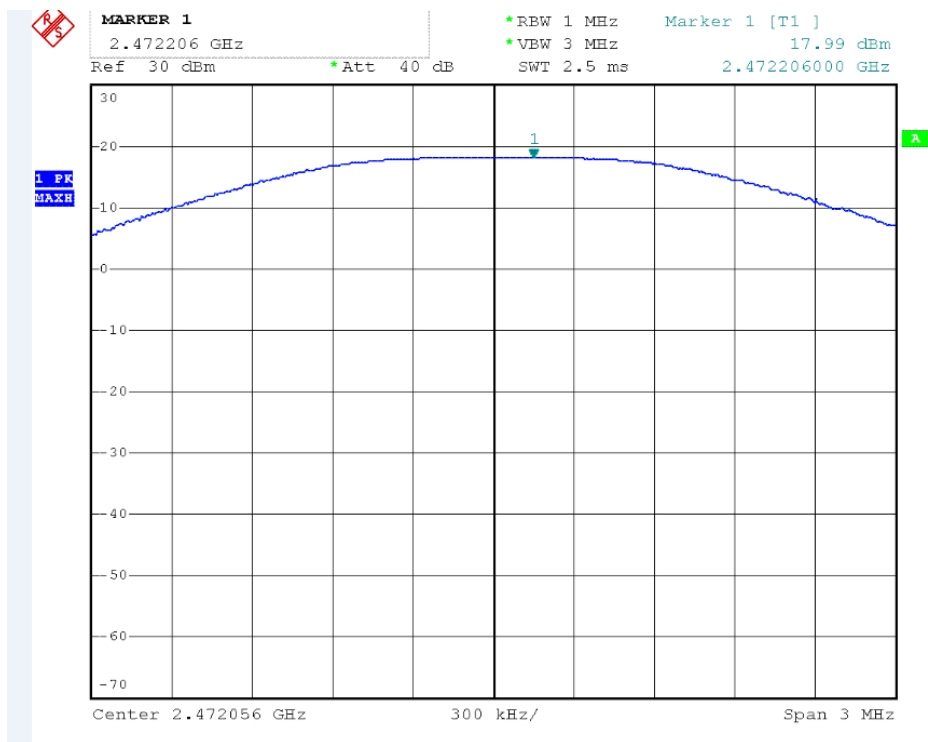

10. Test of Band Edges Emission

10.1 Applicable Standard

Section 15.247(d): In any 100 kHz bandwidth outside the frequency band in which the spread spectrum or digitally modulated intentional radiator is operating, the radio frequency power that is produced by the intentional radiator shall be at least 20 dB below that in the 100 kHz bandwidth within the band that contains the highest level of the desired power, based on either an RF conducted or a radiated measurement. In addition, radiated emissions that fall in the restricted bands, as defined in Section 15.205, must also comply with the radiated emission limits specified in Section 15.209.

10.2 EUT Setup

Radiated Measurement Setup

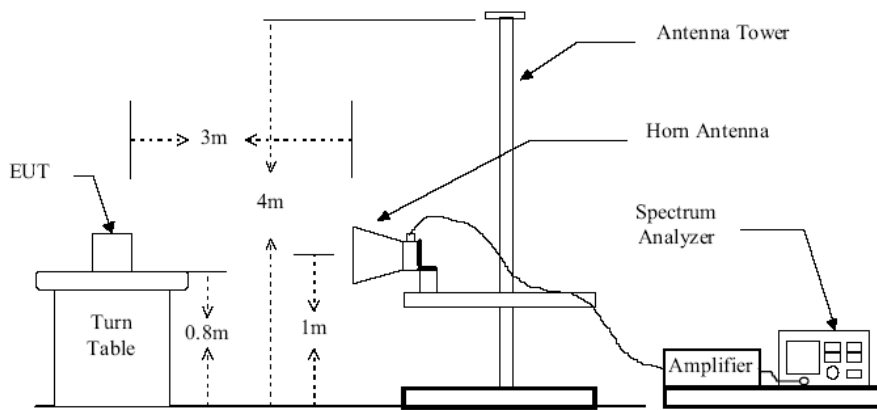
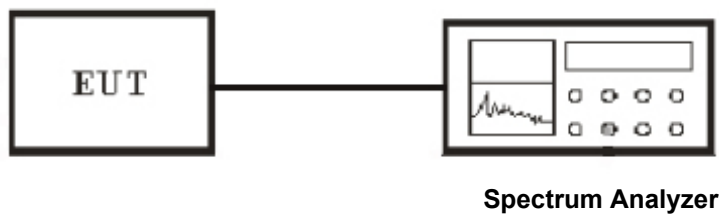

Figure 2 : Frequencies measured above 1 GHz configuration

Conducted Measurement Setup



10.3 Test Equipment List and Details

See section 2.5.

10.4 Test Procedure

Conducted Measurement

1. The transmitter is set to the lowest channel.
2. The transmitter output was connected to the spectrum analyzer via a cable and cable loss is used as the offset of the spectrum analyzer.

3. Set both RBW and VBW of spectrum analyzer to 100KHz with convenient frequency span including 100MHz bandwidth from lower band edge. Then detector set to peak and max hold this trace.
4. The lowest band edges emission was measured and recorded.
5. The transmitter set to the highest channel and repeated 2~4.

Radiated Measurement

1. Configure the EUT according to ANSI C63.4-2003
2. The turntable was rotated by 360 degrees to determine the position of the highest radiation.
3. The height of the broadband receiving antenna was varied between one meter and four meters above ground to find the maximum emission field strength of both horizontal and vertical polarization.
4. For band edge emission, the antenna tower was scan (from 1 M to 4 M) and then the turn table was rotated (from 0 degree to 360 degrees) to find the maximum reading.
5. For band edge emission, use 1MHz VBW and 1MHz RBW for reading under AV and use 1MHz VBW and 1MHz RBW for reading under PK.

10.5 Test Result

Temperature (°C) : 22~23	EUT: 2.4GHz Radio Control Computer Receiver
Humidity (%RH) : 50~54	M/N: X-8N
Barometric Pressure (mbar) : 950~1000	Operation Condition: Tx Mode

Radiated Test Result

Frequency (MHz)	Antenna Polarization	Emission Read Value (dBµV/m)	Limits (dBµV/m)
2398.32	H	42.46	54
2398.22	V	44.62	54
2483.24	H	43.55	54
2483.76	V	41.62	54

Conducted Test Result
Low Channel

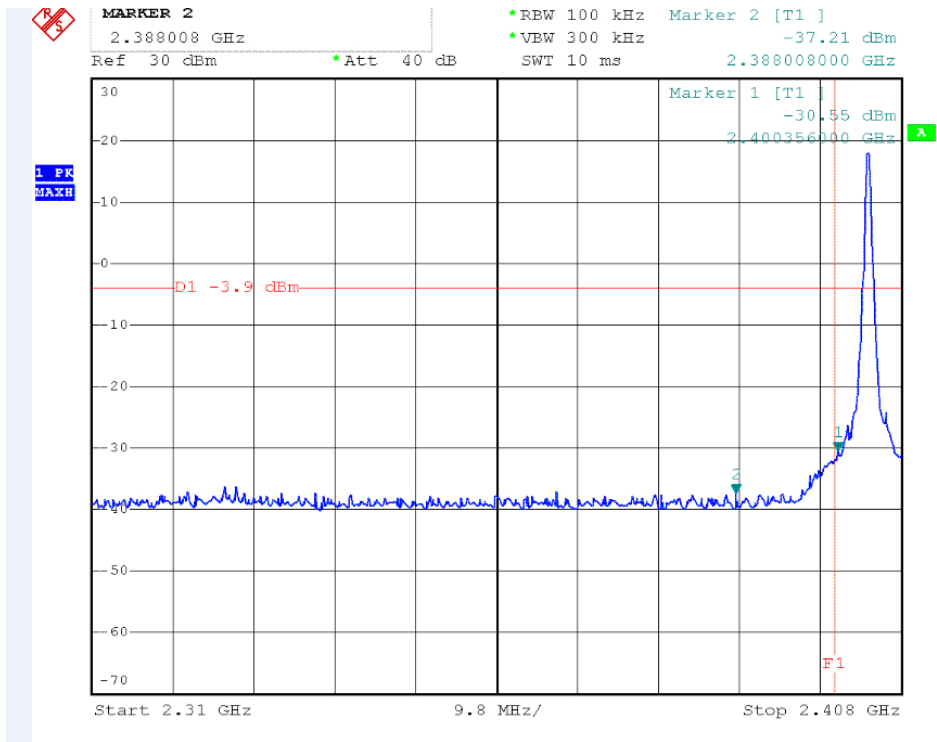

High Channel

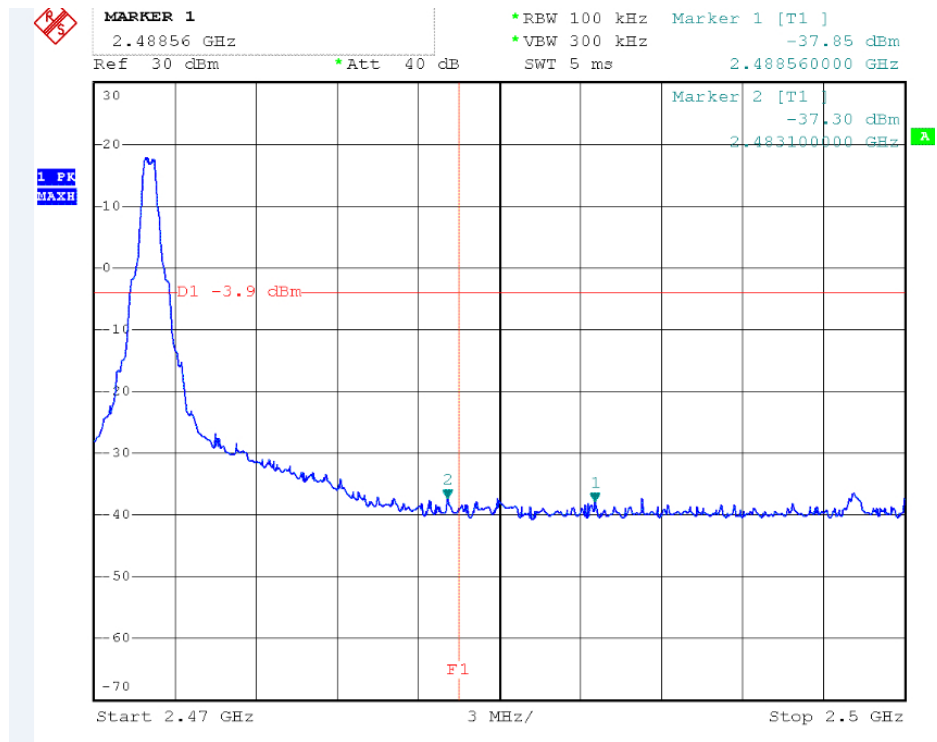

11. Test of Spurious Radiated Emission

11.1 Applicable Standard

Section 15.247(d): In any 100 kHz bandwidth outside the frequency band in which the spread spectrum or digitally modulated intentional radiator is operating, the radio frequency power that is produced by the intentional radiator shall be at least 20 dB below that in the 100 kHz bandwidth within the band that contains the highest level of the desired power, based on either an RF conducted or a radiated measurement. In addition, radiated emissions that fall in the restricted bands, as defined in Section 15.205, must also comply with the radiated emission limits specified in Section 15.209.

11.2 EUT Setup

Conducted Measurement Setup

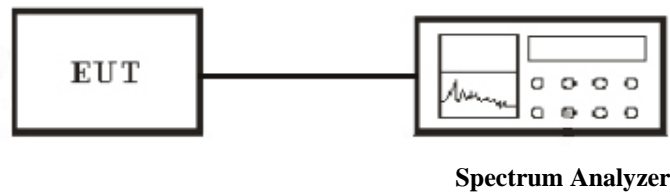

Radiated Measurement Setup

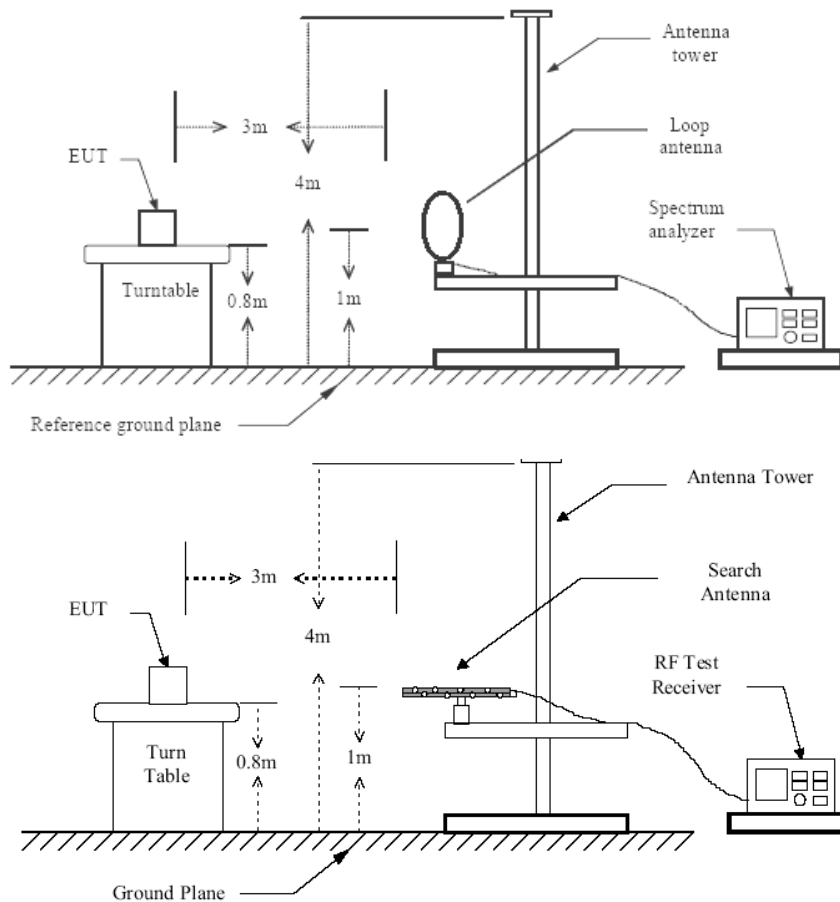

Figure 1 : Frequencies measured below 1 GHz configuration

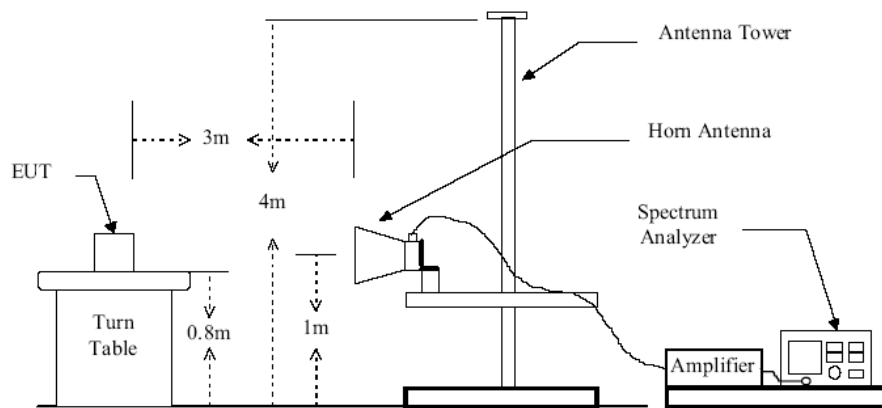

Figure 2 : Frequencies measured above 1 GHz configuration

11.3 Test Equipment List and Details

See section 2.5.

11.4 Test Procedure

Conducted Measurement

1. For emission above 1GHz to 26G,conducted measurement method is used.
2. The transmitter is set to the lowest channel.
3. The transmitter output was connected to the spectrum analyzer via a cable and cable loss is used as the offset of the spectrum analyzer.
4. Set RBW to 1 MHz and VBW to 3 MHz, Then detector set to peak and max hold this trace.
5. The lowest band edges emission was measured and recorded.
6. The transmitter set to the highest channel and repeated 2~4.

Radiated Measurement

1. Configure the EUT according to ANSI C63.4-2003
2. The EUT was placed on the top of the turntable 0.8 meter above ground.
3. Receiving antenna mounted on the top of a height-variable antenna tower was placed 3 meters far away from the turntable. When the frequency spectrum measured started from 9 kHz to 30 MHz, a loop antenna is used. When the frequency spectrum measured started from 30 MHz to 1000 MHz and above 1000 MHz, a broadband receiving antenna and the horn antenna are used.
4. Power on the EUT and all the supporting units.
5. The turntable was rotated by 360 degrees to determine the position of the highest radiation.
6. The height of the broadband receiving antenna was varied between one meter and four meters above ground to find the maximum emission field strength of both horizontal and vertical polarization.
7. For each suspected emission, the antenna tower was scanned (from 1 M to 4 M) and then the turntable was rotated (from 0 degree to 360 degrees) to find the maximum reading.

8. According to the characteristic of the EUT crystals, the range of frequencies was investigated from 9KHz to 30MHz, 30MHz to 1GHz and 1GHz to 26GHz.

9. For emission below 1GHz, Set the test-receiver system to Peak or CISPR quasi-peak Detect Function with specified bandwidth under Maximum Hold Mode.

10. For emission above 1GHz, Set the RBW=1MHz,VBW=3MHz for Peak Detector while the RBW=1MHz, VBW=10Hz for Average Detector, Readings are both peak and average values.

11. The pre-test have done for the EUT in three axes and found the worst emission at position shown in test setup photos. The worst case data is recorded in the report. All emission not reported are much lower than the prescribed limits.

11.5 Test Result

Temperature (°C) : 22~23	EUT: 2.4GHz Radio Control Computer Receiver
Humidity (%RH) : 50~54	M/N: X-8N
Barometric Pressure (mbar) : 950~1000	Operation Condition: TX Mode

Radiated Spurious Emission Data Below 1GHz Channel Low:

EUT: 2.4GHz Radio Control Computer Receiver
M/N: X-8N
Operating Condition: TX Mode
Test Site: 3m CHAMBER
Operator: Chen
Test Specification: DC 6V from battery
Comment: Polarization: Horizontal

SWEEP TABLE: "test (30M-1G)"

Short Description:		Field Strength			
Start	Stop	Detector	Meas. Time	IF Bandw.	Transducer
Frequency	Frequency				
30.0 MHz	1.0 GHz	MaxPeak	Coupled	100 kHz	VULB9163 NEW

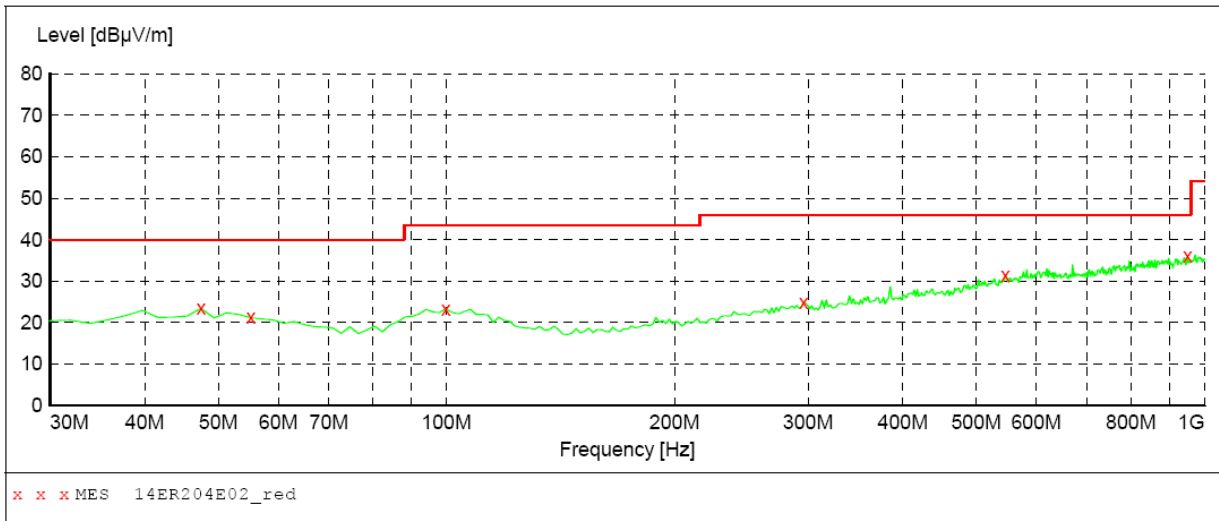

MEASUREMENT RESULT: "14ER204E02_red"

6/10/2014 10:01

Frequency MHz	Level dBµV/m	Transd dB	Limit dBµV/m	Margin dB	Det.	Height cm	Azimuth deg	Polarization
47.460000	23.40	15.8	40.0	16.6	QP	100.0	0.00	HORIZONTAL
55.220000	21.20	15.6	40.0	18.8	QP	100.0	0.00	HORIZONTAL
99.840000	23.30	17.5	43.5	20.2	QP	100.0	0.00	HORIZONTAL
295.780000	24.80	18.6	46.0	21.2	QP	100.0	0.00	HORIZONTAL
546.040000	31.50	24.9	46.0	14.5	QP	100.0	0.00	HORIZONTAL
949.560000	36.00	29.6	46.0	10.0	QP	100.0	0.00	HORIZONTAL

Radiated Spurious Emission Data Below 1GHz Channel Low:

EUT: 2.4GHz Radio Control Computer Receiver
M/N: X-8N
Operating Condition: TX Mode
Test Site: 3m CHAMBER
Operator: Chen
Test Specification: DC 6V from battery
Comment: Polarization: Vertical

SWEEP TABLE: "test (30M-1G)"

Short Description:		Field Strength			
Start	Stop	Detector	Meas. Time	IF Bandw.	Transducer
Frequency	Frequency				
30.0 MHz	1.0 GHz	MaxPeak	Coupled	100 kHz	VULB9163 NEW

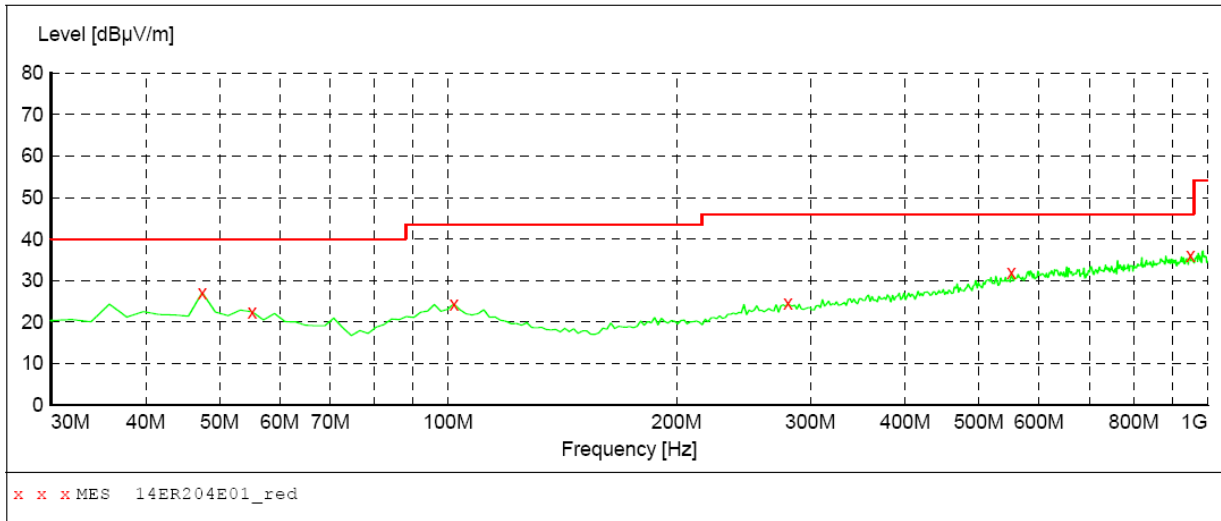

MEASUREMENT RESULT: "14ER204E01_red"

6/10/2014 10:00

Frequency MHz	Level dBµV/m	Transd dB	Limit dBµV/m	Margin dB	Det.	Height cm	Azimuth deg	Polarization
47.460000	27.10	15.8	40.0	12.9	QP	100.0	0.00	VERTICAL
55.220000	22.50	15.6	40.0	17.5	QP	100.0	0.00	VERTICAL
101.780000	24.40	17.3	43.5	19.1	QP	100.0	0.00	VERTICAL
280.260000	24.50	18.2	46.0	21.5	QP	100.0	0.00	VERTICAL
551.860000	31.90	25.0	46.0	14.1	QP	100.0	0.00	VERTICAL
949.560000	36.10	29.6	46.0	9.9	QP	100.0	0.00	VERTICAL

Radiated Spurious Emission Data Below 1GHz Channel Middle:

EUT: 2.4GHz Radio Control Computer Receiver
M/N: X-8N
Operating Condition: TX Mode
Test Site: 3m CHAMBER
Operator: Chen
Test Specification: DC 6V from battery
Comment: Polarization: Horizontal

SWEEP TABLE: "test (30M-1G)"

Short Description:		Field Strength			
Start	Stop	Detector	Meas. Time	IF Bandw.	Transducer
Frequency	Frequency				
30.0 MHz	1.0 GHz	MaxPeak	Coupled	100 kHz	VULB9163 NEW

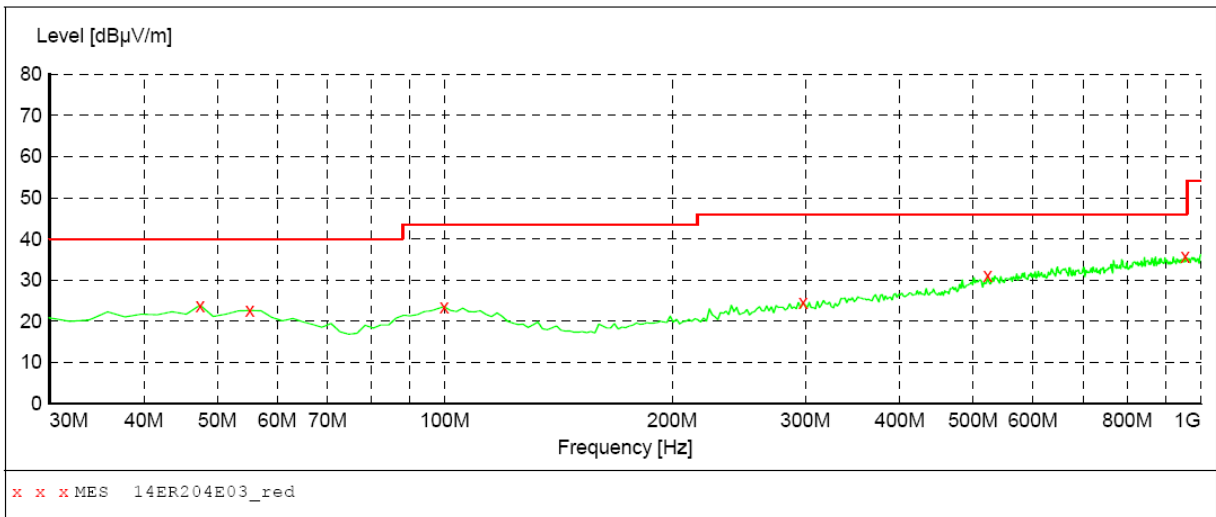

MEASUREMENT RESULT: "14ER204E03_red"

6/10/2014 10:03

Frequency MHz	Level dBµV/m	Transd dB	Limit dBµV/m	Margin dB	Det.	Height cm	Azimuth deg	Polarization
47.460000	23.90	15.8	40.0	16.1	QP	100.0	0.00	HORIZONTAL
55.220000	22.70	15.6	40.0	17.3	QP	100.0	0.00	HORIZONTAL
99.840000	23.60	17.5	43.5	19.9	QP	100.0	0.00	HORIZONTAL
297.720000	24.70	18.7	46.0	21.3	QP	100.0	0.00	HORIZONTAL
522.760000	31.10	24.4	46.0	14.9	QP	100.0	0.00	HORIZONTAL
953.440000	35.80	29.6	46.0	10.2	QP	100.0	0.00	HORIZONTAL

Radiated Spurious Emission Data Below 1GHz Channel Middle:

EUT: 2.4GHz Radio Control Computer Receiver
M/N: X-8N
Operating Condition: TX Mode
Test Site: 3m CHAMBER
Operator: Chen
Test Specification: DC 6V from battery
Comment: Polarization: Vertical

SWEEP TABLE: "test (30M-1G)"

Short Description:		Field Strength			
Start	Stop	Detector	Meas. Time	IF Bandw.	Transducer
Frequency	Frequency				
30.0 MHz	1.0 GHz	MaxPeak	Coupled	100 kHz	VULB9163 NEW

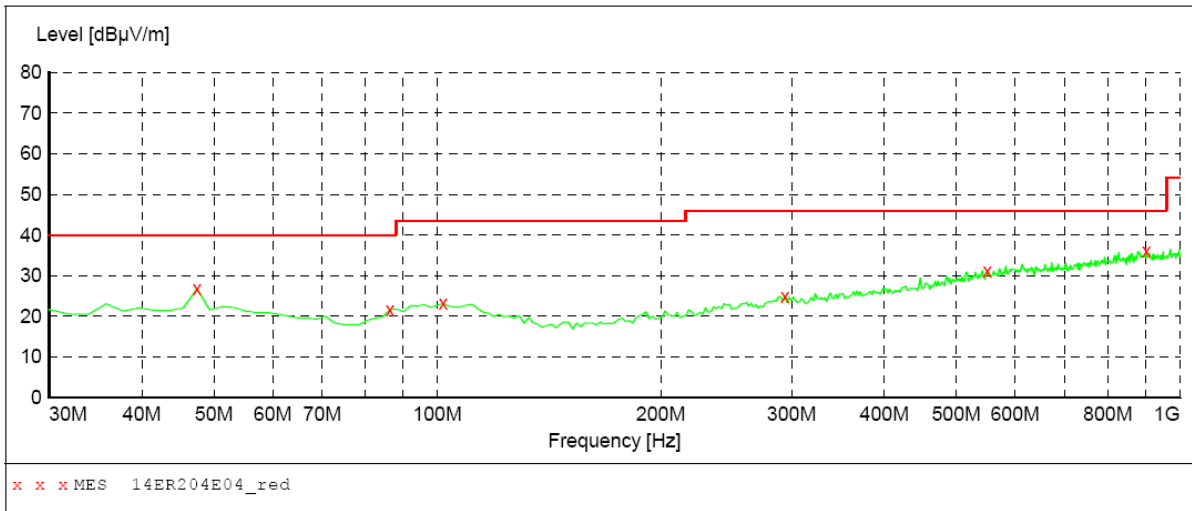

MEASUREMENT RESULT: "14ER204E04_red"

6/10/2014 10:04

Frequency MHz	Level dBµV/m	Transd dB	Limit dBµV/m	Margin dB	Det.	Height cm	Azimuth deg	Polarization
47.460000	26.80	15.8	40.0	13.2	QP	100.0	0.00	VERTICAL
86.260000	21.60	14.8	40.0	18.4	QP	100.0	0.00	VERTICAL
101.780000	23.20	17.3	43.5	20.3	QP	100.0	0.00	VERTICAL
293.840000	24.90	18.6	46.0	21.1	QP	100.0	0.00	VERTICAL
549.920000	31.30	25.0	46.0	14.7	QP	100.0	0.00	VERTICAL
901.060000	36.10	29.2	46.0	9.9	QP	100.0	0.00	VERTICAL

Radiated Spurious Emission Data Below 1GHz Channel High:

EUT: 2.4GHz Radio Control Computer Receiver
M/N: X-8N
Operating Condition: TX Mode
Test Site: 3m CHAMBER
Operator: Chen
Test Specification: DC 6V from battery
Comment: Polarization: Horizontal

SWEEP TABLE: "test (30M-1G)"

Short Description:		Field Strength			
Start	Stop	Detector	Meas. Time	IF Bandw.	Transducer
Frequency	Frequency	MaxPeak	Coupled	100 kHz	VULB9163 NEW
30.0 MHz	1.0 GHz				

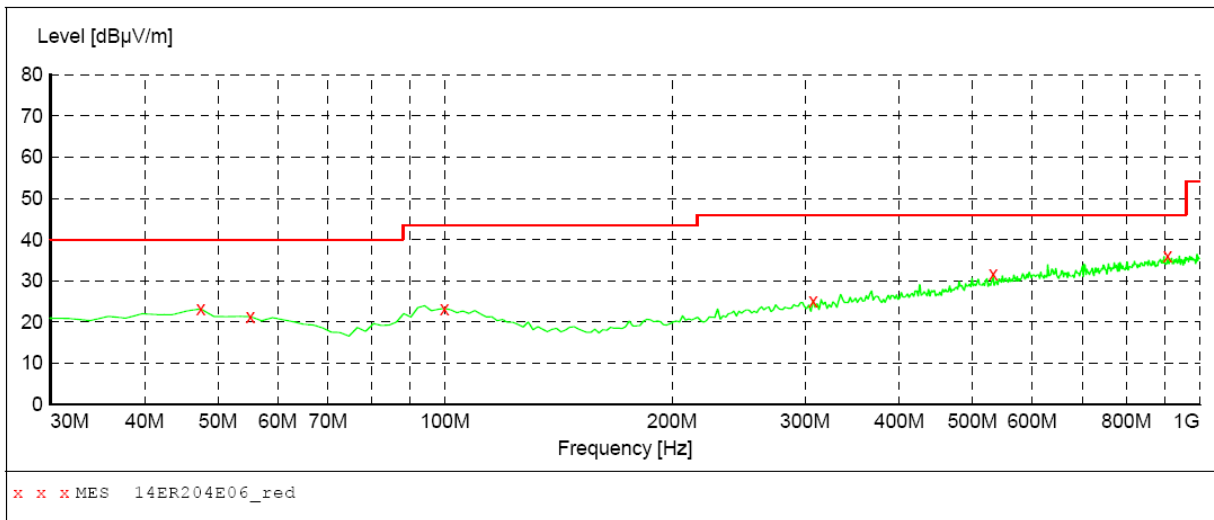

MEASUREMENT RESULT: "14ER204E06_red"

6/10/2014 10:07

Frequency MHz	Level dBµV/m	Transd dB	Limit dBµV/m	Margin dB	Det.	Height cm	Azimuth deg	Polarization
47.460000	23.20	15.8	40.0	16.8	QP	100.0	0.00	HORIZONTAL
55.220000	21.30	15.6	40.0	18.7	QP	100.0	0.00	HORIZONTAL
99.840000	23.30	17.5	43.5	20.2	QP	100.0	0.00	HORIZONTAL
307.420000	25.30	18.9	46.0	20.7	QP	100.0	0.00	HORIZONTAL
532.460000	31.80	24.6	46.0	14.2	QP	100.0	0.00	HORIZONTAL
906.880000	36.20	29.2	46.0	9.8	QP	100.0	0.00	HORIZONTAL

Radiated Spurious Emission Data Below 1GHz Channel High:

EUT: 2.4GHz Radio Control Computer Receiver
M/N: X-8N
Operating Condition: TX Mode
Test Site: 3m CHAMBER
Operator: Chen
Test Specification: DC 6V from battery
Comment: Polarization: Vertical

SWEEP TABLE: "test (30M-1G)"

Short Description:		Field Strength			Transducer
Start	Stop	Detector	Meas.	IF	
Frequency	Frequency		Time	Bandw.	
30.0 MHz	1.0 GHz	MaxPeak	Coupled	100 kHz	VULB9163 NEW

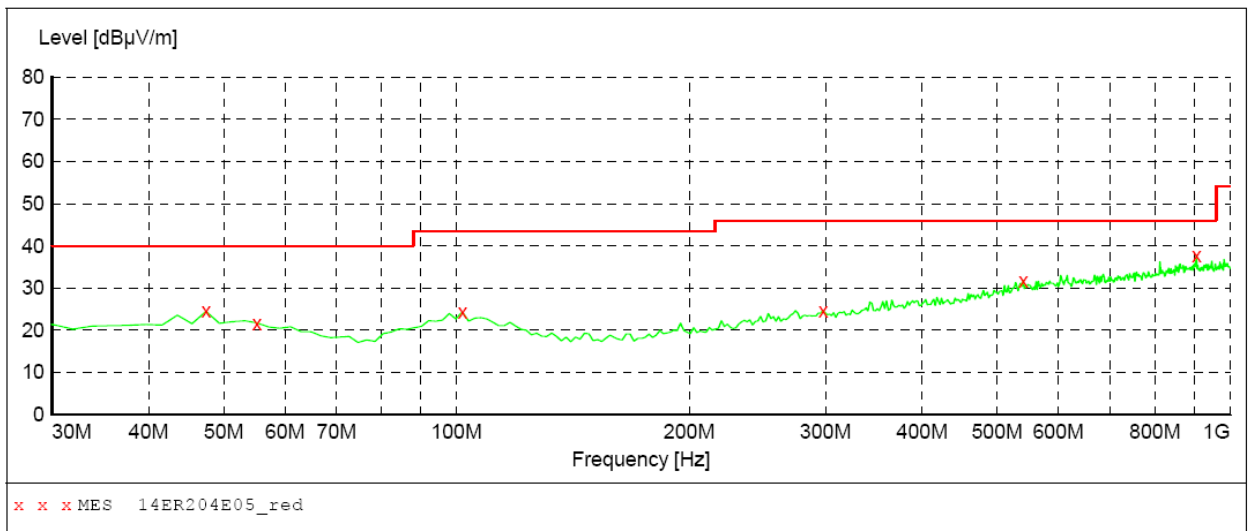

MEASUREMENT RESULT: "14ER204E05_red"

6/10/2014 10:06

Frequency MHz	Level dBµV/m	Transd dB	Limit dBµV/m	Margin dB	Det.	Height cm	Azimuth deg	Polarization
47.460000	24.50	15.8	40.0	15.5	QP	100.0	0.00	VERTICAL
55.220000	21.70	15.6	40.0	18.3	QP	100.0	0.00	VERTICAL
101.780000	24.30	17.3	43.5	19.2	QP	100.0	0.00	VERTICAL
297.720000	24.70	18.7	46.0	21.3	QP	100.0	0.00	VERTICAL
540.220000	31.80	24.8	46.0	14.2	QP	100.0	0.00	VERTICAL
904.940000	37.60	29.2	46.0	8.4	QP	100.0	0.00	VERTICAL

Radiated Spurious Emission Test Data Above 1GHz

Channel Low

Channel Low (2403.920MHz)								
Maximum Frequency (MHz)	Polarity and Level					Limit (dBµV/m)	Margin (dBµV/m)	Mark (P/Q/A)
	Polarity	Height (m)	Reading dBµV	Transd	Result dBµV/m			
2403.920	H	1	111.13	-7.15	103.98	N/A	N/A	P
			102.53	-7.15	95.38	N/A	N/A	A
2403.920	V	1	113.56	-7.15	106.41	N/A	N/A	P
			102.67	-7.15	95.52	N/A	N/A	A
4807.84	H	1	40.17	1.07	41.24	74	-32.76	P
			30.03	1.07	31.1	54	-22.9	A
4807.84	V	1	41.52	1.07	42.59	74	-31.41	P
			30.67	1.07	31.74	54	-22.26	A
7211.76	H	1	40.3	7.38	47.68	74	-26.32	P
			30.47	7.38	37.85	54	-16.15	A
7211.76	V	1	42.16	7.38	49.54	74	-24.46	P
			31.54	7.38	38.92	54	-15.08	A
9615.68	H	1	40.23	10.29	50.52	74	-23.48	P
			31.01	10.29	41.3	54	-12.7	A
9615.68	V	1	42.72	7.38	50.1	74	-23.9	P
			31.39	7.38	38.77	54	-15.23	A
12019.6	H	1	40.37	14.01	54.38	74	-19.62	P
			31.56	14.01	45.57	54	-8.43	A
12019.6	V	1	41.36	14.01	55.37	74	-18.63	P
			31.47	14.01	45.48	54	-8.52	A
25380.35	----	----	----	----	----	----	----	----

Remark: 1. Transd.=Antenna Factor+Cable Loss-Pre-amplifier
 Margin = Level-Limit
 Mark: P means Peak Value, Q means Quasi Peak Value, A means Average Value
 2. Data of measurement within this frequency range shown “-” in the table above means the reading of emissions are attenuated more than 20dB below the permissible limits or the field strength is too small to be measured.
 3. Spectrum analyzer setting P(Peak): RBW=1MHz, VBW=1MHz, A(Average): RBW=1MHz, VBW=10Hz.
 4. The test limit distance is 3m limit

Channel Mid

Channel Low (2435.989MHz)								
Maximum Frequency (MHz)	Polarity and Level					Limit (dBµV/m)	Margin (dBµV/m)	Mark (P/Q/A)
	Polarity	Height (m)	Reading dBµV	Transd	Result dBµV/m			
2435.989	H	1	109.12	-6.37	102.75	N/A	N/A	P
			100.36	-6.37	93.99	N/A	N/A	A
2435.989	V	1	112.47	-6.37	106.1	N/A	N/A	P
			102.24	-6.37	95.87	N/A	N/A	A
4871.978	H	1	40.03	1.07	41.1	74	-32.9	P
			30.16	1.07	31.23	54	-22.77	A
4871.978	V	1	41.37	1.07	42.44	74	-31.56	P
			30.63	1.07	31.7	54	-22.3	A
7307.967	H	1	39.86	7.49	47.35	74	-26.65	P
			30.52	7.49	38.01	54	-15.99	A
7307.967	V	1	41.3	7.49	48.79	74	-25.21	P
			31.14	7.49	38.63	54	-15.37	A
9743.956	H	1	40.53	10.47	51	74	-23	P
			31.16	10.47	41.63	54	-12.37	A
9743.956	V	1	40.87	10.47	51.34	74	-22.66	P
			31.3	10.47	41.77	54	-12.23	A
12179.945	H	1	41.16	14.1	55.26	74	-18.74	P
			30.84	14.1	44.94	54	-9.06	A
12179.945	V	1	41.37	14.1	55.47	74	-18.53	P
			31.52	14.1	45.62	54	-8.38	A
25380.37	----	----	----	----	----	----	----	----

Remark: 1. Transd.=Antenna Factor+Cable Loss-Pre-amplifier
 Margin = Level-Limit
 Mark: P means Peak Value, Q means Quasi Peak Value, A means Average Value
 2. Data of measurement within this frequency range shown “-” in the table above means the reading of emissions are attenuated more than 20dB below the permissible limits or the field strength is too small to be measured.
 3. Spectrum analyzer setting P(Peak): RBW=1MHz, VBW=1MHz, A(Average): RBW=1MHz, VBW=10Hz.
 4. The test limit distance is 3m limit

Channel High

Channel Low (2472.056MHz)								
Maximum Frequency (MHz)	Polarity and Level					Limit (dBµV/m)	Margin (dBµV/m)	Mark (P/Q/A)
	Polarity	Height (m)	Reading dBµV	Transd	Result dBµV/m			
2472.056	H	1	112.32	-6.05	106.27	N/A	N/A	P
			103.45	-6.05	97.4	N/A	N/A	A
2472.056	V	1	114.03	-6.05	107.98	N/A	N/A	P
			103.67	-6.05	97.62	N/A	N/A	A
4944.112	H	1	40.63	1.07	41.7	74	-32.3	P
			30.52	1.07	31.59	54	-22.41	A
4944.112	V	1	41.47	1.07	42.54	74	-31.46	P
			30.61	1.07	31.68	54	-22.32	A
7416.168	H	1	41.47	7.61	49.08	74	-24.92	P
			30.3	7.61	37.91	54	-16.09	A
7416.168	V	1	40.81	7.61	48.42	74	-25.58	P
			31.52	7.61	39.13	54	-14.87	A
9888.224	H	1	40.47	10.65	51.12	74	-22.88	P
			31.3	10.65	41.95	54	-12.05	A
9888.224	V	1	40.95	10.65	51.6	74	-22.4	P
			31.16	10.65	41.81	54	-12.19	A
12360.28	H	1	40.47	14.19	54.66	74	-19.34	P
			31.3	14.19	45.49	54	-8.51	A
12360.28	V	1	40.9	14.19	55.09	74	-18.91	P
			31.67	14.19	45.86	54	-8.14	A
25381.35	----	----	----	----	----	----	----	----

Remark: 1. Transd.=Antenna Factor+Cable Loss-Pre-amplifier
 Margin = Level-Limit
 Mark: P means Peak Value, Q means Quasi Peak Value, A means Average Value
 2. Data of measurement within this frequency range shown “-” in the table above means the reading of emissions are attenuated more than 20dB below the permissible limits or the field strength is too small to be measured.
 3. Spectrum analyzer setting P(Peak): RBW=1MHz, VBW=1MHz, A(Average): RBW=1MHz, VBW=10Hz.
 4. The test limit distance is 3m limit

Radiated Emission Below 30 MHz

Frequency (MHz)	Read Level (dBuV)	Antenna Factor (dB/m)	Cable Loss (dB)	Emission Levels (dBuV/m)	Limit (dBµV/m)	Margin (dB)	Detector Mode
0.522	24.58	8.22	-1.01	31.79	67	-35.21	QP
18.43	24.74	8.17	-1.2	31.71	49.5	-17.79	QP
23.71	22.92	8.03	-1.05	29.9	49.5	-19.6	QP
24.88	24.28	7.48	-1.69	30.07	49.5	-19.43	QP

Note:

1. The pre-test have done for the EUT in three axes and found the worst emission at position shown in test setup photos. The worst case data is recorded in the report.
2. Emission level (dBuV/m) =Raw Value (dBuV) + Correction Factor (dB/m)
3. Correction Factor (dB/m) = Antenna Factor (dB/m) + Cable Factor (dB)
4. The other emission levels were very low against the limit.
5. Margin value = Emission level.- Limit value

Conducted Spurious Emission Test Data 30MHz-26.5GHz
Channel Low

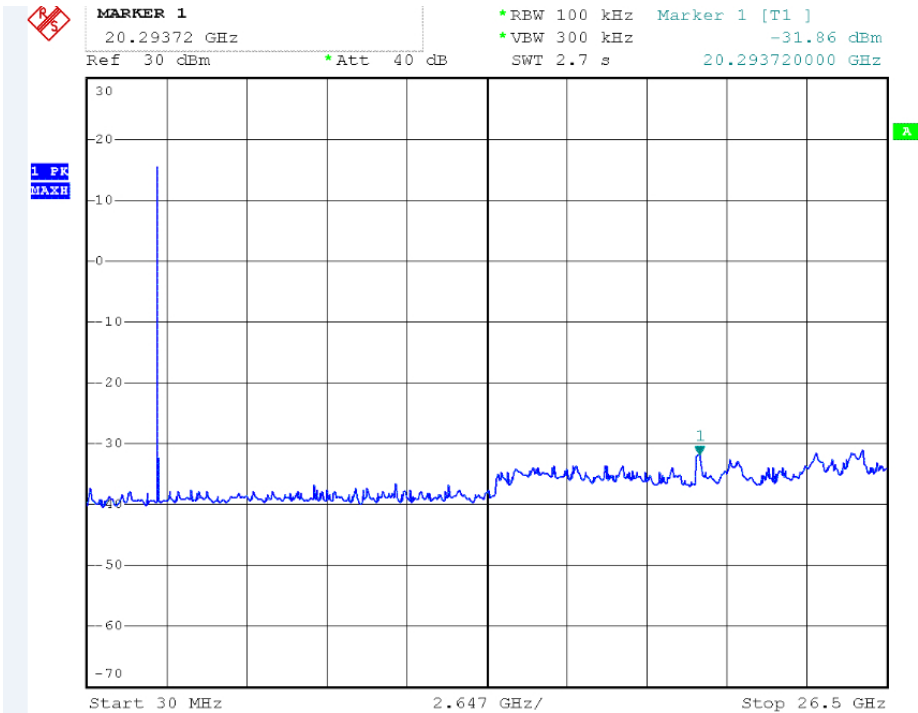

Channel Mid

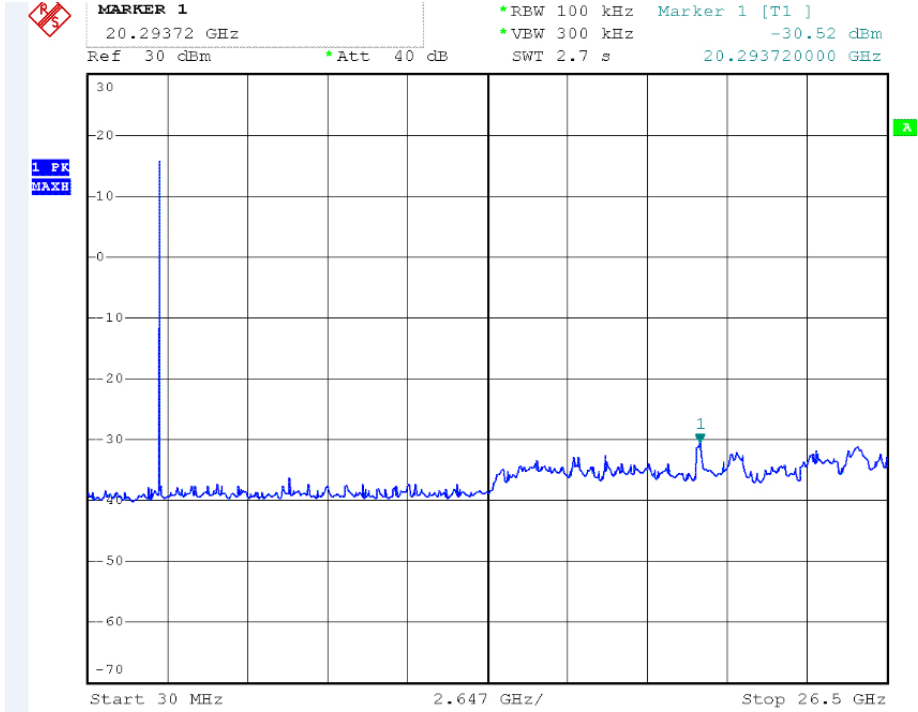

Channel High

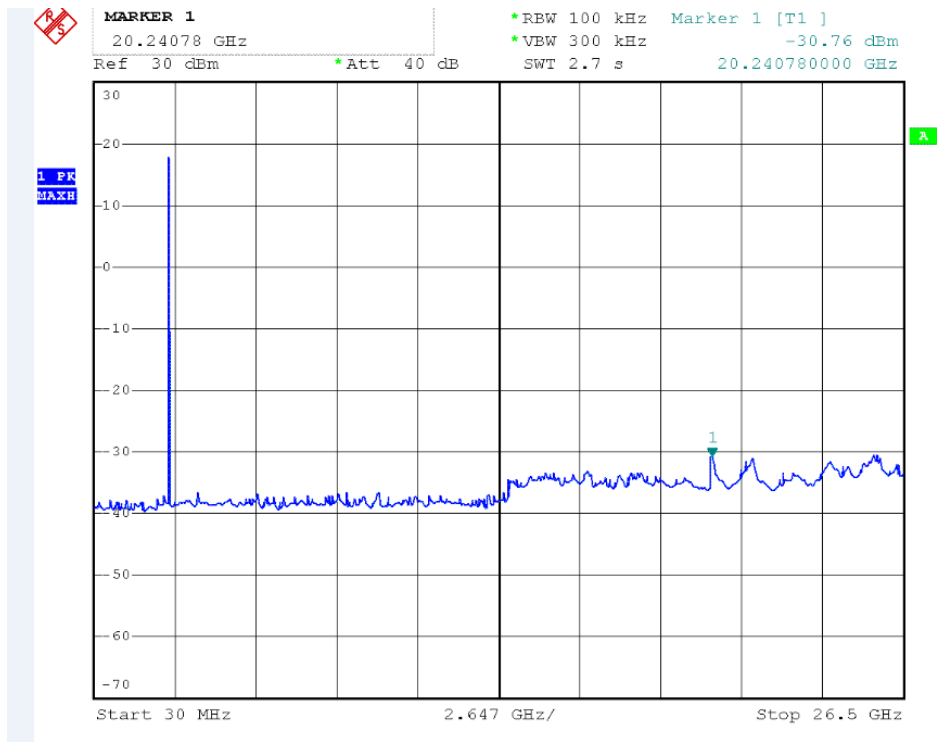

12. ANTENNA REQUIREMENT

12.1 Standard Applicable

Section 15.203:

An intentional radiator shall be designed to ensure that no antenna other than that furnished by the responsible party shall be used with the device. The use of a permanently attached antenna or of an antenna that uses a unique coupling to the intentional radiator shall be considered sufficient to comply with the provisions of this Section. The manufacturer may design the unit so that a broken antenna can be replaced by the user, but the use of a standard antenna jack or electrical connector is prohibited.

Section 15.247(b)/(c):

If transmitting antennas of directional gain greater than 6 dBi are used, the peak output power from the intentional radiator shall be reduced by the amount in dB that the directional gain of the antenna exceeds 6 dBi.

If the intentional radiator is used exclusively for fixed, point-to-point operations may employ transmitting antennas with directional gain greater than 6 dBi provided the maximum peak output power of the intentional radiator is reduced by 1 dB for every 3 dB that the directional gain of the antenna exceeds 6 dBi.

12.2 Antenna Connected Construction

The antenna connector is designed with permanent attachment and no consideration of replacement. The antenna used in this product is complied with Standard. The maximum Gain of the antenna lower than 6.0dBi and have the definite antenna Specification.