

Prüfbericht-Nr.: <i>Test Report No.:</i>	10052341 001	Auftrags-Nr.: <i>Order No.:</i>	114037741	Seite 1 von 27 Page 1 of 27
Kunden-Referenz-Nr.: <i>Client Reference No.:</i>	N/A	Auftragsdatum: <i>Order date:</i>	1-Jul-2015	
Auftraggeber: <i>Client:</i>	Elgato Systems GmbH, Rotkreuzplatz 1, 80634 München, Germany			
Prüfgegenstand: <i>Test item:</i>	Eve Room			
Bezeichnung / Typ-Nr.: <i>Identification / Type No.:</i>	2ER309901000			
Auftrags-Inhalt: <i>Order content:</i>	FCC Part15C /IC RSS-247 Test report			
Prüfgrundlage: <i>Test specification:</i>	FCC 47CFR Part 15: Subpart C Section 15.247 RSS-247 (05-2015)			
Wareneingangsdatum: <i>Date of receipt:</i>	22-Jul-2015			
Prüfmuster-Nr.: <i>Test sample No.:</i>	A000233359-003			
Prüfzeitraum: <i>Testing period:</i>	4-Aug-2015 - 5-Aug-2015			
Ort der Prüfung: <i>Place of testing:</i>	EMC/RF Laboratory Taipei			
Prüflaboratorium: <i>Testing laboratory:</i>	TUV Rheinland Taiwan Ltd.			
Prüfergebnis*: <i>Test result*:</i>	Pass			
geprüft von / tested by:		kontrolliert von / reviewed by:		
2015-08-31 Ryan W. T. Chen / Project Engineer		2015-08-31 Rene Charton / Senior Project		
<i>Datum</i>	<i>Name / Stellung</i>	<i>Unterschrift</i>	<i>Datum</i>	<i>Name / Stellung</i>
<i>Date</i>	<i>Name / Position</i>	<i>Signature</i>	<i>Date</i>	<i>Name / Position</i>
Sonstiges / Other:				
Zustand des Prüfgegenstandes bei Anlieferung: <i>Condition of the test item at delivery:</i>		Prüfmuster vollständig und unbeschädigt <i>Test item complete and undamaged</i>		
* Legende: 1 = sehr gut 2 = gut 3 = befriedigend 4 = ausreichend 5 = mangelhaft P(ass) = entspricht o.g. Prüfgrundlage(n) F(ail) = entspricht nicht o.g. Prüfgrundlage(n) N/A = nicht anwendbar N/T = nicht getestet				
Legend: 1 = very good 2 = good 3 = satisfactory 4 = sufficient 5 = poor P(ass) = passed a.m. test specification(s) F(ail) = failed a.m. test specification(s) N/A = not applicable N/T = not tested				
Dieser Prüfbericht bezieht sich nur auf das o.g. Prüfmuster und darf ohne Genehmigung der Prüfstelle nicht auszugsweise vervielfältigt werden. Dieser Bericht berechtigt nicht zur Verwendung eines Prüfzeichens. <i>This test report only relates to the a. m. test sample. Without permission of the test center this test report is not permitted to be duplicated in extracts. This test report does not entitle to carry any test mark.</i>				

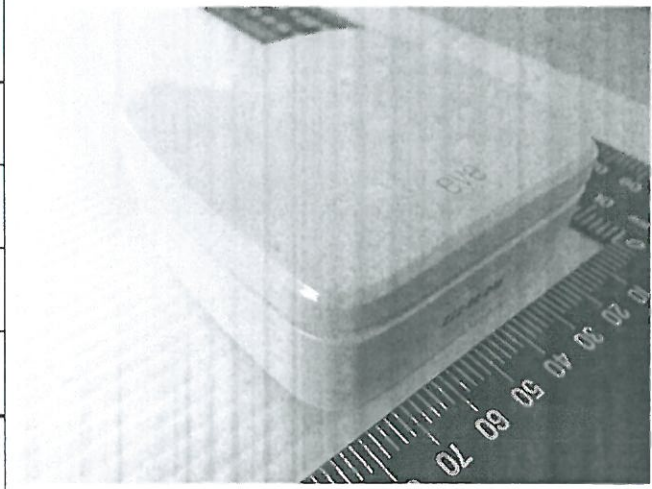

TEST SUMMARY

5.1.1 ANTENNA REQUIREMENT

RESULT: *Passed*

5.1.2 PEAK OUTPUT POWER

RESULT: *Passed*

5.1.3 6dB BANDWIDTH

RESULT: *Passed*

5.1.4 POWER DENSITY

RESULT: *Passed*

5.1.5 CONDUCTED SPURIOUS EMISSIONS AND FREQUENCY BAND EDGE MEASURED IN 100KHz BANDWIDTH

RESULT: *Passed*

5.1.6 SPURIOUS EMISSION

RESULT: *Passed*

6.1.1 ELECTROMAGNETIC FIELDS

RESULT: *Passed*

Contents

1.	GENERAL REMARKS	4
1.1	COMPLEMENTARY MATERIALS.....	4
2.	TEST SITES	5
2.1	TEST LABORATORY	5
2.2	TEST FACILITY.....	5
2.3	LIST OF TEST AND MEASUREMENT INSTRUMENTS.....	6
2.4	TRACEABILITY	7
2.5	CALIBRATION	7
2.6	MEASUREMENT UNCERTAINTY	7
3.	GENERAL PRODUCT INFORMATION.....	8
3.1	PRODUCT FUNCTION AND INTENDED USE	8
3.2	SYSTEM DETAILS AND RATINGS.....	8
3.3	INDEPENDENT OPERATION MODES.....	9
3.4	NOISE GENERATING AND NOISE SUPPRESSING PARTS	9
3.5	SUBMITTED DOCUMENTS.....	9
4.	TEST SET-UP AND OPERATION MODES.....	10
4.1	PRINCIPLE OF CONFIGURATION SELECTION	10
4.2	TEST OPERATION AND TEST SOFTWARE.....	10
4.3	SPECIAL ACCESSORIES AND AUXILIARY EQUIPMENT	10
4.4	COUNTERMEASURES TO ACHIEVE EMC COMPLIANCE.....	11
5.	TEST RESULTS	12
5.1	TRANSMITTER REQUIREMENT & TEST SUITES.....	12
5.1.1	<i>Antenna Requirement</i>	<i>12</i>
5.1.2	<i>Peak Output Power</i>	<i>13</i>
5.1.3	<i>6dB Bandwidth</i>	<i>16</i>
5.1.4	<i>Power Density</i>	<i>19</i>
5.1.5	<i>Conducted spurious emissions and Frequency Band Edge measured in 100kHz Bandwidth.....</i>	<i>22</i>
5.1.6	<i>Spurious Emission</i>	<i>23</i>
6.	SAFETY HUMAN EXPOSURE	24
6.1	RADIO FREQUENCY EXPOSURE COMPLIANCE	24
6.1.1	<i>Electromagnetic Fields.....</i>	<i>24</i>
7.	PHOTOGRAPHS OF THE TEST SET-UP.....	25

8.	LIST OF TABLES	27
9.	LIST OF PHOTOGRAPHS.....	27

1. General Remarks

1.1 Complementary Materials

These attachments are integral parts of this test report:

Appendix P: Photo Documentation internal view
(File Name: 10052341APPENDIX P)

Appendix D: Test Result of Radiated Emissions
(File Name: 10052341APPENDIX D)

Test Specifications

The following standards were applied.

Table 1: Applied Standard and Test Levels

Radio
NCC Low-power Radio-frequency Devices Technical Regulations LP0002(2011)(100年6月28日) FCC CFR47 Part 15: Subpart C Section 15.247 RSS-247 Issue 1 May 2015 RSS-Gen, Issue 4, November 2014 ANSI C63.10:2013 KDB558074 D01 DTS Meas Guidance v02

2. Test Sites

2.1 Test Laboratory

TUV Rheinland Taiwan Ltd.
Taichung Branch Office

No.9, Lane 36, Minsheng Rd., Sec. 3, Daya District,
Taichung City 428
Taiwan (R.O.C.)

2.2 Test Facility

TUV Rheinland Taiwan Ltd.
Taipei Office

11F. No.758, Sec. 4, Bade Rd., Songshan Dist.
Taipei City 105
Taiwan (R.O.C.)

FCC RegistrationNo.: 365730
IC Canada Registration No.: 9465A-1
TAF Accredited NCC Test Lab. No.:0759
TAF ISO17025 Certification effective periods: 2013-Jul-1st to 2016-Jun-30th



Testing Laboratory
0759

2.3 List of Test and Measurement Instruments

Table 2: List of Test and Measurement Equipment

Kind of Equipment	Manufacturer	Type	S/N	Last Calibration	Next Calibration
EMI Test Receiver	R&S	ESR7	101062	31-Aug-14	30-Aug-15
Bilog Antenna	TESEQ	CBL6111D	29802	4-Jul-14	3-Jul-16
Spectrum Analyzer	R&S	FSV 40	100921	17-Dec-14	16-Dec-15
Spectrum Analyzer	Agilent	N9010A	MY53470241	1-Apr-15	30-Mar-16
Horn Antenna	ETS-Lindgren	3117	138160	12-Jan-15	11-Jan-17
Horn Antenna (18GHz~40GHz)	COM-POWER	AH840	101031	30-Oct-13	29-Oct-15
Preamplifier (30MHz -1GHz)	HP	8447F	2805A03335	23-Aug-14	22-Aug-15
Preamplifier (18 GHz -40 GHz)	COM-POWER	PAM-840	461257	26-Aug-14	25-Aug-15
Pre-Amplifier (1GHz~18GHz)	EM Electronics	EM30180	60558	4-Nov-14	3-Nov-15
Loop Antenna	Schwarzbeck	FMZB 1513	1513-076	22-Oct-14	21-Oct-15
EMI Test Receiver	R&S	ESCI7	100797	28-Dec-14	27-Dec-15
Spectrum Analyzer	R&S	FSL3	101943	14-Sep-14	13-Sep-15
LISN (1 phase)	R&S	ENV216	101243	1-Jun-15	31-May-16
LISN	Rolf Heine	NNB-2/16Z	99080	26-Aug-14	25-Aug-15

2.4 Traceability

All measurement equipment calibrations are traceable to NML(Taiwan)/NIST(USA) or where calibration is performed outside Taiwan, to equivalent nationally recognized standards organizations.

2.5 Calibration

Equipment requiring calibration is calibrated periodically in a suitably accredited Calibration Lab. Additionally all equipment is verified for proper performance on a regular schedule using in house standards or comparisons.

2.6 Measurement Uncertainty

The estimated combined standard uncertainty for radiated emissions and conducted emissions measurements .

Table 3: Emission Measurement Uncertainty

Parameter	Uncertainty
Radio Frequency	$\pm 1 \times 10^{-7}$
RF power, conducted	± 1.5 dB
RF power density, conducted	± 3 dB
spurious emissions, conducted	± 3 dB
all emissions, radiated	± 6 dB
Temperature	± 1 °C
Humidity	± 5 %
DC and low frequency voltages	± 3 %

3. General Product Information

3.1 Product Function and Intended Use

The EUT is a environment detector. It contains a Bluetooth LE compatible module enabling the user to communicate data through a Wireless interface.
For details refer to the User Guide, Data Sheet and Circuit Diagram.

3.2 System Details and Ratings

Table 4: Basic Information of EUT

Item	EUT information
Kind of Equipment	Eve Room
Type Designation	2ER309901000
Brand Name	Eva
FCC ID	SNE-ROOM-001
Canada ID	11192A-ROOM001
Canada HVIN	2ER309901000

Table 5: Technical Specification of EUT

Technical Specification	Value
Operating Frequencies	2402~2480 MHz
Channel Spacing	2 MHz
Channel number	40
Operation Voltage	3 V
Modulation	GFSK
Antenna gain	1 dBi

3.3 Independent Operation Modes

Basic operation modes are:

- A. Transmitting
 - 1. Low channel
 - 2. Middle channel
 - 3. High channel
- B. Receiving
- C. Standby
- D. Off

3.4 Noise Generating and Noise Suppressing Parts

Refer to the Circuit Diagram.

3.5 Submitted Documents

- Circuit Diagram
- Instruction Manual
- Rating Label
- Technical Description

4. Test Set-up and Operation Modes

4.1 Principle of Configuration Selection

The equipment under test (EUT) was configured to measure its maximum power level. The test modes were adapted accordingly in reference to the instructions for use.

4.2 Test Operation and Test Software

Setup for testing: Test samples are provided with a USB SPI interface which makes it possible to control them through a test software installed on a notebook computer.

This software was running on the laptop computer connected to the EUT. It was used to enable the operation modes listed in section 3.3 as appropriate.

The samples were used as follows:

Conducted: A000233359-003

Radiation: A000233359-003

Full test was applied on all test modes, but only worst case was shown

4.3 Special Accessories and Auxiliary Equipment

The product has been tested together with the following additional accessories:

Kind of Equipment	Manufacturer	S/N
Laptop	HP	CNF0339QBM

4.4 Countermeasures to achieve EMC Compliance

The test sample which has been tested contained the noise suppression parts as described in the Constructional Data Form or the Technical Construction File. No additional measures were employed to achieve compliance.

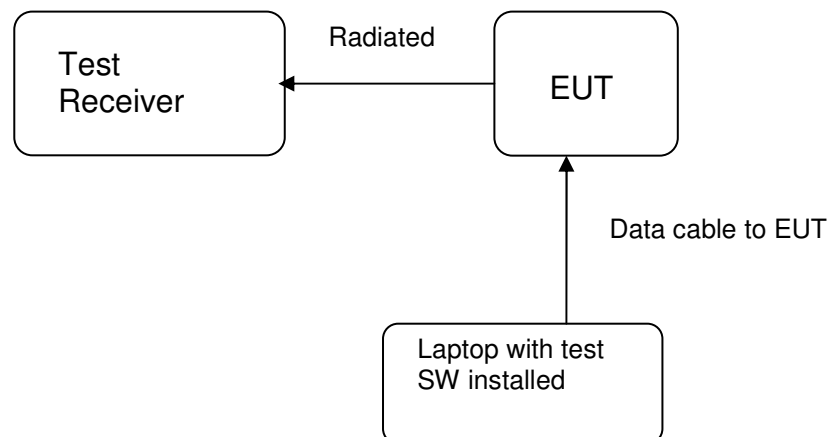

5. Test Results

5.1 Transmitter Requirement & Test Suites

5.1.1 Antenna Requirement

RESULT:**Passed**

Test standard	:	LP0002(2011): 2.2, 3.10.1, (3) FCC Part 15.247(b)(4), Part 15.203 and RSS- Gen 8.3
Requirement	:	use of approved antennas only with directional gains that do not exceed 6 dBi

According to the manufacturer declaration, the EUT has an antenna with a directional gain of 1 dBi. The antenna is inside the RF chip with no possibility of replacement with a non-approved antenna by the end-user. Therefore, the EUT is considered to comply with this provision.

Refer to EUT photo for details.

5.1.2 Peak Output Power

RESULT:
Passed

Test standard : LP0002(2011): 3.10.1, (2)
 FCC Part 15.247(b)(3), RSS-247 5.4(4)
 Basic standard : ANSI C63.10:2013, KDB558074
 Limit : 1 Watt
 Kind of test site : Semi-anechoic chamber

Test setup

Test Channel : Low/ Middle/ High
 Operation Mode : A
 Ambient temperature : 20-24 °C
 Relative humidity : 50-65 %
 Atmospheric pressure : 100-103 kPa

Table 6: Test result of Peak Output Power

Channel	Channel Frequency (MHz)	Output Power				Limit
		measured	Gain	result		
		(dBm)	(dBi)	(dBm)	(W)	(W)
Low Channel	2402	-11.79	0	-11.79	0.000066	1
Middle Channel	2440	-10.76	-0.5	-10.26	0.000094	1
High Channel	2480	-10.80	1	-11.80	0.000066	1

Pmax: 0.0942 mW

Test Plot of Output Power

Low Channel

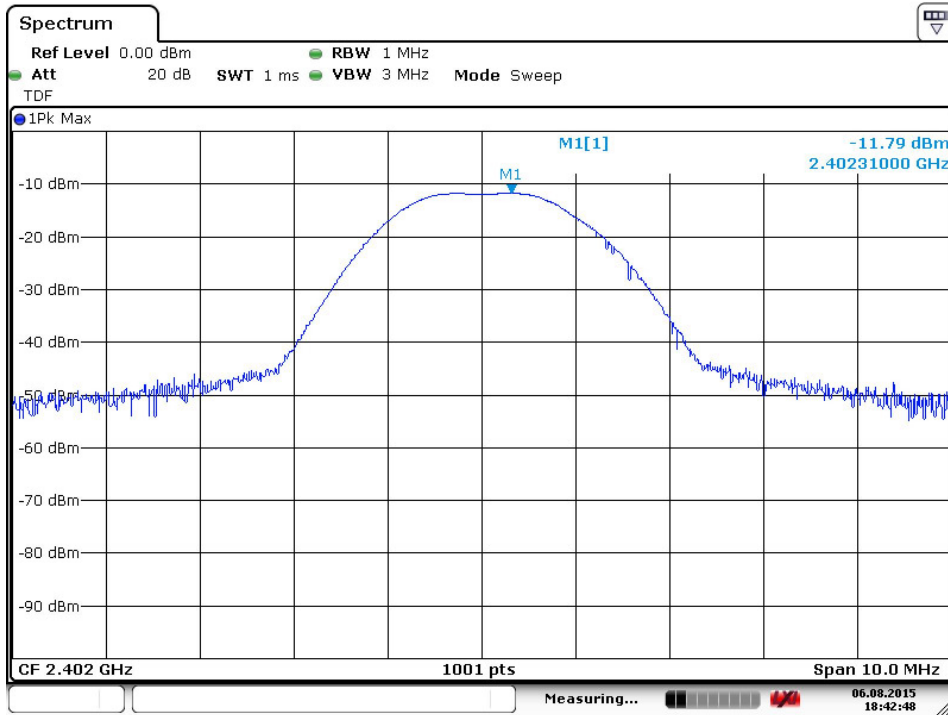

Date: 6.AUG.2015 18:42:49

Middle Channel

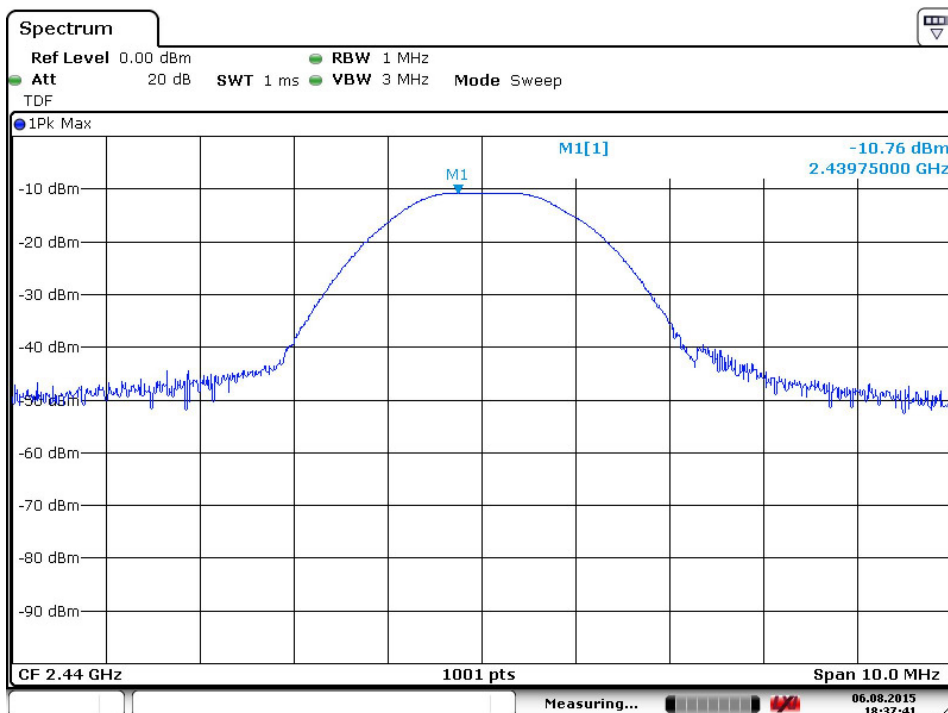

Date: 6.AUG.2015 18:37:42

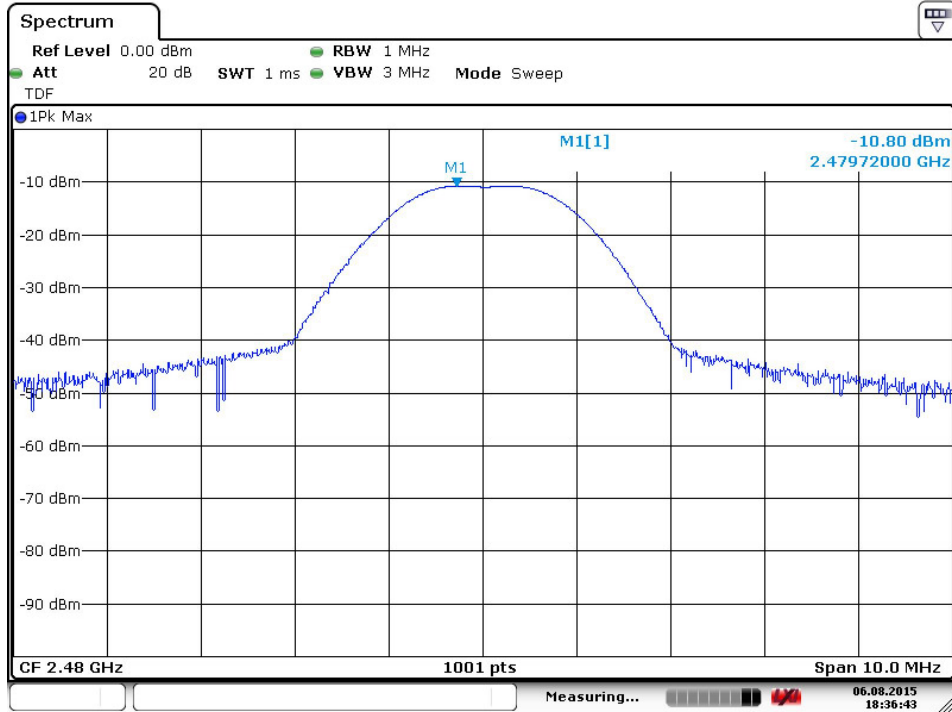
High Channel

Date: 6.AUG.2015 18:36:43

5.1.3 6dB Bandwidth

RESULT:
Passed

Test standard : LP0002(2011): 3.10.1, (5)
 FCC Part 15.247(a)(2), RSS-247 5.2(1)
 Basic standard : ANSI C63.10:2013, KDB558074
 Kind of test site : Semi-anechoic chamber

Test setup

Test Channel : Low/ Middle/ High
 Operation Mode : A

Ambient temperature : 20-24°C
 Relative humidity : 50-65%
 Atmospheric pressure : 100-103 kPa

Table 7: Test result of 6dB Bandwidth

Channel	Channel Frequency (MHz)	6dB Bandwidth (kHz)	Limit (kHz)	Result
Low Channel	2402	683.9	>500	Pass
Mid Channel	2440	689.3	>500	Pass
High Channel	2480	694.9	>500	Pass

Table 8: Test result of 99% Bandwidth, GFSK modulation

Channel	Channel Frequency (MHz)	99% Bandwidth (MHz)
Low Channel	2402	1.1576
Mid Channel	2440	1.1301
High Channel	2480	1.123

Test Plot of 6dB Bandwidth

Low Channel

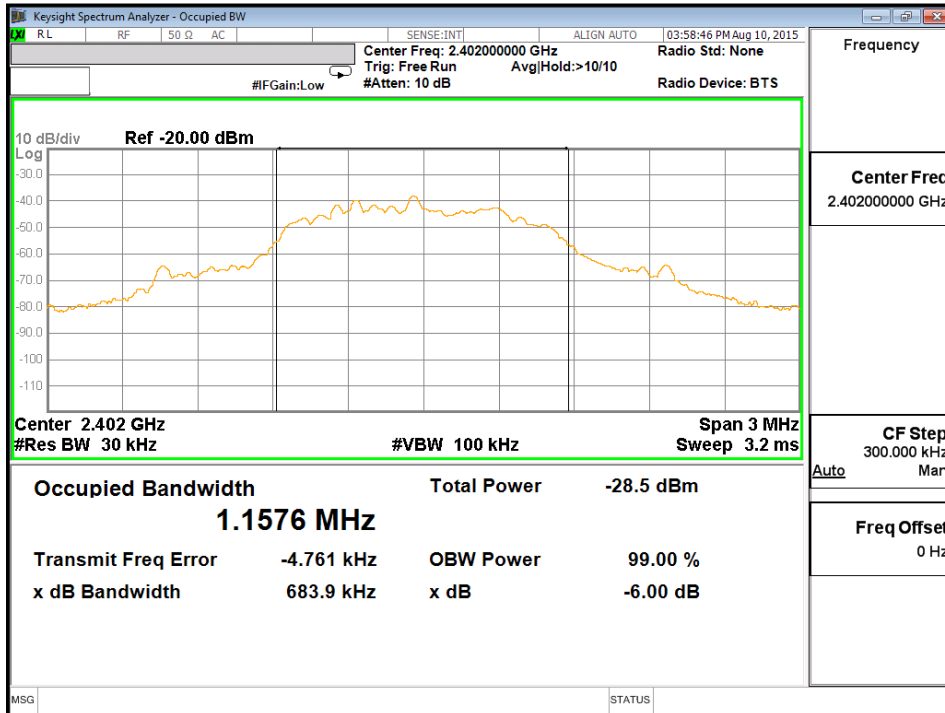

Middle Channel

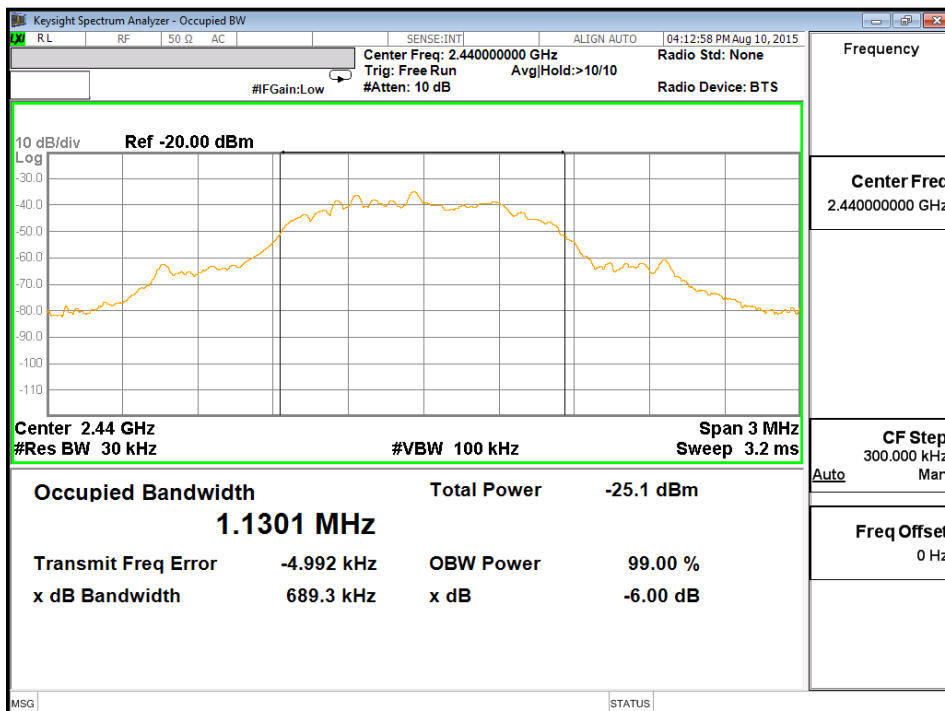

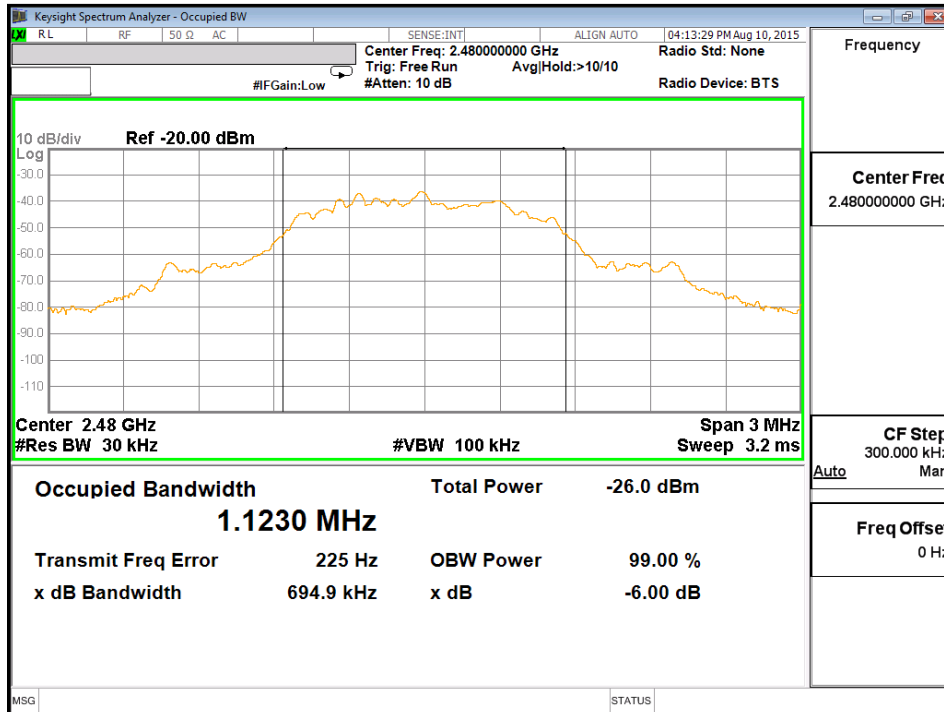
High Channel

5.1.4 Power Density

RESULT:
Passed

Test standard : LP0002(2011): 3.10.1, (6.2.2)
 FCC Part 15.247(e) , RSS-247 5.2(2)
 Basic standard : ANSI C63.10:2013, KDB558074
 Kind of test site : Semi-anechoic chamber

Test setup

Test Channel : Low/ Middle/ High
 Operation Mode : A
 Ambient temperature : 20-24°C
 Relative humidity : 50-65%
 Atmospheric pressure : 100-103 kPa

Table 9: Test result of Power Density

Channel	Channel Frequency (MHz)	Power Density	Limit
		(dBm)	(dBm)
Low Channel	2402	-27.04	8
Middle Channel	2440	-25.95	8
High Channel	2480	-26.31	8

Test Plot of Power Density

Low Channel

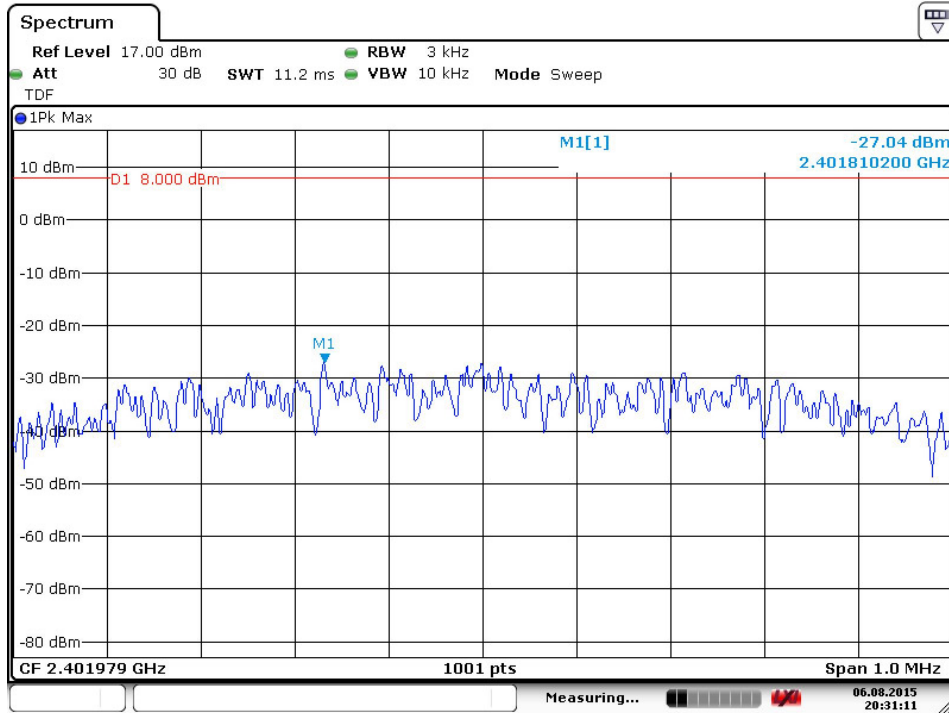

Date: 6.AUG.2015 20:31:11

Middle Channel

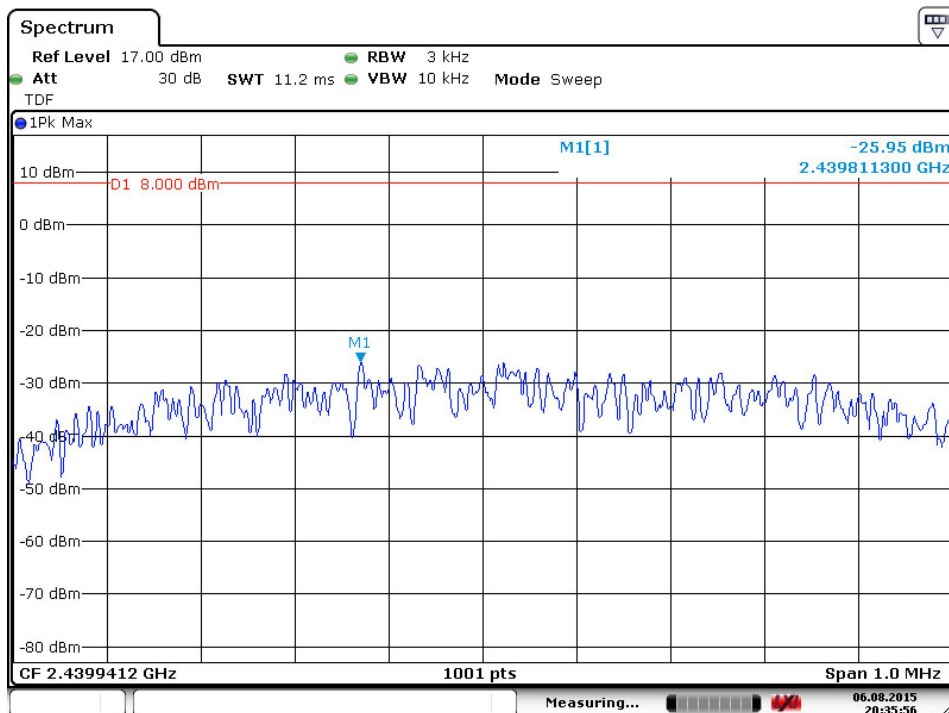

Date: 6.AUG.2015 20:35:56

High Channel

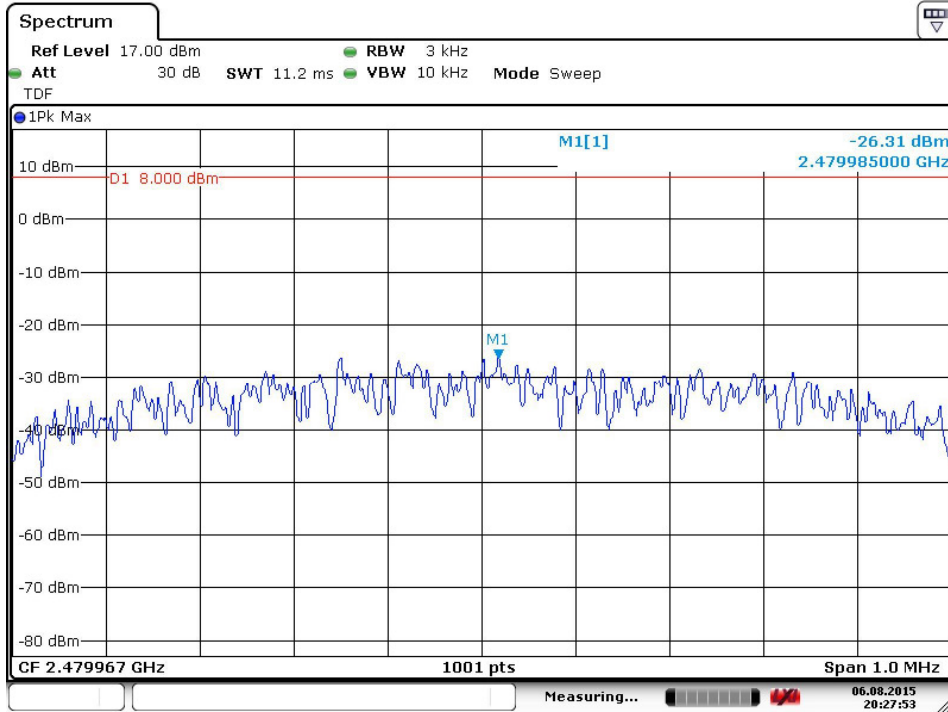

Date: 6.AUG.2015 20:27:53

5.1.5 Conducted spurious emissions and Frequency Band Edge measured in 100kHz Bandwidth

RESULT:**Passed**

Test standard	:	LP0002(2011): 3.10.1, (5) FCC part 15.247(d), RSS-247 5.5
Basic standard	:	ANSI C63.10:2013, KDB558074
Limit	:	20dB (below that in the 100kHz bandwidth within the band that contains the highest level of the desired power)
Kind of test site	:	Semi-anechoic chamber

Test setup

Test Channel	:	Low/ High
Operation mode	:	A
Ambient temperature	:	20-24°C
Relative humidity	:	50-65%
Atmospheric pressure	:	100-103 kPa

All emissions are more than 20dB below fundamental, details refer to following test plot, and compliance is achieved as well.

Due to the small size of the product and that there are no inductive components of significant size, 9kHz to 30MHz frequency range is not tested based on technical judgment.

Since Antenna is design to combine with Chip,the test item was perform by Radiation method,the evaluation can be comply with limit,for detail,please refer to AppendixD .

5.1.6 Spurious Emission

RESULT:**Passed**

Test standard	:	FCC part 15.247(d), FCC 15.205, FCC 15.209, RSS-210 2.2, RSS-247 5.5 and RSS-Gen i4, 8.9 (Table 6), LP0002(2011): 3.10.1, (5)
Basic standard	:	ANSI C63.10: 2009
Limits	:	Radiated emissions which fall in the restricted bands, as defined in FCC 15.205(a) and RSS-Gen i4, 8.9 (Table 6), must comply with the radiated emission limits specified in FCC 15.209(a) and RSS-Gen i4, 8.9 (Table 4 and 5). Radiated emissions which fall in the restricted bands, as defined in LP0002(2011): 2.7 , must comply with the radiated emission limits specified in LP0002(2011): 2.8 Emission radiated outside the specified frequency bands must comply with the radiated emission limits specified in FCC 15.209(a) and FCC 15.249(a), RSS-Gen i4, 8.9 (Table 4 and 5) and RSS-210 A2.9(a). Emission radiated outside the specified frequency bands must comply with the radiated emission limits specified in LP0002(2011): 2.8
Kind of test site	:	3m Semi-Anechoic Chamber

Test setup

Test Channel	:	Low/ Middle/ High
Operation mode	:	A, B

Remark: Testing was carried out within frequency range 30MHz to the tenth harmonic.

For details refer to Appendix D.

Testing was carried out within frequency range 30MHz to the tenth harmonic. For details refer to Appendix D. The Radiated Emissions testing was performed in the X, Y and Z axis orientation. The worst-case Axis orientation is recorded in this test report. Due to the small size of the product and that there are no inductive components of significant size, 9kHz to 30MHz frequency range is not tested based on technical judgment.

6. Safety Human exposure

6.1 Radio Frequency Exposure Compliance

6.1.1 Electromagnetic Fields

RESULT:**Passed**

Test standard : FCC KDB Publication 447498 D01 v05

The maximum peak output power of the transmitter is 0.0942 mW.

Hence the EUT is excluded from SAR evaluation.

Please also refer to FCC KDB publication 447498 D01 v05: Mobile Portable RF Exposure

7. Photographs of the Test Set-Up

Photograph 1: Set-up for Fundamental and Spurious Emissions (Front View)

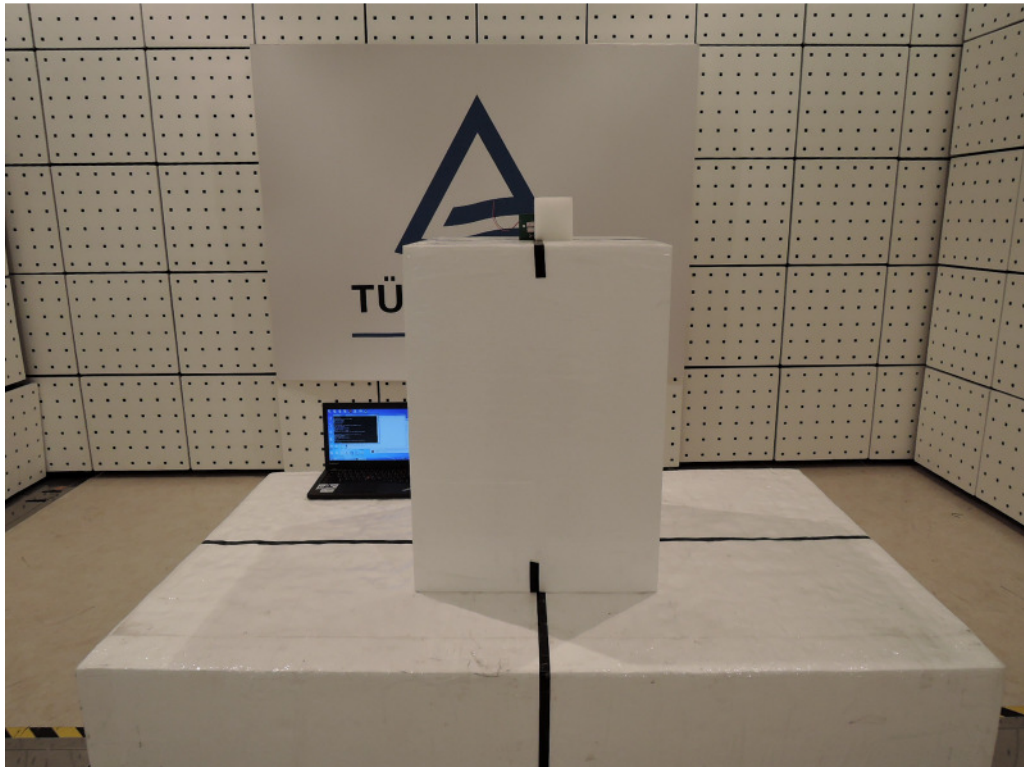

Photograph 2: Set-up for Fundamental and Spurious Emissions (Back View 1)

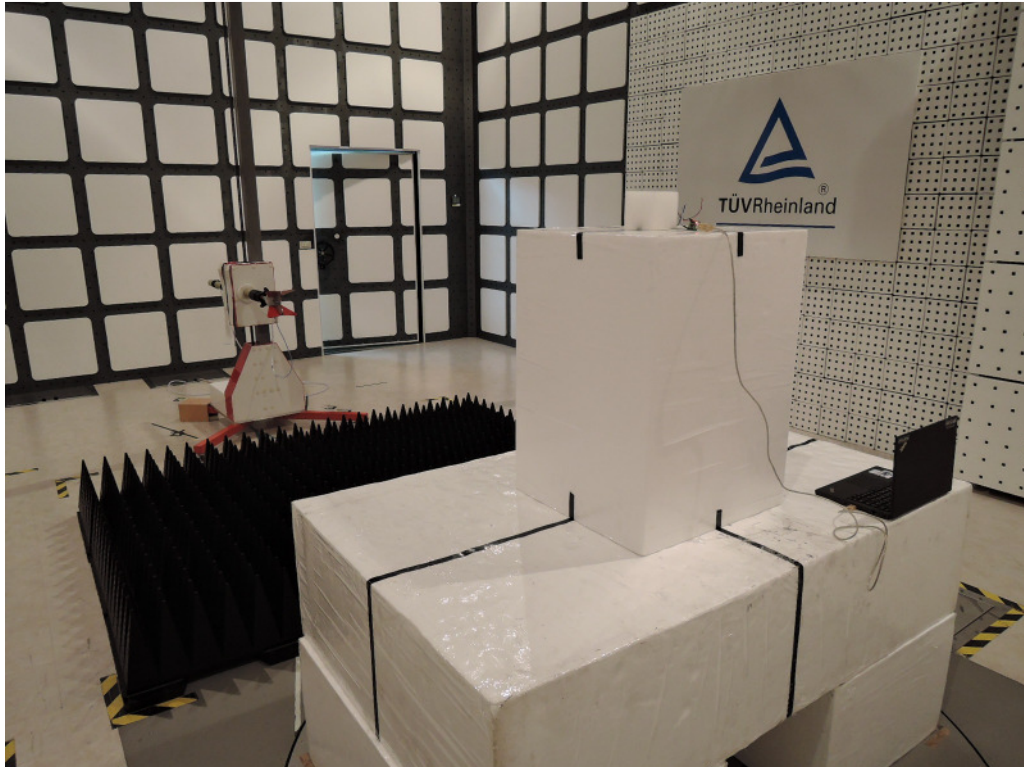

Photograph 3: Set-up for Spurious Emissions (Back View 2)

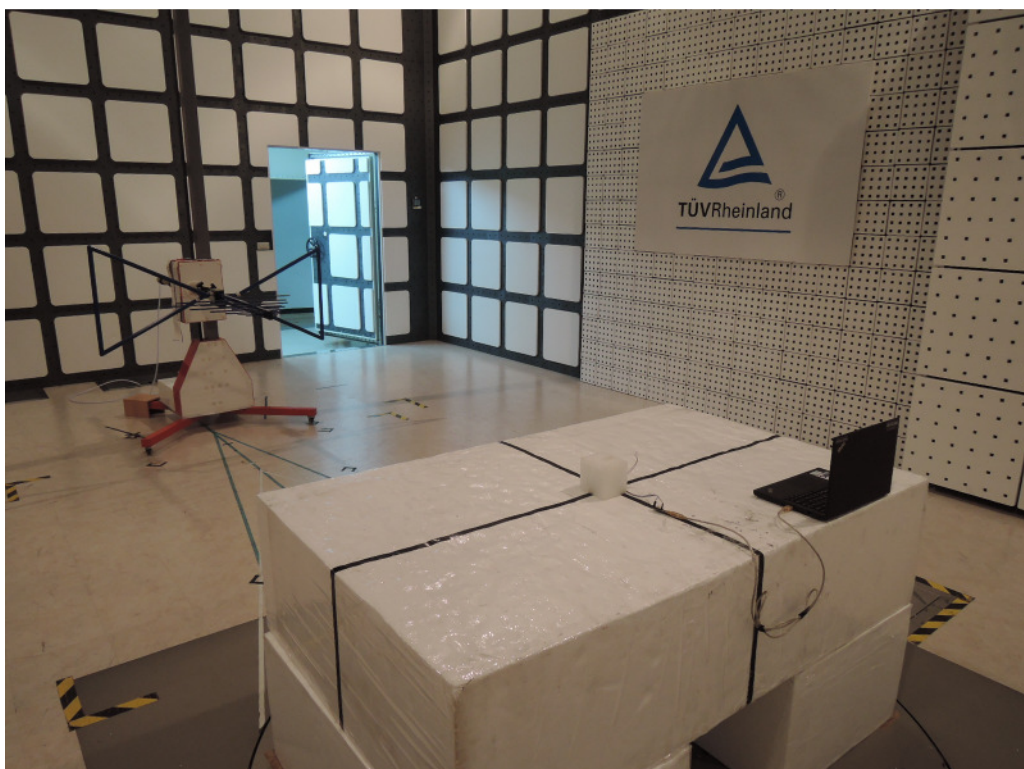

8. List of Tables

Table 1: Applied Standard and Test Levels	4
Table 2: List of Test and Measurement Equipment	6
Table 3: Emission Measurement Uncertainty.....	7
Table 4: Basic Information of EUT	8
Table 5: Technical Specification of EUT	8
Table 6: Test result of Peak Output Power	13
Table 7: Test result of 6dB Bandwidth	16
Table 8: Test result of 99% Bandwidth, GFSK modulation	16
Table 8: Test result of Power Density	19

9. List of Photographs

Photograph 1: Set-up for Spurious Emissions (Front View).....	25
Photograph 2: Set-up for Spurious Emissions (Back View 1)	26
Photograph 3: Set-up for Spurious Emissions (Back View 2)	26