

Certification Test Report

FCC ID: SNA-CFR

FCC Rule Part: 15.247
IC Radio Standards Specification: RSS-210

ACS Report Number: 10-0086.W03.45.A

Manufacturer: Woodstream Corporation
Model: 5144G-R

Test Begin Date: March 15, 2010
Test End Date: March 17, 2010

Report Issue Date: March 25, 2010



FOR THE SCOPE OF ACCREDITATION UNDER LAB Code 200612-0

This report is not be used to claim certification, approval, or endorsement by NVLAP, NIST or any government agency.

Reviewed by:

A handwritten signature in black ink, appearing to read 'Kirby Munroe', is written over a horizontal line.

Kirby Munroe
Director, Wireless Certifications
ACS, Inc.

This test report shall not be reproduced except in full. This report may be reproduced in part with prior written consent of ACS, Inc. The results contained in this report are representative of the sample(s) submitted for evaluation.

This report contains 21 pages

TABLE OF CONTENTS

1	GENERAL	3
1.1	PURPOSE.....	3
1.2	PRODUCT DESCRIPTION	3
1.2.1	<i>General</i>	3
1.3	TEST METHODOLOGY AND CONSIDERATIONS	3
2	TEST FACILITIES.....	4
2.1	LOCATION	4
2.2	LABORATORY ACCREDITATIONS/RECOGNITIONS/CERTIFICATIONS	4
2.3	RADIATED EMISSIONS TEST SITE DESCRIPTION	5
2.3.1	<i>Semi-Anechoic Chamber Test Site</i>	5
2.3.2	<i>Open Area Tests Site (OATS)</i>	6
2.4	CONDUCTED EMISSIONS TEST SITE DESCRIPTION	7
3	APPLICABLE STANDARD REFERENCES.....	7
4	LIST OF TEST EQUIPMENT	8
5	SUPPORT EQUIPMENT	9
6	EQUIPMENT UNDER TEST SETUP BLOCK DIAGRAM	9
7	SUMMARY OF TESTS.....	10
7.1	ANTENNA REQUIREMENT – FCC: SECTION 15.203	10
7.2	POWER LINE CONDUCTED EMISSIONS – FCC: SECTION 15.207 IC: RSS-GEN 7.2.2.....	10
7.2.1	<i>Measurement Procedure</i>	10
7.2.2	<i>Measurement Results</i>	10
7.3	RADIATED EMISSIONS – FCC: SECTION 15.109(UNINTENTIONAL RADIATION) IC: RSS-210 2.6..	12
7.3.1	<i>Measurement Procedure</i>	12
7.3.2	<i>Measurement Results</i>	12
	TABLE 7.3.2-1: RADIATED EMISSIONS TABULATED DATA	12
7.4	6dB / 99% BANDWIDTH – FCC: SECTION 15.247(A)(2) IC: RSS-210 A8.2(A)	13
7.4.1	<i>Measurement Procedure</i>	13
7.4.2	<i>Measurement Results</i>	13
7.5	PEAK OUTPUT POWER REQUIREMENT - FCC SECTION 15.247(B)(3) IC: RSS-210 A8.4(4)	15
7.5.1	<i>Measurement Procedure</i>	15
7.5.2	<i>Measurement Results</i>	15
7.6	SPURIOUS EMISSIONS - FCC 15.247D IC:RSS-210 2.6, A8.5	15
7.6.1	<i>RF Conducted Spurious Emissions</i>	15
7.6.1.1	<i>Measurement Procedure</i>	15
7.6.1.2	<i>Measurement Results</i>	15
7.6.2	<i>Radiated Spurious Emissions (Restricted Bands) - FCC Sec. 15.205 IC: RSS-210 2.6</i>	18
7.6.2.1	<i>Measurement Procedure</i>	18
7.6.2.2	<i>Duty Cycle Correction</i>	18
7.6.2.3	<i>Measurement Results</i>	18
7.6.2.4	<i>Sample Calculation:</i>	19
7.7	PEAK POWER SPECTRAL DENSITY- FCC SECTION 15.247(E) IC: RSS-210 A8.2(B).....	20
7.7.1	<i>Measurement Procedure</i>	20
7.7.2	<i>Measurement Results</i>	20
8	CONCLUSION	21

1 GENERAL

1.1 Purpose

The purpose of this report is to demonstrate compliance with Part 15 Subpart C of the FCC's Code of Federal Regulations and Industry Canada's Radio Standards Specification RSS-210.

1.2 Product description

1.2.1 General

The Havahart® Custom Fence Remote model 5144G-R is a component in the Custom-Shape Wireless Dog Fence from Havahart®. The system is driven by a nanoLOC TRX 2.4 GHz transceiver that has been enhanced with complex algorithms, strategic distortion filtering and modular signal amplification to deliver advanced time-of-flight-ranging technology and precision event-stamp mapping.

Technical Details:

Frequency Range: 2400-2483.5MHz

Operating channels: 1 (2441.7 MHz)

Modulation 802.15.4A CSS (Chirp Spread Spectrum)

Operating Voltage: Rechargeable CR123A 3.6V lithium battery / 5VDC (USB)

Manufacturer Information:

Woodstream Corporation

69 N. Locust St.

Lititz, PA 17543

Test Sample Serial Number(s): C

Test Sample Condition: The test samples were provided in good working order with no visible defects.

1.3 Test Methodology and Considerations

For radiated emissions and AC power line conducted emissions the EUT was configured and evaluated as a PC peripheral. For radiated emissions only, the EUT was also tested in a stand-alone configuration. Sections 5.0 and 6.0 of this report detail the test setup. The EUT was tested in orientations representative of final use. Data representing the worst case configuration and orientation is presented in this report.

2 TEST FACILITIES

2.1 Location

The radiated and conducted emissions test sites are located at the following address:

Advanced Compliance Solutions
5015 B.U. Bowman Drive
Buford, GA 30518
Phone: (770) 831-8048
Fax: (770) 831-8598

2.2 Laboratory Accreditations/Recognitions/Certifications

The Semi-Anechoic Chamber Test Site, Open Area Test Site (OATS) and Conducted Emissions Site have been fully described, submitted to, and accepted by the FCC, Industry Canada and the Japanese Voluntary Control Council for Interference by information technology equipment. In addition, ACS is compliant to ISO/IEC 17025 as certified by the National Institute of Standards and Technology under their National Voluntary Laboratory Accreditation Program. The following certification numbers have been issued in recognition of these accreditations and certifications:

FCC Site Registration Number: 894540

Industry Canada Lab Code: IC 4175A-1

VCCI Member Number: 1831

- VCCI OATS Registration Number R-1526
- VCCI Conducted Emissions Site Registration Number: C-1608

NVLAP Lab Code: 200612-0

2.3 Radiated Emissions Test Site Description

2.3.1 Semi-Anechoic Chamber Test Site

The Semi-Anechoic Chamber Test Site consists of a 20' x 30' x 18' shielded enclosure. The chamber is lined with Toyo Ferrite Grid Absorber, model number FFG-1000. The ferrite tile grid is 101 x 101 x 19mm thick and weighs approximately 550 grams. These tiles are mounted on steel panels and installed directly on the inner walls of the chamber.

The turntable is 150cm in diameter and is located 160cm from the back wall of the chamber. The chamber is grounded via 1 - 8' copper ground rod, installed at the center of the back wall, it is bound to the ground plane using 3/4" stainless steel braided cable.

The turntable is all steel, flush mounted table installed in an all steel frame. The table is remotely operated from inside the control room located 25' from the range. The turntable is electrically bonded to the surrounding ground plane via steel fingers installed on the edge of the turn table. The steel fingers make constant contact with the ground plane during operation.

Behind the turntable is a 3' x 6' x 4' deep shielded pit used for support equipment if necessary. The pit is equipped with 1 - 4" PVC chases from the turntable to the pit that allow for cabling to the EUT if necessary. The underside of the turntable can be accessed from the pit so cables can be supplied to the EUT from the pit.

A diagram of the Semi-Anechoic Chamber Test Site is shown in Figure 2.3-1 below:

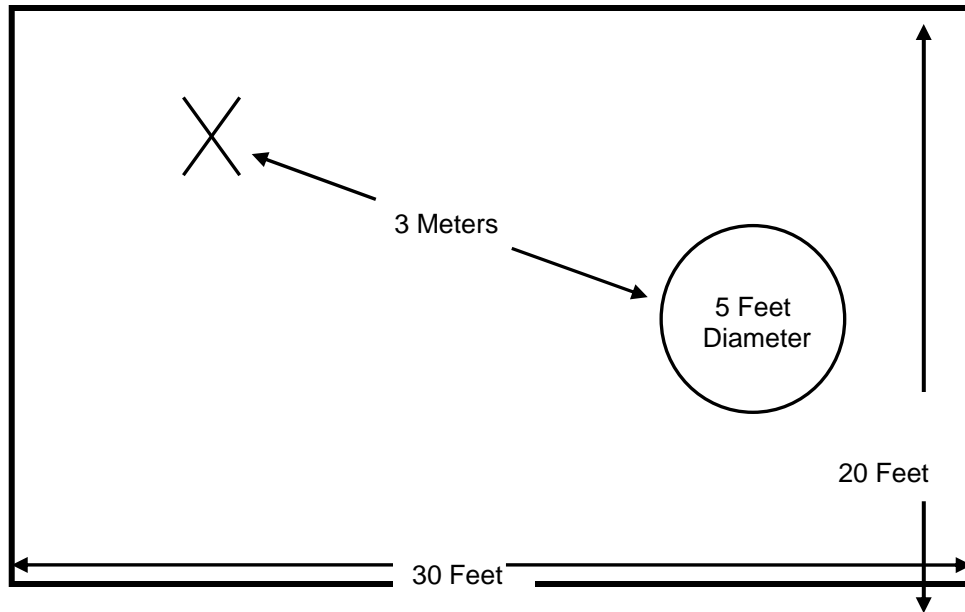

Figure 2.3-1: Semi-Anechoic Chamber Test Site

2.3.2 Open Area Tests Site (OATS)

The open area test site consists of a 40' x 66' concrete pad covered with a perforated electro-plated galvanized sheet metal. The perforations in the sheet metal are 1/8" holes that are staggered every 3/16". The individual sheets are placed to overlap each other by 1/4" and are riveted together to provide a continuous seam. Rivets are spaced every 3" in a 3 x 20 meter perimeter around the antenna mast and EUT area. Rivets in the remaining area are spaced as necessary to properly secure the ground plane and maintain the electrical continuity.

The entire ground plane extends 12' beyond the turntable edge and 16' beyond the antenna mast when set to a 10 meter measurement distance. The ground plane is grounded via 4 - 8' copper ground rods, each installed at a corner of the ground plane and bound to the ground plane using 3/4" stainless steel braided cable.

The turntable is an all aluminum 10' flush mounted table installed in an all aluminum frame. The table is remotely operated from inside the control room located 40' from the range. The turntable is electrically bonded to the surrounding ground plane via steel fingers installed on the edge of the turn table. The steel fingers make constant contact with the ground plane during operation.

Adjacent to the turntable is a 7' x 7' square and 4' deep concrete pit used for support equipment if necessary. The pit is equipped with 5 - 4" PVC chases from the pit to the control room that allow for cabling to the EUT if necessary. The underside of the turntable can be accessed from the pit so cables can be supplied to the EUT from the pit. The pit is covered with 2 sheets of 1/4" diamond style re-enforced steel sheets. The sheets are painted to match the perforated steel ground plane; however the underside edges have been masked off to maintain the electrical continuity of the ground plane. All reflecting objects are located outside of the ellipse defined in ANSI C63.4.

A diagram of the Open Area Test Site is shown in Figure 2.3-2 below:

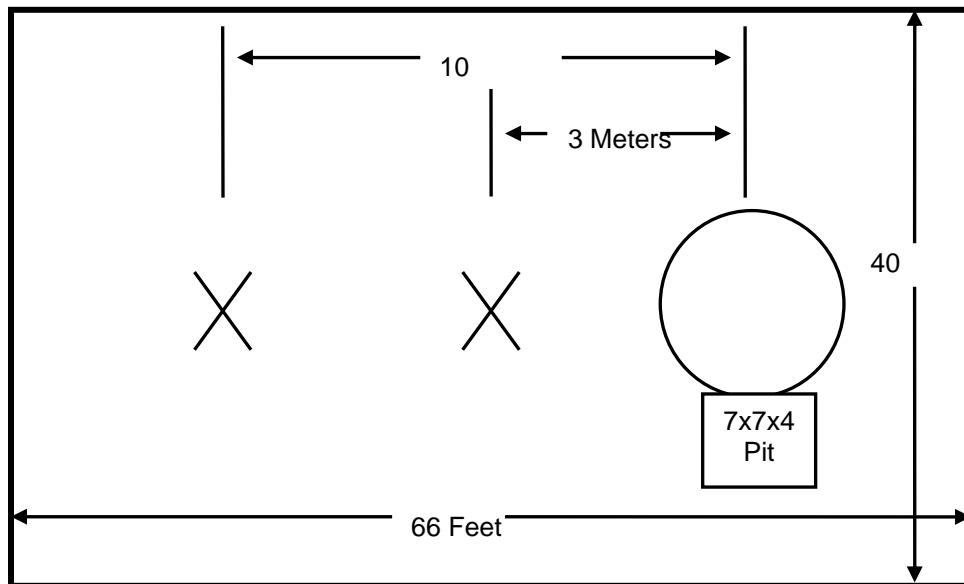

Figure 2.3-2: Open Area Test Site

2.4 Conducted Emissions Test Site Description

The AC mains conducted EMI site is located in the main EMC lab. It consists of an 8' x 8' solid aluminum horizontal group reference plane (GRP) bonded every 3" to an 8' X 8' vertical ground plane.

The site is of sufficient size to test table top and floor standing equipment in accordance with section 6.1.4 of ANSI C63.4.

A diagram of the room is shown below in figure 4.1.3-1:

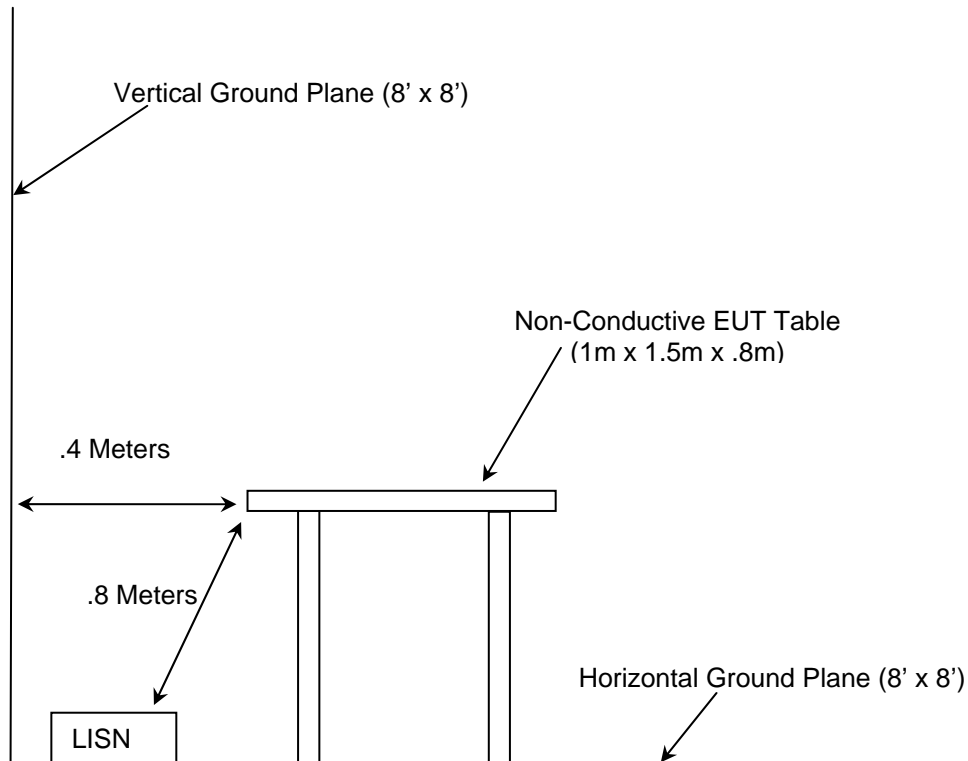

Figure 2.4-1: AC Mains Conducted EMI Site

3 APPLICABLE STANDARD REFERENCES

The following standards were used:

- ❖ ANSI C63.4-2003: Method of Measurements of Radio-Noise Emissions from Low-Voltage Electrical and Electronic Equipment in the 9KHz to 40GHz
- ❖ US Code of Federal Regulations (CFR): Title 47, Part 2, Subpart J: Equipment Authorization Procedures, 2009
- ❖ US Code of Federal Regulations (CFR): Title 47, Part 15, Subpart C: Radio Frequency Devices, Intentional Radiators, 2009
- ❖ FCC KDB Publication No. 558074 - Guidance on Measurements for Digital Transmission Systems (47 CFR 15.247), March 2005
- ❖ Industry Canada Radio Standards Specification: RSS-210 - Low-power License-exempt Radiocommunication Devices (All Frequency Bands): Category I Equipment, Issue 7 June 2007
- ❖ Industry Canada Radio Standards Specification: RSS-GEN – General Requirements and Information for the Certification of Radiocommunication Equipment, Issue2, June 2007.

4 LIST OF TEST EQUIPMENT

The calibration interval of test equipment is annually or the manufacturer's recommendations. Where the calibration interval deviates from the annual cycle based on the instrument manufacturer's recommendations, it shall be stated below.

Table 4-1: Test Equipment

Equipment Calibration Information					
ACS#	Mfg.	Eq. type	Model	S/N	Cal. Due
1	Rohde & Schwarz	Spectrum Analyzers	ESMI - Display	833771/007	09-21-2010
2	Rohde & Schwarz	Spectrum Analyzers	ESMI-Receiver	839587/003	09-21-2010
3	Rohde & Schwarz	Spectrum Analyzers	ESMI - Display	839379/011	02-02-2011
4	Rohde & Schwarz	Spectrum Analyzers	ESMI-Receiver	833827/003	02-02-2011
25	Chase	Antennas	CBL6111	1043	09-02-2010
30	Spectrum Technologies	Antennas	DRH-0118	970102	05-08-2010
73	Agilent	Amplifiers	8447D	2727A05624	07-15-2010
153	EMCO	LISN	3825/2	9411-2268	01-11-2011
167	ACS	Cable Set	Chamber EMI Cable Set	167	01-25-2011 (See Note1)
168	Hewlett Packard	Attenuators	11947A	44829	02-04-2011 (See Note2)
267	Agilent	Power Meter	N1911A	MY45100129	11-16-2010
268	Agilent	Sensor	N1921A	MY45240184	11-16-2010
283	Rohde & Schwarz	Spectrum Analyzers	FSP40	1000033	09-21-2010
291	Florida RF Cables	Cables	SMRE-200W-12.0-SMRE	None	11-24-2010 (See Note1)
292	Florida RF Cables	Cables	SMR-290AW-480.0-SMR	None	11-24-2010 (See Note1)
324	ACS	Cables	Belden	8214	07-15-2010
329	A.H.Systems	Antennas	SAS-571	721	08-04-2010
338	Hewlett Packard	Amplifiers	8449B	3008A01111	10-16-2010
340	Aeroflex/Weinschel	Attenuators	AS-20	7136	10-16-2010 (See Note2)
422	Florida RF	Cables	SMS-200AW-72.0-SMR	0805	01-26-2011 (See Note2)
432	Microwave Circuits	Filter	H3G020G4	264066	07-17-2010

Note1: Items characterized on an annual cycle. The date shown indicates the next characterization due date.

Note2: Items verified on an annual cycle. The date shown indicates the next verification due date.

5 SUPPORT EQUIPMENT

Table 5-1: Support Equipment

Item	Equipment Type	Manufacturer	Model Number	Serial Number
1	Laptop PC	Dell	D610 model PP11L	CN-0D4571-48643-610-8314
2	DC Power Supply	Dell	PA-1650-05D	CN-OF7970-71615-56T-396B
3	Mouse (Serial)	Microsoft Corp.	28898	4673674

6 EQUIPMENT UNDER TEST SETUP BLOCK DIAGRAM

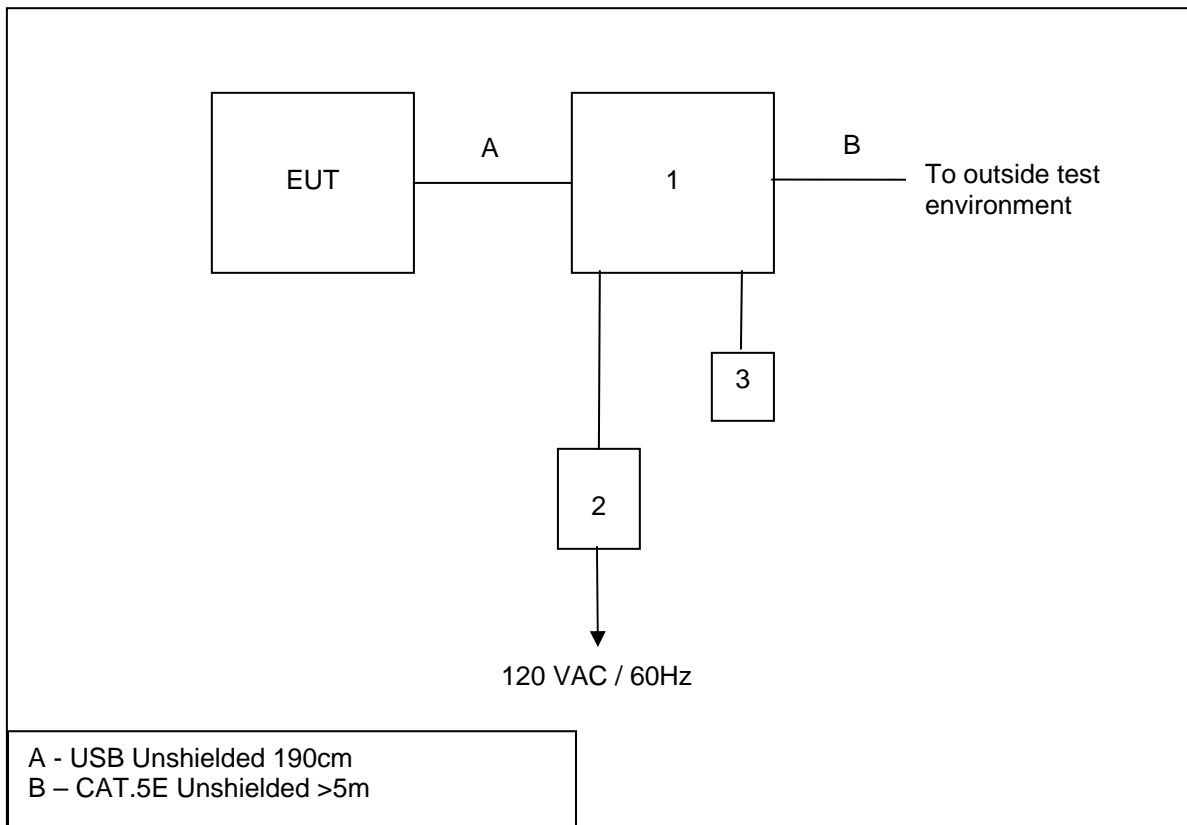

Note: For radiated emissions the EUT was also tested stand-alone with no support equipment utilized.

7 SUMMARY OF TESTS

Along with the tabular data shown below, plots were taken of all signals deemed important enough to document.

7.1 Antenna Requirement – FCC: Section 15.203

The EUT utilizes an integral Skywave dipole antenna part number 81-3000-A with 3dBi gain. The antenna is non-detachable which meets the requirements of 15.203 for unique antenna coupling.

7.2 Power Line Conducted Emissions – FCC: Section 15.207 IC: RSS-Gen 7.2.2

7.2.1 Measurement Procedure

ANSI C63.4 sections 6 and 7 were the guiding documents for this evaluation. Conducted emissions were performed from 150kHz to 30MHz with the spectrum analyzer’s resolution bandwidth set to 9kHz and the video bandwidth set to 30kHz. The calculation for the conducted emissions is as follows:

Corrected Reading = Analyzer Reading + LISN Loss + Cable Loss
Margin = Applicable Limit - Corrected Reading

7.2.2 Measurement Results

Results of the test are shown below in and Table 7.2.2-1 to 7.2.2.2.

Table 7.2.2-1: Line 1 Conducted EMI Results

Frequency (MHz)	Level (dBuV)	Transducer (dB)	Limit (dBuV)	Margin (dB)	Line	PE	Detector
0.18	52	10	65	12.5	L1	GND	QP
0.24	45.4	9.9	62	16.7	L1	GND	QP
2.208	28.2	10	56	27.8	L1	GND	QP
3.456	33.3	9.9	56	22.7	L1	GND	QP
3.576	33.3	9.9	56	22.7	L1	GND	QP
3.696	32.3	9.9	56	23.7	L1	GND	QP
3.876	31.5	9.9	56	24.5	L1	GND	QP
3.996	29	9.9	56	27	L1	GND	QP
4.05	36	9.9	56	20	L1	GND	QP
0.18	41.9	10	55	12.6	L1	GND	QP
0.24	38	9.9	52	14.1	L1	GND	AVG
0.3	34.8	10	50	15.4	L1	GND	AVG
2.202	28.6	10	46	17.4	L1	GND	AVG
3.456	21	9.9	46	25	L1	GND	AVG
3.57	25.3	9.9	46	20.7	L1	GND	AVG
3.696	19.4	9.9	46	26.6	L1	GND	AVG
3.87	27.8	9.9	46	18.2	L1	GND	AVG
3.99	26.3	9.9	46	19.7	L1	GND	AVG
4.044	25.3	9.9	46	20.7	L1	GND	AVG

Table 7.2.2-2: Line 2 Conducted EMI Results

Frequency (MHz)	Level (dBuV)	Transducer (dB)	Limit (dBuV)	Margin (dB)	Line	PE	Detector
0.18	49.8	10	65	14.7	L2	GND	QP
0.3	39.2	10	60	21.1	L2	GND	QP
3.204	34.7	9.9	56	21.3	L2	GND	QP
3.444	34	9.9	56	22	L2	GND	QP
3.564	34.2	9.9	56	21.8	L2	GND	QP
3.684	32.7	9.9	56	23.3	L2	GND	QP
3.798	37.5	9.9	56	18.5	L2	GND	QP
3.918	38.4	9.9	56	17.6	L2	GND	QP
3.978	35.8	9.9	56	20.2	L2	GND	QP
4.272	35.7	9.9	56	20.3	L2	GND	QP
0.18	40.9	10	55	13.6	L2	GND	AVG
0.354	28.4	10	49	20.5	L2	GND	AVG
3.222	8.1	9.9	46	37.9	L2	GND	AVG
3.444	22.5	9.9	46	23.5	L2	GND	AVG
3.552	16.9	9.9	46	29.1	L2	GND	AVG
3.678	28.2	9.9	46	17.8	L2	GND	AVG
3.798	28.7	9.9	46	17.3	L2	GND	AVG
3.858	28	9.9	46	18	L2	GND	AVG
3.966	16.3	9.9	46	29.8	L2	GND	AVG
4.236	10.3	9.9	46	35.7	L2	GND	AVG

7.3 Radiated Emissions – FCC: Section 15.109(Unintentional Radiation) IC: RSS-210 2.6

7.3.1 Measurement Procedure

Radiated emissions tests were performed over the frequency range of 30MHz to 12.5GHz. Measurements of the radiated field strength were made at a distance of 3m from the boundary of the equipment under test (EUT) and the receiving antenna. The antenna height was varied from 1m to 4m so that the maximum radiated emissions level would be detected. Radiated measurements above 30MHz and below 1GHz were made with the Spectrum Analyzer's resolution bandwidth set to 120 KHz using a Quasi-peak detector. Above 1GHz, peak and average measurements are taken with the RBW and VBW were set to 1MHz.

7.3.2 Measurement Results

Results of the test are given in Table 7.3.2-1:

Table 7.3.2-1: Radiated Emissions Tabulated Data

Frequency (MHz)	Level (dBuV)		Antenna Polarity (H/V)	Correction Factors (dB)	Corrected Level (dBuV/m)		Limit (dBuV/m)		Margin (dB)	
	pk	Qpk/Avg			pk	Qpk/Avg	pk	Qpk/Avg	pk	Qpk/Avg
30	-----	41.33	V	-6.70	-----	34.63	-----	40.0	-----	5.4
51.5	-----	51.87	V	-17.23	-----	34.64	-----	40.0	-----	5.4
249.996	-----	50.40	H	-12.00	-----	38.40	-----	46.0	-----	7.6
399.996	-----	43.92	H	-7.60	-----	36.32	-----	46.0	-----	9.7
700.033	-----	35.59	H	-1.80	-----	33.79	-----	46.0	-----	12.2
798.255	-----	34.78	V	-0.40	-----	34.38	-----	46.0	-----	11.6

* Note: All emissions above 798 MHz were attenuated below the permissible limit.

7.4 6dB / 99% Bandwidth – FCC: Section 15.247(a)(2) IC: RSS-210 A8.2(a)

7.4.1 Measurement Procedure

The 6dB bandwidth was measured in accordance with the FCC KDB Publication No. 558074 “Guidance on Measurements for Digital Transmission Systems (47 CFR 15.247)”. The RBW of the spectrum analyzer was set to 100 kHz and VBW 300 kHz. Span was set large enough to capture the entire emissions and >> RBW.

The 99% occupied bandwidth was measured with the spectrum analyzer span set to fully display the emission and approximately 20 dB below the peak level. The RBW was to 1% - 3% of the estimated emission bandwidth. The trace was set to max hold with a peak detector active. The occupied bandwidth measurement function of the analyzer was used for the 99% bandwidth.

7.4.2 Measurement Results

Results are shown below in table 7.4.2-1 and figure 7.4.2-1 to 7.4.2-2:

Table 7.4.2-1: 6dB / 99% Bandwidth

Frequency [MHz]	6dB Bandwidth [MHz]	99% Bandwidth [MHz]
2441.7	57.6	57.6

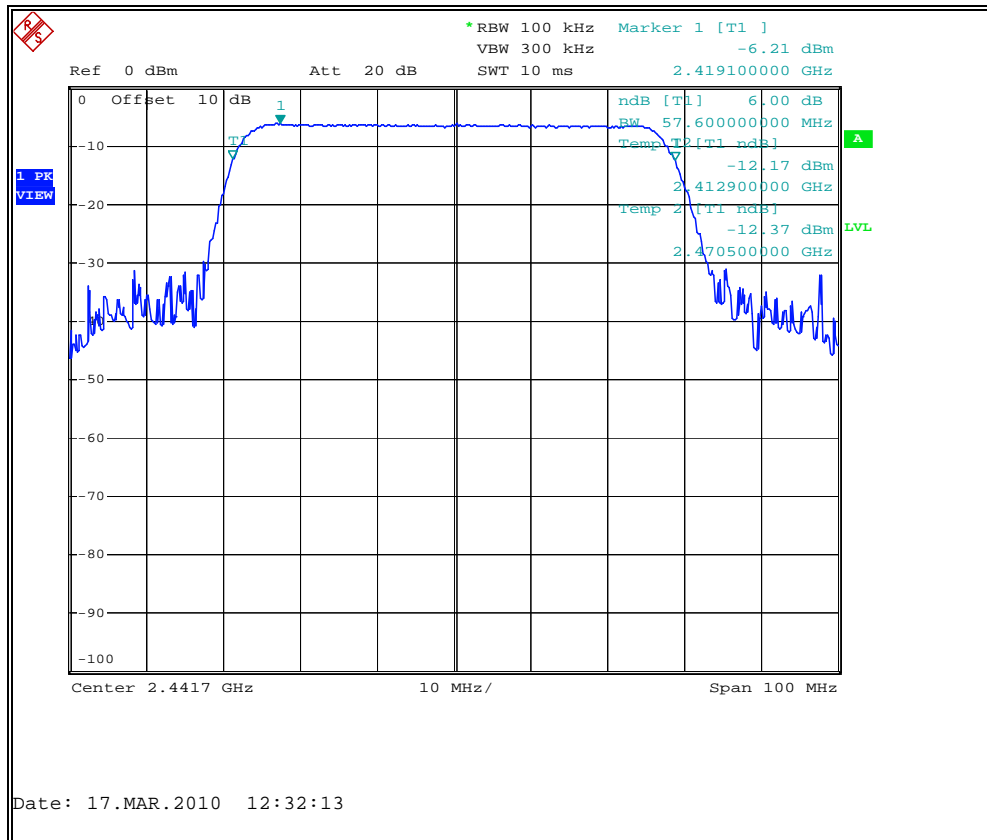

Figure 7.4.2-1: 6dB Bandwidth Plot

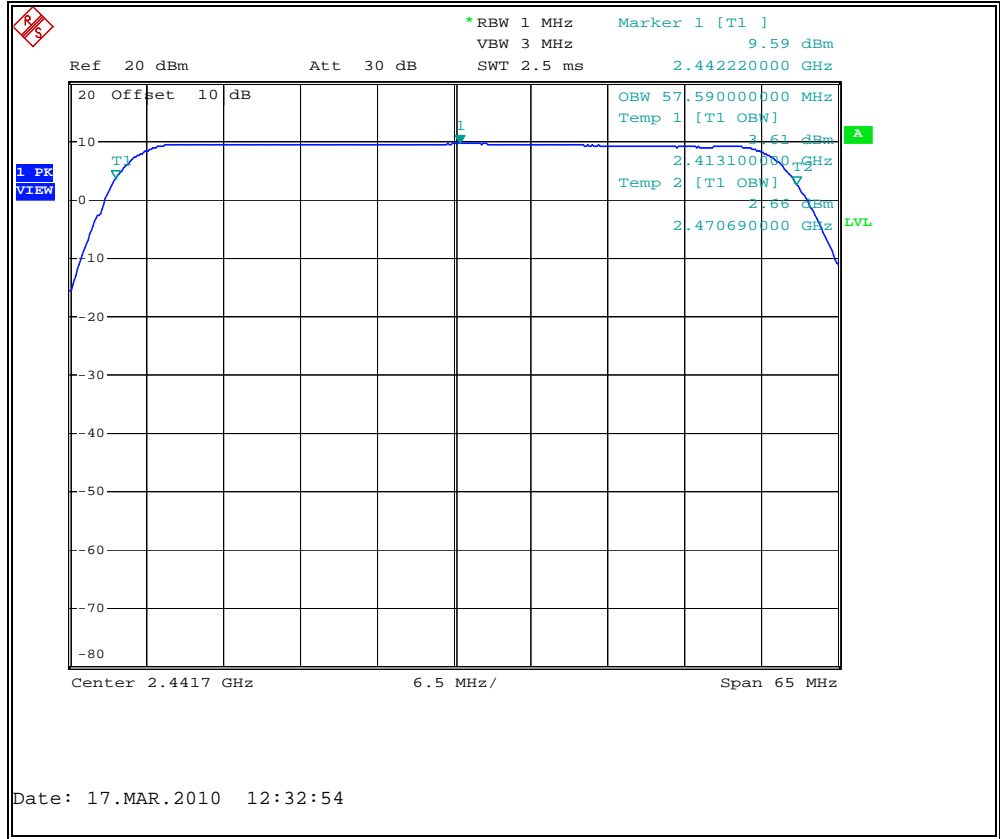

Figure 7.4.2-2: 99% Bandwidth Plot

7.5 Peak Output Power Requirement - FCC Section 15.247(b)(3) IC: RSS-210 A8.4(4)

7.5.1 Measurement Procedure

The Peak Output Power was measured in accordance with the FCC KDB Publication No. 558074 “Guidance on Measurements for Digital Transmission Systems (47 CFR 15.247)” Power Option 1. The RF output of the equipment under test was directly connected to the input of the power meter. The insertion loss for all cables and attenuators was included as an offset value.

Data was collected with the EUT operating at maximum power.

7.5.2 Measurement Results

Results are shown below in Table 7.5.2-1.

Table 7.5.2-1: Peak Output Power

Frequency (MHz)	Output Power (dBm)
2441.7	17.65

7.6 Spurious Emissions - FCC 15.247d IC:RSS-210 2.6, A8.5

7.6.1 RF Conducted Spurious Emissions

7.6.1.1 Measurement Procedure

The RF Conducted Spurious Emissions were measured in accordance with the FCC KDB Publication No. 558074 “Guidance on Measurements for Digital Transmission Systems (47 CFR 15.247)”. The RF output of the equipment under test was directly connected to the input of the Spectrum Analyzer. The EUT was investigated for conducted spurious emissions from 30MHz to 25GHz, 10 times the highest fundamental frequency. For each measurement, the spectrum analyzer’s RBW was set to 100 kHz and the VBW was set to 300 kHz. The peak detector and Max Hold function of the analyzer were utilized.

7.6.1.2 Measurement Results

In a 100 kHz bandwidth, the radio frequency power that was produced by the EUT emissions is at least 20 dB below that in the 100 kHz bandwidth within the band that contains the highest level of desired power. RF Conducted Emissions are displayed in Figures 7.6.2.2-1 through 7.6.2.2-4.

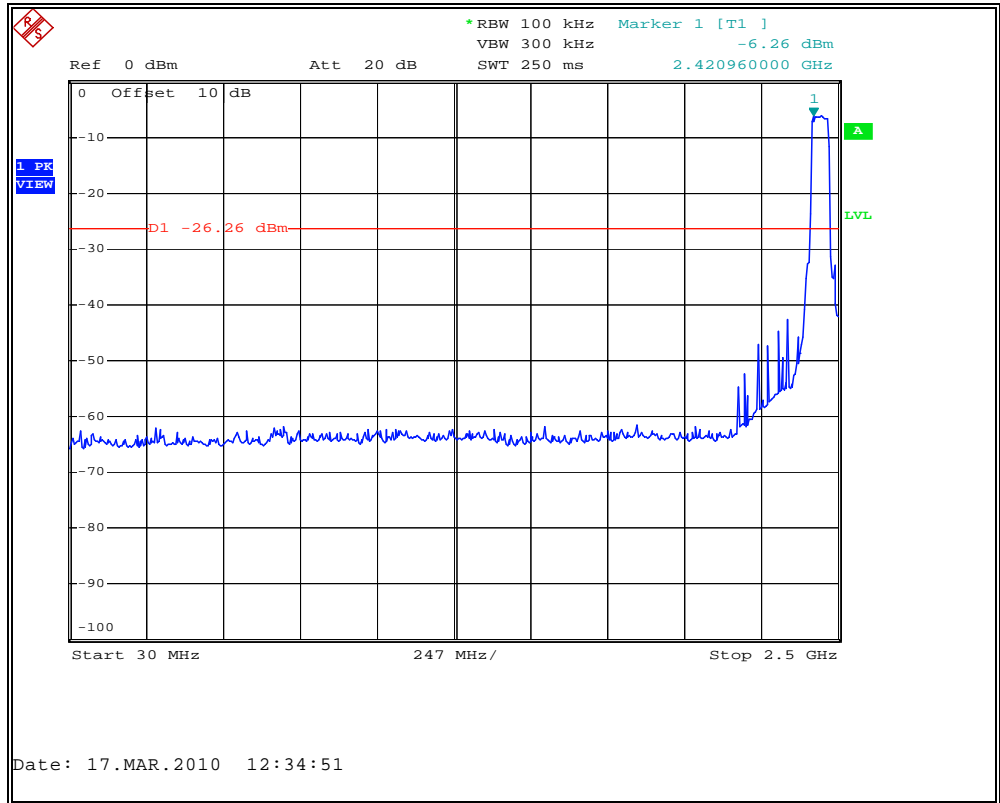

Figure 7.6.2.2-1: 30 MHz – 2.5 GHz

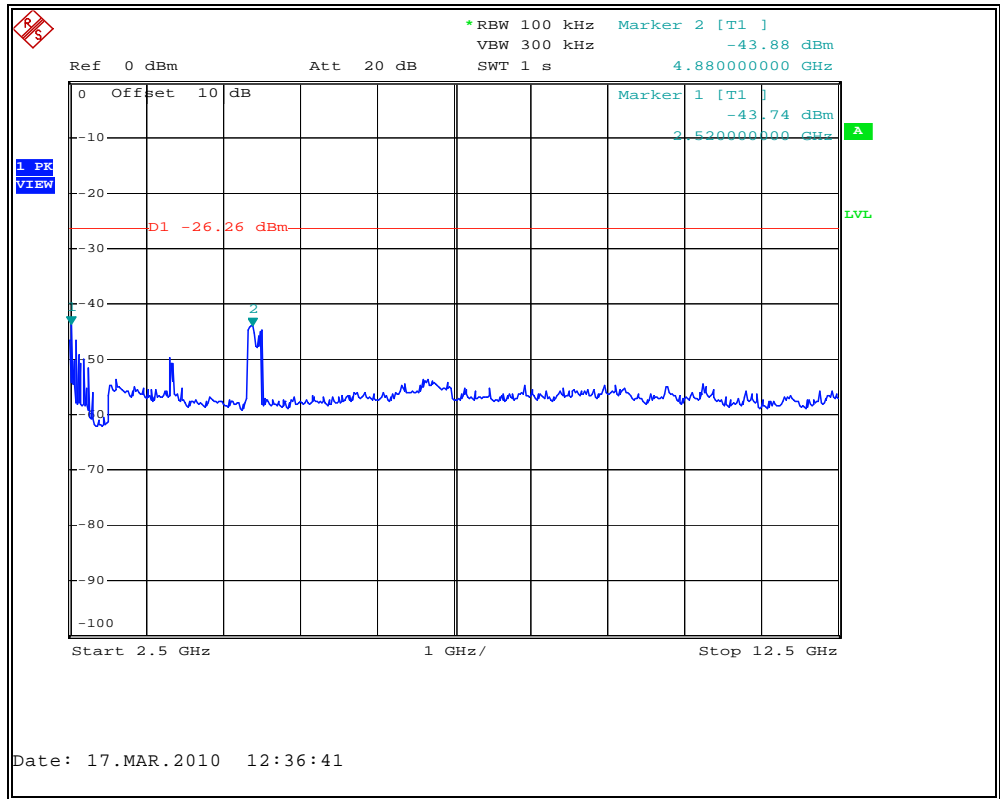

Figure 7.6.2.2-2: 2.5 GHz – 12.5 GHz

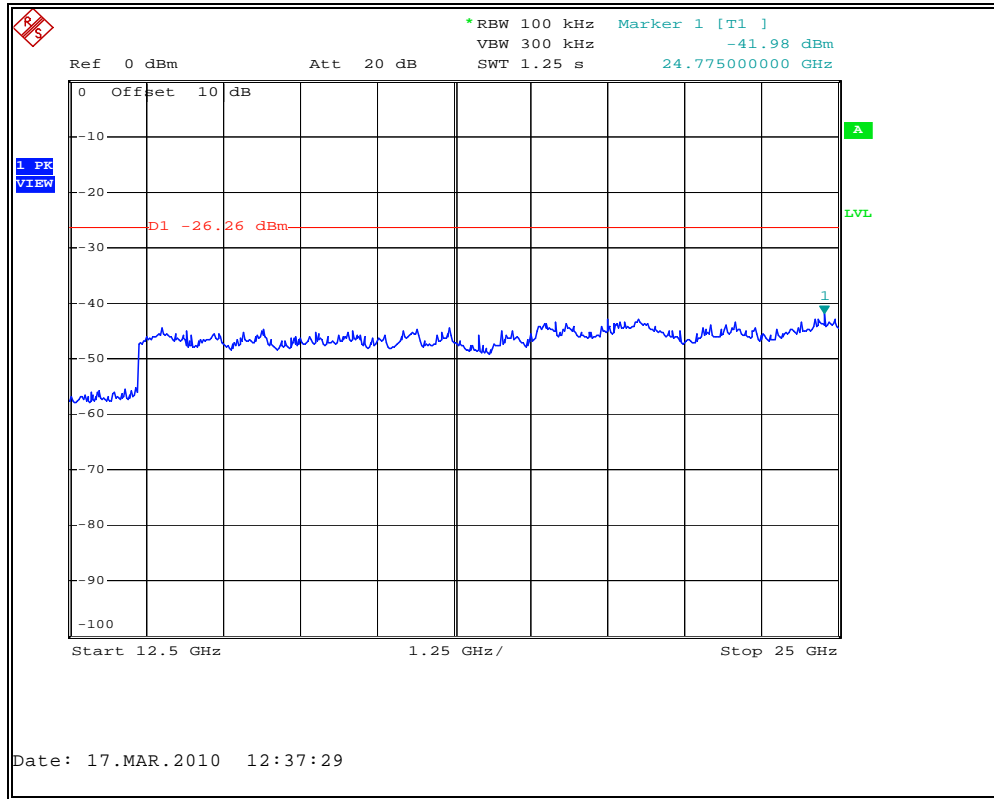

Figure 7.6.2.2-3: 12.5 GHz – 25 GHz

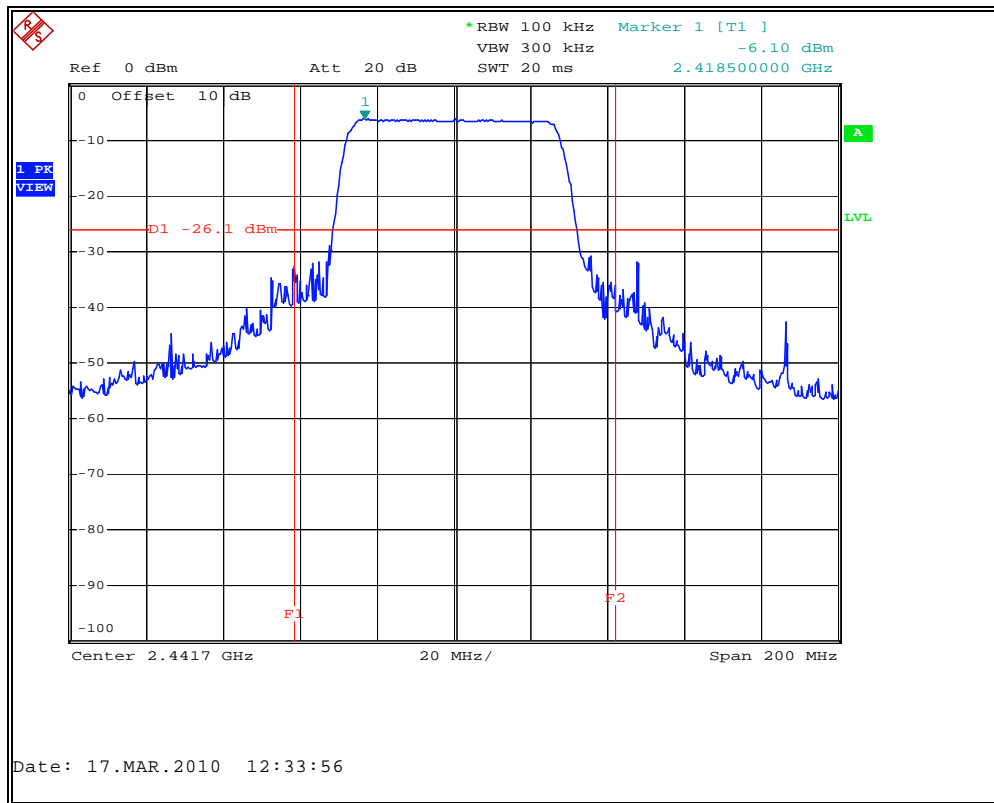

Figure 7.6.2.2-4: Band-edge (Conducted)

7.6.2 Radiated Spurious Emissions (Restricted Bands) - FCC Sec. 15.205 IC: RSS-210 2.6

7.6.2.1 Measurement Procedure

Radiated emissions tests were made over the frequency range of 30MHz to 25GHz, 10 times the highest fundamental frequency.

The EUT was rotated through 360° and the receive antenna height was varied from 1m to 4m so that the maximum radiated emissions level would be detected. For frequencies below 1000MHz, quasi-peak measurements were made using a resolution bandwidth RBW of 120 kHz and a video bandwidth VBW of 300 kHz. For frequencies above 1000MHz, peak and average measurements were made with RBW and VBW of 1 MHz and 3 MHz respectively. The average emissions were further corrected by applying the duty cycle correction of the EUT for comparison to the average limit.

Each emission found to be in a restricted band as defined by section 15.205 was compared to the radiated emission limits as defined in section 15.209.

7.6.2.2 Duty Cycle Correction

For average radiated measurements, using an 18% duty cycle, the measured level was reduced by a factor 14.89dB. The duty cycle correction factor is determined using the formula: $20\log(18/100) = 14.89\text{dB}$.

A detailed analysis of the duty cycle timing is provided in the Theory of Operation accompanying this report.

7.6.2.3 Measurement Results

Radiated spurious emissions found in the band of 30MHz to 25GHz are reported in the table 7.6.3.2-1 below.

Table 7.6.2.3-1: Radiated Spurious Emissions Tabulated Data

Frequency (MHz)	Level (dBuV)		Antenna Polarity (H/V)	Correction Factors (dB)	Corrected Level (dBuV/m)		Limit (dBuV/m)		Margin (dB)	
	pk	Qpk/Avg			pk	Qpk/Avg	pk	Qpk/Avg	pk	Qpk/Avg
X Position (Flat)										
2489.4	69.71	63.09	H	-4.13	65.58	44.07	74.0	54.0	8.4	9.9
2489.23	71.96	65.56	V	-4.13	67.83	46.54	74.0	54.0	6.2	7.5
4883.4	60.78	47.62	H	3.48	64.26	36.20	74.0	54.0	9.7	17.8
4883.4	58.92	46.18	V	3.48	62.40	34.76	74.0	54.0	11.6	19.2
Y Position (Upright)										
2489.31	64.6	57.75	H	-4.13	60.47	38.73	74.0	54.0	13.5	15.3
2489.27	77.8	69.57	V	-4.13	73.67	50.55	74.0	54.0	0.3	3.5
4883.4	53.41	40.92	H	3.48	56.89	29.50	74.0	54.0	17.1	24.5
4883.4	62.05	49.25	V	3.48	65.53	37.83	74.0	54.0	8.5	16.2

* Note: All emissions above 4883.4 MHz were attenuated below the permissible limit.

7.6.2.4 Sample Calculation:

$$R_C = R_U + CF_T$$

Where:

CF_T = Total Correction Factor (AF+CA+AG)-DC (Average Measurements Only)

R_U = Uncorrected Reading

R_C = Corrected Level

AF = Antenna Factor

CA = Cable Attenuation

AG = Amplifier Gain

DC = Duty Cycle Correction Factor

Example Calculation: Peak

Corrected Level: $69.71 - 4.13 = 65.58\text{dBuV/m}$

Margin: $74\text{dBuV/m} - 65.58\text{dBuV/m} = 8.4\text{dB}$

Example Calculation: Average

Corrected Level: $63.09 - 4.13 - 14.89 = 44.07\text{dBuV}$

Margin: $54\text{dBuV} - 44.07\text{dBuV} = 9.9\text{dB}$

7.7 Peak Power Spectral Density- FCC Section 15.247(e) IC: RSS-210 A8.2(b)

7.7.1 Measurement Procedure

The power spectral density was measured in accordance with the FCC KDB Publication No. 558074 "Guidance on Measurements for Digital Transmission Systems (47 CFR 15.247)". The emission peaks within the pass band were located and zoomed in on. The spectrum analyzer RBW was set to 3 kHz and VBW 10 kHz. Span was adjusted to 500 kHz and the sweep time was calculated to be 170s (Span/3 kHz).

7.7.2 Measurement Results

Results are shown below in table 7.7.2-1 and figure 7.7.2-1.

Table 7.7.2-1: Peak Power Spectral Density

Frequency (MHz)	PSD Level (dBm)
2441.7	-18.05

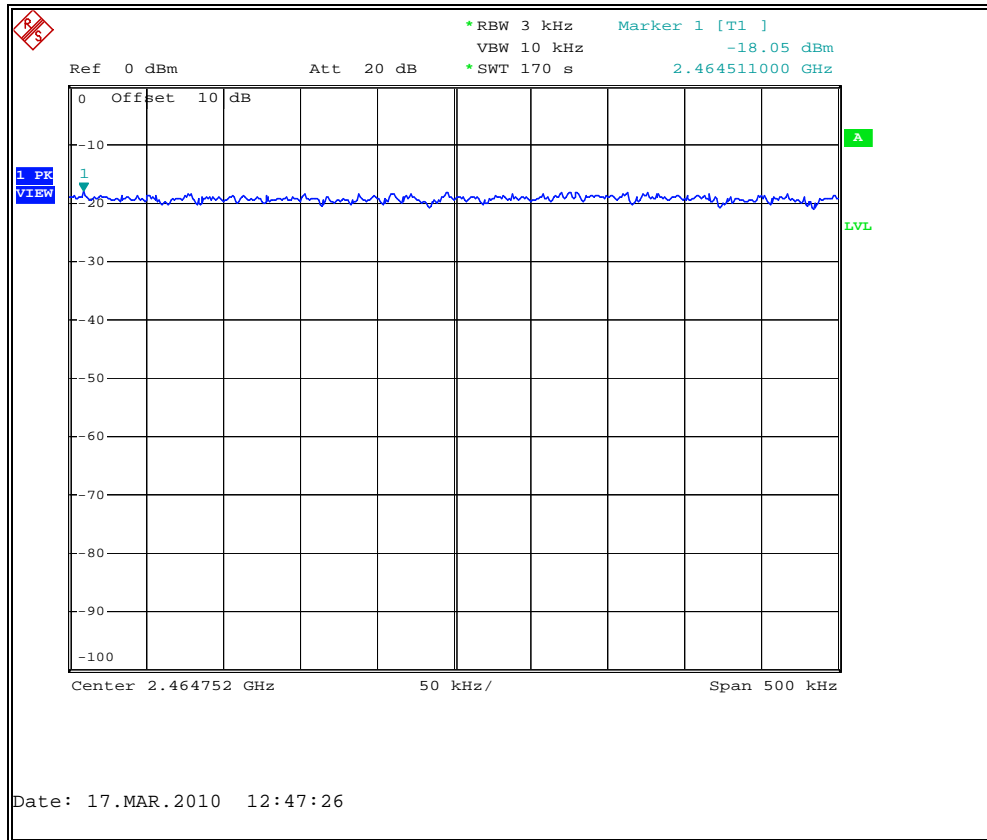

Figure 7.7.2-1: Power Spectral Density Plot

8 CONCLUSION

In the opinion of ACS, Inc. the Havahart® Custom Fence Remote model 5144G-R, manufactured by Woodstream Corporation meets the requirements of FCC Part 15 subpart C and Industry Canada's Radio Standards Specification RSS-210.

END REPORT