

# PA Series

Biofeedback and Stimulation System

# User Manual

CE<sub>0123</sub>



## About this Manual

P/N: 01.54.459103

Version 1.1

MPN: 01.54.459103011

Release Date: Mar. 2022

© Copyright EDAN INSTRUMENTS, INC. 2022. All rights reserved.

## Statement

This manual will help you understand the operation and maintenance of the product better. It is reminded that the product shall be used strictly complying with this manual. User's operation failing to comply with this manual may result in malfunction or accident for which EDAN INSTRUMENTS, INC. (hereinafter called EDAN) cannot be held liable.

EDAN owns the copyrights of this manual. Without prior written consent of EDAN, any materials contained in this manual shall not be photocopied, reproduced or translated into other languages.

Materials protected by the copyright law, including but not limited to confidential information such as technical information and patent information are contained in this manual, the user shall not disclose such information to any irrelevant third party.

The user shall understand that nothing in this manual grants him, expressly or implicitly, any right or license to use any of the intellectual properties of EDAN.

EDAN holds the rights to modify, update, and ultimately explain this manual.

## Responsibility of the Manufacturer

EDAN only considers itself responsible for any effect on safety, reliability and performance of the equipment if:

Assembly operations, extensions, re-adjustments, modifications or repairs are carried out by persons authorized by EDAN, and

The electrical installation of the relevant room complies with national standards, and

The instrument is used in accordance with the instructions for use.

## Product Information

**Product Name:** Biofeedback and Stimulation System

**Model:** PA4, PA4 Plus, PA4 Pro, PA36, PA35, PA38, PA39, PA40

## Terms Used in this Manual

This guide is designed to give key concepts on safety precautions.

### WARNING

**AWARNING** label advises against certain actions or situations that could result in

personal injury or death.

**CAUTION**

A **CAUTION** label advises against actions or situations that could damage equipment, produce inaccurate data, or invalidate a procedure.

**NOTE**

A **NOTE** provides useful information regarding a function or a procedure.

---

**Table of Content**

<b>Chapter 1 Safety Guidance .....</b>	<b>3</b>
1.1 Intended Use/Indications for Use .....	3
1.2 Contraindications.....	3
1.3 Safety Precautions .....	3
1.4 Definitions and Symbols .....	11
<b>Chapter 2 Introduction .....</b>	<b>14</b>
2.1 <b>Main Unit</b> .....	15
2.1.1 Indicators.....	16
2.2 <b>Accessories</b> .....	16
2.2.1 Sensor Cable.....	17
2.2.2 Vagina Sensor .....	17
2.2.3 Rectum Sensor.....	18
2.2.4 Stress Probe .....	18
2.3 <b>Rechargeable lithium battery</b> .....	19
2.3.1 Replacing the Battery .....	19
2.3.2 Battery Status on the Main Screen .....	19
2.3.3 Charging the Battery .....	20
2.3.4 Maintaining the Battery .....	20
2.3.5 Storing the Battery .....	20
2.3.6 Checking Battery Performance.....	20
2.3.7 Recycling the Battery .....	21
<b>Chapter 3 Installation.....</b>	<b>22</b>
3.1 Opening and Checking the Package .....	22
3.2 Connecting AC Power .....	22
3.3 Switching on the System .....	22
3.4 Switching off the System.....	22
<b>Chapter 4 Basic Functions and Operations.....</b>	<b>23</b>
4.1 Connecting to Patient .....	23
4.2 Adjusting Current .....	23
4.3 Sensor/Probe/Electrodes Off .....	24
<b>Chapter 5 *Software Operation .....</b>	<b>25</b>
5.1 Starting up the Software .....	25
5.2 Main Interface .....	25
5.3 Patient Information.....	25
5.3.1 Patient Information Interface.....	25
5.3.2 Adding Patient .....	26
5.3.3 Searching Patient.....	27
5.3.4 Patient Record.....	27
5.4 Assessment .....	27
5.4.1 Free Training.....	28
5.4.2 Quick Screening.....	29
5.4.3 EMG Screening.....	30
5.4.4 EMG Assessment .....	30
5.4.5 Pressure Assessment.....	30
5.4.6 Lumbago Assessment.....	31
5.4.7 Sexual Function Assessment.....	31
5.4.8 Cough Reflex Assessment .....	32
5.4.9 Screening Assessment Report.....	32
5.5 Treatment.....	32
5.5.1 Defined Protocol.....	33
5.5.1.1 Intelligent Protocol .....	33
5.5.1.2 Fixed Protocol.....	34
5.5.1.3 MVC Detection.....	35
5.5.1.4 Protocol Treatment .....	36
5.5.2 Custom Treatment .....	41
5.6 Postpartum Rehabilitation .....	41

5.7 Database .....	43
5.7.1 Patient Information.....	44
5.7.2 Patient Record.....	44
5.8 Settings .....	44
5.8.1 User Settings .....	44
5.8.1.1 Hospital Name .....	44
5.8.1.2 Application.....	44
5.8.1.3 Adding User .....	44
5.8.1.4 Modifying User .....	45
5.8.1.5 Login Settings.....	45
5.8.2 General Settings .....	45
5.8.2.1 Interface Settings .....	45
5.8.2.2 Channel Settings.....	46
5.8.2.3 Other Settings.....	46
5.8.2.4 Restoring Factory Configurations.....	46
5.8.3 Printing Settings.....	46
5.8.4 Protocol Management .....	47
5.8.5 Database.....	48
5.8.5.1 Backing Up Database.....	48
5.8.5.2 Rebuilding Database .....	48
5.8.5.3 Updating System.....	48
5.8.6 Communication Settings.....	49
5.8.6.1 Wifi Settings.....	49
5.8.6.2 BT Settings .....	49
5.8.6.3 NFC Settings .....	49
<b>Chapter 6 Maintenance and Cleaning .....</b>	<b>50</b>
6.1 Maintenance .....	50
6.1.1 Inspection.....	50
6.1.2 Daily Maintenance.....	50
6.2 Care and Cleaning .....	51
6.2.1 Safety Instructions .....	51
6.2.2 General Points.....	51
6.2.3 Cleaning.....	52
6.2.4 Disinfecting .....	53
6.2.5 After Reprocessing.....	54
6.2.6 Storage and Transport.....	55
<b>Chapter 7 Warranty and Service .....</b>	<b>56</b>
7.1 Warranty .....	56
7.2 Contact information.....	56
<b>Appendix 1 Product Specifications.....</b>	<b>57</b>
<b>A1.1 Environmental Specifications.....</b>	<b>57</b>
<b>A1.2 Physical Specifications .....</b>	<b>57</b>
<b>A1.3 Performance Specifications.....</b>	<b>58</b>
<b>A1.4 Rechargeable Lithium-ion Battery.....</b>	<b>59</b>
<b>Appendix 2 Troubleshooting.....</b>	<b>60</b>
A2.1 Trouble with Starting Up .....	60
A2.2 Trouble with Identifying U Disk or Other USB Device .....	60
A2.4 Unstable EMG Signal.....	60
A2.5 Falling Off Issue .....	61
<b>Appendix 3 EMC Information.....</b>	<b>63</b>
A3.1 Electromagnetic Emissions.....	63
A3.2 Electromagnetic Immunity .....	64
A3.3 Electromagnetic Immunity .....	65
A3.4 Recommended Separation Distances.....	68
<b>Appendix 4 Ordering Information .....</b>	<b>70</b>

# Chapter 1 Safety Guidance

---

---

## **CAUTION**

**Federal (U.S.) Law restricts this device to sale by or on the order of a physician.**

---

---

### **NOTE:**

- 1 To ensure proper running of the device and safety of the operator and patient, read through this chapter before using the device.**
- 2 This user manual is written to cover the maximum configuration. Therefore, your model may not have some of the parameters and functions described, depending on what you have ordered.**

## 1.1 Intended Use/Indications for Use

The Biofeedback and Stimulation System collects, analyzes patients' surface electromyography or stress signal and performs biofeedback, treating muscular dysfunction, promoting blood circulation and providing analgesia and tissue metabolism by electrical stimulation and EMG-electrical stimulation.

## 1.2 Contraindications

- Gestation
- Lochia not finished after delivery or menstrual period
- Patients who wear cardiac pacemakers
- Malignant tumor
- Surgical scar rupture
- Nervous system disease
- Other diseases that doctor considers not applicable

## 1.3 Safety Precautions

WARNING and CAUTION messages must be observed. To avoid the possibility of injury, observe the following precautions during the operation of the device.

---

---

## **WARNING**

- 1 The device is intended to be used only by trained and qualified personnel in hospitals, clinics and private medical institutions.**
  - 2 This device is provided for the use of professionally trained and qualified physicians, or under guidance of these personnel. Familiarize yourself with the contents of this user manual before operation.**
  - 3 Do not use the device in the presence of flammable anesthetics due to explosion risk.**
- 
- 

## **WARNING**

- 4 **SHOCK HAZARD**—Do not attempt to connect or disconnect a power cord with wet hands. Make sure that your hands are clean and dry before touching a power cord.
  - 5 **SHOCK HAZARD** - The power receptacle must be a three-wire grounded outlet. Never try to adapt the three-prong plug to fit a two-slot outlet. A hospital grade outlet is required. If the outlet has only two slots, make sure that it is replaced with a three-slot grounded outlet before attempting to operate the system.
  - 6 **Electromagnetic Interference** – Ensure that the environment in which the device is installed is not subject to any source of strong electromagnetic emissions, such as CT, radio transmitters, mobile phone base stations, etc.
  - 7 **Electromagnetic Interference** – Do not use mobile phones nearby the device, otherwise it may interfere with device operation.
  - 8 Do not touch the signal input or output connector and the patient simultaneously.
  - 9 Accessory equipment connected to the device must be certified according to the respective IEC/EN standards (e.g. IEC/EN 60950 for data processing equipment and IEC/EN 60601-1 for medical equipment). Furthermore all configurations shall comply with the valid version of the system standard IEC/EN 60601-1. If any question, please consult our technical service department or your local distributor.
  - 10 Connecting any accessory or equipment to the device makes a medical system. In that case, additional safety measures should be taken during installation of the system, and the system shall provide:
    - a) Within the patient environment, a level of safety comparable to that provided by medical electrical equipment complying with IEC/EN 60601-1, and
    - b) Outside the patient environment, the level of safety appropriate for non-medical electrical equipment complying with other IEC or ISO safety standards.
  - 11 Do not exceed the maximum permitted load when using multiple portable socket-outlets to supply the system. You can refer to the label or silk-screen for the maximum permitted load.
  - 12 **SHOCK HAZARD** – Do not connect non-medical electrical equipment, which has been supplied as a part of the system, directly to the wall outlet when the non-medical equipment is intended to be supplied via a multiple portable socket-outlet with a separating transformer.
- 
- 

### **WARNING**

- 13 **SHOCK HAZARD** –Do not connect electrical equipment, which has not been supplied as a part of the system, to the multiple portable socket-outlet

supplying the system.

- 14 Multiple portable socket-outlets shall not be placed on the floor. An additional multiple portable socket-outlet or extension cord shall not be connected to the system.
  - 15 Only accessories supplied by the manufacturer can be used.
  - 16 Do not connect any equipment or accessories that are not approved by the manufacturer or that are not IEC/EN 60601-1 approved to the device. The operation or use of non-approved equipment or accessories with the device is not tested or supported, and device operation and safety are not guaranteed.
  - 17 Using accessories other than those specified by the manufacturer may result in increased electromagnetic emissions or decreased electromagnetic immunity of the device.
  - 18 Make sure that all the components and accessories are connected correctly and checked before powering on.
  - 19 No part of the device is intended to be maintained by the user. Unauthorized servicemen shall not open the enclosure. Otherwise, safety hazards may happen.
  - 20 The mains plug is used as isolation means from supply mains. Position the device in a location where the operator can easily access the disconnection device.
  - 21 The device should not be used adjacent to or stacked with other equipment and that if adjacent or stacked use is necessary, the device should be observed to verify normal operation in the configuration in which it will be used.
  - 22 The medical electrical equipment needs to be installed and put into service according to the EMC Information provided in this user manual.
  - 23 The device should be operated under certain circumstances, such as power supply, humidity and altitude.
  - 24 Portable and mobile RF communications equipment can affect medical electrical equipment, refer to section A3.4 Recommended Separation Distances.
  - 25 Do not service or maintain the device or any accessory which is in use with a patient.
- 
- 

### **WARNING**

- 26 The assembly and modifications of the device during actual service life shall be evaluated based on the requirements of IEC60601-1.
- 27 Only electrodes recommended by the manufacturer should be used in case of skin reactions, burns or other hazards caused by excessive current densities.



- 28 Please do not plug a random USB flash disk into the device, please use a specialized USB flash disk without virus.
  - 29 Do not apply the device simultaneously with other PATIENT-connected equipment, such as, a cardiac pacemaker or other electrical stimulators, on the same patient.
  - 30 Operation in close proximity (e.g.1m) to a shortwave or microwave may produce instability in the stimulation output.
  - 31 Simultaneous connection of a patient to a high frequency surgical equipment may result in burns at the site of the stimulator electrodes and cause possible damage to the stimulator.
  - 32 Application of electrodes near the thorax/heart may increase the risk of cardiac fibrillation.
  - 33 A patient with an implanted electronic device (for example a cardiac pacemaker) should not be subjected to stimulation.
  - 34 A hazard could exist if excessive current densities are present.
  - 35 This device is capable of generating current densities exceeding 2mA r.m.s./cm<sup>2</sup> that may require special attention of the operator.
  - 36 Use of any equipment in a biofeedback or stimulation context should be immediately terminated upon any sign of treatment-related distress or discomfort.
  - 37 The electrodes should not be placed crossing over the heart.
  - 38 The operator is responsible for ensuring the safety of any device controlled or triggered by the device or software. The software must be configured or device be connected in such a way to acquire reliable data. Processing or control functions can trigger patient feedback, but the stimulus shouldn't be too much.
  - 39 Stimulations should not be applied across or through the head, directly on the eyes, covering the mouth, on the front of the neck, (especially the carotid sinus).
  - 40 The device should not be applied around swollen, infected inflammation or tetter, phlebophlogosis, thrombophlebitis.
  - 41 The device should not be applied during pregnancy.
- 
- 

### **WARNING**

- 42 Caution should be used for patients with suspected or diagnosed heart problems.
- 43 Caution should be used for patients with suspected or diagnosed epilepsy.
- 44 Some patients may have skin allergy due to electrical stimulation, please reduce the current intensity or change the location of electrodes.

- 45 **Do not use with diminished mental capacity or physical competence limiting the use of the device.**
- 46 **Please do not apply stimulation in below situations:**
  - a. after bleeding or fracture;
  - b. muscle contraction during surgery;
  - c. during period or pregnancy;
  - d. Skin numbness.
- 47 **Electrode placement and stimulation settings should be operated by qualified personnel.**
- 48 **Avoid accidental contact between connected but unused applied parts and other conductive parts including those connected to protective earth.**
- 49 **If damage is evident of the unit or accessories, discontinue use and contact your supplier for further information on repair.**
- 50 **Please protect the sensitive information of patients.**
- 51 **Please destroy sensitive information in free or waste devices, for example, delete the database in Android settings.**
- 52 **The current waveform outputted by the treatment system has no direct component. The impulse frequency, impulse width and amplitude peak are not influenced by load impedance.**
- 53 **The allowable maximum output of stimulation sensor is 40mA r.m.s., excessive current may cause skin discomfort.**
- 54 **If any serious incident that has occurred in relation to the device, user and/or patient should report to the manufacturer and the competent authority of the Member State in which the user and/or patient is established.**

**For using the Battery:**

- 55 **Before using the rechargeable lithium-ion battery (hereinafter called lithium battery), be sure to read the user manual and safety precautions thoroughly.**
- 56 **The lithium battery can only be used for this device.**
- 57 **The lithium battery can only be charged in this device.**
- 58 **Do not reverse the lithium battery polarity.**

---

---

**WARNING**

- 59 **Do not connect the positive (+) and negative (-) terminals with metal objects such as lead wire, which can result in short circuits.**
- 60 **The cycle life of the lithium battery is 500 times. The service life of the lithium battery may shorten if it is used inappropriately. It is recommended to replace the lithium battery after 500 charge-discharge cycles, or it may cause safety risks such as heat and liquid leakage, and risks such as failure or decline of performance.**

- 61 Do not heat or throw the lithium battery into a fire.
- 62 Do not immerse, throw or wet the lithium battery in water, beverages or other liquids.
- 63 Do not use or leave lithium battery at high temperature (charging >45 °C, discharging >60 °C, such as in direct sunlight or in a very hot car), otherwise it may cause overheat, fire, malfunction to the lithium battery, shorten the service life of the lithium battery, or damage the lithium battery.
- 64 Do not place the lithium battery near microwave equipment or other cooking devices. If the lithium battery is heated or subjected to strong electromagnetic radiation, liquid leakage, heat, smoke, fire, etc. may occur.
- 65 Do not hit it with a hammer, step on it or throw or drop it to cause strong shock.
- 66 Do not weld the lithium battery directly.
- 67 Do not use a lithium battery of other specifications.
- 68 Do not use a lithium battery with serious scratch or deformation.
- 69 Keep lithium batteries out of the reach of children.
- 70 Power off the device, remove and stop using the lithium battery if abnormal heat, odor, discoloration, deformation or abnormal condition is detected during use, charge, or storage, or it may cause safety accidents such as heat, smoke, and fire.
- 71 Do not touch a leaking lithium battery. If the liquid leaked from the lithium battery gets into eyes, do not rub the eyes. Wash them well with clean water and see a doctor immediately.
- 72 When the device is running on lithium battery power, do not replace the lithium battery during operation of the device.
- 73 High internal temperature may also cause the lithium battery unable to be charged. Keep the device at room temperature and move it away from heat sources or out of direct sunlight. The lithium battery will resume charging when the temperature is within range again.

---

---

#### **WARNING**

- 74 Lithium batteries should be charged, used and stored in places far away from static electricity.
- 75 Lithium batteries are hazardous waste. Do NOT dispose them together with house-hold garbage. At the end of their life hand the batteries over to the applicable collection points for the recycling of waste batteries. For more detailed information about recycling of this product or lithium batteries, please contact your local Civic Office, or the shop where you purchased the product.

---

---

#### **CAUTION**

- 1 The device is designed for continuous operation. Do not water the device.

- 2 Keep the environment clean. Make the device far from corrosive medicine, dust area, high-temperature and humid environment. Avoid vibration. Do not move it with the power cord connected.**
  - 3 Do not operate the device if it is damp or wet because of condensation or spills. Avoid using the device immediately after moving it from a cold environment to a warm, humid location.**
  - 4 Keep the workstation at least 5cm away from the wall for the sake of heat and air dissipation.**
  - 5 Do not sterilize the device or any accessory with autoclave or gas.**
  - 6 This system is medical equipment. Unauthorized third party software is forbidden to be installed on it.**
  - 7 Do not delete the system files. That's to avoid improper system running.**
  - 8 Do not change the time of the system unless necessary, otherwise the appointment data may be lost.**
  - 9 The waste adhesive electrodes should be treated as medical waste.**
  - 10 The waste vagina sensor and rectum sensor should be treated as medical waste.**
  - 11 The device and accessories are to be disposed of according to local regulations after their useful lives. Alternatively, they can be returned to the dealer or the manufacturer for recycling or proper disposal.**
  - 12 Please install protection software and update the virus database when internet is connected.**
  - 13 When turning on Bluetooth and connecting to a Bluetooth audio device, please do not connect to unfamiliar devices.**
  - 14 Please do not root the system.**
  - 15 Please enable the firewall and add the software installed in the device to the whitelist.**
  - 16 Please do not install other software after the device leaves the factory.**
  - 17 For secure deployment, please use wired network in case of unstable bandwidth and network led by Wi-Fi or unstable network device, and cause data transmission problem.**
- 
-

## FCC Statement

This device complies with Part 15 of the FCC rules. Operation is subject to the following two conditions: 1) this device may not cause harmful interference, and 2) this device must accept any interference received, including interference that may cause undesired operation.

Note: This equipment has been tested and found to comply with the limits for a Class B digital device, pursuant to part 15 of the FCC Rules. These limits are designed to provide reasonable protection against harmful interference in a residential installation. This equipment generates uses and can radiate radio frequency energy and, if not installed and used in accordance with the instructions, may cause harmful interference to radio communications. However, there is no guarantee that interference will not occur in particular installation. If this equipment does cause harmful interference to radio or television reception, which can be determined by turning the equipment off and on, the user is encouraged to try to correct the interference by one or more of the following measures:

- Reorient or relocate the receiving antenna.
- Increase the separation between the equipment and receiver.
- Connect the equipment into an outlet on a circuit different from that to which the receiver is connected.
- Consult the dealer or an experienced radio/TV technician for help.











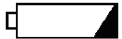

Changes or modifications not expressly approved by the party responsible for compliance could void the user's authority to operate the equipment.





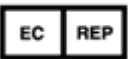







### FCC Radiation Exposure Statement

This device complies with FCC RF radiation exposure limits set forth for an uncontrolled environment. This transmitter must not be co-located or operating in conjunction with any other antenna or transmitter.

This device must operate with a minimum distance of 20 cm between the radiator and user body.

## 1.4 Definitions and Symbols

No.	Symbol	Description
1		Alternating Current
2		Battery check
3		Direct Current
5		On/Off switch
6		Caution
7		Consult instructions for use
8	P/N	Part Number
9		SERIAL NUMBER
10		General symbol for recovery/recyclable
11		Date of manufacture
12		AUTHORISED REPRESENTATIVE IN THE EUROPEAN COMMUNITY
13		MANUFACTURER
14		CE marking
15		Disposal method

16		Refer to instruction manual/booklet (Background: Blue; Symbol: White)
17		No pushing (Background: White; Symbol: Black; Outline: Red)
18		This way up
19		Fragile, handle with care
20		Keep away from rain
21		Stacking limit by number
23		Do not roll
24		Non-ionizing electromagnetic radiation
25		Adjust Intensity
26		Type BF applied part
27	CH1-CH4	Channel Interface
28	CH-P	Stress Probe Interface
29		Do not reuse
30		Medical device
31		Unique Device Identifier

**NOTE:**

**1 The user manual is printed in black and white.**



## Chapter 2 Introduction

### NOTE:

The user manual introduces PA4 as an example. You may not have all of these features, depending on the configuration purchased. The pictures and interfaces provided in this manual are for reference only.

This device is used with an all-in-one computer and a trolley. For details of the trolley, please refer to the PA trolley installation guide.

The overall appearance figure is as below:

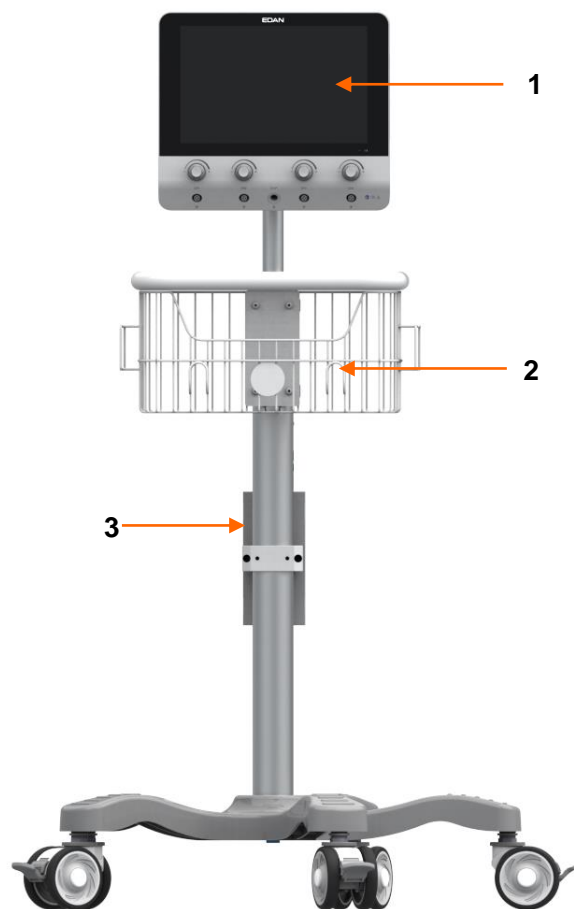

Figure 2-1 Appearance

1	Main Unit	2	Storage basket	3	Trolley
---	-----------	---	----------------	---	---------

### **CAUTION**

The maximum load is 2.5 kg for the storage basket. Do not put objects exceeding the load limit on them.

## 2.1 Main Unit



Figure 2-2 Front View

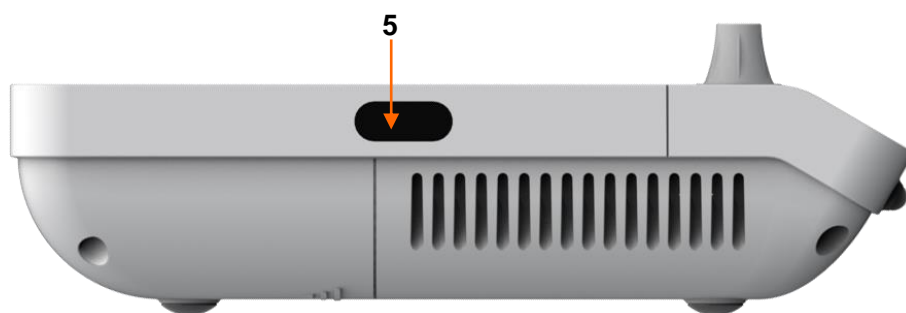

Figure 2-1 Left Side

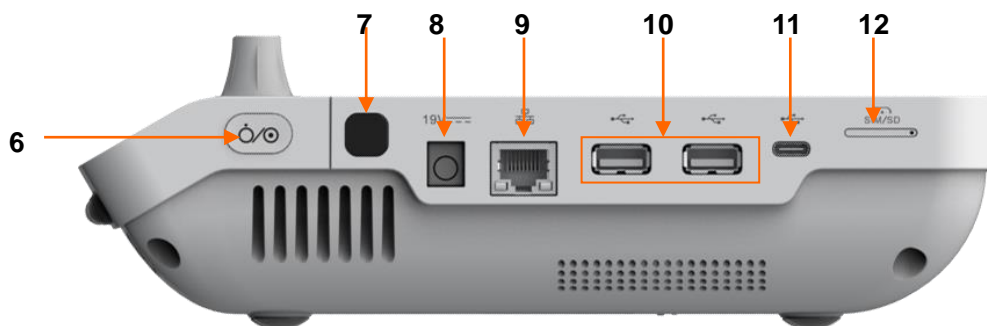

Figure 2-2 Right Side

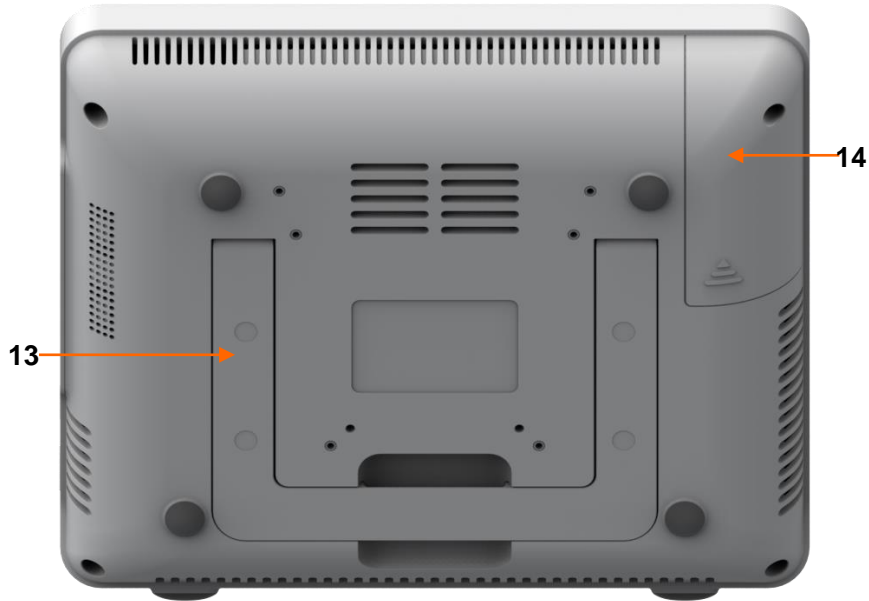



Figure 2-3 Bottom

1	Touchscreen	2	AC indicator and charge indicator	3	Control knobs	4	Channel interface
5	Scanner	6	Power switch	7	Finger Unlocking	8	Power interface
9	Network Interface	10	USB interface	11	Type-C interface	12	SD card slot
13	Supporting bracket	14	Battery compartment				

### 2.1.1 Indicators

	Charge Indicator	On	The battery is being charged
		Off	No battery or the battery is fully charged
	AC Indicator	On	The main unit is connected to AC power supply.
		Off	The main unit is not connected to AC power supply.

## 2.2 Accessories

### Accessory List

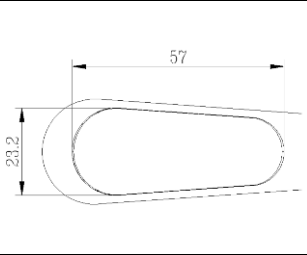
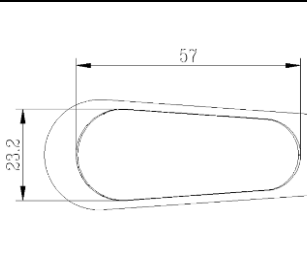
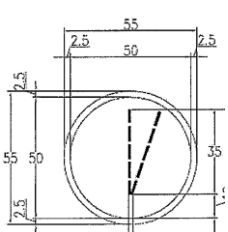
Name	Model	Specification	Area	Actual Area	Figure	Impedance
Pelvic Floor Intracavity Sensor	SV2	Intracavity sensor, which is applied in the vagina and it is reusable	no less than 8cm <sup>2</sup>	12.34 cm <sup>2</sup> length*width:57mm*23.2mm Error : ±5%		
Pelvic Floor Intracavity Sensor	SV1	Intracavity sensor, which is applied in the vagina and it is disposable.	no less than 8cm <sup>2</sup>	12.34 cm <sup>2</sup> Irregular length*width : 57mm*23.2 mm Error : ±5%		
Adhesive Electrodes	SK1	Adhesive electrodes, which are applied on the skin and they are disposable	no less than 15cm <sup>2</sup>	19.625cm <sup>2</sup> Diameter:5cm Error: ±5%		<500Ω ±5%
Vagina Stress Probe	PV	Intracavity stress probe, which is applied in the vagina and it is reusable.	/	/	/	/

## 2.2.1 Sensor Cable

The sensor cable connects the sensor with the host to conduct signals.

## 2.2.2 Vagina Sensor

There are two types of vagina sensors, the reusable one and the disposable one.

The vagina sensor is used to conduct electrical signals between the pelvic floor muscles and the host, including pelvic floor Surface Electromyography signal (SEMG) and electrical stimulation signals.

Using methods:

1. Open the package and connect the vagina sensor to the host with the sensor cable.
2. Insert the vagina sensor into the vagina till the end of the sensor. Select an assessment protocol or treatment plan and start it.
3. After the assessment or treatment, disconnect the sensor from the cable. For disposable vagina sensor, pull it out and dispose of it as medical waste. For

reusable vagina sensor, pull it out and store it after cleaning and disinfection.

Attentions:

1. The reusable vagina sensor is restricted to a single patient, do not cross use it.
2. The disposable vagina sensor is for single use only, do not reuse it.
3. Please do not plug or unplug the sensor during the operation of the host.
4. The device that the sensor connects to has to conform to IEC 60601-1:2005/A1:2012.
5. The sensor should be placed by qualified personnel. The entire sensor surface should be in good contact with the vagina when placing the sensor.
6. The sensor should not contact with wounds or scars during the treatment.

### 2.2.3 Rectum Sensor

The rectum sensor is reusable.

The rectum sensor is used to conduct electrical signals between the pelvic floor muscles and the host, including pelvic floor Surface electromyography signal (SEMG) and electrical stimulation signals.

Using methods:

1. Open the package and connect the rectum sensor to the host with the sensor cable.
2. Insert the rectum sensor into the rectum till the end of the sensor. Select an assessment protocol or treatment plan and start it.
3. After the assessment or treatment, disconnect the sensor from the host, pull out the sensor and keep it after cleaning and disinfection.

Attentions:

1. The sensor is restricted to a single patient, do not cross use it.
2. Please do not plug or unplug the sensor during the operation of the host.
3. The device that the sensor connects to has to conform to IEC 60601-1:2005/A1:2012.
4. The sensor should be placed by qualified personnel. The entire sensor surface should be in good contact with the rectum when placing the sensor.
5. The sensor should not contact with wounds or scars during the treatment.

### 2.2.4 Stress Probe

The stress probe is used to measure the contraction strength change of the pelvic floor muscles.

Using methods:

1. Open the package and connect the stress probe to the host with the sensor cable.
2. Cover the stress probe with a condom and insert the stress probe into the vagina till the groove of the silicon tail, i.e. the location indicated by the red line in below picture. Select an assessment protocol or treatment plan and start it.
3. After the assessment or treatment, disconnect the probe from the host, pull out the probe, and take down the condom and dispose of it. Store the probe after cleaning and disinfection.

Attentions:

1. Please do not plug or unplug the probe during the operation of the host.
2. The device that the probe connects to has to conform to IEC 60601-1:2005/A1:2012.

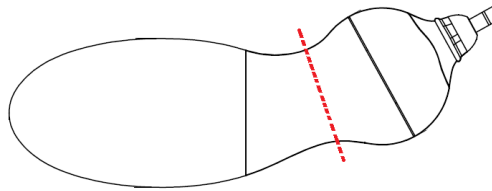

Figure 2-4 Stress Probe

## 2.3 Rechargeable lithium battery

### 2.3.1 Replacing the Battery

This device is equipped with a rechargeable lithium battery, which can work for 8 hours in a typical working mode when the battery is fully charged.

How to install the battery:

1. Find the battery compartment and unscrew it, and remove the compartment cover.
2. Push aside the battery lock, and place the battery in the compartment.
3. Close the battery compartment and fix it with the screw.

---

#### **WARNING**

**The Battery can only be replaced by serviceman authorized by EDAN. Incorrect replacement would result in an unacceptable risk.**

---

### 2.3.2 Battery Status on the Main Screen

The device is equipped with a built-in rechargeable battery. When connected to AC power, the battery will be automatically charged until it is fully charged. When the battery is being charged, there will be a charge indicator  displayed on the top right corner of the screen, the value by the battery icon represents the remaining battery capacity.

### 2.3.3 Charging the Battery

1. Load the battery into the device and connect the device to the mains power.
2. When the battery is being charged, the charge indicator lights up. When the battery is fully charged, the charge indicator is off and the battery power indicator is filled.

**NOTE:**

**EDAN recommends to charge the battery when the device is switched off so as to improve the charging efficiency and save charging time.**

### 2.3.4 Maintaining the Battery

The performance of rechargeable batteries may deteriorate over time. It is recommended to check and maintain the batteries regularly every 3 months.

1. Disconnect the patient from the device and stop all measurement.
2. Switch off the device, connect it to mains power, install the battery and fully charge it.
3. Disconnect the device from mains power, switch on the device and let the device run until there is no battery power left and the device shuts off.
4. Reconnect the device to mains power and charge the battery until it is full for use or charge to 40%~60% for storage.

**NOTE:**

- 1. Do not use the device on a patient during the battery maintenance.**
- 2. Do not interrupt the battery maintenance process.**

### 2.3.5 Storing the Battery

Remove the lithium battery and store it at a cool and dry environment if the lithium battery or the device is not used for a long time. Charge the batteries to 40%-60% for storage. Check and maintain the batteries regularly every 3 months. For more information, please refer to *Section 2.3.4*.

**NOTE:**

- 1 When storing the battery, avoid contact between the battery interface and metal objects.**
- 2 The service life of the battery will be shortened if it is stored at high temperature for a long time.**
- 3 Storing batteries in a cool place can slow down the aging process. The ideal storage temperature is 15°C.**

### 2.3.6 Checking Battery Performance

The performance of rechargeable batteries may deteriorate over time. If you suspect that

the battery may have failed, check the battery performance.

Please refer to Step 1~Step 3 in section 2.3.4, and record the running time of the battery, which reflects the battery performance. If the running time is obviously less than the specified time in the specification, the battery may have reached its service life or malfunctioned, please change the battery or contact the service personnel. If the running time meets the specification, then the battery can continue to be used normally.

### 2.3.7 Recycling the Battery

If the battery is obviously damaged or the battery is exhausted, it should be replaced and properly recycled. When disposing of used batteries, follow the corresponding regulations.



## Chapter 3 Installation

### 3.1 Opening and Checking the Package

The package is in large size and of heavy weight. Do not turn it upside-down. Visually examine the package prior to unpacking. If any signs of mishandling or damage are detected, contact the carrier to claim for damage.

Open the package and check the components according to the packing list. Inspect the components for any damage. Let the service engineer of the manufacturer assemble the system for you.

Keep the package for possible future transportation or storage.

---

---

#### **CAUTION**

---

---

**When moving the device, avoid running into door frame or other objects.**

---

---

### 3.2 Connecting AC Power

- ◆ Make sure that the AC power supply complies with the following specifications:  
Operating Voltage and Input Voltage: 100-240V  
Operating Frequency: 50 Hz /60 Hz
- ◆ Use the provided power cable. Plug one end of the power cable to the power socket of the system and the other end to a power output special for hospital usage.

### 3.3 Switching on the System

Prior to switching on the system, check if all the components are correctly connected and if all the cables are in good condition. Make sure that the system is linked to the protective earth.

If any sign of damage is detected, do not use the system. Replace the damaged parts or contact biomedical engineer in the hospital or our service engineer immediately.

To switch on the main unit, long press the power key of it. If necessary, then turn on the printer.

### 3.4 Switching off the System

When the system is not used, exit the biofeedback and stimulation system software. Long press the power key of the main unit to turn off it (If a printer is connected and used, turn off the printer).

# Chapter 4 Basic Functions and Operations

## 4.1 Connecting to Patient

Connect one end of the sensor cable to the channel interface of the main unit, and connect the other end of the sensor cable to the interface of sensor/probe/electrodes. Reference electrode should be connected when collecting EMG signals. Operate per the sensor/probe/electrodes' user manual.

Adhesive electrodes placement is shown as below.

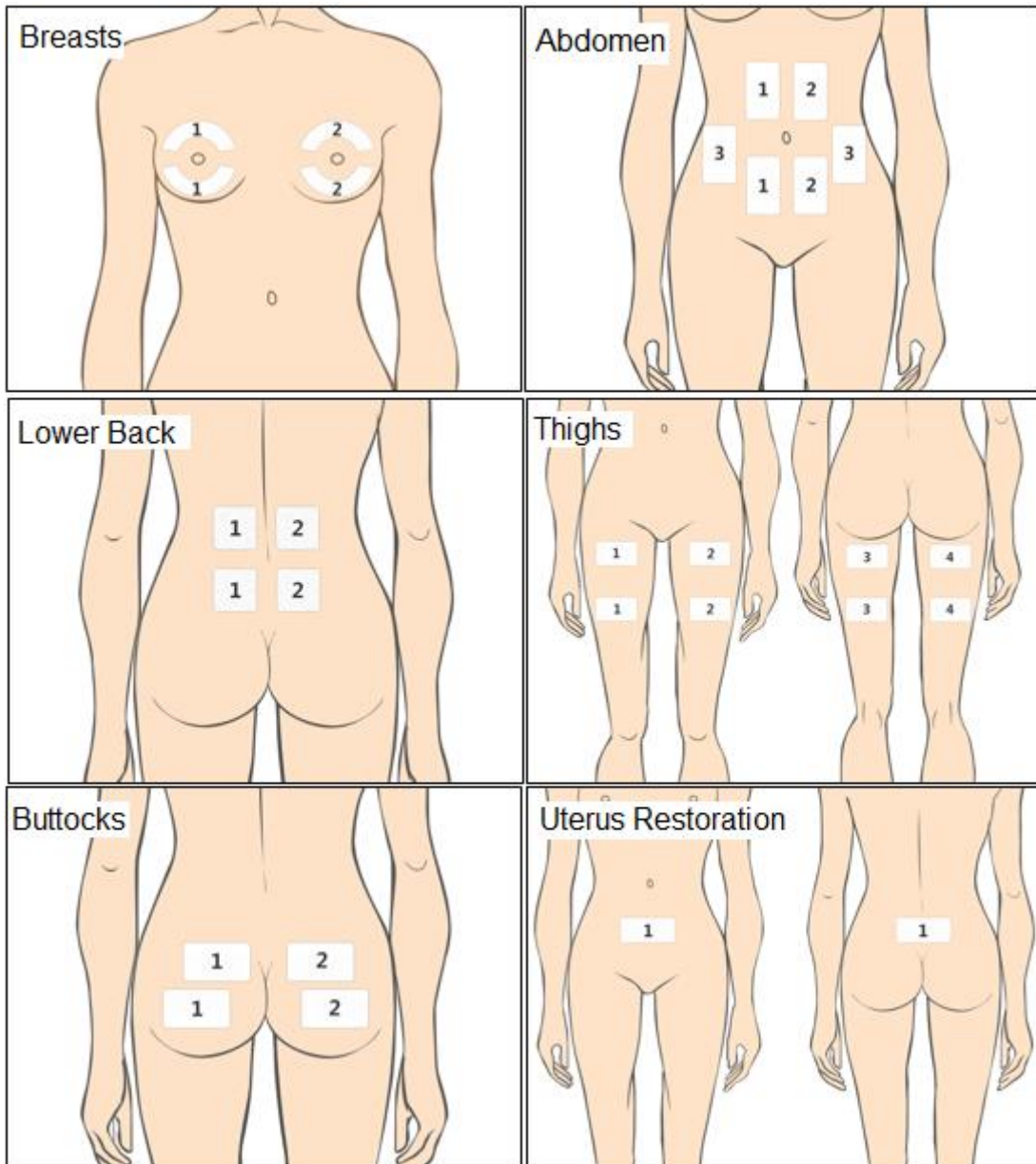

Figure 4-1

## 4.2 Adjusting Current

On the front panel of the main unit, there are four control knobs that can adjust the current intensity. Rotate them clockwise to increase the current intensity, rotate them

counterclockwise to decrease the current intensity. Only during the electrical stimulation output can the current be adjusted. The current cannot be adjusted during resting period.

### 4.3 Sensor/Probe/Electrodes Off

During the electrical stimulation, if any sensor/probe/electrode falls off or is not in good contact with the skin, the electrical stimulation will stop automatically and “Channel has fallen off” will be displayed on the interface. After replacement of the sensor/probe/electrode, the system will identify whether it’s connected successfully, if so, the treatment will go on.

---

---

#### **WARNING**

- 1 Please avoid contact between the electrodes and wounds or scars during the treatment.**
  - 2 The adhesive electrodes should not be placed crossing over the heart.**
- 
- 

#### **CAUTION**

- 1 Make sure the adhesive electrodes are in good contact with the skin.**
- 
-

# Chapter 5 \*Software Operation

## 5.1 Starting up the Software

After the device is turned on, the software login interface pops up automatically.

The drop-down user name menu lists all the latest user names. Select a user name, input the correct password and then click **Login** to open the main interface.

If it's the first time to use the software, please use sys as the user name to log in, the default password is **sys**. After entering the system, you can add patient.

**NOTE: Suggest to revise the password of user name sys after first login.**

## 5.2 Main Interface

After successfully logging in to the system, the system will automatically turn to the main interface, where you can choose to enter the functional modules such as assessment, treatment, postpartum rehab, database, setup, etc. See figure 5-1.



Figure 5-1

## 5.3 Patient Information

### 5.3.1 Patient Information Interface

Select **Assessment**, **Treatment** or **General Rehab**, the system will automatically turn to **Patient List** interface, see figure 5-2.

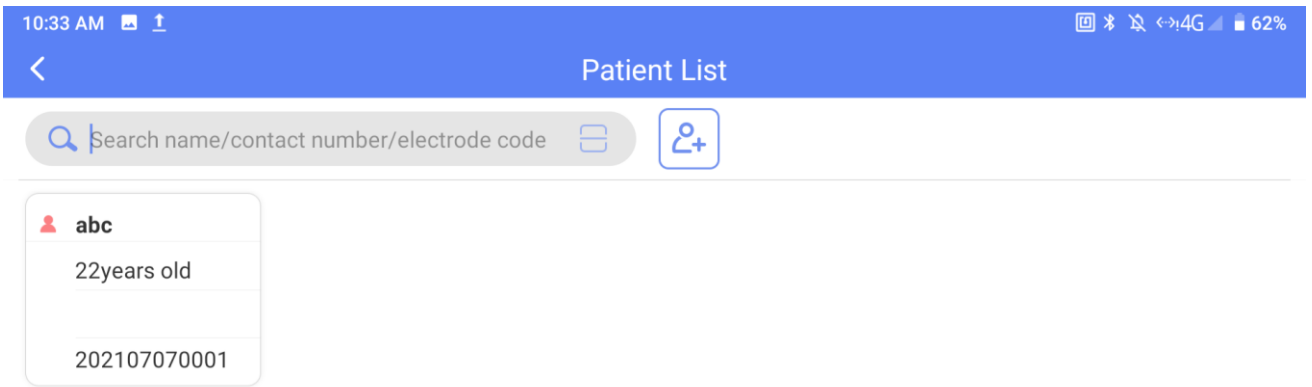



Figure 5-2

### 5.3.2 Adding Patient

You can register and input the information of a new patient by clicking the  button. See figure 5-3.

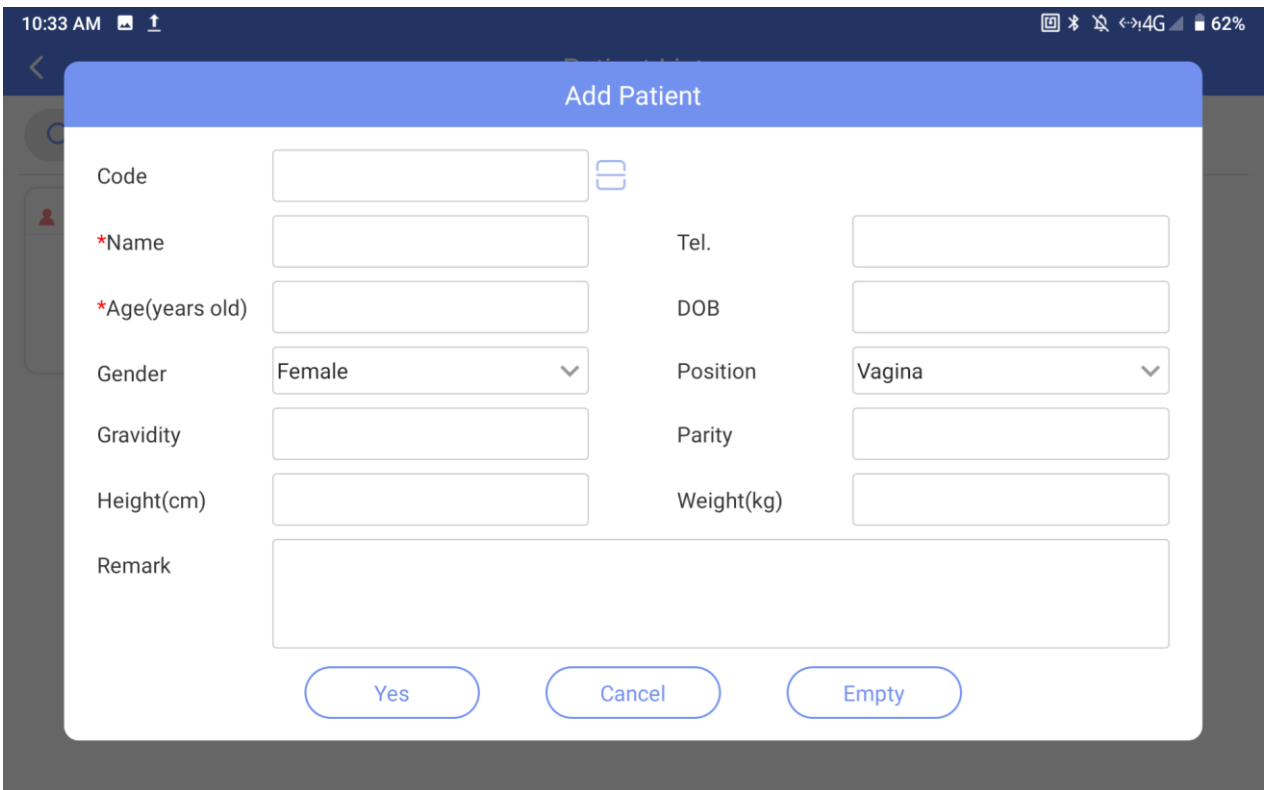

Figure 5-3

You should at least input the Name and Age. Click **Yes** to save the patient information; click **Cancel** to give up adding the new patient. The newly added patient information will be updated to the patient list automatically. You can long press the patient information in the patient list and modify it, then click **Yes** to save the modified information.

### 5.3.3 Searching Patient

You can search the patient in the patient list or through searching function if the patient information is in the database. Input the patient's name or phone number or code to search the patient, then the related patient will be displayed in the list. Select the patient, and enter the corresponding function interface.

### 5.3.4 Patient Record

Long press a patient in the patient list, you can select **Record** or **Treatment Record**, or delete the patient's information.

**1. Record:** includes all the patient screening and assessment data;

**Preview Waveform:** long press a record and select **Preview Waveform**, and the screening or assessment waveform and template will be displayed (the waveform of phase, waveform of which body part to be displayed and whether to display the template are optional);

**Assessment Report:** Click a record and the complete report preview of screening or assessment will be displayed. The report can be printed and saved by clicking **Print&Save**, or saved by clicking **Save**. The report content can be configured through **System- Print Settings**.

Click the waveform area in the examination report, the screening or evaluation waveform and template will be displayed.

**2. Treatment Record:** includes all the pelvic treatment and postpartum rehabilitation data and treatment progress of the patient. Select any of the record to review the data.

## 5.4 Assessment

Click **Assessment** on the main interface, select a patient in the patient list and then enter the main interface of assessment.

Before the assessment starts, click the **Protocol Selection** button  on the bottom right corner of the screen to switch the assessment type. There are four assessment types: **Quick Screening**, **EMG Assess**, **EMG Screening**, **Pressure Assess**, **Lumbago**, **Sexual Function** and **Cough Reflex**. Quick screening lasts about 1.5 minutes, EMG screening and pressure assessment last about 3.5 minutes, EMG assessment lasts about 6 minutes, lumbago lasts about 1.5 minutes, and the cough reflex assessment lasts about 1 minute and sexual function assessment lasts about 2 minutes. Please refer to figure 5-4 for the main interface of Assessment.

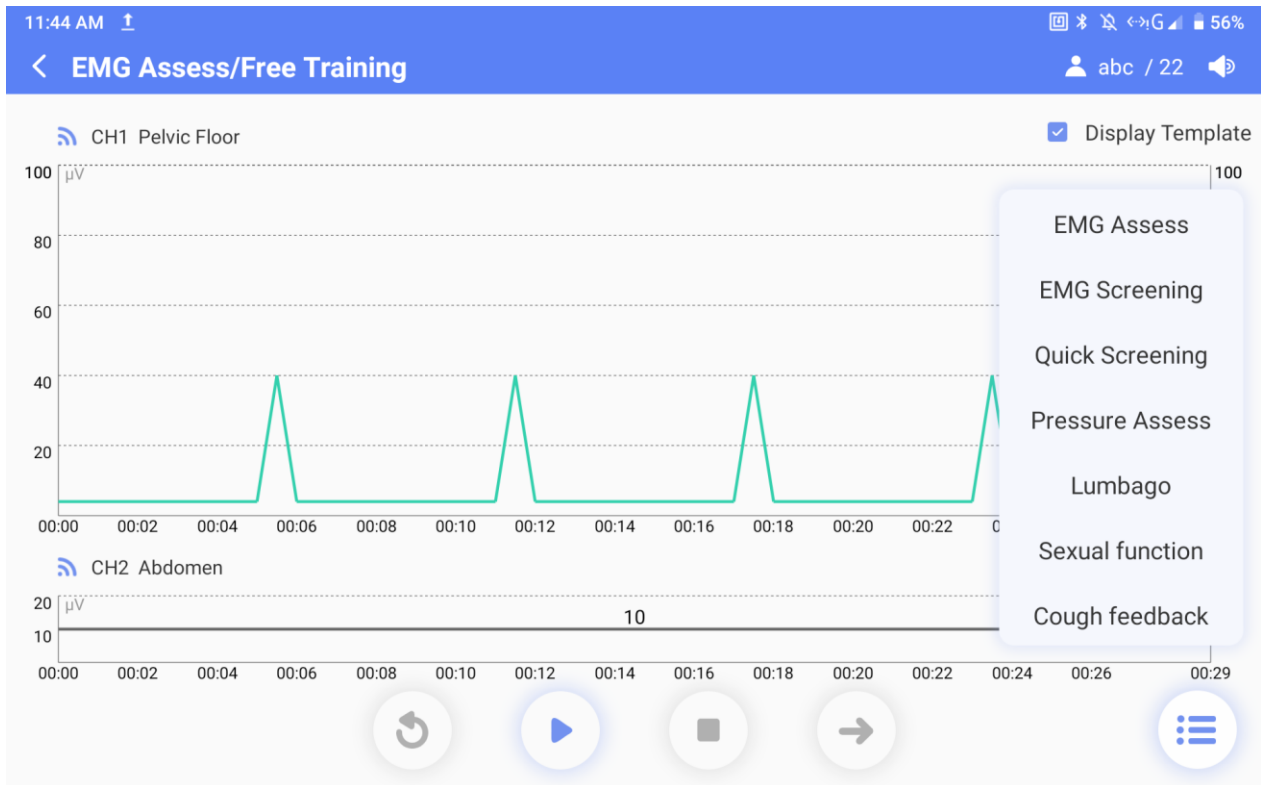

Figure 5-4

Quick screening, EMG screening, EMG evaluation and pressure screening include free training and formal assessment. Sexual function assessment, lumbago assessment and cough reflex assessment do not include free training.

**NOTE: If code is not filled during adding patient, click any mode under assessment, you will be informed to fill in the code.**

### 5.4.1 Free Training

The interface of Free Training is as follows.



Figure 5-5

Free training mainly helps patient learn to contract target muscles and be familiar with the contraction actions and contraction rhythms. Free training not only displays the template of fast twitch muscle contraction and slow twitch muscle contraction, but also plays the corresponding voice prompt. When the patient is familiar with the contraction actions and

rhythms, click  to enter formal screening. The interface displays the EMG or pressure waveforms and templates, position information of the channel and whether to display the template (selected by default).

### 5.4.2 Quick Screening

The interface of **Quick Screening** is similar to **Free Training**. As shown in figure 5-6, it has 4 phases: pre-resting phase (10s resting), fast contraction phase (fast contraction for 3 times), continuous contraction phase (continuous contraction for 3 times) and post-resting phase (10s resting), totally lasting for 1 minute and 3 seconds.

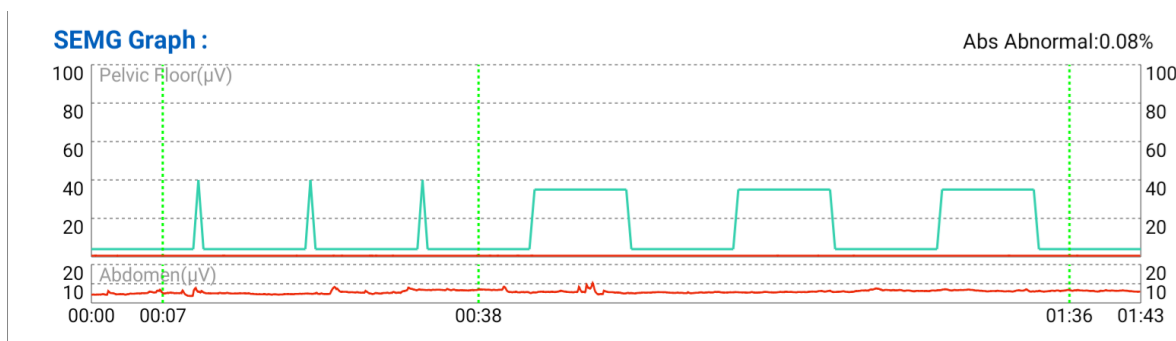

Figure 5-6



### 5.4.3 EMG Screening

The interface of **EMG Screening** is similar to Free Training. As shown in figure 5-7, it has 4 phases: pre-resting phase (25s resting), fast contraction phase (fast contraction for 5 times), continuous contraction phase (continuous contraction for 5 times) and post-resting phase (25s resting), totally lasting 3 minutes and 25 seconds.

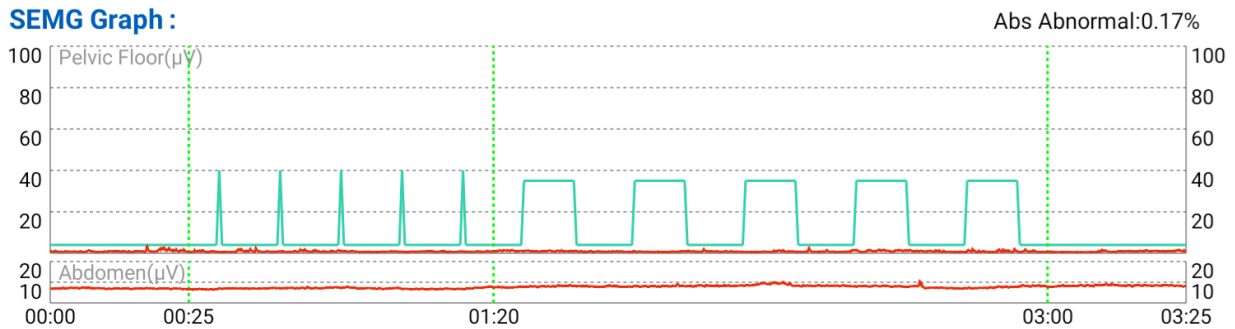

Figure 5-7

### 5.4.4 EMG Assessment

The interface of **EMG Assess** is similar to Free Training. As shown in figure 5-8, it has 5 phases: pre-resting phase (60s resting), fast contraction phase (fast contraction for 5 times), continuous contraction phase (continuous contraction for 5 times), durable contraction phase (60s durable contraction) and post-resting phase (60s resting), totally lasting 6 minutes and 15 seconds.

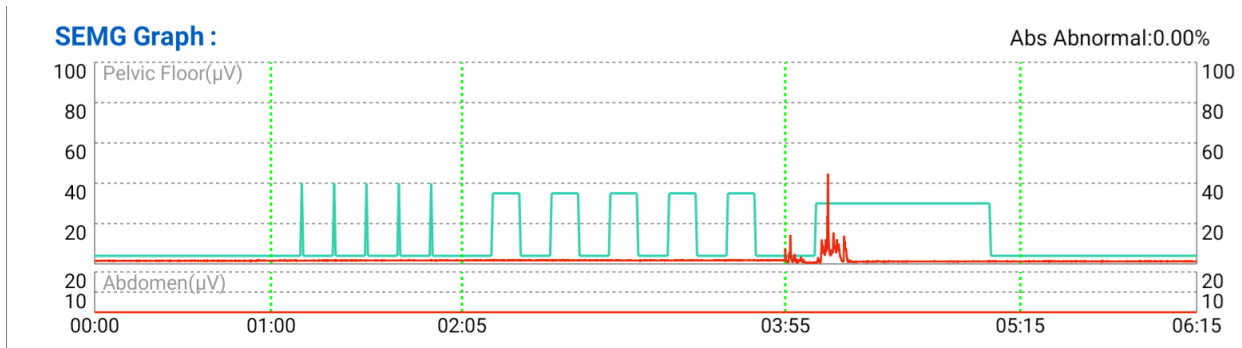

Figure 5-8

### 5.4.5 Pressure Assessment

The vaginal stress probe is used for pressure assessment.

The interface of Pressure Assessment is similar to Quick Screening. It has 4 phases: pre-resting phase (25s resting), fast contraction phase (fast contraction for 5 times), continuous contraction phase (continuous contraction for 5 times) and post-resting phase (25s resting), totally lasting 3 minutes and 25 seconds.

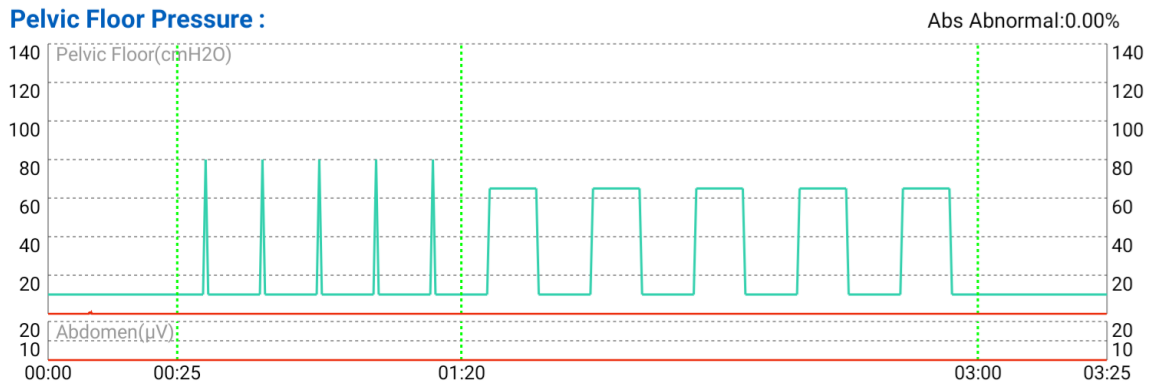

Figure 5-9

### 5.4.6 Lumbago Assessment

The **lumbago assessment** is conducted by evaluating the lower back muscles when patient is bending down, getting up and relaxing under guidance. During the lumbago process, the actions of bending down, getting up and relaxing repeat three times, as shown in figure 5-10, totally lasting 1 minute and 33 seconds.

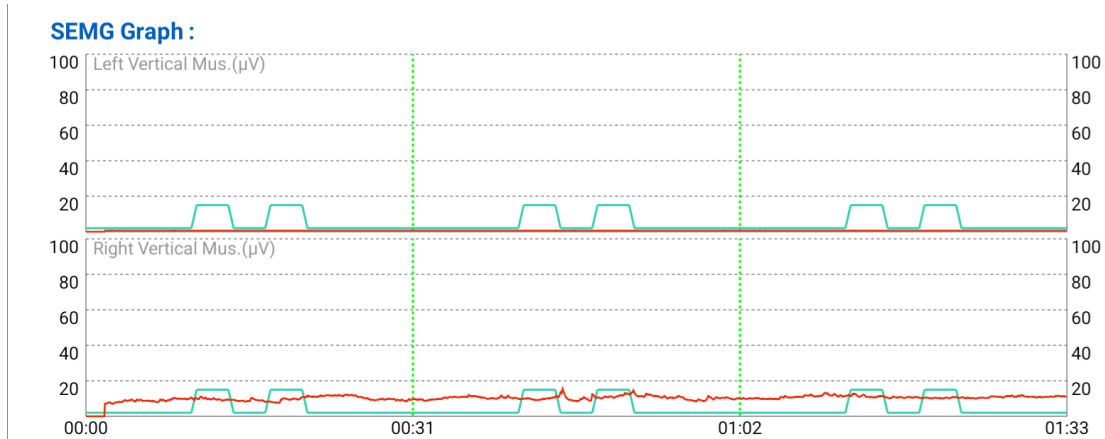

Figure 5-10

### 5.4.7 Sexual Function Assessment

Click the **Sexual Function** button and the **Sexual function response test** dialogue box will pop out. Select the test results for **Nipple Test Response**, **G-point Test Response** and **Cotton Swab Test Response**. There are three kinds of test results: **Blank** (default), **Negative** and **Positive**. Click **OK** and the sexual function assessment will be started. The sexual function assessment includes 3 phases, totally lasting 2 minutes.

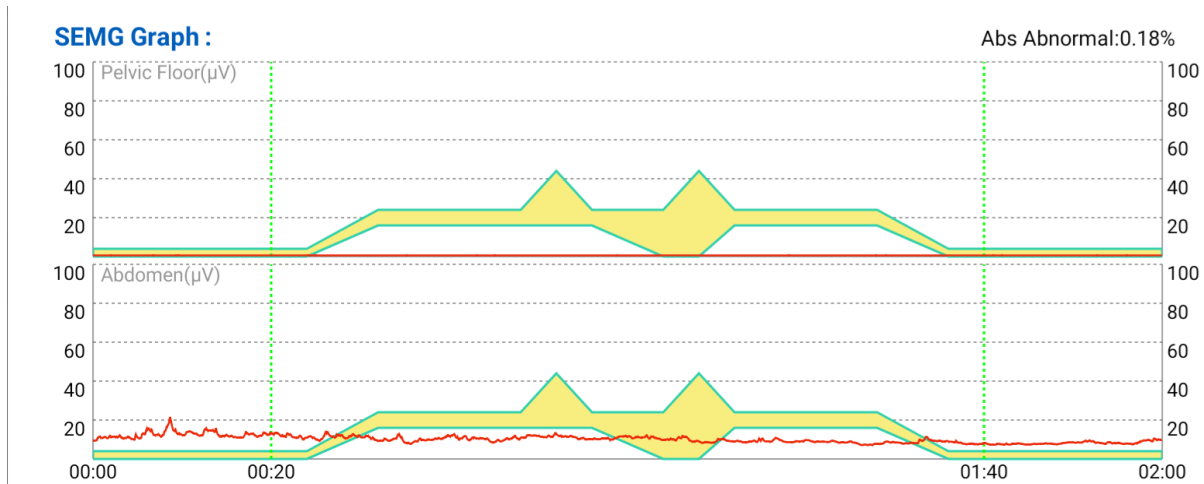

Figure 5-11

### 5.4.8 Cough Reflex Assessment

The **Cough Reflex Assessment** includes 2 phases. Before each phase, there are corresponding voice prompts, cough reflex assessment voice prompts and message box prompts: This test measures the reflex rate and contractile muscle strength of pelvic floor muscles under cough condition, including three times of mild cough and three times of vigorous cough. Please complete different degrees of cough according to the voice prompts.

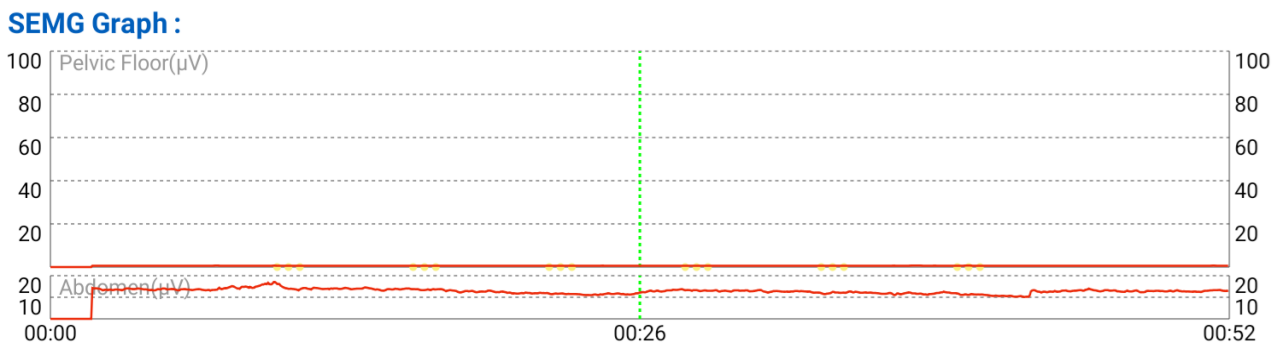

Figure 5-12

### 5.4.9 Screening Assessment Report

When the screening and assessment ends, the report will pop up automatically. Click the **Print** button to print and save the report. Click the **Save** button to save the report without printing.

Close the report and return to patient information interface.

**NOTE: The evaluation results are for doctor's reference only, and the doctor will finally give the diagnosis conclusion.**

## 5.5 Treatment

Click **Treatment** on the main interface, select a patient in the patient list and then enter the main interface of treatment.

Treatment includes "**Defined Protocol**" and "**Custom Protocol**". Select the required protocol and click  , and the parameter interface will pop out. The parameters can be adjusted, such as treatment time: 1-60min (1min step, ±10%) . For the range of the other parameters, please refer to A1.3 **Performance Specifications-Stimulation Parameters**.

### 5.5.1 Defined Protocol

The defined protocol includes **Intelligent Protocol** and **Fixed Protocol**. **Intelligent Protocol** refers to generating a treatment protocol intelligently according to the screening assessment result. **Fixed Protocol** refers to selecting a system defaulted or user edited treatment protocol and generating treatment protocol.

#### 5.5.1.1 Intelligent Protocol

"**Intelligent Protocol**" is selected by default on the patient protocol interface. If the patient has the screening assessment result, the system will select the latest data by

default. Select a protocol type and click  to generate an Intelligent Protocol.

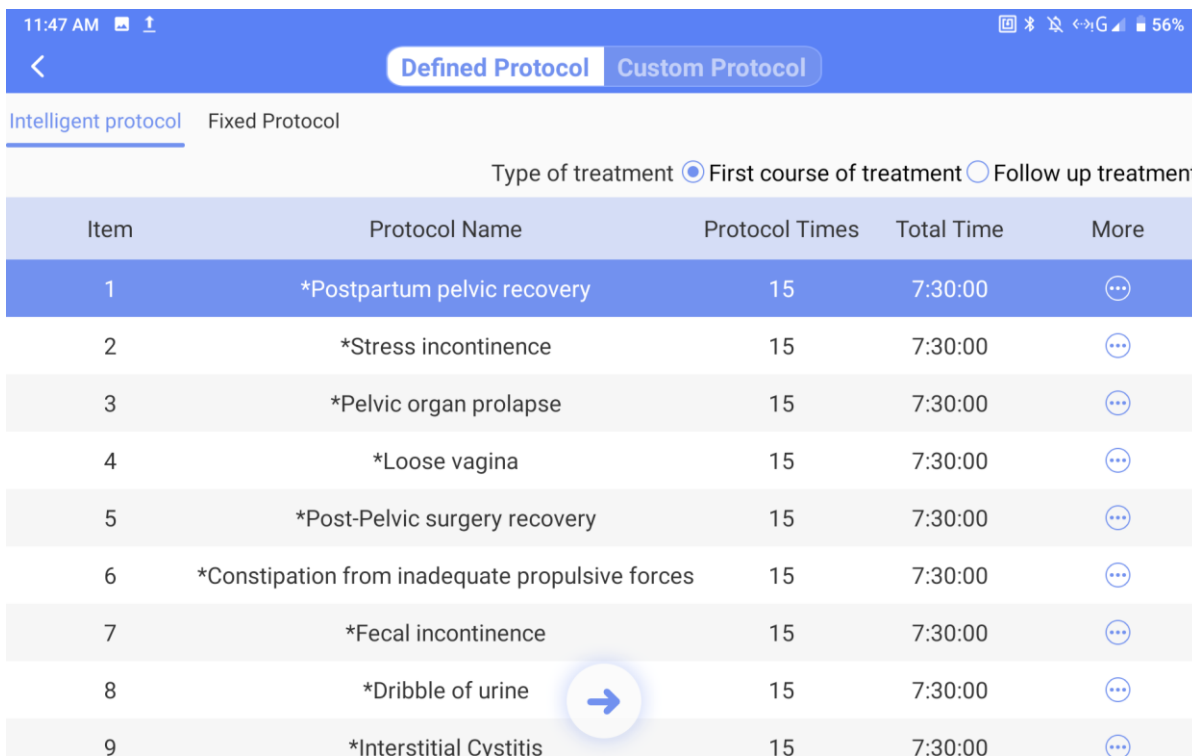



Figure 5-13

If the patient does not have a screening assessment result, the user can select **Muscle Grade**, **Pressure Assess Result** or **Result of EMG Assessment** (default) to generate a protocol. When **Result of EMG Assessment** is selected, the user shall input **Max of Fast Twitch Muscle** and **Mean of Slow Twitch Muscle** of the patient. When **Muscle Grade** is selected, the user shall input the muscle grade, ranging from 0 to 5 (blank by default); when **Pressure Assess Result** is selected, the user shall input **Current**

**Pressure** and **Max. Value**. After filling in the information, click  to generate an Intelligent Protocol.

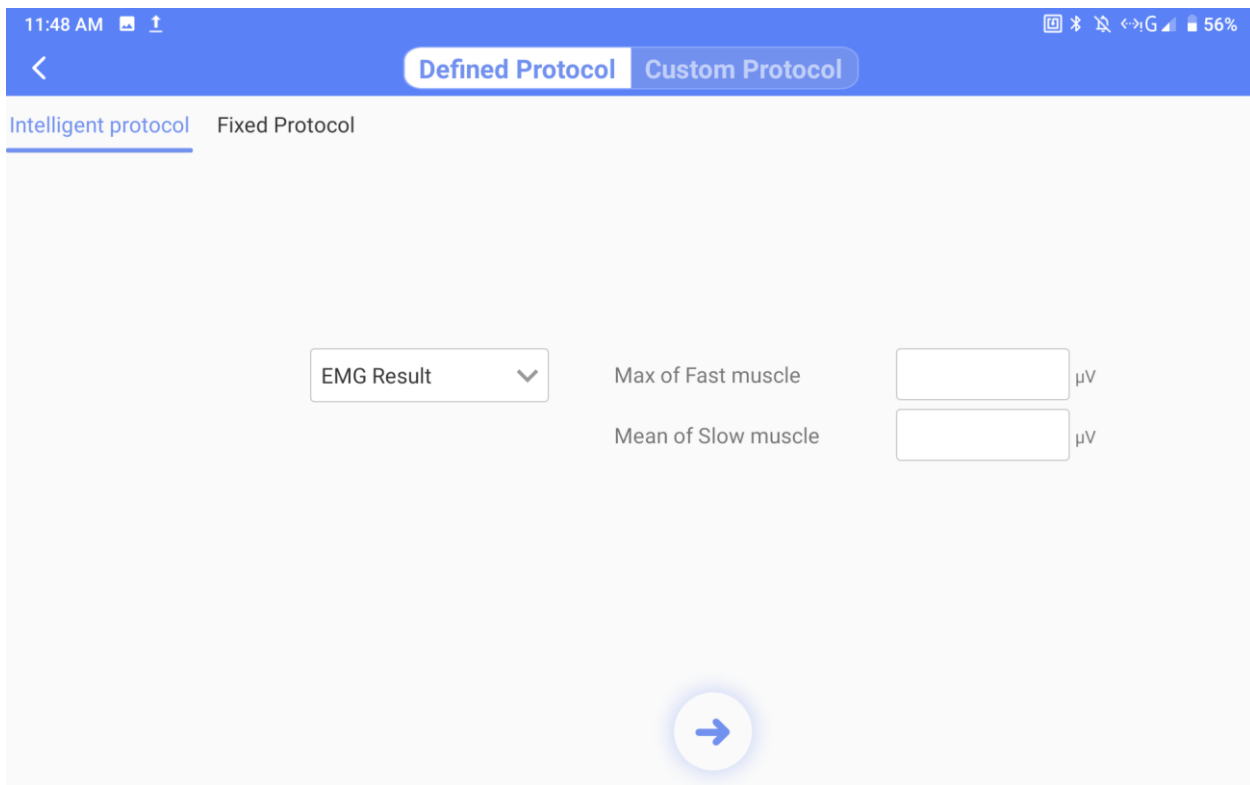



Figure 5-14

### 5.5.1.2 Fixed Protocol

Select "**Fixed Protocol**" on the patient protocol interface, select a protocol type and click

 to generate a treatment protocol.

Item	Protocol Name	Protocol Times	Total Time	More
1	*Postpartum pelvic recovery	15	7:30:00	⋮
2	*Stress incontinence	15	7:30:00	⋮
3	*Pelvic organ prolapse	15	7:30:00	⋮
4	*Loose vagina	15	7:30:00	⋮
5	*Post-Pelvic surgery recovery	15	7:30:00	⋮
6	*Constipation from inadequate propulsive forces	15	7:30:00	⋮
7	*Fecal incontinence	15	7:30:00	⋮
8	*Dribble of urine	15	7:30:00	⋮
9	*Interstitial Cystitis	10	5:00:00	⋮
10	*Myogenic chronic pelvic pain	10	5:00:00	⋮

Figure 5-15

### 5.5.1.3 MVC Detection

MVC is short for Maximum Voluntary Contraction. If an intelligent protocol is selected, the MVC Detection interface will pop up by default. The parameter and template are adjusted according to the single MVC result of the patient, as shown in the following figure.





Figure 5-16

If **Fixed Protocol** is selected and the protocol includes Kegel or biostim feedback programs, the MVC Detection interface will pop up during each treatment by default. The template is adjusted according to the single MVC result of the patient, as shown in the following figure.

#### 5.5.1.4 Protocol Treatment

The protocol treatment includes various methods: **Electro-Stim, ETS, Biostim feedback, Kegel, Scene Training, Relaxation (Music Relaxation, Breath Relaxation, Feedback Relaxation), Game and Dilation**, as shown in the following figure.

Click the **Start Treatment** button  to start the treatment, click the **Pause** button 

to pause the treatment if necessary, click the **End Treatment** button  to end the treatment.

During Electro-Stim, Kegel and Scene Training, the height of coordinate axis can be adjusted in real time.







Figure 5-19 Biostim feedback



Figure 5-20 Kegel



Figure 5-21 Scene Training

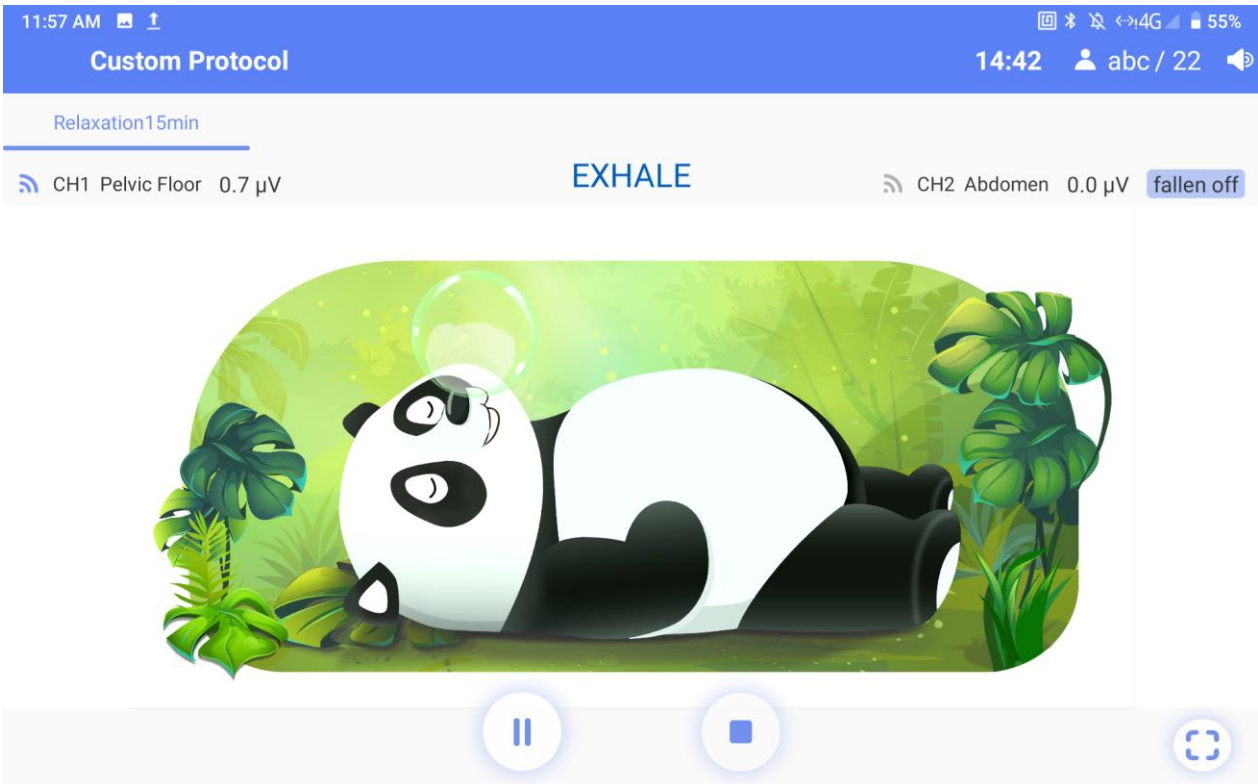

Figure 5-22 Breath Relaxation

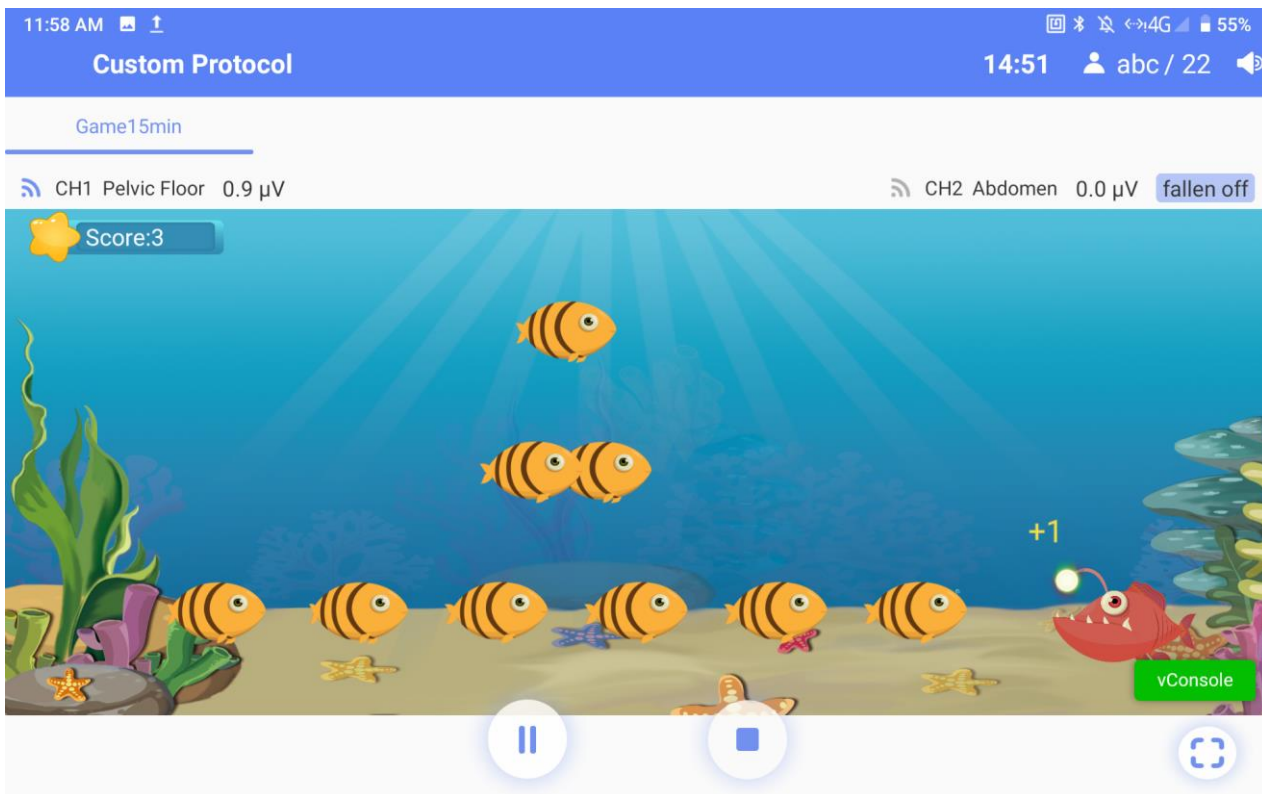

Figure 5-23 Game

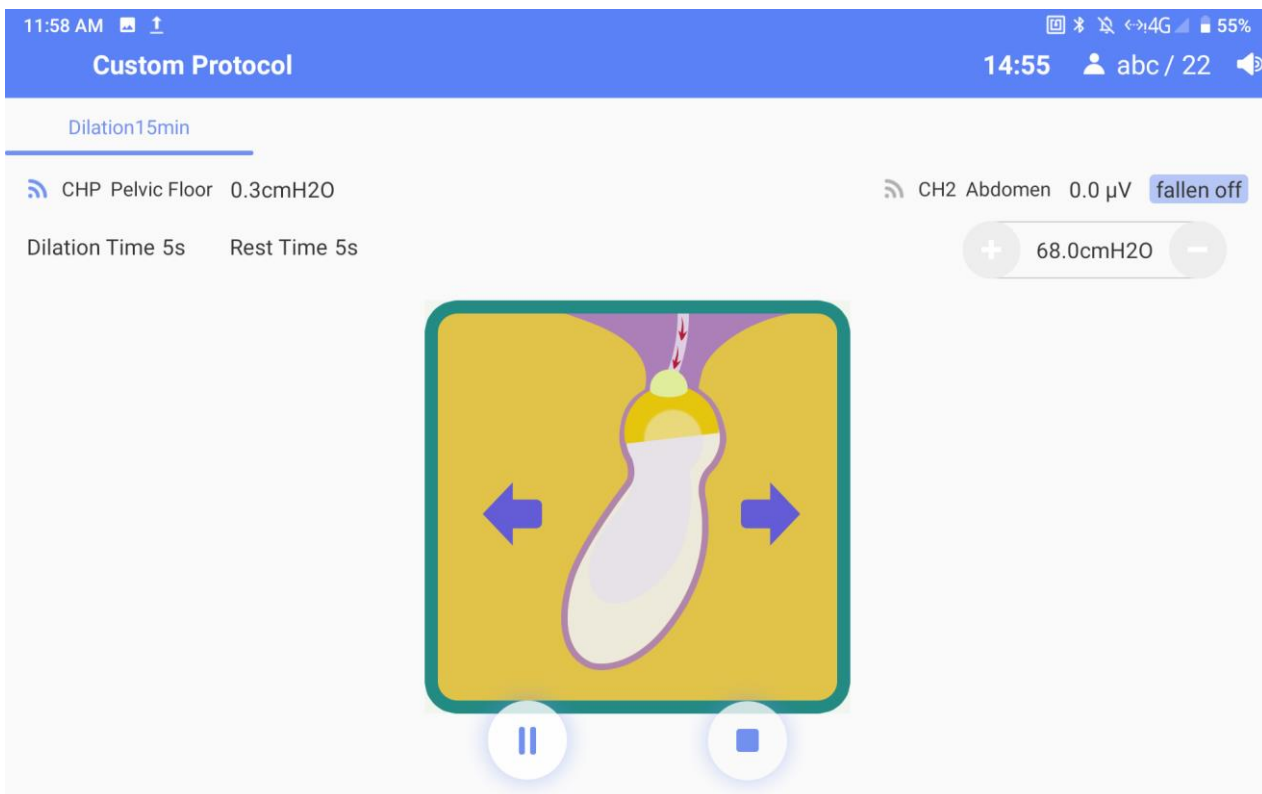

Figure 5-24 Dilation

## 5.5.2 Custom Treatment

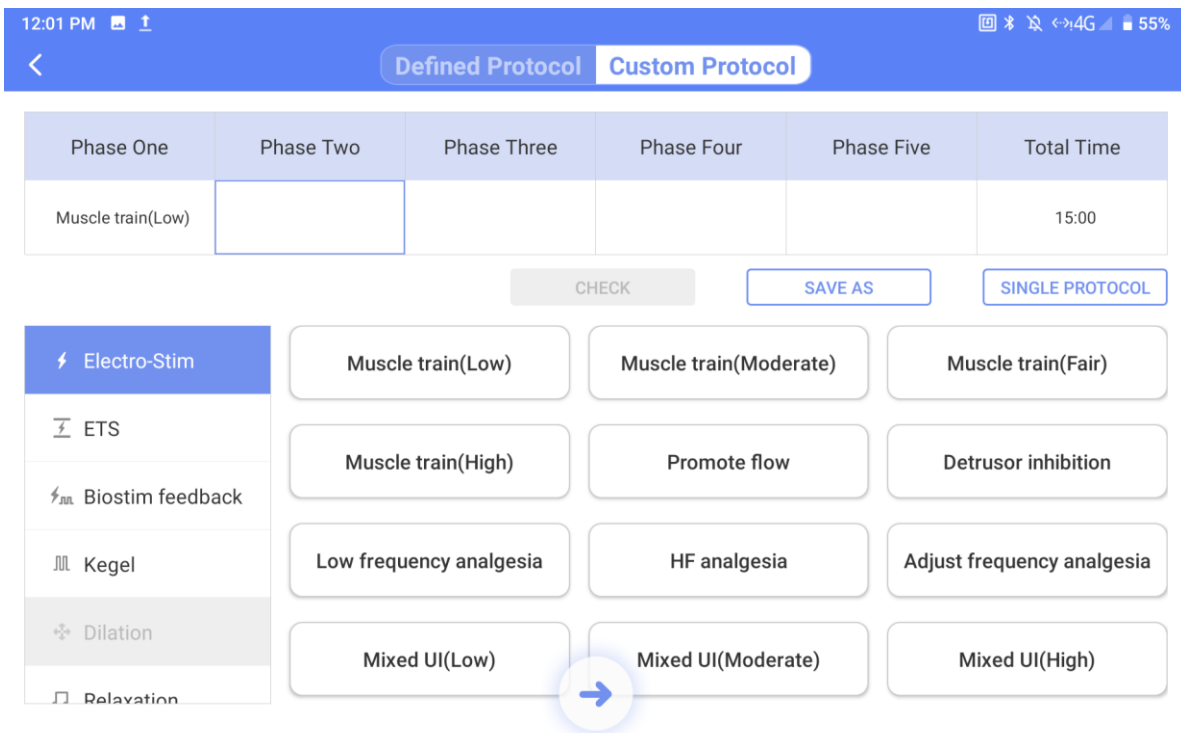



Figure 5-25 Custom Treatment

The Custom Treatment supports user to assemble and adjust customized protocols referring to patient's condition. The user can select appropriate protocol segments below, modify the parameters and add them to the phase framework. Click the **Start Treatment**

button  to start the treatment.

When the selection of each phase is completed, click **Save As** and the parameter information interface will pop up. Edit the protocol name and parameter values, and click **Save As** to save the current protocol. The protocol is available in Single Protocol of pelvic floor treatment.

Click **Single Protocol**, and the single protocol selection interface will pop up. Select a

protocol, and click  to return to the **Custom Protocol** interface, the protocol will be automatically filled in the corresponding phase of custom protocol. Click the **Start**

**Treatment** button  to start the treatment.

## 5.6 Postpartum Rehabilitation

Select **Postpartum Rehabilitation** on the main interface, select a patient in the patient list and then enter the main interface of Postpartum Rehabilitation.

Postpartum Rehabilitation has two modes: Single Person Mode and Double Person Mode. After clicking **Start All**, the software would remember the user's choice.

In Double Person Mode, CH1 and CH2 are defaulted for Patient 1, CH3 and CH4 are defaulted for Patient 2. Channels can work or end simultaneously by clicking the "Start

all” or “End all” button. Or the user can pause or end each one channel by corresponding button in its framework.

Click **Please choose protocol**. If the parameter of the selected protocol needs modification, click the protocol, and then configure the current intensity of each channel. If the current intensity is confirmed to be appropriate, click **Start all** to start the treatment. The electrical stimulation will stop automatically if the treatment time is up.

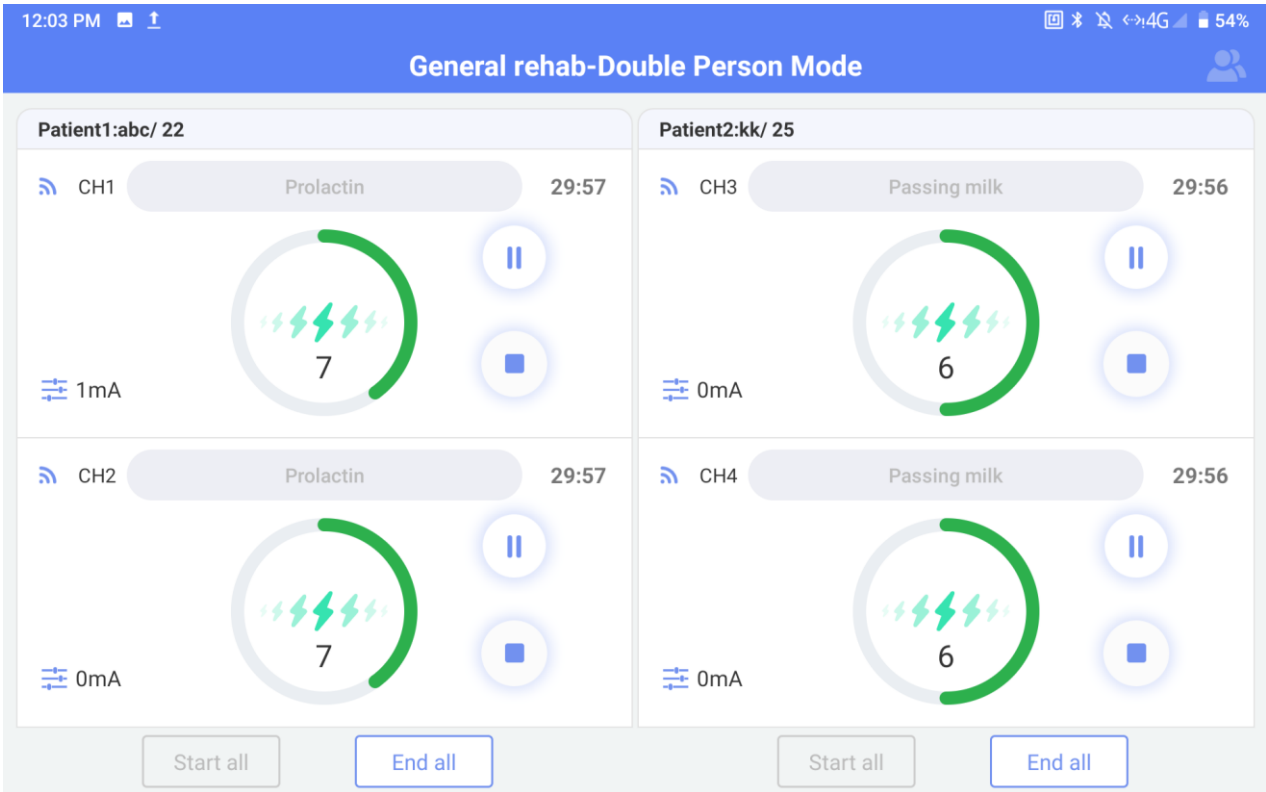

Figure 5-26 Double Person

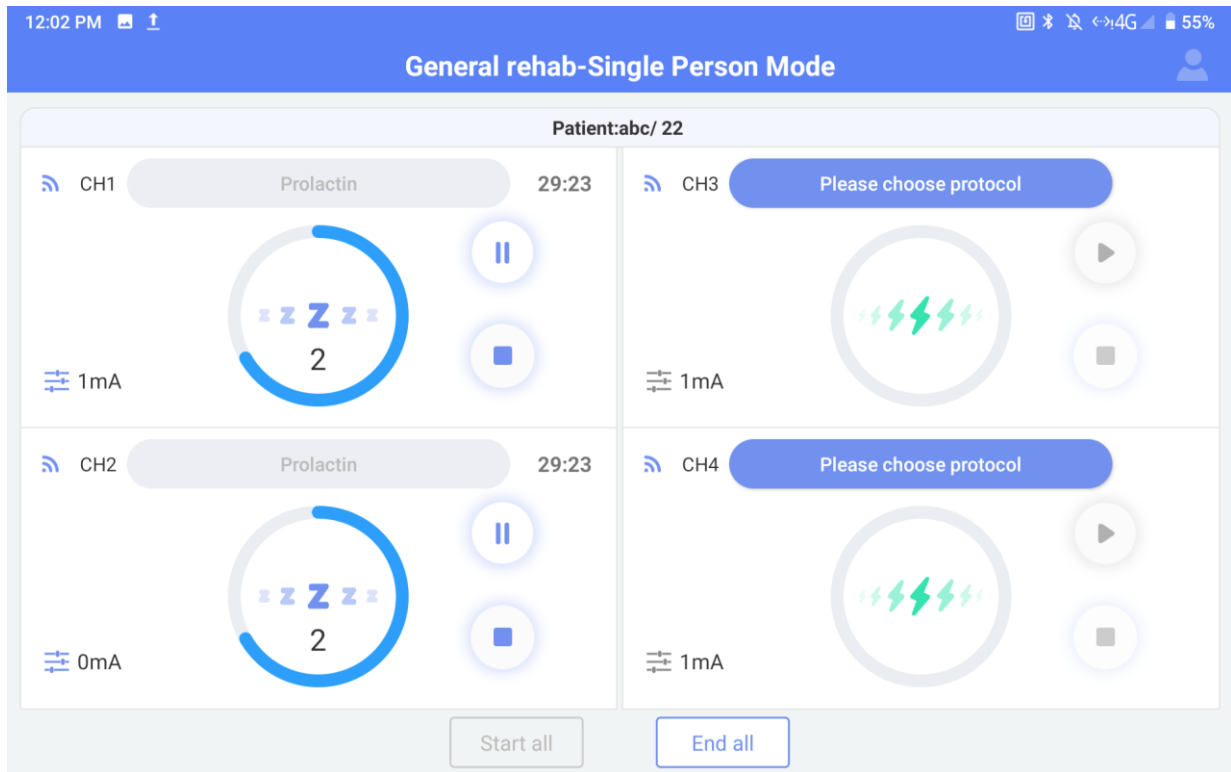

Figure 5-27 Single Person

## 5.7 Database

Click **Database** on the main interface to enter the Database interface.

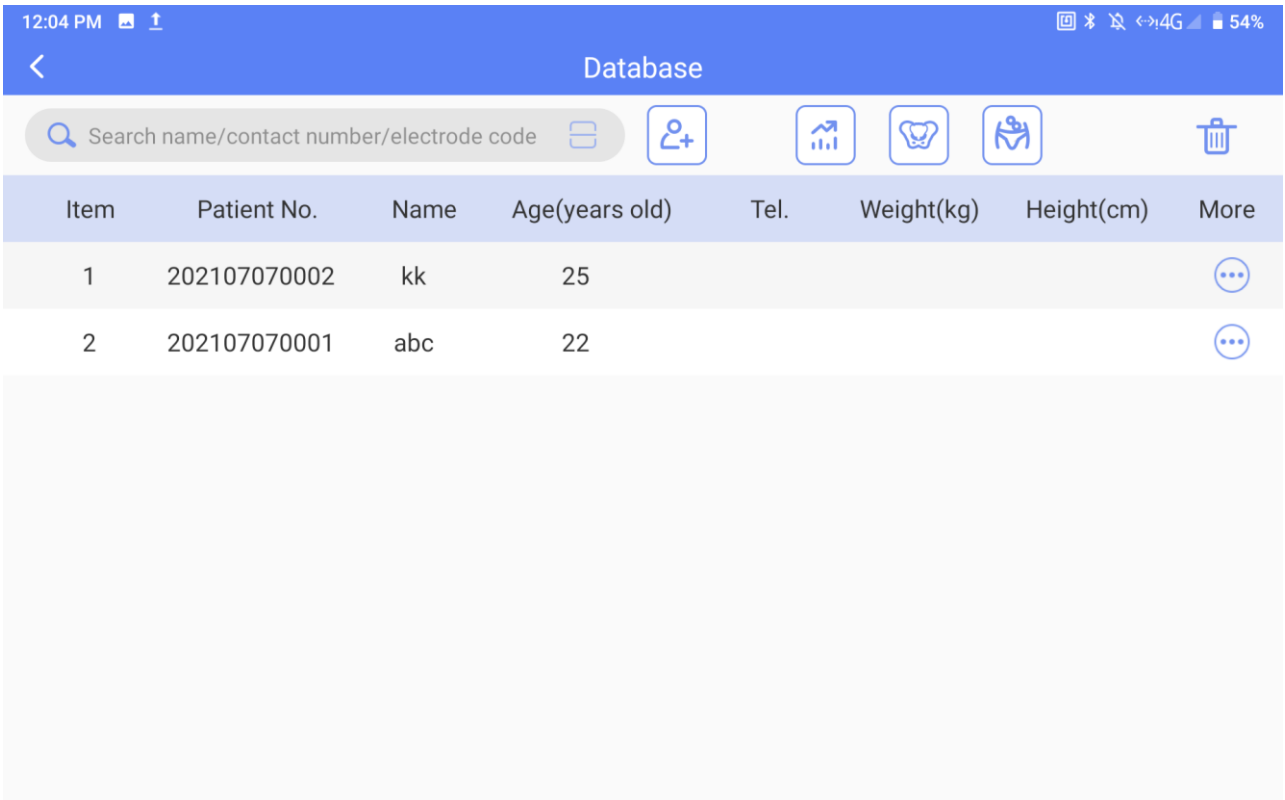

Figure 5-28 Database

### 5.7.1 Patient Information

Long press a patient, click **Edit**, the selected patient information modification interface will pop up, and the patient information can be modified.

Click **Delete** to delete the selected patient information and all patient records.

### 5.7.2 Patient Record

Preview Waveform: refers to section 5.3.4

Examine Report: refers to section 5.3.4

Data Review: refers to section 5.3.4

Delete: deletes a patient record selected.



## 5.8 Settings

### Note:

**Only the user authorized with "Setup" can enter the "Setup" interface to setup the system.**

### 5.8.1 User Settings

#### 5.8.1.1 Hospital Name

- 1) Click the **Setup** button  on the main interface.
- 2) Click User **Setup**.
- 3) Click **Name** and input hospital name.
- 4) Click the **Save** button .

#### 5.8.1.2 Application

- 1) Click the **Setup** button  on the main interface.
- 2) Click User **Setup**.
- 3) Click **Application**, and select a department in the drop-down menu.

#### 5.8.1.3 Adding User



- 1) Click the **Setup** button  on the main interface.
- 2) Click User **Setup**.
- 3) Click **Add User**.
- 4) Input name, password and type, and then register your fingerprint.

- 5) Click the **Save** button .



**NOTE:**

The user in different type can pick different authorization. The system manager defaults to have all authorizations; the director cannot pick "Setup"; the doctor and nurse cannot pick "Setup" and "Delete Historical Data".

#### 5.8.1.4 Modifying User

- 1) Click the **Setup** button  on the main interface.
- 2) Click User **Setup**.
- 3) Click **Modify User**.
- 4) Select the user requiring modification in the drop-down menu of **Name**, and the user information will be shown below. You can edit the information.
- 5) After modification, click the **Save** button  and restart the software.

#### 5.8.1.5 Login Settings

- 1) Click the **Setup** button  on the main interface.
- 2) Click User **Setup**.
- 3) Click **Login Settings**.
- 4) Select **Default User Login** (not selected by default).
- 5) Select a user in the drop-down menu and click the **Save** button  and then next time you can log in directly with the user's account and password after starting the software without confirmation.

### 5.8.2 General Settings

#### 5.8.2.1 Interface Settings

**Filled Color:** sets the filled color of Kegel template in Kegel and Biostim Feedback interface, and the filled color of ETS template in ETS and initiative Biostim Feedback interface.

**Waveform Color:** sets the color of all waveforms on the Assessment and Treatment interface.

**Template Color:** sets the template color of MVC detection on the Assessment and Treatment interface.

**Threshold Line Color:** sets the color of all the threshold lines on the Assessment and Treatment interface.



**Waveform/Template Size:** sets the width of all waveforms/ template width in MVC detection on the Assessment and Treatment interface.

**Pressure Unit:** Set the pressure unit in pressure assessment and report, the pressure unit is cmH<sub>2</sub>O by default.

### 5.8.2.2 Channel Settings

**Pelvic Floor:** sets the corresponding channel of pelvic floor muscles in the Assessment and Treatment interface. If the channel is not configured, it is CH1 by default.

**Abdomen:** sets the corresponding channel of abdominal muscle on the Assessment and Treatment interface. If the channel is not configured, then it is CH2 by default.

**Gluteus** (in case): sets whether to use gluteus channel, setup the corresponding channel of gluteus in the Assessment and Treatment interface. **Gluteus** is not selected and its channel is CH3 by default.

**Adductor** (in case): sets whether to tick adductor channel, and sets the corresponding channel of adductor on the Assessment interface. **Adductor** is not selected and its channel is CH4 by default.

### 5.8.2.3 Other Settings

**Date Format:** selects a date format in the drop-down menu. If the date format is not configured, the date format is identical with the system time format by default.

**Free Training Time:** sets the free training time on the Assessment interface. If it is not configured, then it is 2 min by default.

**Phase Interval:** sets the interval between treatment phases on the Treatment interface. If it is not configured, then it is 5s by default.

**Current intensity Stepping (50-100mA):** sets the current intensity stepping during Electro-Stim, ETS and Biostim Feedback, the default value is 0.5mA.

**Current intensity Stepping (0-50mA):** sets the current intensity stepping during Electro-Stim, ETS and Biostim Feedback, the default value is 1mA.

**Power Frequency Filtering:** Selects “50Hz” (default) or “60Hz”, and **Weak Filter** (default) and **Strong Filter** can be selected in the drop-down menu.

**ECG Filtered:** **Close**, **Weak Filter** and **Strong Filter** can be selected in the drop-down menu. The ECG interference can be reduced when it is turned on.

### 5.8.2.4 Restoring Factory Configurations

Click the **Restore Factory Config** button. All configurations will restore to the system default values.

### 5.8.3 Printing Settings

Click **Print Settings** to set up patient information, report information, report title and

footer.

Content	Option	Instructions
Patient Information	Name	Selected by default
	Age	Selected by default
	Gender	Selected by default
	Examining Time	Selected by default
	Position	Unselected by default
	Gravidity	Selected by default
	Parity	Selected by default
	Tel.	Unselected by default, print when selected
	Height	Unselected by default, print when selected
	Weight	Unselected by default, print when selected
	Remark	Unselected by default, print when selected
Report Information	Report Remark	Selected by default
	Clinic Advice	Selected by default
	Brief Description of the Report	When the report type is Assessment Report, then it's selected by default and can be edited. When the report type is General Report, then it's not selected by default and will be printed when selected.
	Muscle state	Selected by default
	Display Template	Unselected by default, print when selected
	Participate%	Selected by default
Report Title	EMG Screening / Quick Screening / EMG Assess, Pressure Assess	Title can be modified.
	Cough Reflex, Lumbago, Sexual Function	Title can be modified.
Page Footer	Doctor, Operator	Selected by default

### 5.8.4 Protocol Management

Click the **Protocol Management** button to check **Pelvic Floor Protocols**, **Postpartum Protocols** and **Import Protocol**. Protocols with \* in the front is system-provided which cannot be deleted or modified.

**Pelvic Floor Protocols** include Intelligent Protocol, Single Protocol and Fixed Protocol.

- 1) Click the **Add** button below the three libraries to add custom protocol.
- 2) Select a protocol and click the **View Protocol** button to check the parameters of the protocol; click the **Delete** button to delete the protocol; click the **Up** and **Down** buttons to move the protocol upward and downward in the list.
- 3) Select a protocol and click the **Export** or **Import** button, the dialogue box of export or import route will pop out, click **Yes** to export or import the selected protocol.

There are following buttons under **Post-Birth Plan Library**: **Add**, **Delete**, **Up**, **Down**, and **Check**. The operation method is the same as **PF Plan Library**.

**Import Protocol**: Insert the mobile storage device into the USB interface and click **Import Protocol**. Select the protocol file, and click **Import File**. Select the imported protocol, and click **Import Protocol** to import.

## 5.8.5 Database

### 5.8.5.1 Backing Up Database

- 1) Click the **Setup** button  on the main interface, and then click **Database**.
- 2) Connect the removable storage device to the USB interface.
- 3) Click **Backup Database**. Select the backup method(**Auto Backup** or **Manual Backup**). Automatic backup requires selecting days (1-30 days, default is 7 days), it starts after restarting the software; manual backup takes effects after clicking Start Backup.
- 4) After database is backed up, restart the software

#### **NOTE:**

**The figure cannot be backed up in automatic backup, but can be backed up in manual backup.**

### 5.8.5.2 Rebuilding Database

- 1) Click the **Setup** button , then click the **Database** label.
- 2) Select the database rebuilding path.
- 3) Click **Start Restoring**.
- 4) Click **OK** after database is rebuilt.
- 5) Exit the system manually, then restart the software.

### 5.8.5.3 Updating System

This interface displays the Device Model, SN Code, Full Version of the Software, Firmware Version, Algorithm Version, and System Version No. At the same time, you can set the language and skin of the software and upgrade the software through a USB flash drive.

Multi-language: Simplified Chinese, Traditional Chinese (Taiwan, China), and English can be selected.

Skin replacement: Default skin and pink skin can be selected. U Disk Software Upgrade: After clicking

"Upgrade Software by U Flash Disk", select the APP installation file and click **Import**. The import process displays a progress bar. After the import is complete, follow the steps to complete the installation.

## 5.8.6 Communication Settings

### 5.8.6.1 Wifi Settings



- 1) Open the top menu, locate the WiFi WLAN , and long press to enter.
- 2) Select the device to connect, enter the device password, and click connect.

### 5.8.6.2 BT Settings



- 1) Open the top menu, locate the BT 蓝牙 , and long press to enter.
- 2) Select the device to connect, enter the device password, and click connect.

### 5.8.6.3 NFC Settings



- 1) Open the top menu, click the NFC NFC .
- 2) Place the identification card above the device, and check whether the displayed information is accurate.

## Chapter 6 Maintenance and Cleaning

### 6.1 Maintenance

#### 6.1.1 Inspection

##### (1) Visual Inspection

Prior to using the system every time, perform the following inspections:

- 1) Check the system and accessories to see if there is any visible evidence of damage that may affect the patient's or operator's safety.
- 2) Check all the outer cables, power socket and power cables for damage and connection.
- 3) Check if the system functions properly.

If any damage is detected, stop using the system. Replace the damage part(s) or contact the manufacturer for service before reusing it.

##### (2) Routine Inspection

The overall check of the system, including safety check and function check, should be performed by qualified personnel every 12 months or according to local regulations, and each time after service.

The equipment should undergo periodic safety testing to ensure proper patient isolation from leakage currents. This should include leakage current measurement and insulation testing. The recommended testing interval is once a year or as specified in the institution's test and inspection protocol.

---

---

#### **WARNING**

**Failure on the part of the responsible individual hospital or institution employing the use of this equipment to implement a satisfactory maintenance schedule may cause undue equipment failure and possible health hazards.**

---

---

#### 6.1.2 Daily Maintenance

Workstation:

- ◆ Keep the workstation at least 5cm away from the wall for the sake of heat and air dissipation.
- ◆ To avoid the potential accident resulted from unexpected power lost or unsteady power supply, it is recommended to connect the system to a UPS (Uninterrupted Power Supply).
- ◆ This system is medical equipment. To protect the system from virus and crash, third-party software without authorization should not be installed.
- ◆ To ensure normal running of the operating system and the software, do not delete or modify the files on the hard drive.

## 6.2 Care and Cleaning

Use only the EDAN-approved substances and methods listed in this chapter to clean or disinfect your equipment. Warranty does not cover damage caused by using unapproved substances or methods.

EDAN Instruments has validated the cleaning and disinfection instructions included in this User Manual. It is the responsibility of the healthcare professional to ensure that the instructions are followed so as to ensure adequate cleaning and disinfection.

### 6.2.1 Safety Instructions

#### Reusable products

Reusable products must be reprocessed, otherwise there is an increased risk of infection.

- ▶ Follow the infection prevention policies and reprocessing regulations of the health-care facility.
- ▶ Follow the national infection prevention policies and reprocessing regulations.
- ▶ Use validated procedures for reprocessing.
- ▶ Reprocess reusable products after every use.
- ▶ Follow the manufacturer's instructions for cleaning agents, disinfectants, and reprocessing devices. Signs of wear, e.g., cracks, deformation, discoloration, or peeling, may occur with reprocessed products.
- ▶ Check the products for signs of wear and replace them if necessary.

#### Disposable products

Disposable products have been designed, tested, and manufactured exclusively for single use. Reuse, reprocessing, or sterilization can result in failure of the accessory, incorrect measurements, and injury to the patient.

- ▶ Do not reuse disposable products.
- ▶ Do not reprocess disposable products.
- ▶ Do not use any disinfectants.

### 6.2.2 General Points

Keep your main unit, cables and accessories free of dust and dirt. To prevent the device from damage, please follow the procedure:

- Use only recommended cleaning substances and disinfectants listed in this manual. Others may cause damage (not covered by warranty), reduce product lifetime or cause safety hazards.
- Always dilute according to the manufacturer's instructions.
- Unless otherwise specified, do not immerse any part of the equipment or any accessories in liquid.
- Do not pour liquid onto the system.

- Do not allow liquid to enter the case.
- Never use abrasive material (such as steel wool or silver polish).
- Inspect the system and reusable accessories after they are cleaned and disinfected.

---

---

**CAUTION**

**If you spill liquid on the equipment, battery, or accessories, or they are accidentally immersed in liquid, contact your service personnel or EDAN service engineer.**

---

---

**NOTE:**

**Automated cleaning/disinfection to the equipment and accessories is prohibited.**

### 6.2.3 Cleaning

If the equipment or accessory has been in contact with the patient, then cleaning and disinfection is required after each use. If there has been no patient contact and there is no visible contamination then daily cleaning and disinfection is appropriate.

The validated cleaning agents are:

- Ethanol (75%)
- Isopropanol (70%)

Cleaning agents should be applied or removed using a clean, soft, non-abrasive cloth or paper towel. Refer to the cleaning agent manufacturer's instruction for use with reference to concentration, temperature and contact time.

---

---

**WARNING**

**Make sure that the power is off and the power cords are disconnected prior to cleaning or disinfecting the device.**

---

---

---

---

**CAUTION**

**Any residue of cleaning solution should be removed from the main unit and accessories after cleaning.**

---

---

To clean the main unit:

1. Switch off the main unit and disconnect it from the power cord.
2. Wipe the exterior surface of the equipment using a soft cloth dampened with the cleaning solution until no visible contaminants remain.
3. Wipe off the cleaning solution with a fresh cloth or paper towel dampened with tap water after cleaning until no visible cleaning agent remains.
4. Dry the main unit in a ventilated and cool place.

To clean the sensor, probe and sensor cable:

1. Wipe them with a soft cloth dampened with the cleaning solution until no visible contaminants remain.
2. Wipe off the cleaning solution with a fresh cloth or paper towel dampened with tap water after cleaning until no visible cleaning agent remains.
3. Wipe off with a dry cloth to remove residual moisture.

4. Leave them to air dry.

## 6.2.4 Disinfecting

Clean the main unit and reusable accessories before they are disinfected. The validated disinfectants for disinfecting the main unit and reusable accessories are listed below.

Refer to the disinfecting agent manufacturer's instruction for use with reference to concentration, temperature and contact time.

Select a proper way to disinfect the main unit and accessories:

Type	Disinfecting Intensity	Disinfecting Method	Disinfectants
Vagina Sensor	HLD	Immersion	Cidex Glutaraldehyde(2.4%)
Stress Probe	HLD	Immersion	Cidex Glutaraldehyde(2.4%)
Rectum Sensor	HLD	Immersion	Cidex Glutaraldehyde(2.4%)
Main Unit	LLD	Wiping	Ethanol (75%)
Sensor Cable	LLD	Wiping	Ethanol (75%)
Note: LLD=Low-level Disinfection; HLD=High-level disinfection			

### **WARNING**

1. **Unplug the accessories from the system prior to cleaning or disinfecting.**
2. **To avoid infection, always use protective gloves when performing cleaning and disinfecting procedures.**
3. **To avoid infection, ensure that expiration date of the disinfecting solution has not passed.**

#### **Disinfecting by Immersion (vagina sensor, stress probe and rectum sensor):**

1. Disconnect the vagina sensor/stress probe/rectum sensor from the system.
2. Wear protective gloves to prevent infection.
3. Clean and dry the vagina sensor/stress probe/rectum sensor according to the methods in section 6.2.3 *Cleaning*.
4. Prepare the disinfectant solution (Cidex Glutaraldehyde 2.4%). Refer to the instructions provided by the disinfectant manufacturer for the concentration of the disinfection solution, method of dilution, method of disinfection, temperature and cautions during use.
5. Place the cleaned and dried vagina sensor/stress probe/rectum sensor in contact with the disinfectant for the time specified by the disinfectant manufacturer. For



example, the contact time recommended by the manufacturer for soaking in Cidex Glutaraldehyde (2.4%) is at least 45 min.

6. Rinse the vagina sensor/stress probe/rectum sensor thoroughly with sterile water to remove all chemical residues. For example, it is required to flush the sensor after soaking in Cidex Glutaraldehyde (2.4%) with plenty of sterile water (about 2 gallons) at least one time. Or, follow the complete rinsing instructions provided by the disinfectant manufacturer to rinse the vagina sensor/ stress probe/rectum sensor.
7. Wipe off the water on the vagina sensor/ stress probe/rectum sensor with a dry sterile cloth. Leave the vagina sensor/ stress probe/rectum sensor to air dry.
8. Inspect the vagina sensor/ stress probe/rectum sensor to ensure that there is no damage.

#### **Disinfecting by Wiping (main unit and sensor cable):**

1. Switch off the main unit and disconnect it from the power cord.
2. Wipe the exterior surface of the equipment and above mentioned accessories using a soft cloth dampened with the disinfectant solution.
3. Wipe off the disinfectant solution with a dry cloth after disinfection if necessary.
4. Dry the main unit and above mentioned accessories for at least 30 minutes in a ventilated and cool place.

---

### **WARNING**

---

- 1. Prohibit infiltration of any type of liquid into the device or accessories**
- 2. Do not immerse or soak any part of an accessory in any cleaning material not listed in the recommended list of disinfectant.**
- 3. Use the immersion method to disinfect the vagina sensor and stress probe.**
- 4. Only non-immersion method can be used with solution of ethanol. The solution concentration should not exceed the value provided above.**
- 5. The immersion time should not exceed the time that is specified by the disinfectant manufacturer. Do not use high-temperature, high-pressure vapour or ionizing radiation as disinfection methods.**
- 6. Do not use chloric disinfectant such as chloride, sodium hypochlorite etc.**

---

#### 6.2.5 After Reprocessing

- After reprocessing, the equipment, cables, sensors and other accessories should be checked to ensure there are no signs of aging, wear, cracks, deformation, discoloration or peeling, etc. Replacement should be taken or contact the service personal of the manufacturer if necessary.
- Assembling and attaching device-specific components

Prerequisite:

All components have been reprocessed and are dry.

- Preparation before next use of device

Assembling and fitting patient-specific accessories and consumables.

### 6.2.6 Storage and Transport

After reprocessing, there are no special requirements for storage and transport of the product. However, the following must be observed:

- Store dry and free of dust
- Avoid recontamination and damage during transport

All further information on storage and transport included in the accompanying documents must be observed.

# Chapter 7 Warranty and Service

## 7.1 Warranty

EDAN warrants that EDAN's products meet the labeled specifications of the products and will be free from defects in materials and workmanship that occur within warranty period.

The warranty is void in cases of:

- a) damage caused by mishandling during shipping.
- b) subsequent damage caused by improper use or maintenance.
- c) damage caused by alteration or repair by anyone not authorized by EDAN.
- d) damage caused by accidents.
- e) replacement or removal of serial number label and manufacture label.

If a product covered by this warranty is determined to be defective because of defective materials, components, or workmanship, and the warranty claim is made within the warranty period, EDAN will, at its discretion, repair or replace the defective part(s) free of charge. EDAN will not provide a substitute product for use when the defective product is being repaired.

## 7.2 Contact information

If you have any question about maintenance, technical specifications or malfunctions of devices, contact your local distributor.

Alternatively, you can send an email to EDAN service department at: [support@edan.com.cn](mailto:support@edan.com.cn).

# Appendix 1 Product Specifications

## NOTE:

Specifications of the system are shown in its accompany file.

## A1.1 Environmental Specifications

Working	Temperature:	0 °C ~ + 40 °C
	Relative Humidity:	15%RH ~ 95%RH (non-condensing)
	Atmospheric Pressure:	86kPa ~ 106kPa
Transport and Storage	Temperature:	-20 °C ~ +55 °C
	Relative Humidity:	15%RH ~ 95%RH (non-condensing)
	Atmospheric Pressure:	70kPa ~ 106kPa

## A1.2 Physical Specifications

Dimensions of the Main Unit	270mm*232mm*55mm±5mm
Weight of the Main Unit	≤3kg
AC Power Supply	Rated Voltage: 100V-240V~
	Rated Frequency: 50 Hz /60 Hz
	Input Current: 1.3A-0.5A
Standards Compliance	IEC 60601-1:2005/A1:2012, EN 60601-1: 2006+A1: 2013, IEC 60601-1-2:2014, EN 60601-1-2: 2015, IEC60601-2-10:2016, EN60601-2-10:2015/A1:2016 , IEC 60601-2-40:2016, EN 60601-2-40:2017
Anti-electric Shock Type	Class I equipment with internal power
Anti-electric Shock Degree	BF
Working System	Continuous operation equipment
Degree of Protection against Harmful Ingress of	Ordinary equipment (sealed equipment without liquid

Water	proof)
Degree of Safety in Presence of Flammable Gases	Equipment not suitable for use in presence of flammable gases
Disinfection/Sterilizing Method	Refer to this user manual for details
EMC	CISPR 11 Group 1 Class B

## A1.3 Performance Specifications

<b>EMG Parameters</b>	
Measurement Range	1uV ~3000uV
Accuracy	1μV ~20μV (±2μV) or 21μV ~3000μV (±10%)
Definition	≅ 0.2uV
Input Noise	≅ 1uV
Transmission Bands	Wider than 20Hz ~ 500Hz
Differential-mode Input Impedance	≅ 10MΩ
Common Mode Rejection Ratio	>100dB
Power Frequency Notch	50Hz/100μV (peak-valley), signal amplitude after attenuation ≤ 5μV (peak-valley)
<b>Electrical Stimulation Parameters</b>	
Frequency	0.5–999Hz (1Hz step, 0.5–20Hz (±2Hz) or 21–999Hz (±10%))
Pulse Width	50–1000μs (50μs step, ±20%)
Output Intensity	0-100mA (load is 500 Ω) (0-50mA (±5mA) or 51-100mA (±10%))
<b>Pelvic Floor Stress Parameters</b>	
Measurement Range	0-140mmHg(+5%or±1mmHg), whichever is greater
Measurement Definition	1 mmHg

## A1.4 Rechargeable Lithium-ion Battery

Type	Rechargeable Lithium-ion Battery
Continual Working Time	≥8 hours
Necessary charge time from "out of power" to "fully charged"	≤7 hours (stand by or power off status)
Necessary charge time from "out of power" to "90% charged"	≤6.5 hours (stand by or power off status)
Nominal Capacity	≥6000mAH
Nominal Voltage	14.4V
Cycle Life	≥500 times

## Appendix 2 Troubleshooting

### A2.1 Trouble with Starting Up

Phenomenon	Possible Cause	Solution
Abrupt switching off.	The power supply is faulty.	Replace the power supply.
	Power input is in poor contact.	Check the power input.
	The main control board is faulty.	Replace the main control board.
	The boot interface board is faulty.	Replace the boot interface board.

### A2.2 Trouble with Identifying U Disk or Other USB Device

Phenomenon	Possible Cause	Solution
U disk or other USB device cannot be identified.	The drive fails.	Replace the USB device or contact the service provider.
	The connecting cable is damaged.	Replace the connecting cable.
	The connecting cable is loose.	Tighten the connecting cable.
	The main control board is damaged.	Replace the board.

### A2.4 Unstable EMG Signal

Phenomenon	Possible Cause	Solution
Unstable EMG Signal	<ol style="list-style-type: none"> <li>The electrodes have been used for too many times and are dirty. The adhesion is poor, and polarization occurs.</li> <li>Patient's skin is dry and cracked, and there's so much scurf or hair on the skin that would lead to increase of skin impedance.</li> </ol>	Wipe the attached position and the surface of the electrodes with normal saline, or replace the electrodes.

	The device or power supply is not grounded.	Ground the device or the power supply.
	The patient is nervous or the position is wrong, and the actual EMG signal is higher.	Guide the patient to relax and adjust the position.
	The electrodes are not provided by EDAN. The contact of the electrode connector is so poor that leads to the change of skin impedance.	Use electrodes provided by EADN or electrodes that are suitable.
	There's high-power equipment that produces Signal interference	Change another room and keep away from the high-power equipment,

### A2.5 Falling Off Issue

Phenomenon	Possible Cause	Solution
Abdomen channel disconnected	<p>1. The electrodes have been used for too many times and are dirty. The adhesion is poor, and polarization occurs.</p> <p>2. Patient's skin is dry and cracked, and there's so much scurf or hair on the skin that would lead to increase of skin impedance.</p>	Wipe the attached position and the surface of the electrodes with normal saline, or replace the electrodes.
	The electrodes are not provided by EDAN. The contact of the electrode connector is so poor that leads to the change of skin impedance.	Use electrodes provided by EADN or electrodes that are suitable.
Pelvic channel disconnected	Vagina sensor or rectum sensor is very loose and the contact between the sensor and the vagina /rectum is poor.	Adjust the sensor in the vagina or rectum. Guide the patient to tighten the vagina or rectum and then check whether the prompt of falling off is closed.
	The electrodes are not provided by EDAN. The contact of the electrode connector is so poor that leads to the change of	Use electrodes provided by EADN or electrodes that are suitable.



	skin impedance.	
	The reference electrode is not well connected.	Check whether the reference electrode is well connected

## Appendix3 EMC Information

### A3.1 Electromagnetic Emissions

<b>Guidance and manufacture's declaration – electromagnetic emission</b>		
The <i>PA Biofeedback and Stimulation System</i> is intended for use in the electromagnetic environment specified below. The customer or the user of the <i>Biofeedback and Stimulation System</i> should assure that it is used in such an environment.		
<b>Emission test</b>	<b>Compliance</b>	<b>Electromagnetic environment – guidance</b>
<b>RF emissions CISPR 11</b>	<b>Group 1</b>	The <i>PA Biofeedback and Stimulation System</i> uses RF energy only for its internal function. Therefore, its RF emissions are very low and are not likely to cause any interference in nearby electronic equipment.
<b>RF emission CISPR 11</b>	<b>Class B</b>	The <i>PA Biofeedback and Stimulation System</i> is suitable for use in all establishments, other than domestic and those directly connected to the public low-voltage power supply network that supplies buildings used for domestic purposes.
<b>Harmonic emissions IEC 61000-3-2</b>	<b>Not Applied</b>	
<b>Voltage fluctuations/ flicker emissions IEC 61000-3-3</b>	<b>Not Applied</b>	

## A3.2 Electromagnetic Immunity

<b>Guidance and manufacture's declaration – electromagnetic immunity</b>			
The <i>PA Biofeedback and Stimulation system</i> is intended for use in the electromagnetic environment specified below. The customer or the user of the <i>PA Biofeedback and Stimulation System</i> should assure that it is used in such an environment.			
<b>Immunity test</b>	<b>IEC 60601 test level</b>	<b>Compliance level</b>	<b>Electromagnetic environment - guidance</b>
Electrostatic discharge (ESD) IEC 61000-4-2	±8 kV contact ±15 kV air	±8 kV contact ±15 kV air	Floors should be wood, concrete or ceramic tile. If floor are covered with synthetic material, the relative humidity should be at least 30%.
Electrical transient/burst IEC 61000-4-4	± 2 kV for power supply lines ± 1 kV for input/output lines	± 2kV for power supply lines Not Applicable	Mains power quality should be that of a typical commercial or hospital environment.
Surge IEC 61000-4-5	± 1 kV line(s) to line(s) ±2 kV line(s) to earth	± 1 kV line(s) to line(s) ±2 kV line(s) to earth	Mains power quality should be that of a typical commercial or hospital environment.
Power frequency (50Hz/60Hz) magnetic field IEC61000-4-8	30A/m	30 A/m	Power frequency magnetic fields should be at levels characteristic of a typical location in a typical commercial or hospital environment.

<p>Voltage dips, short interruptions and voltage variations on power supply input lines IEC 61000-4-11</p>	<p>0 % UT; 0,5 cycle At 0°, 45°, 90°, 135°, 180°, 225°, 270° and 315°  0 % UT; 1 cycle and 70 % UT; 25/30 cycles ) Single phase: at 0°  0 % UT; 250/300 cycle</p>	<p>0 % UT; 0,5 cycle At 0°, 45°, 90°, 135°, 180°, 225°, 270° and 315°  0 % UT; 1 cycle and 70 % UT; 25/30 cycles ) Single phase: at 0°  0 % UT; 250/300 cycle</p>	<p>Mains power quality should be that of a typical commercial or hospital environment. If the users of the <i>PA Biofeedback and Stimulation System</i> require continued operation during power mains interruptions, it is recommended that the <i>PA Biofeedback and Stimulation System</i> be powered from an uninterruptible power supply.</p>
--	---	---	--

**NOTE:** U<sub>T</sub> is the a.c. mains voltage prior to application of the test level.

### A3.3 Electromagnetic Immunity

<p><b>Guidance and manufacture’s declaration – electromagnetic immunity</b></p>			
<p>The <i>Biofeedback and Stimulation System</i> intended for use in the electromagnetic environment specified below. The customer or the user of the <i>Biofeedback and Stimulation System</i> should assure that it is used in such an environment.</p>			
Immunity test	IEC 60601 test level	Compliance level	Electromagnetic environment - guidance
			<p>Portable and mobile RF communications equipment should be used no closer to any part of the <i>PA Biofeedback and Stimulation System</i> including cables, than the recommended separation distance calculated from the equation applicable to the frequency of the transmitter.</p> <p><b>Recommended separation distance</b></p>

<p>Conducted RF IEC 61000-4-6</p>	<p>3 V<sub>rms</sub> 150 kHz to 80 MHz 6V<sub>rms</sub><sup>c)</sup>in ISM bands between 0,15 MHz and 80 MHz</p>	<p>3 V<sub>rms</sub> 150 kHz to 80 MHz 6V<sub>rms</sub><sup>c)</sup>in ISM bands between 0,15 MHz and 80 MHz</p>	<p><math>d = 1.2\sqrt{P}</math> 150 kHz to 80 MHz</p>
<p>Radiated RF IEC 61000-4-3</p>	<p>3 V/m 80 MHz to 2.7 GHz</p>	<p>3 V/m 80 MHz to 2.7 GHz</p>	<p><math>d = 1.2\sqrt{P}</math> 80 MHz to 800 MHz <math>d = 2.3\sqrt{P}</math> 800 MHz to 2.7 GHz</p> <p><math>d = 6\sqrt{P} / E</math> at RF wireless communications equipment bands (Portable RF communications equipment (including peripherals such as antenna cables and external antennas) should be used no closer than 30 cm (12 inches) to any part of the <i>Biofeedback and Stimulation System</i>, including cables specified by the manufacturer).</p> <p>Where <math>P</math> is the maximum output power rating of the transmitter in watts (W) according to the transmitter manufacturer and <math>d</math> is the recommended separation distance in meters (m).</p> <p>Field strengths from fixed RF transmitters, as determined by an electromagnetic site survey,<sup>a)</sup> should be less than the compliance level in each frequency range.<sup>b)</sup></p> <p>Interference may occur in the vicinity of equipment marked with the following symbol:</p> 

**NOTE 1:**At 80 MHz and 800 MHz, the higher frequency range applies.

**NOTE 2:**These guidelines may not apply in all situations. Electromagnetic propagation is affected by absorption and reflection from structures, objects and people.

a) Field strengths from fixed transmitters, such as base stations for radio (cellular/cordless) telephones and land mobile radios, amateur radio, AM and FM radio broadcast and TV broadcast cannot be predicted theoretically with accuracy. To assess the electromagnetic environment due to fixed RF transmitters, an electromagnetic site survey should be considered. If the measured field strength in the location in which the *PA Biofeedback and Stimulation System* is used exceeds the applicable RF compliance level above, the *PA Biofeedback and Stimulation System* should be observed to verify normal operation. If abnormal performance is observed, additional measures may be necessary, such as reorienting or relocating the *PA Biofeedback and Stimulation System*.

b) Over the frequency range 150 kHz to 80 MHz, field strengths should be less than 3 V/m.

c) The ISM (industrial, scientific and medical) bands between 0,15 MHz and 80 MHz are 6,765 MHz to 6,795 MHz; 13,553 MHz to 13,567 MHz; 26,957 MHz to 27,283 MHz; and 40,66 MHz to 40,70 MHz. The amateur radio bands between 0,15 MHz and 80 MHz are 1,8 MHz to 2,0 MHz, 3,5 MHz to 4,0 MHz, 5,3 MHz to 5,4 MHz, 7 MHz to 7,3 MHz, 10,1 MHz to 10,15 MHz, 14 MHz to 14,2 MHz, 18,07 MHz to 18,17 MHz, 21,0 MHz to 21,4 MHz, 24,89 MHz to 24,99 MHz, 28,0 MHz to 29,7 MHz and 50,0 MHz to 54,0 MHz.

**Table-Test specifications for ENCLOSURE PORT IMMUNITY to RF wireless communications equipment**

Test Frequency (MHz)	Brand (MHz) <sup>a)</sup>	Service <sup>a)</sup>	Modulation <sup>b)</sup>	Maximum Power(W)	Distance (m)	IMMUNITY TEST LEVEL (V/m)
385	380-390	TETRA 400	Pulse modulation <sup>b)</sup> 18Hz	1.8	0.3	27
450	430-470	GMRS 460, FRS 460	FM <sup>c)</sup> ±5 kHz deviation 1kHz sine	2	0.3	28
710	704-787	LTE Brand 13, 17	Pulse modulation <sup>b)</sup> 217 Hz	0.2	0.3	9
745						
780						
810	800-960	GSM 800/900,TETRA 800, iDEN 820, CDMA 850, LTE Band 5	Pulse modulation <sup>b)</sup> 18 Hz	2	0.3	28
870						
930						
1720	1700-1990	GSM 1800; CDMA 1900; GSM 1900; DECT; LTE Band 1, 3, 4,25; UMTS	Pulse modulation <sup>b)</sup> 217 Hz	2	0.3	28
1845						
1970						
2450	2400-2570	Bluetooth,	Pulse	2	0.3	28

		WLAN,802.11 b/g/n, RFID 2450, LTE Brand 7	modulation <sup>b)</sup> 217 Hz			
5240	5100-5800	WLAN 802.11 a/n	Pulse modulation <sup>b)</sup> 217 Hz	0.2	0.3	9
5500						
5785						

Note: If necessary to achieve the IMMUNITY TEST LEVEL, the distance between the transmitting antenna and the ME EQUIPMENT or ME SYSTEM maybe reduce to 1m. The 1 m test distance is permitted by IEC 61000-4-3.

- a) For some services, only the uplink frequencies are included.
- b) The carrier shall be modulated using a 50% duty cycle square wave signal.
- c) As an alternative FM modulation, 50% pulse modulation at 18 Hz may be used because while it does not represent actual modulation, it would be worst case

### A3.4 Recommended Separation Distances

**Recommended separation distances between  
portable and mobile RF communications equipment and the  
PA Biofeedback and Stimulation System**

The *PA Biofeedback and Stimulation System* is intended for use in an electromagnetic environment in which radiated RF disturbances are controlled. The customer or the user of the *Biofeedback and Stimulation System* can help prevent electromagnetic interference by maintaining a minimum distance between portable and mobile RF communications equipment (transmitters) and the *PA Biofeedback and Stimulation System* as recommended below, according to the maximum output power of the communications equipment.

Rated maximum output power of transmitter (W)	Separation distance according to frequency of transmitter (m)		
	150 kHz to 80 MHz $d = 1.2\sqrt{P}$	80 MHz to 800 MHz $d = 1.2\sqrt{P}$	800 MHz to 2.7 GHz $d = 2.3\sqrt{P}$
0.01	0.12	0.12	0.23
0.1	0.38	0.38	0.73
1	1.2	1.2	2.3
10	3.8	3.8	7.3
100	12	12	23

For transmitters rated at a maximum output power not listed above, the recommended separation distance  $d$  in meters (m) can be estimated using the equation applicable to the frequency of the transmitter, where  $P$  is the maximum output power rating of the transmitter in watts (W) according to the transmitter manufacturer.

**NOTE 1:** At 80 MHz and 800 MHz, the separation distance for the higher frequency range applies.

**NOTE 2:** These guidelines may not apply in all situations. Electromagnetic propagation is affected by absorption and reflection from structures, objects and people.



## Appendix 4 Ordering Information

### **CAUTION**

**Only the parts supplied by the manufacturer should be used with the system.**

<b>Part Number</b>	<b>Accessories</b>
01.57.472216	Sensor Cable (1.6 m, with 3 branches)
01.57.472178	Sensor Cable (1.8 m, with 3 branches)
01.57.472215	Sensor Cable (1.8 m, with 5 branches)
02.57.225123	Vagina Sensor SV1
02.57.225124	Vagina Sensor SV2
01.57.472020	EMG/Stimulation sensor
01.57.472022	Stress Probe

#### **NOTE:**

**The part name may vary depending on documents, but the part number is constant.**

P/N: 01.54.459103  
MPN: 01.54.459103011



**EDAN INSTRUMENTS, INC.**

#15 Jinhui Road, Jinsha Community, Kengzi Sub-District  
Pingshan District, 518122 Shenzhen, P.R.China

Email: [info@edan.com.cn](mailto:info@edan.com.cn)

TEL: +86-755-2689 8326 FAX: +86-755-2689 8330

Website: [www.edan.com.cn](http://www.edan.com.cn)

**EC REPRESENTATIVE**

Shanghai International Holding Corp. GmbH  
Eiffestrasse 80, 20537 Hamburg Germany

TEL: +49-40-2513175

E-mail: [shholding@hotmail.com](mailto:shholding@hotmail.com)