

Levana

MANUAL / MANUEL / MANUAL

Astra™

31006B



Digital Baby Video Monitor  
Moniteur vidéo bébé numérique  
Video Monitor Digital para Bebé



CAUTION: Keep small parts away from children.

ATTENTION: Gardez les petites pièces hors de la portée des enfants.

PRECAUCIÓN: Mantenga las piezas pequeñas fuera del alcance de los niños.

[mylevana.com](http://mylevana.com)

## SAFETY WARNINGS



**CAUTION: Keep small parts away from children.**



**Strangulation Hazard:** Children can become entangled in cords. Power cords should be kept more than 3 feet away from the crib and baby's reach at all times. Baby monitors and cameras with power cords should never be hung on or near the crib.



**This product is not a toy and should be kept out of children's reach.**



**This product contains small parts. Exercise care when unpacking and assembling the product.**



**Read and Keep Instructions:** All the safety and operating instructions should be read before the video baby monitor is operated.



**This product cannot replace responsible adult supervision.**



**Use only with provided power supply.**



**The socket-outlet shall be installed near the equipment and shall be easily accessible.**



**RISK OF EXPLOSION IF BATTERY IS REPLACED BY AN INCORRECT TYPE!**



**Dispose of used batteries according to the instructions.**



**Use only batteries/power supplies listed in the user manual.**

**Water and Moisture:** This product is designed for indoor use only. The unit should not be exposed to rain, moisture, dripping or splashing. No objects filled with liquid should be placed on top of, or beside the product, such as a glass or vase. This item should not be used near water.

**Non-Use Periods:** Always unplug the AC adapters from the wall outlets during long periods of non-use.

**Ventilation:** This baby monitor should not be used on a bed, sofa, rug or similar surface that may block the ventilation openings, or be placed in an enclosed area, such as a bookcase or drawer that may impede air flow.

**Keep Away from Sources of Heat:** This unit should not be exposed to direct heat sources such as a candle, fireplace, radiator, heat register, stove or other appliance that emits heat. The unit should not be left in direct sunlight.

**Power Source:** This unit should only be used with the AC power adapters included in this package (rated 5.9V 1A)

**Damage Requiring Service:** This unit should be serviced by qualified personnel only when:

- a. Objects have fallen or liquid has been spilled into the product
- b. The units have been exposed to rain
- c. The units do not appear to operate normally or exhibits a distinct change in performance
- d. The units have been dropped or the enclosure damaged

**FCC Caution:**

Any Changes or modifications not expressly approved by the party responsible for compliance could void the user's authority to operate the equipment.

This device complies with part 15 of the FCC Rules.

Operation is subject to the following two conditions:

- (1) This device may not cause harmful interference, and
- (2) this device must accept any interference received, including interference that may cause undesired operation.

**IMPORTANT NOTE:****FCC Radiation Exposure Statement:**

This equipment complies with FCC\IC radiation exposure limits set forth for an uncontrolled environment. This equipment should be installed and operated with minimum distance 20cm between the radiator & your body.

This transmitter must not be co-located or operating in conjunction with any other antenna or transmitter.

**IC Warning****RSS(Category I Equipment):**

This device complies with Industry Canada licence-exempt RSS standard(s). Operation is subject to the following two conditions:

- (1) this device may not cause interference, and
- (2) this device must accept any interference, including interference that may cause undesired operation of the device.

Le présent appareil est conforme aux CNR d'Industrie Canada applicables aux appareils radio exempts de licence.

L'exploitation est autorisée aux deux conditions suivantes:

- (1) l'appareil ne doit pas produire de brouillage, et
- (2) l'utilisateur de l'appareil doit accepter tout brouillage radioélectrique subi, même si le brouillage est susceptible d'en compromettre le fonctionnement.

Under industry Canada regulations, this radio transmitter may only operate using an antenna of a type and maximum (or lesser) gain approved for the transmitter by Industry Canada.

To reduce potential radio interference to other users, the antenna type and its gain should be so chosen that the equivalent isotropically radiated power (e.i.r.p.) is not more than that necessary for successful communication.

Conformément à la réglementation d'Industrie Canada, le présent émetteur radio peut fonctionner avec une antenne d'un type et d'un gain maximal (ou inférieur) approuvé pour l'émetteur par Industrie Canada.

Dans le but de réduire les risques de brouillage radioélectrique à l'intention des autres utilisateurs, il faut choisir le type d'antenne et son gain de sorte que la puissance isotrope rayonnée équivalente (p.i.r.e.) ne dépasse pas l'intensité nécessaire à l'établissement d'une communication satisfaisante.



Please visit our website at [www.myLEVANA.com](http://www.myLEVANA.com) for information about your product's warranty

We take quality very seriously. This is why all of our products come with a one-year warranty from the original purchase date against defects in workmanship and materials. If you have warranty or support issues please contact us using any of the following methods:

**Web:** [www.mylevana.com](http://www.mylevana.com)

**Support:** [www.mylevana.com/support](http://www.mylevana.com/support)

**LEVANA Canada**

4080 Montrose Road  
Niagara Falls, ON  
Canada L2H 1J9

**LEVANA USA**

60 Industrial Parkway #Z64  
Cheektowaga NY  
USA 14227

**Warranty Terms**

1. LEVANA® products are guaranteed for a period of one year from the date of purchase against defects in workmanship and materials. This warranty is limited to the repair, replacement or refund of the purchase price at LEVANA's option.
2. This warranty becomes void if the product shows evidence of having been misused, mishandled or tampered with contrary to the applicable instruction manual.
3. Routine cleaning, normal cosmetic and mechanical wear and tear are not covered under the terms of this warranty.
4. The warranty expressly provided for herein is the sole warranty provided in connection with the product itself and no other warranty, expressed or implied is provided. LEVANA assumes no responsibilities for any other claims not specifically mentioned in this warranty.
5. This warranty does not cover the shipping cost, insurance or any other incidental charges.
6. You MUST contact LEVANA at [www.mylevana.com/support](http://www.mylevana.com/support) before sending any product back for repair. You will be sent a Return Authorization form with return instructions. When returning the product for warranty service, please pack it carefully in the original box with all supplied accessories, and enclose your original receipt or copy, and a brief explanation of the problem (include RA #).
7. This warranty is valid only in Canada and the continental U.S.
8. This warranty cannot be re-issued.

# TABLE OF CONTENTS

- SAFETY INSTRUCTIONS ..... 2
- FCC STATEMENT ..... 3
- WARRANTY ..... 4
- WHAT'S INCLUDED ..... 6
- BUTTONS AND CONNECTIONS - MONITOR ..... 7
- BUTTONS AND CONNECTIONS - CAMERA ..... 8
- SETUP ..... 9
  - Battery installation ..... 9
  - Connecting Power to the Monitor / Charging Battery ..... 10
  - Connecting Power to the Camera ..... 10
  - Screen Icons ..... 11
- OPERATION ..... 12
  - Turn the Monitor ON / OFF ..... 12
  - Pairing the Cameras & Monitor ..... 12
  - Placement of the Monitor ..... 13
  - Placement of the Camera ..... 13
  - Mounting the Camera on a Tabletop Safely ..... 13
  - Mounting the Camera on a Wall Safely ..... 14
  - Night Vision ..... 15
  - Adjusting the Camera Angle ..... 15
  - Using the ZOOM Function ..... 15
  - Volume ..... 16
  - Using the Talk to Baby™ Two-Way Intercom ..... 16
  - Selecting a Lullaby ..... 16
  - Using PEEP Mode ..... 17
  - Changing the Camera View ..... 17
  - Setting the Brightness ..... 18
  - Sound Sensitivity Settings ..... 18
  - Contacting Customer Support ..... 19
- TROUBLESHOOTING ..... 20

## WHAT'S INCLUDED

- **Pan/Tilt/Zoom Night Vision Camera**
- **Baby Video Monitor**
- **Rechargeable Battery**
- **2 Power Adapters**
- **Mounting Hardware**
- **Instruction Manual**
- **1 Year Warranty**
- **Lifetime Live Customer Support**



This product is not a toy.

This product contains small parts. Exercise care when unpacking and assembling the product.

This product does not replace responsible adult supervision. Check on your child at regular intervals and make sure your monitor is always adequately charged.

LEVANA® does not endorse any LEVANA® products for illegal activities. Levana is not responsible or liable in any way for any damage, vandalism, theft or any other action that may occur while a LEVANA® product is in use by the purchaser.

We reserve the right to change models, configuration, or specifications without notice or liability. Product may not be exactly as shown.

©2012 LEVANA®. All rights reserved. LEVANA®, the LEVANA® logo, Astra™ and other LEVANA® marks may be registered. All other Trademarks are the property of their respective owners.

## MONITOR

- 1. LOCK / UNLOCK BUTTON**  
Disables ALL function buttons in the LOCK position
- 2. LCD SCREEN**
- 3. POWER ON/OFF**
- 4. POWER INPUT**
- 5. TALK TO BABY™**  
Press and hold to talk, release to listen
- 6. PAN / TILT / ZOOM BUTTON**
- 7. MENU**
- 8. MICROPHONE**
- 9. COLOR-CHANGING LED RING**  
Ring changes color with sound intensity
- 10. SELECTION / ZOOM BUTTON**
- 11. DIRECTIONAL ARROWS / VOLUME CONTROL**
- 12. ANTENNA**  
Extend to improve signal
- 13. TABLE STAND**
- 14. SPEAKER**
- 15. BATTERY COMPARTMENT**



## CAMERA



1. PTZ CAMERA
2. MICROPHONE
3. POWER LED
4. NIGHT VISION LIGHT SENSOR



5. ANTENNA
6. POWER INPUT
7. POWER ON/OFF
8. SPEAKER



## LET'S GET STARTED!

### Battery Installation

1. Gently remove the BATTERY COMPARTMENT COVER on the back of the monitor by sliding down.
2. Insert the battery; the battery connectors on the battery should line up with the connectors inside the battery compartment.
3. Slide the BATTERY COMPARTMENT COVER back into place.

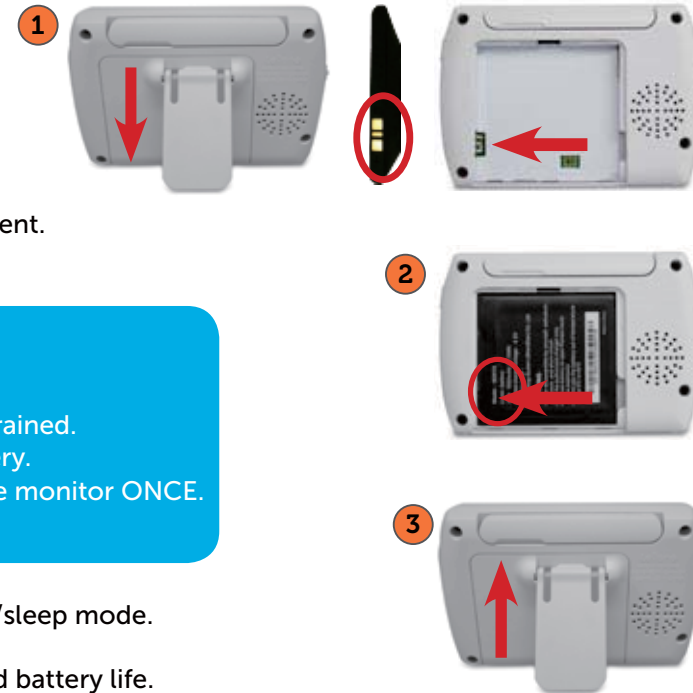

### Get the Most Out of Your Rechargeable Battery

1. Fully charge battery (4 hours) before first use.
2. To maximize battery life, charge battery before battery is fully drained.
3. Avoid extreme heat or cold as this will affect the life of the battery.
4. Turn LCD screen OFF; press POWER  button on the side of the monitor ONCE.
5. Astra™ menu settings that increase battery life:



 **PEEP Mode:** After 1 minute of inactivity, monitor enters standby/sleep mode.

 **Adjustable Brightness:** Decreasing screen brightness will extend battery life.

6. For extended periods of non-use, please remove battery from baby monitor.

## SETUP

### Connecting Power to the Monitor / Charging Battery



1. Connect the small end of power adapter marked MONITOR  into the DC input on the side of the monitor as shown in the diagram. Connect the other end of the adapter into an available wall outlet. For safety reasons, ONLY use the adapters included in the package.
2. **Press and hold** the POWER  button on the side of the monitor to turn the monitor ON.
3. The icon in the top right corner of the main screen will show you the **battery power status**.
4. The **LED Ring** on the front of the monitor also indicates the **battery power status**.

**SOLID BLUE** = BATTERY FULLY CHARGED    **SLOW FLASHING BLUE** = BATTERY CHARGING  
**QUICK FLASHING BLUE** = BATTERY LOW    **FLASHING PINK** = PAIRING UNSUCCESSFUL

5. For safety reasons, ONLY use the adapters included in the package.

EMPTY    CHARGING FULL  
 →

### Connecting Power to the Camera

1. Take the second power adapter and connect the small end of the power adapter marked CAMERA  into the DC input on the side of the camera base as shown in the diagram. For safety reasons, ONLY use the adapters included in the package.
2. On the side of the camera, slide the POWER switch  ● LEFT to the ON position. The **POWER LED** will light up.

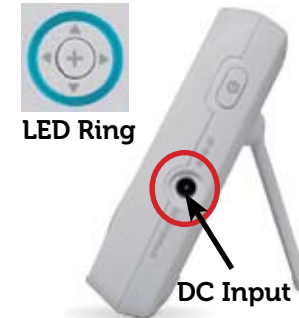

**Note:** Baby monitors and cameras with power cords should never be hung on or near the crib as it is a strangulation hazard. Power cords should be kept no less than 3 feet away from the crib and the baby's reach at all times.

# SCREEN ICONS

## SIGNAL STRENGTH

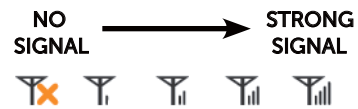

## BATTERY STRENGTH

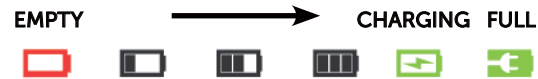

## PEEP MODE



## CAMERA

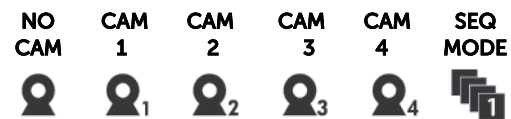

## PTZ / VPIZ / PTZ



## ZOOM



## TALK TO BABY™



## SUPPORT



## SOUND SENSITIVITY SETTING



## VOLUME



## BRIGHTNESS

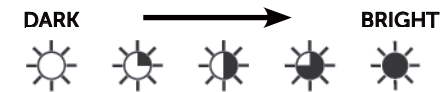

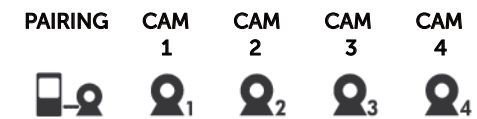

## PAIRING



## OPERATION

















### Turn the MONITOR ON/OFF

Press and hold the POWER  button on the side of the monitor to turn the monitor ON. Press and hold the POWER  button again to turn OFF the monitor.

### Pairing the Camera(s) and Monitor

The camera and monitor come paired (connected) to each other automatically. However, if upon opening this package the devices do not automatically connect and transmit, you may do so manually.

**Note:** Before you begin pairing, be sure to have the monitor and the camera(s) side by side.

1. To pair your camera and monitor, press the MENU  button. Using the navigational arrows   on the front of the monitor, highlight the PAIRING icon and press the SELECT  button once to select.
2. Use the navigational arrows   to highlight the the  icon.
3. Press the SELECT  button. When you see  flashing next to camera  icon, quickly press and hold the PAIRING  button on the BOTTOM of the camera. A checkmark  will appear next to camera , confirming pairing is successful. Video/audio will be transmitted automatically.
4. To pair additional cameras, repeat steps 1 to 3 and be sure to select camera number , , or  in the Pairing menu when pairing each additional camera.

✓ **ICONS ARE ORANGE WHEN SELECTED**

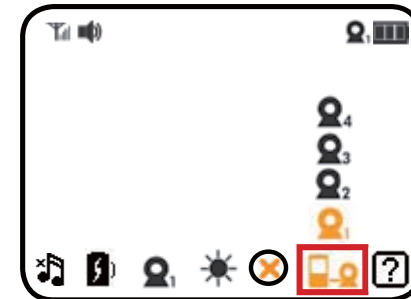

## OPERATION

### Placement of the Monitor

This monitor can be placed on a tabletop.

- You can place the monitor on a tabletop by using the retractable table stand on the back of the monitor. When not in use, simply tuck the table stand away into the back of the monitor until you hear a "click".



### Placement of the Camera

This camera can be placed on a tabletop or hung on the wall above the area being monitored.

- Place the camera within 15 feet of the area being monitored for best picture results.
- Do not place objects within 2 feet of the field of vision of the camera as the night vision will not activate correctly if objects are too close.

### Mounting the Camera on a Tabletop Safely:

1. Place the camera on a tabletop no less than 3 feet away from your baby's crib.
2. Feed the power cord down the back of the table or use wall clips (not included) to secure the cord away so the baby cannot reach it.
3. Plug in the power cord, check the monitor to ensure that you are getting a good view of your child and there are no obstructions.

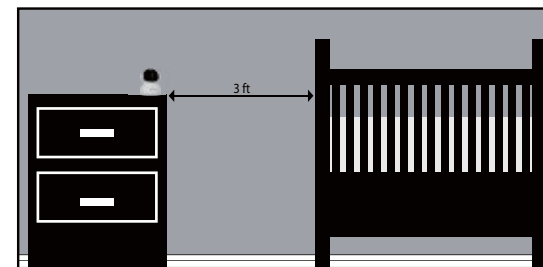

**Note:** Baby monitors and cameras with power cords should never be hung on or near the crib as it is a strangulation hazard. Power cords should be kept no less than 3 feet away from the crib and the baby's reach at all times.

## OPERATION

### Mounting the Camera on a Wall Safely:

Before drilling the holes, it is important to check the reception and camera positioning in the intended location on the wall. Ensure you are hanging the camera no less than 3 feet away from baby's crib.

**Note:** Baby monitors and cameras with power cords should never be hung on or near the crib as it is a strangulation hazard. Power cords should be kept no less than 3 feet away from the crib and the baby's reach at all times.

1. Pre-drill two holes in the wall using a 3/16", 4.8mm drill bit.
2. Insert the included wall anchors into each hole and tap gently with a hammer until the anchor is flush with the wall.
3. Insert a screw (included) into each wall anchor and tighten until the screws only stick out about a 1/2 inch.
4. Plug the power cord into the power input of the camera.
5. Locate the wall mounting holes on the bottom of the camera base.
6. Slide the holes over the screws sticking out of the wall.
7. Confirm that the camera is secure, if it is loose you may have to tighten the screws more.
8. Use wall clips (not included) to secure the power cord away from the crib or the baby's reach.
9. Connect the other end of the adapter into an available wall outlet.

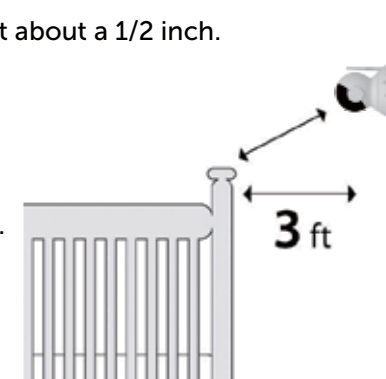



## OPERATION

### Night Vision

The camera is equipped with **NEW Invisible IR (infrared)** LEDs which keep the nursery dark. The LEDs are located on the front of the camera and allow you to see up to 12 feet in complete darkness so you can check on your baby at any time of night. The night vision LEDs will activate automatically when the **Light Sensor** on the side of the camera detects that the light levels are too low.

### Adjusting the Camera Angle - PTZ

The camera is equipped with Pan / Tilt / Zoom (PTZ). You can adjust the angle 300° degrees horizontal and 110° degrees vertical from the center position.

1. Press the  button on the front of the monitor.
2. Using the NAVIGATIONAL KEYS, move the camera to the desired position.
3. When set, press the  button again.

### Using the ZOOM Function

In **LIVE VIEW** mode, press the SELECT (+) button. To return to normal view, press the SELECT (+) button again.

INVISIBLE  
LEDs



NAVIGATIONAL  
KEYS



CENTER POSITION

## OPERATION

### Volume

Use the navigational arrows ◀▶ to increase /decrease /mute the VOLUME.

- Press the ▶ button to INCREASE the volume in LIVE VIEW; the VOLUME icon 🔊 will display the volume level in the top left corner of the screen.
- Press the ◀ button to DECREASE the volume; to MUTE, decrease the volume until the 🔊✖ icon appears in the top left corner of the screen.

**Note:** Placing the monitor and camera too close together will create feedback. DECREASE or MUTE the volume and move the camera away from the monitor.

### Using the Talk to Baby™ Two-Way Intercom

With the simple press of a button you can talk to your child at any time without entering the nursery.

1. To talk, press and hold the 🗣️ button on the front of the monitor and release to listen.
2. To talk when using multiple cameras, select the camera in the MENU and press the 🗣️ button, release to listen.

### Setting a lullaby

Choose from three different lullabies to soothe your baby to sleep.



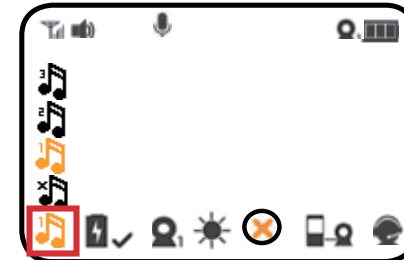
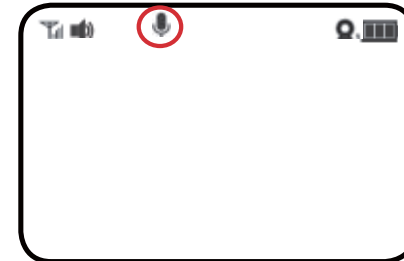
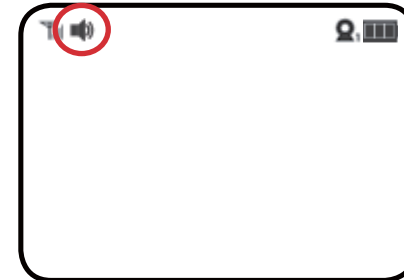







1. To select a lullaby, press the MENU ⬆️ button. Using the navigational arrows ◀▶ on the front of the monitor, highlight the LULLABY icon.
2. Use the ▲▼ to toggle to select the LULLABY icon of your choice and press the SELECT ⊕ button once to select.
3. To turn OFF the lullabies, select the 🎵 and press the ⊕ button once to select.











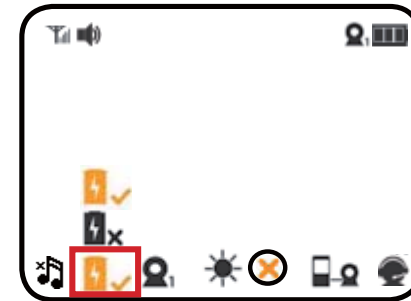



## Using PEEP Mode

When in **PEEP Mode**, the monitor enters standby/sleep mode after 1 minute of inactivity. When sound is detected, the screen changes to live view.

- To access live view manually when the screen is off, press the POWER  button ONCE.
  - **PEEP Mode** extends the battery life over 48 hours.
1. To set **PEEP Mode**, press the MENU  button. Using the navigational arrows   on the front of the monitor, highlight the PEEP Mode icon .
  2. Use the   to toggle to the  icon and press the SELECT  button once to select.
  3. To return to continuous live view, press the MENU  button.



## Changing the Camera View



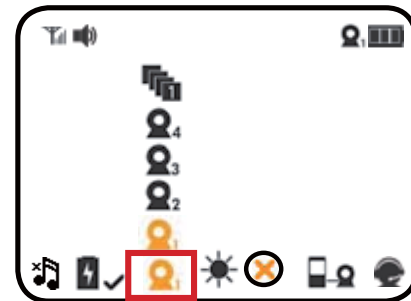



1. To change the camera view, press the MENU  button. Using the navigational arrows   on the front of the monitor, highlight the CAMERA icon.
2. Use the   to toggle to select the CAMERA icon of your choice and press the SELECT  button once to select.
3. Select  to cycle through cameras 1 through 4 and press the SELECT  button once to select.
4. To return to continuous live view, press the MENU  button.



## OPERATION

### Setting the Brightness





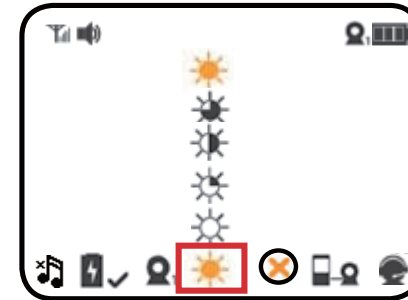

**Brightness Mode** sets the brightness of the the screen. **Brightness Mode** also extends the battery life.

1. To set the **Brightness Mode**, press the MENU  button. Using the navigational arrows   on the front of the monitor, highlight the BRIGHTNESS icon.
2. Use the   to toggle to the your desired brightness and press the SELECT  button once to select.



### Sound Sensitivity Settings

**Sensitivity Mode** allows you to adjust the sensitivity of the sound the that the camera picks up.

1. To set the **Sensitivity Mode**, press the MENU  button. Using the navigational arrows   on the front of the monitor, highlight the SENSITIVITY icon.
2. Use the   to toggle to the your desired sensitivity and press the SELECT  button once to select.
3. The **LED Ring** on the front of the monitor also indicates how loud the sound in the room is with colors.

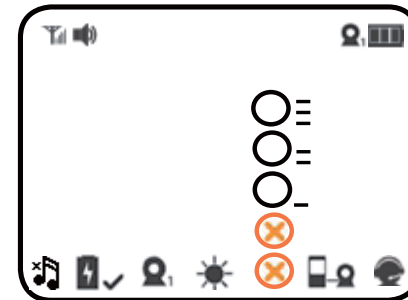

### SOUND SENSITIVITY SETTING









### SOUND SENSITIVITY COLORS



### Contacting Customer Support

**Customer Support** is just a click away whenever you need it! Our customer support team can be reached by live web chat or on our website at [www.mylevana.com/support](http://www.mylevana.com/support). Our experts will be happy to assist you in English, French and Spanish.

1. To access **Customer Support**, press the MENU  button. Using the navigational arrows   on the front of the monitor, highlight the SUPPORT  icon press the SELECT  button once to select.
2. This will take you to the screen which displays our **Customer Support** information. Press the MENU  button once to EXIT the **Customer Support** screen.

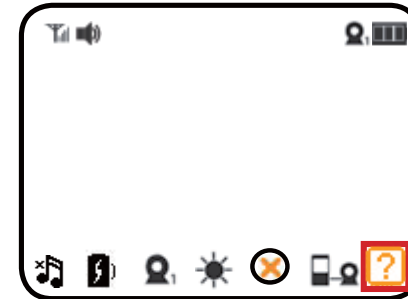

Support: [www.mylevana.com/support](http://www.mylevana.com/support)  
Web: [www.mylevana.com](http://www.mylevana.com)  
Online Live Web Chat: [www.mylevana.com](http://www.mylevana.com)

## TROUBLESHOOTING

ISSUE	POSSIBLE SOLUTION
Equipment does not function	<ul style="list-style-type: none"> <li>• Confirm that the camera and monitor are ON</li> <li>• The battery may be depleted; charge battery</li> <li>• The power adapters may not be properly connected</li> </ul>
No reception	<ul style="list-style-type: none"> <li>• Camera and monitor may not be properly paired; follow PAIRING instructions</li> <li>• Camera may be too far away from the monitor</li> <li>• Extend the antenna on the monitor</li> </ul>
Reception Interference (static)	<ul style="list-style-type: none"> <li>• The camera and monitor may be too far apart</li> <li>• The battery power may be too low</li> <li>• Other electronic devices may be interfering with the signal</li> <li>• The camera or monitor may be placed too close to many metal objects</li> </ul>
Feedback (screeching, static)	<ul style="list-style-type: none"> <li>• The camera and monitor may be too close together</li> <li>• The volume on the monitor may be set too high</li> </ul>
Noise (static, beeping)	<ul style="list-style-type: none"> <li>• Battery power may be too low</li> </ul>
The buttons are not working	<ul style="list-style-type: none"> <li>• LOCK/UNLOCK Button is in LOCKED position; move to UNLOCK position</li> </ul>
Picture works but there is no sound	<ul style="list-style-type: none"> <li>• Volume setting may be too low</li> </ul>
Picture is black and white	<ul style="list-style-type: none"> <li>• Night vision LEDs may be ON; increase the amount of light in the room being monitored</li> </ul>
The rechargeable battery will not charge	<ul style="list-style-type: none"> <li>• The power adapters may not be connected</li> <li>• Battery pack may not be properly connected inside the battery compartment</li> </ul>

### Maintenance

- Clean the surfaces of the camera and monitor with a soft, fluff-free cloth
- If the units become dirty, use a lightly damp cloth to wipe surfaces, taking care to not allow water into any openings
- Never use cleaning agents or solvents

## SPECIFICATIONS

MONITOR		MONITOR	
Monitor Type	TFT LCD	Talk to Baby	Yes
Screen Size	3.5"	Lullabies	Yes
Resolution	320x240	Battery Type	Li-Ion
Frame Rate	25 FPS	Battery Capacity	1800 mAH
LCD Brightness	Adjustable: 0,1,2,3,4	Battery Connection	Charging Contact
Frequency	2.4GHz	Battery Life (video + audio on)	10 hours
Private Signal	Yes	Battery Life (LCD off)	10 hours
Technology	Digital FHSS	Battery Life (PEEP Mode)	Up to 48 hours
No. of hop/sec	300	Battery Low - Visual Warning	Yes
No. of hopping channels	19	Battery Low - Audible Warning	Yes
Channel bandwidth	3.375 MHz	PEEP Mode (Power Save):	Yes
Data Rate	3 Mbps	Volume Indicator LED	Yes
Transmission Power	+13 dBm	Key Lock	Yes
Max Transmission Range	750ft	Housing Material	ABS Plastic
Optimum Transmission Range	200ft	Power Adapter Input	100~240VAC
Expandable	Up to 4 Cameras	Power Adapter	6V 800mA DC
Zoom	2x	Limited charge voltage	4.2V
Scan View	Yes, 8 seconds/camera	Operating Temperature	0 to 50 Degrees Celsius
Speaker	Yes	Dimensions	4 1/2 " x 1" x 3 1/4"
Microphone	Yes	Weight	0.35 lbs

## SPECIFICATIONS

CAMERA		CAMERA	
Image sensor	CMOS	Housing Material	ABS Plastic
Resolution	640 x 480	Wall Mountable	Yes
Viewing Angle	50 Degree	Power Adapter Input	100~240VAC, 50/60Hz 150mA
Focal Length	2.8mm	Power Adapter	6V 800mA DC
Optimal Focal Distance	2-10ft	Operating Temperature	0 to 50 Degree Celsius
PTZ	Yes	Dimensions	3 1/2 "x 4" x 4 1/2"
Range of Motion - Horizontal	300	Weight	0.55 lbs
Range of Motion - Vertical	110		
Frequency	2.4GHz	<b>FCC</b>	
		FCC ID: SMH32008B	
Technology	Digital FHSS		
Max Transmission Range	750ft		
Optimum Transmission Range	200ft	<b>IC</b>	
Number of IR LEDs	8	IC: 4593A-32008B	
IR Wavelength	940nm		
Night Vision Distance	15ft		
Battery Operable	No		
Microphone	Yes		
Speaker	Yes		