

Levana

Jena™

MANUAL
MANUEL
MANUAL



Digital Baby Video Monitor
Moniteur vidéo bébé numérique
Video Monitor Digital para Bebé



CAUTION: Keep small parts away from children.

ATTENTION: Gardez les petites pièces hors de la portée des enfants.

PRECAUCIÓN: Mantenga las piezas pequeñas fuera del alcance de los niños.

SAFETY WARNINGS



CAUTION: Keep small parts away from children.



Strangulation Hazard: Children can become entangled in cords. Power cords should be kept more than 3 feet away from the crib and baby's reach at all times. Baby monitors and cameras with power cords should never be hung on or near the crib.



This product is not a toy and should be kept out of children's reach.



This product contains small parts. Exercise care when unpacking and assembling the product.



Read and Keep Instructions: All the safety and operating instructions should be read before the video baby monitor is operated.

Water and Moisture: This product is designed for indoor use only. The unit should not be exposed to rain, moisture, dripping or splashing. No objects filled with liquid should be placed on top of, or beside the product, such as a glass or vase. This item should not be used near water.

Non-Use Periods: Always unplug the AC adapters from the wall outlets during long periods of non-use.

Ventilation: This baby monitor should not be used on a bed, sofa, rug or similar surface that may block the ventilation openings, or be placed in an enclosed area, such as a bookcase or drawer that may impede air flow.

Keep Away from Sources of Heat: This unit should not be exposed to direct heat sources such as a candle, fireplace, radiator, heat register, stove or other appliance that emits heat. The unit should not be left in direct sunlight.

Power Source: This unit should only be used with the power adapters included in this package (rated 6V DC)

Damage Requiring Service: This unit should be serviced by qualified personnel only when:

- a. Objects have fallen or liquid has been spilled into the product
- b. The units have been exposed to rain
- c. The units do not appear to operate normally or exhibits a distinct change in performance
- d. The units have been dropped or the enclosure damaged



This product cannot replace responsible adult supervision.



Use only with provided power supply.



The socket-outlet shall be installed near the equipment and shall be easily accessible.



RISK OF EXPLOSION IF BATTERY IS REPLACED BY AN INCORRECT TYPE!



Dispose of used batteries according to the instructions.



Use only batteries/power supplies listed in the user manual.

FCC STATEMENT

This device complies with part 15 of the FCC Rules. Operation is subject to the following two conditions:

- (1) This device may not cause harmful interference.
- (2) This device must accept any interference received, including interference that may cause undesired operation.

FCC WARNING

This equipment has been tested and found to comply with the limits for a Class B digital device, pursuant to Part 15 of the FCC Rules. These limits are designed to provide reasonable protection against harmful interference in a residential installation.

This equipment generates, uses and can radiate radio frequency energy and, if not installed and used in accordance with the instructions, may cause harmful interference to radio communications. However, there is no guarantee that interference will not occur in a particular installation. If this equipment does cause harmful interference to radio or television reception, which can be determined by turning the equipment off and on, the user is encouraged to try to correct the interference by one or more of the following measures:

- Reorient or relocate the receiving antenna.
- Increase the separation between the equipment and the receiver.
- Connect the equipment into an outlet different from that to which the receiver is connected.
- Consult the dealer or an experienced radio/TV technician for help.

Any Changes or modifications not expressly approved by the party responsible for compliance could void the user's authority to operate the equipment.

IMPORTANT NOTE:

FCC Radiation Exposure Statement:

This equipment complies with FCC radiation exposure limits set forth for an uncontrolled environment. This equipment should be installed and operated with minimum distance 20cm between the baby unit & your body.

This transmitter must not be co-located or operating in conjunction with any other antenna or transmitter.

IC STATEMENT / DÉCLARATION IC:

This Class B digital apparatus complies with ICES-003. / Cet appareil numérique de la classe B est conforme à la norme NMB-003 du Canada.

This device complies with Industry Canada licence-exempt RSS 210 standard(s). Operation is subject to the following two conditions: (1) this device may not cause interference, and (2) this device must accept any interference, including interference that may cause undesired operation of the device.

Le présent appareil est conforme aux CNR 210 d'Industrie Canada applicables aux appareils radio exempts de licence. L'exploitation est autorisée aux deux conditions suivantes : (1) l'appareil ne doit pas produire de brouillage, et (2) l'utilisateur de l'appareil doit accepter tout brouillage radioélectrique subi, même si le brouillage est susceptible d'en compromettre le fonctionnement.

Changes or modifications not expressly approved by the party responsible for compliance could void the user's authority to operate the equipment.

Under Industry Canada regulations, this radio transmitter may only operate using an antenna of a type and maximum (or lesser) gain approved for the transmitter by Industry Canada. To reduce potential radio interference to other users, the antenna type and its gain should be so chosen that the equivalent isotropically radiated power (e.i.r.p.) is not more than that necessary for successful communication.

Conformément à la réglementation d'Industrie Canada, le présent émetteur radio peut fonctionner avec une antenne d'un type et d'un gain maximal (ou inférieur) approuvé pour l'émetteur par Industrie Canada. Dans le but de réduire les risques de brouillage radioélectrique à l'intention des autres utilisateurs, il faut choisir le type d'antenne et son gain de sorte que la puissance isotrope rayonnée équivalente (p.i.r.e.) ne dépasse pas l'intensité nécessaire à l'établissement d'une communication satisfaisante.

We take quality very seriously. This is why all of our products come with a one-year warranty from the original purchase date against defects in workmanship and materials. If you have warranty or support issues please contact us using any of the following methods:

Web: www.mylevana.com

Support: www.mylevana.com/support

LEVANA Canada

4080 Montrose Road
Niagara Falls, ON
Canada L2H 1J9

LEVANA USA

60 Industrial Parkway #Z64
Cheektowaga NY
USA 14227

Warranty Terms

1. LEVANA® products are guaranteed for a period of one year from the date of purchase against defects in workmanship and materials. This warranty is limited to the repair, replacement or refund of the purchase price at LEVANA's option.
2. This warranty becomes void if the product shows evidence of having been misused, mishandled or tampered with contrary to the applicable instruction manual.
3. Routine cleaning, normal cosmetic and mechanical wear and tear are not covered under the terms of this warranty.
4. The warranty expressly provided for herein is the sole warranty provided in connection with the product itself and no other warranty, expressed or implied is provided. LEVANA assumes no responsibilities for any other claims not specifically mentioned in this warranty.
5. This warranty does not cover the shipping cost, insurance or any other incidental charges.
6. You **MUST** contact LEVANA at www.mylevana.com/support before sending any product back for repair. You will be sent a Return Authorization form with return instructions. When returning the product for warranty service, please pack it carefully in the original box with all supplied accessories, and enclose your original receipt or copy, and a brief explanation of the problem (include RA #).
7. This warranty is valid only in Canada and the continental U.S.
8. This warranty cannot be re-issued.

TABLE OF CONTENTS

SAFETY INSTRUCTIONS	2
FCC STATEMENT.....	3
WARRANTY	4
WHAT'S INCLUDED	6
BUTTONS AND CONNECTIONS - MONITOR.....	7
BUTTONS AND CONNECTIONS - CAMERA.....	8
SETUP.....	9
Battery installation - monitor.....	9
Battery installation - camera.....	9
Get the Most Out of Your Rechargeable Battery.....	9
Connecting Power to the Monitor / Charging Battery.....	10
Connecting Power to the Camera	10
SCREEN ICONS	11
OPERATION	12
Turn the Monitor ON / OFF.....	12
Pairing the Cameras & Monitor.....	12
Placement of the Monitor.....	13
Placement of the Camera	13
Mounting the Camera on a Tabletop Safely	13
Mounting the Camera on a Wall Safely	14
Night Vision.....	15
Using Pan/Tilt.....	15
Using the ZOOM Function	15
Volume.....	16
Using the Talk to Baby™ Two-Way Intercom.....	16
Selecting a Lullaby.....	17
Manual Screen OFF	17
Changing the Camera View.....	17
Setting the Brightness.....	18
Using VOX (PEEP) Mode.....	18
Temperature Settings.....	19
TROUBLESHOOTING.....	20
MAINTENANCE	20

WHAT'S INCLUDED

- Baby Video Monitor
- Night Vision Camera
- Rechargeable Lithium Ion Battery
- 2 Power Adapters
- Charging Base for Monitor
- Quick Start Guide
- 1 Year Warranty
- Lifetime Customer Support



This product is not a toy. This product contains small parts. Exercise care when unpacking and assembling the product.

Battery life of 8 hours based on full duration testing. Battery life may vary depending on usage.

Night vision range up to 15ft under ideal conditions. Objects at or beyond this range may be partially or completely obscured, depending on the camera application. Optimum range is 150ft when signal is passing through walls or floors. Microwave ovens (when in use) may cause signal disruption at close range. Buildings with metal frames may also cause signal disruption. Maximum transmission range is 500 feet.

This product does not replace responsible adult supervision. Check on your child at regular intervals and make sure your monitor is always adequately charged.

Strangulation Hazard: Children can become entangled in cords. Power cords should be kept more than 3 feet away from the crib and baby's reach at all times. Baby monitors/cameras with power cords should never be hung on or near the crib.

We reserve the right to change models, configuration, or specifications without notice or liability. Product may not be exactly as shown.

©2013 LEVANA®. All rights reserved. LEVANA®, the LEVANA® logo, Jena™ and other LEVANA® marks may be registered. All other Trademarks are the property of their respective owners.

MONITOR

- 1. ANTENNA**
Transmits and receives signals
- 2. VOLUME LEDS**
Indicates the amount of sound being heard by the camera
- 3. 2.4" SCREEN**
- 4. POWER/SCREEN ON-OFF**
- 5. MENU/ZOOM BUTTON**
- 6. BELT CLIP/TABLE STAND**
- 7. PAIRING BUTTON**
- 8. Power LED**
Green when monitor has power
- 9. MICROPHONE**
Captures the sound of your voice when using Talk to Baby™
- 10. BATTERY COMPARTMENT**
- 11. VOLUME +**
Increases the volume through the speaker

- 12. VOLUME -**
Decreases the volume through the speaker
- 13. TALK TO BABY™**
Press and hold to talk, release to listen
- 14. LULLABIES**
5 Remote-controlled lullabies to choose from
- 15. PAIRING LED**
Flashes red quickly when pairing
- 16. SPEAKER**
- 17. CHARGING BASE**

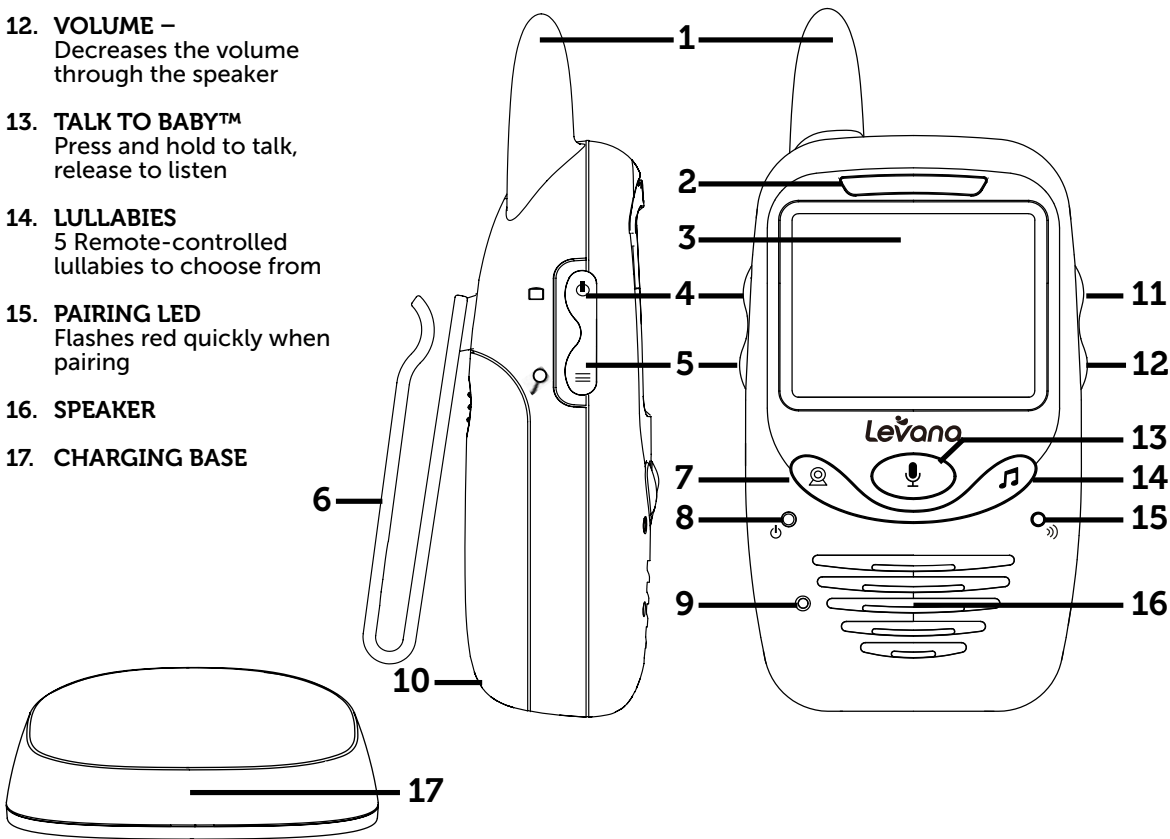

CAMERA

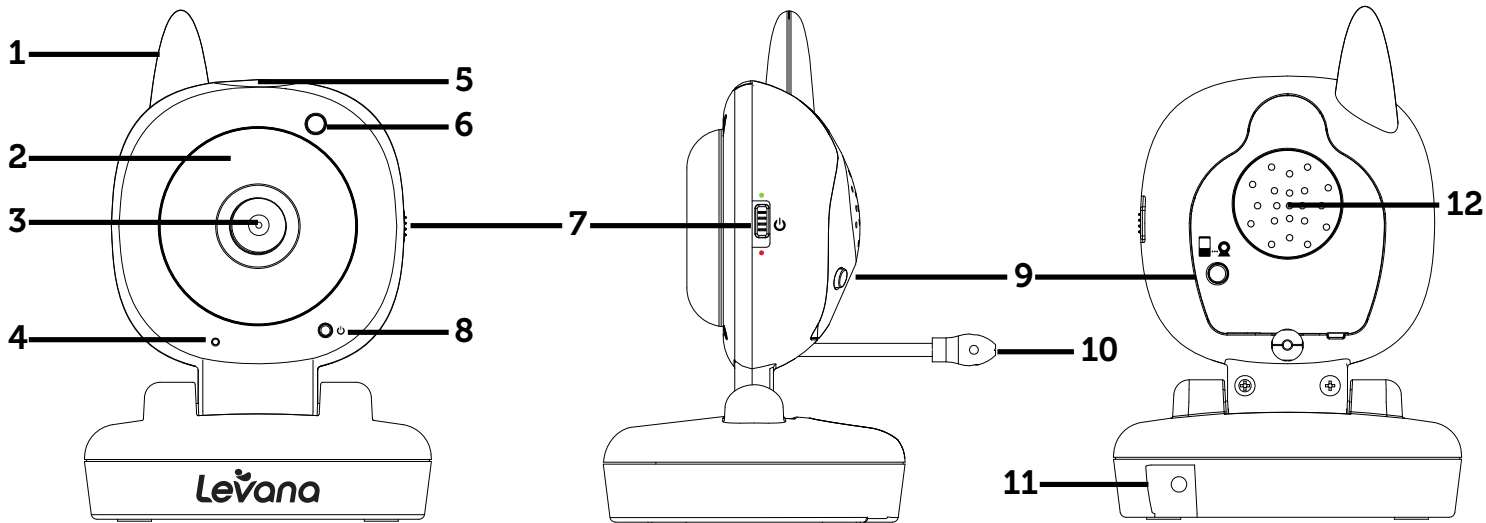

- 1. ANTENNA
- 2. NIGHT VISION LEDs
- 3. CAMERA LENS
- 4. MICROPHONE

- 5. NIGHTLIGHT
- 6. NIGHT VISION LIGHT SENSOR
- 7. ON/OFF BUTTON
- 8. POWER LED

- 9. PAIRING BUTTON
- 10. TEMPERATURE SENSOR
- 11. POWER INPUT
- 12. SPEAKER

SETUP

Battery Installation - Monitor

1. Gently remove the BATTERY COMPARTMENT COVER on the back of the monitor by sliding down.
2. Insert the included rechargeable battery, plug the battery cord into the small jack on the inside of the battery compartment.
3. Slide the BATTERY COMPARTMENT COVER back into place.
4. For extended periods of non-use, please remove battery from baby monitor.

Battery Installation - Camera

The camera unit can be powered using 4 AAA batteries instead of the included adapter

1. Gently remove the BATTERY COMPARTMENT COVER on the bottom of the camera base, using a small phillips (cross) head screwdriver.
2. Insert 4 AAA batteries in the compartment (not included), paying close attention to the labelled polarity markings.
3. Replace the battery compartment cover using the small screwdriver.
4. The POWER LED will flash when the battery charge is low.

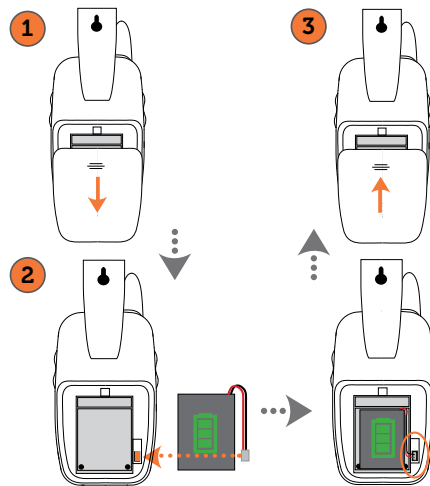
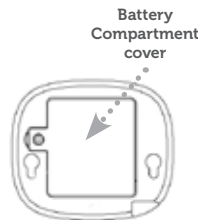

Get the Most Out of Your Rechargeable Battery



Fully charge battery (4 hours) before first use.



To maximize battery life, charge battery before battery is fully drained.



Avoid extreme heat or cold as this will affect the life of the battery.



Turn LCD screen OFF; press POWER  button on the side of the monitor ONCE.

VOX



PEEP Mode: After 1 minute of inactivity, monitor enters standby/sleep mode (when activated).



Adjustable Brightness: Decreasing screen brightness will extend battery life.

SETUP

Connecting Power to the Monitor / Charging Battery

1. Connect the power adapter attached to the charging dock marked **MONITOR**  into an available wall outlet. For safety reasons, **ONLY** use the adapters included in the package.
2. With the battery in the monitor, place the monitor into the charging dock with the screen facing you.
3. **Press and hold** the **POWER**  button on the side of the monitor to turn the monitor **ON**.
4. The icon in the top right corner of the main screen will show you the **battery power status**.

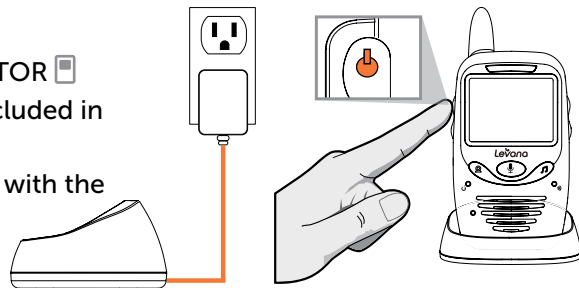



EMPTY  CHARGING FULL



Note: When monitor battery is low, **POWER LED** will flash slowly & beep. Recharging the battery will be required shortly after.

Connecting Power to the Camera

1. Take the second power adapter and connect the small end of the power adapter marked **CAMERA**  into the DC input on the side of the camera base as shown in the diagram. For safety reasons, **ONLY** use the adapters included in the package.
2. On the side of the camera, slide the **POWER** switch   LEFT to the **ON** position. The **POWER LED** will light up.

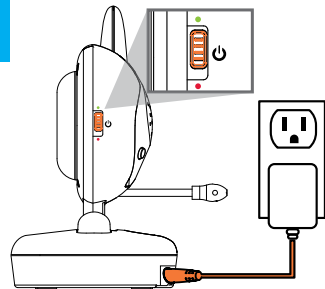

Note: Baby monitors and cameras with power cords should never be hung on or near the crib as it is a strangulation hazard. Power cords should be kept no less than 3 feet away from the crib and the baby's reach at all times.

SCREEN ICONS

SIGNAL STRENGTH

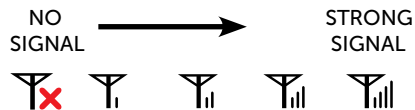

PAN/TILT

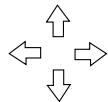

TALK TO BABY™



BATTERY STRENGTH



TEMPERATURE

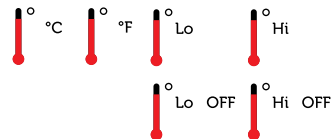

ZOOM



CAMERA VIEW

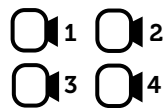

NIGHTLIGHT



LULLABIES



PEEP MODE

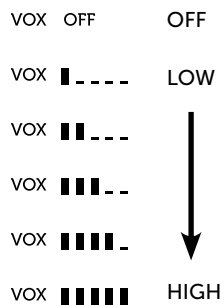

BRIGHTNESS

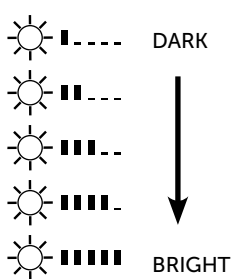

VOLUME

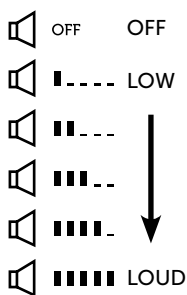

PAIRING

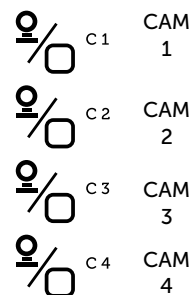

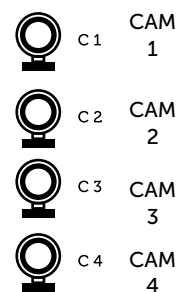

CAMERA



OPERATION

Turn the MONITOR ON/OFF





- Press and hold the POWER  button on the side of the monitor to turn the monitor ON.
- Press and hold the POWER  button again to turn OFF the monitor.



Pairing the Camera(s) and Monitor

The camera and monitor come paired (connected) to each other automatically. However, if upon opening this package the devices do not automatically connect and transmit, you may do so manually. To pair additional cameras, follow the steps below and be sure to assign a different camera number to each additional camera.

Note: Before you begin pairing, be sure to have the monitor and the camera(s) side by side.

1. To pair your camera and monitor, press and hold the  button on the monitor. Use the  VOLUME arrows (side) to select a camera number.
2. Press the  button ONCE. The PAIRING LED flashes red quickly (on monitor).
3. Quickly press and hold the PAIRING  button on the BACK of the camera. A checkmark  will appear next to the paired camera confirming pairing is successful. Video/audio will be transmitted automatically.

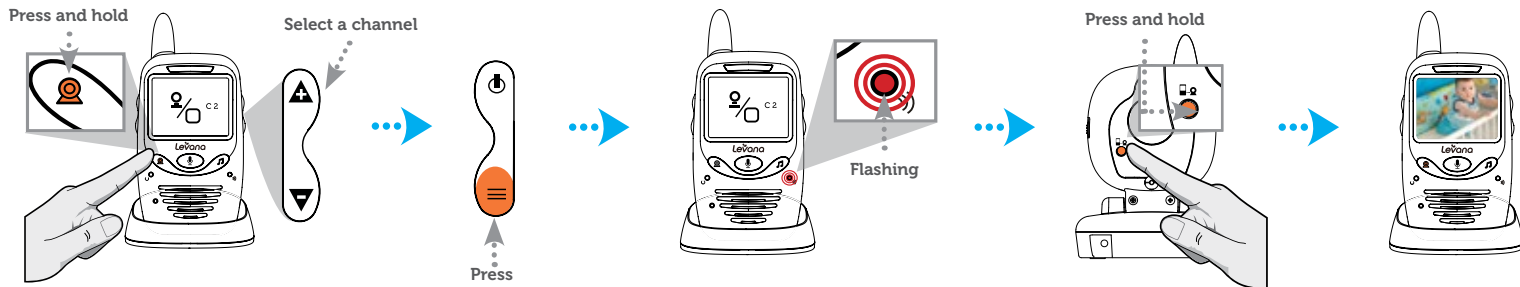

OPERATION

Placement of the Monitor

The monitor can be used three different ways; placed on a tabletop, attached to your belt or mounted on the wall.

- Set up the monitor on a tabletop by turning the belt clip DOWN and use the clip as a support stand.
- Carry the monitor on your belt by turning the belt clip UP on the back of the monitor and slide the clip over your belt.
- Hang the monitor from a screw on the wall using the screw mounting hole in the belt clip.

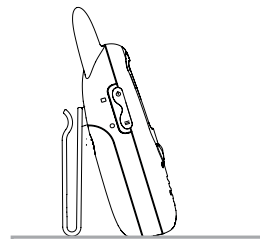

Placement of the Camera

This camera can be placed on a tabletop or hung on the wall above the area being monitored.

- Place the camera within 15 feet of the area being monitored for best picture results.
- Do not place objects within 2 feet of the field of vision of the camera as the night vision will not activate correctly if objects are too close.

Mounting the Camera on a Tabletop Safely:

1. Place the camera on a tabletop no less than 3 feet away from your baby's crib.
2. Feed the power cord down the back of the table or use wall clips (not included) to secure the cord away so the baby cannot reach it.
3. Plug in the power cord, check the monitor to ensure that you are getting a good view of your child and there are no obstructions.

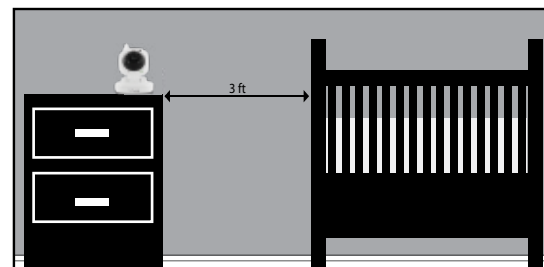

Note: Baby monitors and cameras with power cords should never be hung on or near the crib as it is a strangulation hazard. Power cords should be kept no less than 3 feet away from the crib and the baby's reach at all times.

OPERATION

Mounting the Camera on a Wall Safely:

Before drilling the holes, it is important to check the reception and camera positioning in the intended location on the wall. Ensure you are hanging the camera no less than 3 feet away from baby's crib.

Note: Baby monitors and cameras with power cords should never be hung on or near the crib as it is a strangulation hazard. Power cords should be kept no less than 3 feet away from the crib and the baby's reach at all times.

1. Pre-drill two holes in the wall using a 3/16", 4.8mm drill bit.
2. Insert wall anchors (not included) into each hole and tap gently with a hammer until the anchor is flush with the wall.
3. Insert a screw (not included) into each wall anchor and tighten until the screws only stick out about a 1/2 inch.
4. Plug the power cord into the power input of the camera.
5. Locate the wall mounting holes on the bottom of the camera base.
6. Slide the holes over the screws sticking out of the wall.
7. Confirm that the camera is secure, if it is loose you may have to tighten the screws more.
8. Use wall clips (not included) to secure the power cord away from the crib or the baby's reach.
9. Connect the other end of the adapter into an available wall outlet.

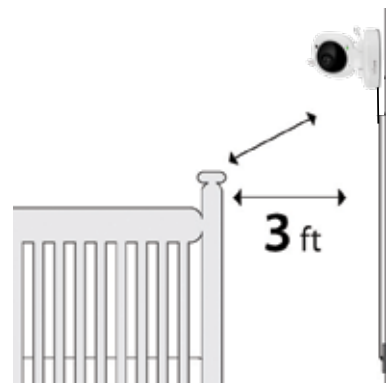



OPERATION

Night Vision

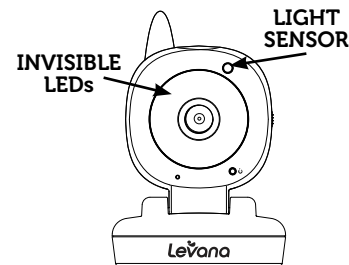
The camera is equipped with Invisible IR (infrared) LEDs which keep the nursery dark. The LEDs are located on the front of the camera and allow you to see up to 15 feet in complete darkness so you can check on your baby at any time of night. The night vision LEDs will activate automatically when the Light Sensor on the front of the camera detects that the light levels are too low.



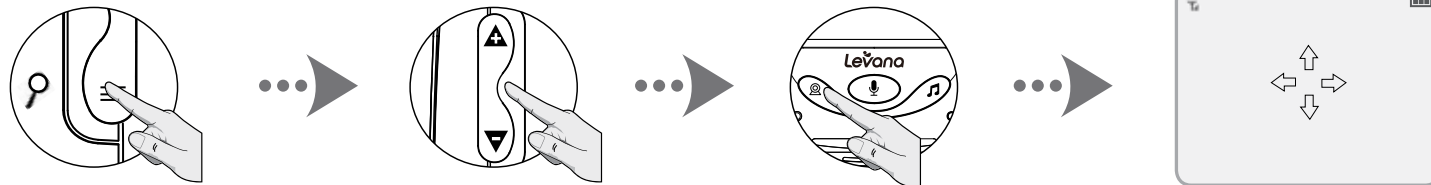

Using Pan/Tilt

The screen allows you to Pan/Tilt the image on the screen (not the camera angle). Press and hold the  button. The arrows will appear on the screen. Use the  VOLUME arrows (side) to go UP/DOWN and use the  buttons (front) to move LEFT/RIGHT.



Using the ZOOM Function

1. Press and hold the  button. ARROWS will appear on the screen.
2. Press the  button again. The X2 icon will appear at the top of the screen and the arrows will disappear.
3. Press and hold the  button to return to normal view.

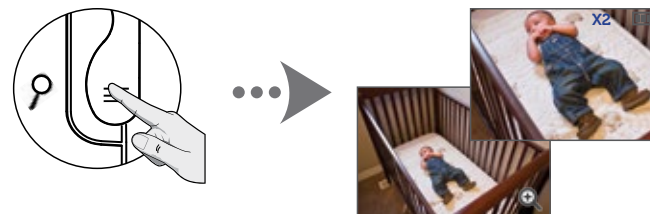

OPERATION

Volume

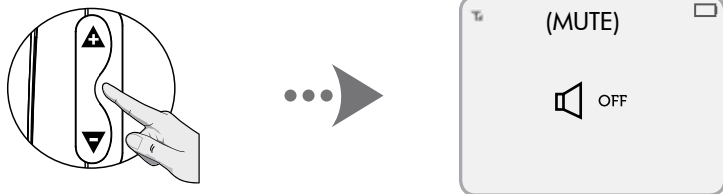

Use the ▲▼ VOLUME arrows (side) to increase/decrease/mute the VOLUME.



Note: Placing the monitor and camera too close together will create feedback. DECREASE or MUTE the volume and move the camera away from the monitor.

Using the Talk to Baby™ Two-Way Intercom



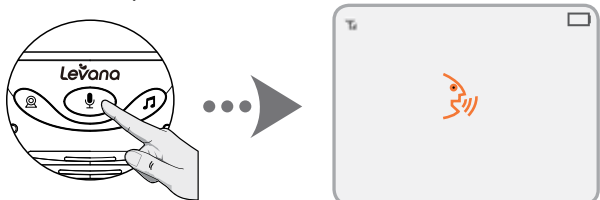

With the simple press of a button you can talk to your child at any time without entering the nursery.

1. To talk, press and hold the  (TALK) button on the front of the monitor and release to listen.
2. To talk when using multiple cameras, select the camera view (see "Changing the Camera View") and press the  (TALK) button, release to listen.



Note: To optimize the effectiveness of the Talk to Baby™ function, please keep the monitor at least 6-8 inches away from your mouth.

Nightlight

1. To turn the Nightlight ON/OFF, press the  /  button until you see the  OFF icon.
2. Use the ▲▼ VOLUME arrows (side) to select  ON.

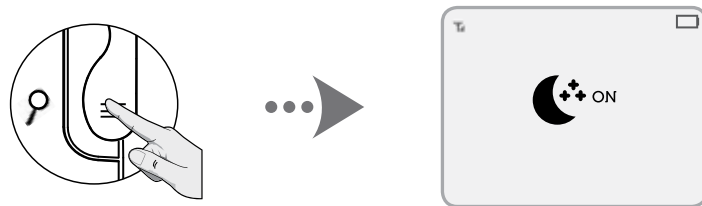

OPERATION

Setting a lullaby

Choose from five different lullabies to soothe your baby to sleep.

1. To select a lullaby, press the LULLABY 🎵 button.
2. Use the ▲▼ VOLUME arrows (side) to scroll through the 5 lullabies.
3. To turn OFF the lullabies, press the LULLABY 🎵 button.

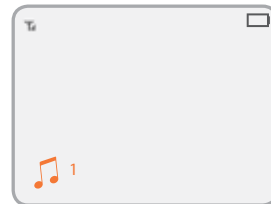
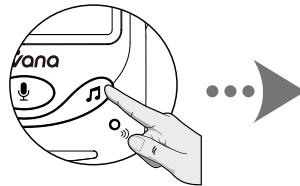

Manual Screen OFF

Another power saving feature allows you to turn the screen OFF without turning off the monitor. When sound is detected, the screen changes to live view.

1. To turn the screen OFF, press the POWER ⏻ button ONCE.
2. When sound is detected, the screen changes to live view.
3. You must once again turn the screen OFF manually; press the POWER ⏻ button ONCE.
4. To return to live view at any time, press the POWER ⏻ button ONCE.

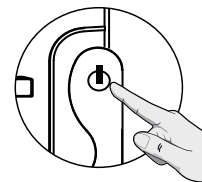

Changing the Camera View

1. To change the camera view, press the CAMERA 📷 button. Use the ▲▼ VOLUME arrows (side), to select the desired CAMERA icon 📷^{c1}, 📷^{c2}, 📷^{c3}, 📷^{c4}, SCAN.
2. Once the camera view is selected, the corresponding camera icon will appear at the top left of the screen.
3. Repeat the steps above to return to any other camera view.
- SCAN cycles through cameras 1 through 4. Each camera view will appear for 6 seconds per camera.

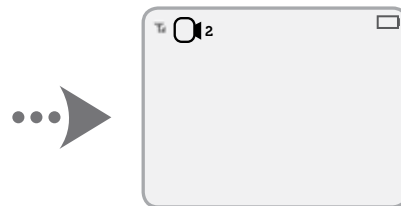
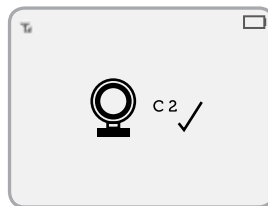
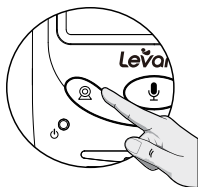

OPERATION

Setting the Brightness

Brightness Mode sets the brightness of the the screen. **Brightness Mode** also extends the battery life.

1. To set the **Brightness Mode**, press the ρ / \equiv button until you see the  icon.
2. Use the $\blacktriangle \blacktriangledown$ VOLUME arrows (side) to increase/decrease the brightness level.

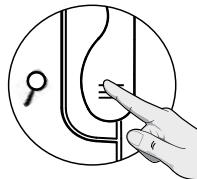

Note: Low brightness levels reduce battery consumption and extends the battery life.

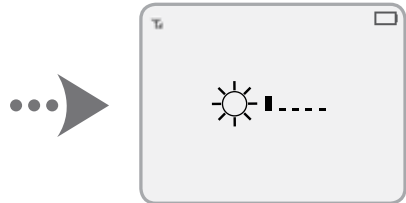

Using VOX (PEEP) Mode

When in **VOX (PEEP) Mode**, the monitor enters standby/sleep mode after 1 minute of inactivity. When sound is detected, the screen changes to live view.

- To access live view manually when the screen is off, press the POWER \cup button ONCE.
- VOX (PEEP) Mode can extend the battery life to more than 12 hours without recharging.

1. To set **VOX (PEEP) Mode**, press the ρ / \equiv button until you see the VOX icon.
2. Use the $\blacktriangle \blacktriangledown$ VOLUME arrows (side) to increase/decrease the sensitivity to sound.

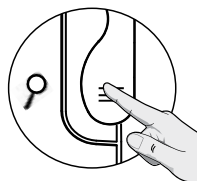

Note: Lower sensitivity levels reduce battery consumption and extends the battery life.



OPERATION

Temperature Settings

The ideal temperature for a baby's room is between 16° - 20° Celcius or 61° - 68° Fahrenheit. Please set or adjust the room temperature accordingly.

1. To select a Temperature, press the ρ/\equiv button until you see the  icon.
2. Use the $\blacktriangle/\blacktriangledown$ VOLUME arrows (side) to select °C or °F.

Temperature Ranges

You can preset alarms which will alert you to temperature changes in the room you are monitoring. An alarm will beep if the temperature drops below or goes above a selected temperature.

Minimum Temperature range

1. To select a Minimum Temperature range, press the ρ/\equiv button until you see the  icon.
2. Use the $\blacktriangle/\blacktriangledown$ VOLUME arrows (side) to select a temperature between: 59°F - 75°F or 15°C - 24°C.

Maximum Temperature range

1. To select a Maximum Temperature range, press the ρ/\equiv button until you see the  icon.
2. Use the $\blacktriangle/\blacktriangledown$ VOLUME arrows (side) to select a temperature between: 77°F - 95°F or 25°C - 35°C.

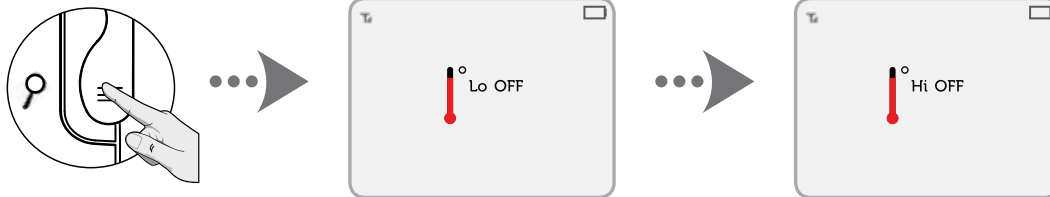

TROUBLESHOOTING

ISSUE	POSSIBLE SOLUTION
Equipment does not function	<ul style="list-style-type: none">• Confirm that the camera and monitor are ON• The battery may be depleted; charge battery• The power adapters may not be properly connected
No reception	<ul style="list-style-type: none">• Camera and monitor may not be properly paired; follow PAIRING instructions• Camera may be too far away from the monitor
Reception Interference (static)	<ul style="list-style-type: none">• The camera and monitor may be too far apart• The battery power may be too low• Other electronic devices may be interfering with the signal• The camera or monitor may be placed too close to many metal objects
Feedback (screeching, static)	<ul style="list-style-type: none">• The camera and monitor may be too close together• The volume on the monitor may be set too high
Noise (static, beeping)	<ul style="list-style-type: none">• Battery power may be too low
Picture works but there is no sound	<ul style="list-style-type: none">• Volume setting may be too low
Picture is black and white	<ul style="list-style-type: none">• Night vision LEDs may be ON; increase the amount of light in the room being monitored
Day/night vision is whitewashed	<ul style="list-style-type: none">• Ensure that night vision light sensor is pointed away from a wall and is not covered.
The rechargeable battery will not charge	<ul style="list-style-type: none">• The power adapters may not be connected• Battery pack may not be properly connected inside the battery compartment

Maintenance

- Clean the surfaces of the camera and monitor with a soft, fluff-free cloth
- If the units become dirty, use a lightly damp cloth to wipe surfaces, taking care to not allow water into any openings
- Never use cleaning agents or solvents