



# FCC RADIO TEST REPORT-BLE

## FCC ID:SMCJMGO-G1

**Product :** Smart Projector

**Trade Name :** JmGO,Holatek

**Model Name :** JmGO-G1

**Serial Model :** JmGO-XXX (XXX (X=0~9, A~Z or blank,  
X represents the color of the products and  
sales of customer))

**Report No. :** NTEK-2014NT12052165F1

### Prepared for

SHENZHEN HOLATEK CO.,LTD.

Rm.1001,Unit 4,Bld.B,Kexing Science Park, Keyuan Road, Nshan  
District,Shenzhen,China

### Prepared by

Shenzhen NTEK Testing Technology Co., Ltd.

1/F, Building E, Fenda Science Park, Sanwei Community, Xixiang Street  
Bao'an District, Shenzhen P.R. China

Tel.: +86-0755-61156588 Fax.: +86-0755-61156599

Website:www.ntek.org.cn

## TEST RESULT CERTIFICATION

**Applicant's name** ..... SHENZHEN HOLATEK CO.,LTD.

Address ..... Rm.1001,Unit 4,Bld.B,Kexing Science Park, Keyuan Road, Nashan District,Shenzhen,China

**Manufacturer's Name**... SHENZHEN HOLATEK CO.,LTD.

Address ..... Rm.1001,Unit 4,Bld.B,Kexing Science Park, Keyuan Road, Nashan District,Shenzhen,China

### Product description

Product name ..... Smart Projector

Model and/or type reference ..... JmGO-G1

Serial Model ..... JmGO-XXX (XXX (X=0~9, A~Z or blank, X represents the color of the products and sales of customer))

**Standards** ..... FCC Part15.247: 01 Oct. 2014

Test procedure ..... ANSI C63.4-2003 and KDB 558074: June 5, 2014

This device described above has been tested by NTEK, and the test results show that the equipment under test (EUT) is in compliance with the FCC requirements. And it is applicable only to the tested sample identified in the report.

This report shall not be reproduced except in full, without the written approval of NTEK, this document may be altered or revised by NTEK, personal only, and shall be noted in the revision of the document.

**Date of Test** .....

Date (s) of performance of tests .....: 05 Dec. 2014 ~12 Feb. 2015

Date of Issue.....: 12 Feb. 2015

Test Result.....: **Pass**

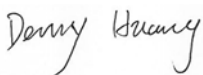
Testing Engineer :   
\_\_\_\_\_

Denny Huang

Technical Manager :   
\_\_\_\_\_

(Brown Lu)

Authorized Signatory :   
\_\_\_\_\_

(Bill Yao)

**Table of Contents**

	<b>Page</b>
<b>1 . SUMMARY OF TEST RESULTS</b>	<b>5</b>
1.1 TEST FACILITY	6
1.2 MEASUREMENT UNCERTAINTY	6
<b>2 . GENERAL INFORMATION</b>	<b>7</b>
2.1 GENERAL DESCRIPTION OF EUT	7
2.2 DESCRIPTION OF TEST MODES	8
2.3 BLOCK DIGRAM SHOWING THE CONFIGURATION OF SYSTEM TESTED	9
2.4 DESCRIPTION OF SUPPORT UNITS(CONDUCTED MODE)	10
2.5 EQUIPMENTS LIST FOR ALL TEST ITEMS	11
<b>3 . EMC EMISSION TEST</b>	<b>12</b>
3.1 CONDUCTED EMISSION MEASUREMENT	12
3.1.1 POWER LINE CONDUCTED EMISSION LIMITS	12
3.1.2 TEST PROCEDURE	13
3.1.3 DEVIATION FROM TEST STANDARD	13
3.1.4 TEST SETUP	13
3.1.5 EUT OPERATING CONDITIONS	13
3.1.6 TEST RESULTS	14
3.2 RADIATED EMISSION MEASUREMENT	16
3.2.1 RADIATED EMISSION LIMITS	16
3.2.2 TEST PROCEDURE	17
3.2.3 DEVIATION FROM TEST STANDARD	17
3.2.4 TEST SETUP	18
3.2.5 EUT OPERATING CONDITIONS	19
3.2.6 TEST RESULTS (BETWEEN 9KHZ – 30 MHZ)	20
3.2.7 TEST RESULTS (BETWEEN 30MHZ – 1GHZ)	21
3.2.8 TEST RESULTS (ABOVE 1000 MHZ)	23
<b>4 . POWER SPECTRAL DENSITY TEST</b>	<b>24</b>
4.1 APPLIED PROCEDURES / LIMIT	24
4.1.1 TEST PROCEDURE	24
4.1.2 DEVIATION FROM STANDARD	24
4.1.3 TEST SETUP	24
4.1.4 EUT OPERATION CONDITIONS	24
4.1.5 TEST RESULTS	25
<b>5 . BANDWIDTH TEST</b>	<b>27</b>
5.1 APPLIED PROCEDURES / LIMIT	27
5.1.1 TEST PROCEDURE	27

**Table of Contents**

	<b>Page</b>
<b>TEST SETUP</b>	<b>27</b>
<b>5.1.2 EUT OPERATION CONDITIONS</b>	<b>27</b>
<b>5.1.3 TEST RESULTS</b>	<b>28</b>
<b>6 . PEAK OUTPUT POWER TEST</b>	<b>30</b>
<b>6.1 APPLIED PROCEDURES / LIMIT</b>	<b>30</b>
<b>6.1.1 TEST PROCEDURE</b>	<b>30</b>
<b>6.1.2 DEVIATION FROM STANDARD</b>	<b>30</b>
<b>6.1.3 TEST SETUP</b>	<b>30</b>
<b>6.1.4 EUT OPERATION CONDITIONS</b>	<b>30</b>
<b>6.1.5 TEST RESULTS</b>	<b>31</b>
<b>7 . 100 KHZ BANDWIDTH OF FREQUENCY BAND EDGE</b>	<b>32</b>
<b>7.1 DEVIATION FROM STANDARD</b>	<b>32</b>
<b>7.2 TEST SETUP</b>	<b>32</b>
<b>7.3 EUT OPERATION CONDITIONS</b>	<b>32</b>
<b>7.4 TEST RESULTS</b>	<b>33</b>
<b>8 . ANTENNA REQUIREMENT</b>	<b>35</b>
<b>8.1 STANDARD REQUIREMENT</b>	<b>35</b>
<b>8.2 EUT ANTENNA</b>	<b>35</b>
<b>9 . EUT TEST PHOTO</b>	<b>36</b>
<b>APPENDIX-PHOTOGRAPHS OF EUT CONSTRUCTIONAL DETAILS</b>	

### 1. SUMMARY OF TEST RESULTS

Test procedures according to the technical standards:

FCC Part15 (15.247) , Subpart C			
Standard Section	Test Item	Judgment	Remark
15.207	Conducted Emission	PASS	
15.247 (a)(2)	6dB Bandwidth	PASS	
15.247 (b)	Peak Output Power	PASS	
15.247 (c)	Radiated Spurious Emission	PASS	
15.247 (d)	Power Spectral Density	PASS	
15.205	Band Edge Emission	PASS	
15.203	Antenna Requirement	PASS	

**NOTE:**

(1) "N/A" denotes test is not applicable in this Test Report

**1.1 TEST FACILITY**

NTEK Testing Technology Co., Ltd  
 Add.:1/F, Building E, Fenda Science Park, Sanwei Community, Xixiang Street, Bao'an District, Shenzhen P.R. China.  
 FCC Registration No.:238937; IC Registration No.:9270A-1  
 CNAS Registration No.:L5516

**1.2 MEASUREMENT UNCERTAINTY**

The reported uncertainty of measurement  $y \pm U$ , where expanded uncertainty  $U$  is based on a standard uncertainty multiplied by a coverage factor of  $k=2$ , providing a level of confidence of approximately 95 %.

No.	Item	Uncertainty
1	Conducted Emission Test	$\pm 1.38\text{dB}$
2	RF power,conducted	$\pm 0.16\text{dB}$
3	Spurious emissions,conducted	$\pm 0.21\text{dB}$
4	All emissions,radiated(<1G)	$\pm 4.68\text{dB}$
5	All emissions,radiated(>1G)	$\pm 4.89\text{dB}$
6	Temperature	$\pm 0.5^{\circ}\text{C}$
7	Humidity	$\pm 2\%$

## 2. GENERAL INFORMATION

### 2.1 GENERAL DESCRIPTION OF EUT

Equipment	Smart Projector	
Trade Name	JmGO,Holatek	
Model Name	JmGO-G1	
Serial Model	JmGO-XXX (XXX (X=0~9, A~Z or blank, X represents the color of the products and sales of customer))	
Model Difference	All the model are the same circuit and RF module, except the model name and colour.	
Product Description	The EUT is a Smart Projector	
	Operation Frequency:	2402~2480MHz
	Modulation Type:	GFSK
	Number Of Channel	40CH
	Antenna Designation:	Please see Note 3.
	Antenna Gain (dBi)	1.0dBi
Channel List	Please refer to the Note 2.	
Ratings	DC 19.0V From adapter AC120V/60Hz	
Adapter	Mode:FSP090-DIEBN2 Input: 100-240V~,50/60 Hz,1.5A Output: 19.0V---, 4.74A	
Battery	N/A	
Connecting I/O Port(s)	Please refer to the User's Manual	

Note:

1. For a more detailed features description, please refer to the manufacturer's specifications or the User's Manual.
- 2.

Channel	Frequency (MHz)
00	2402
01	2404
.....	.....
.....	.....
...	...
.....	.....
38	2478
39	2480

3.

Table for Filed Antenna

Ant	Brand	Model Name	Antenna Type	Connector	Gain (dBi)	NOTE
A	N/A	N/A	FPCB Antenna	N/A	1.0	BT Antenna

## 2.2 DESCRIPTION OF TEST MODES

To investigate the maximum EMI emission characteristics generates from EUT, the test system was pre-scanning tested base on the consideration of following EUT operation mode or test configuration mode which possible have effect on EMI emission level. Each of these EUT operation mode(s) or test configuration mode(s) mentioned above was evaluated respectively.

Pretest Mode	Description
Mode 1	CH00
Mode 2	CH19
Mode 3	CH39
Mode 4	Link Mode

For Conducted Emission	
Final Test Mode	Description
Mode 4	Link Mode

For Radiated Emission	
Final Test Mode	Description
Mode 1	CH00
Mode 2	CH19
Mode 3	CH39
Mode 4	Link Mode

Note:

- (1) The measurements are performed at the highest, middle, lowest available channels.
- (2) The measurements are performed at all Bit Rate of Transmitter, the worst data was reported



### 2.3 BLOCK DIGRAM SHOWING THE CONFIGURATION OF SYSTEM TESTED

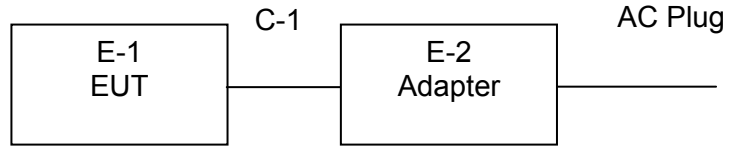

**2.4 DESCRIPTION OF SUPPORT UNITS(CONDUCTED MODE)**

The EUT has been tested as an independent unit together with other necessary accessories or support units. The following support units or accessories were used to form a representative test configuration during the tests.

Item	Equipment	Brand	Model/Type No.	Series No.	Note
E-1	Smart Projector	JmGO,Holatek	JmGO-G1	N/A	EUT
E-2	Adapter	N/A	FSP090-DIEBN2	N/A	

Item	Shielded Type	Ferrite Core	Length	Note
C-1	NO	NO	1.2m	

Note:

- (1) The support equipment was authorized by Declaration of Confirmation.
- (2) For detachable type I/O cable should be specified the length in cm in 『Length』 column.

**2.5 EQUIPMENTS LIST FOR ALL TEST ITEMS**

Radiation Test equipment

Item	Kind of Equipment	Manufacturer	Type No.	Serial No.	Last calibration	Calibrated until	Calibration period
1	Spectrum Analyzer	Agilent	E4407B	MY45108040	2014.07.06	2015.07.05	1 year
2	Test Receiver	R&S	ESPI	101318	2014.06.07	2015.06.06	1 year
3	Bilog Antenna	TESEQ	CBL6111D	31216	2014.07.06	2015.07.05	1 year
4	50Ω Coaxial Switch	Anritsu	MP59B	6200264416	2014.06.07	2015.06.06	1 year
5	Spectrum Analyzer	ADVANTEST	R3132	150900201	2014.06.07	2015.06.06	1 year
6	Horn Antenna	EM	EM-AH-10180	2011071402	2014.07.06	2015.07.05	1 year
7	Horn Ant	Schwarzbeck	BBHA 9170	9170-181	2014.07.06	2015.07.05	1 year
8	Amplifier	EM	EM-30180	060538	2014.12.22	2015.12.21	1 year
9	Loop Antenna	ARA	PLA-1030/B	1029	2014.06.08	2015.06.07	1 year
10	Power Meter	R&S	NRVS	100696	2014.07.06	2015.07.05	1 year
11	Power Sensor	R&S	URV5-Z4	0395.1619.05	2014.07.06	2015.07.05	1 year

Conduction Test equipment

Item	Kind of Equipment	Manufacturer	Type No.	Serial No.	Last calibration	Calibrated until	Calibration period
1	Test Receiver	R&S	ESCI	101160	2014.06.06	2015.06.05	1 year
2	LISN	R&S	ENV216	101313	2014.08.24	2015.08.23	1 year
3	LISN	EMCO	3816/2	00042990	2014.08.24	2015.08.23	1 year
4	50Ω Coaxial Switch	Anritsu	MP59B	6200264417	2014.06.07	2015.06.06	1 year
5	Passive Voltage Probe	R&S	ESH2-Z3	100196	2014.06.07	2015.06.06	1 year
6	Absorbing clamp	R&S	MOS-21	100423	2014.06.08	2015.06.07	1 year

1	Attenuation	MCE	24-10-34	BN9258	2014.06.08	2015.06.07	1 year
---	-------------	-----	----------	--------	------------	------------	--------

### 3. EMC EMISSION TEST

#### 3.1 CONDUCTED EMISSION MEASUREMENT

##### 3.1.1 POWER LINE CONDUCTED EMISSION Limits (Frequency Range 150KHz-30MHz)

FREQUENCY (MHz)	Class A (dBuV)		Class B (dBuV)		Standard
	Quasi-peak	Average	Quasi-peak	Average	
0.15 -0.5	79.00	66.00	66 - 56 *	56 - 46 *	CISPR
0.50 -5.0	73.00	60.00	56.00	46.00	CISPR
5.0 -30.0	73.00	60.00	60.00	50.00	CISPR

0.15 -0.5	79.00	66.00	66 - 56 *	56 - 46 *	FCC
0.50 -5.0	73.00	60.00	56.00	46.00	FCC
5.0 -30.0	73.00	60.00	60.00	50.00	FCC

Note:

- (1) The tighter limit applies at the band edges.
- (2) The limit of " \* " marked band means the limitation decreases linearly with the logarithm of the frequency in the range.

The following table is the setting of the receiver

Receiver Parameters	Setting
Attenuation	10 dB
Start Frequency	0.15 MHz
Stop Frequency	30 MHz
IF Bandwidth	9 kHz

**3.1.2 TEST PROCEDURE**

- a. The EUT was placed 0.8 meters from the horizontal ground plane with EUT being connected to the power mains through a line impedance stabilization network (LISN). All other support equipments powered from additional LISN(s). The LISN provide 50 Ohm/ 50uH of coupling impedance for the measuring instrument.
- b. Interconnecting cables that hang closer than 40 cm to the ground plane shall be folded back and forth in the center forming a bundle 30 to 40 cm long.
- c. I/O cables that are not connected to a peripheral shall be bundled in the center. The end of the cable may be terminated, if required, using the correct terminating impedance. The overall length shall not exceed 1 m.
- d. LISN at least 80 cm from nearest part of EUT chassis.
- e. For the actual test configuration, please refer to the related Item –EUT Test Photos.

**3.1.3 DEVIATION FROM TEST STANDARD**

No deviation

**3.1.4 TEST SETUP**

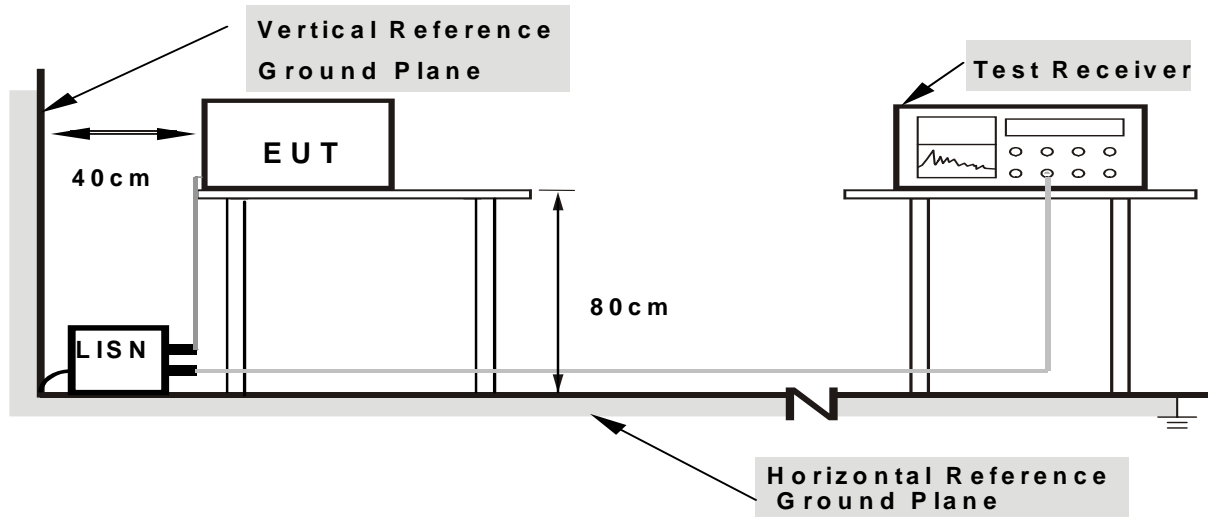

- Note:**
- 1. Support units were connected to second LISN.
  - 2. Both of LISNs (AMN) are 80 cm from EUT and at least 80 from other units and other metal planes

**3.1.5 EUT OPERATING CONDITIONS**

The EUT was configured for testing in a typical fashion (as a customer would normally use it). The EUT has been programmed to continuously transmit during test. This operating condition was tested and used to collect the included data.

### 3.1.6 TEST RESULTS

EUT :	Smart Projector	Model Name. :	JmGO-G1
Temperature :	26 °C	Relative Humidity :	56%
Pressure :	1010hPa	Phase :	L
Test Voltage :	DC 19.0V form Adapter AC 120V/60Hz	Test Mode :	Mode 4

Frequency (MHz)	Meter Reading (dBµV)	Factor (dB)	Emission Level (dBµV)	Limits (dBµV)	Margin (dB)	Remark
0.3780	34.44	9.45	43.89	58.32	-14.43	QP
0.3780	22.54	9.45	31.99	48.32	-16.33	AVG
0.8020	28.86	9.45	38.31	56.00	-17.69	QP
0.8020	24.55	9.45	34.00	46.00	-12.00	AVG
1.1419	30.17	9.46	39.63	56.00	-16.37	QP
1.1419	24.11	9.46	33.57	46.00	-12.43	AVG
1.6060	30.25	9.46	39.71	56.00	-16.29	QP
1.6060	23.51	9.46	32.97	46.00	-13.03	AVG
2.0739	29.67	9.46	39.13	56.00	-16.87	QP
2.0739	21.17	9.46	30.63	46.00	-15.37	AVG
13.5219	30.96	9.69	40.65	60.00	-19.35	QP
13.5219	22.66	9.69	32.35	50.00	-17.65	AVG

Remark:

1. All readings are Quasi-Peak and Average values.
2. Factor = Insertion Loss + Cable Loss.

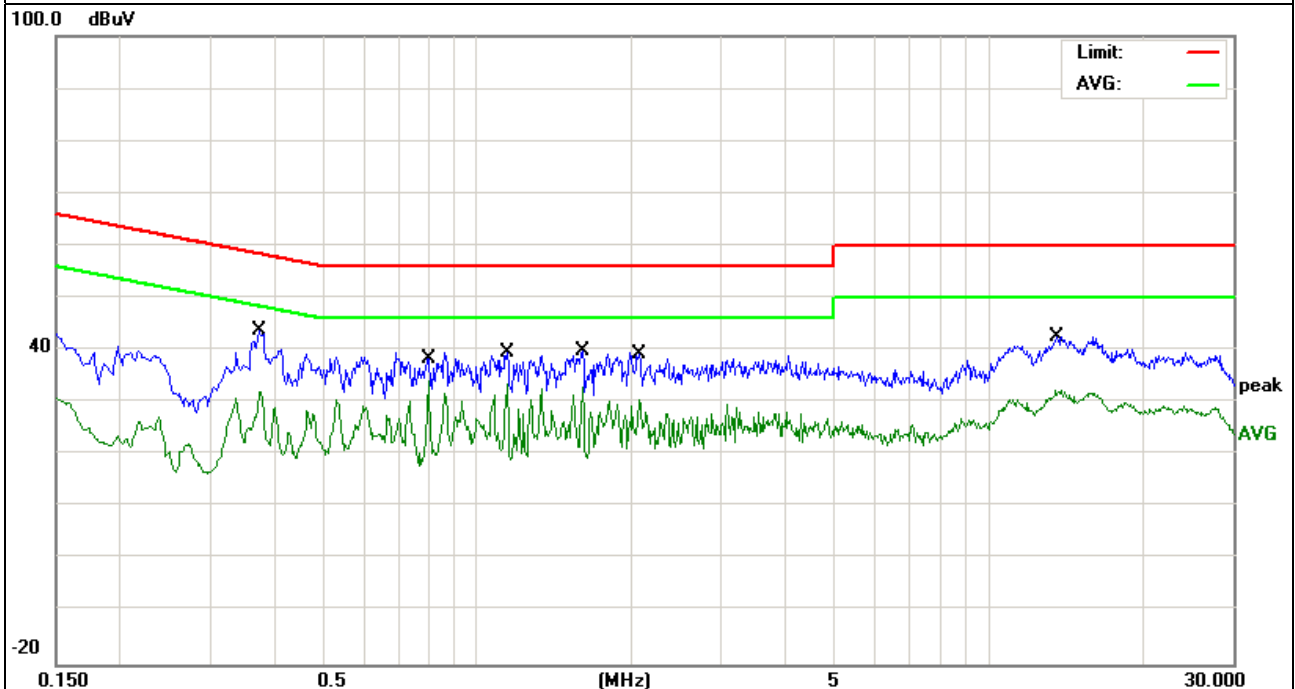

EUT :	Smart Projector	Model Name. :	JmGO-G1
Temperature :	26 °C	Relative Humidity :	56%
Pressure :	1010hPa	Phase :	N
Test Voltage :	DC 19.0V form Adapter AC 120V/60Hz	Test Mode :	Mode 4

Frequency (MHz)	Meter Reading (dBμV)	Factor (dB)	Emission Level (dBμV)	Limits (dBμV)	Margin (dB)	Remark
0.3780	31.76	9.45	41.21	58.32	-17.11	QP
0.3780	22.35	9.45	31.80	48.32	-16.52	AVG
0.5340	26.83	9.46	36.29	56.00	-19.71	QP
0.5340	20.36	9.46	29.82	46.00	-16.18	AVG
0.8059	23.00	9.45	32.45	56.00	-23.55	QP
0.8059	17.64	9.45	27.09	46.00	-18.91	AVG
2.3540	30.31	9.45	39.76	56.00	-16.24	QP
2.3540	22.42	9.45	31.87	46.00	-14.13	AVG
2.8140	31.06	9.45	40.51	56.00	-15.49	QP
2.8140	22.53	9.45	31.98	46.00	-14.02	AVG
13.8459	32.98	9.69	42.67	60.00	-17.33	QP
13.8459	22.57	9.69	32.26	50.00	-17.74	AVG

Remark:

1. All readings are Quasi-Peak and Average values.
2. Factor = Insertion Loss + Cable Loss.

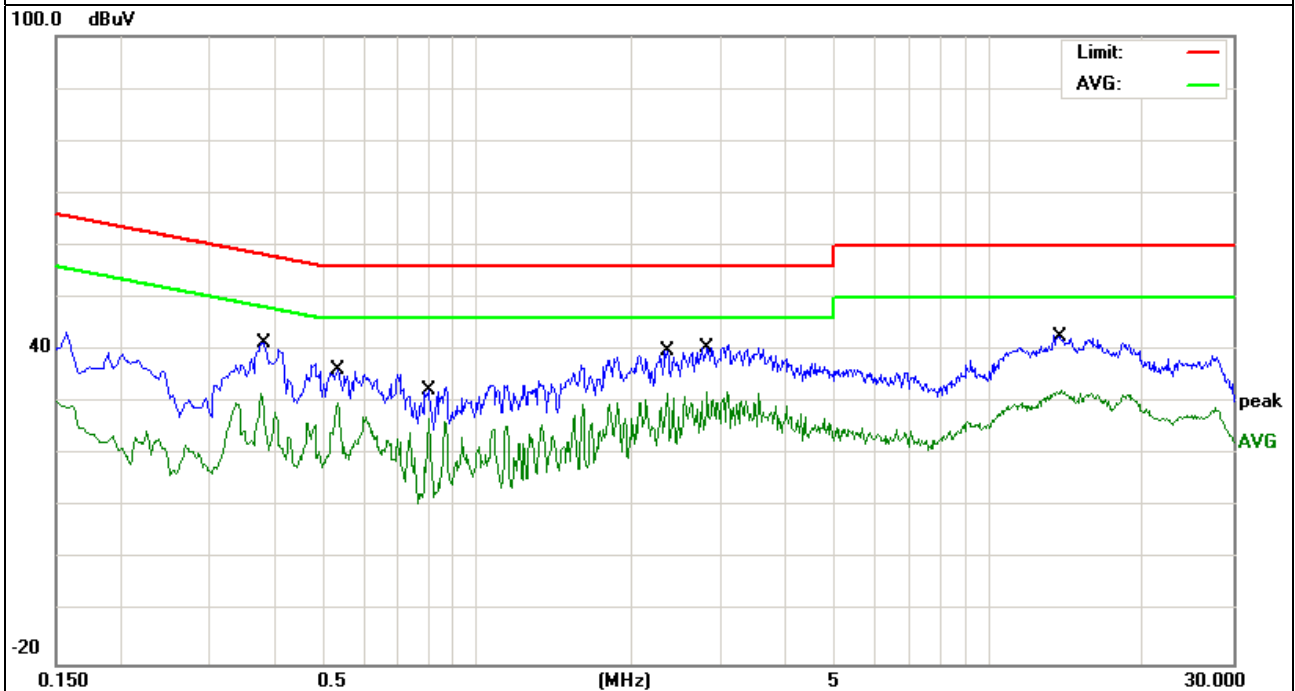

### 3.2 RADIATED EMISSION MEASUREMENT

#### 3.2.1 RADIATED EMISSION LIMITS (Frequency Range 9kHz-1000MHz)

20dBc in any 100 kHz bandwidth outside the operating frequency band. In case the emission fall within the restricted band specified on 15.205(a), then the 15.209(a) limit in the table below has to be followed.

Frequencies (MHz)	Field Strength (micorvolts/meter)	Measurement Distance (meters)
0.009~0.490	2400/F(KHz)	300
0.490~1.705	24000/F(KHz)	30
1.705~30.0	30	30
30~88	100	3
88~216	150	3
216~960	200	3
Above 960	500	3

#### LIMITS OF RADIATED EMISSION MEASUREMENT (Above 1000MHz)

FREQUENCY (MHz)	Class B (dBuV/m) (at 3M)	
	PEAK	AVERAGE
Above 1000	74	54

Notes:

- (1) The limit for radiated test was performed according to FCC PART 15C.
- (2) The tighter limit applies at the band edges.
- (3) Emission level (dBuV/m)=20log Emission level (uV/m).

Spectrum Parameter	Setting
Attenuation	Auto
Start Frequency	1000 MHz
Stop Frequency	10th carrier harmonic
RB / VB (emission in restricted band)	1 MHz / 1 MHz for Peak, 1 MHz / 10Hz for Average

Receiver Parameter	Setting
Attenuation	Auto
Start ~ Stop Frequency	9kHz~150kHz / RB 200Hz for QP
Start ~ Stop Frequency	150kHz~30MHz / RB 9kHz for QP
Start ~ Stop Frequency	30MHz~1000MHz / RB 120kHz for QP



**3.2.2 TEST PROCEDURE**

- a. The measuring distance of at 3 m shall be used for measurements at frequency up to 1GHz. For frequencies above 1GHz, any suitable measuring distance may be used.
- b. The EUT was placed on the top of a rotating table 0.8 meters above the ground at a 3 meter test site. The table was rotated 360 degrees to determine the position of the highest radiation.
- c. The height of the equipment or of the substitution antenna shall be 0.8 m; the height of the test antenna shall vary between 1 m to 4 m. Both horizontal and vertical polarizations of the antenna are set to make the measurement.
- d. The initial step in collecting conducted emission data is a spectrum analyzer peak detector mode pre-scanning the measurement frequency range. Significant peaks are then marked and then Quasi Peak detector mode re-measured.
- e. If the Peak Mode measured value compliance with and lower than Quasi Peak Mode Limit, the EUT shall be deemed to meet QP Limits and then no additional QP Mode measurement performed.
- f. For the actual test configuration, please refer to the related Item –EUT Test Photos.

Note:

Both horizontal and vertical antenna polarities were tested and performed pretest to three orthogonal axis. The worst case emissions were reported

During the radiated emission test, the Spectrum Analyzer was set with the following configurations:

Frequency Band (MHz)	Function	Resolution bandwidth	Video Bandwidth
30 to 1000	QP	120 kHz	300 kHz
Above 1000	Peak	1 MHz	1 MHz
	Peak	1 MHz	10 Hz

**3.2.3 DEVIATION FROM TEST STANDARD**

No deviation

### 3.2.4 TEST SETUP

#### (A) Radiated Emission Test-Up Frequency Below 30MHz

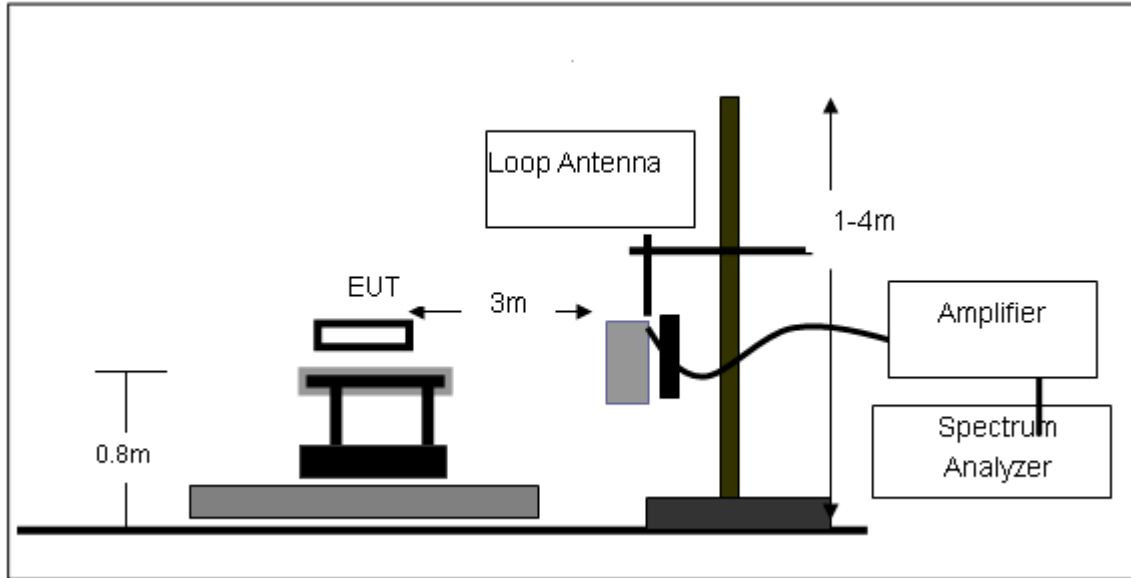

#### (B) Radiated Emission Test-Up Frequency 30MHz~1GHz

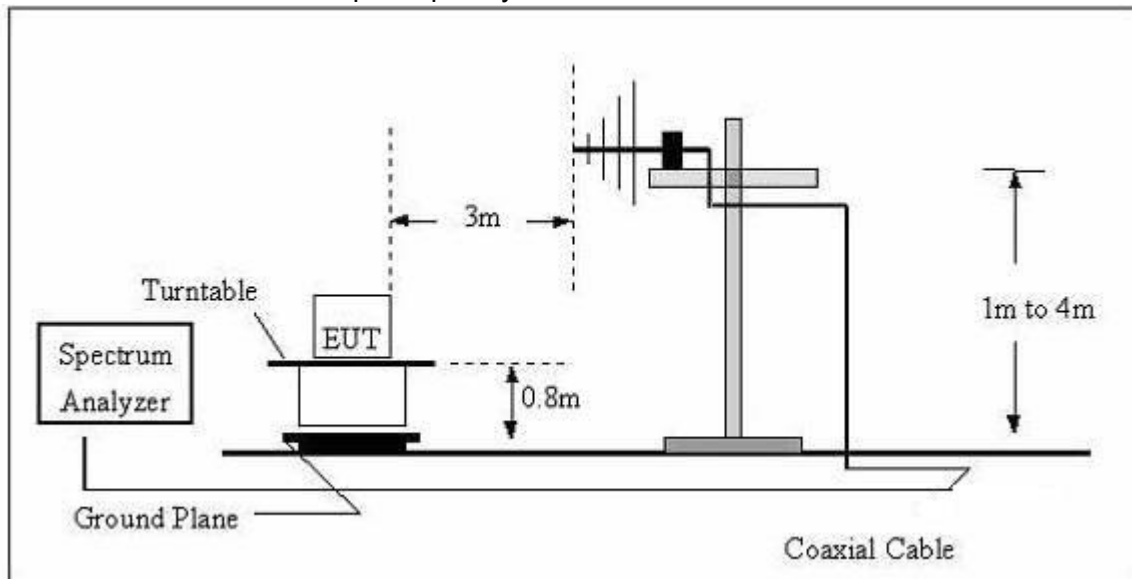

(C) Radiated Emission Test-Up Frequency Above 1GHz

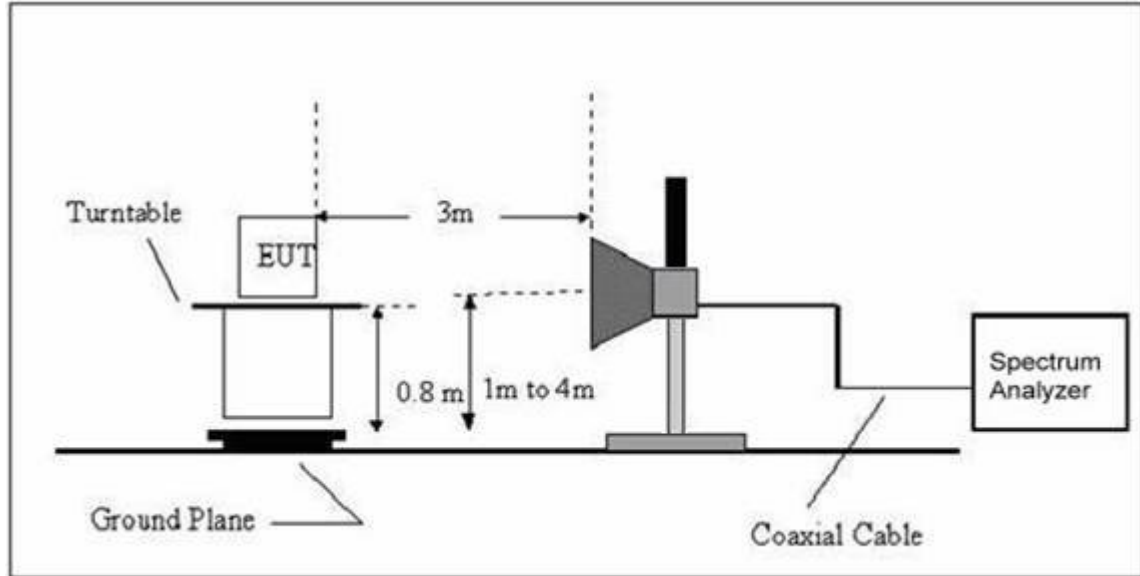

**3.2.5 EUT OPERATING CONDITIONS**

The EUT tested system was configured as the statements of 2.4 Unless otherwise a special operating condition is specified in the follows during the testing.

**3.2.6 TEST RESULTS (BETWEEN 9KHZ – 30 MHZ)**

EUT:	Smart Projector	Model Name. :	JmGO-G1
Temperature:	20 °C	Relative Humidity:	48%
Pressure:	1010 hPa	Test Voltage :	DC 19.0V form Adapter AC 120V/60Hz
Test Mode :	TX	Polarization :	--

Freq.	Reading	Limit	Margin	State
(MHz)	(dBuV/m)	(dBuV/m)	(dB)	P/F
--	--	--	--	N/A
--	--	--	--	N/A

**NOTE:**

The amplitude of spurious emissions which are attenuated by more than 20dB below the permissible value has no need to be reported.

Distance extrapolation factor =  $40 \log(\text{specific distance}/\text{test distance})$ (dB);

Limit line = specific limits(dBuv) + distance extrapolation factor.

### 3.2.7 TEST RESULTS (BETWEEN 30MHZ – 1GHZ)

EUT :	Smart Projector	Model Name :	JmGO-G1
Temperature :	20 °C	Relative Humidity :	48%
Pressure:	1010 hPa	Test Voltage :	DC 19.0V form Adapter AC 120V/60Hz
Test Mode :	TX		

Polar (H/V)	Frequency	Meter Reading	Factor	Emission Level	Limits	Margin	Remark
	(MHz)	(dBuV)	(dB)	(dBuV/m)	(dBuV/m)	(dB)	
V	61.9951	22.36	7.38	29.74	40.00	-10.26	QP
V	150.5378	28.13	10.42	38.55	43.50	-4.95	QP
V	290.0172	25.82	14.04	39.86	46.00	-6.14	QP
V	495.9343	17.01	20.21	37.22	46.00	-8.78	QP
V	620.7096	16.57	22.82	39.39	46.00	-6.61	QP
V	821.7103	13.67	27.33	41.00	46.00	-5.00	QP

**Remark:**

Absolute Level= ReadingLevel+ Factor, Margin= Absolute Level - Limit

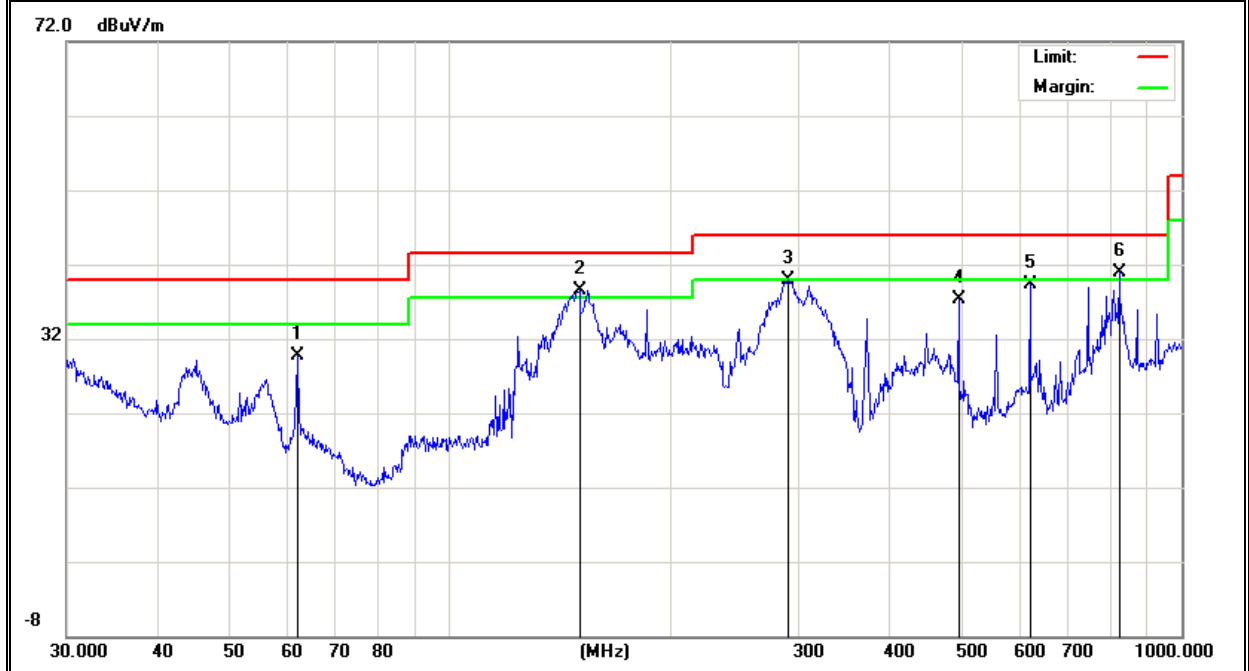

Polar (H/V)	Frequency	Meter Reading	Factor	Emission Level	Limits	Margin	Remark
	(MHz)	(dBuV)	(dB)	(dBuV/m)	(dBuV/m)	(dB)	
H	61.9951	18.43	7.38	25.81	40.00	-14.19	QP
H	185.788	27.47	10.67	38.14	43.50	-5.36	QP
H	313.276	25.11	14.71	39.82	46.00	-6.18	QP
H	744.8659	14.35	25.96	40.31	46.00	-5.69	QP
H	807.4288	13.84	27.38	41.22	46.00	-4.78	QP
H	925.7563	11.27	27.17	38.44	46.00	-7.56	QP

**Remark:**

Absolute Level= ReadingLevel+ Factor, Margin= Absolute Level - Limit

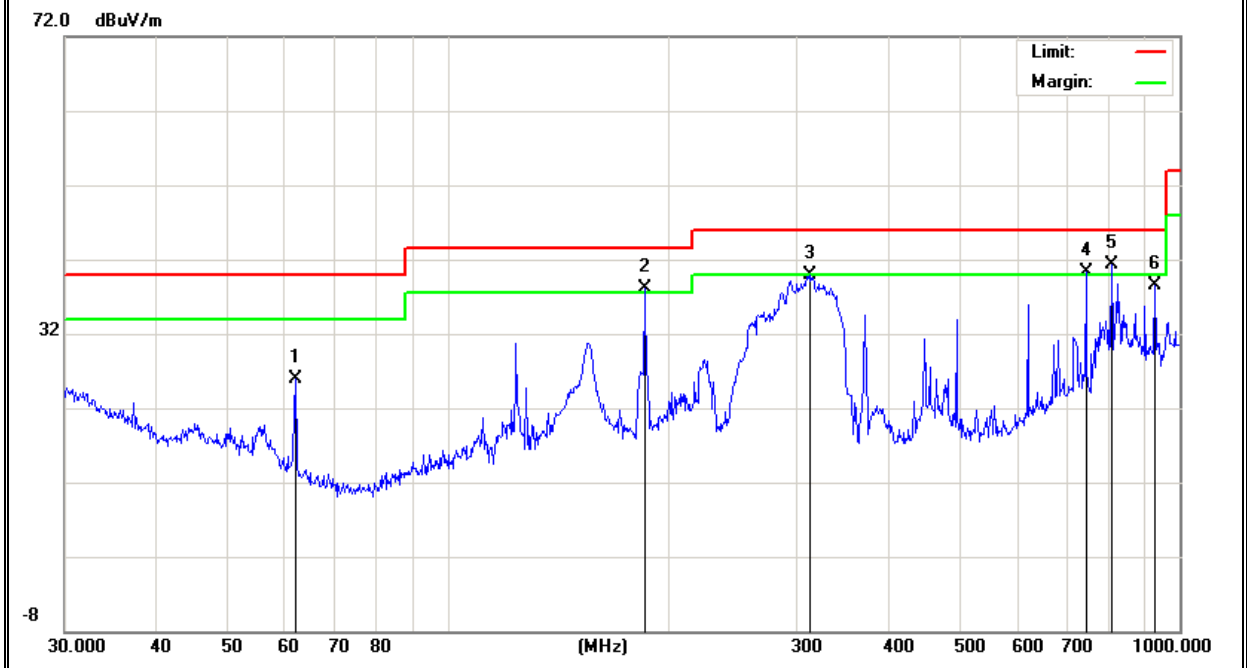

### 3.2.8 TEST RESULTS (ABOVE 1000 MHZ)

EUT :	Smart Projector	Model Name :	JmGO-G1
Temperature :	20 °C	Relative Humidity :	48%
Pressure:	1010 hPa	Test Voltage :	DC 19.0V form Adapter AC 120V/60Hz
Test Mode :	TX		

Frequency (MHz)	Reading (dBµV)	Factor (dB)	Corrected Amplitude (dBµV/m)	Limit (dBµV/m)	Margin (dB)	Remark	Polar (H/V)
Low Channel (2402 MHz)-Above 1G							
4804.305	58.96	-3.64	55.32	74.00	-18.68	Pk	Vertical
4804.305	41.23	-3.64	37.59	54.00	-16.41	AV	Vertical
7206.217	59.11	-0.95	58.16	74.00	-15.84	Pk	Vertical
7206.217	37.24	-0.95	36.29	54.00	-17.71	AV	Vertical
4804.063	59.34	-3.64	55.70	74.00	-18.30	Pk	Horizontal
4804.063	42.27	-3.64	38.63	54.00	-15.37	AV	Horizontal
7206.109	57.31	-0.95	56.36	74.00	-17.64	Pk	Horizontal
7206.109	37.13	-0.95	36.18	54.00	-17.82	AV	Horizontal
Mid Channel (2440 MHz)-Above 1G							
4880.064	59.71	-3.68	56.03	74.00	-17.97	Pk	Vertical
4880.064	41.74	-3.68	38.06	54.00	-15.94	AV	Vertical
7320.241	59.14	-0.82	58.32	74.00	-15.68	Pk	Vertical
7320.241	39.94	-0.82	39.12	54.00	-14.88	AV	Vertical
4880.305	56.61	-3.68	52.93	74.00	-21.07	Pk	Horizontal
4880.305	37.74	-3.68	34.06	54.00	-19.94	AV	Horizontal
7320.158	59.04	-0.82	58.22	74.00	-15.78	Pk	Horizontal
7320.158	39.21	-0.82	38.39	54.00	-15.61	AV	Horizontal
High Channel (2480MHz)- Above 1G							
4960.304	59.03	-3.59	55.44	74.00	-18.56	Pk	Vertical
4960.304	37.88	-3.59	34.29	54.00	-19.71	AV	Vertical
7440.217	57.56	-0.68	56.88	74.00	-17.12	Pk	Vertical
7440.217	41.76	-0.68	41.08	54.00	-12.92	AV	Vertical
4960.311	58.86	-3.59	55.27	74.00	-18.73	Pk	Horizontal
4960.311	39.04	-3.59	35.45	54.00	-18.55	AV	Horizontal
7440.168	60.49	-0.68	59.81	74.00	-14.19	Pk	Horizontal
7440.168	39.23	-0.68	38.55	54.00	-15.45	AV	Horizontal

**Remark:** Absolute Level= ReadingLevel+ Factor, Margin= Absolute Level - Limit

#### 4. POWER SPECTRAL DENSITY TEST

##### 4.1 APPLIED PROCEDURES / LIMIT

FCC Part15 (15.247) , Subpart C				
Section	Test Item	Limit	Frequency Range (MHz)	Result
15.247	Power Spectral Density	8 dBm (in any 3KHz)	2400-2483.5	PASS

##### 4.1.1 TEST PROCEDURE

1. Set analyzer center frequency to DTS channel center frequency.
2. Set the span to 1.5 times the DTS channel bandwidth.
3. 3 kHz ≤ Set the RBW ≤ 100 kHz.
4. Set the VBW ≥ 3 x RBW.
5. Detector = peak.
6. Sweep time = auto couple.
7. Trace mode = max hold.
8. Allow trace to fully stabilize.
9. Use the peak marker function to determine the maximum amplitude level within the RBW.
10. If measured value exceeds limit, reduce RBW (no less than 3 kHz) and repeat.

##### 4.1.2 DEVIATION FROM STANDARD

No deviation.

##### 4.1.3 TEST SETUP

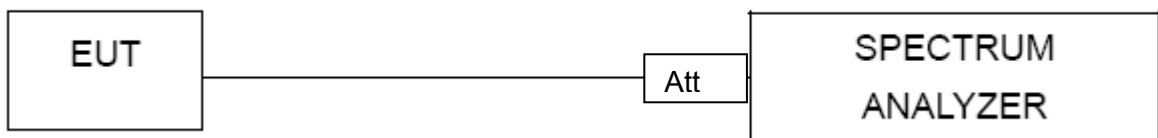

##### 4.1.4 EUT OPERATION CONDITIONS

The EUT tested system was configured as the statements of 2.1 Unless otherwise a special operating condition is specified in the follows during the testing.



### 4.1.5 TEST RESULTS

EUT :	Smart Projector	Model Name :	JmGO-G1
Temperature :	25 °C	Relative Humidity :	56%
Pressure :	1015 hPa	Test Voltage :	DC 19.0V form Adapter AC 120V/60Hz
Test Mode :	TX Mode /CH00, CH19, CH39		

Frequency	Power Density (dBm)	Limit (dBm)	Result
2402 MHz	-21.85	8	PASS
2440 MHz	-21.22	8	PASS
2480 MHz	-20.85	8	PASS

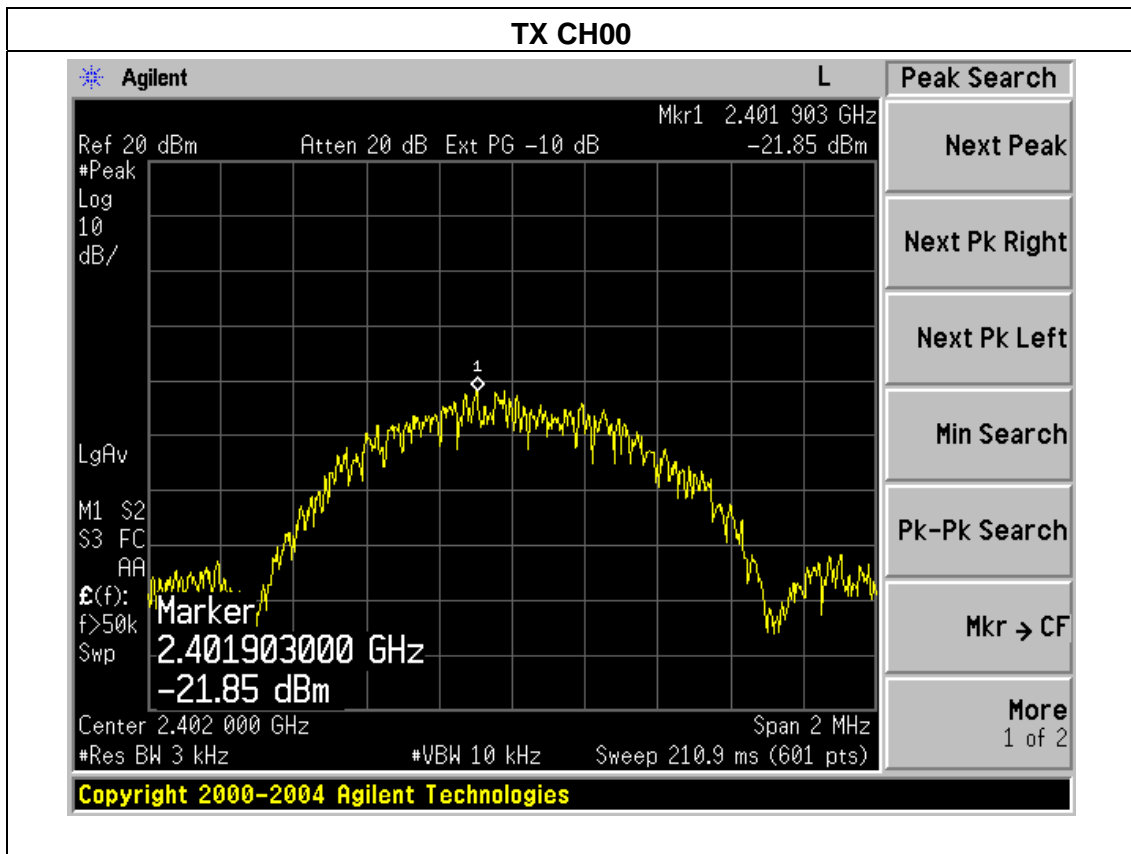

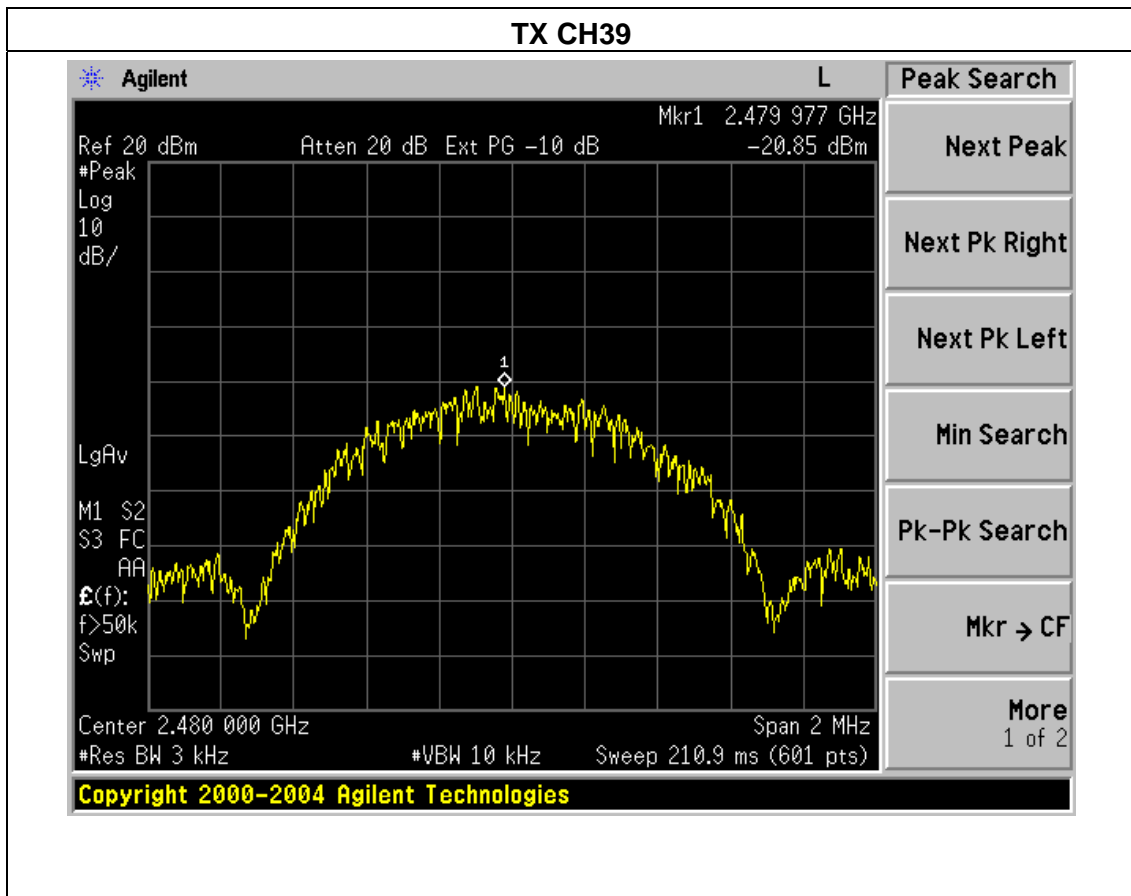
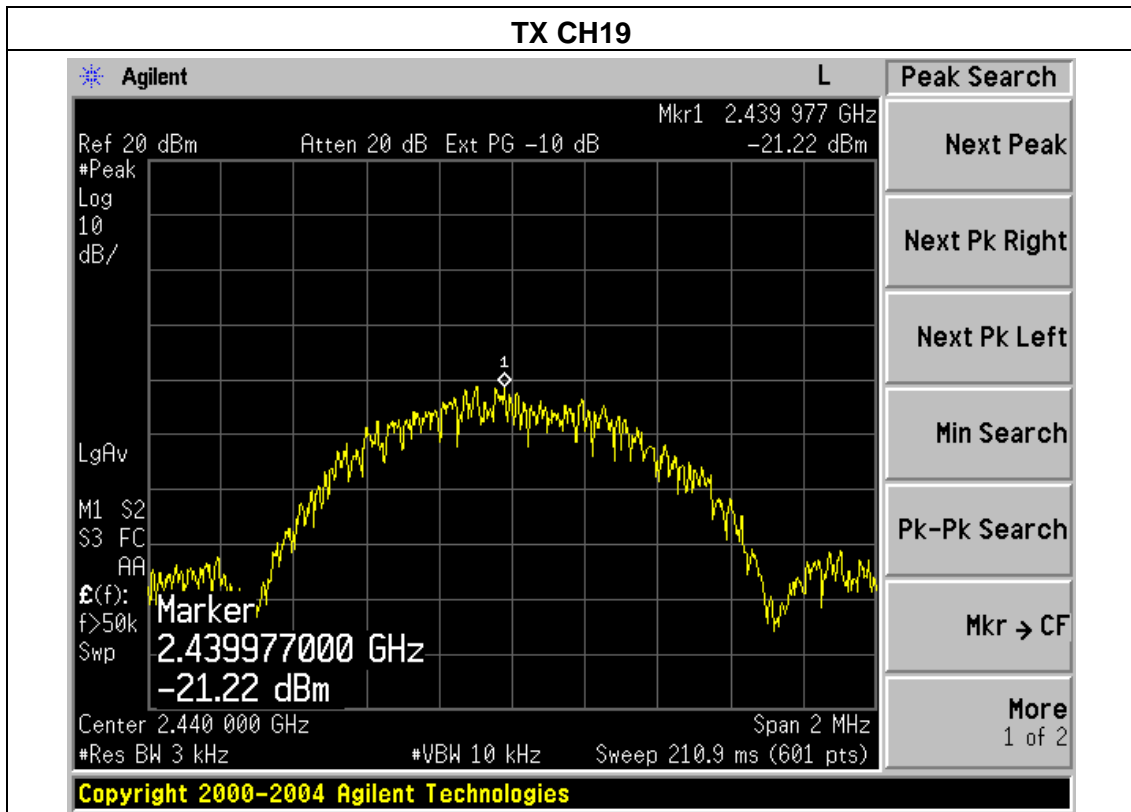

## 5. BANDWIDTH TEST

### 5.1 APPLIED PROCEDURES / LIMIT

FCC Part15 (15.247) , Subpart C				
Section	Test Item	Limit	Frequency Range (MHz)	Result
15.247(a)(2)	Bandwidth	$\geq 500\text{KHz}$ (6dB bandwidth)	2400-2483.5	PASS

#### 5.1.1 TEST PROCEDURE

1. Set RBW = 100 kHz.
2. Set the video bandwidth (VBW)  $\geq 3 \times$  RBW.
3. Detector = Peak.
4. Trace mode = max hold.
5. Sweep = auto couple.
6. Allow the trace to stabilize.
7. Measure the maximum width of the emission that is constrained by the frequencies associated with the two outermost amplitude points (upper and lower) that are attenuated by 6 dB relative to the maximum level measured in the fundamental emission.

#### TEST SETUP

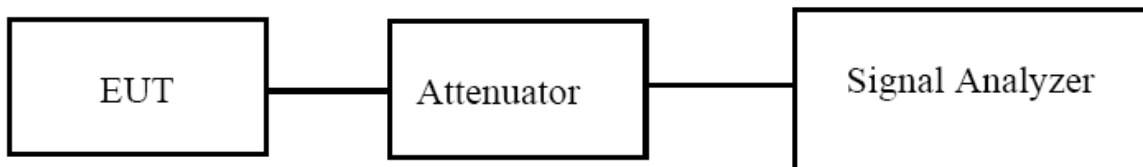

#### 5.1.2 EUT OPERATION CONDITIONS

The EUT tested system was configured as the statements of 2.4 Unless otherwise a special operating condition is specified in the follows during the testing.

### 5.1.3 TEST RESULTS

EUT :	Smart Projector	Model Name :	JmGO-G1
Temperature :	25 °C	Relative Humidity :	56%
Pressure :	1012 hPa	Test Voltage :	DC 19.0V form Adapter AC 120V/60Hz
Test Mode :	TX Mode /CH00, CH19, CH39		

Channel	Frequency (MHz)	6dB bandwidth (kHz)	Limit (kHz)	Result
Low	2402	699.109	500	Pass
Middle	2440	704.488	500	Pass
High	2480	701.158	500	Pass

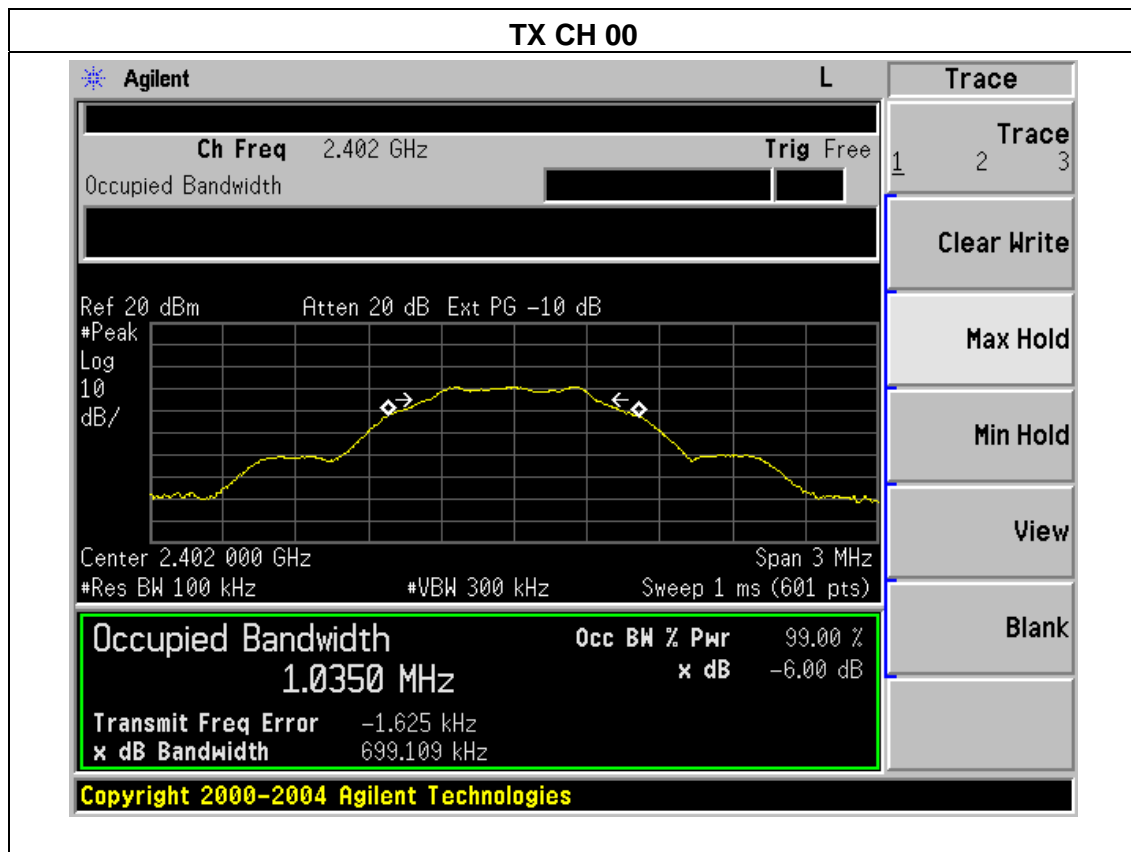

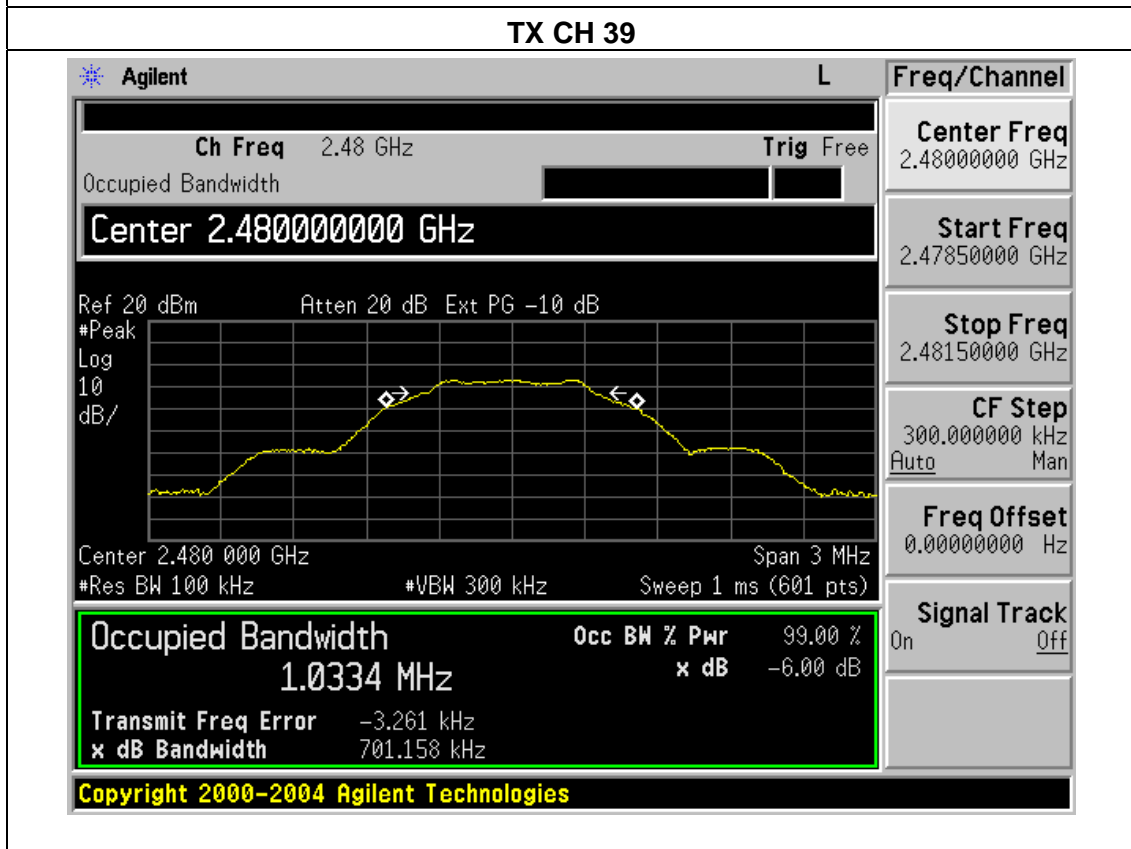
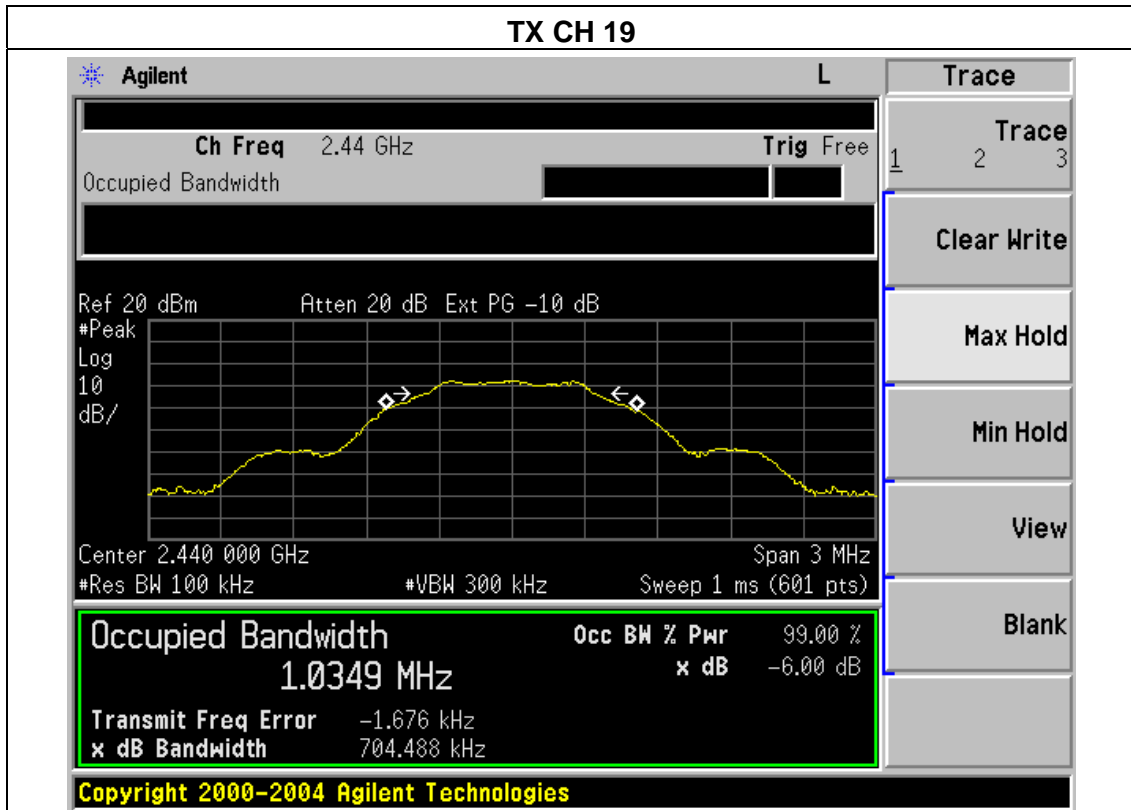

**6. PEAK OUTPUT POWER TEST**

**6.1 APPLIED PROCEDURES / LIMIT**

FCC Part15 (15.247) , Subpart C				
Section	Test Item	Limit	Frequency Range (MHz)	Result
15.247(b)(3)	Peak Output Power	1 watt or 30dBm	2400-2483.5	PASS

**6.1.1 TEST PROCEDURE**

- a. The EUT was directly connected to the Power meter

**6.1.2 DEVIATION FROM STANDARD**

No deviation.

**6.1.3 TEST SETUP**



**6.1.4 EUT OPERATION CONDITIONS**

The EUT tested system was configured as the statements of 2.4 Unless otherwise a special operating condition is specified in the follows during the testing.

**6.1.5 TEST RESULTS**

EUT :	Smart Projector	Model Name :	JmGO-G1
Temperature :	25 °C	Relative Humidity :	60%
Pressure :	1012 hPa	Test Voltage :	DC 19.0V form Adapter AC 120V/60Hz
Test Mode :	TX Mode		

Test Channe	Frequency	Maximum Conducted Output Power(PK)	LIMIT
	(MHz)	(dBm)	dBm
CH00	2402	-4.42	30
CH19	2440	-4.37	30
CH39	2480	-4.45	30

**7. 100 KHZ BANDWIDTH OF FREQUENCY BAND EDGE**

**APPLICABLE STANDARD**

In any 100 kHz bandwidth outside the frequency band in which the spread spectrum or digitally modulated intentional radiator is operating, the radio frequency power that is produced by the intentional radiator shall be at least 20 dB below that in the 100 kHz bandwidth within the band that contains the highest level of the desired power, based on either an RF conducted or a radiated measurement, provided the transmitter demonstrates compliance with the peak conducted power limits. If the transmitter complies with the conducted power limits based on the use of RMS averaging over a time interval, as permitted under paragraph (b)(3) of this section, the attenuation required under this paragraph shall be 30 dB instead of 20 dB. Attenuation below the general limits specified in §15.209(a) is not required. In addition, radiated emissions which fall in the restricted bands, as defined in §15.205(a), must also comply with the radiated emission limits specified in §15.209(a) (see §15.205(c)).

**TEST PROCEDURE**

- a) Check the calibration of the measuring instrument using either an internal calibrator or a known signal from an external generator.
- b) Position the EUT without connection to measurement instrument. Turn on the EUT and connect its antenna terminal to measurement instrument via a low loss cable. Then set it to any one measured frequency within its operating range, and make sure the instrument is operated in its linear range.
- c) Set RBW to 100 kHz and VBW of spectrum analyzer to 300 kHz with a convenient frequency span including 100 kHz bandwidth from band edge.
- d) Measure the highest amplitude appearing on spectral display and set it as a reference level. Plot the graph with marking the highest point and edge frequency.
- e) Repeat above procedures until all measured frequencies were complete.

**7.1 DEVIATION FROM STANDARD**

No deviation.

**7.2 TEST SETUP**

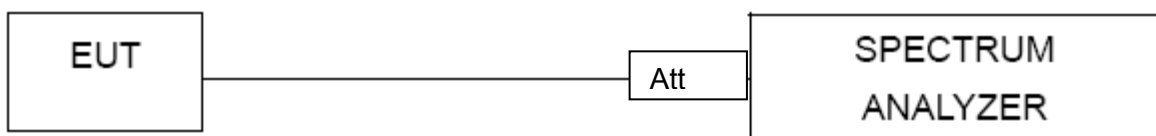

**7.3 EUT OPERATION CONDITIONS**

The EUT tested system was configured as the statements of 2.4 Unless otherwise a special operating condition is specified in the follows during the testing.



### 7.4 TEST RESULTS

EUT :	Smart Projector	Model Name :	JmGO-G1
Temperature :	25 °C	Relative Humidity :	56%
Pressure :	1012 hPa	Test Voltage :	DC 19.0V form Adapter AC 120V/60Hz

Frequency Band	Delta Peak to band emission (dBc)	> Limit (dBc)	Result
2400	53.21	20	Pass
2483.5	55.67	20	Pass

#### Radiated band edge:

Frequency (MHz)	Meter Reading (dBµV)	Factor (dB)	Emission Level (dBµV/m)	Limits (dBµV/m)	Margin (dB)	Detector Type	Comment
2390	56.58	-13.06	43.52	74	-30.48	peak	Vertical
2390	56.38	-13.06	43.32	74	-30.68	peak	Horizontal
2483.5	57.51	-12.78	44.73	74	-29.27	peak	Vertical
2483.5	57.56	-12.78	44.78	74	-29.22	peak	Horizontal

Note: Test method to see chapter 3.2 . When PK value is lower than the Average value limit, average not record.

Left Side

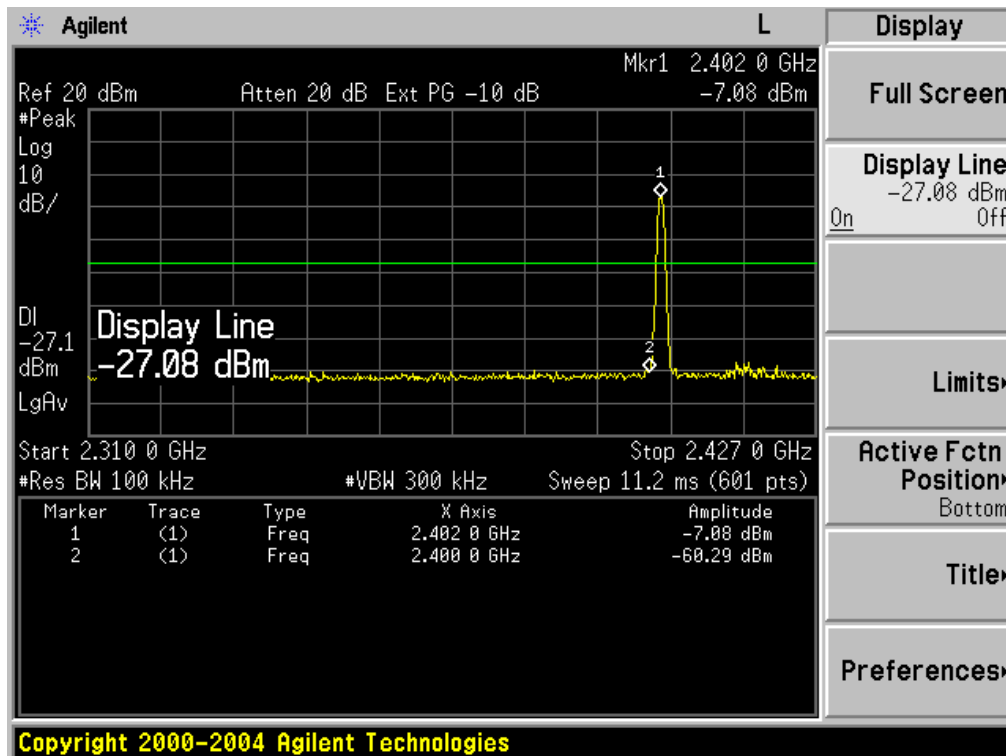

Right Side

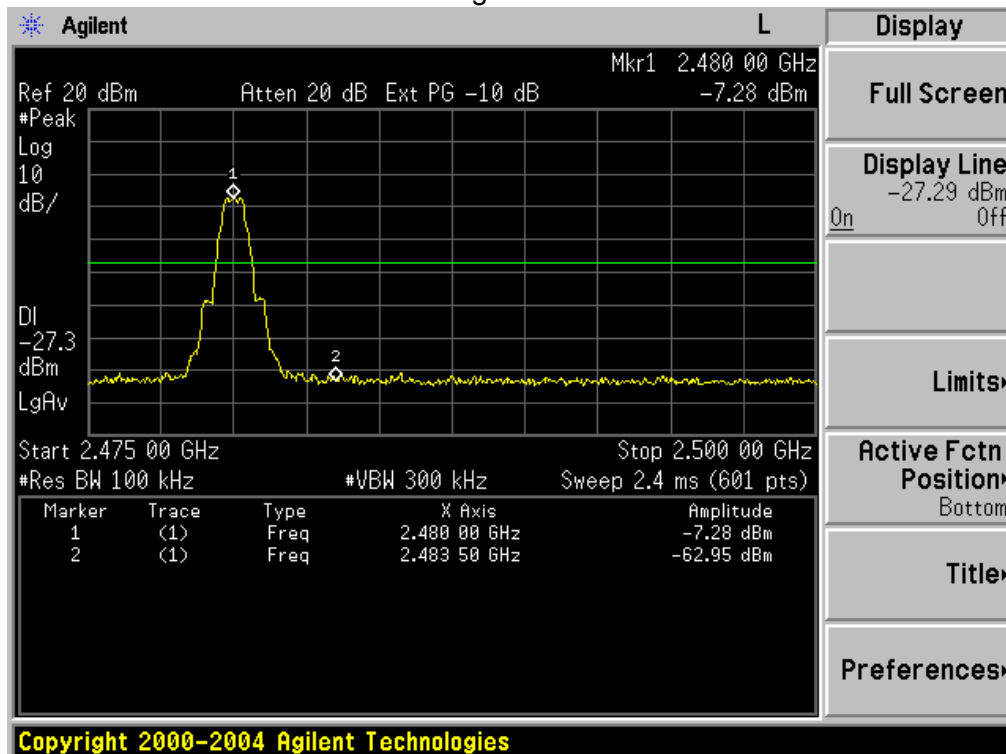

## **8. ANTENNA REQUIREMENT**

### **8.1 STANDARD REQUIREMENT**

15.203 requirement: For intentional device, according to 15.203: an intentional radiator shall be designed to ensure that no antenna other than that furnished by the responsible party shall be used with the device.

### **8.2 EUT ANTENNA**

The EUT antenna is permanent attached antenna. It comply with the standard requirement.

**9. EUT TEST PHOTO**

**Radiated Measurement Photos**

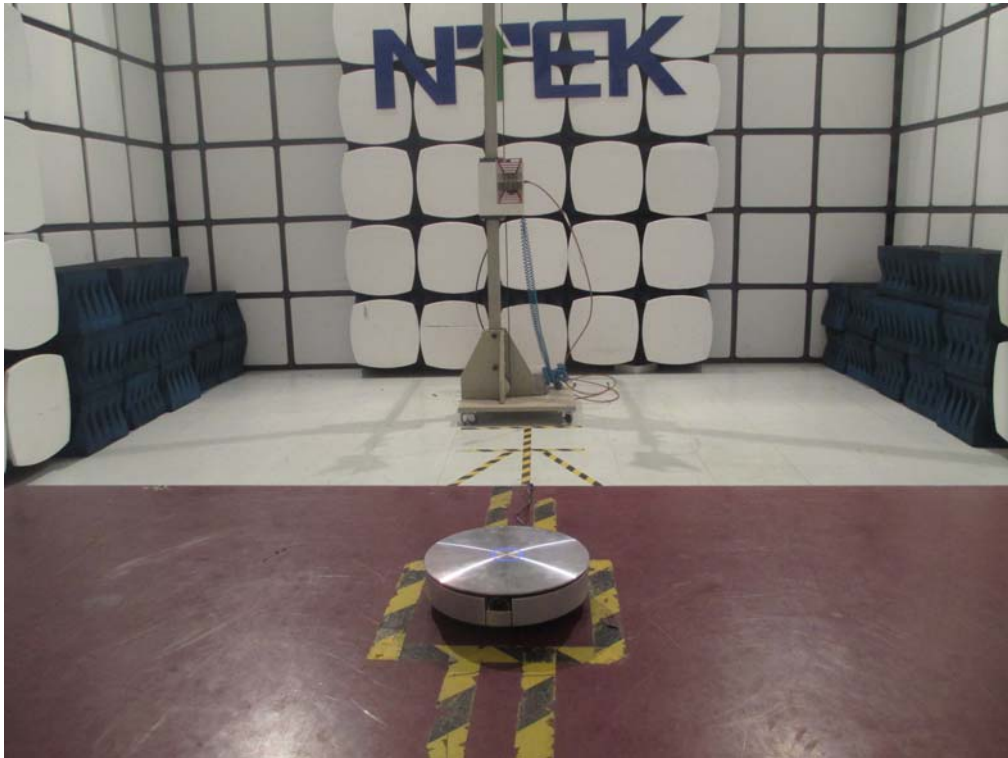
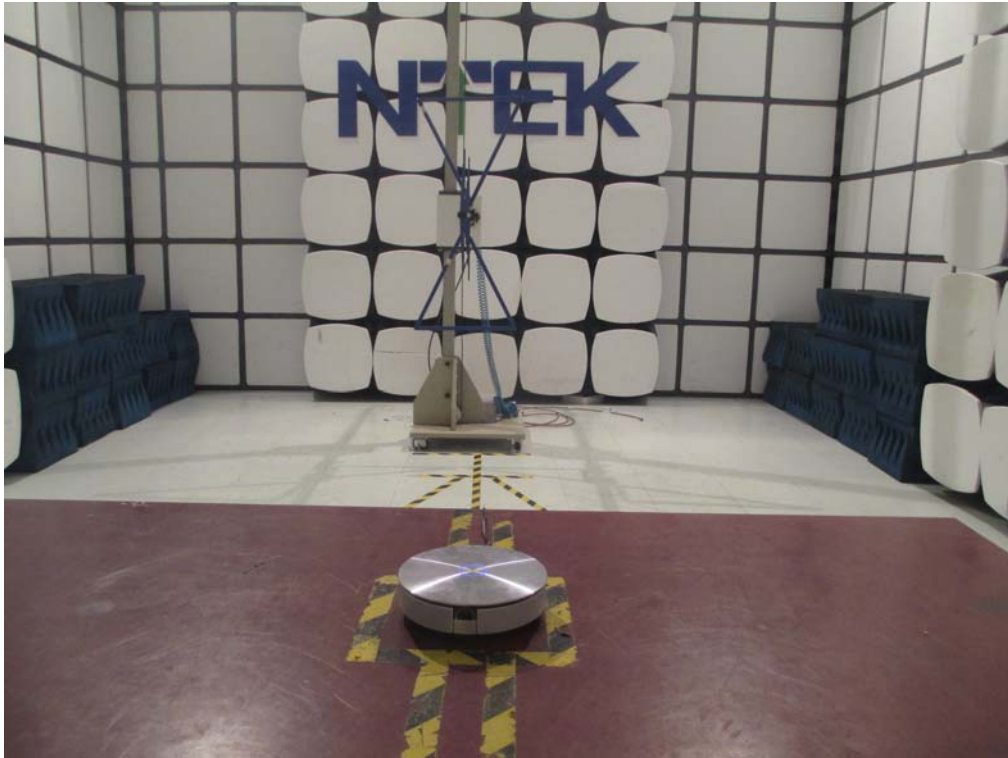

**Conducted Measurement Photos**

