



FCC PART 15 SUBPART C TEST REPORT

FCC PART 15.247

Report Reference No.....: GRCTR230302023-02

FCC ID.....: SMC-J70

Compiled by
(position+printed name+signature)..: Testing Engineer Jimmy Wang

Supervised by
(position+printed name+signature)..: Project Engineer Kelley Zhang

Approved by
(position+printed name+signature)..: Manager Sam Wang

Date of issue.....: Apr. 17, 2023

Testing Laboratory Name.....: Shenzhen GUOREN Certification Technology Service Co., Ltd.

Address.....: 101#, Building K & Building T, The Second Industrial Zone, Jiazitang Community, Fenghuang Street, Guangming District, Shenzhen, China

Applicant's name.....: SHENZHEN HOLATEK CO., LTD.

Address.....: #12,Building 1,Chongwen Park, Nanshan Zhiyuan,3370 Liuxian Ave, Nanshan District, Shenzhen, China

Test specification.....:

Standard.....: FCC Part 15.247

Shenzhen GUOREN Certification Technology Service Co., Ltd. All rights reserved.

This publication may be reproduced in whole or in part for non-commercial purposes as long as the Shenzhen GUOREN Certification Technology Service Co., Ltd. is acknowledged as copyright owner and source of the material. Shenzhen GUOREN Certification Technology Service Co., Ltd. takes no responsibility for and will not assume liability for damages resulting from the reader's interpretation of the reproduced material due to its placement and context.

Test item description.....: Smart Projector

Trade Mark.....: JMGO

Manufacturer.....: SHENZHEN HOLATEK CO., LTD.

Model/Type reference.....: J70-6A1

Listed Models: J70-6A2,J70-6A3,J70-6A4,J70-6A5,J70-6A6,J70-6A7,J70-6A8,J70-6A9,J70-6AA,J70-6AB,J70-6AC,J70-6AD,J70-6AE,J70-6AF,J70-6AG,J70-6AH,J70-6AJ,J70-6AK,J70-6AM,J70-6AN,J70-6AL,J70-6AO,J70-6AP,J70-6AQ

Firmware Version.....: 1.1.21.1

Hardware Version.....: Ver C

Modulation: GFSK

Frequency.....: From 2402MHz to 2480MHz

Ratings.....: DC 24V from external circuit

Result.....: PASS

TEST REPORT

Equipment under Test : Smart Projector

Model /Type : J70-6A1

Listed Models : J70-6A2,J70-6A3,J70-6A4,J70-6A5,J70-6A6,J70-6A7,J70-6A8,J70-6A9,J70-6AA,J70-6AB,J70-6AC,J70-6AD,J70-6AE, J70-6AF,J70-6AG,J70-6AH,J70-6AJ,J70-6AK,J70-6AM,J70-6AN,J70-6AL,J70-6AO,J70-6AP,J70-6AQ

Applicant : **SHENZHEN HOLATEK CO., LTD.**

Address : #12,Building 1,Chongwen Park, Nanshan Zhiyuan,3370 Liuxian Ave, Nanshan District, Shenzhen, China

Manufacturer : **SHENZHEN HOLATEK CO., LTD.**

Address : #12,Building 1,Chongwen Park, Nanshan Zhiyuan,3370 Liuxian Ave, Nanshan District, Shenzhen, China

Test Result:	PASS
---------------------	-------------

The test report merely corresponds to the test sample.
It is not permitted to copy extracts of these test result without the written permission of the test laboratory.

Contents

1 TEST STANDARDS	4
2 SUMMARY	5
2.1 General Remarks	5
2.2 Product Description	5
2.3 Equipment Under Test	5
2.4 Short description of the Equipment under Test (EUT)	6
2.5 EUT operation mode	6
2.6 Block Diagram of Test Setup	6
2.7 Related Submittal(s) / Grant (s)	6
2.8 Modifications	6
3 TEST ENVIRONMENT	7
3.1 Address of the test laboratory	7
3.2 Test Facility	7
3.3 Environmental conditions	7
3.4 Summary of measurement results	8
3.5 Statement of the measurement uncertainty	8
3.6 Equipments Used during the Test	9
4 TEST CONDITIONS AND RESULTS	10
4.1 AC Power Conducted Emission	10
4.2 Radiated Emissions and Band Edge	13
4.3 Maximum Peak Output Power	19
4.4 Power Spectral Density	20
4.5 6dB Bandwidth	22
4.6 Out-of-band Emissions	24
4.7 Antenna Requirement	29
5 TEST SETUP PHOTOS OF THE EUT	30
6 PHOTOS OF THE EUT	31

1 TEST STANDARDS

The tests were performed according to following standards:

[FCC Rules Part 15.247](#): Frequency Hopping, Direct Spread Spectrum and Hybrid Systems that are in operation within the bands of 902-928 MHz, 2400-2483.5 MHz, and 5725-5850 MHz.

[ANSI C63.10-2013](#): American National Standard for Testing Unlicensed Wireless Devices

[KDB558074 D01 V05r02](#): Guidance for Performing Compliance Measurements on Digital Transmission Systems (DTS) Operating Under §15.247

2 SUMMARY

2.1 General Remarks

Date of receipt of test sample	:	Mar. 28, 2023
Testing commenced on	:	Mar. 28, 2023
Testing concluded on	:	Apr. 17, 2023

2.2 Product Description

Product Name:	Smart Projector
Model/Type reference:	J70-6A1
Listed Models:	J70-6A2,J70-6A3,J70-6A4,J70-6A5,J70-6A6,J70-6A7,J70-6A8,J70-6A9,J70-6AA,J70-6AB,J70-6AC,J70-6AD,J70-6AE,J70-6AF,J70-6AG,J70-6AH,J70-6AJ,J70-6AK,J70-6AM,J70-6AN,J70-6AL,J70-6AO,J70-6AP,J70-6AQ (The electrical circuit design, layout, components used and internal wiring are identical. Only the body color, pattern, sales customers, and sales regions are different.)
Power supply:	DC 24V from external circuit
Adapter information:	M/N:NSA100EC-24041700 Input:AC 100-240V 50/60Hz 2.0A Output:DC 24V/4.17A
Testing sample ID:	GRCTR230302023-1# (Engineer sample), GRCTR230302023-2# (Normal sample)
Bluetooth	
Supported type:	Bluetooth low Energy
Modulation:	GFSK
Operation frequency:	2402MHz to 2480MHz
Channel number:	40
Channel separation:	2 MHz
Antenna type:	FPC antenna
Antenna gain*(Supplied by the customer):	2.79 dBi
Remark:*When the information provided by the customer was used to calculate test results, if the information provided by the customer is not accurate, shenzhen GUOREN Certification Technology Service Co., Ltd. does not assume any responsibility.	

2.3 Equipment Under Test

Power supply system utilised

Power supply voltage	:	<input type="radio"/> 230V / 50 Hz	<input type="radio"/> 120V / 60Hz
		<input type="radio"/> 12 V DC	<input type="radio"/> 24 V DC
		<input checked="" type="radio"/> Other (specified in blank below)	

DC 24V from external circuit

2.4 Short description of the Equipment under Test (EUT)

This is a Smart Projector.
 For more details, refer to the user’s manual of the EUT.

2.5 EUT operation mode

The Applicant provides communication tools software(RtlBluetoothMP) to control the EUT for staying in continuous transmitting (Duty Cycle more than 98%) and receiving mode for testing .There are 40 channels provided to the EUT and Channel 00/19/39 were selected to test.

Operation Frequency:

Channel	Frequency (MHz)
00	2402
01	2404
02	2406
⋮	⋮
19	2440
⋮	⋮
37	2476
38	2478
39	2480

2.6 Block Diagram of Test Setup

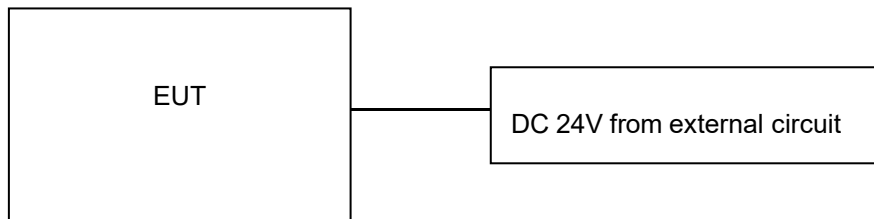

2.7 Related Submittal(s) / Grant (s)

This submittal(s) (test report) is intended for the device filing to comply with Section 15.247 of the FCC Part 15, Subpart C Rules.

2.8 Modifications

No modifications were implemented to meet testing criteria.

3 TEST ENVIRONMENT

3.1 Address of the test laboratory

Shenzhen GUOREN Certification Technology Service Co., Ltd.

101#, Building K & Building T, The Second Industrial Zone, Jiazitang Community, Fenghuang Street, Guangming District, Shenzhen, China

3.2 Test Facility

The test facility is recognized, certified, or accredited by the following organizations:

FCC-Registration No.: 920798 Designation Number: CN1304

Shenzhen GUOREN Certification Technology Service Co., Ltd. has been listed on the US Federal Communications Commission list of test facilities recognized to perform electromagnetic emissions measurements.

A2LA-Lab Cert. No.: 6202.01

Shenzhen GUOREN Certification Technology Service Co., Ltd. has been listed by American Association for Laboratory Accreditation to perform electromagnetic emission measurement.

ISED#: 27264 CAB identifier: CN0115

Shenzhen GUOREN Certification Technology Service Co., Ltd. has been listed by Innovation, Science and Economic Development Canada to perform electromagnetic emission measurement.

CNAS-Lab Code: L15631

Shenzhen GUOREN Certification Technology Service Co., Ltd. has been assessed and proved to be in compliance with CNAS-CL01 Accreditation Criteria for Testing and Calibration Laboratories for the Competence of Testing and Calibration Laboratories.

The 3m-Semi anechoic test site fulfils CISPR 16-1-4 according to ANSI C63.10 and CISPR 16-1-4:2010.

3.3 Environmental conditions

During the measurement the environmental conditions were within the listed ranges:

Normal Temperature	15-35 °C
Relative Humidity	30-60 %
Air Pressure	950-1050mbar

3.4 Summary of measurement results

Test Specification clause	Test case	Test Mode	Test Channel	Recorded In Report		Test result
§15.247(e)	Power spectral density	BLE 1Mbps BLE 2Mbps	<input checked="" type="checkbox"/> Lowest <input checked="" type="checkbox"/> Middle <input checked="" type="checkbox"/> Highest	BLE 1Mbps BLE 2Mbps	<input checked="" type="checkbox"/> Lowest <input checked="" type="checkbox"/> Middle <input checked="" type="checkbox"/> Highest	complies
§15.247(a)(2)	Spectrum bandwidth – 6 dB bandwidth	BLE 1Mbps BLE 2Mbps	<input checked="" type="checkbox"/> Lowest <input checked="" type="checkbox"/> Middle <input checked="" type="checkbox"/> Highest	BLE 1Mbps BLE 2Mbps	<input checked="" type="checkbox"/> Lowest <input checked="" type="checkbox"/> Middle <input checked="" type="checkbox"/> Highest	complies
§15.247(b)(3)	Maximum output Peak power	BLE 1Mbps BLE 2Mbps	<input checked="" type="checkbox"/> Lowest <input checked="" type="checkbox"/> Middle <input checked="" type="checkbox"/> Highest	BLE 1Mbps BLE 2Mbps	<input checked="" type="checkbox"/> Lowest <input checked="" type="checkbox"/> Middle <input checked="" type="checkbox"/> Highest	complies
§15.247(d)	Band edge compliance conducted	BLE 1Mbps BLE 2Mbps	<input checked="" type="checkbox"/> Lowest <input checked="" type="checkbox"/> Highest	BLE 1Mbps BLE 2Mbps	<input checked="" type="checkbox"/> Lowest <input checked="" type="checkbox"/> Highest	complies
§15.205	Band edge compliance radiated	BLE 1Mbps BLE 2Mbps	<input checked="" type="checkbox"/> Lowest <input checked="" type="checkbox"/> Highest	BLE 1Mbps	<input checked="" type="checkbox"/> Lowest <input checked="" type="checkbox"/> Highest	complies
§15.247(d)	TX spurious emissions conducted	BLE 1Mbps BLE 2Mbps	<input checked="" type="checkbox"/> Lowest <input checked="" type="checkbox"/> Middle <input checked="" type="checkbox"/> Highest	BLE 1Mbps BLE 2Mbps	<input checked="" type="checkbox"/> Lowest <input checked="" type="checkbox"/> Middle <input checked="" type="checkbox"/> Highest	complies
§15.247(d)	TX spurious emissions radiated	BLE 1Mbps BLE 2Mbps	<input checked="" type="checkbox"/> Lowest <input checked="" type="checkbox"/> Middle <input checked="" type="checkbox"/> Highest	BLE 1Mbps BLE 2Mbps	<input checked="" type="checkbox"/> Lowest <input checked="" type="checkbox"/> Middle <input checked="" type="checkbox"/> Highest	complies
§15.209(a)	TX spurious Emissions radiated Below 1GHz	BLE 1Mbps BLE 2Mbps	-/-	BLE 1Mbps	-/-	complies
§15.107(a) §15.207	Conducted Emissions < 30 MHz	BLE 1Mbps BLE 2Mbps	-/-	BLE 1Mbps	-/-	complies

Remark:

1. The measurement uncertainty is not included in the test result.
2. We tested all test mode and recorded worst case in report.
3. N/A means “not applicable”.

3.5 Statement of the measurement uncertainty

The data and results referenced in this document are true and accurate. The reader is cautioned that there may be errors within the calibration limits of the equipment and facilities. The measurement uncertainty was calculated for all measurements listed in this test report acc. to TR-100028-01” Electromagnetic compatibility and Radio spectrum Matters (ERM);Uncertainties in the measurement of mobile radio equipment characteristics; Part 1” and TR-100028-02 “Electromagnetic compatibility and Radio spectrum Matters (ERM);Uncertainties in the measurement of mobile radio equipment characteristics; Part 2 “ and is documented in the Shenzhen GUOREN Certification Technology Service Co., Ltd.quality system acc. to DIN EN ISO/IEC 17025. Furthermore, component and process variability of devices similar to that tested may result in additional deviation. The manufacturer has the sole responsibility of continued compliance of the device.

Hereafter the best measurement capability for Shenzhen GUOREN Certification Technology Service Co., Ltd.:

Test	Range	Measurement Uncertainty	Notes
Radiated Emission	30~1000MHz	4.06 dB	(1)
Radiated Emission	1~18GHz	5.14 dB	(1)
Radiated Emission	18~40GHz	5.38 dB	(1)
Conducted Disturbance	0.15~30MHz	2.14 dB	(1)

(1) This uncertainty represents an expanded uncertainty expressed at approximately the 95% confidence level using a coverage factor of $k=2$.

3.6 Equipments Used during the Test

Test Equipment	Manufacturer	Model No.	Equipment No.	Calibration Date	Calibration Due Date
LISN	R&S	ENV216	GRCTEE009	2022/10/12	2023/10/11
LISN	R&S	ENV216	GRCTEE010	2022/10/12	2023/10/11
EMI Test Receiver	R&S	ESPI	GRCTEE017	2022/10/12	2023/10/11
EMI Test Receiver	R&S	ESCI	GRCTEE008	2022/10/12	2023/10/11
Spectrum Analyzer	Agilent	N9020A	GRCTEE002	2022/10/12	2023/10/11
Spectrum Analyzer	R&S	FSP	GRCTEE003	2022/10/12	2023/10/11
Vector Signal generator	Agilent	N5181A	GRCTEE007	2022/10/12	2023/10/11
Analog Signal Generator	R&S	SML03	GRCTEE006	2022/10/12	2023/10/11
Climate Chamber	QIYA	LCD-9530	GRCTES016	2022/10/12	2023/10/11
Ultra-Broadband Antenna	Schwarzbeck	VULB9163	GRCTEE018	2020/10/25	2023/10/24
Horn Antenna	Schwarzbeck	BBHA 9120D	GRCTEE019	2020/10/25	2023/10/24
Loop Antenna	Zhinan	ZN30900C	GRCTEE020	2020/10/25	2023/10/24
Horn Antenna	Beijing Hangwei Dayang	OBH100400	GRCTEE049	2021/1/18	2024/1/17
Amplifier	Schwarzbeck	BBV 9745	GRCTEE021	2022/10/12	2023/10/11
Amplifier	Taiwan chengyi	EMC051845B	GRCTEE022	2022/10/12	2023/10/11
Temperature/Humidity Meter	Huaguan	HG-308	GRCTES037	2022/10/12	2023/10/11
Directional coupler	NARDA	4226-10	GRCTEE004	2022/10/12	2023/10/11
High-Pass Filter	XingBo	XBLBQ-GTA18	GRCTEE053	2022/10/12	2023/10/11
High-Pass Filter	XingBo	XBLBQ-GTA27	GRCTEE054	2022/10/12	2023/10/11
Automated filter bank	Tonscend	JS0806-F	GRCTEE055	2022/10/12	2023/10/11
Power Sensor	Agilent	U2021XA	GRCTEE070	2022/10/12	2023/10/11
EMI Test Software	ROHDE & SCHWARZ	ESK1-V1.71	GRCTEE060	N/A	N/A
EMI Test Software	Fera	EZ-EMC	GRCTEE061	N/A	N/A

4 TEST CONDITIONS AND RESULTS

4.1 AC Power Conducted Emission

TEST CONFIGURATION

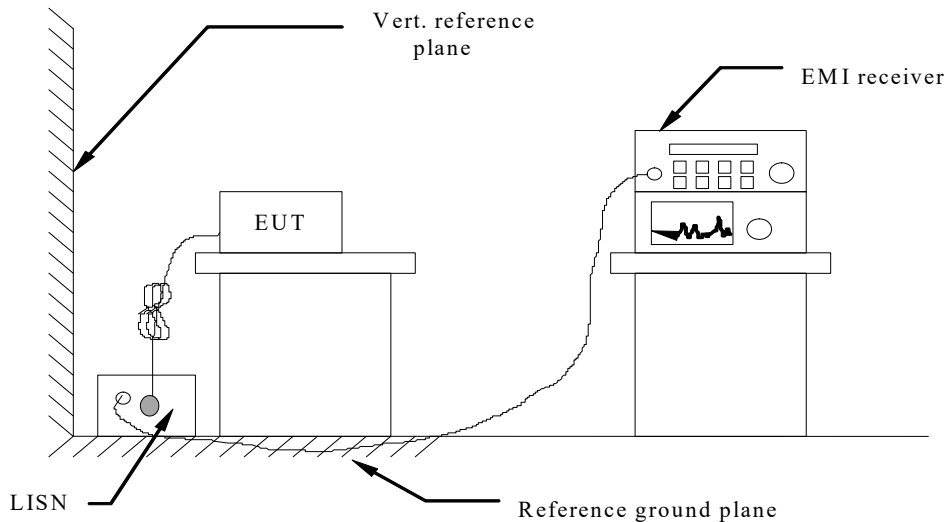

TEST PROCEDURE

- 1 The equipment was set up as per the test configuration to simulate typical actual usage per the user's manual. The EUT is a tabletop system, a wooden table with a height of 0.8 meters is used and is placed on the ground plane as per ANSI C63.10-2013.
- 2 Support equipment, if needed, was placed as per ANSI C63.10-2013
- 3 All I/O cables were positioned to simulate typical actual usage as per ANSI C63.10-2013
- 4 The EUT received power from adapter, the adapter received AC120V/60Hz and AC 240V/60Hz power through a Line Impedance Stabilization Network (LISN) which supplied power source and was grounded to the ground plane.
- 5 All support equipments received AC power from a second LISN, if any.
- 6 The EUT test program was started. Emissions were measured on each current carrying line of the EUT using a spectrum Analyzer / Receiver connected to the LISN powering the EUT. The LISN has two monitoring points: Line 1 (Hot Side) and Line 2 (Neutral Side). Two scans were taken: one with Line 1 connected to Analyzer / Receiver and Line 2 connected to a 50 ohm load; the second scan had Line 1 connected to a 50 ohm load and Line 2 connected to the Analyzer / Receiver.
- 7 Analyzer / Receiver scanned from 150 KHz to 30MHz for emissions in each of the test modes.
- 8 During the above scans, the emissions were maximized by cable manipulation.

AC Power Conducted Emission Limit

For intentional device, according to § 15.207(a) AC Power Conducted Emission Limits is as following:

Frequency range (MHz)	Limit (dBuV)	
	Quasi-peak	Average
0.15-0.5	66 to 56*	56 to 46*
0.5-5	56	46
5-30	60	50

* Decreases with the logarithm of the frequency.

TEST RESULTS

Remark:

1. BLE 1Mbps and BLE 2Mbps were tested at Low, Middle, and High channel and recorded worst mode at BLE 1Mbps:

2. Both 120 VAC, 50/60 Hz and 240 VAC, 50/60 Hz power supply have been tested, only the worst result of 120 VAC, 60 Hz was reported as below:

Power supply:	DC 24V from Adapter AC 120V/60Hz	Polarization	L
---------------	-------------------------------------	--------------	---

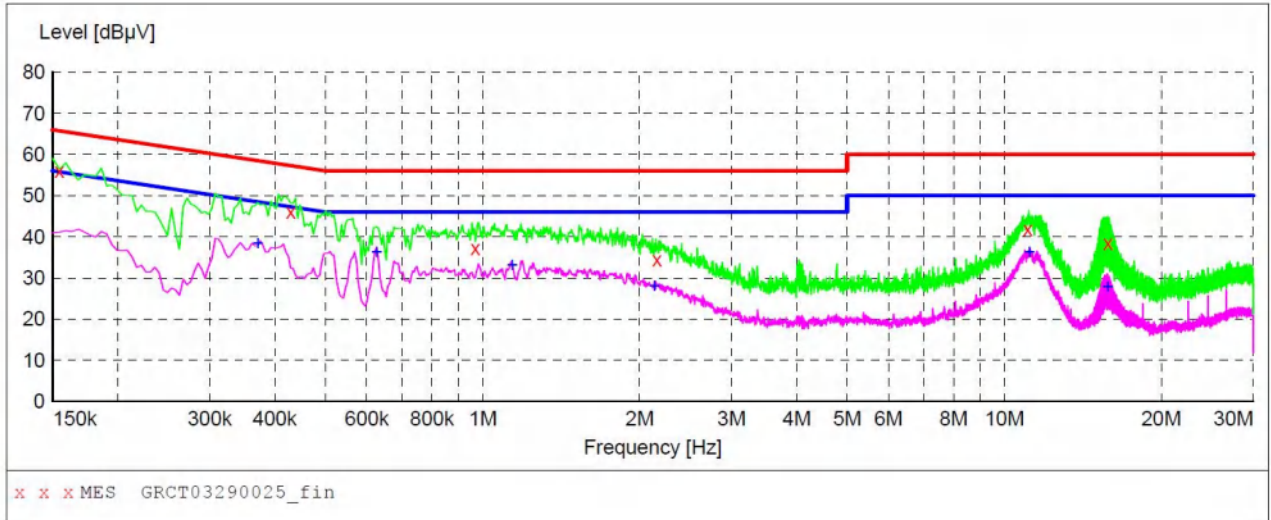

MEASUREMENT RESULT: "GRCT03290025_fin"

3/29/2023 2:41PM

Frequency MHz	Level dBµV	Transd dB	Limit dBµV	Margin dB	Detector	Line	PE
0.154500	56.10	9.7	66	9.7	QP	L1	GND
0.429000	46.00	9.7	57	11.3	QP	L1	GND
0.969000	37.30	9.9	56	18.7	QP	L1	GND
2.161500	34.40	9.9	56	21.6	QP	L1	GND
11.094000	41.80	10.1	60	18.2	QP	L1	GND
15.801000	38.50	10.2	60	21.5	QP	L1	GND

MEASUREMENT RESULT: "GRCT03290025_fin2"

3/29/2023 2:41PM

Frequency MHz	Level dBµV	Transd dB	Limit dBµV	Margin dB	Detector	Line	PE
0.370500	38.40	9.7	49	10.1	AV	L1	GND
0.627000	36.40	9.7	46	9.6	AV	L1	GND
1.140000	33.30	9.9	46	12.7	AV	L1	GND
2.134500	28.10	9.9	46	17.9	AV	L1	GND
11.175000	36.30	10.1	50	13.7	AV	L1	GND
15.756000	27.90	10.2	50	22.1	AV	L1	GND

- Note:1).Level (dBµV)= Reading (dBµV)+ Transducer (dB)
- 2). Transducer (dB)=insertion loss of LISN (dB) + Cable loss (dB)
- 3). Margin(dB) = Limit (dBµV) - Level (dBµV)

Power supply:	DC 24V from Adapter AC 120V/60Hz	Polarization	N
---------------	-------------------------------------	--------------	---

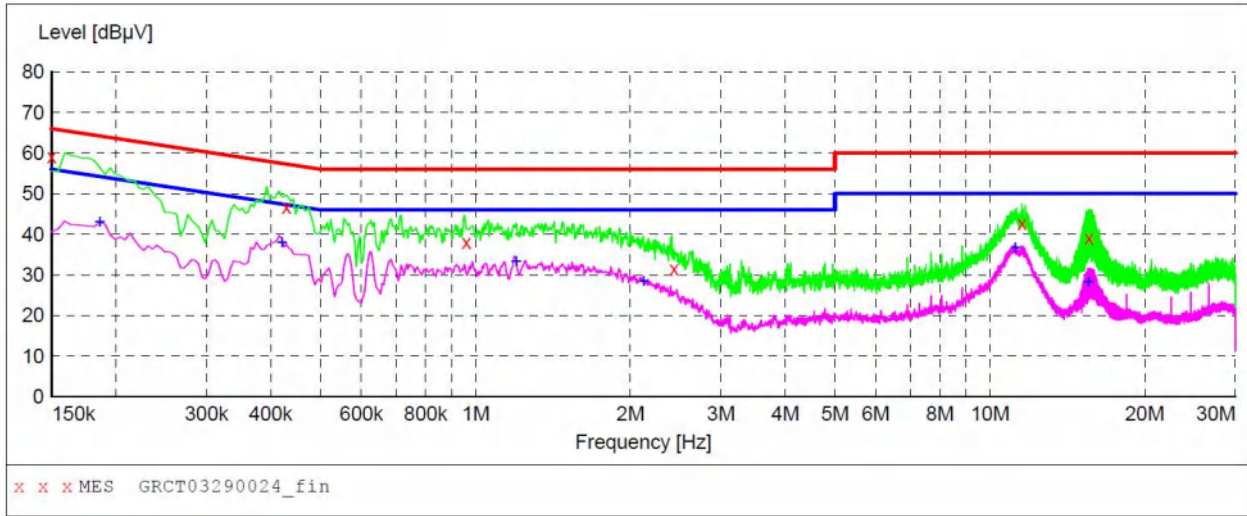

MEASUREMENT RESULT: "GRCT03290024_fin"

3/29/2023 2:38PM

Frequency MHz	Level dBµV	Transd dB	Limit dBµV	Margin dB	Detector	Line	PE
0.150000	59.20	9.7	66	6.8	QP	N	GND
0.429000	46.70	9.7	57	10.6	QP	N	GND
0.960000	38.00	9.9	56	18.0	QP	N	GND
2.431500	31.40	9.9	56	24.6	QP	N	GND
11.553000	42.60	10.1	60	17.4	QP	N	GND
15.625500	39.20	10.2	60	20.8	QP	N	GND

MEASUREMENT RESULT: "GRCT03290024_fin2"

3/29/2023 2:38PM

Frequency MHz	Level dBµV	Transd dB	Limit dBµV	Margin dB	Detector	Line	PE
0.186000	43.00	9.7	54	11.2	AV	N	GND
0.420000	38.10	9.7	47	9.3	AV	N	GND
1.198500	33.40	9.9	46	12.6	AV	N	GND
2.121000	28.50	9.9	46	17.5	AV	N	GND
11.197500	36.70	10.1	50	13.3	AV	N	GND
15.531000	28.40	10.2	50	21.6	AV	N	GND

- Note:1).Level (dBµV)= Reading (dBµV)+ Transducer (dB)
 2). Transducer (dB)=insertion loss of LISN (dB) + Cable loss (dB)
 3). Margin(dB) = Limit (dBµV) - Level (dBµV)

4.2 Radiated Emissions and Band Edge

TEST CONFIGURATION

Frequency range 9 KHz – 30MHz

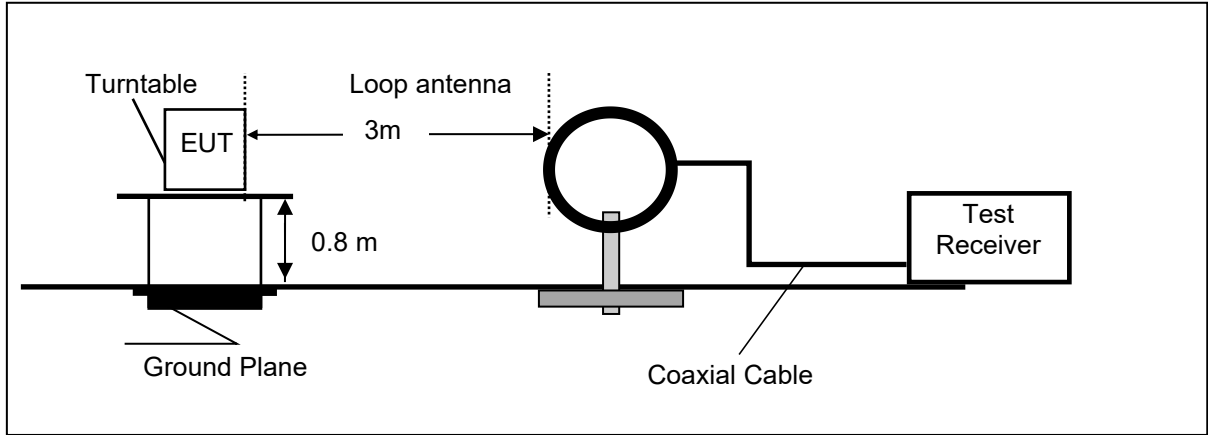

Frequency range 30MHz – 1000MHz

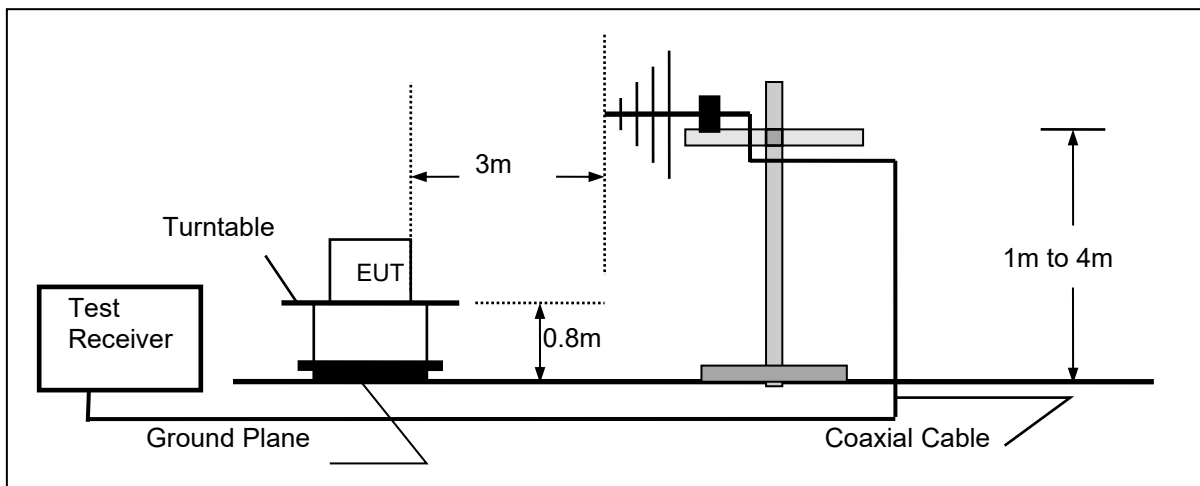

Frequency range above 1GHz-25GHz

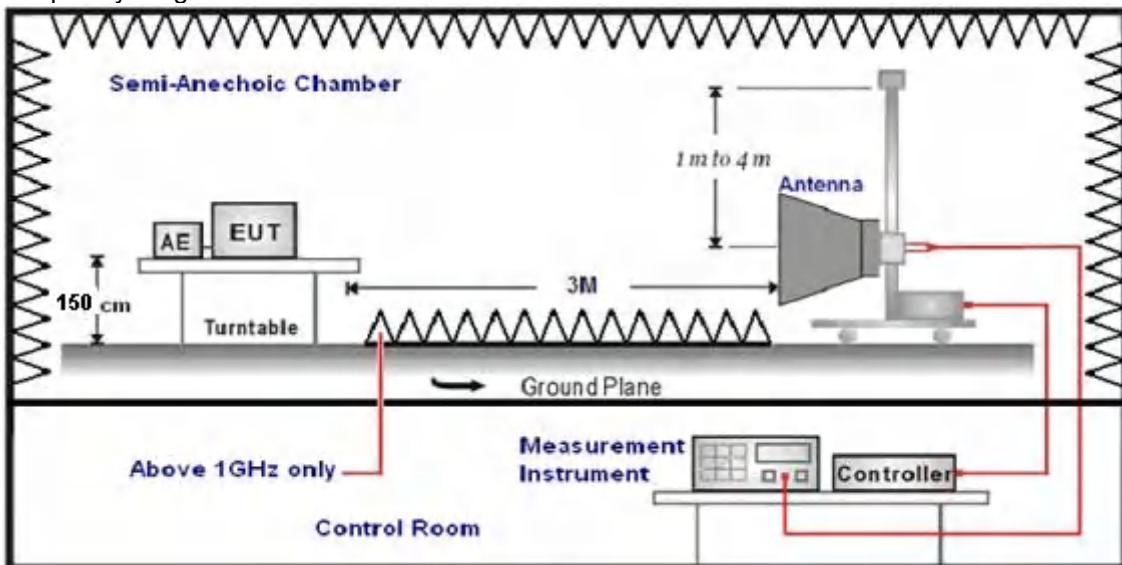

TEST PROCEDURE

1. The EUT was placed on a turn table which is 0.8m above ground plane when testing frequency range 9 KHz –1GHz, the EUT was placed on a turn table which is 1.5m above ground plane when testing frequency range 1GHz – 25GHz.
2. Maximum procedure was performed by raising the receiving antenna from 1m to 4m and rotating the turn table from 0° to 360° to acquire the highest emissions from EUT.
3. And also, each emission was to be maximized by changing the polarization of receiving antenna both horizontal and vertical.
4. Repeat above procedures until all frequency measurements have been completed.
5. Radiated emission test frequency band from 9KHz to 25GHz.
6. The distance between test antenna and EUT as following table states:

Test Frequency range	Test Antenna Type	Test Distance
9KHz-30MHz	Active Loop Antenna	3
30MHz-1GHz	Ultra-Broadband Antenna	3
1GHz-18GHz	Double Ridged Horn Antenna	3
18GHz-25GHz	Horn Antenna	1

7. Setting test receiver/spectrum as following table states:

Test Frequency range	Test Receiver/Spectrum Setting	Detector
9KHz-150KHz	RBW=200Hz/VBW=3KHz, Sweep time=Auto	QP
150KHz-30MHz	RBW=9KHz/VBW=100KHz, Sweep time=Auto	QP
30MHz-1GHz	RBW=120KHz/VBW=1000KHz, Sweep time=Auto	QP
1GHz-40GHz	Peak Value: RBW=1MHz/VBW=3MHz, Sweep time=Auto Average Value: RBW=1MHz/VBW=10Hz, Sweep time=Auto	Peak

Field Strength Calculation

The field strength is calculated by adding the Antenna Factor and Cable Factor and subtracting the Amplifier Gain and Duty Cycle Correction Factor(if any) from the measured reading. The basic equation with a sample calculation is as follows:

FS = RA + AF + CL - AG

Where FS = Field Strength	CL = Cable Attenuation Factor (Cable Loss)
RA = Reading Amplitude	AG = Amplifier Gain
AF = Antenna Factor	

Transd=AF +CL-AG

RADIATION LIMIT

For intentional device, according to § 15.209(a), the general requirement of field strength of radiated emission from intentional radiators at a distance of 3 meters shall not exceed the following table. According to § 15.247(d), in any 100kHz bandwidth outside the frequency band in which the EUT is operating, the radio frequency power that is produced by the intentional radiator shall be at least 20dB below that in the 200kHz bandwidth within the band that contains the highest level of desired power.

The pre-test have done for the EUT in three axes and found the worst emission at position shown in test setup photos.

Frequency (MHz)	Distance (Meters)	Radiated (dBµV/m)	Radiated (µV/m)
0.009-0.49	3	20log(2400/F(KHz))+40log(300/3)	2400/F(KHz)
0.49-1.705	3	20log(24000/F(KHz))+ 40log(30/3)	24000/F(KHz)
1.705-30	3	20log(30)+ 40log(30/3)	30
30-88	3	40.0	100
88-216	3	43.5	150
216-960	3	46.0	200
Above 960	3	54.0	500

TEST RESULTS

Remark:

1. This test was performed with EUT in X, Y, Z position and the worse case was found when EUT in X position.
2. BLE 1Mbps and BLE 2Mbps were tested at Low, Middle, and High channel and recorded worst mode at BLE 1Mbps Middle channel below 1GHz. Above 1GHz, the worst mode at BLE 1Mbps was recorded.
3. Radiated emission test from 9 KHz to 10th harmonic of fundamental was verified, and no emission found except system noise floor in 9 KHz to 30MHz and not recorded in this report.

For 30MHz-1GHz

Horizontal

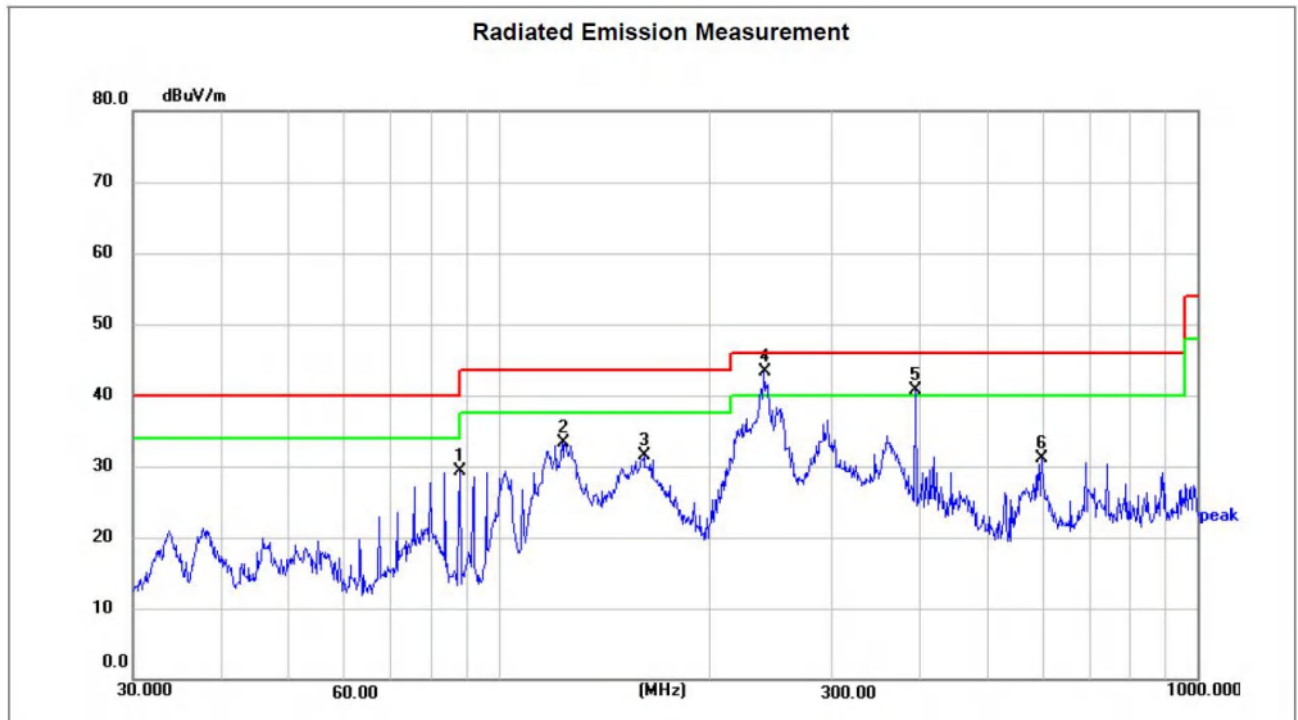

Site LAB
 Limit: FCC Part15 RE-Class B_30-1000MHz
 EUT:
 M/N:
 Mode:
 Note:

Polarization: **Horizontal**
 Power: AC120V/60Hz
 Distance: 3m

Temperature: 24.5(C)
 Humidity: 52 %

No.	Frequency (MHz)	Reading (dBuV)	Factor (dB/m)	Level (dBuV/m)	Limit (dBuV/m)	Margin (dB)	Detector	Height (cm)	Azimuth (deg.)	P/F	Remark
1	88.0329	50.31	-21.10	29.21	43.50	-14.29	peak	200	86	P	
2	123.2655	54.60	-21.23	33.37	43.50	-10.13	peak	200	186	P	
3	161.4742	53.18	-21.70	31.48	43.50	-12.02	peak	200	122	P	
4 *	239.9874	61.35	-18.41	42.94	46.00	-3.06	peak	100	193	P	
5 !	394.8545	56.26	-15.46	40.80	46.00	-5.20	peak	200	52	P	
6	599.3212	41.76	-10.71	31.05	46.00	-14.95	peak	200	8	P	

Note:1).Level (dBuV/m)= Reading (dBuV)+ Factor (dB/m)

2). Factor(dB/m)=Antenna Factor (dB/m) + Cable loss (dB) - Pre Amplifier gain (dB)

3). Margin(dB) = Level (dBuV/m) - Limit (dBuV/m)

Vertical

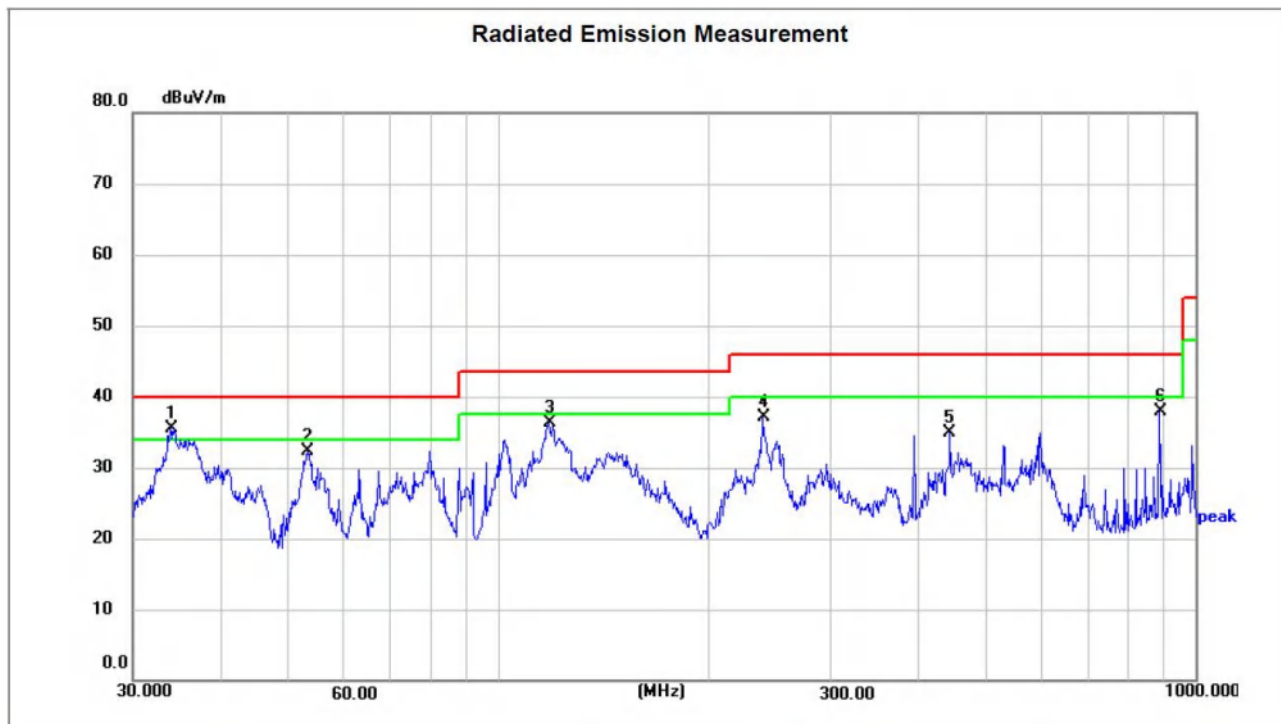

Site LAB Polarization: **Vertical** Temperature: 24.5(C)
 Limit: FCC Part15 RE-Class B_30-1000MHz Power: AC120V/60Hz Humidity: 52 %
 EUT: Distance: 3m
 M/N:
 Mode:
 Note:

No.	Frequency (MHz)	Reading (dBuV)	Factor (dB/m)	Level (dBuV/m)	Limit (dBuV/m)	Margin (dB)	Detector	Height (cm)	Azimuth (deg.)	P/F	Remark
1 *	33.9174	55.43	-19.92	35.51	40.00	-4.49	peak	100	127	P	
2	53.3179	50.24	-17.99	32.25	40.00	-7.75	peak	100	351	P	
3	118.1862	56.09	-19.79	36.30	43.50	-7.20	peak	100	100	P	
4	239.9874	55.45	-18.41	37.04	46.00	-8.96	peak	200	17	P	
5	444.8514	49.63	-14.71	34.92	46.00	-11.08	peak	200	8	P	
6	887.6098	45.46	-7.52	37.94	46.00	-8.06	peak	200	264	P	

- Note:1).Level (dBuV/m)= Reading (dBuV)+ Factor (dB/m)
 2). Factor(dB/m)=Antenna Factor (dB/m) + Cable loss (dB) - Pre Amplifier gain (dB)
 3). Margin(dB) = Level (dBuV/m) - Limit (dBuV/m)

For 1GHz to 25GHz

GFSK (above 1GHz)

Frequency(MHz):			2402		Polarity:		HORIZONTAL		
Frequency (MHz)	Emission Level (dBuV/m)		Limit (dBuV/m)	Margin (dB)	Raw Value (dBuV)	Antenna Factor (dB/m)	Cable Factor (dB)	Pre-amplifier (dB)	Correction Factor (dB/m)
4804.00	54.00	PK	74	20.00	75.16	28.42	5.14	54.72	-21.16
4804.00	43.15	AV	54	10.85	64.31	28.42	5.14	54.72	-21.16
7206.00	50.41	PK	74	23.59	64.83	34.15	6.46	55.03	-14.42
7206.00	38.33	AV	54	15.67	52.75	34.15	6.46	55.03	-14.42

Frequency(MHz):			2402		Polarity:		VERTICAL		
Frequency (MHz)	Emission Level (dBuV/m)		Limit (dBuV/m)	Margin (dB)	Raw Value (dBuV)	Antenna Factor (dB/m)	Cable Factor (dB)	Pre-amplifier (dB)	Correction Factor (dB/m)
4804.00	52.92	PK	74	21.08	74.08	28.42	5.14	54.72	-21.16
4804.00	44.32	AV	54	9.68	65.48	28.42	5.14	54.72	-21.16
7206.00	49.96	PK	74	24.04	64.38	34.15	6.46	55.03	-14.42
7206.00	39.29	AV	54	14.71	53.71	34.15	6.46	55.03	-14.42

Frequency(MHz):			2440		Polarity:		HORIZONTAL		
Frequency (MHz)	Emission Level (dBuV/m)		Limit (dBuV/m)	Margin (dB)	Raw Value (dBuV)	Antenna Factor (dB/m)	Cable Factor (dB)	Pre-amplifier (dB)	Correction Factor (dB/m)
4880.00	53.60	PK	74	20.40	73.91	28.73	5.32	54.36	-20.31
4880.00	44.55	AV	54	9.45	64.86	28.73	5.32	54.36	-20.31
7320.00	50.60	PK	74	23.40	64.26	34.38	6.81	54.85	-13.66
7320.00	38.86	AV	54	15.14	52.52	34.38	6.81	54.85	-13.66

Frequency(MHz):			2440		Polarity:		VERTICAL		
Frequency (MHz)	Emission Level (dBuV/m)		Limit (dBuV/m)	Margin (dB)	Raw Value (dBuV)	Antenna Factor (dB/m)	Cable Factor (dB)	Pre-amplifier (dB)	Correction Factor (dB/m)
4880.00	53.68	PK	74	20.32	73.99	28.73	5.32	54.36	-20.31
4880.00	42.45	AV	54	11.55	62.76	28.73	5.32	54.36	-20.31
7320.00	50.16	PK	74	23.84	63.82	34.38	6.81	54.85	-13.66
7320.00	39.08	AV	54	14.92	52.74	34.38	6.81	54.85	-13.66

Frequency(MHz):			2480		Polarity:		HORIZONTAL		
Frequency (MHz)	Emission Level (dBuV/m)		Limit (dBuV/m)	Margin (dB)	Raw Value (dBuV)	Antenna Factor (dB/m)	Cable Factor (dB)	Pre-amplifier (dB)	Correction Factor (dB/m)
4960.00	55.34	PK	74	18.66	74.87	29.52	5.63	54.68	-19.53
4960.00	43.81	AV	54	10.19	63.34	29.52	5.63	54.68	-19.53
7440.00	52.12	PK	74	21.88	65.32	34.49	7.23	54.92	-13.2
7440.00	40.43	PK	54	13.57	53.63	34.49	7.23	54.92	-13.2

Frequency(MHz):			2480		Polarity:		VERTICAL		
Frequency (MHz)	Emission Level (dBuV/m)		Limit (dBuV/m)	Margin (dB)	Raw Value (dBuV)	Antenna Factor (dB/m)	Cable Factor (dB)	Pre-amplifier (dB)	Correction Factor (dB/m)
4960.00	53.86	PK	74	20.14	73.39	29.52	5.63	54.68	-19.53
4960.00	45.05	AV	54	8.95	64.58	29.52	5.63	54.68	-19.53
7440.00	52.02	PK	74	21.98	65.22	34.49	7.23	54.92	-13.2
7440.00	40.71	PK	54	13.29	53.91	34.49	7.23	54.92	-13.2

REMARKS:

1. Emission level (dBuV/m) =Raw Value (dBuV)+Correction Factor (dB/m)

2. Correction Factor (dB/m) = Antenna Factor (dB/m)+Cable Factor (dB)- Pre-amplifier
3. Margin value = Limit value- Emission level.
4. -- Mean the PK detector measured value is below average limit.
5. The other emission levels were very low against the limit.

Results of Band Edges Test (Radiated)

GFSK

Frequency(MHz):			2402		Polarity:		HORIZONTAL		
Frequency (MHz)	Emission Level (dBuV/m)		Limit (dBuV/m)	Margin (dB)	Raw Value (dBuV)	Antenna Factor (dB/m)	Cable Factor (dB)	Pre-amplifier (dB)	Correction Factor (dB/m)
2390.00	56.40	PK	74	17.60	81.12	25.72	4.32	54.76	-24.72
2390.00	41.04	AV	54	12.96	65.76	25.72	4.32	54.76	-24.72
Frequency(MHz):			2402		Polarity:		VERTICAL		
Frequency (MHz)	Emission Level (dBuV/m)		Limit (dBuV/m)	Margin (dB)	Raw Value (dBuV)	Antenna Factor (dB/m)	Cable Factor (dB)	Pre-amplifier (dB)	Correction Factor (dB/m)
2390.00	57.64	PK	74	16.36	82.36	25.72	4.32	54.76	-24.72
2390.00	41.02	AV	54	12.98	65.74	25.72	4.32	54.76	-24.72
Frequency(MHz):			2480		Polarity:		HORIZONTAL		
Frequency (MHz)	Emission Level (dBuV/m)		Limit (dBuV/m)	Margin (dB)	Raw Value (dBuV)	Antenna Factor (dB/m)	Cable Factor (dB)	Pre-amplifier (dB)	Correction Factor (dB/m)
2483.50	57.00	PK	74	17.00	81.57	25.78	4.48	54.83	-24.57
2483.50	40.66	AV	54	13.34	65.23	25.78	4.48	54.83	-24.57
Frequency(MHz):			2480		Polarity:		VERTICAL		
Frequency (MHz)	Emission Level (dBuV/m)		Limit (dBuV/m)	Margin (dB)	Raw Value (dBuV)	Antenna Factor (dB/m)	Cable Factor (dB)	Pre-amplifier (dB)	Correction Factor (dB/m)
2483.50	56.67	PK	74	17.33	81.24	25.78	4.48	54.83	-24.57
2483.50	40.96	AV	54	13.04	65.53	25.78	4.48	54.83	-24.57

REMARKS:

1. Emission level (dBuV/m) =Raw Value (dBuV)+Correction Factor (dB/m)
2. Correction Factor (dB/m) = Antenna Factor (dB/m)+Cable Factor (dB)- Pre-amplifier
3. Margin value = Limit value- Emission level.
4. -- Mean the PK detector measured value is below average limit.
5. The other emission levels were very low against the limit.

4.3 Maximum Peak Output Power

Limit

The Maximum Peak Output Power Measurement is 30dBm.

Test Procedure

Remove the antenna from the EUT and then connect a low loss RF cable from the antenna port to the power sensor.

Test Configuration

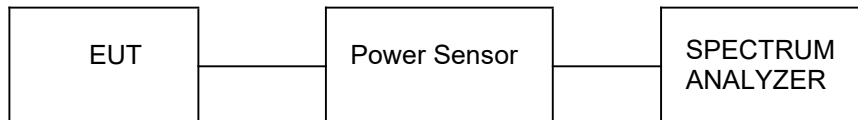

Test Results

Type	Channel	Output power (dBm)	Limit (dBm)	Result
GFSK 1Mbps	00	3.46	30.00	Pass
	19	3.17		
	39	3.68		
GFSK 2Mbps	00	3.52		
	19	3.75		
	39	3.61		

Note: 1.The test results including the cable lose.

4.4 Power Spectral Density

Limit

The resulting peak PSD level shall not be greater than 8 dBm/3KHz.

Test Procedure

1. Use this procedure when the maximum peak conducted output power in the fundamental emission is used to demonstrate compliance.
2. Set the RBW \geq 3 kHz.
3. Set the VBW \geq 3 \times RBW.
4. Set the span to 1.5 times the DTS channel bandwidth.
5. Detector = peak.
6. Sweep time = auto couple.
7. Trace mode = max hold.
8. Allow trace to fully stabilize.
9. Use the peak marker function to determine the maximum power level.
10. If measured value exceeds limit, reduce RBW (no less than 3 kHz) and repeat.
11. The resulting peak PSD level shall not be greater than 8 dBm/3KHz.

Test Configuration



Test Results

Type	Channel	Power Spectral Density (dBm/3KHz)	Limit (dBm/3KHz)	Result
GFSK 1Mbps	00	-17.73	8.00	Pass
	19	-15.98		
	39	-17.43		
GFSK 2Mbps	00	-20.23		
	19	-18.48		
	39	-19.88		

Test plot as follows:

BLE GFSK 1Mbps

BLE GFSK 2Mbps

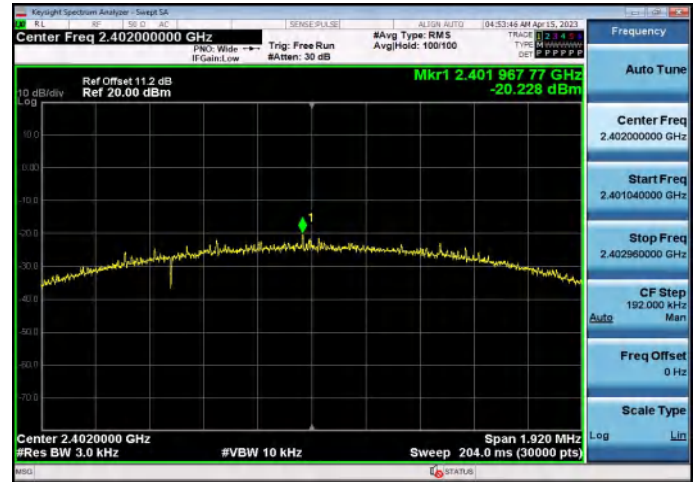
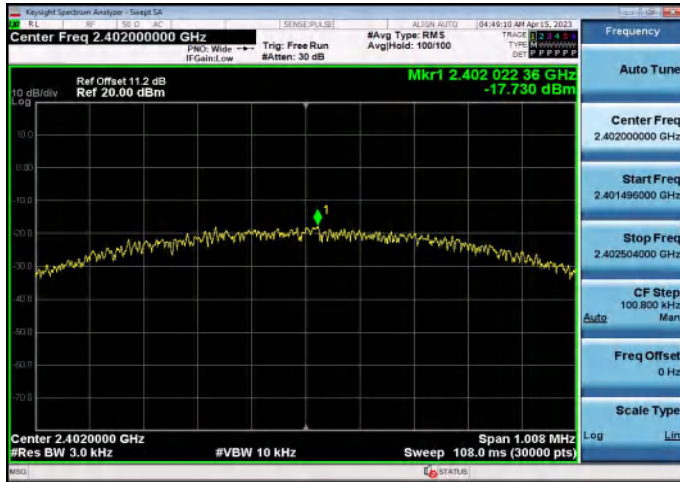

CH00

CH00

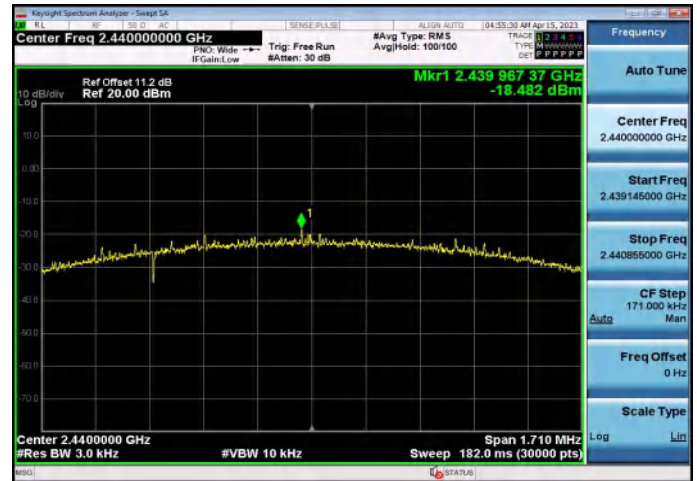
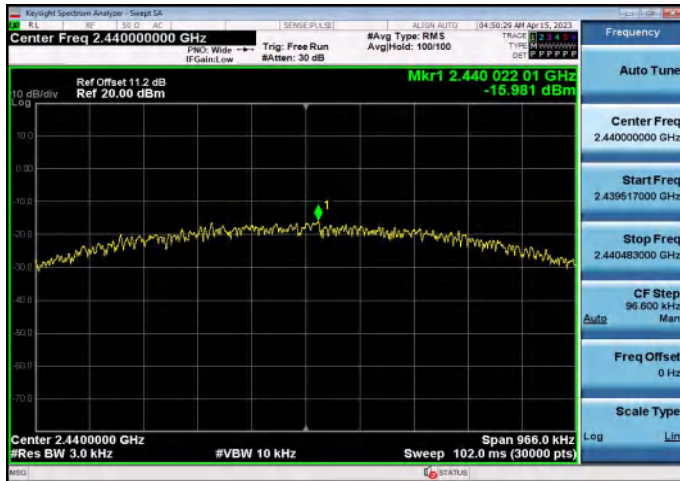

CH19

CH19



CH39

CH39

4.5 6dB Bandwidth

Limit

For digital modulation systems, the minimum 6 dB bandwidth shall be at least 500 kHz

Test Procedure

The transmitter output was connected to the spectrum analyzer through an attenuator. The bandwidth of the fundamental frequency was measured by spectrum analyzer with 100 KHz RBW and 300 KHz VBW. The 6dB bandwidth is defined as the total spectrum the power of which is higher than peak power minus 6dB.

Test Configuration



Test Results

Type	Channel	6dB Bandwidth (MHz)	Limit (KHz)	Result
GFSK 1Mbps	00	0.6668	≥500	Pass
	19	0.7331		
	39	0.6933		
GFSK 2Mbps	00	1.147		
	19	1.137		
	39	1.165		

Test plot as follows:

BLE GFSK 1Mbps

BLE GFSK 2Mbps

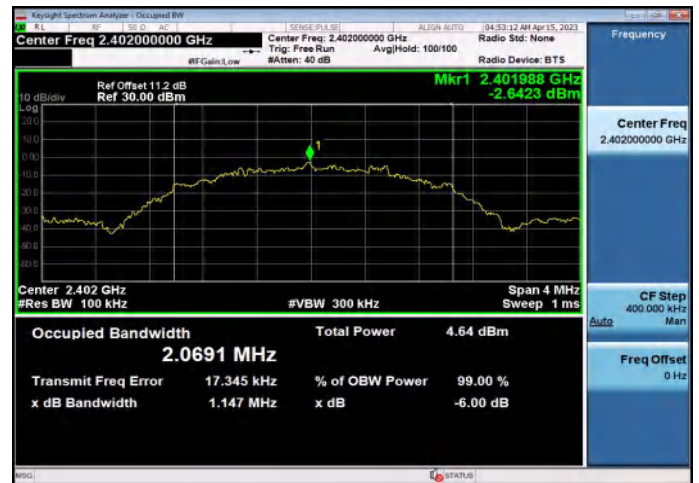

CH00

CH00

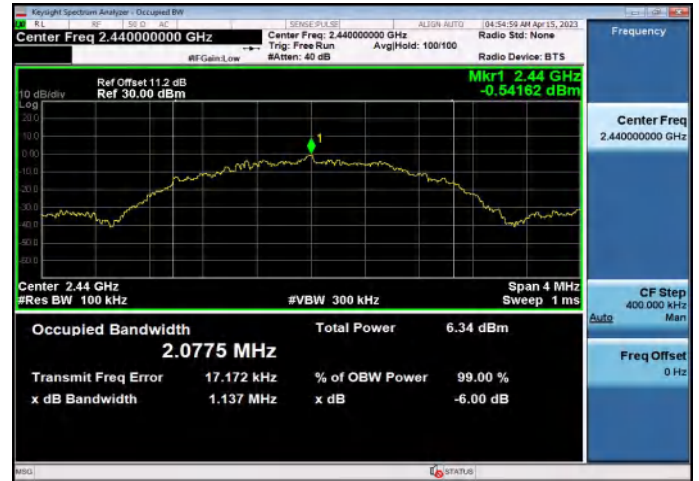
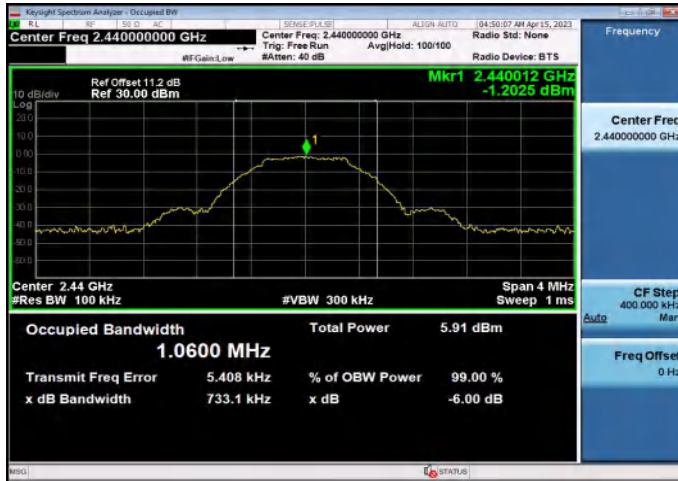

CH19

CH19

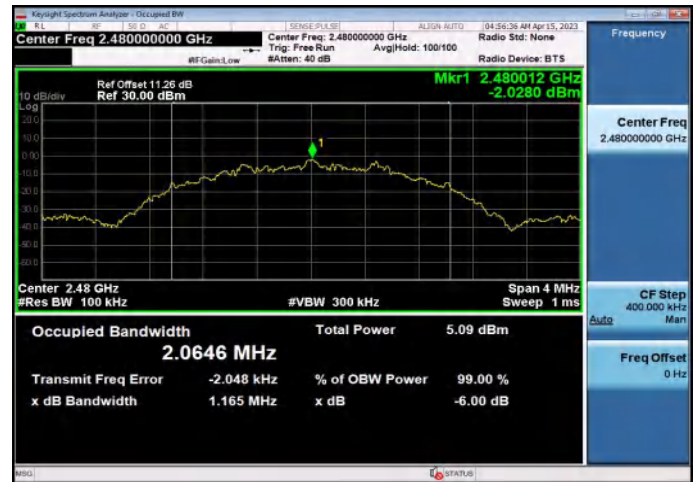
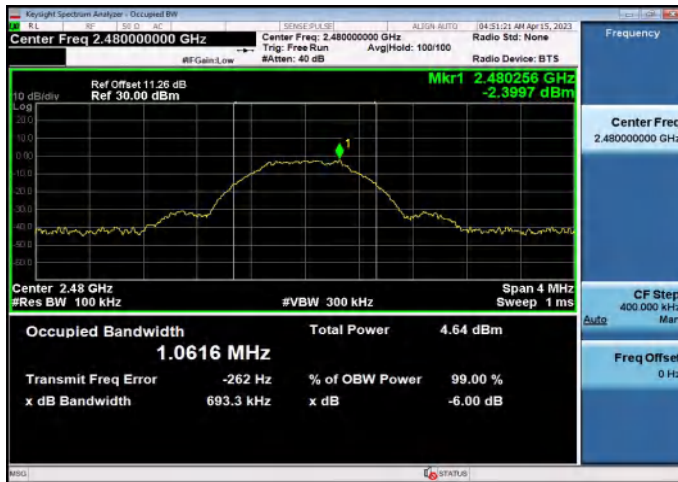

CH39

CH39

4.6 Out-of-band Emissions

Limit

In any 100 kHz bandwidth outside the frequency band in which the spread spectrum or digitally modulated intentional radiator is operating, the radio frequency power that is produced by the intentional radiator shall be at least 20 dB below that in the 100 kHz bandwidth within the band that contains the highest level of the desired power, based on either an RF conducted or a radiated measurement, provided the transmitter demonstrates compliance with the peak conducted power limits. If the transmitter complies with the conducted power limits based on the use of RMS averaging over a time interval, as permitted under paragraph (b)(3) of this section, the attenuation required under this paragraph shall be 30 dB instead of 20 dB. Attenuation below the general limits specified in §15.209(a) is not required.

Test Procedure

Connect the transmitter output to spectrum analyzer using a low loss RF cable, and set the spectrum analyzer to RBW=100 kHz, VBW= 300 kHz, peak detector, and max hold. Measurements utilizing these settings are made of the in-band reference level, bandedge and out-of-band emissions.

Test Configuration



Test Results

Remark: The measurement frequency range is from 30MHz to the 10th harmonic of the fundamental frequency. The lowest, middle and highest channels are tested to verify the spurious emissions and bandedge measurement data.

Test plot as follows:

GFSK 1Mbps (CH00)



GFSK 1Mbps (CH19)



reference

reference

30MHz-1G

30MHz-1G

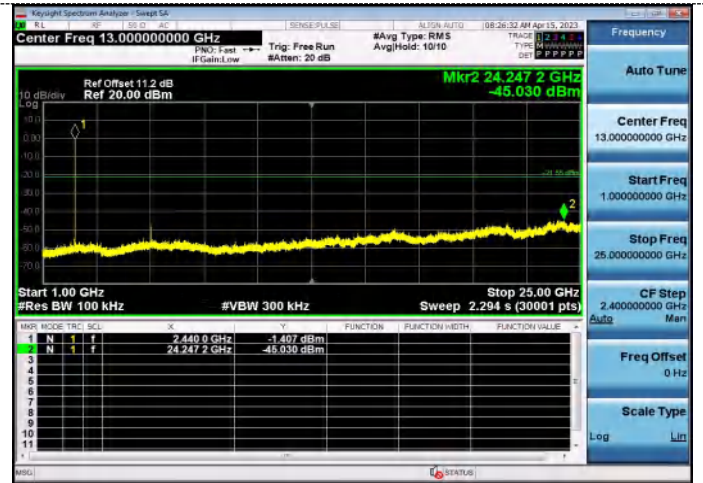
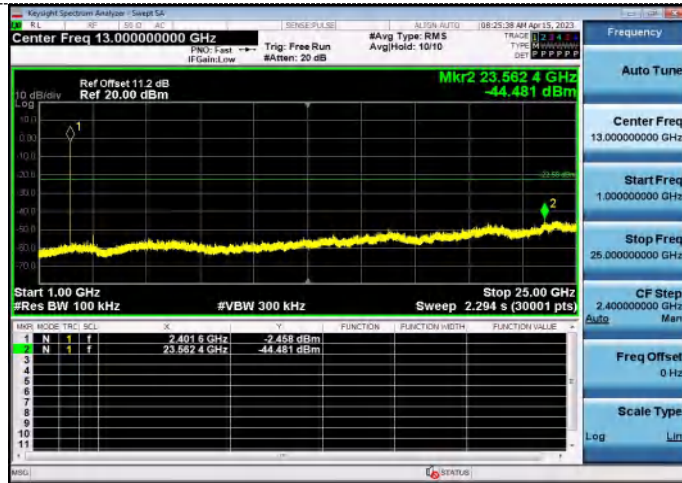

1G-25G

1G-25G

GFSK 1Mbps (CH39)



GFSK 2Mbps (CH00)

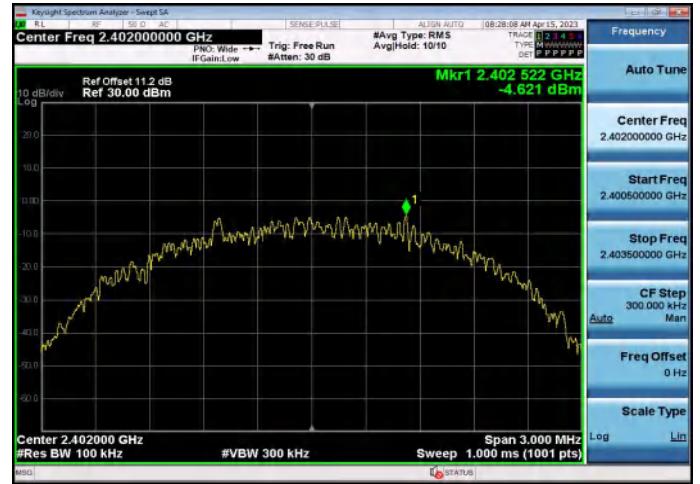

reference

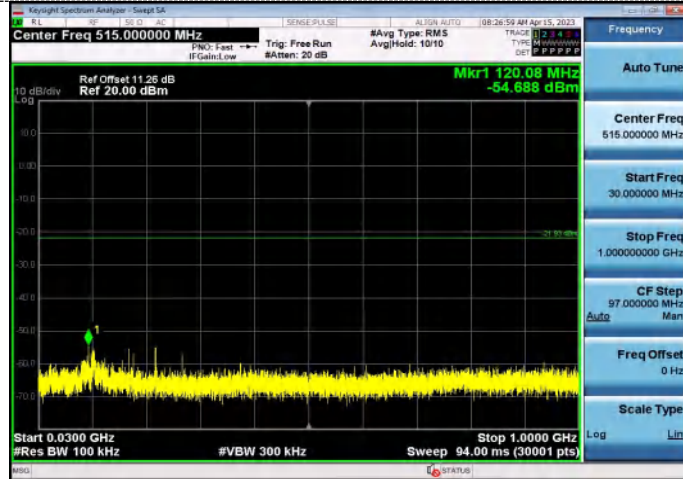

reference

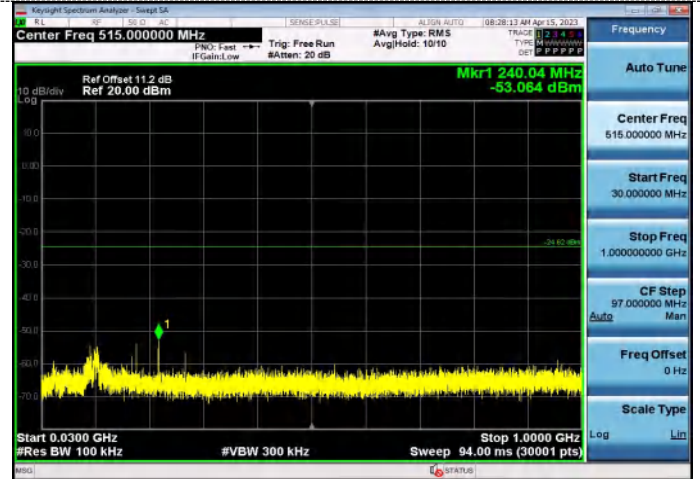

30MHz-1G

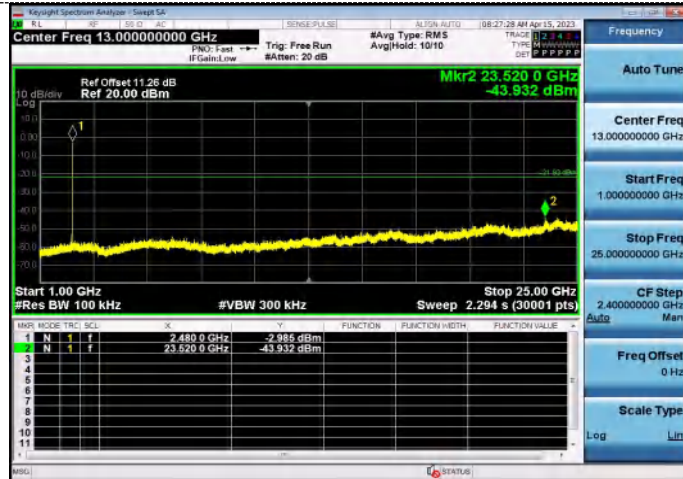

30MHz-1G

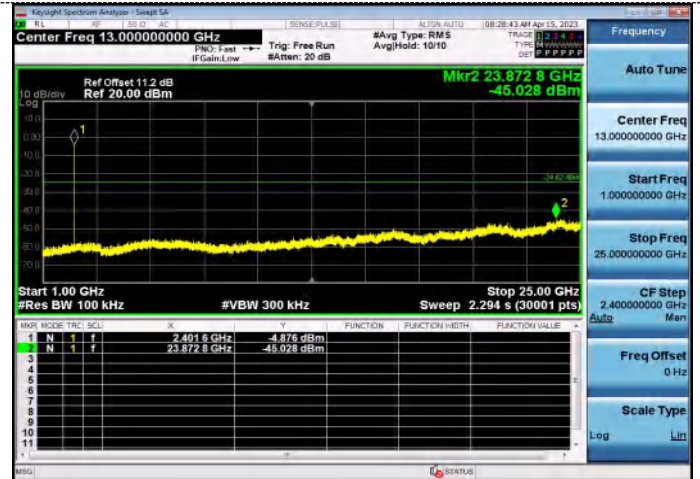

1G-25G

1G-25G

GFSK 2Mbps (CH19)



GFSK 2Mbps (CH39)



reference

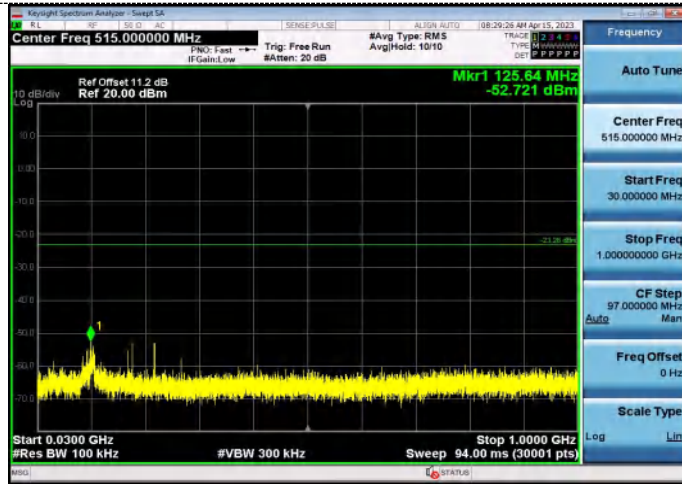

reference

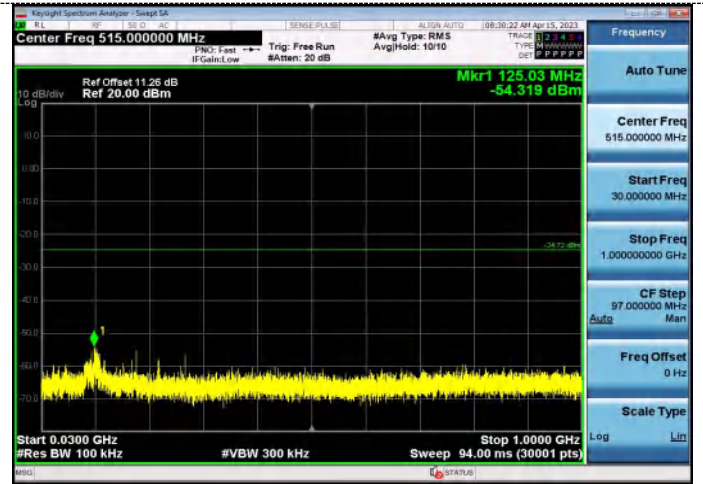

30MHz-1G

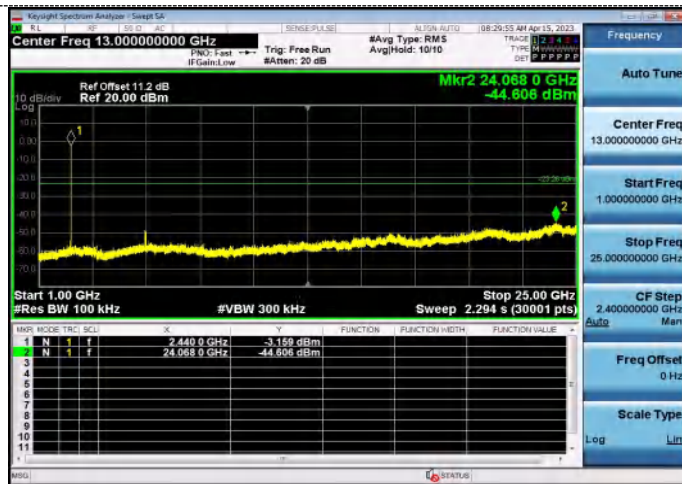

30MHz-1G

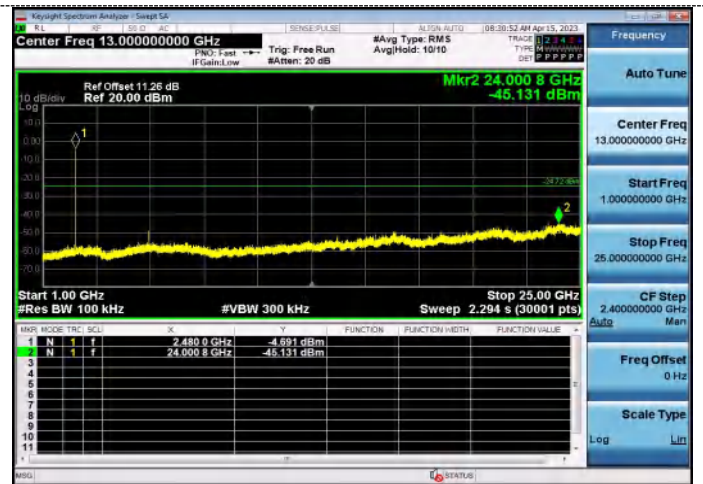

1G-25G

1G-25G

Band-edge Measurements for RF Conducted Emissions:

BLE GFSK 1Mbps

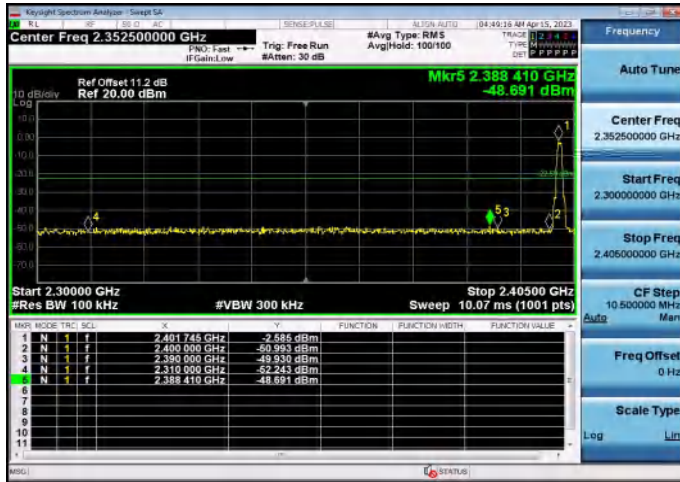

Left bandedge

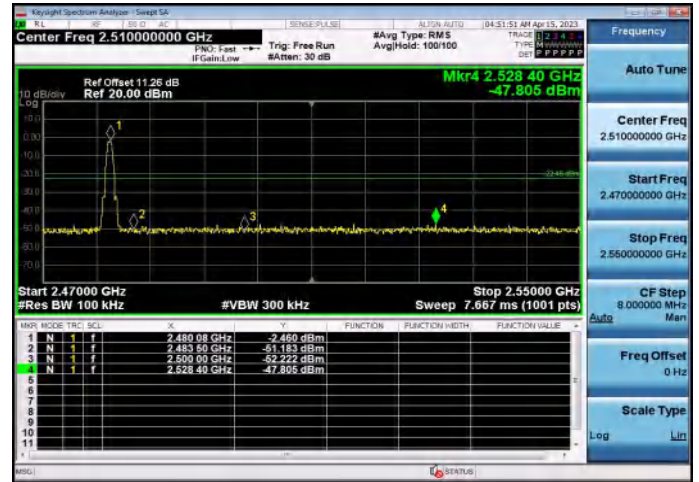

Right bandedge

BLE GFSK 2Mbps

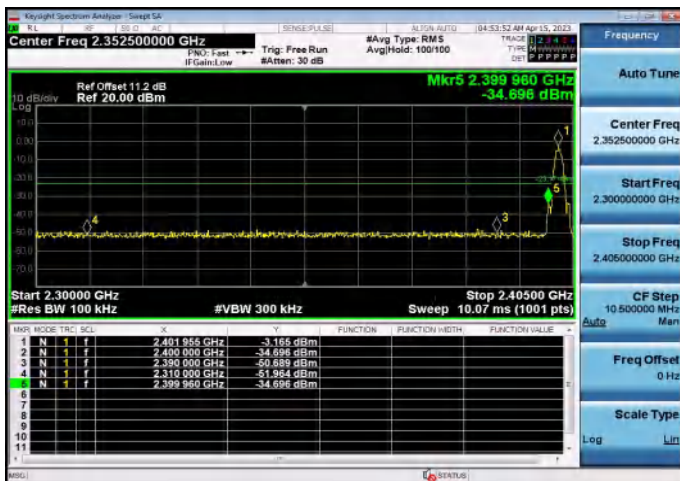

Left bandedge

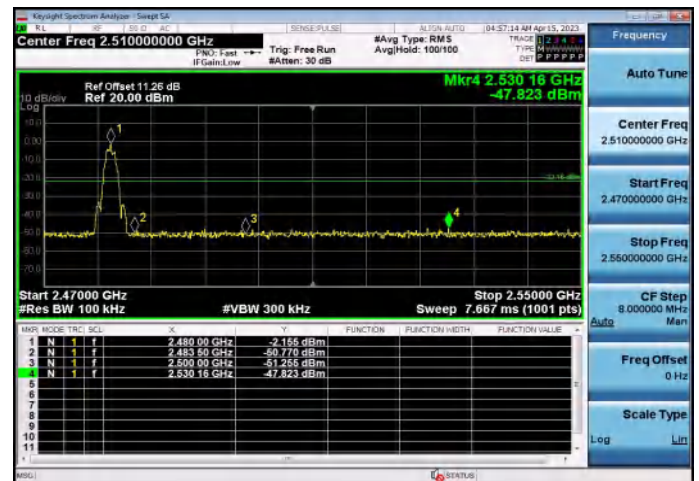

Right bandedge

4.7 Antenna Requirement

Standard Applicable

For intentional device, according to FCC 47 CFR Section 15.203:

An intentional radiator shall be designed to ensure that no antenna other than that furnished by the responsible party shall be used with the device. The use of a permanently attached antenna or of an antenna that uses a unique coupling to the intentional radiator, the manufacturer may design the unit so that a broken antenna can be replaced by the user, but the use of a standard antenna jack or electrical connector is prohibited.

FCC CFR Title 47 Part 15 Subpart C Section 15.247(c) (1) (I):

(i) Systems operating in the 2400-2483.5 MHz band that is used exclusively for fixed. Point-to-point operations may employ transmitting antennas with directional gain greater than 6dBi provided the maximum conducted output power of the intentional radiator is reduced by 1 dB for every 3 dB that the directional gain of the antenna exceeds 6dBi.

Antenna Connected Construction

The maximum gain of antenna was 2.79 dBi.

Remark: The antenna gain is provided by the customer, if the data provided by the customer is not accurate, Shenzhen GUOREN Certification Technology Service Co., Ltd. does not assume any responsibility.

5 Test Setup Photos of the EUT

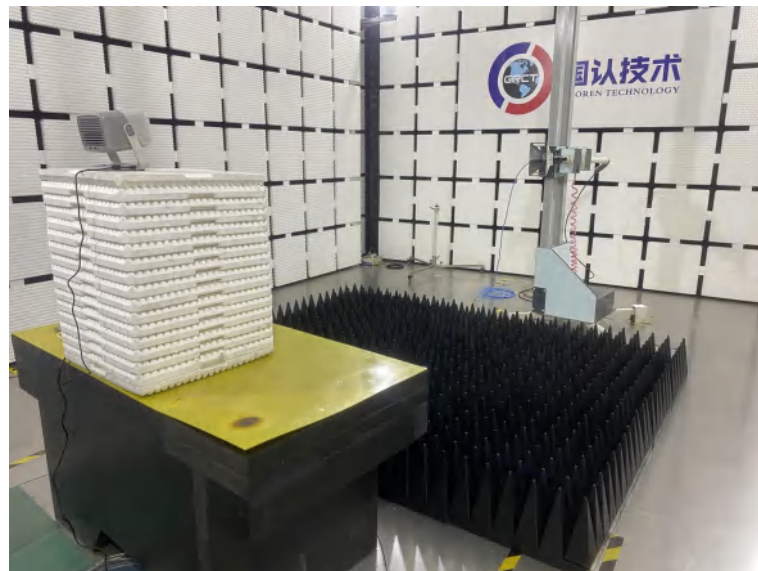
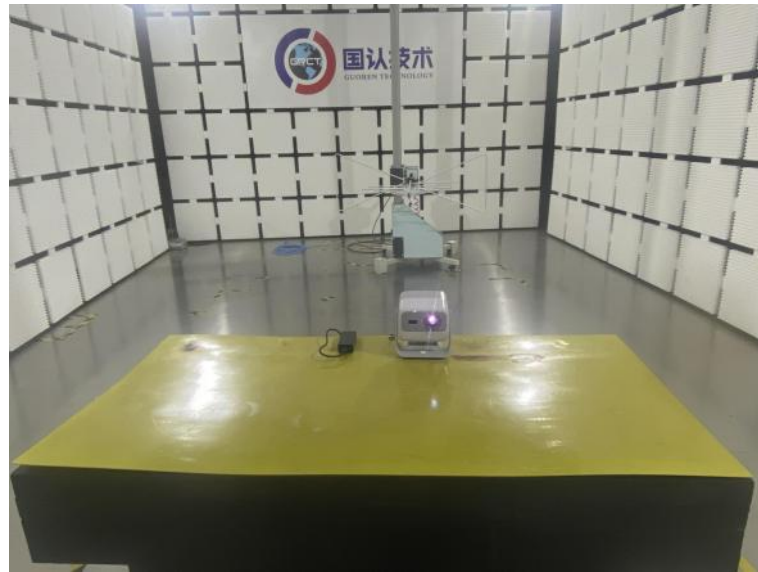

6 Photos of the EUT

Reference to the test report No. GRCTR230302023-01.

***** End of Report *****