

---

# INTERTEK TESTING SERVICES

---

## Equipment Photographs

(Internal)

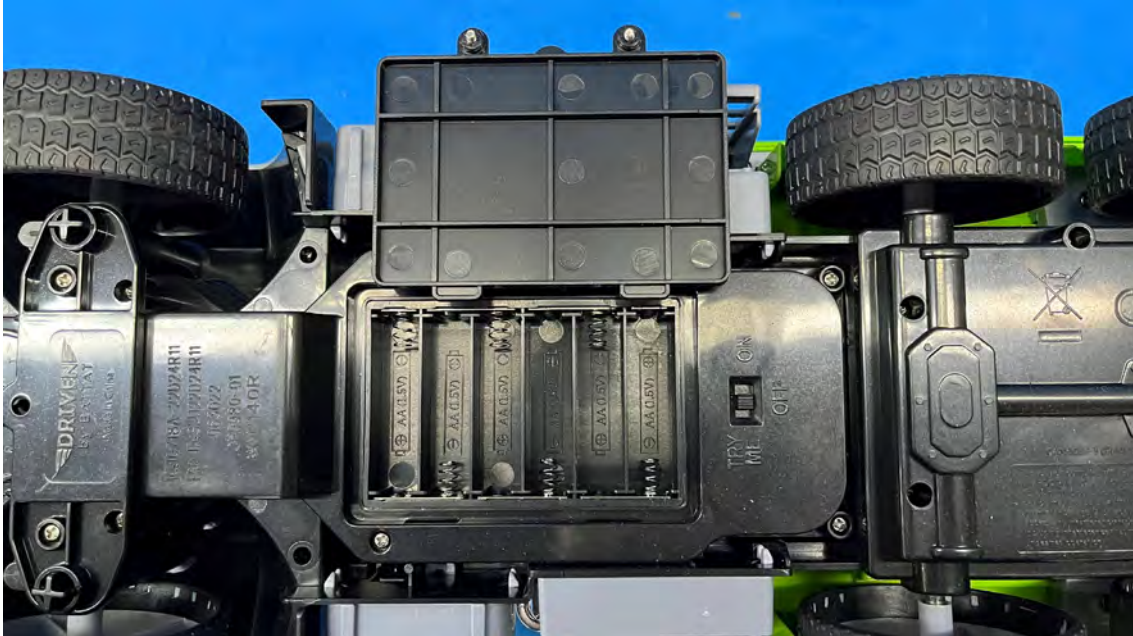

---

FCC ID: SLU22D24R16  
IC: 10718A-22D24R16

---

# INTERTEK TESTING SERVICES

---

## Equipment Photographs

(Internal)

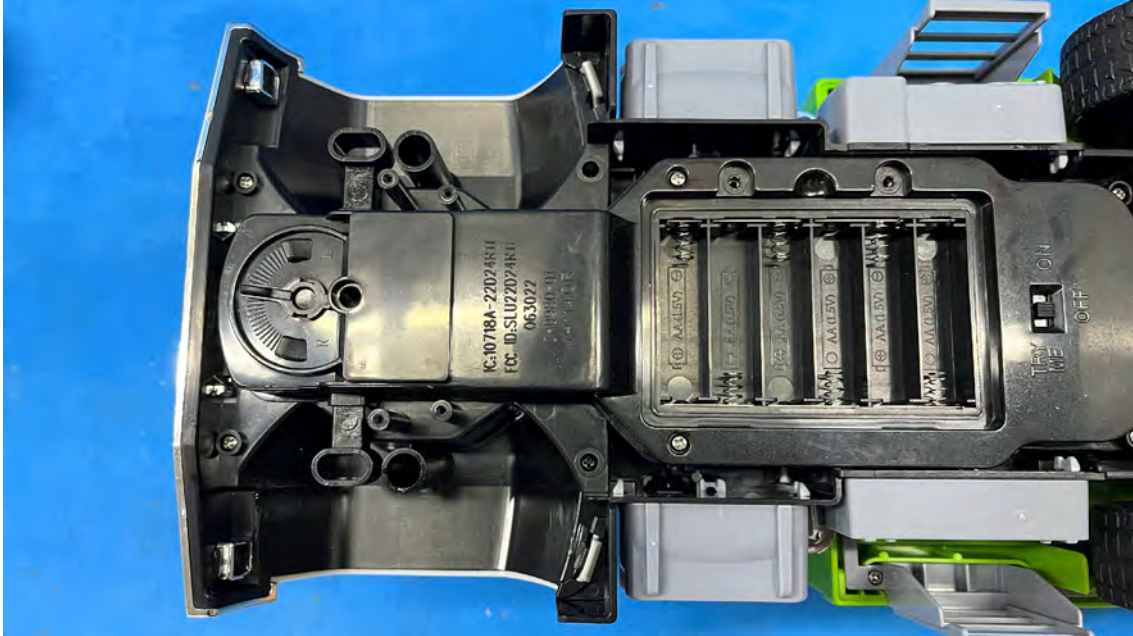

---

FCC ID: SLU22D24R16  
IC: 10718A-22D24R16

---

# INTERTEK TESTING SERVICES

---

## Equipment Photographs

(Internal)



---

# INTERTEK TESTING SERVICES

---

## Equipment Photographs

(Internal)



---

# INTERTEK TESTING SERVICES

---

## Equipment Photographs

(Internal)



---

# INTERTEK TESTING SERVICES

---

## Equipment Photographs

(Internal)



---

# INTERTEK TESTING SERVICES

---

## Equipment Photographs

(Internal)

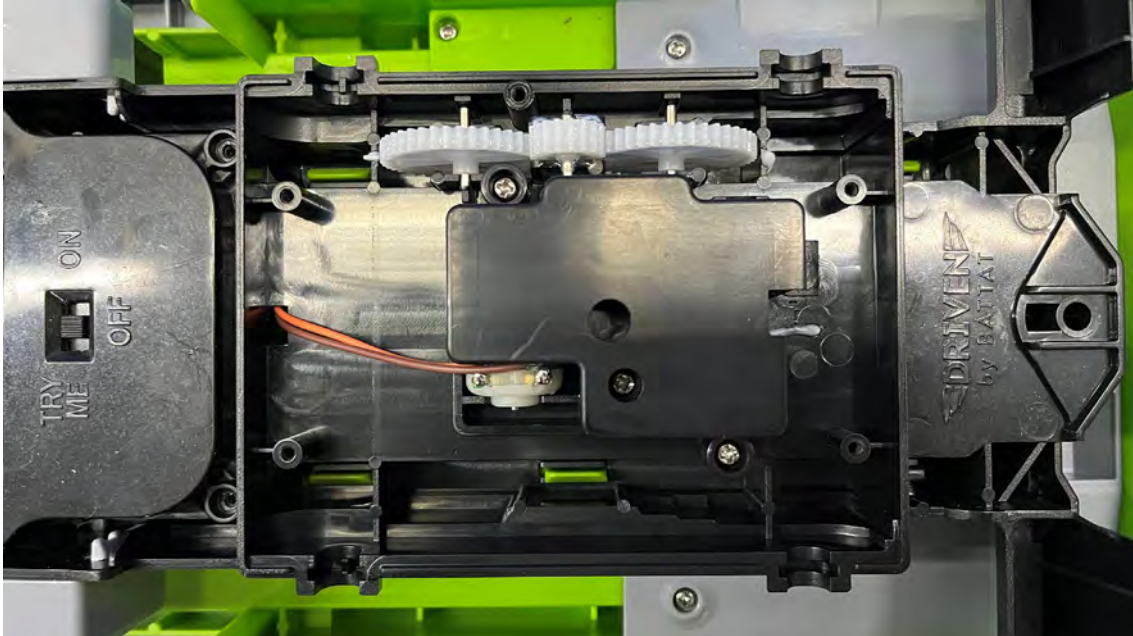

---

FCC ID: SLU22D24R16  
IC: 10718A-22D24R16

---

# INTERTEK TESTING SERVICES

---

## Equipment Photographs

(Internal)

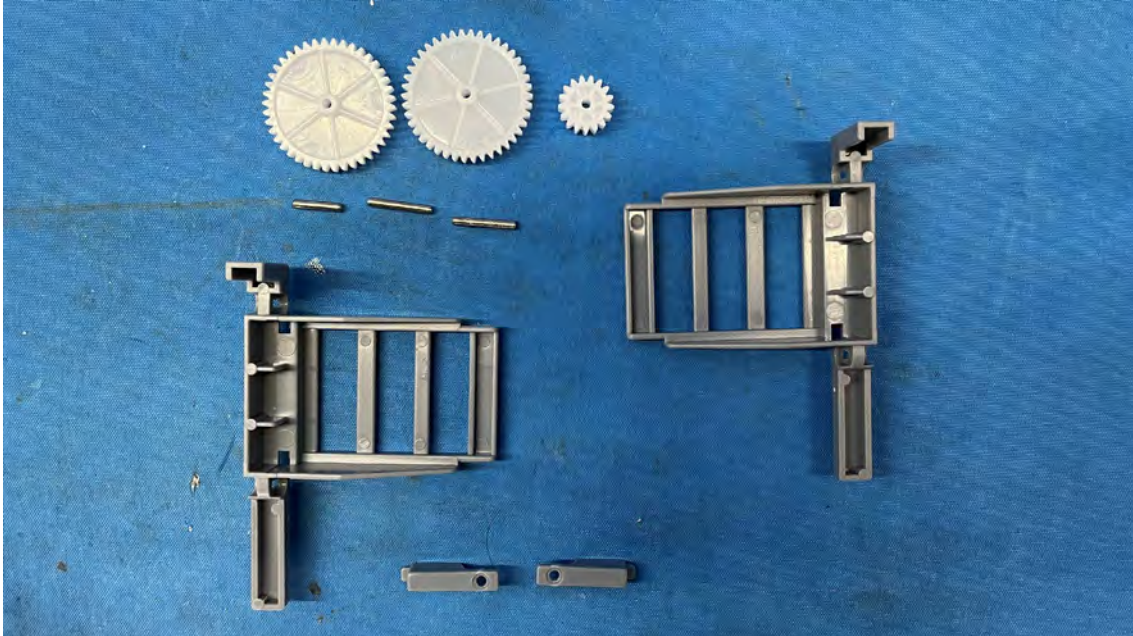



---

# INTERTEK TESTING SERVICES

---

## Equipment Photographs

(Internal)

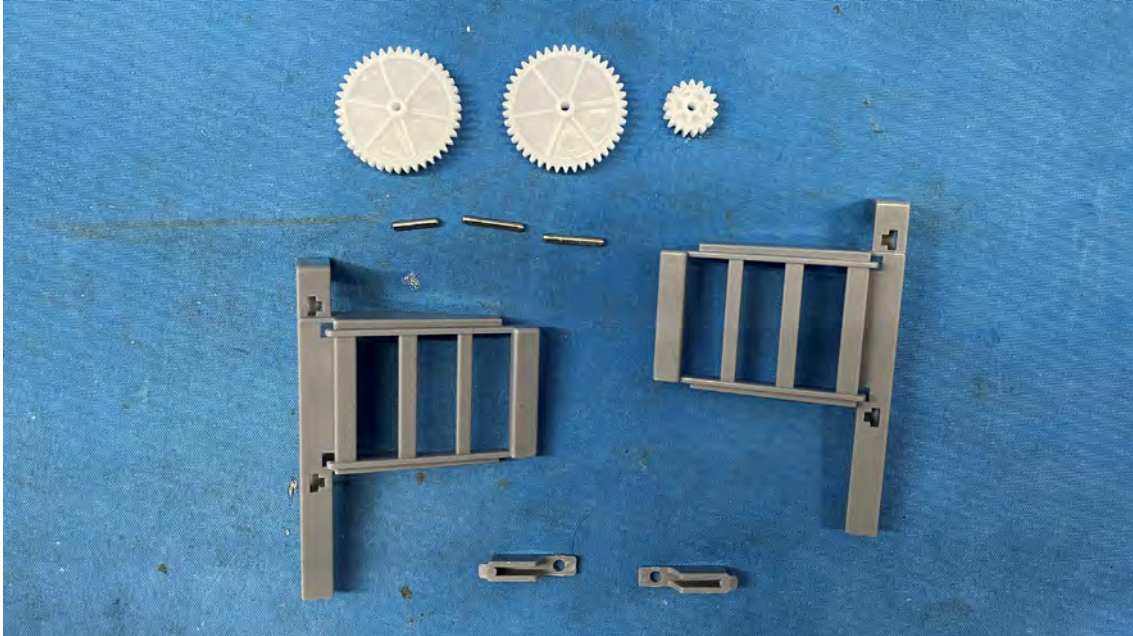

---

## INTERTEK TESTING SERVICES

---

### Equipment Photographs

(Internal)



---

FCC ID: SLU22D24R16  
IC: 10718A-22D24R16

---

# INTERTEK TESTING SERVICES

---

## Equipment Photographs

(Internal)

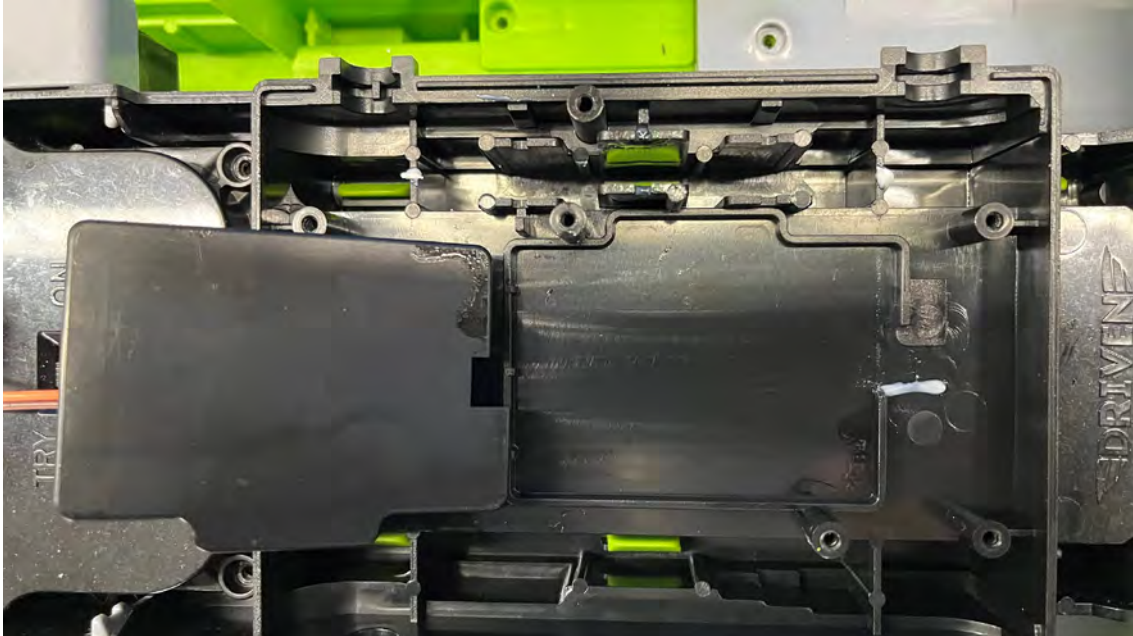

---

FCC ID: SLU22D24R16  
IC: 10718A-22D24R16

---

## INTERTEK TESTING SERVICES

---

### Equipment Photographs

(Internal)

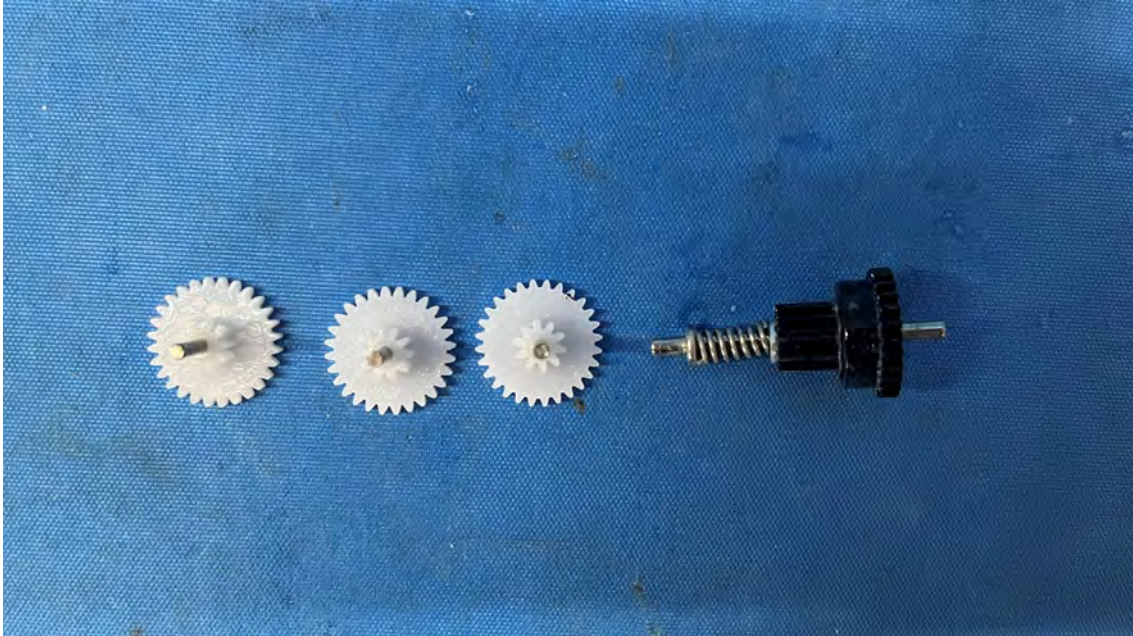

---

# INTERTEK TESTING SERVICES

---

## Equipment Photographs

(Internal)

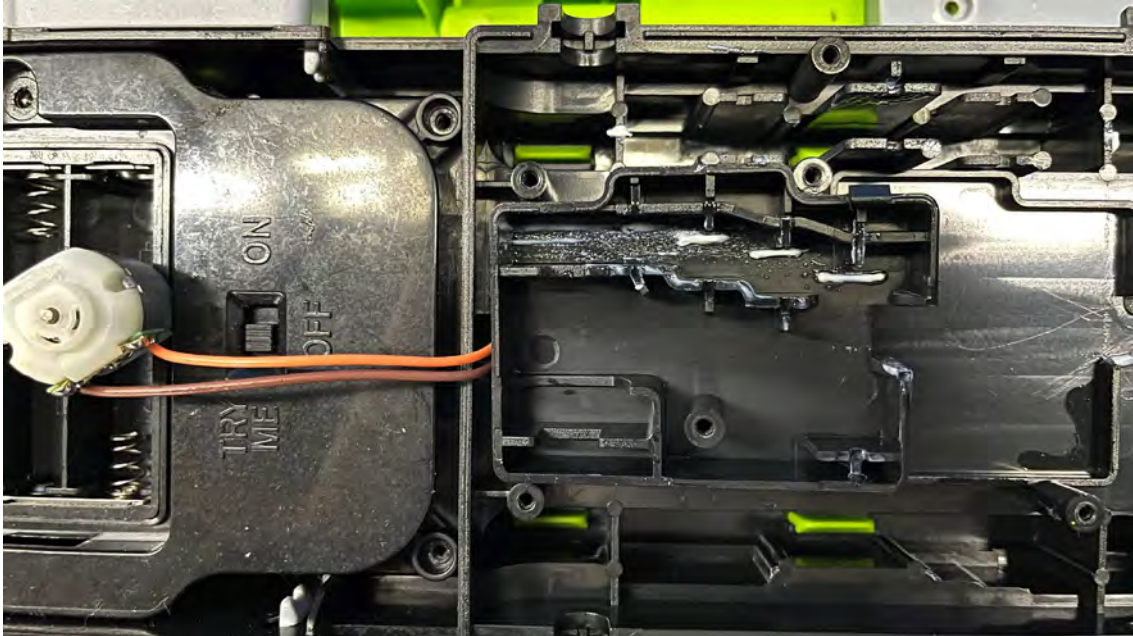

---

## INTERTEK TESTING SERVICES

---

### Equipment Photographs

(Internal)



---

## INTERTEK TESTING SERVICES

---

### Equipment Photographs

(Internal)



---

# INTERTEK TESTING SERVICES

---

## Equipment Photographs

(Internal)

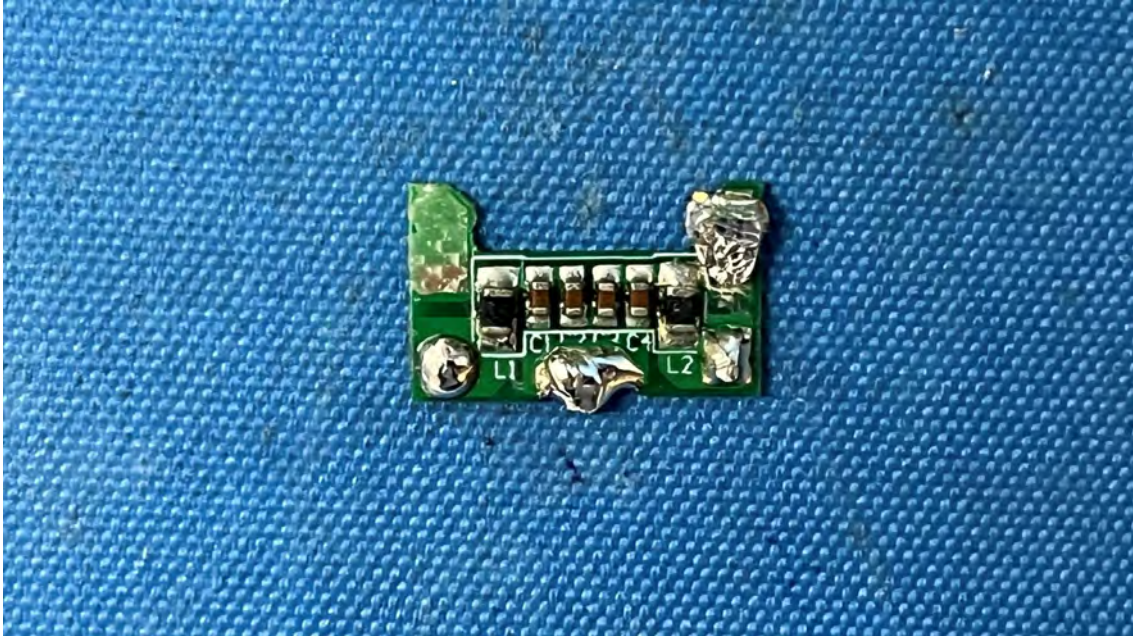



---

# INTERTEK TESTING SERVICES

---

## Equipment Photographs

(Internal)

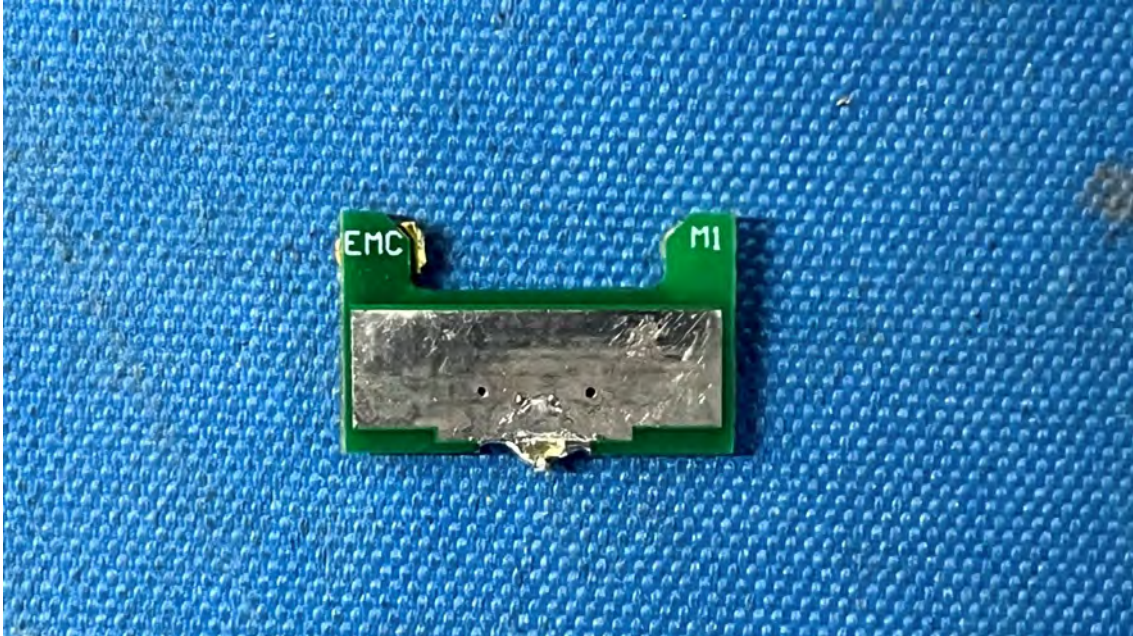

---

## INTERTEK TESTING SERVICES

---

### Equipment Photographs

(Internal)



---

# INTERTEK TESTING SERVICES

---

## Equipment Photographs

(Internal)

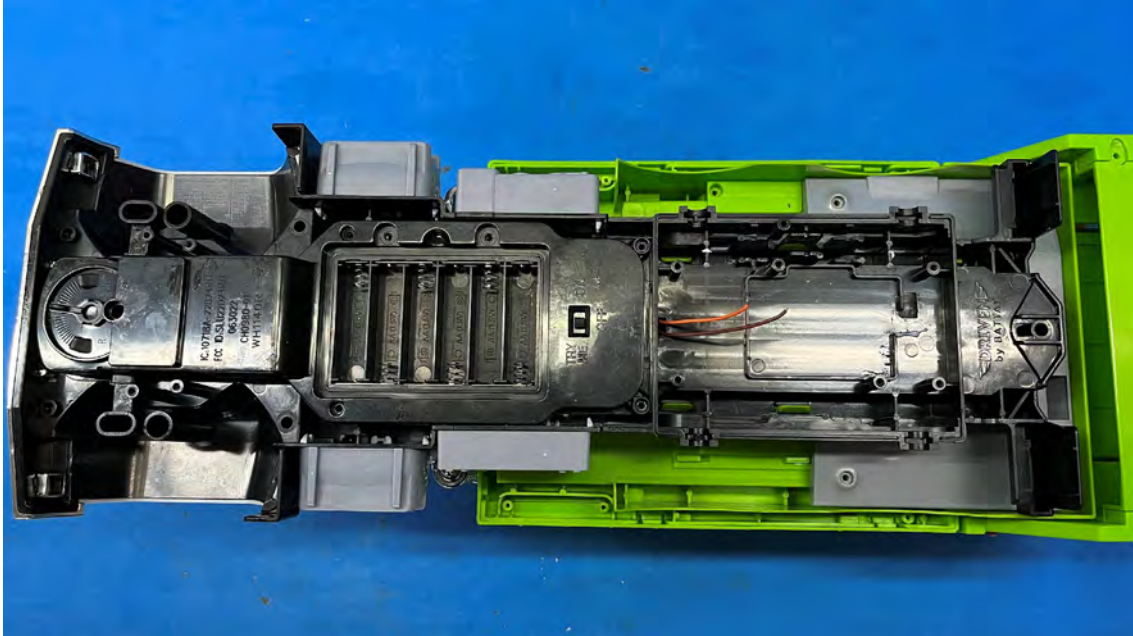

---

FCC ID: SLU22D24R16  
IC: 10718A-22D24R16

---

# INTERTEK TESTING SERVICES

---

## Equipment Photographs

(Internal)



---

# INTERTEK TESTING SERVICES

---

## Equipment Photographs

(Internal)



---

# INTERTEK TESTING SERVICES

---

## Equipment Photographs

(Internal)



---

# INTERTEK TESTING SERVICES

---

## Equipment Photographs

(Internal)

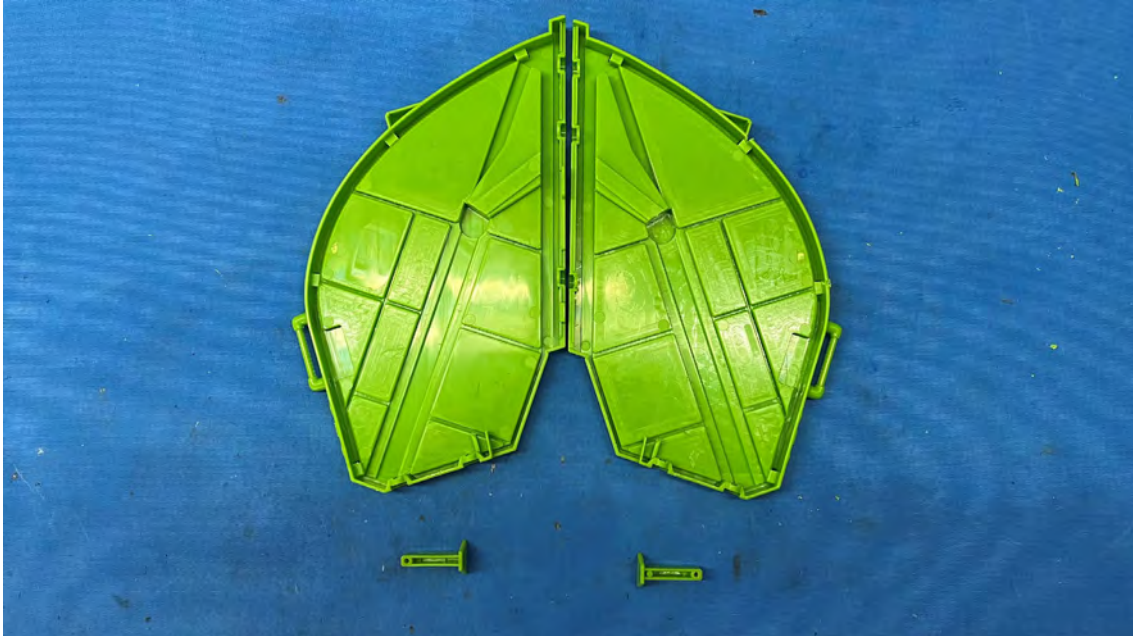

---

## INTERTEK TESTING SERVICES

---

### Equipment Photographs

(Internal)





---

## INTERTEK TESTING SERVICES

---

### Equipment Photographs

(Internal)



---

# INTERTEK TESTING SERVICES

---

## Equipment Photographs

(Internal)

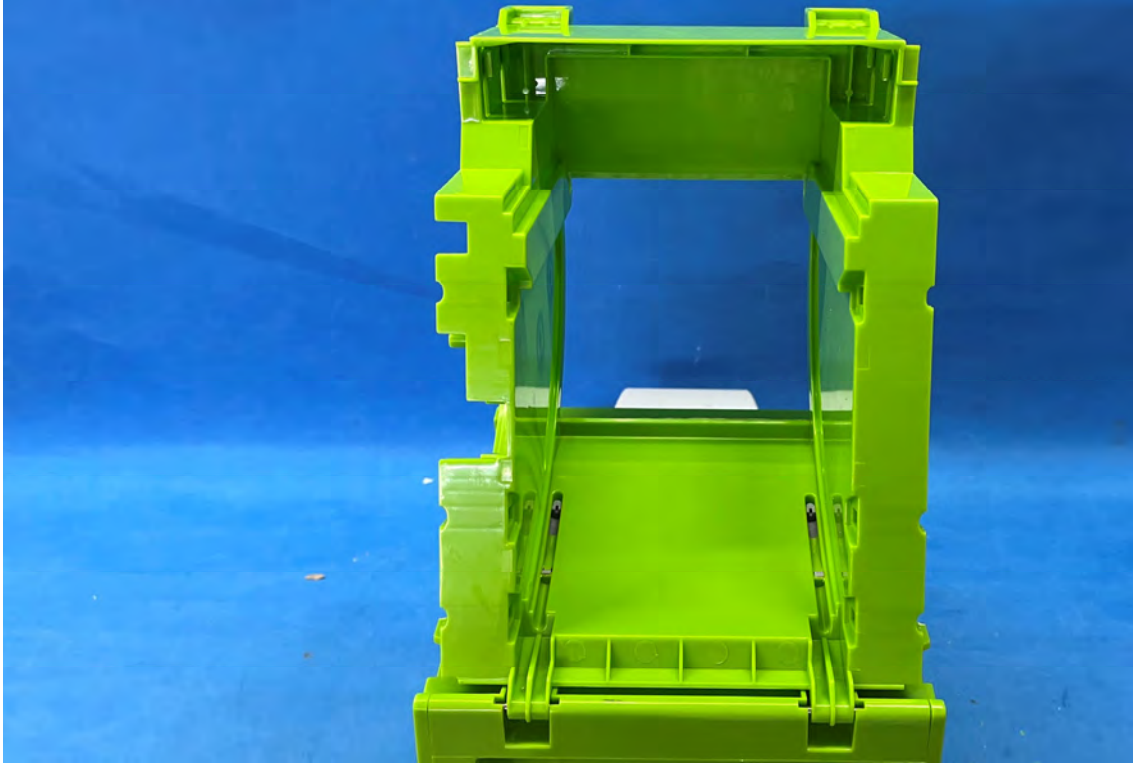

---

# INTERTEK TESTING SERVICES

---

## Equipment Photographs

(Internal)



---

# INTERTEK TESTING SERVICES

---

## Equipment Photographs

(Internal)



---

# INTERTEK TESTING SERVICES

---

## Equipment Photographs

(Internal)



---

## INTERTEK TESTING SERVICES

---

### Equipment Photographs

(Internal)



---

# INTERTEK TESTING SERVICES

---

## Equipment Photographs

(Internal)

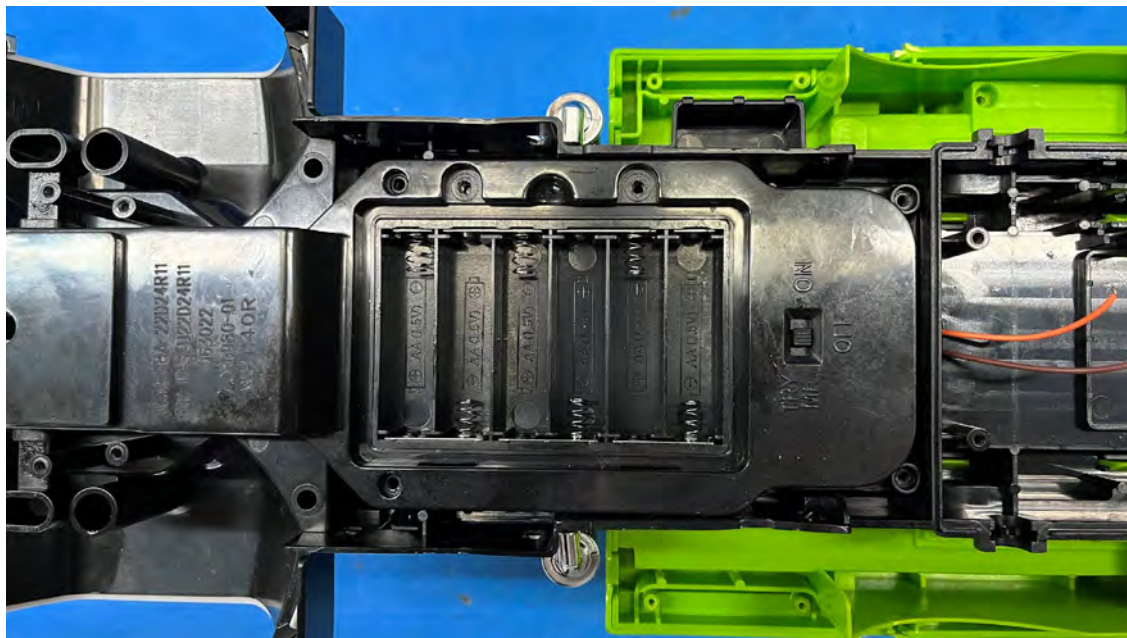

---

FCC ID: SLU22D24R16  
IC: 10718A-22D24R16

---

# INTERTEK TESTING SERVICES

---

## Equipment Photographs

(Internal)





---

# INTERTEK TESTING SERVICES

---

## Equipment Photographs

(Internal)

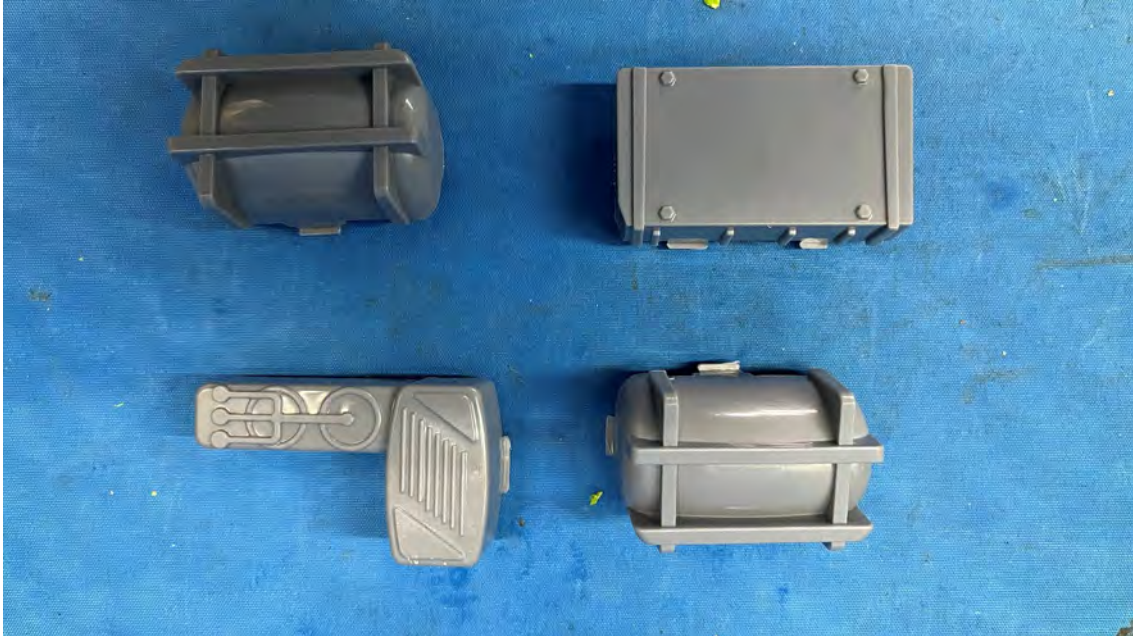

---

# INTERTEK TESTING SERVICES

---

## Equipment Photographs

(Internal)



---

# INTERTEK TESTING SERVICES

---

## Equipment Photographs

(Internal)



---

# INTERTEK TESTING SERVICES

---

## Equipment Photographs

(Internal)

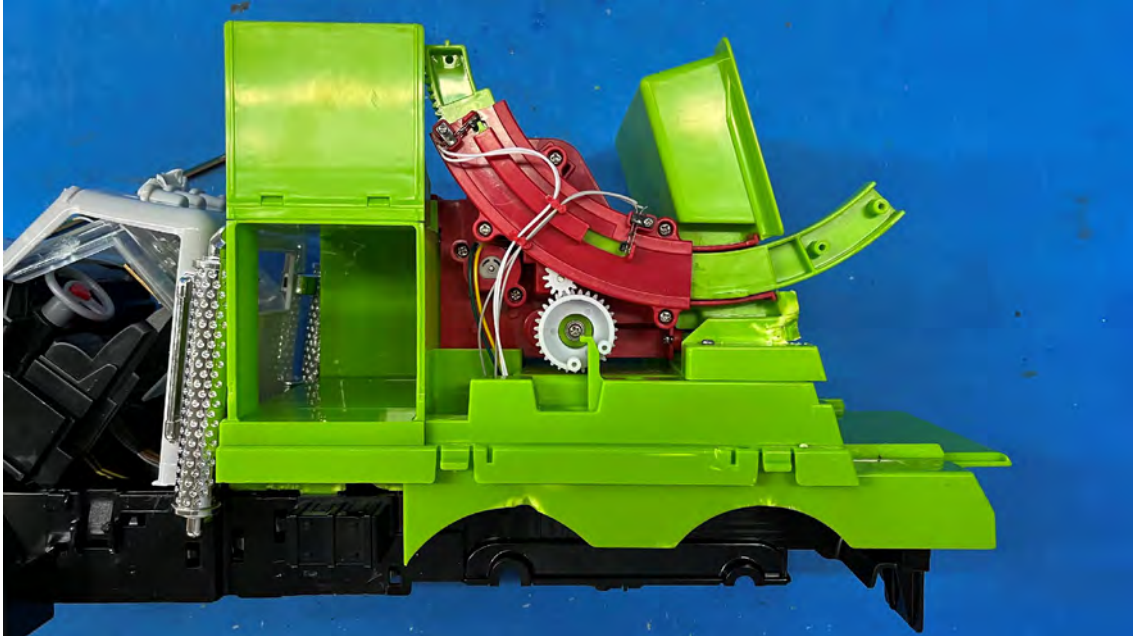

---

# INTERTEK TESTING SERVICES

---

## Equipment Photographs

(Internal)

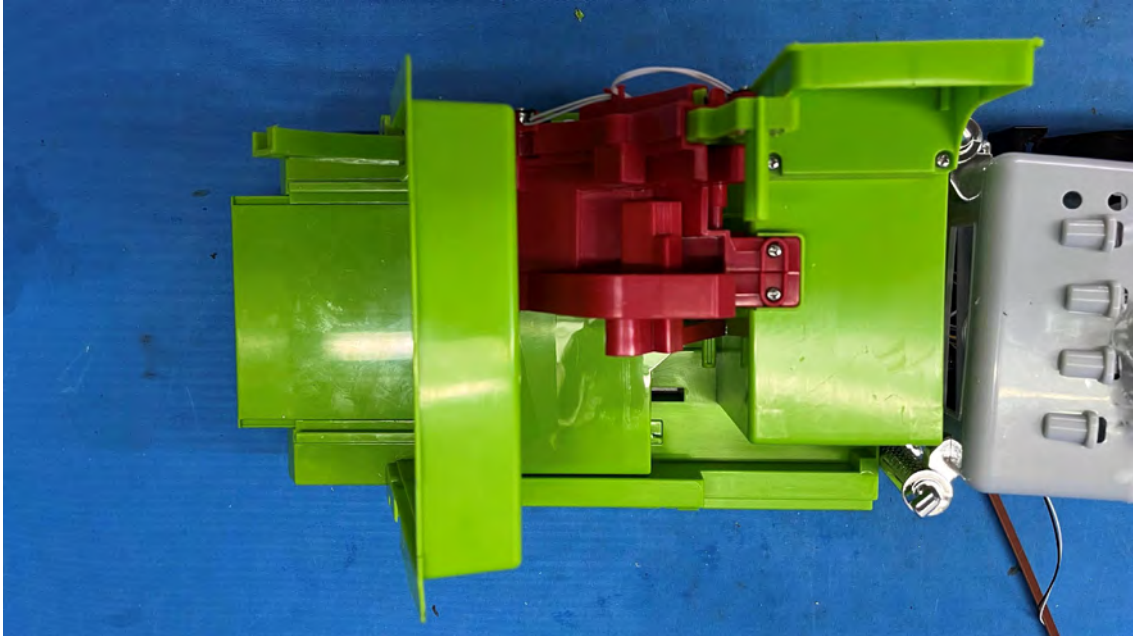

---

# INTERTEK TESTING SERVICES

---

## Equipment Photographs

(Internal)



---

# INTERTEK TESTING SERVICES

---

## Equipment Photographs

(Internal)



---

# INTERTEK TESTING SERVICES

---

## Equipment Photographs

(Internal)

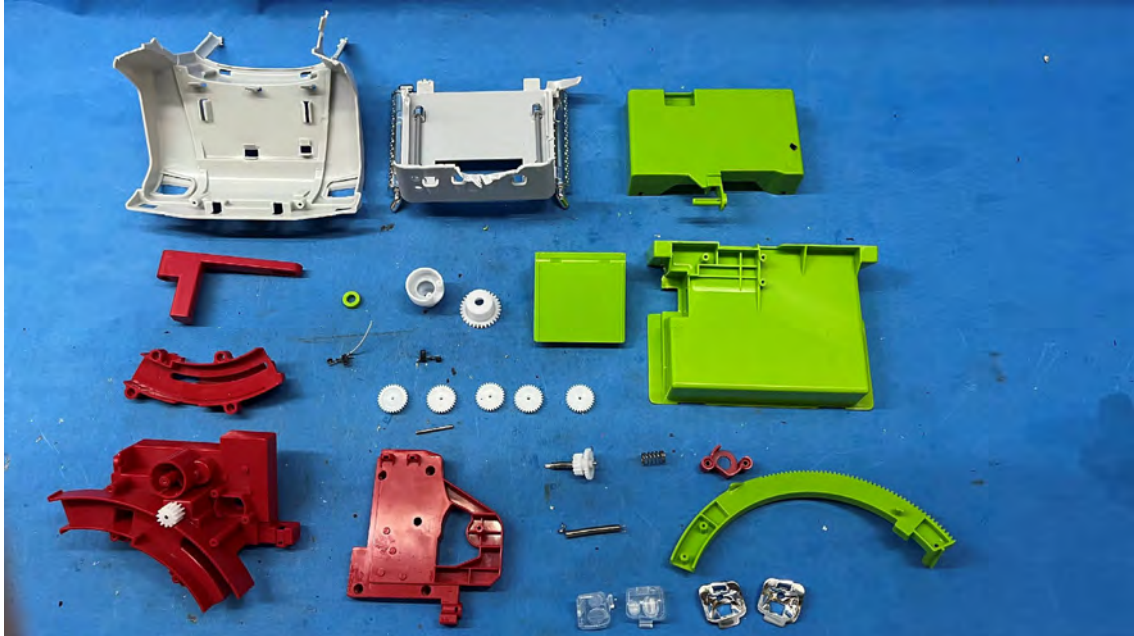



---

## INTERTEK TESTING SERVICES

---

### Equipment Photographs

(Internal)



---

# INTERTEK TESTING SERVICES

---

## Equipment Photographs

(Internal)

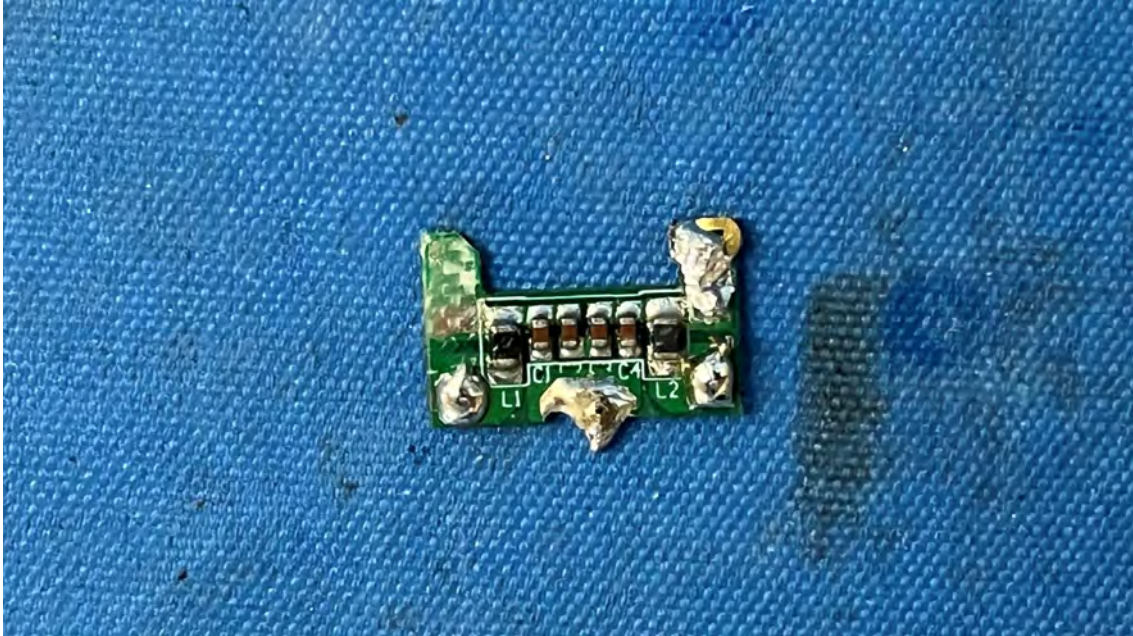

---

## INTERTEK TESTING SERVICES

---

### Equipment Photographs

(Internal)

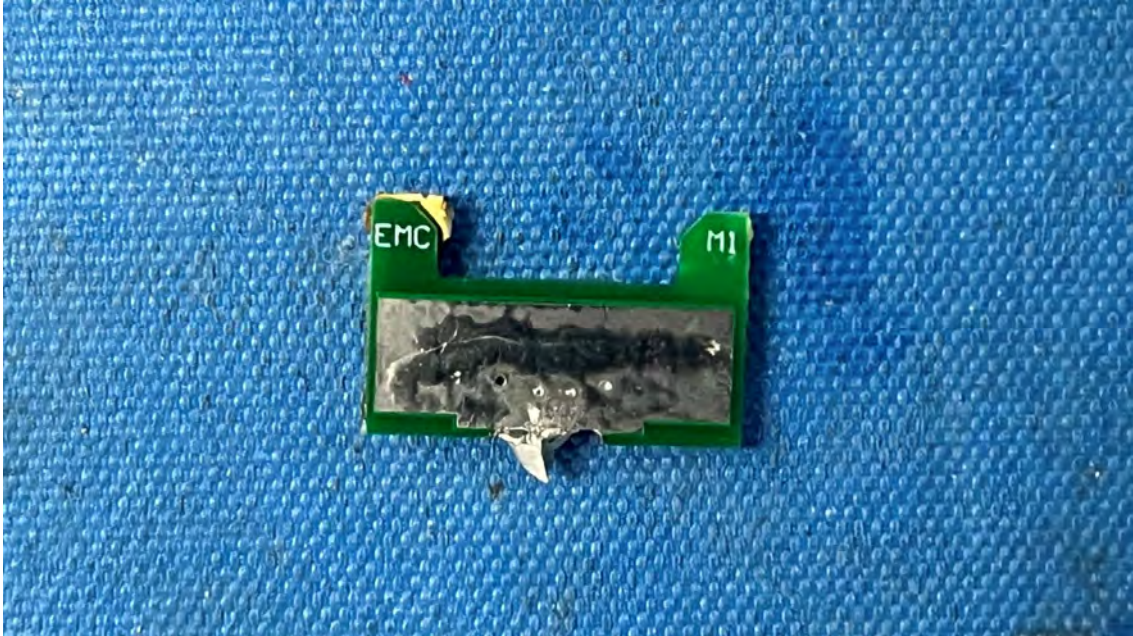

---

## INTERTEK TESTING SERVICES

---

### Equipment Photographs

(Internal)



---

## INTERTEK TESTING SERVICES

---

### Equipment Photographs

(Internal)



---

# INTERTEK TESTING SERVICES

---

## Equipment Photographs

(Internal)



---

# INTERTEK TESTING SERVICES

---

## Equipment Photographs

(Internal)



---

# INTERTEK TESTING SERVICES

---

## Equipment Photographs

(Internal)

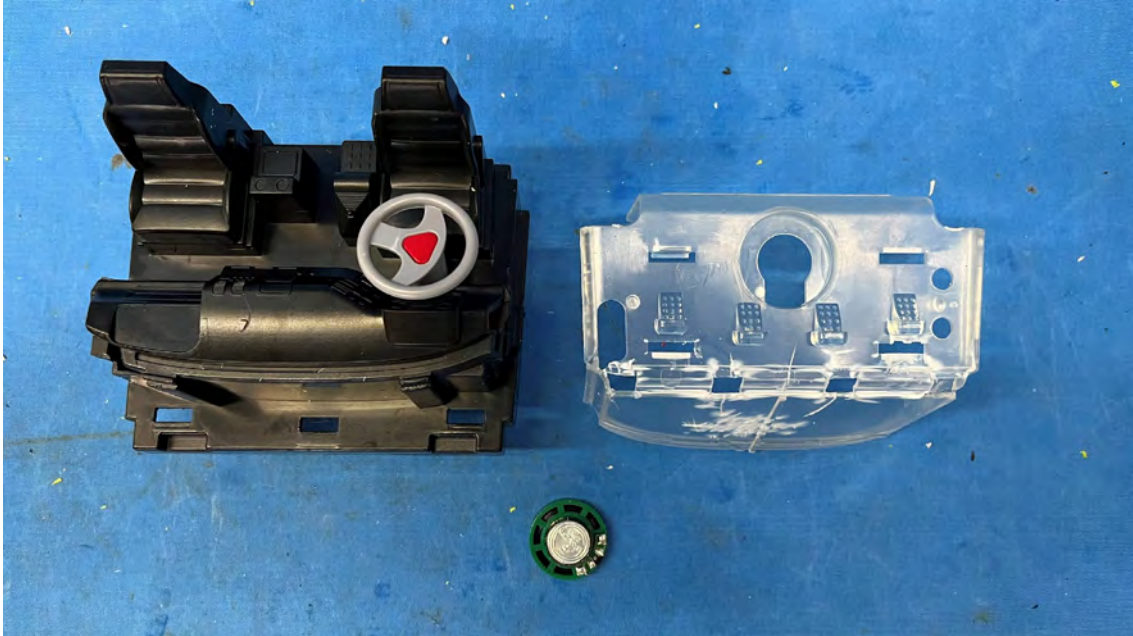



---

# INTERTEK TESTING SERVICES

---

## Equipment Photographs

(Internal)

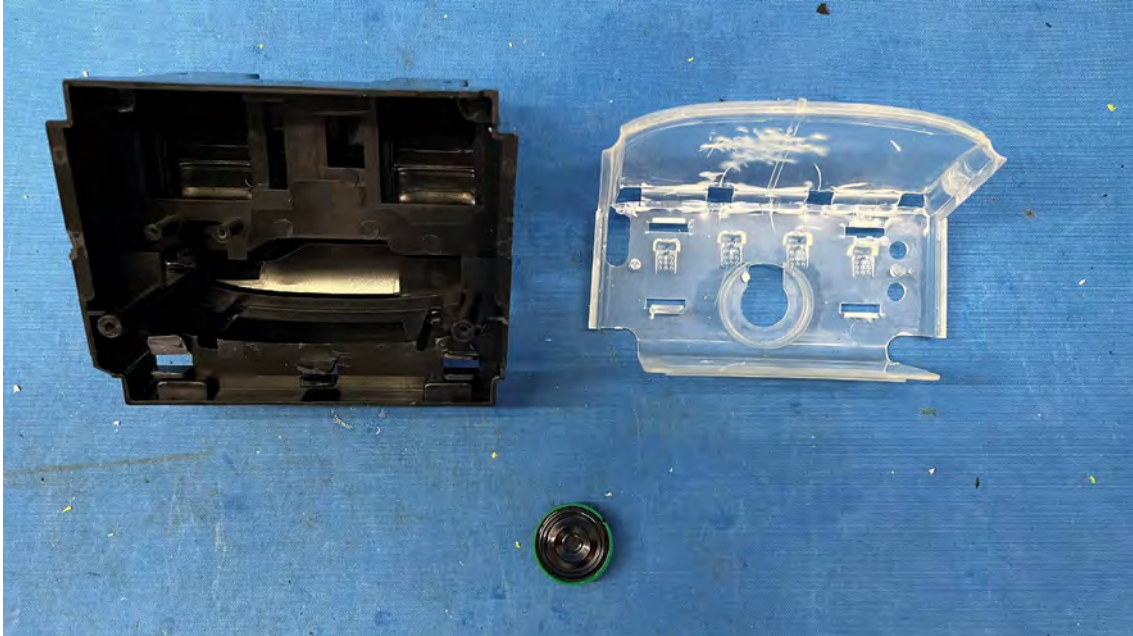

---

# INTERTEK TESTING SERVICES

---

## Equipment Photographs

(Internal)

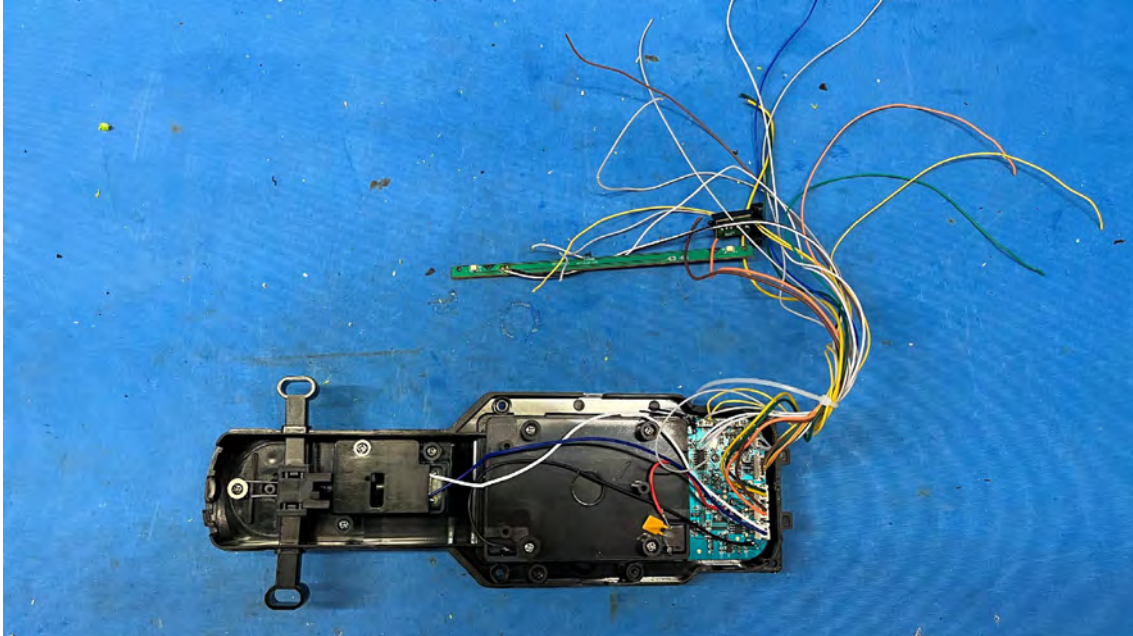

---

# INTERTEK TESTING SERVICES

---

## Equipment Photographs

(Internal)

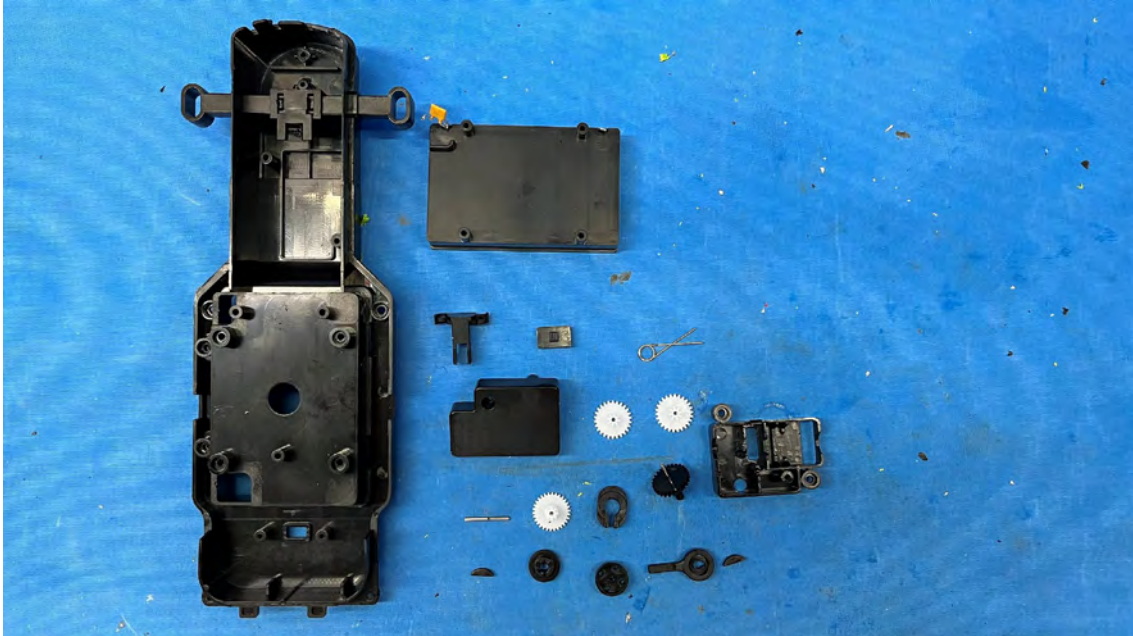

---

# INTERTEK TESTING SERVICES

---

## Equipment Photographs

(Internal)



---

FCC ID: SLU22D24R16  
IC: 10718A-22D24R16

---

## INTERTEK TESTING SERVICES

---

### Equipment Photographs

(Internal)

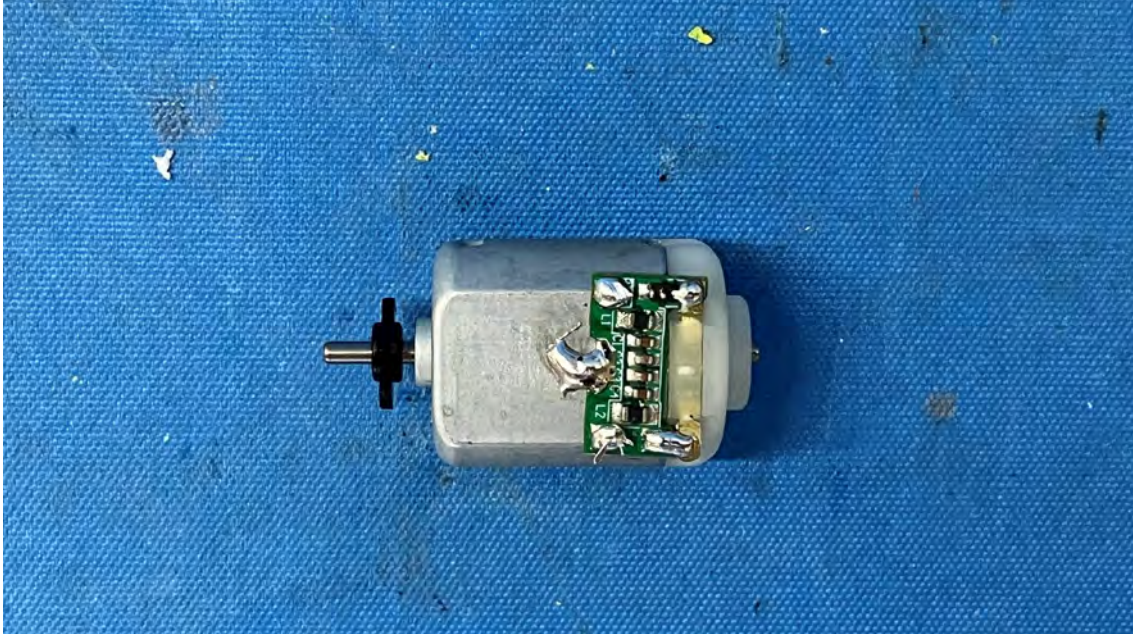

---

## INTERTEK TESTING SERVICES

---

### Equipment Photographs

(Internal)



---

## INTERTEK TESTING SERVICES

---

### Equipment Photographs

(Internal)

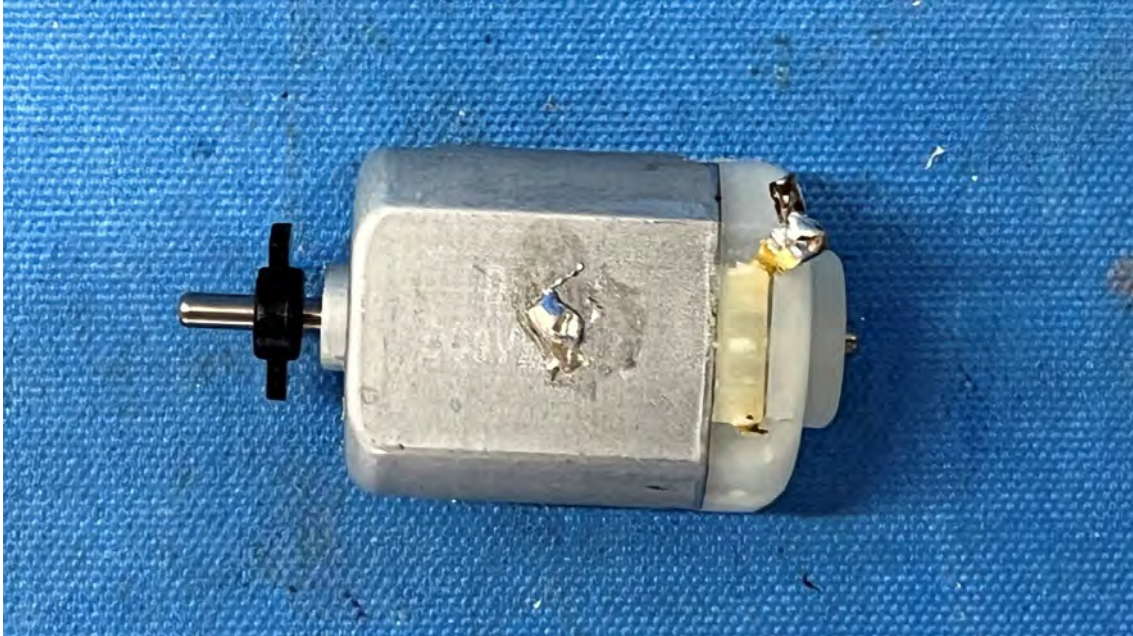

---

# INTERTEK TESTING SERVICES

---

## Equipment Photographs

(Internal)

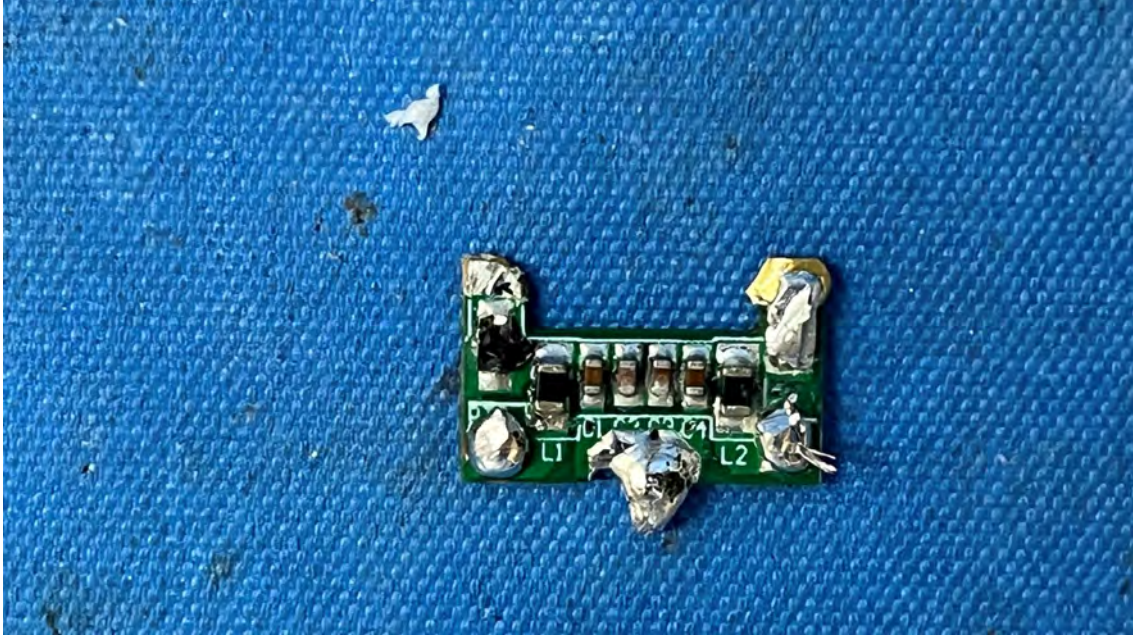



---

## INTERTEK TESTING SERVICES

---

### Equipment Photographs

(Internal)

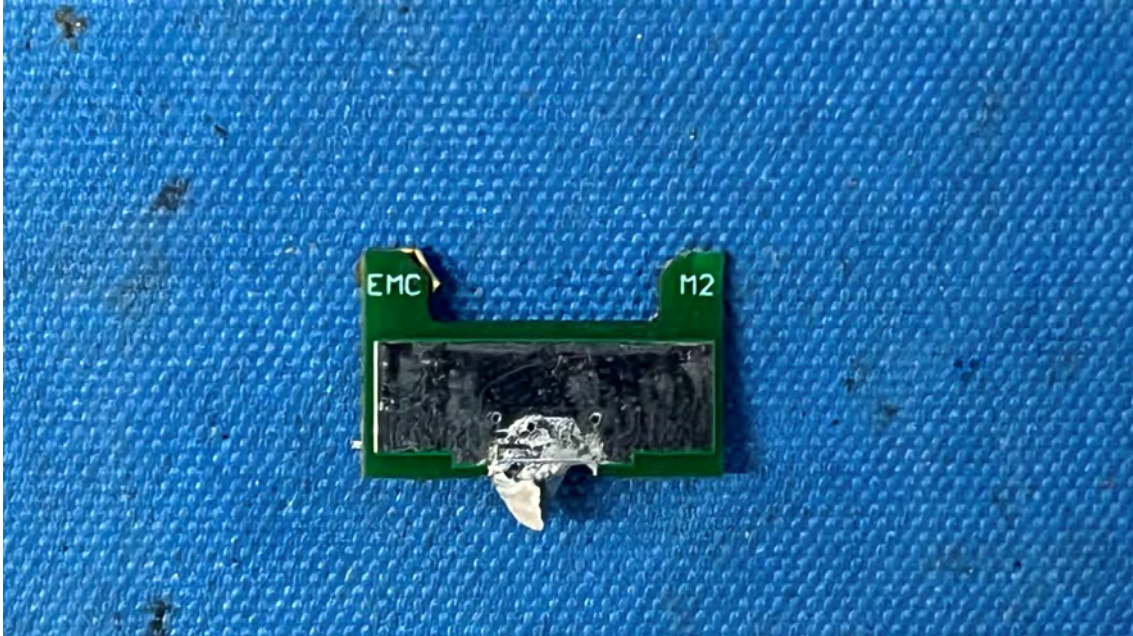

---

# INTERTEK TESTING SERVICES

---

## Equipment Photographs

(Internal)

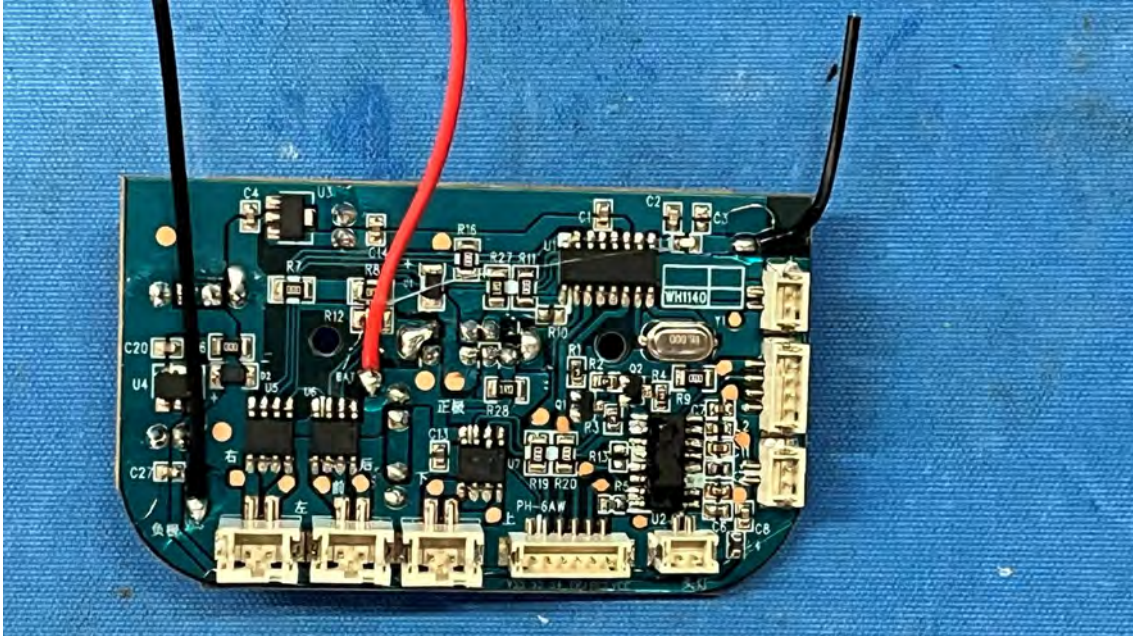

---

FCC ID: SLU22D24R16  
IC: 10718A-22D24R16

---

# INTERTEK TESTING SERVICES

---

## Equipment Photographs

(Internal)

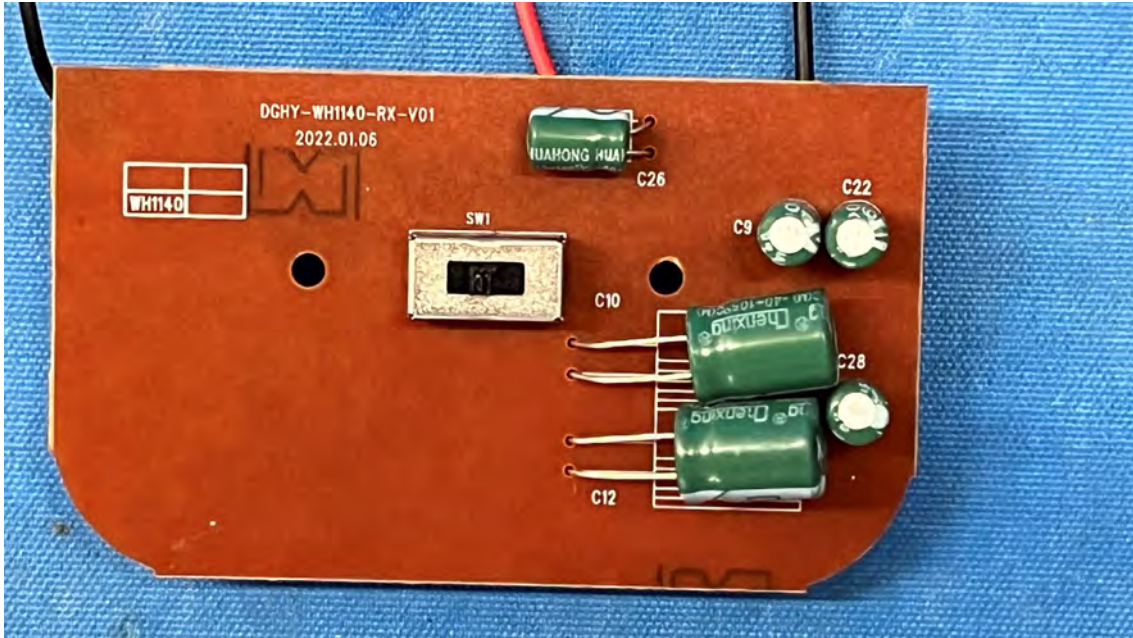

---

# INTERTEK TESTING SERVICES

---

## Equipment Photographs

(Internal)

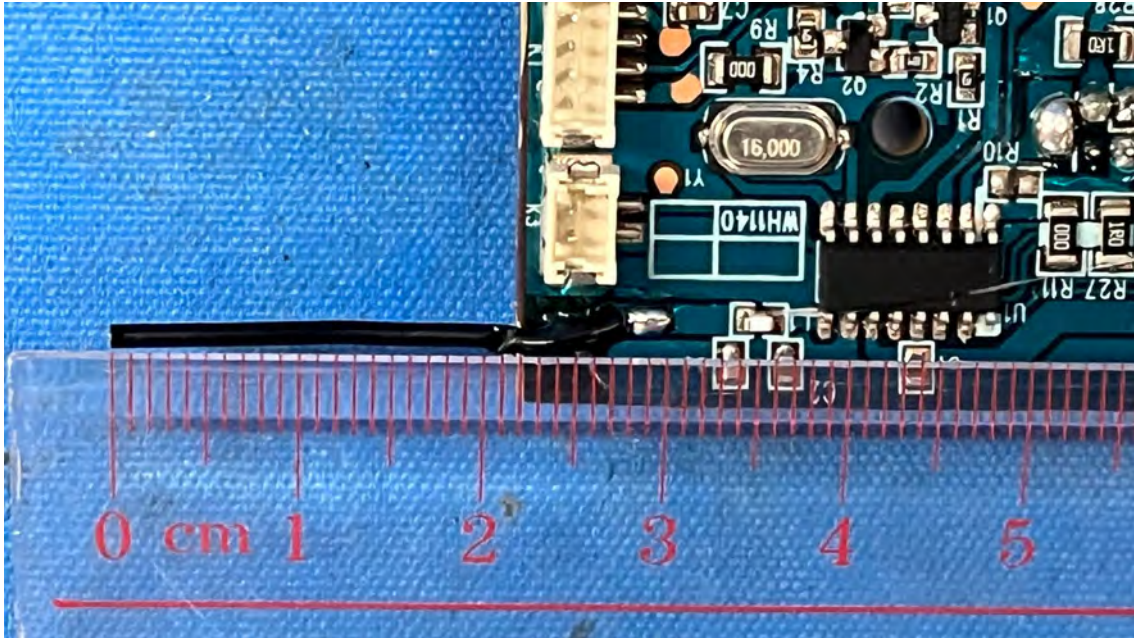

---

# INTERTEK TESTING SERVICES

---

## Equipment Photographs

(Internal)

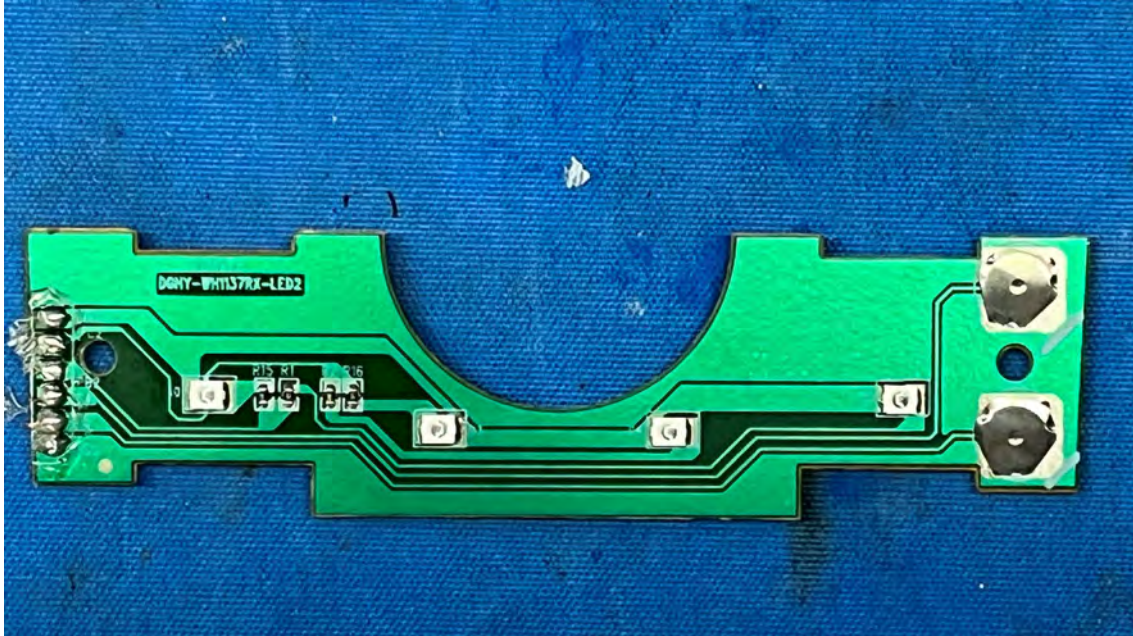

---

**INTERTEK TESTING SERVICES**

---

**Equipment Photographs**

**(Internal)**

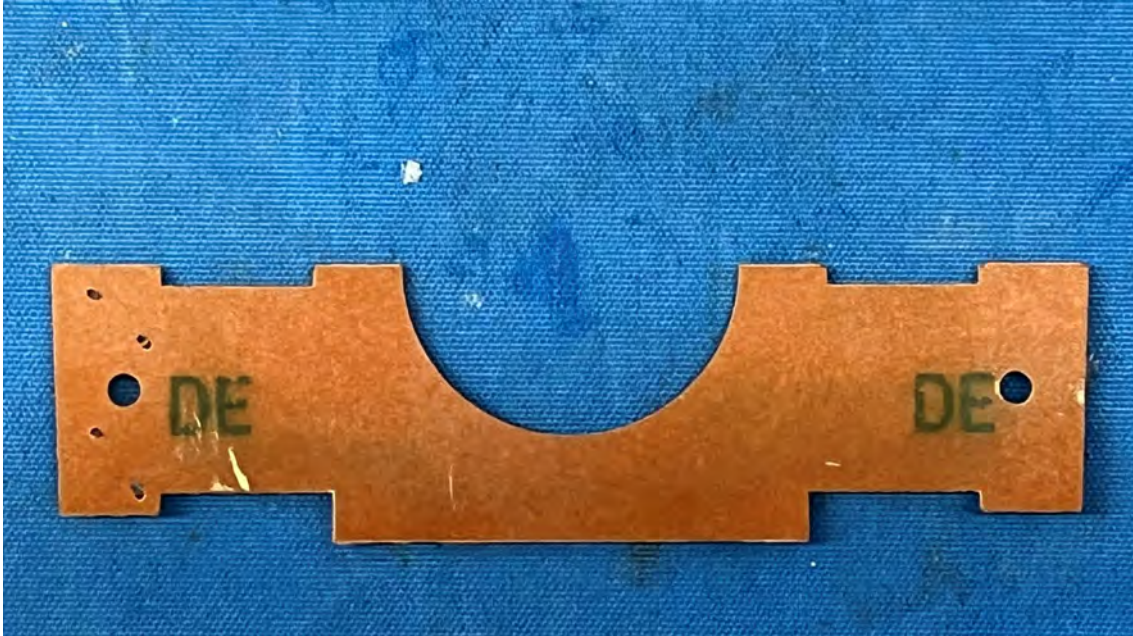

---

# INTERTEK TESTING SERVICES

---

## Equipment Photographs

(Internal)



---

## INTERTEK TESTING SERVICES

---

### Equipment Photographs

(Internal)





---

# INTERTEK TESTING SERVICES

---

## Equipment Photographs

(Internal)

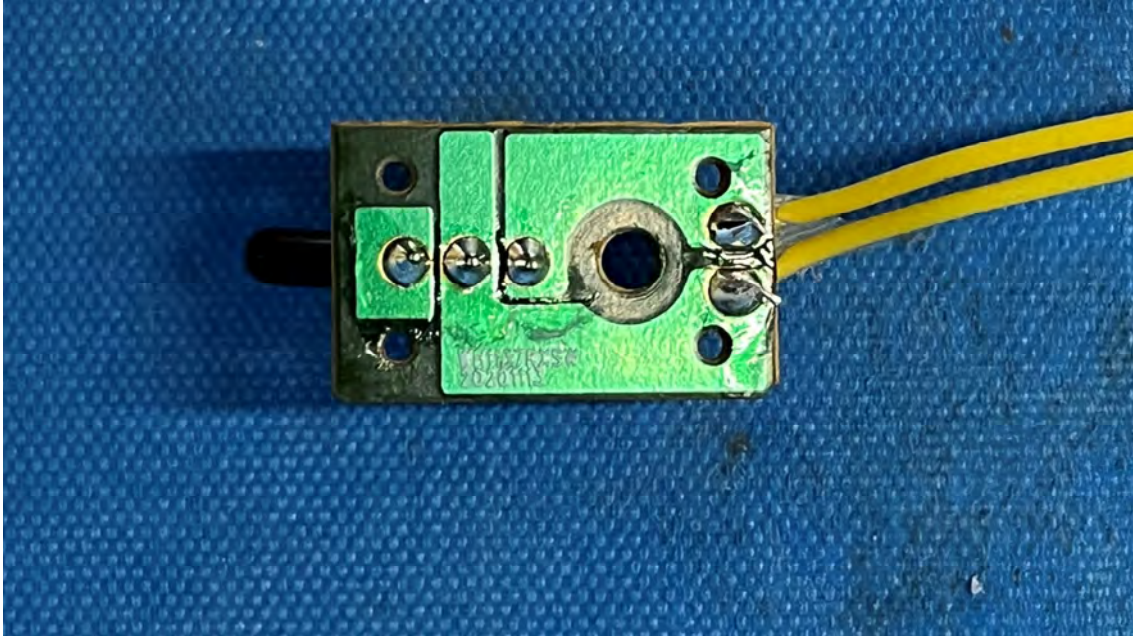

---

# INTERTEK TESTING SERVICES

---

## Equipment Photographs

(Internal)

