

INTERTEK TESTING SERVICES

Equipment Photographs

(Internal)

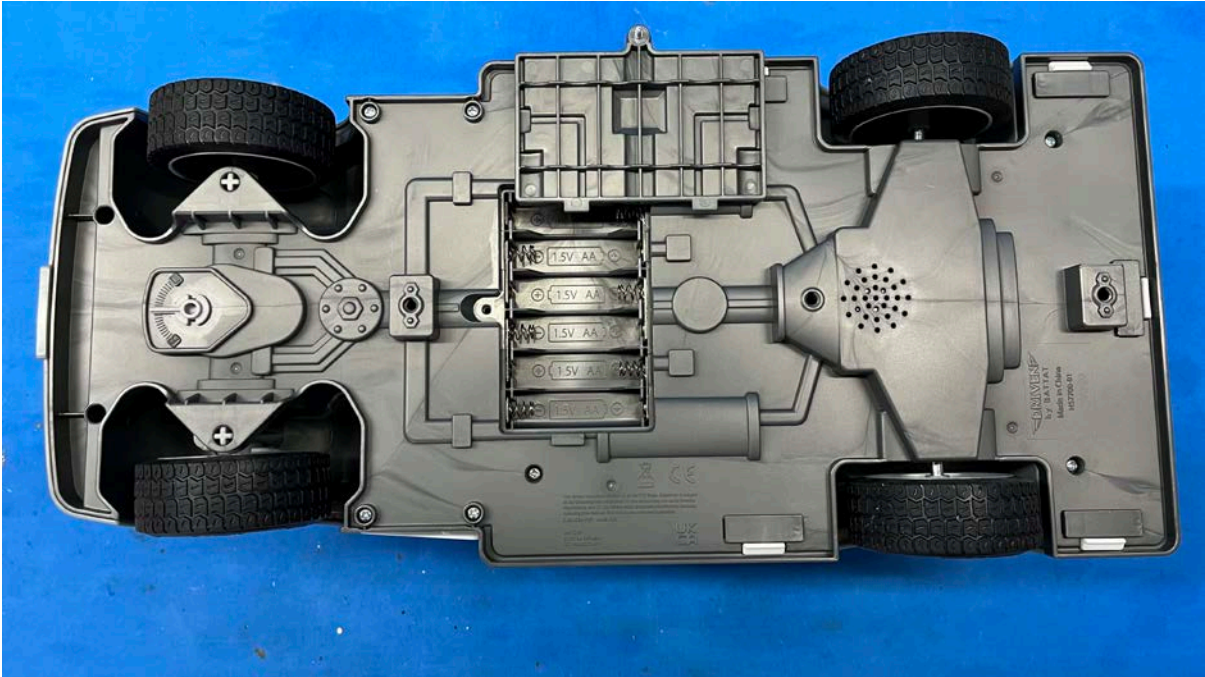

INTERTEK TESTING SERVICES

Equipment Photographs

(Internal)



INTERTEK TESTING SERVICES

Equipment Photographs

(Internal)

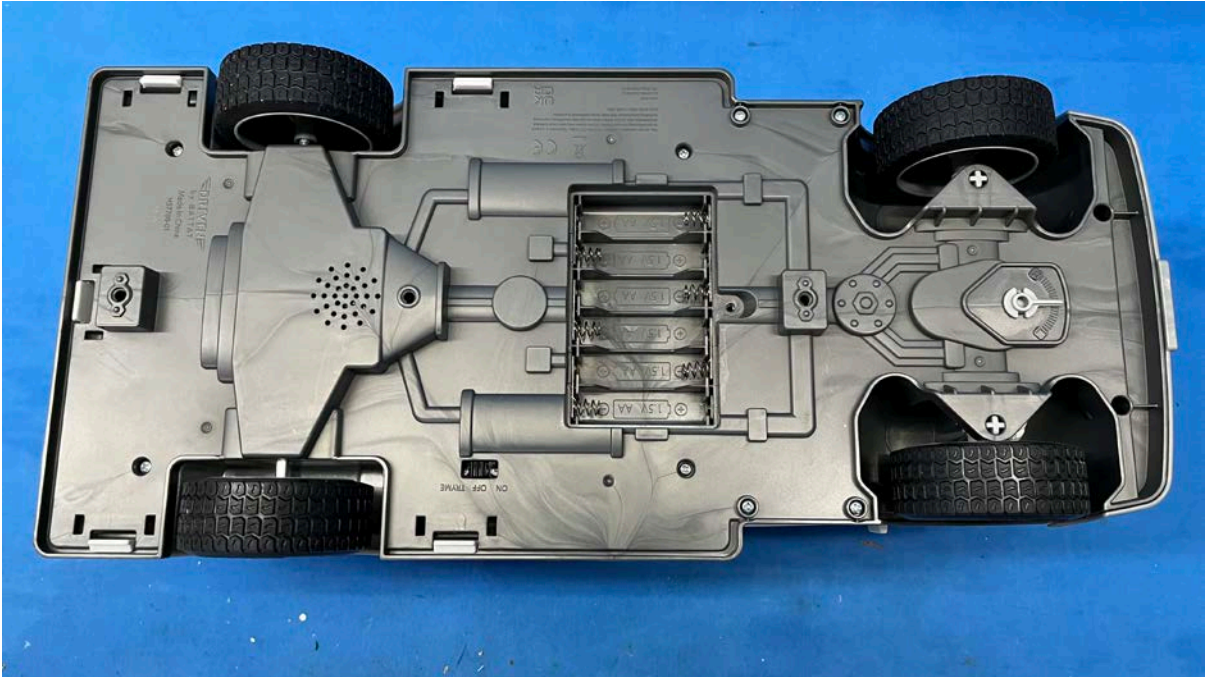

INTERTEK TESTING SERVICES

Equipment Photographs

(Internal)

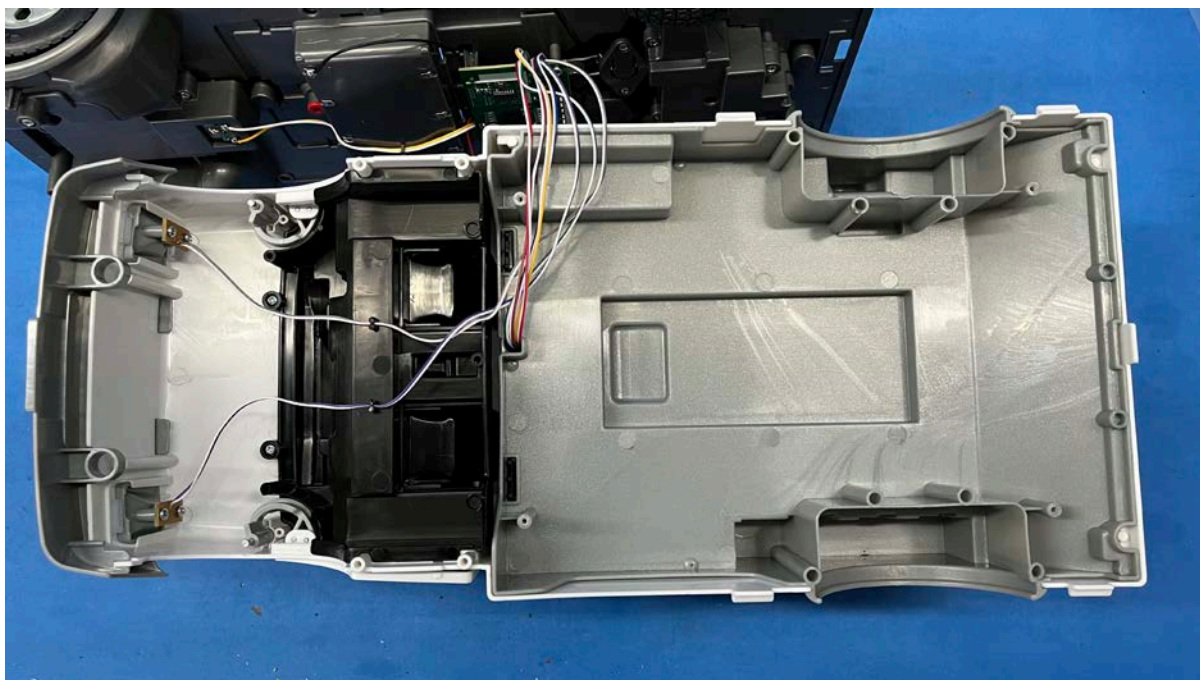

INTERTEK TESTING SERVICES

Equipment Photographs

(Internal)

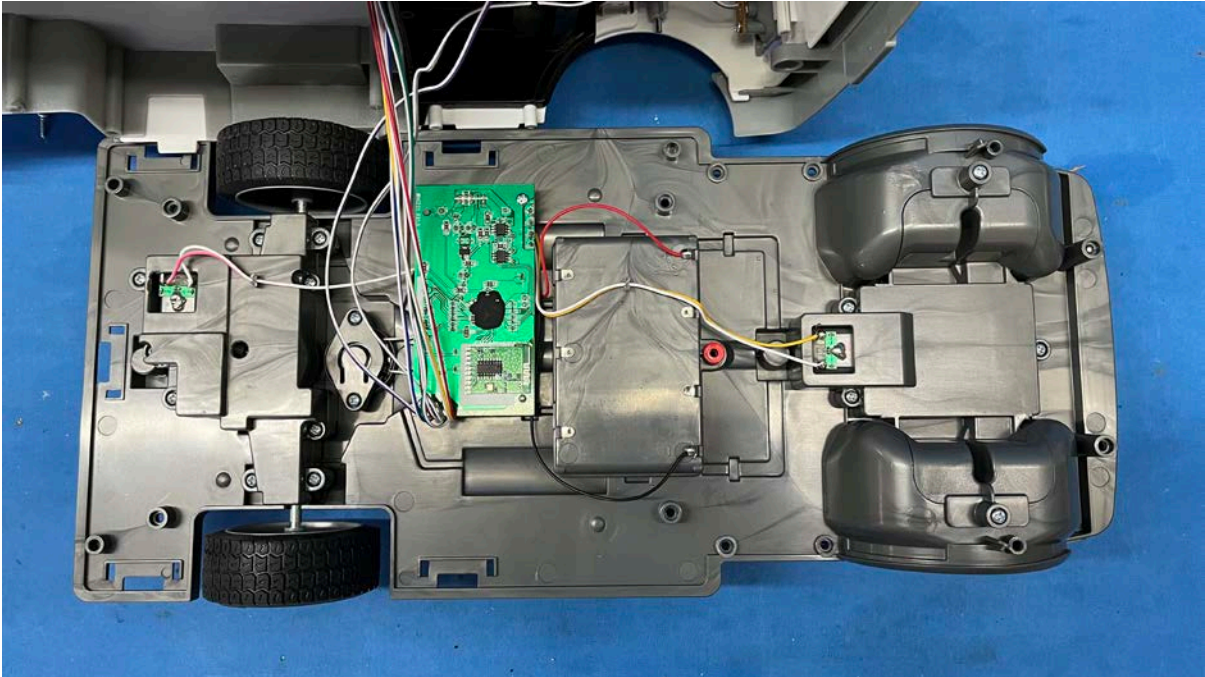

INTERTEK TESTING SERVICES

Equipment Photographs

(Internal)

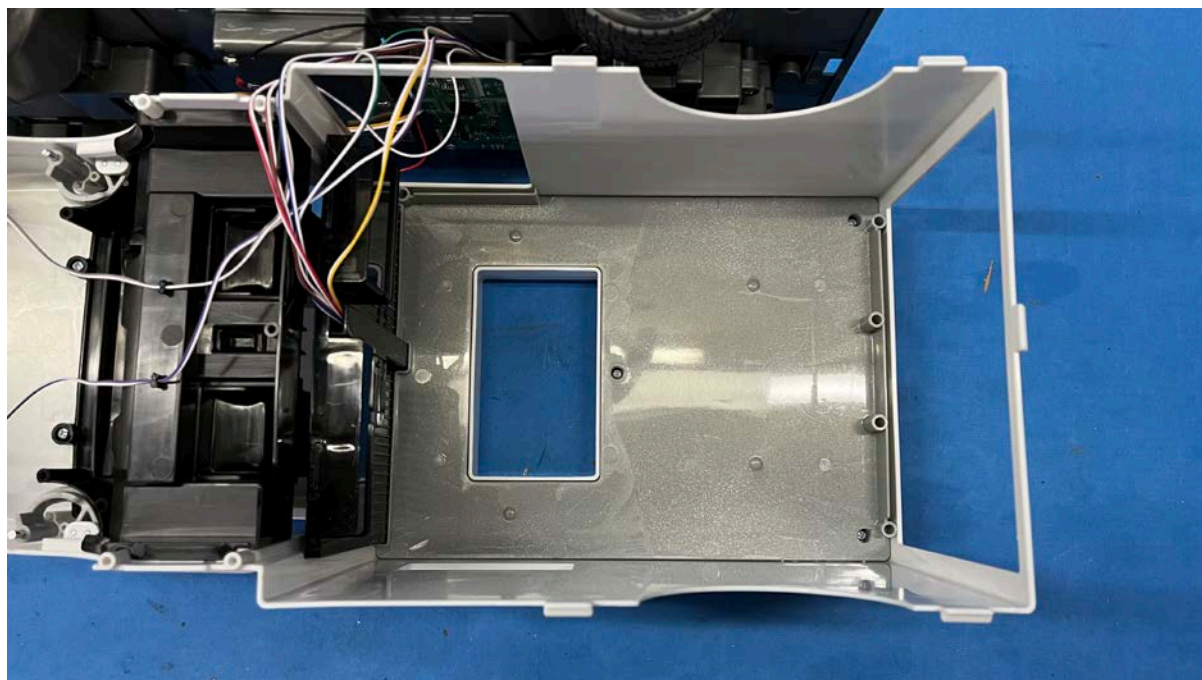

INTERTEK TESTING SERVICES

Equipment Photographs

(Internal)

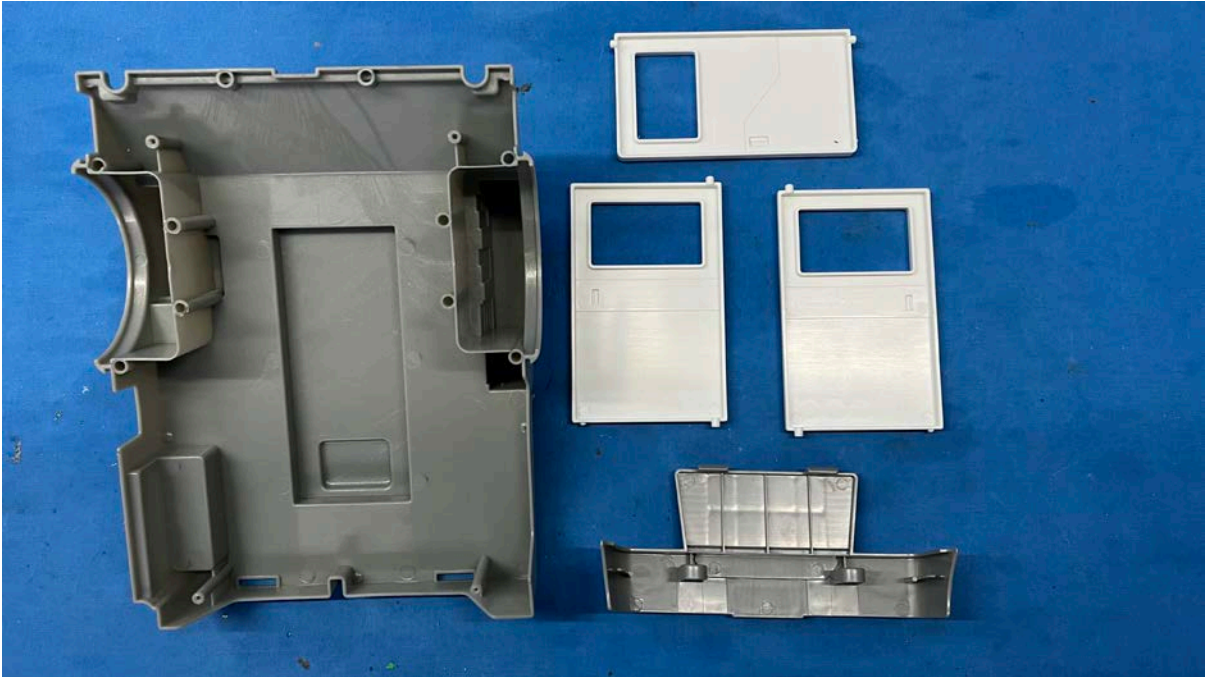

INTERTEK TESTING SERVICES

Equipment Photographs

(Internal)

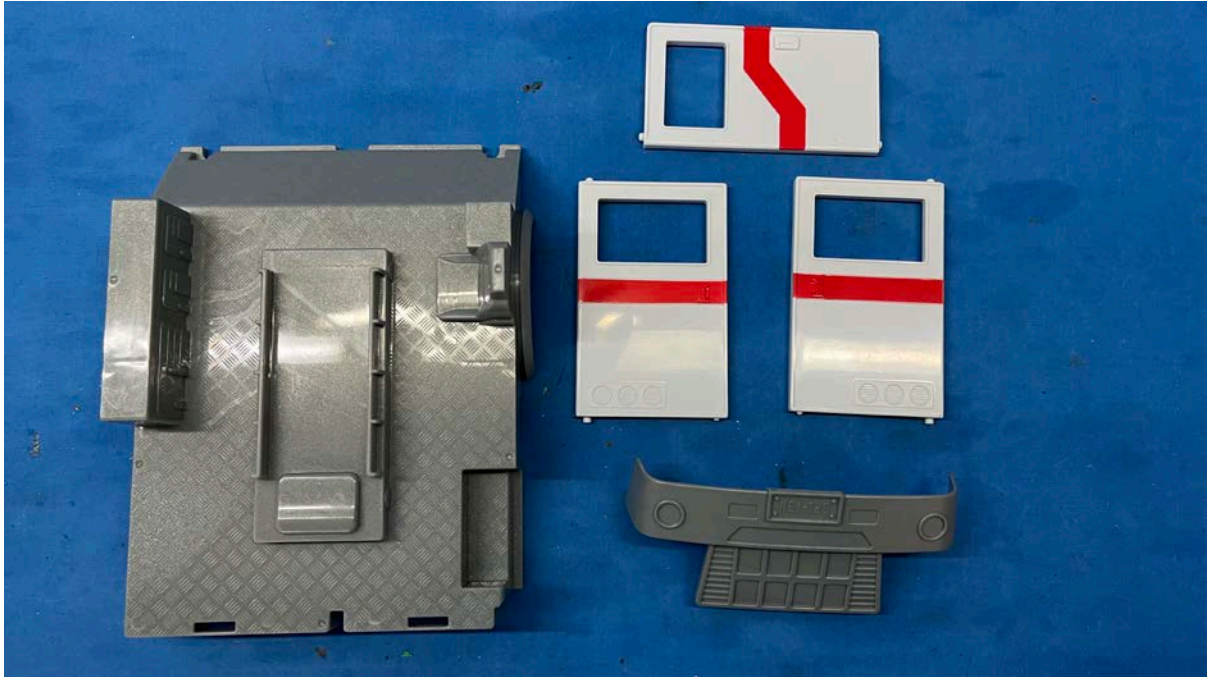

INTERTEK TESTING SERVICES

Equipment Photographs

(Internal)

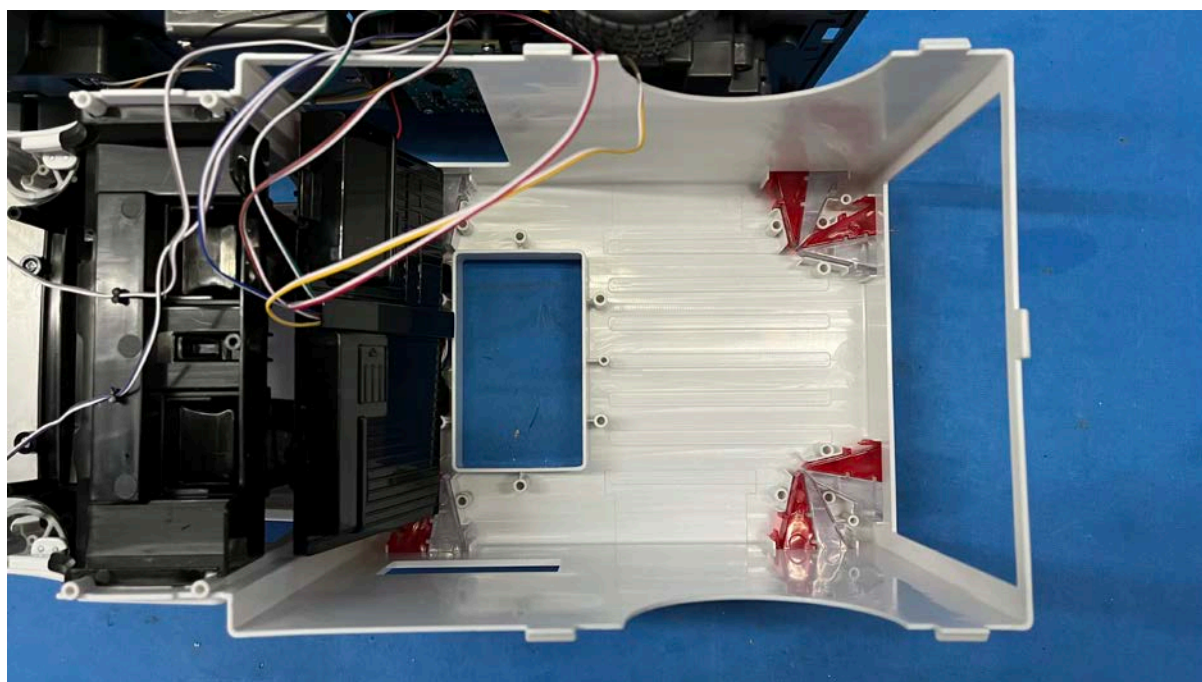

INTERTEK TESTING SERVICES

Equipment Photographs

(Internal)

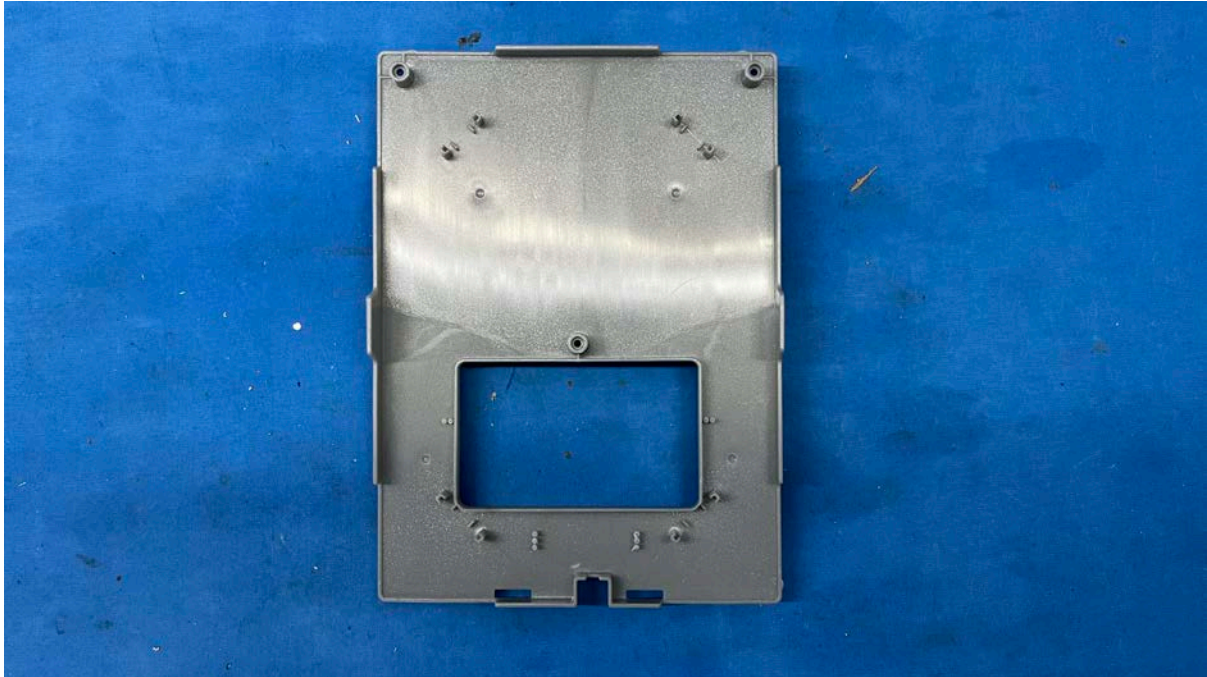

INTERTEK TESTING SERVICES

Equipment Photographs

(Internal)



INTERTEK TESTING SERVICES

Equipment Photographs

(Internal)

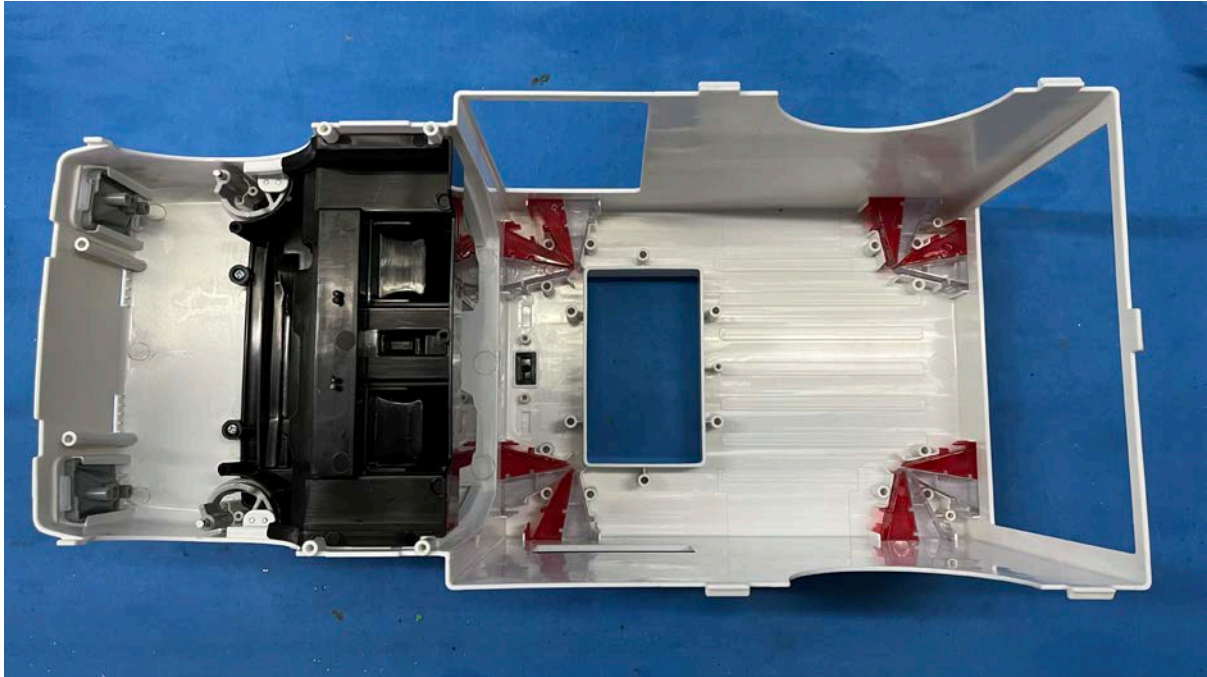

INTERTEK TESTING SERVICES

Equipment Photographs

(Internal)

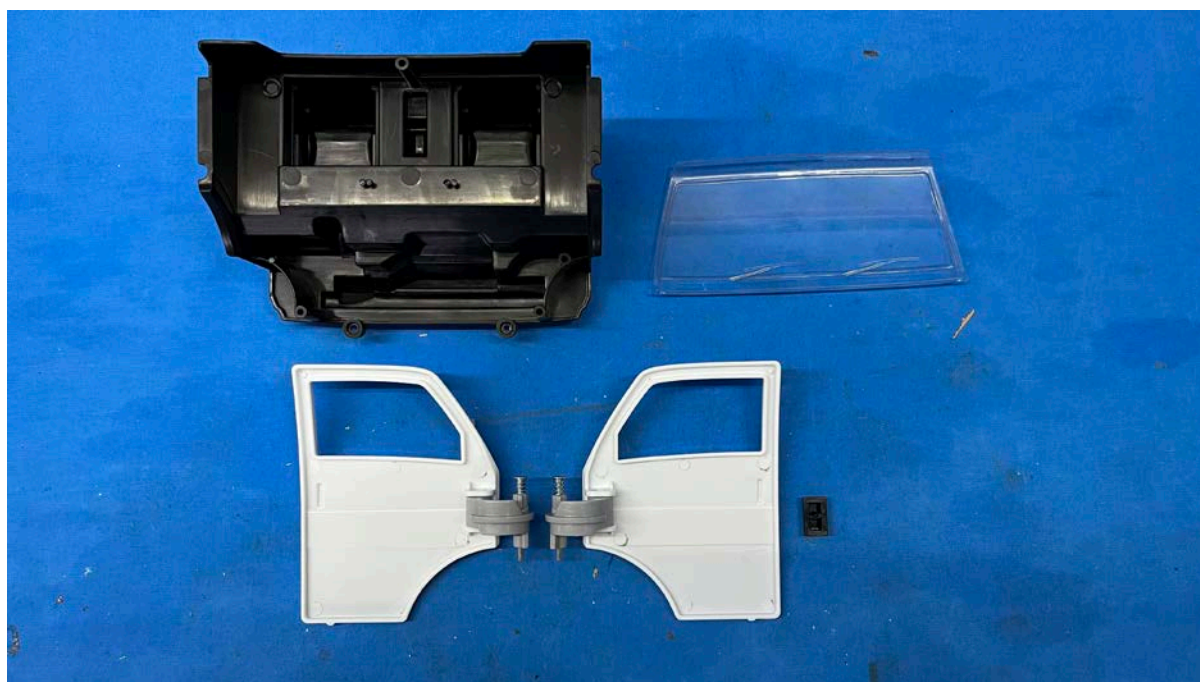

INTERTEK TESTING SERVICES

Equipment Photographs

(Internal)



INTERTEK TESTING SERVICES

Equipment Photographs

(Internal)

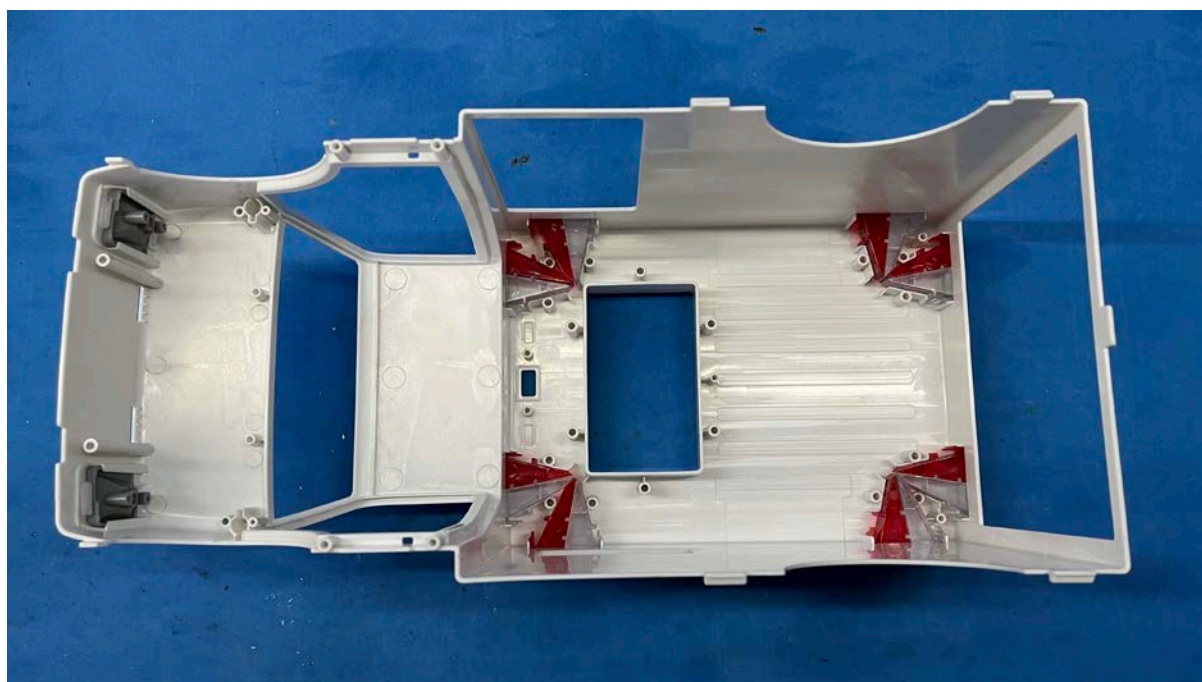

INTERTEK TESTING SERVICES

Equipment Photographs

(Internal)

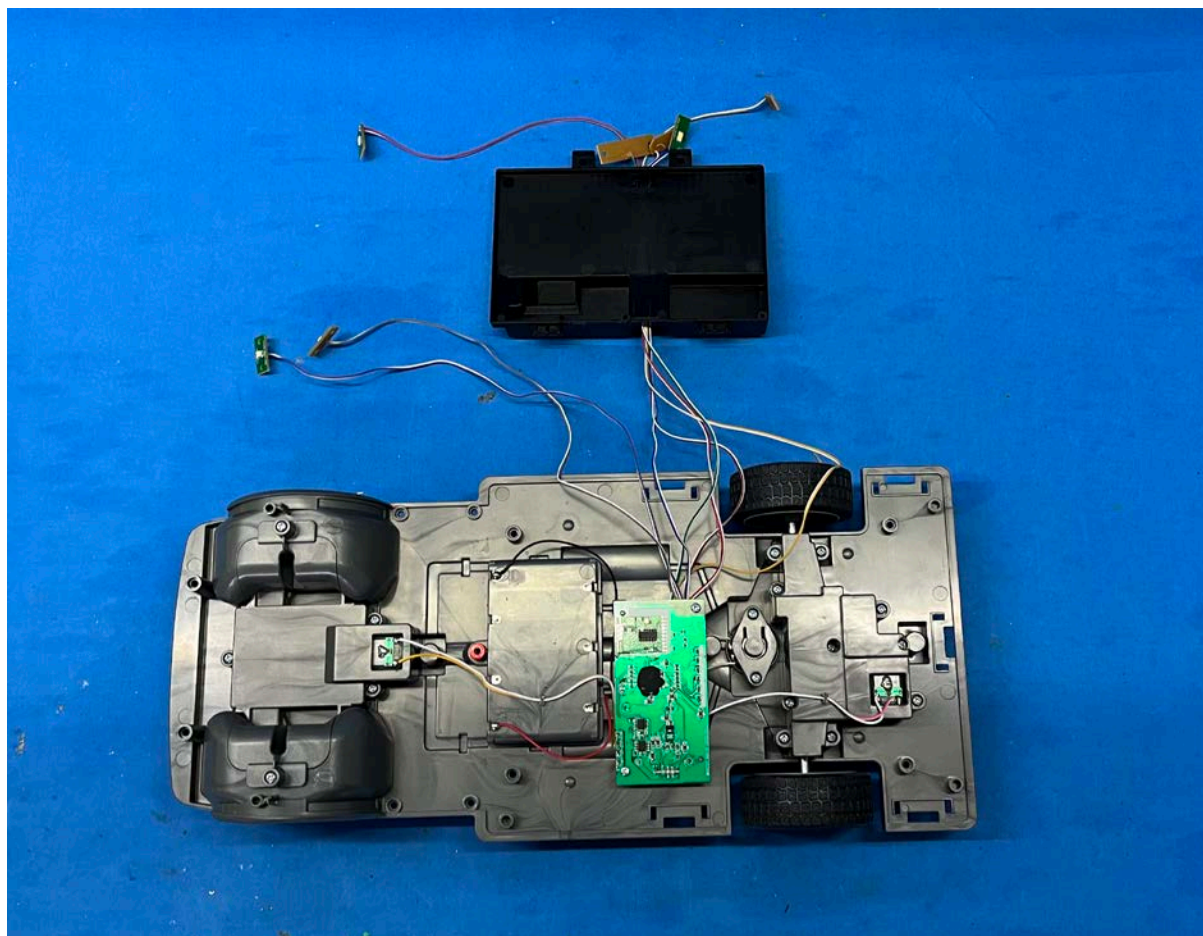

INTERTEK TESTING SERVICES

Equipment Photographs

(Internal)

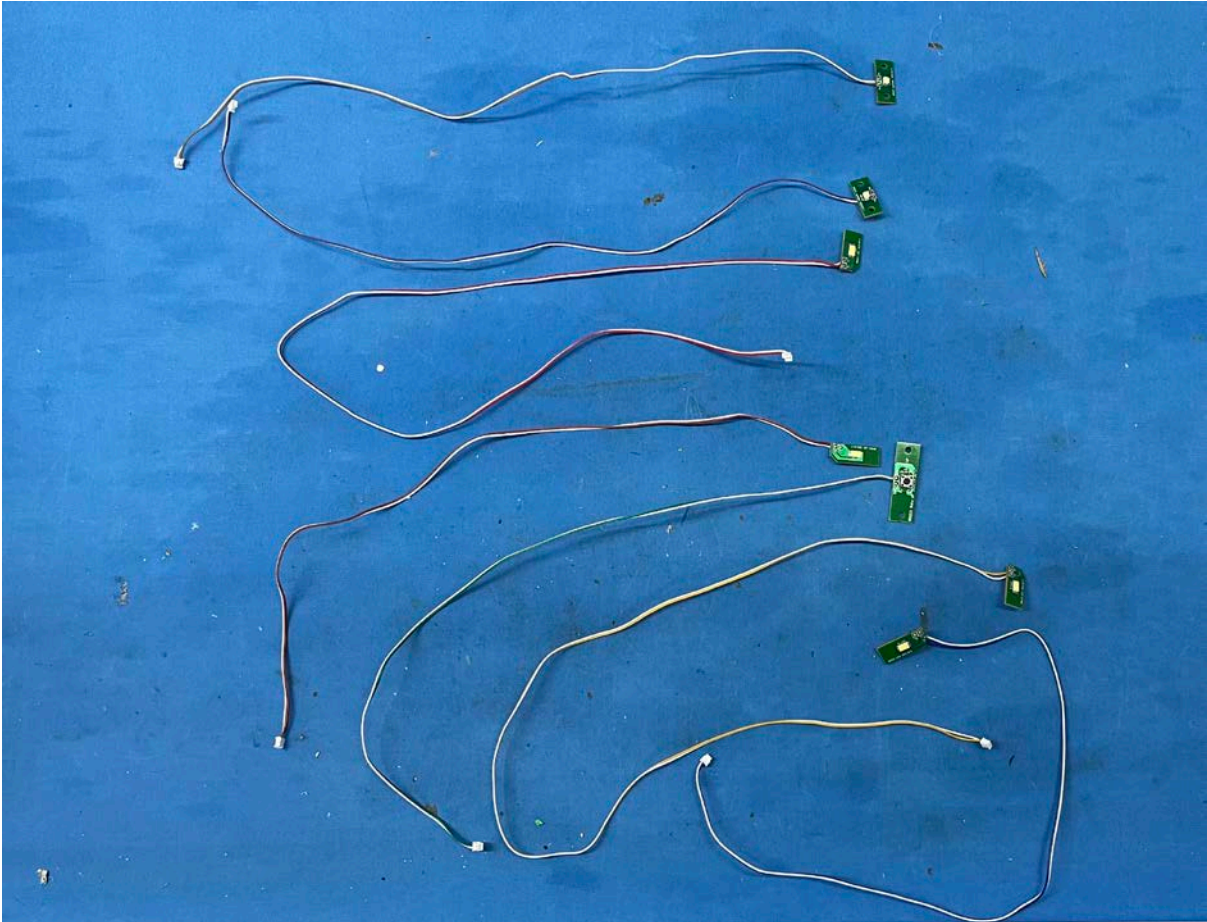

INTERTEK TESTING SERVICES

Equipment Photographs

(Internal)

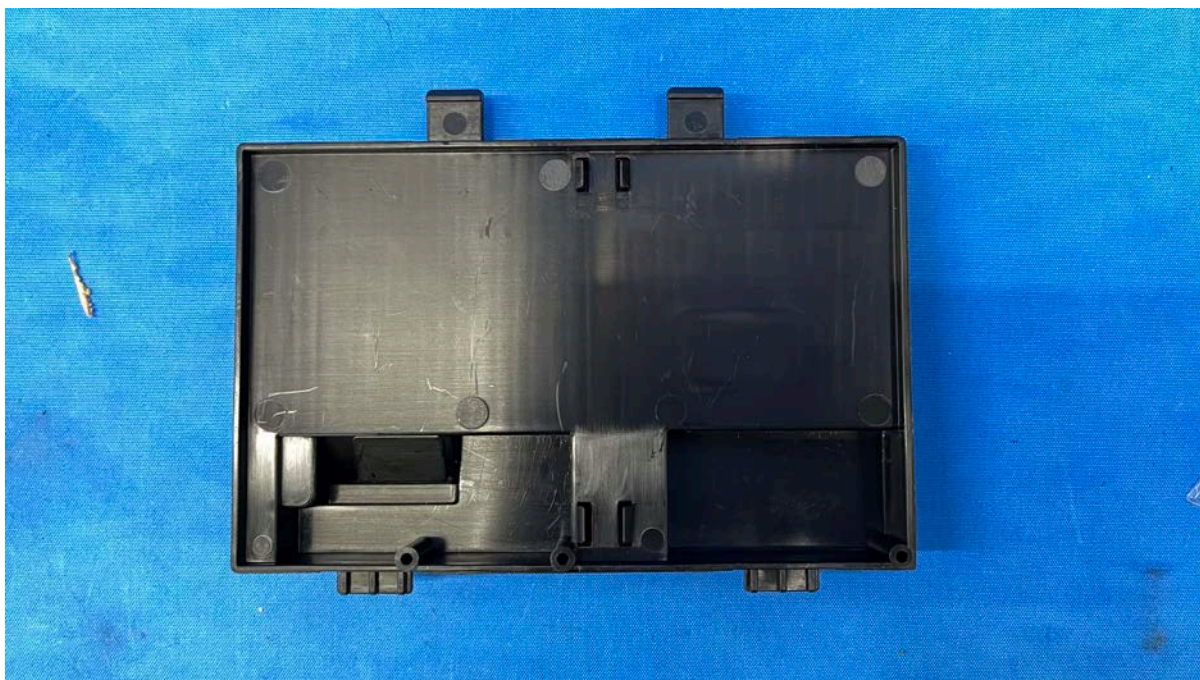

INTERTEK TESTING SERVICES

Equipment Photographs

(Internal)



INTERTEK TESTING SERVICES

Equipment Photographs

(Internal)

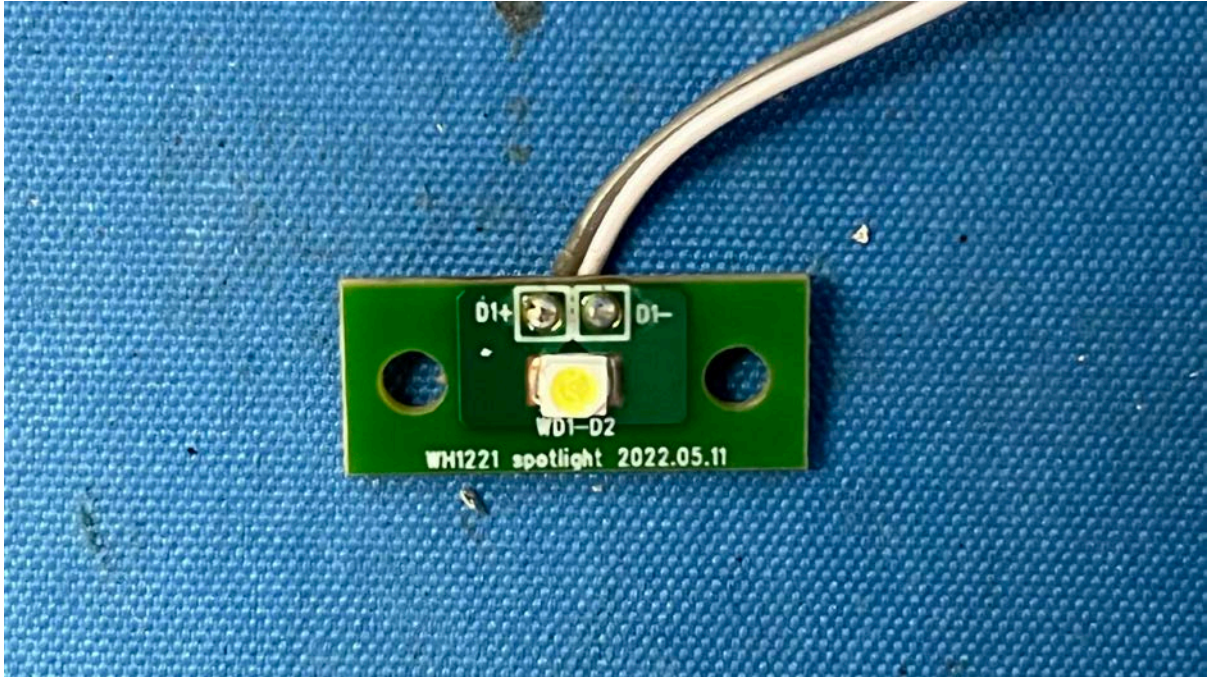

INTERTEK TESTING SERVICES

Equipment Photographs

(Internal)

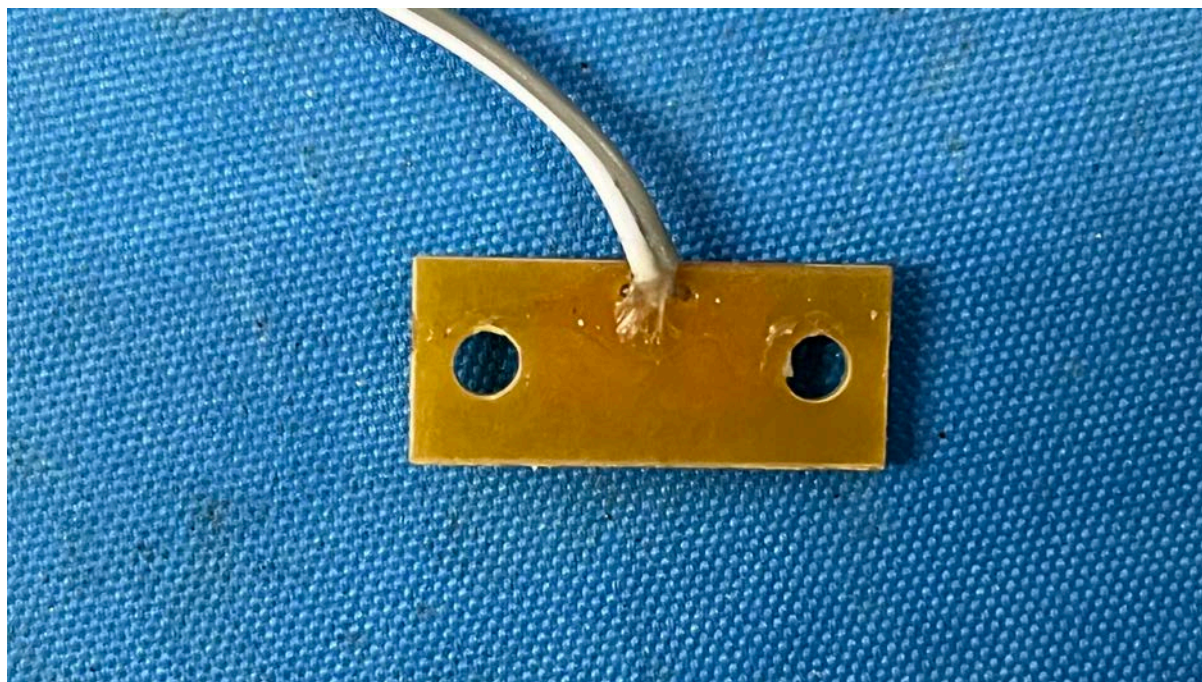

INTERTEK TESTING SERVICES

Equipment Photographs

(Internal)

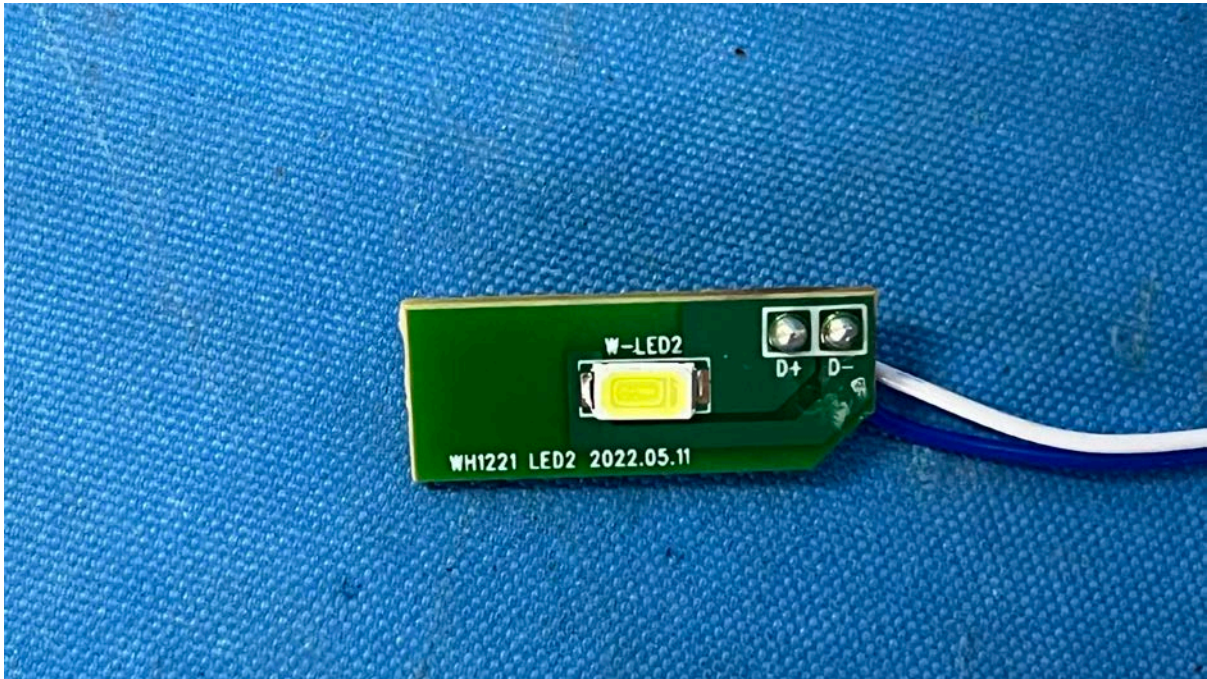

INTERTEK TESTING SERVICES

Equipment Photographs

(Internal)

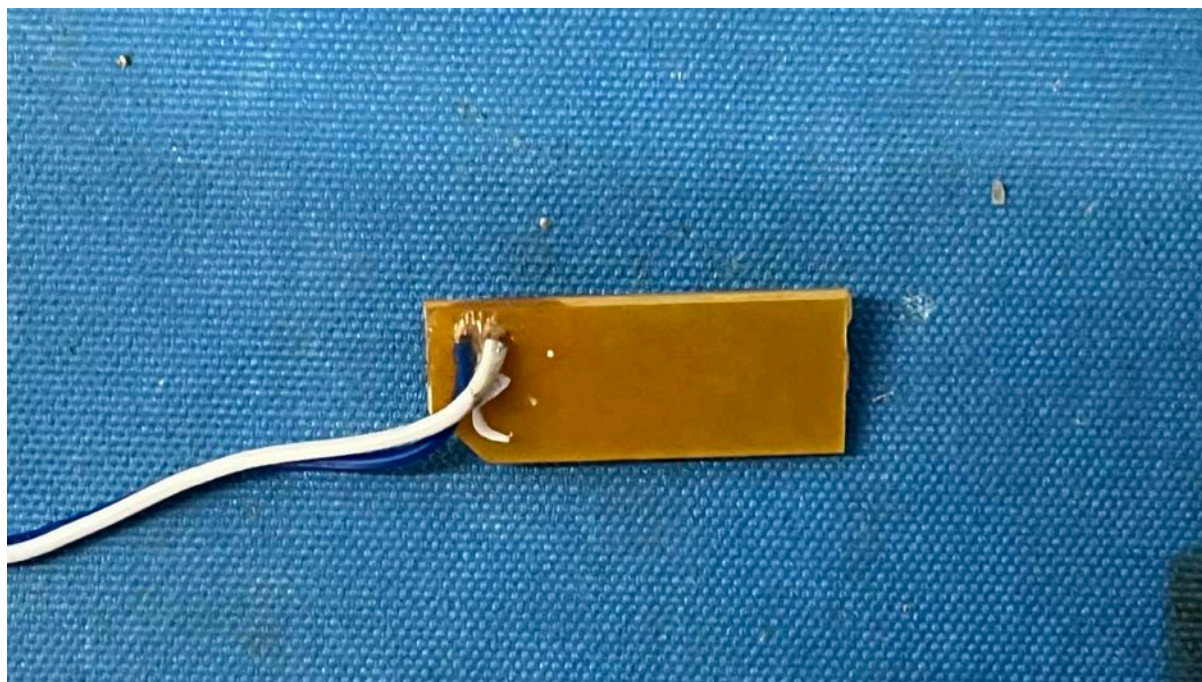

INTERTEK TESTING SERVICES

Equipment Photographs

(Internal)

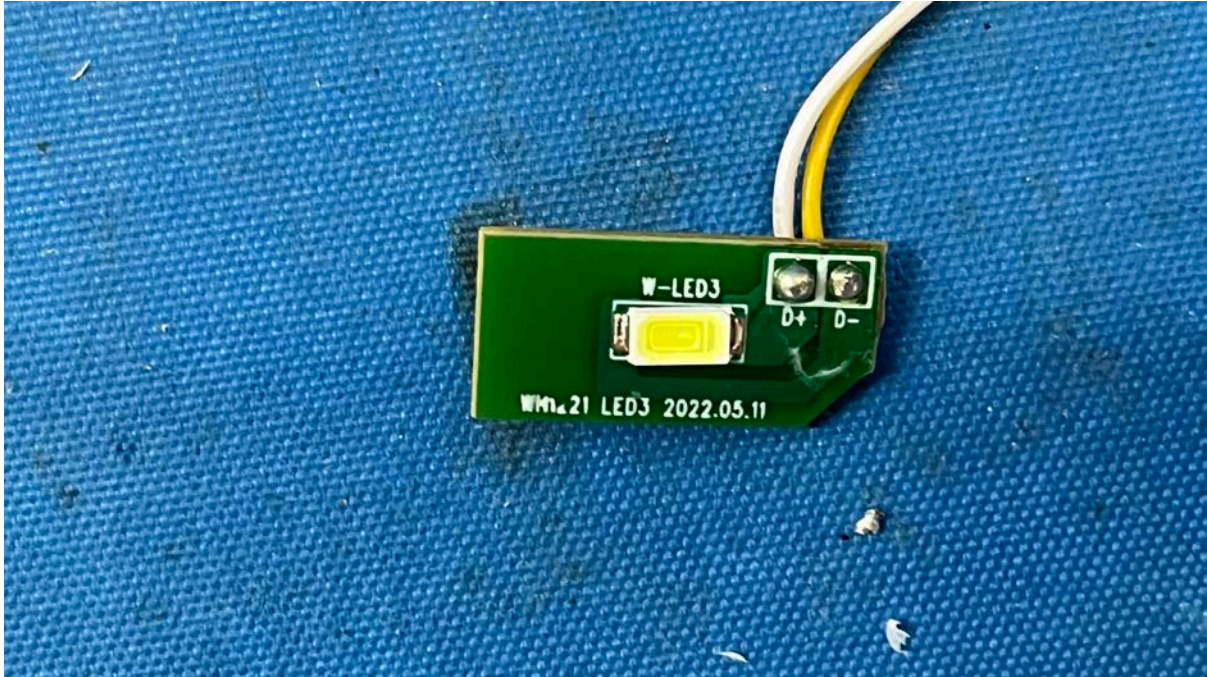

INTERTEK TESTING SERVICES

Equipment Photographs

(Internal)

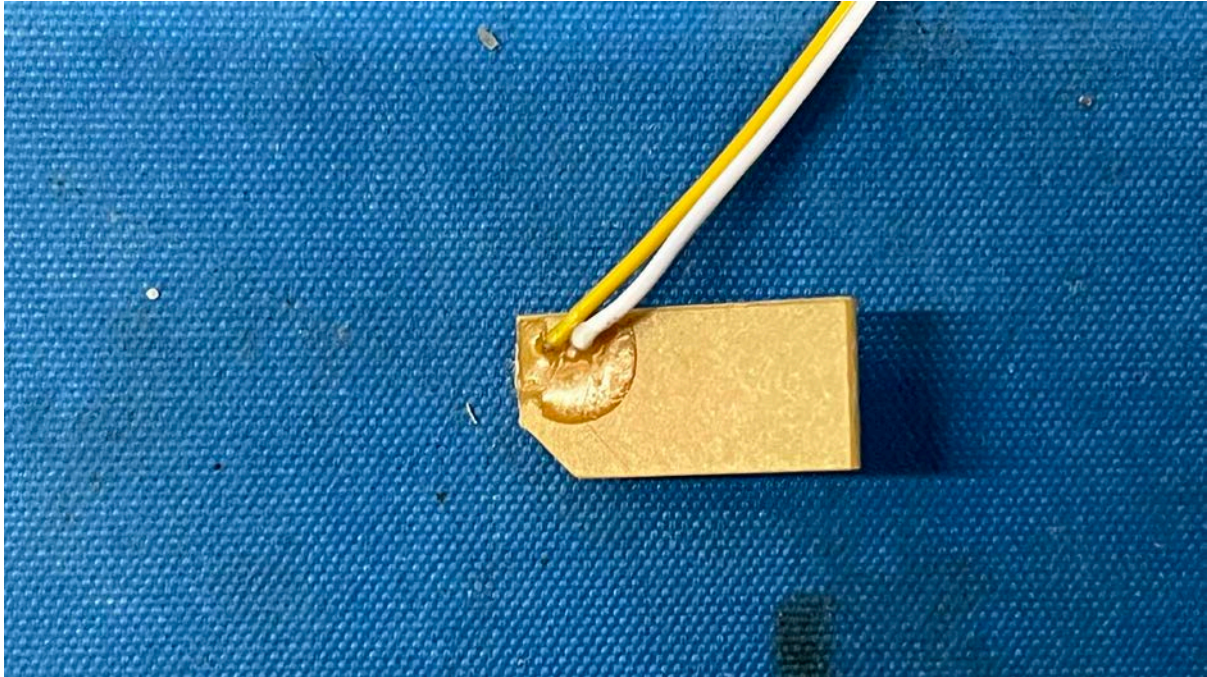

INTERTEK TESTING SERVICES

Equipment Photographs

(Internal)

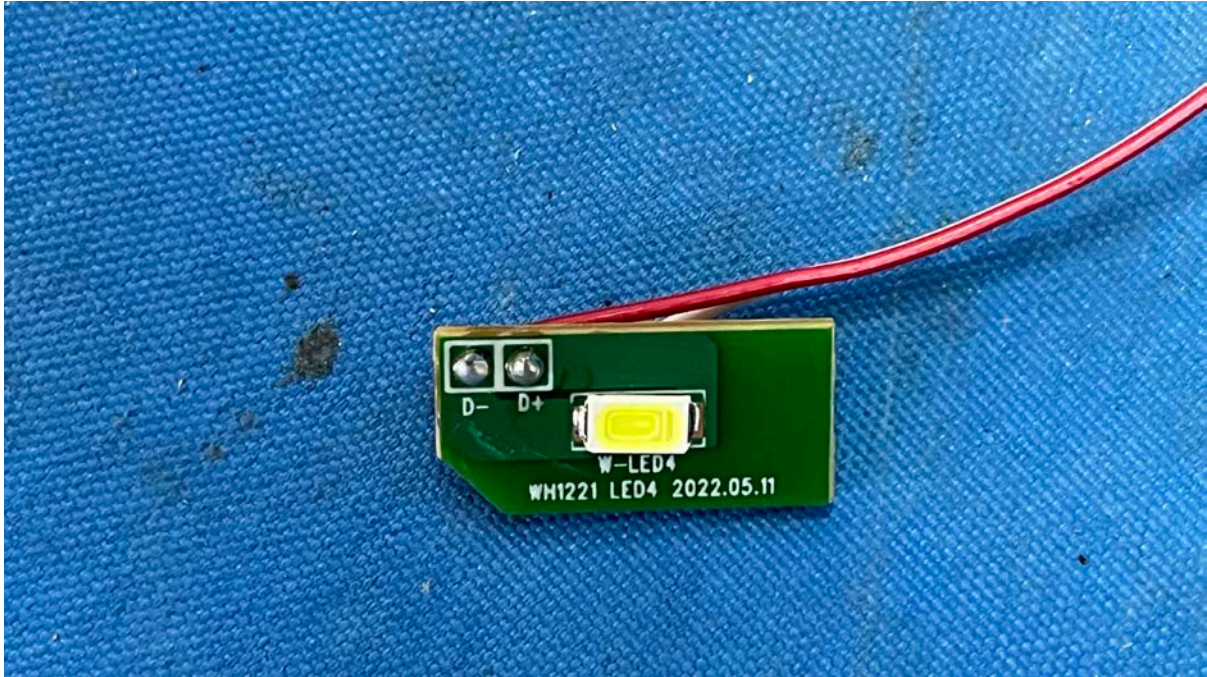

INTERTEK TESTING SERVICES

Equipment Photographs

(Internal)

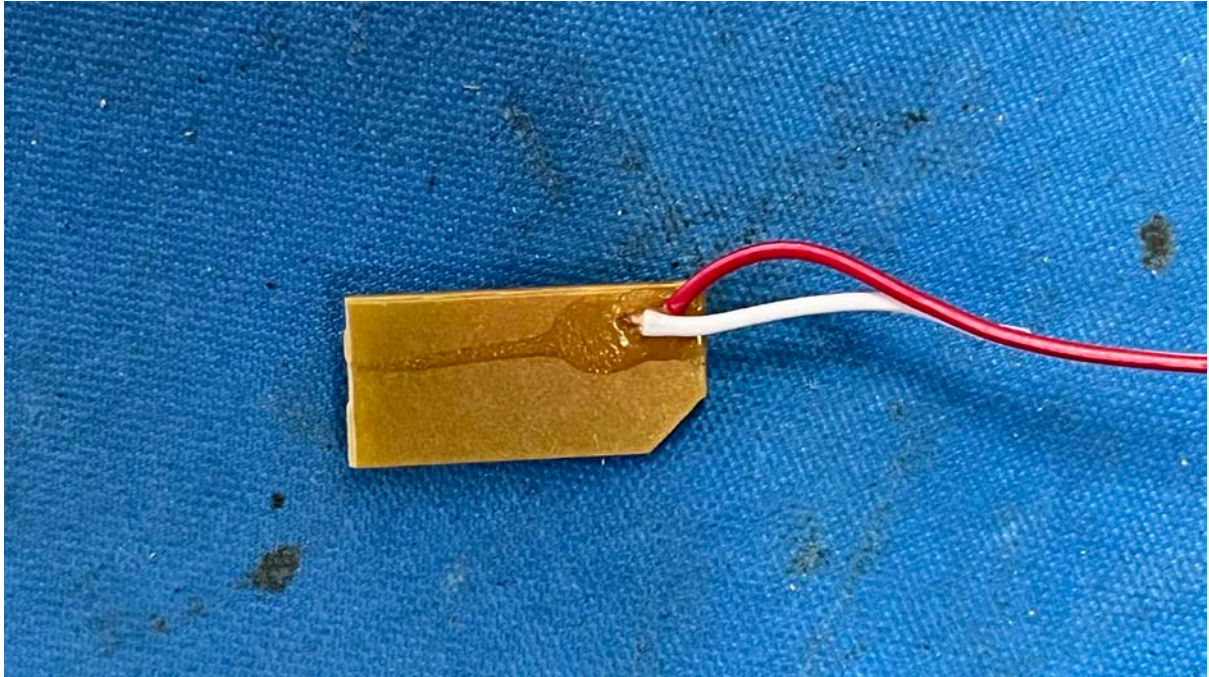

INTERTEK TESTING SERVICES

Equipment Photographs

(Internal)



INTERTEK TESTING SERVICES

Equipment Photographs

(Internal)

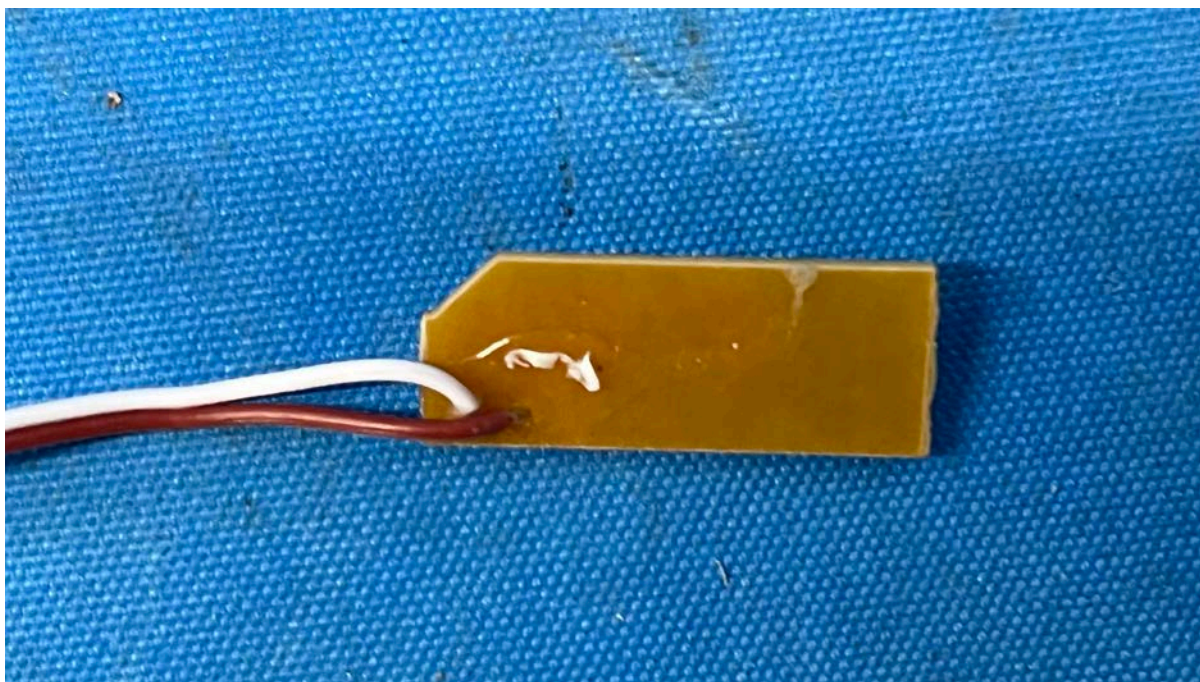

INTERTEK TESTING SERVICES

Equipment Photographs

(Internal)

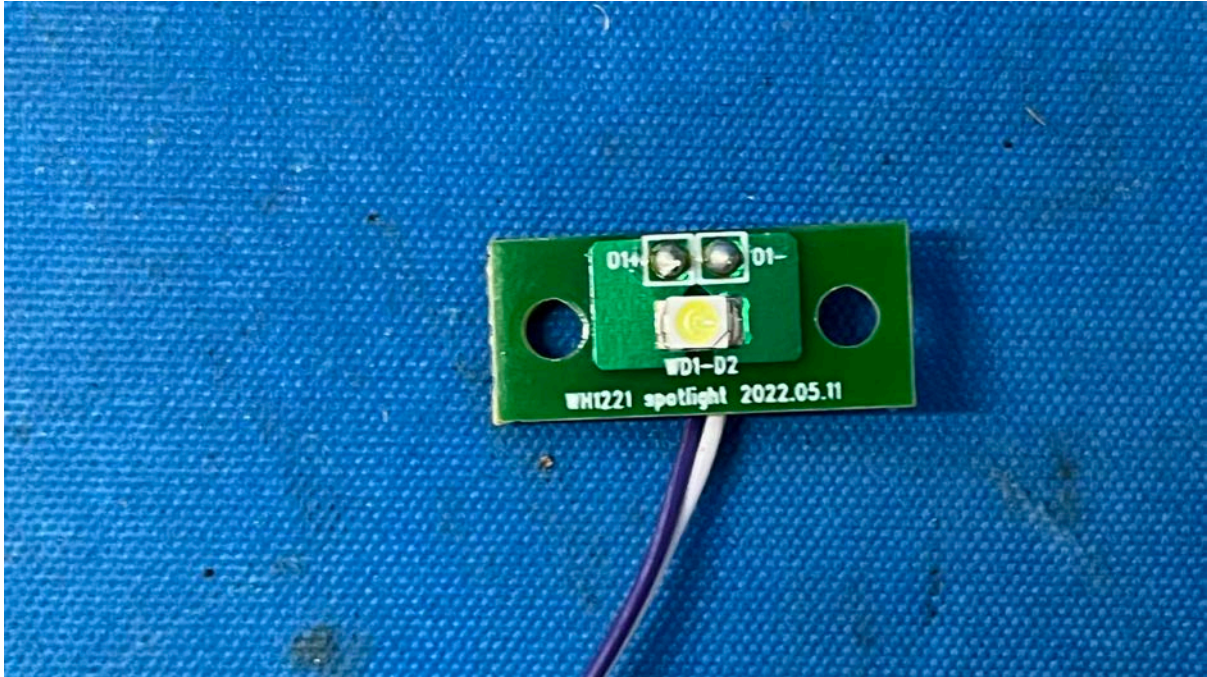

INTERTEK TESTING SERVICES

Equipment Photographs

(Internal)

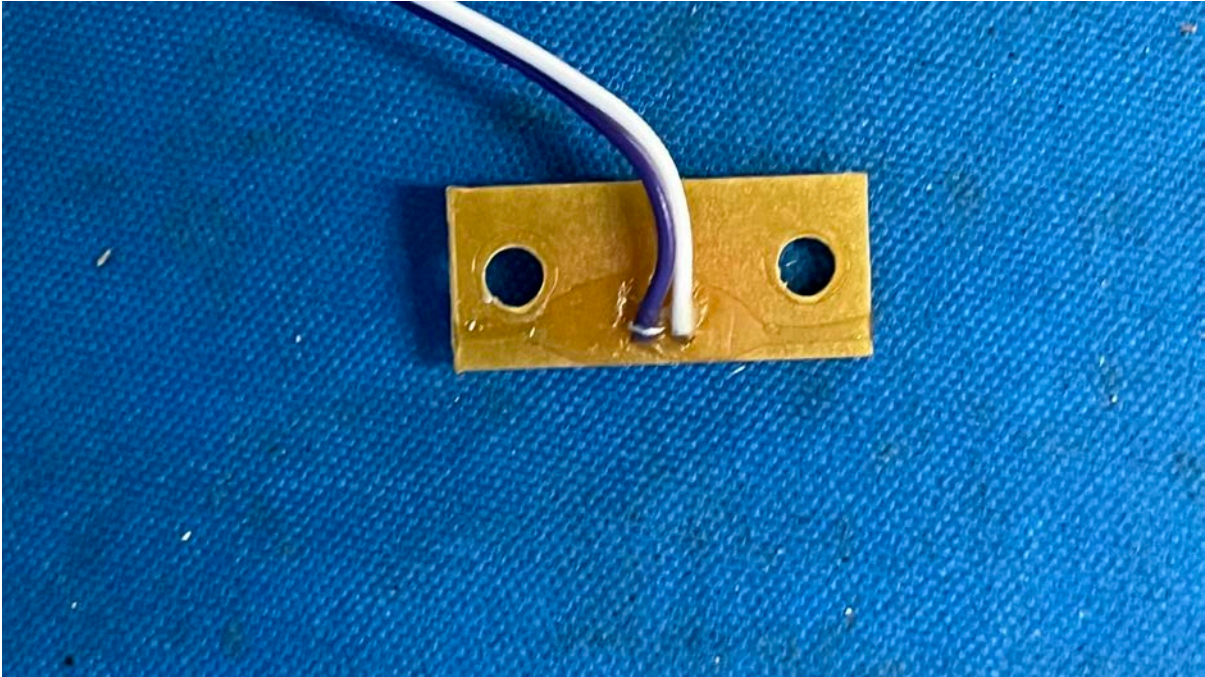

INTERTEK TESTING SERVICES

Equipment Photographs

(Internal)

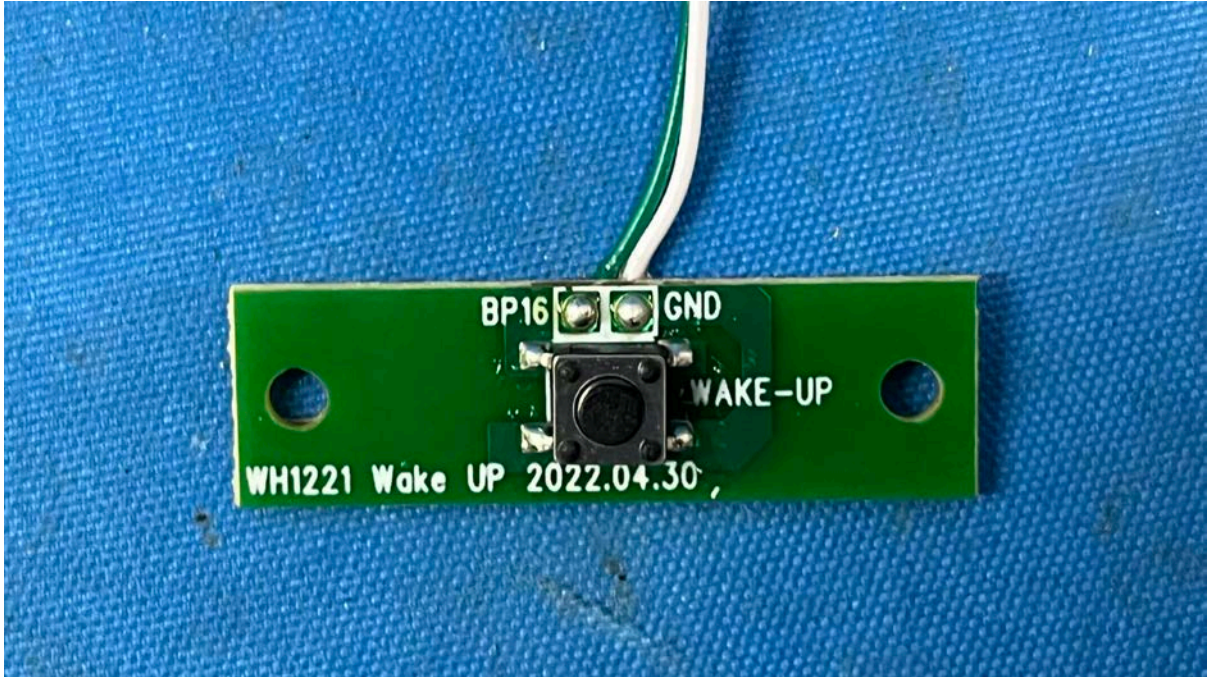

INTERTEK TESTING SERVICES

Equipment Photographs

(Internal)

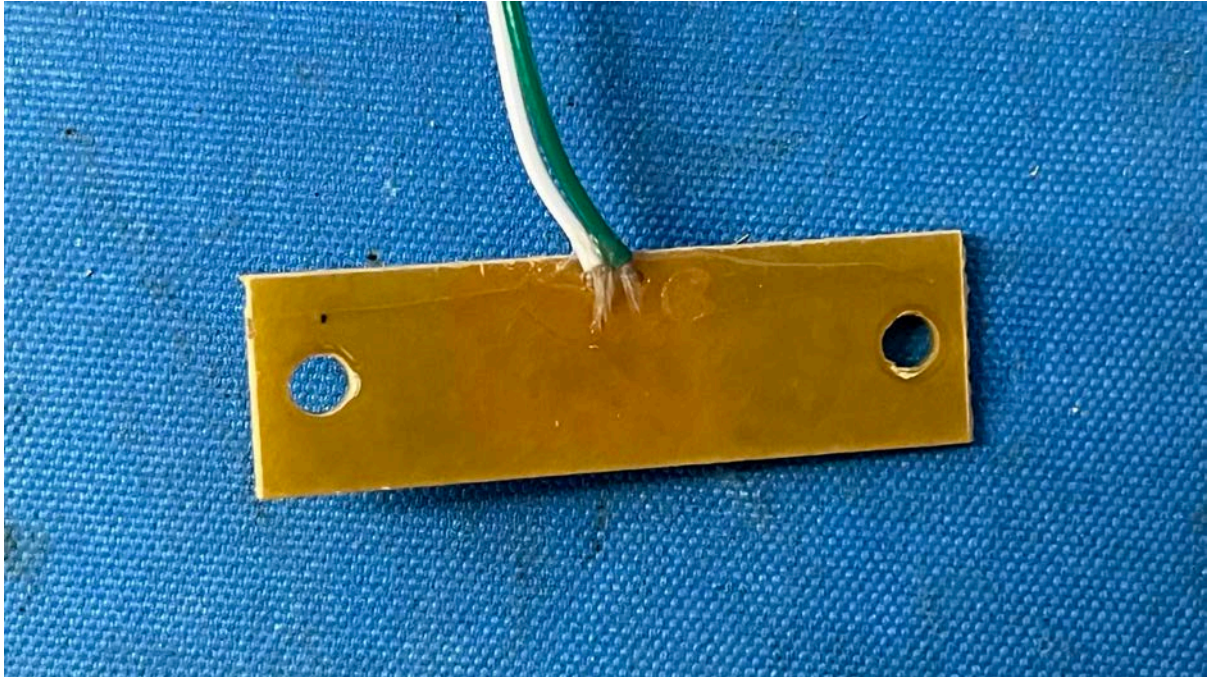

INTERTEK TESTING SERVICES

Equipment Photographs

(Internal)

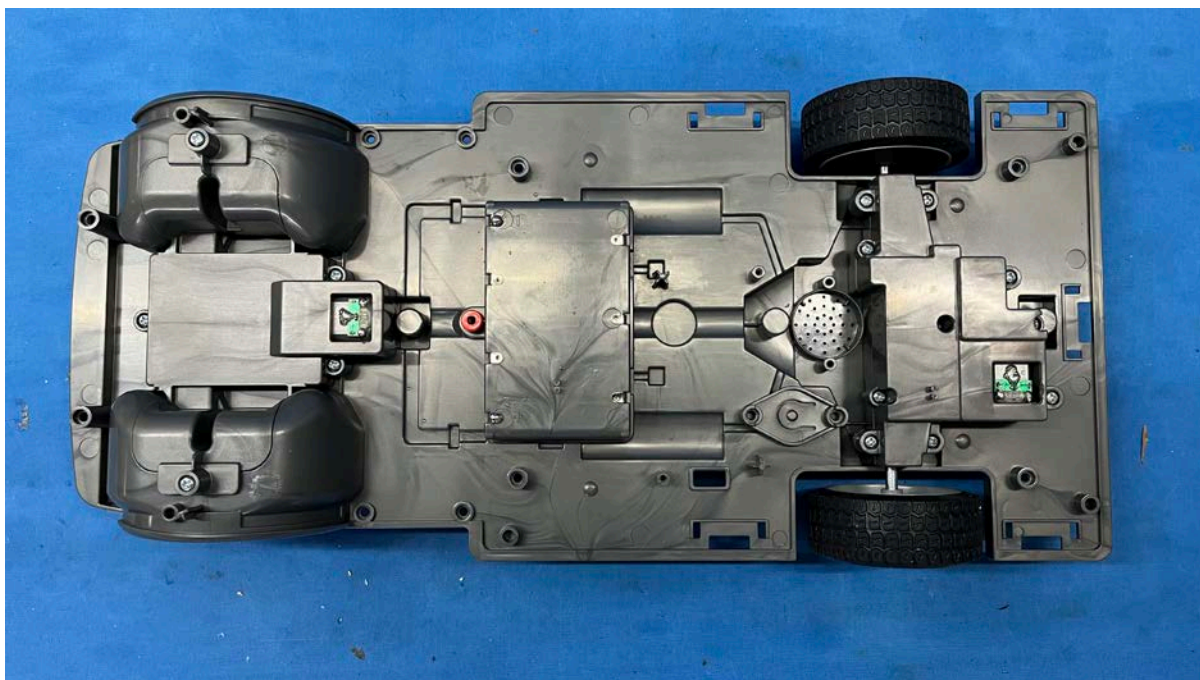

INTERTEK TESTING SERVICES

Equipment Photographs

(Internal)

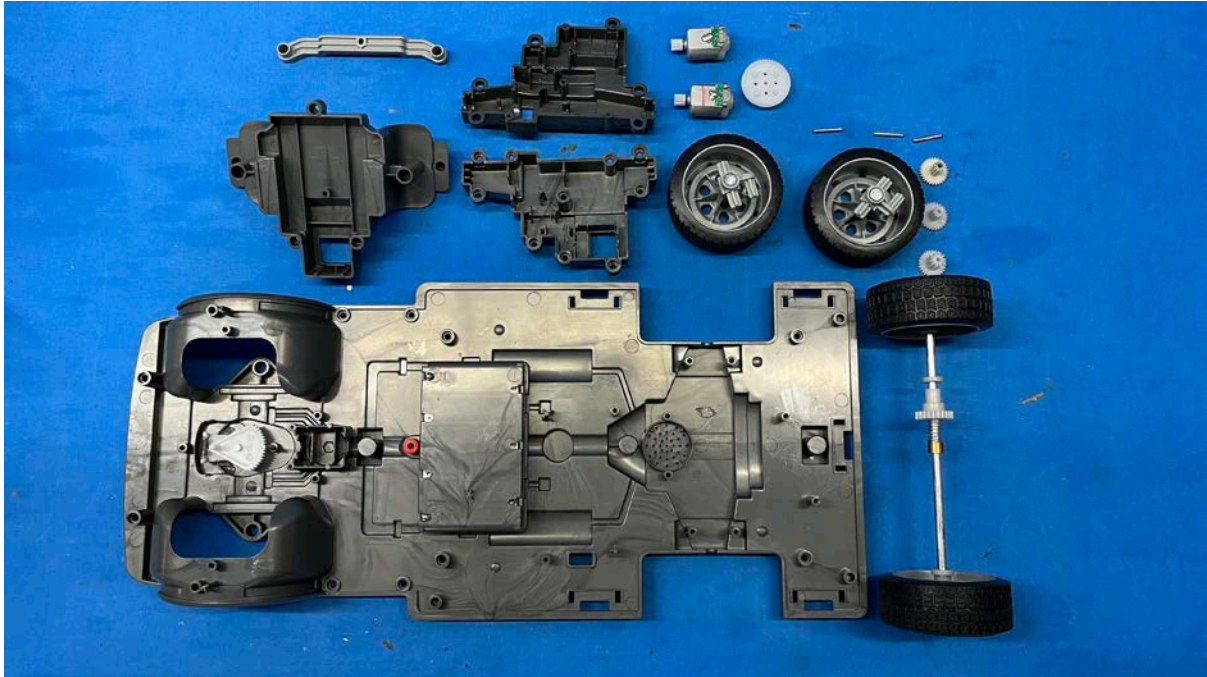

INTERTEK TESTING SERVICES

Equipment Photographs

(Internal)

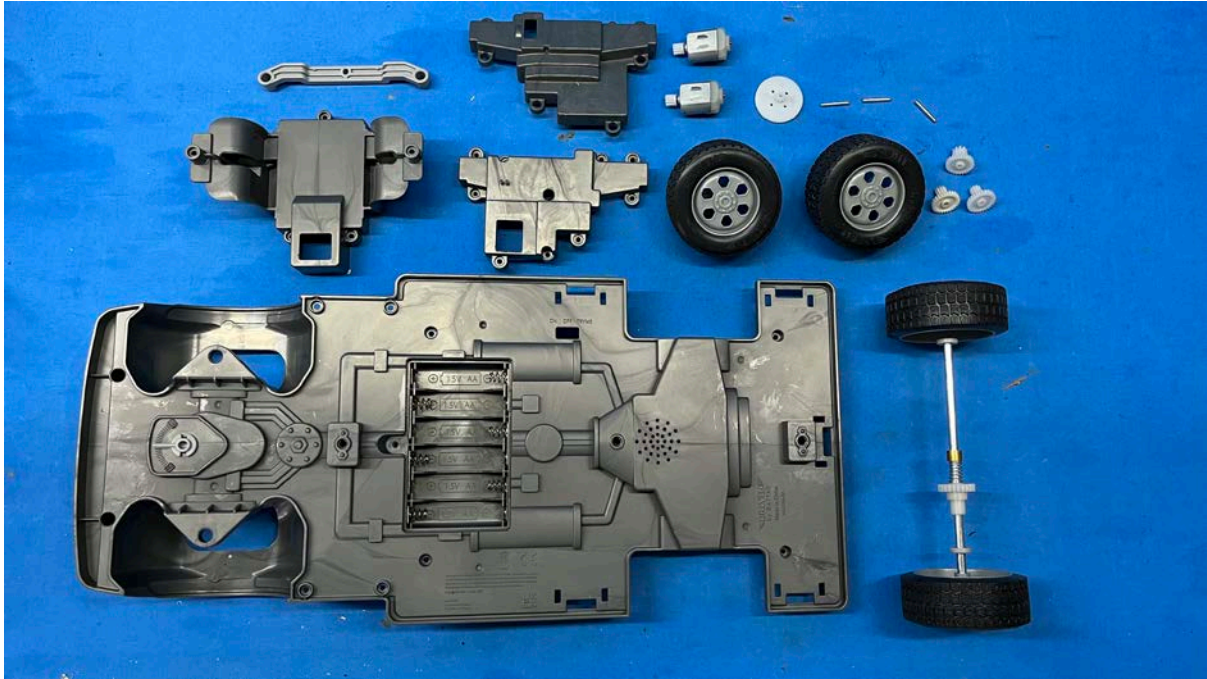

INTERTEK TESTING SERVICES

Equipment Photographs

(Internal)

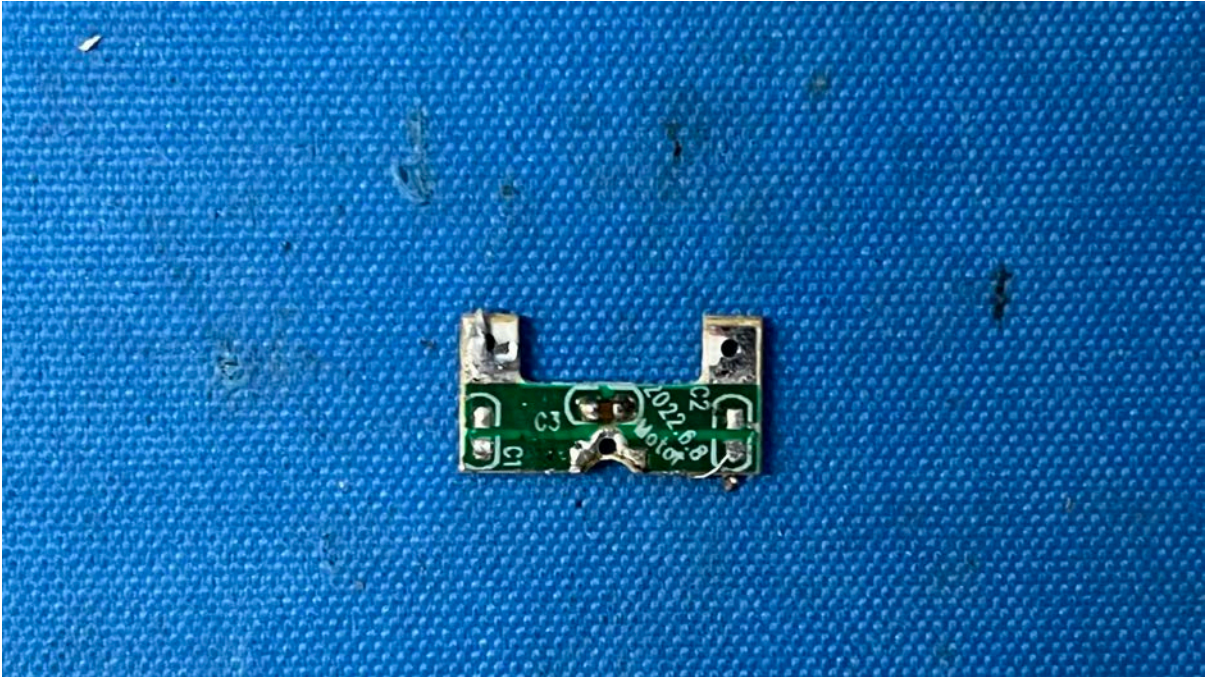

INTERTEK TESTING SERVICES

Equipment Photographs

(Internal)



INTERTEK TESTING SERVICES

Equipment Photographs

(Internal)



INTERTEK TESTING SERVICES

Equipment Photographs

(Internal)

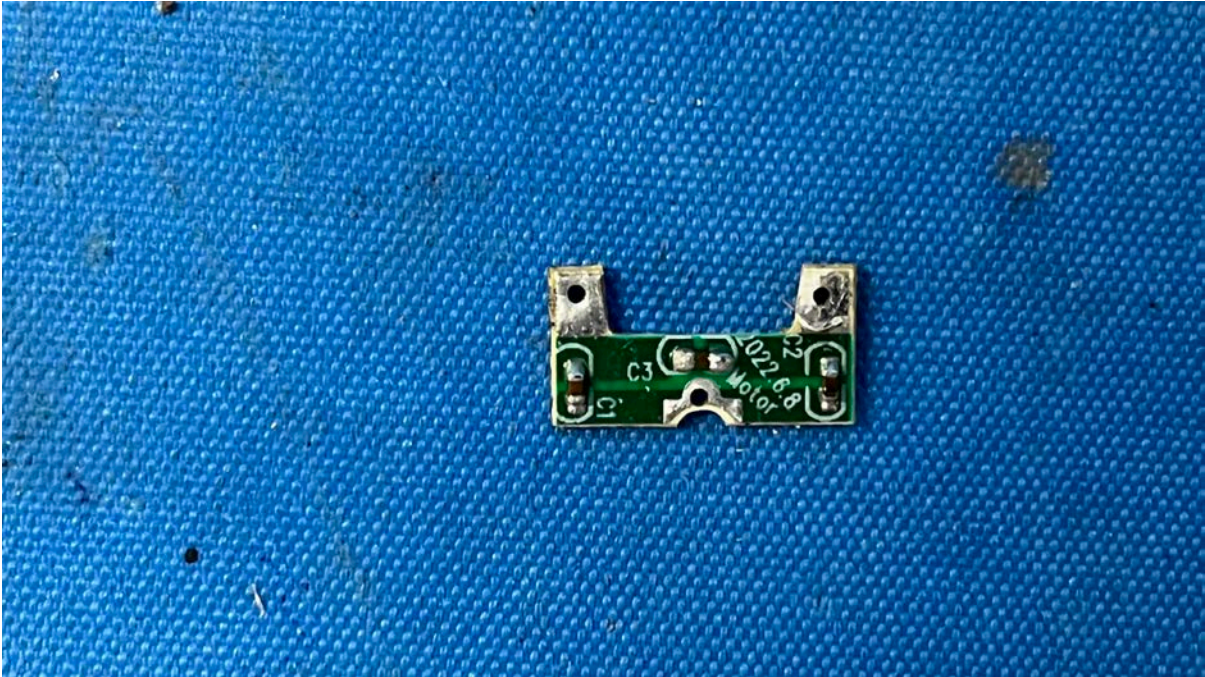

INTERTEK TESTING SERVICES

Equipment Photographs

(Internal)



INTERTEK TESTING SERVICES

Equipment Photographs

(Internal)



INTERTEK TESTING SERVICES

Equipment Photographs

(Internal)



INTERTEK TESTING SERVICES

Equipment Photographs

(Internal)

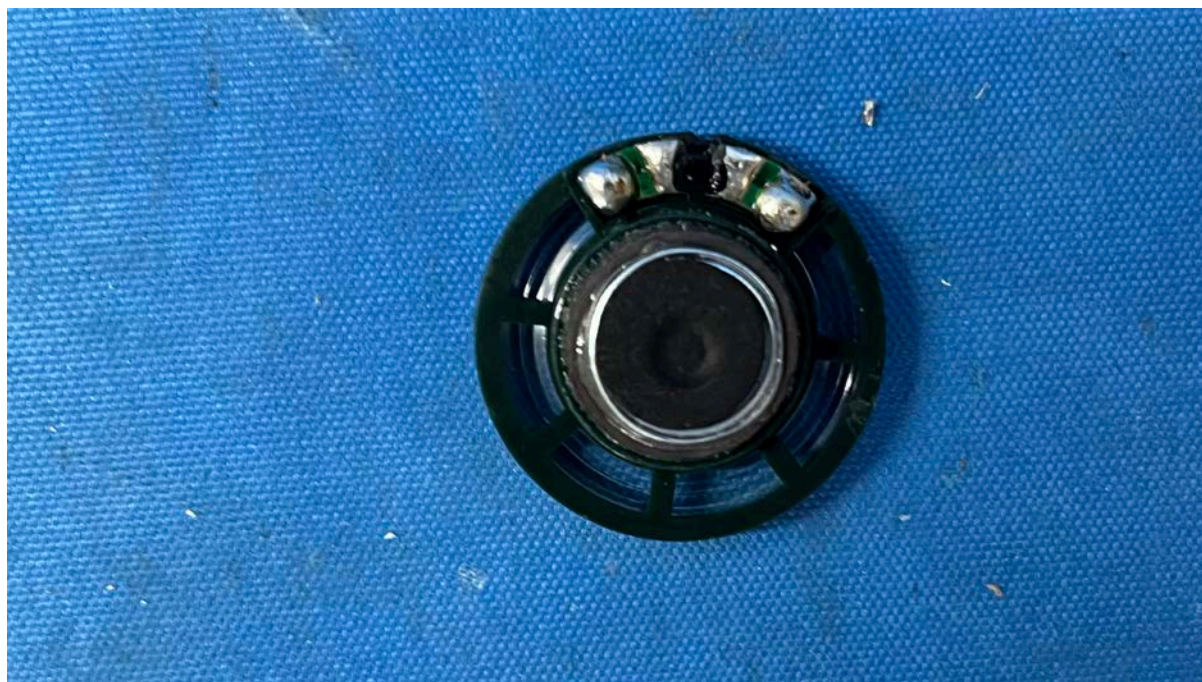

INTERTEK TESTING SERVICES

Equipment Photographs

(Internal)

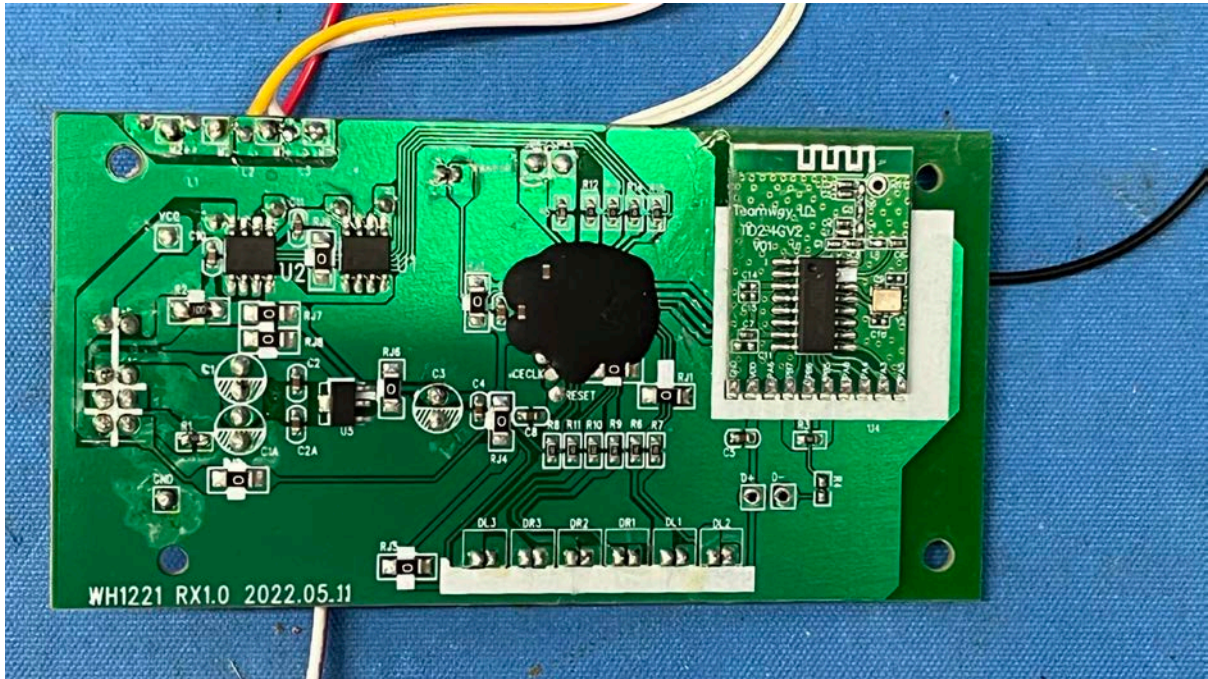

INTERTEK TESTING SERVICES

Equipment Photographs

(Internal)

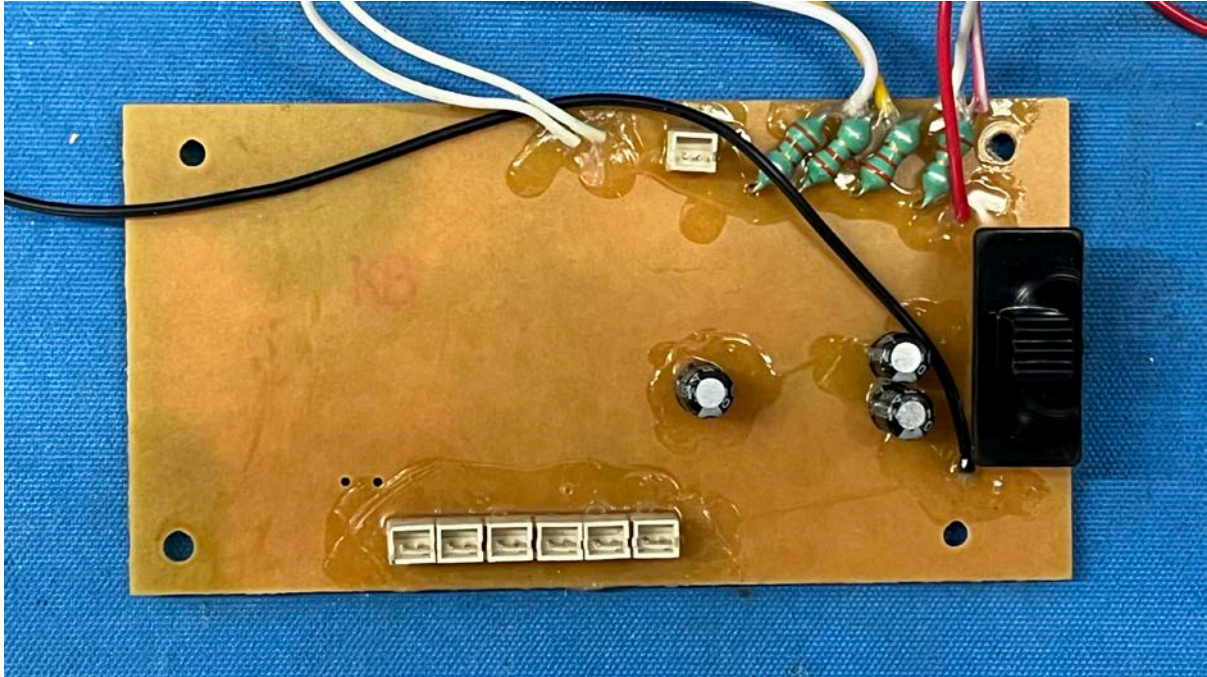

INTERTEK TESTING SERVICES

Equipment Photographs

(Internal)



INTERTEK TESTING SERVICES

Equipment Photographs

(Internal)

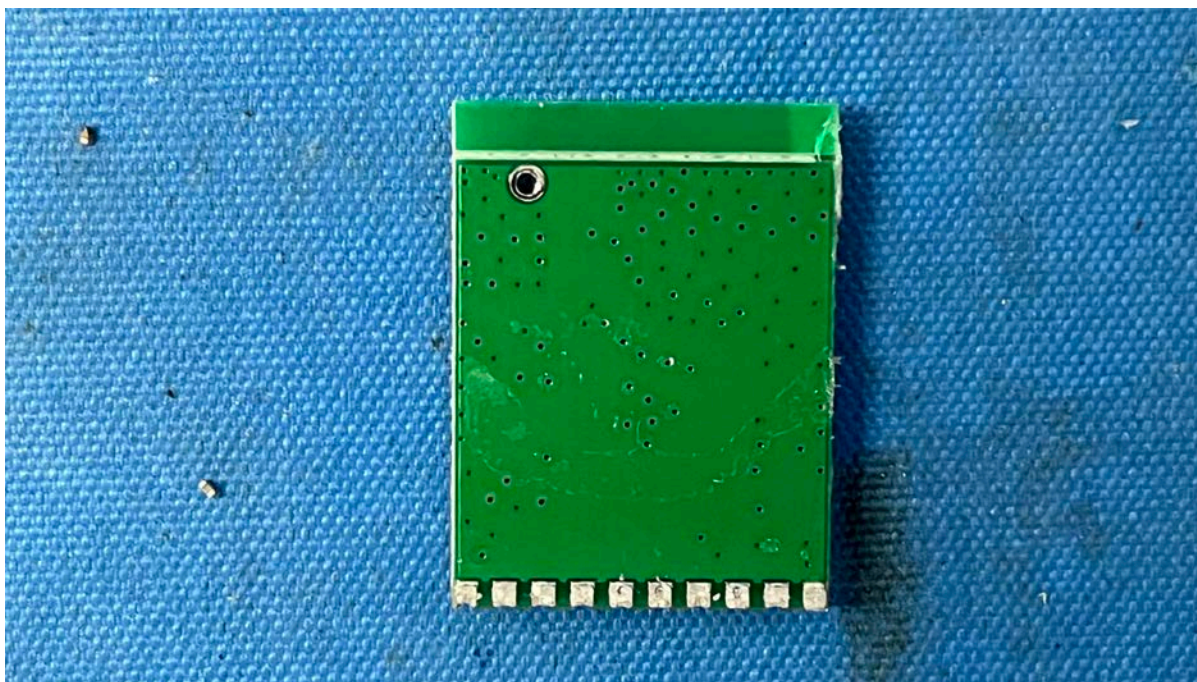

INTERTEK TESTING SERVICES

Equipment Photographs

(Internal)

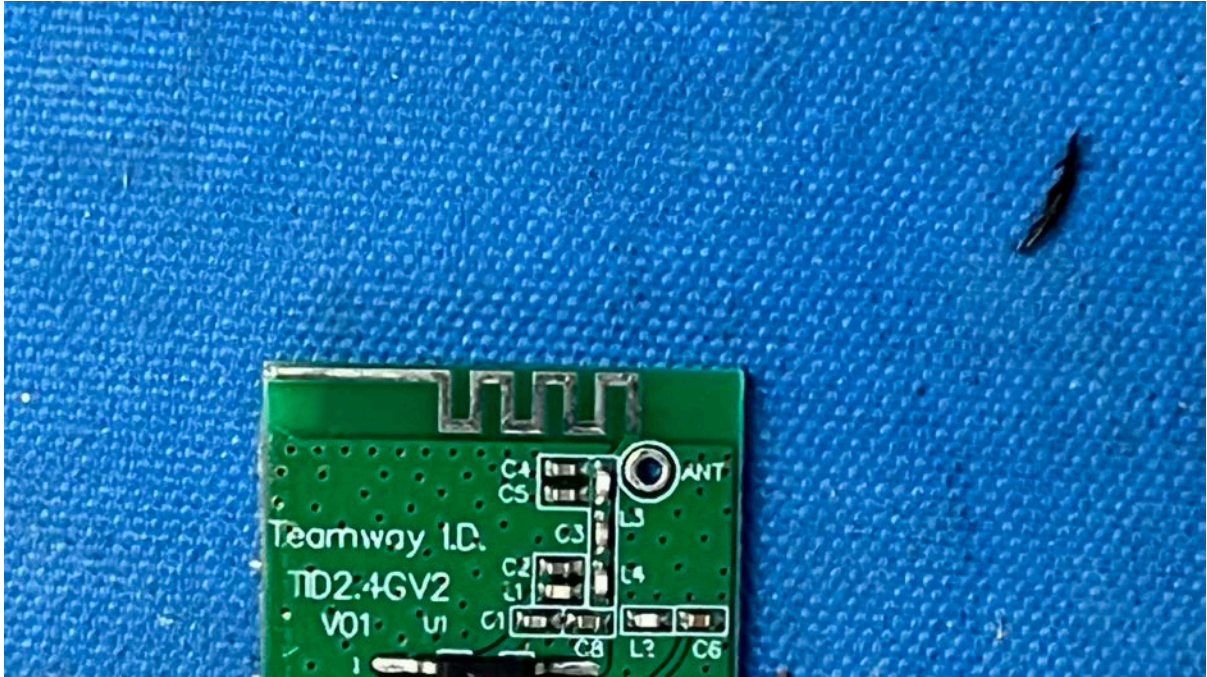

INTERTEK TESTING SERVICES

Equipment Photographs

(Internal)

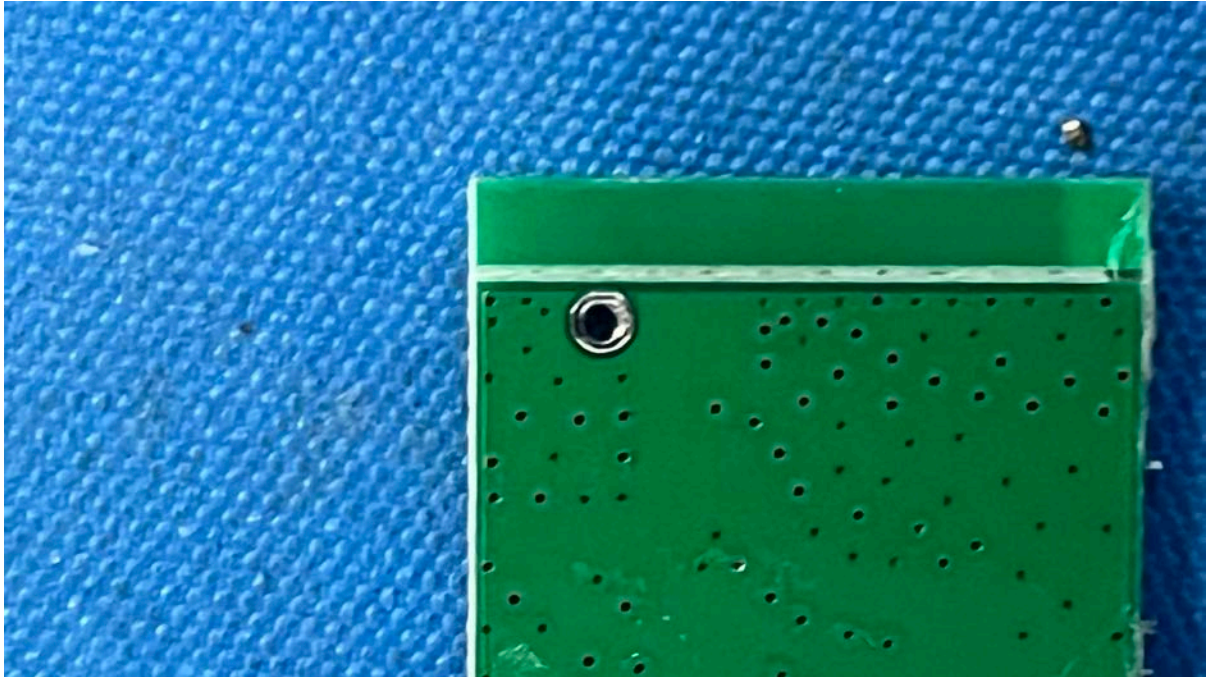

INTERTEK TESTING SERVICES

Equipment Photographs

(Internal)

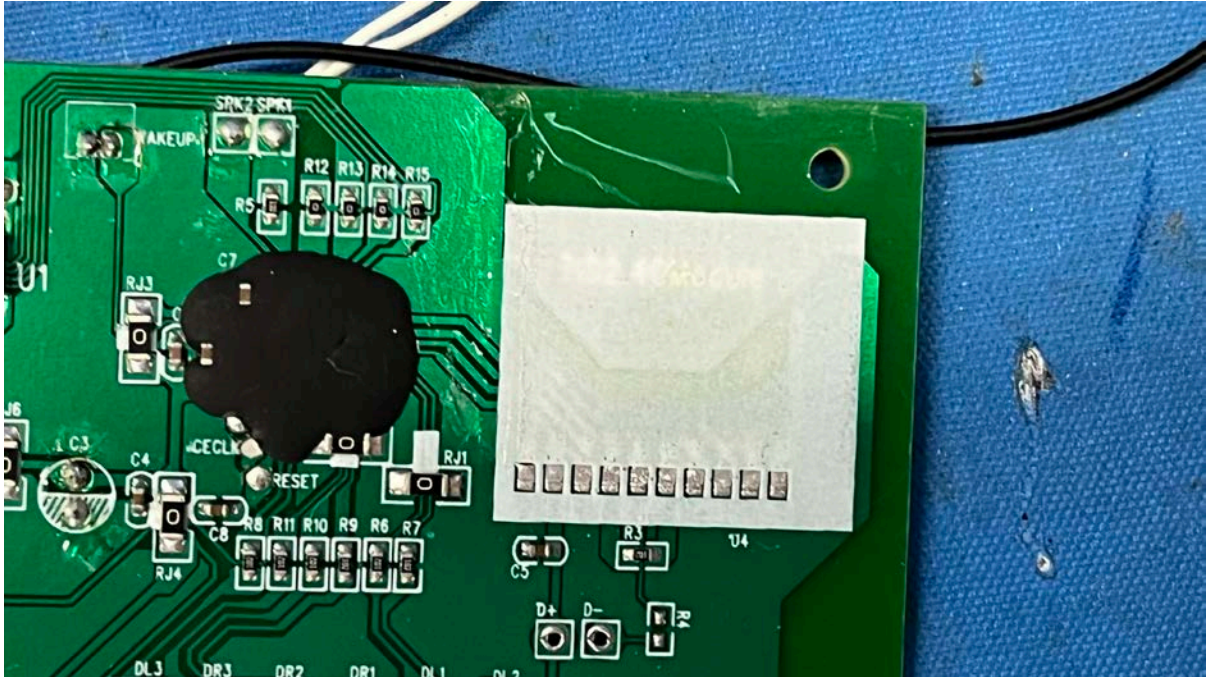

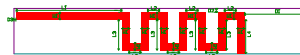

L1	7MM
L2	0.77MM
L3	2MM
L4	2.2MM
D1	4.2MM
D2	0.25MM
D3	0.16MM
W1	0.5MM

Table 1: Antenna Dimensions