

FCC TEST REPORT

REPORT NO. : RF931007L08

MODEL NO. : NPort W2004

RECEIVED : Oct. 05, 2004

TESTED : Nov. 08 ~ Nov. 13, 2004

APPLICANT : Moxa Technologies Co., Ltd.

ADDRESS : 4F, No.135, Lane 235, Pao-Chiao Rd., Shing Tien
City, Taipei, Taiwan R.O.C.

ISSUED BY : Advance Data Technology Corporation

LAB ADDRESS : No. 47, 14th Ling, Chia Pau Tsuen, Lin Kou Hsiang
244, Taipei Hsien, Taiwan, R.O.C.

TEST LOCATION : No. 19, Hwa Ya 2nd Rd., Wen Hwa Tsuen, Kwei
Shan Hsiang, Taoyuan Hsien 333, Taiwan, R.O.C.

This test report consists of 67 pages in total. It may be duplicated completely for legal use with the approval of the applicant. It should not be reproduced except in full, without the written approval of our laboratory. The client should not use it to claim product endorsement by CNLA, A2LA or any government agencies. The test results in the report only apply to the tested sample.





Table of Contents

1	CERTIFICATION	4
2	SUMMARY OF TEST RESULTS	5
2.1	GENERAL DESCRIPTION OF EUT	5
3	GENERAL INFORMATION.....	6
3.1	GENERAL DESCRIPTION OF EUT	6
3.2	DESCRIPTION OF TEST MODES.....	7
3.3	GENERAL DESCRIPTION OF APPLIED STANDARDS	7
3.4	DESCRIPTION OF SUPPORT UNITS	8
3.5	CONFIGURATION OF SYSTEM UNDER TEST	8
4	TEST TYPES AND RESULTS	9
4.1	CONDUCTED EMISSION MEASUREMENT	9
4.1.1	LIMITS OF CONDUCTED EMISSION MEASUREMENT.....	9
4.1.2	TEST INSTRUMENTS.....	9
4.1.3	TEST PROCEDURES	10
4.1.4	DEVIATION FROM TEST STANDARD	10
4.1.5	TEST SETUP.....	11
4.1.6	EUT OPERATING CONDITIONS	11
4.1.7	TEST RESULTS	12
4.2	RADIATED EMISSION MEASUREMENT	18
4.2.1	LIMITS OF RADIATED EMISSION MEASUREMENT.....	18
4.2.2	TEST INSTRUMENTS.....	19
4.2.3	TEST PROCEDURES	20
4.2.4	DEVIATION FROM TEST STANDARD	20
4.2.5	TEST SETUP.....	21
4.2.6	EUT OPERATING CONDITIONS	21
4.2.7	TEST RESULTS	22
4.2.8	TEST RESULTS (A)	24
4.2.9	TEST RESULTS (B)	27
4.3	6dB BANDWIDTH MEASUREMENT.....	30
4.3.1	LIMITS OF 6dB BANDWIDTH MEASUREMENT	30
4.3.2	TEST INSTRUMENTS.....	30
4.3.3	TEST PROCEDURE.....	31
4.3.4	DEVIATION FROM TEST STANDARD	31
4.3.5	TEST SETUP.....	31
4.3.6	EUT OPERATING CONDITIONS	31



4.3.7	TEST RESULTS (A)	32
4.3.8	TEST RESULTS (B)	36
4.4	MAXIMUM PEAK OUTPUT POWER	40
4.4.1	LIMITS OF MAXIMUM PEAK OUTPUT POWER MEASUREMENT	40
4.4.2	TEST INSTRUMENTS.....	40
4.4.3	TEST PROCEDURES	40
4.4.4	DEVIATION FROM TEST STANDARD	41
4.4.5	TEST SETUP	41
4.4.6	EUT OPERATING CONDITIONS	41
4.4.7	TEST RESULTS (A)	42
4.4.8	TEST RESULTS (B)	42
4.5	POWER SPECTRAL DENSITY MEASUREMENT	43
4.5.1	LIMITS OF POWER SPECTRAL DENSITY MEASUREMENT	43
4.5.2	TEST INSTRUMENTS.....	43
4.5.3	TEST PROCEDURE.....	43
4.5.4	DEVIATION FROM TEST STANDARD	43
4.5.5	TEST SETUP	44
4.5.6	EUT OPERATING CONDITIONS	44
4.5.7	TEST RESULTS (A)	45
4.5.8	TEST RESULTS (B)	49
4.6	BAND EDGES MEASUREMENT	53
4.6.1	LIMITS OF BAND EDGES MEASUREMENT.....	53
4.6.2	TEST INSTRUMENTS.....	53
4.6.3	TEST PROCEDURE.....	53
4.6.4	DEVIATION FROM TEST STANDARD	53
4.6.5	EUT OPERATING CONDITION	53
4.6.6	TEST RESULTS	54
4.6.7	TEST RESULTS(A)	54
4.6.8	TEST RESULTS(B)	59
4.7	ANTENNA REQUIREMENT	64
4.7.1	STANDARD APPLICABLE	64
4.7.2	ANTENNA CONNECTED CONSTRUCTION	64
5	PHOTOGRAPHS OF THE TEST CONFIGURATION.....	65
6	INFORMATION ON THE TESTING LABORATORIES	67



1 CERTIFICATION

PRODUCT : Wireless Serial Device Server
BRAND NAME : MOXA
MODEL NO. : NPort W2004
APPLICANT : Moxa Technologies Co., Ltd.
TESTED : Nov. 08 ~ Nov. 13, 2004
TEST SAMPLE : ENGINEERING SAMPLE
STANDARDS : FCC Part 15, Subpart C (Section 15.247)
ANSI C63.4:2003

The above equipment has been tested by **Advance Data Technology Corporation**, and found compliance with the requirement of the above standards. The test record, data evaluation & Equipment Under Test (EUT) configurations represented herein are true and accurate accounts of the measurements of the sample's EMC characteristics under the conditions specified in this report.

PREPARED BY : Suntee Liu, **DATE:** Nov. 11, 2004
(Suntee Liu)

TECHNICAL
ACCEPTANCE : Gary Chang, **DATE:** Nov. 11, 2004
Responsible for RF (Gary Chang)

APPROVED BY : Cody Chang, **DATE:** Nov. 11, 2004
(Cody Chang, Deputy Manager)

2 SUMMARY OF TEST RESULTS

The EUT has been tested according to the following specifications:

APPLIED STANDARD: FCC Part 15, Subpart C			
Standard Section	Test Type and Limit	Result	REMARK
15.207	AC Power Conducted Emission	PASS	Meet the requirement of limit. Minimum passing margin is -7.02 dB at 21.395 MHz
15.247(a)(2)	Spectrum Bandwidth of a Direct Sequence Spread Spectrum System Limit: min. 500kHz	PASS	Meet the requirement of limit.
15.247(b)	Maximum Peak Output Power Limit: max. 30dBm	PASS	Meet the requirement of limit.
15.247(d)	Transmitter Radiated Emissions Limit: Table 15.209	PASS	Meet the requirement of limit. Minimum passing margin is -1.61 dB at 2483.50 MHz
15.247(e)	Power Spectral Density Limit: max. 8dBm	PASS	Meet the requirement of limit.
15.247(d)	Band Edge Measurement Limit: 20 dB less than the peak value of fundamental frequency	PASS	Meet the requirement of limit.

2.1 GENERAL DESCRIPTION OF EUT

Where relevant, the following measurement uncertainty levels have been estimated for tests performed on the EUT as specified in CISPR 16-4:

MEASUREMENT	FREQUENCY	UNCERTAINTY
Conducted emissions	9kHz~30MHz	2.44 dB
Radiated emissions	30MHz ~ 200MHz	3.63 dB
	200MHz ~1000MHz	3.65 dB
	1GHz ~ 18GHz	2.20 dB
	18GHz ~ 40GHz	1.88 dB



3 GENERAL INFORMATION

3.1 GENERAL DESCRIPTION OF EUT

PRODUCT	Wireless Serial Device Server
MODEL NO.	NPort W2004
POWER SUPPLY	12Vdc from adapter
MODULATION TYPE	BPSK, QPSK, CCK, 16QAM, 64QAM
RADIO TECHNOLOGY	DSSS, OFDM
TRANSFER RATE	802.11b: 11/5.5/2/1 Mbps 802.11g: 54/48/36/24/18/12/9/6 Mbps
FREQUENCY RANGE	2412MHz ~ 2462MHz
NUMBER OF CHANNEL	11
OUTPUT POWER	64.42 mW
ANTENNA TYPE	Dipole antenna with 2.14 dBi gain
DATA CABLE	NA
I/O PORTS	RJ45

NOTE:

1. The EUT, operates in the 2.4GHz frequency range, lets you connect IEEE 802.11g or IEEE 802.11b devices to the network. With its high-speed data transmissions of up to 54Mbps.
2. The EUT was powered by the following adapter.

Brand	BALANCE ELECTRONIC CO.,LTD.
Model	GPSA-1200125
Input	100-240Vac, 50-60MHz, 0.5A
Output	12Vdc, 1.2A
Power Line	1.8M non-shielded cable without core(AC 2 Pin)

3. The above EUT information was declared by manufacturer and for more detailed features description, please refer to the manufacturer's specifications or User's Manual.



3.2 DESCRIPTION OF TEST MODES

11 channels are provided to this EUT.

Channel	Frequency	Channel	Frequency
1	2412 MHz	7	2442 MHz
2	2417 MHz	8	2447 MHz
3	2422 MHz	9	2452 MHz
4	2427 MHz	10	2457 MHz
5	2432 MHz	11	2462 MHz
6	2437 MHz		

NOTE:

1. Below 1GHz, the channel 1, 6, and 11 were pre-tested in chamber. The channel 11, the worst case, was chosen for final test.
2. Above 1GHz, the channel 1, 6, and 11 were tested individually.
3. From our experience and technical viewpoint, we have chosen data rates 11Mbps for CCK technique and 6Mbps for OFDM technique, as the worst cases for the test among other data rates.
4. Two test results were presented in the following sections. The test result A was for CCK technique and the test result B was for OFDM technique.

3.3 GENERAL DESCRIPTION OF APPLIED STANDARDS

The EUT is a Wireless Serial Device Server. According to the specifications of the manufacturer, it must comply with the requirements of the following standards:

FCC Part 15, Subpart C (15.247)

ANSI C63.4:2003

All test items have been performed and recorded as per the above standards.

NOTE: The EUT is also considered as a kind of computer peripheral, because the connection to computer is necessary for typical use. It has been verified to comply with the requirements of FCC Part 15, Subpart B, Class A. The test report has been issued separately.



3.4 DESCRIPTION OF SUPPORT UNITS

The EUT has been tested as an independent unit together with other necessary accessories or support units. The following support units or accessories were used to form a representative test configuration during the tests.

NO.	PRODUCT	BRAND	MODEL NO.	SERIAL NO.	FCC ID
1	NOTEBOOK COMPUTER	DELL	PP05L	9954115984	E2K24CLNS
2	PRINTER	EPSON	LQ-300+	DCGY054147	FCC DoC Approved
3	MODEM	ACEEX	1414V/3	0401008269	IFAXDM1414

NO.	SIGNAL CABLE DESCRIPTION OF THE ABOVE SUPPORT UNITS
1	NA
2	1.2m shielded cable
3	1.2m shielded cable

NOTE:

1. All power cords of the above support units are non shielded (1.8m).

3.5 CONFIGURATION OF SYSTEM UNDER TEST

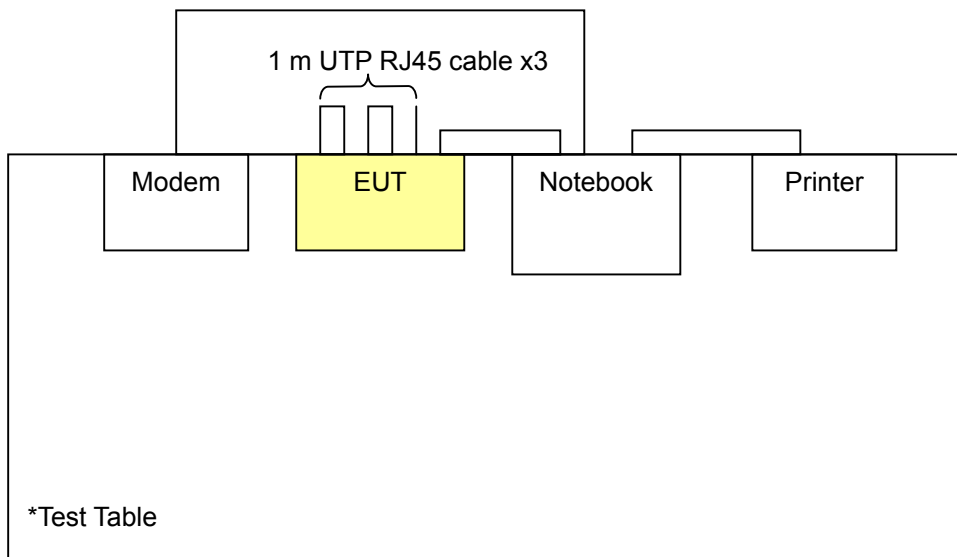



4 TEST TYPES AND RESULTS

4.1 CONDUCTED EMISSION MEASUREMENT

4.1.1 LIMITS OF CONDUCTED EMISSION MEASUREMENT

FREQUENCY OF EMISSION (MHz)	CONDUCTED LIMIT (dB μ V)	
	Quasi-peak	Average
0.15-0.5	66 to 56	56 to 46
0.5-5	56	46
5-30	60	50

- NOTE:**
1. The lower limit shall apply at the transition frequencies.
 2. The limit decreases in line with the logarithm of the frequency in the range of 0.15 to 0.50 MHz.
 3. All emanations from a class A/B digital device or system, including any network of conductors and apparatus connected thereto, shall not exceed the level of field strengths specified above.

4.1.2 TEST INSTRUMENTS

DESCRIPTION & MANUFACTURER	MODEL NO.	SERIAL NO.	CALIBRATED UNTIL
Test Receiver ROHDE & SCHWARZ	ESCS30	100291	Dec. 12, 2004
RF signal cable Woken	5D-FB	Cable-HYC01-01	Mar. 02, 2005
LISN ROHDE & SCHWARZ	ESH3-Z5	100312	Mar. 03, 2005
LISN ROHDE & SCHWARZ	ESH2-Z5	100104	Mar. 02, 2005
Software ADT	ADT_Cond_V3	NA	NA

- NOTE:**
1. The calibration interval of the above test instruments is 12 months and the calibrations are traceable to NML/ROC and NIST/USA.
 2. The test was performed in HwaYa Shielded Room 1.
 3. The VCCI Site Registration No. is C-2040.



4.1.3 TEST PROCEDURES

- a. The EUT was placed 0.4 meters from the conducting wall of the shielded room with EUT being connected to the power mains through a line impedance stabilization network (LISN). Other support units were connected to the power mains through another LISN. The two LISNs provide 50 ohm/ 50uH of coupling impedance for the measuring instrument.
- b. Both lines of the power mains connected to the EUT were checked for maximum conducted interference.
- c. The frequency range from 150 kHz to 30 MHz was searched. Emission levels (Limit -20dB) was not recorded.

4.1.4 DEVIATION FROM TEST STANDARD

No deviation

4.1.5 TEST SETUP

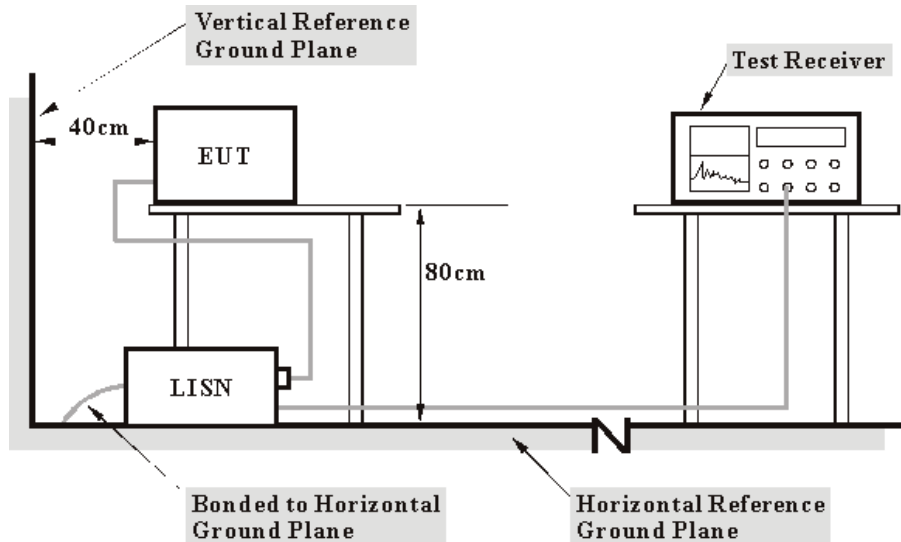

- Note:**
1. Support units were connected to second LISN.
 2. Both of LISNs (AMN) 80 cm from EUT and at the least 80 cm from other units and other metal planes support units.

For the actual test configuration, please refer to the related item – Photographs of the Test Configuration.

4.1.6 EUT OPERATING CONDITIONS

- a. Connected the EUT to the notebook.
- b. The notebook sent “H” messages to the modem.
- c. The notebook sent “H” messages to the printer and the printer printed them out.
- d. Prepared a router outside of testing area to act as a communication partner.



4.1.7 TEST RESULTS

EUT	Wireless Serial Device Server	MODEL	NPort W2004
CHANNEL	1	6dB BANDWIDTH	9 kHz
INPUT POWER (SYSTEM)	120 Vac, 60 Hz	PHASE	Line (L)
ENVIRONMENTAL CONDITIONS	24 deg. C, 64% RH, 991 hPa	TESTED BY	Gary Chang

No	Freq. [MHz]	Corr. Factor (dB)	Reading Value		Emission Level		Limit		Margin	
			[dB (uV)]		[dB (uV)]		[dB (uV)]		(dB)	
			Q.P.	AV.	Q.P.	AV.	Q.P.	AV.	Q.P.	AV.
1	0.201	0.12	43.70	-	43.82	-	63.58	53.58	-19.76	-
2	0.267	0.12	35.07	-	35.19	-	61.20	51.20	-26.01	-
3	1.344	0.15	34.47	-	34.62	-	56.00	46.00	-21.38	-
4	4.367	0.22	30.33	-	30.55	-	56.00	46.00	-25.45	-
5	21.201	1.05	47.69	-	48.74	-	60.00	50.00	-11.26	-
6	25.760	1.20	48.68	-	49.88	-	60.00	50.00	-10.12	-

- REMARKS:**
1. Q.P. and AV. are abbreviations of quasi-peak and average individually.
 2. "-": The Quasi-peak reading value also meets average limit and measurement with the average detector is unnecessary.
 3. The emission levels of other frequencies were very low against the limit.
 4. Margin value = Emission level - Limit value
 5. Correction factor = Insertion loss + Cable loss
 6. Emission Level = Correction Factor + Reading Value.

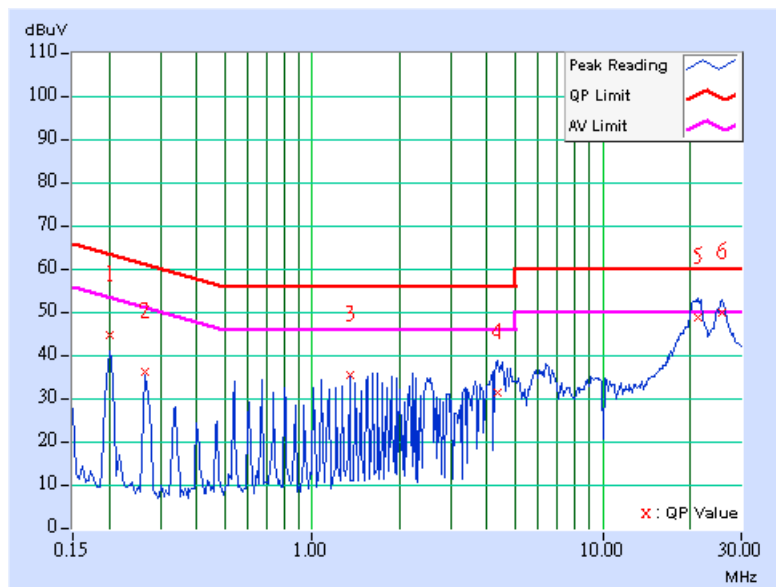



EUT	Wireless Serial Device Server	MODEL	NPort W2004
CHANNEL	1	6dB BANDWIDTH	9 kHz
INPUT POWER (SYSTEM)	120 Vac, 60 Hz	PHASE	Neutral (N)
ENVIRONMENTAL CONDITIONS	24 deg. C, 64% RH, 991 hPa	TESTED BY	Gary Chang

No	Freq. [MHz]	Corr. Factor (dB)	Reading Value		Emission Level		Limit		Margin	
			[dB (uV)]		[dB (uV)]		[dB (uV)]		(dB)	
			Q.P.	AV.	Q.P.	AV.	Q.P.	AV.	Q.P.	AV.
1	0.205	0.11	45.58	-	45.69	-	63.42	53.42	-17.73	-
2	0.537	0.12	41.43	-	41.55	-	56.00	46.00	-14.45	-
3	0.607	0.12	39.29	-	39.41	-	56.00	46.00	-16.59	-
4	4.909	0.22	35.25	-	35.47	-	56.00	46.00	-20.53	-
5	21.395	0.70	49.50	42.28	50.20	42.98	60.00	50.00	-9.80	-7.02
6	25.562	0.67	49.53	41.52	50.20	42.19	60.00	50.00	-9.80	-7.81

- REMARKS:**
1. Q.P. and AV. are abbreviations of quasi-peak and average individually.
 2. "-": The Quasi-peak reading value also meets average limit and measurement with the average detector is unnecessary.
 3. The emission levels of other frequencies were very low against the limit.
 4. Margin value = Emission level - Limit value
 5. Correction factor = Insertion loss + Cable loss
 6. Emission Level = Correction Factor + Reading Value.

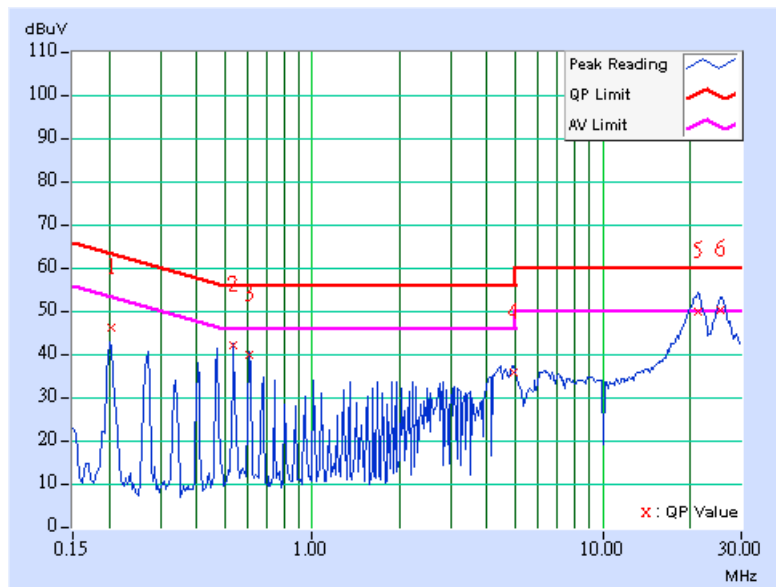



EUT	Wireless Serial Device Server	MODEL	NPort W2004
CHANNEL	6	6dB BANDWIDTH	9 kHz
INPUT POWER (SYSTEM)	120 Vac, 60 Hz	PHASE	Line (L)
ENVIRONMENTAL CONDITIONS	24 deg. C, 64% RH, 991 hPa	TESTED BY	Gary Chang

No	Freq. [MHz]	Corr. Factor (dB)	Reading Value [dB (uV)]		Emission Level [dB (uV)]		Limit [dB (uV)]		Margin (dB)	
			Q.P.	AV.	Q.P.	AV.	Q.P.	AV.	Q.P.	AV.
			1	0.201	0.12	42.71	-	42.83	-	63.58
2	0.537	0.13	34.81	-	34.94	-	56.00	46.00	-21.06	-
3	1.340	0.15	34.49	-	34.64	-	56.00	46.00	-21.36	-
4	4.289	0.21	32.32	-	32.53	-	56.00	46.00	-23.47	-
5	21.152	1.05	48.68	-	49.73	-	60.00	50.00	-10.27	-
6	25.582	1.19	42.73	-	43.92	-	60.00	50.00	-16.08	-

- REMARKS:**
1. Q.P. and AV. are abbreviations of quasi-peak and average individually.
 2. "-": The Quasi-peak reading value also meets average limit and measurement with the average detector is unnecessary.
 3. The emission levels of other frequencies were very low against the limit.
 4. Margin value = Emission level - Limit value
 5. Correction factor = Insertion loss + Cable loss
 6. Emission Level = Correction Factor + Reading Value.

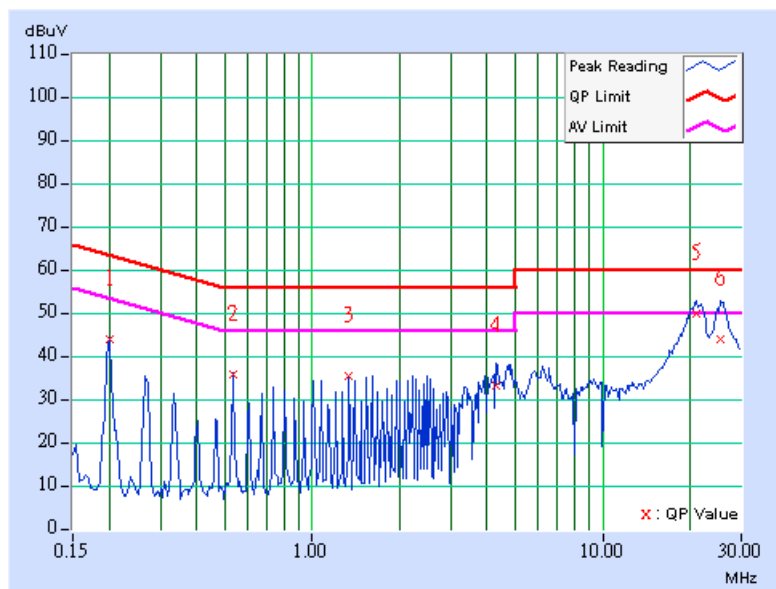



EUT	Wireless Serial Device Server	MODEL	NPort W2004
CHANNEL	6	6dB BANDWIDTH	9 kHz
INPUT POWER (SYSTEM)	120 Vac, 60 Hz	PHASE	Neutral (N)
ENVIRONMENTAL CONDITIONS	24 deg. C, 64% RH, 991 hPa	TESTED BY	Gary Chang

No	Freq. [MHz]	Corr. Factor (dB)	Reading Value		Emission Level		Limit		Margin	
			[dB (uV)]		[dB (uV)]		[dB (uV)]		(dB)	
			Q.P.	AV.	Q.P.	AV.	Q.P.	AV.	Q.P.	AV.
1	0.201	0.11	46.16	-	46.27	-	63.58	53.58	-17.31	-
2	0.533	0.12	39.79	-	39.91	-	56.00	46.00	-16.09	-
3	0.603	0.12	39.67	-	39.79	-	56.00	46.00	-16.21	-
4	4.629	0.21	31.09	-	31.30	-	56.00	46.00	-24.70	-
5	21.585	0.70	48.13	-	48.83	-	60.00	50.00	-11.17	-
6	25.477	0.67	46.69	-	47.36	-	60.00	50.00	-12.64	-

- REMARKS:**
1. Q.P. and AV. are abbreviations of quasi-peak and average individually.
 2. "-": The Quasi-peak reading value also meets average limit and measurement with the average detector is unnecessary.
 3. The emission levels of other frequencies were very low against the limit.
 4. Margin value = Emission level - Limit value
 5. Correction factor = Insertion loss + Cable loss
 6. Emission Level = Correction Factor + Reading Value.

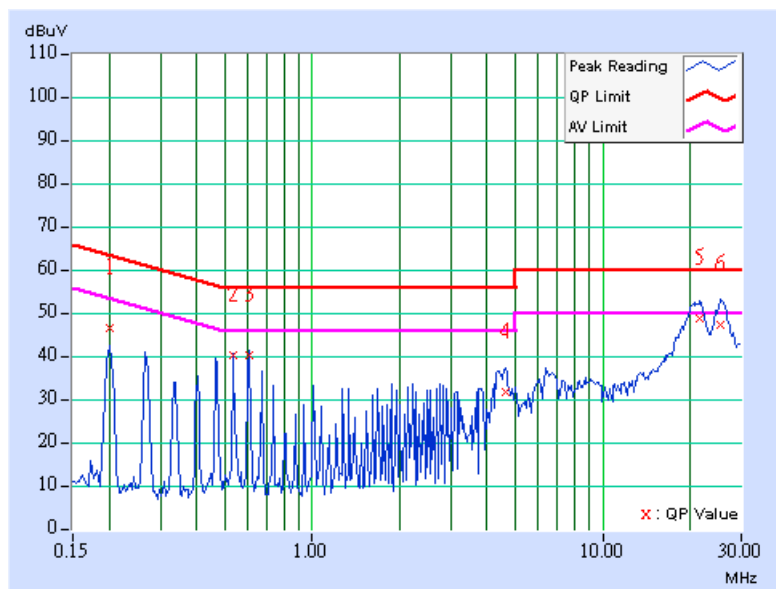



EUT	Wireless Serial Device Server	MODEL	NPort W2004
CHANNEL	11	6dB BANDWIDTH	9 kHz
INPUT POWER (SYSTEM)	120 Vac, 60 Hz	PHASE	Line (L)
ENVIRONMENTAL CONDITIONS	24 deg. C, 64% RH, 991 hPa	TESTED BY	Gary Chang

No	Freq. [MHz]	Corr. Factor (dB)	Reading Value		Emission Level		Limit		Margin	
			[dB (uV)]		[dB (uV)]		[dB (uV)]		(dB)	
			Q.P.	AV.	Q.P.	AV.	Q.P.	AV.	Q.P.	AV.
1	0.201	0.12	41.44	-	41.56	-	63.58	53.58	-22.02	-
2	0.533	0.13	34.64	-	34.77	-	56.00	46.00	-21.23	-
3	1.336	0.15	34.41	-	34.56	-	56.00	46.00	-21.44	-
4	4.539	0.22	36.28	-	36.50	-	56.00	46.00	-19.50	-
5	21.033	1.05	46.73	-	47.78	-	60.00	50.00	-12.22	-
6	25.434	1.19	48.52	-	49.71	-	60.00	50.00	-10.29	-

- REMARKS:**
1. Q.P. and AV. are abbreviations of quasi-peak and average individually.
 2. "-": The Quasi-peak reading value also meets average limit and measurement with the average detector is unnecessary.
 3. The emission levels of other frequencies were very low against the limit.
 4. Margin value = Emission level - Limit value
 5. Correction factor = Insertion loss + Cable loss
 6. Emission Level = Correction Factor + Reading Value.

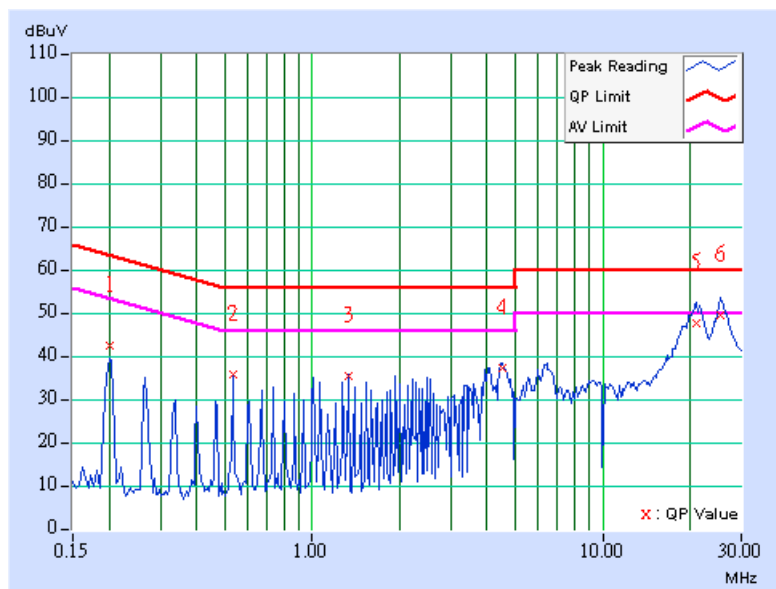



EUT	Wireless Serial Device Server	MODEL	NPort W2004
CHANNEL	11	6dB BANDWIDTH	9 kHz
INPUT POWER (SYSTEM)	120 Vac, 60 Hz	PHASE	Netural (N)
ENVIRONMENTAL CONDITIONS	24 deg. C, 64% RH, 991 hPa	TESTED BY	Gary Chang

No	Freq. [MHz]	Corr. Factor (dB)	Reading Value		Emission Level		Limit		Margin	
			[dB (uV)]		[dB (uV)]		[dB (uV)]		(dB)	
			Q.P.	AV.	Q.P.	AV.	Q.P.	AV.	Q.P.	AV.
1	0.201	0.11	45.28	-	45.39	-	63.58	53.58	-18.19	-
2	0.466	0.12	39.97	-	40.09	-	56.58	46.58	-16.49	-
3	0.537	0.12	40.89	-	41.01	-	56.00	46.00	-14.99	-
4	4.615	0.21	29.47	-	29.68	-	56.00	46.00	-26.32	-
5	20.312	0.71	46.17	-	46.88	-	60.00	50.00	-13.12	-
6	25.385	0.67	49.13	-	49.80	-	60.00	50.00	-10.20	-

- REMARKS:**
1. Q.P. and AV. are abbreviations of quasi-peak and average individually.
 2. "-": The Quasi-peak reading value also meets average limit and measurement with the average detector is unnecessary.
 3. The emission levels of other frequencies were very low against the limit.
 4. Margin value = Emission level - Limit value
 5. Correction factor = Insertion loss + Cable loss
 6. Emission Level = Correction Factor + Reading Value.

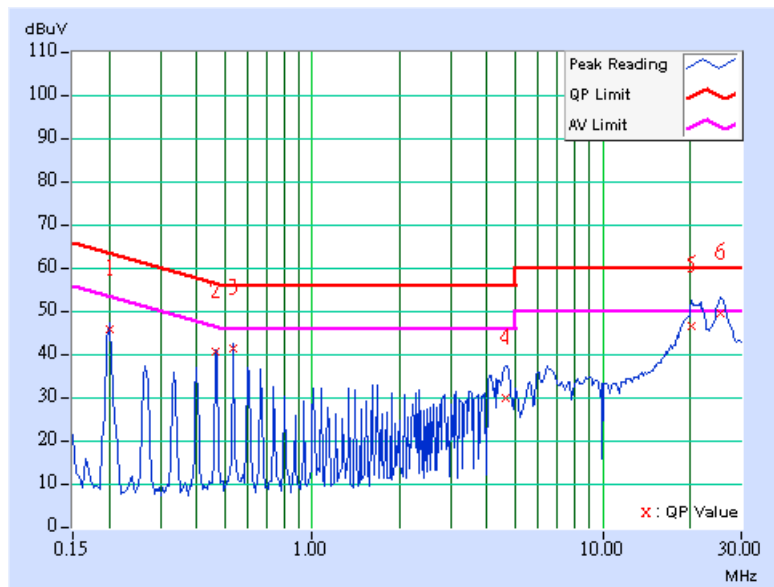



4.2 RADIATED EMISSION MEASUREMENT

4.2.1 LIMITS OF RADIATED EMISSION MEASUREMENT

Emissions radiated outside of the specified bands, shall be according to the general radiated limits in 15.209 as following:

Frequencies (MHz)	Field strength (microvolts/meter)	Measurement distance (meters)
0.009-0.490	2400/F(kHz)	300
0.490-1.705	24000/F(kHz)	30
1.705-30.0	30	30
30-88	100	3
88-216	150	3
216-960	200	3
Above 960	500	3

NOTE:

1. The lower limit shall apply at the transition frequencies.
2. Emission level (dBuV/m) = 20 log Emission level (uV/m).
3. As shown in 15.35(b), for frequencies above 1000MHz, the field strength limits are based on average detector, however, the peak field strength of any emission shall not exceed the maximum permitted average limits, specified above by more than 20dB under any condition of modulation.



4.2.2 TEST INSTRUMENTS

DESCRIPTION & MANUFACTURER	MODEL NO.	SERIAL NO.	CALIBRATED UNTIL
Test Receiver ROHDE & SCHWARZ	ESI7	838496/016	Feb. 09, 2005
Spectrum Analyzer ROHDE & SCHWARZ	FSP40	100041	Dec. 15, 2004
BILOG Antenna SCHWARZBECK	VULB9168	9168-155	Feb. 03, 2005
HORN Antenna SCHWARZBECK	BBHA 9120D	9120D-404	Feb. 03, 2005
HORN Antenna SCHWARZBECK	BBHA 9170	BBHA 9170242	Feb. 23, 2005
Preamplifier Agilent	8447D	2944A10631	Jan. 15, 2005
Preamplifier Agilent	8449B	3008A01960	Jan. 22, 2005
RF signal cable HUBER+SUHNNER	SUCOFLEX 104	219272/4	Mar. 04, 2005
RF signal cable HUBER+SUHNNER	SUCOFLEX 104	219275/4	Mar. 04, 2005
Software ADT.	ADT_Radiated_V5.14	NA	NA
Antenna Tower inn-co GmbH	MA 4000	010303	NA
Antenna Tower Controller inn-co GmbH	CO2000	019303	NA
Turn Table ADT.	TT100.	TT93021704	NA
Turn Table Controller ADT.	SC100.	SC93021704	NA

- NOTE:**
1. The calibration interval of the above test instruments is 12 months and the calibrations are traceable to NML/ROC and NIST/USA.
 2. The test was performed in HwaYa Chamber 3.
 3. The horn antenna and HP preamplifier (model: 8449B) are used only for the measurement of emission frequency above 1GHz if tested.
 4. The IC Site Registration No. is IC4924-4.



4.2.3 TEST PROCEDURES

- a. The EUT was placed on the top of a rotating table 0.8 meters above the ground at a 3 meters semi-anechoic chamber. The table was rotated 360 degrees to determine the position of the highest radiation.
- b. The EUT was set 3 meters away from the interference-receiving antenna, which was mounted on the top of a variable-height antenna tower.
- c. The antenna is a broadband antenna, and its height is varied from one meter to four meters above the ground to determine the maximum value of the field strength. Both horizontal and vertical polarizations of the antenna are set to make the measurement.
- d. For each suspected emission, the EUT was arranged to its worst case and then the antenna was tuned to heights from 1 meter to 4 meters and the rotatable table was turned from 0 degrees to 360 degrees to find the maximum reading.
- e. The test-receiver system was set to Peak Detect Function and Specified Bandwidth with Maximum Hold Mode.
- f. If the emission level of the EUT in peak mode was 10 dB lower than the limit specified, then testing could be stopped and the peak values of the EUT would be reported. Otherwise the emissions that did not have 10 dB margin would be re-tested one by one using peak, quasi-peak or average method as specified and then reported in a data sheet.

NOTE:

1. The resolution bandwidth and video bandwidth of test receiver/spectrum analyzer is 120kHz for Peak detection (PK) and Quasi-peak detection (QP) at frequency below 1GHz.
2. The resolution bandwidth and video bandwidth of test receiver/spectrum analyzer is 1 MHz for Peak detection at frequency above 1GHz.
3. The resolution bandwidth of test receiver/spectrum analyzer is 1 MHz and the video bandwidth is 10 Hz for Average detection (AV) at frequency above 1GHz.

4.2.4 DEVIATION FROM TEST STANDARD

No deviation.

4.2.5 TEST SETUP

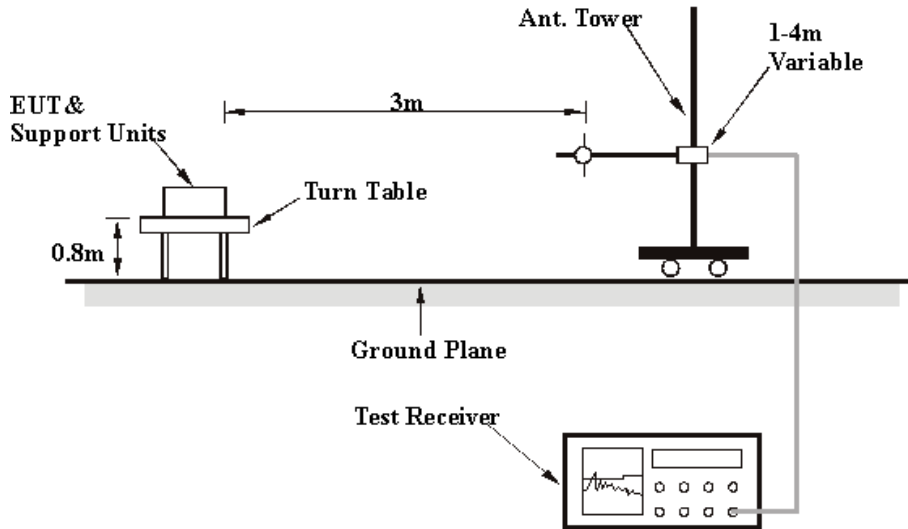

For the actual test configuration, please refer to the related item – Photographs of the Test Configuration.

4.2.6 EUT OPERATING CONDITIONS

Same as 4.1.6.



4.2.7 TEST RESULTS

EUT	Wireless Serial Device Server	MODEL	NPort W2004
CHANNEL	11	FREQUENCY RANGE	Below 1000 MHz
INPUT POWER (SYSTEM)	120 Vac, 60Hz	DETECTOR FUNCTION	Quasi-Peak
ENVIRONMENTAL CONDITIONS	26 deg. C, 56% RH, 991 hPa	TESTED BY	Rush Kao

ANTENNA POLARITY & TEST DISTANCE: HORIZONTAL AT 3 M								
No.	Freq. (MHz)	Emission Level (dBuV/m)	Limit (dBuV/m)	Margin (dB)	Antenna Height (m)	Table Angle (Degree)	Raw Value (dBuV)	Correction Factor (dB/m)
1	37.78	35.84 QP	40.00	-4.16	2.50 H	337	20.88	14.96
2	197.17	39.61 QP	43.50	-3.89	1.50 H	289	28.11	11.50
3	263.27	32.92 QP	46.00	-13.08	1.50 H	322	19.54	13.39
4	362.40	38.40 QP	46.00	-7.60	1.00 H	358	22.58	15.82
5	395.45	41.39 QP	46.00	-4.61	2.50 H	175	24.77	16.62
6	527.64	36.09 QP	46.00	-9.91	1.50 H	130	17.03	19.06
7	560.68	38.98 QP	46.00	-7.02	2.00 H	19	19.23	19.75

- REMARKS:**
1. Emission level(dBuV/m)=Raw Value(dBuV) + Correction Factor(dB/m)
 2. Correction Factor(dB/m) = Antenna Factor (dB/m) + Cable Factor (dB)
 3. The other emission levels were very low against the limit.
 4. Margin value = Emission level – Limit value.



EUT	Wireless Serial Device Server	MODEL	NPort W2004
CHANNEL	11	FREQUENCY RANGE	Below 1000 MHz
INPUT POWER (SYSTEM)	120 Vac, 60Hz	DETECTOR FUNCTION	Quasi-Peak
ENVIRONMENTAL CONDITIONS	26 deg. C, 56% RH, 991 hPa	TESTED BY	Rush Kao

ANTENNA POLARITY & TEST DISTANCE: VERTICAL AT 3 M

No.	Freq. (MHz)	Emission Level (dBuV/m)	Limit (dBuV/m)	Margin (dB)	Antenna Height (m)	Table Angle (Degree)	Raw Value (dBuV)	Correction Factor (dB/m)
1	51.38	38.20 QP	40.00	-1.80	1.00 V	334	23.74	14.46
2	230.22	41.82 QP	46.00	-4.18	1.00 V	160	29.46	12.36
3	395.45	38.03 QP	46.00	-7.97	1.50 V	166	21.41	16.62
4	494.59	37.58 QP	46.00	-8.42	1.25 V	13	19.07	18.51
5	527.64	42.26 QP	46.00	-3.74	1.00 V	343	23.20	19.06
6	560.68	40.68 QP	46.00	-5.32	1.00 V	337	20.93	19.75
7	599.56	40.53 QP	46.00	-5.47	1.25 V	166	19.71	20.82
8	792.00	40.97 QP	46.00	-5.03	1.00 V	115	17.55	23.42

- REMARKS:**
1. Emission level(dBuV/m)=Raw Value(dBuV) + Correction Factor(dB/m)
 2. Correction Factor(dB/m) = Antenna Factor (dB/m) + Cable Factor (dB)
 3. The other emission levels were very low against the limit.
 4. Margin value = Emission level – Limit value.

4.2.8 TEST RESULTS (A)

EUT	Wireless Serial Device Server	MODEL	NPort W2004
CHANNEL	1	FREQUENCY RANGE	1~25 GHz
INPUT POWER (SYSTEM)	120 Vac, 60 Hz	DETECTOR FUNCTION	Peak (PK) Average (AV)
ENVIRONMENTAL CONDITIONS	25 deg. C, 62% RH, 991 hPa	TESTED BY	Leo Hung

ANTENNA POLARITY & TEST DISTANCE: HORIZONTAL AT 3 M

No.	Freq. (MHz)	Emission Level (dBuV/m)	Limit (dBuV/m)	Margin (dB)	Antenna Height (m)	Table Angle (Degree)	Raw Value (dBuV)	Correction Factor (dB/m)
1	1056.00	43.88 PK	74.00	-30.12	1.34 H	155	16.12	27.76
2	2390.00	48.67 PK	74.00	-25.33	1.08 H	187	17.06	31.61
3	*2412.00	106.49 PK			1.08 H	187	74.79	31.70
3	*2412.00	98.96 AV			1.08 H	187	67.26	31.70
4	2786.00	57.85 PK	74.00	-16.15	1.09 H	36	24.85	33.00
4	2786.00	45.50 AV	54.00	-8.50	1.09 H	36	12.50	33.00
5	4824.00	53.51 PK	74.00	-20.49	1.09 H	222	15.93	37.58
5	4824.00	41.52 AV	54.00	-12.48	1.09 H	222	3.94	37.58

ANTENNA POLARITY & TEST DISTANCE: VERTICAL AT 3 M

No.	Freq. (MHz)	Emission Level (dBuV/m)	Limit (dBuV/m)	Margin (dB)	Antenna Height (m)	Table Angle (Degree)	Raw Value (dBuV)	Correction Factor (dB/m)
1	1056.00	42.93 PK	74.00	-31.07	1.06 V	238	15.17	27.76
2	2390.00	54.17 PK	74.00	-19.83	1.10 V	318	22.56	31.61
2	2390.00	46.70 AV	54.00	-7.30	1.10 V	318	15.09	31.61
3	*2412.00	111.99 PK			1.10 V	318	80.29	31.70
3	*2412.00	104.50 AV			1.10 V	318	72.80	31.70
4	2786.00	60.73 PK	74.00	-13.27	1.00 V	199	27.73	33.00
4	2786.00	48.43 AV	54.00	-5.57	1.00 V	199	15.43	33.00
5	4824.00	54.92 PK	74.00	-19.08	1.10 V	255	17.34	37.58
5	4824.00	42.65 AV	54.00	-11.35	1.10 V	255	5.07	37.58

REMARKS:

1. Emission level(dBuV/m)=Raw Value(dBuV) + Correction Factor(dB)
2. Correction Factor(dB/m) = Antenna Factor (dB/m) + Cable Factor (dB)
3. The other emission levels were very low against the limit.
4. Margin value = Emission level – Limit value.
5. “ * ” : Fundamental frequency



EUT	Wireless Serial Device Server	MODEL	NPort W2004
CHANNEL	6	FREQUENCY RANGE	1~25 GHz
INPUT POWER (SYSTEM)	120 Vac, 60 Hz	DETECTOR FUNCTION	Peak (PK) Average (AV)
ENVIRONMENTAL CONDITIONS	25 deg. C, 62% RH, 991 hPa	TESTED BY	Leo Hung

ANTENNA POLARITY & TEST DISTANCE: HORIZONTAL AT 3 M

No.	Freq. (MHz)	Emission Level (dBuV/m)	Limit (dBuV/m)	Margin (dB)	Antenna Height (m)	Table Angle (Degree)	Raw Value (dBuV)	Correction Factor (dB/m)
1	1056.00	42.21 PK	74.00	-31.79	1.12 H	21	14.45	27.76
2	*2437.00	105.22 PK			1.16 H	328	73.37	31.85
2	*2437.00	97.54 AV			1.16 H	328	65.69	31.85
3	2808.00	56.21 PK	74.00	-17.79	1.10 H	223	23.15	33.06
3	2808.00	45.78 AV	54.00	-8.22	1.10 H	223	12.72	33.06
4	4874.00	53.20 PK	74.00	-20.80	1.02 H	222	15.54	37.66
4	4874.00	40.22 AV	54.00	-13.78	1.02 H	222	2.56	37.66

ANTENNA POLARITY & TEST DISTANCE: VERTICAL AT 3 M

No.	Freq. (MHz)	Emission Level (dBuV/m)	Limit (dBuV/m)	Margin (dB)	Antenna Height (m)	Table Angle (Degree)	Raw Value (dBuV)	Correction Factor (dB/m)
1	1056.00	42.58 PK	74.00	-31.42	1.32 V	125	14.82	27.76
2	*2437.00	112.54 PK			1.16 V	328	80.69	31.85
2	*2437.00	103.57 AV			1.16 V	328	71.72	31.85
3	2808.00	60.57 PK	74.00	-13.43	1.10 V	112	27.51	33.06
3	2808.00	48.57 AV	54.00	-5.43	1.10 V	112	15.51	33.06
4	4874.00	54.21 PK	74.00	-19.79	1.10 V	122	16.55	37.66
4	4874.00	42.36 AV	54.00	-11.64	1.10 V	122	4.70	37.66

REMARKS:

1. Emission level(dBuV/m)=Raw Value(dBuV) + Correction Factor(dB)
2. Correction Factor(dB/m) = Antenna Factor (dB/m) + Cable Factor (dB)
3. The other emission levels were very low against the limit.
4. Margin value = Emission level – Limit value.
5. “ * “ : Fundamental frequency



EUT	Wireless Serial Device Server	MODEL	NPort W2004
CHANNEL	11	FREQUENCY RANGE	1~25 GHz
INPUT POWER (SYSTEM)	120 Vac, 60 Hz	DETECTOR FUNCTION	Peak (PK) Average (AV)
ENVIRONMENTAL CONDITIONS	25 deg. C, 62% RH, 991 hPa	TESTED BY	Leo Hung

ANTENNA POLARITY & TEST DISTANCE: HORIZONTAL AT 3 M								
No.	Freq. (MHz)	Emission Level (dBuV/m)	Limit (dBuV/m)	Margin (dB)	Antenna Height (m)	Table Angle (Degree)	Raw Value (dBuV)	Correction Factor (dB/m)
1	1056.00	42.58 PK	74.00	-31.42	1.32 H	125	14.82	27.76
2	*2462.00	105.57 PK			1.06 H	188	73.57	32.00
2	*2462.00	97.54 AV			1.06 H	188	65.54	32.00
3	2483.50	53.79 PK	74.00	-20.21	1.16 H	328	21.66	32.13
3	2483.50	46.70 AV	54.00	-7.30	1.16 H	328	14.57	32.13
4	2838.00	56.57 PK	74.00	-17.43	1.10 H	221	23.45	33.12
4	2838.00	44.21 AV	54.00	-9.79	1.10 H	221	11.09	33.12
5	4924.00	52.11 PK	74.00	-21.89	1.09 H	221	14.37	37.74
5	4924.00	40.24 AV	54.00	-13.76	1.09 H	221	2.50	37.74

ANTENNA POLARITY & TEST DISTANCE: VERTICAL AT 3 M								
No.	Freq. (MHz)	Emission Level (dBuV/m)	Limit (dBuV/m)	Margin (dB)	Antenna Height (m)	Table Angle (Degree)	Raw Value (dBuV)	Correction Factor (dB/m)
1	1056.00	42.01 PK	74.00	-31.99	1.00 V	223	14.25	27.76
2	*2462.00	111.21 PK			1.16 V	328	79.21	32.00
2	*2462.00	103.02 AV			1.16 V	328	71.02	32.00
3	2462.00	59.37 PK	74.00	-14.63	1.16 V	328	27.37	32.00
3	2462.00	51.18 AV	54.00	-2.82	1.16 V	328	19.18	32.00
4	2838.00	59.57 PK	74.00	-14.43	1.10 V	234	26.45	33.12
4	2838.00	47.23 AV	54.00	-6.77	1.10 V	234	14.11	33.12
5	4924.00	54.21 PK	74.00	-19.79	1.10 V	121	16.47	37.74
5	4924.00	42.12 AV	54.00	-11.88	1.10 V	121	4.38	37.74

REMARKS:

1. Emission level(dBuV/m)=Raw Value(dBuV) + Correction Factor(dB)
2. Correction Factor(dB/m) = Antenna Factor (dB/m) + Cable Factor (dB)
3. The other emission levels were very low against the limit.
4. Margin value = Emission level – Limit value.
5. “ * ” : Fundamental frequency



4.2.9 TEST RESULTS (B)

EUT	Wireless Serial Device Server	MODEL	NPort W2004
CHANNEL	1	FREQUENCY RANGE	1~25 GHz
INPUT POWER (SYSTEM)	120 Vac, 60 Hz	DETECTOR FUNCTION	Peak (PK) Average (AV)
ENVIRONMENTAL CONDITIONS	25 deg. C, 62% RH, 991 hPa	TESTED BY	Leo Hung

ANTENNA POLARITY & TEST DISTANCE: HORIZONTAL AT 3 M

No.	Freq. (MHz)	Emission Level (dBuV/m)	Limit (dBuV/m)	Margin (dB)	Antenna Height (m)	Table Angle (Degree)	Raw Value (dBuV)	Correction Factor (dB/m)
1	1056.00	43.23 PK	74.00	-30.77	1.23 H	310	15.47	27.76
2	2038.00	46.77 PK	74.00	-27.23	1.18 H	186	16.73	30.04
3	2390.00	55.10 PK	74.00	-18.90	1.05 H	14	23.49	31.61
3	2390.00	45.59 AV	54.00	-8.41	1.05 H	14	13.98	31.61
4	*2412.00	105.51 PK			1.05 H	14	73.81	31.70
4	*2412.00	96.00 AV			1.05 H	14	64.30	31.70
5	2786.00	55.88 PK	74.00	-18.12	1.27 H	10	22.88	33.00
5	2786.00	42.50 AV	54.00	-11.50	1.27 H	10	9.50	33.00
6	4824.00	52.38 PK	74.00	-21.62	1.27 H	194	14.80	37.58
6	4824.00	39.48 AV	54.00	-14.52	1.27 H	194	1.90	37.58

ANTENNA POLARITY & TEST DISTANCE: VERTICAL AT 3 M

No.	Freq. (MHz)	Emission Level (dBuV/m)	Limit (dBuV/m)	Margin (dB)	Antenna Height (m)	Table Angle (Degree)	Raw Value (dBuV)	Correction Factor (dB/m)
1	1056.00	46.92 PK	74.00	-27.08	1.04 V	37	19.16	27.76
2	2038.00	51.93 PK	74.00	-22.07	1.04 V	346	21.89	30.04
2	2038.00	49.81 AV	54.00	-4.19	1.04 V	346	19.77	30.04
3	2390.00	60.48 PK	74.00	-13.52	1.18 V	27	28.87	31.61
3	2390.00	51.33 AV	54.00	-2.67	1.18 V	27	19.72	31.61
4	*2412.00	110.89 PK			1.18 V	27	79.19	31.70
4	*2412.00	101.74 AV			1.18 V	27	70.04	31.70
5	2786.00	57.76 PK	74.00	-16.24	1.15 V	221	24.76	33.00
5	2786.00	46.65 AV	54.00	-7.35	1.15 V	221	13.65	33.00
6	4824.00	56.09 PK	74.00	-17.91	1.06 V	162	18.51	37.58
6	4824.00	43.12 AV	54.00	-10.88	1.06 V	162	5.54	37.58

REMARKS:

1. Emission level(dBuV/m)=Raw Value(dBuV) + Correction Factor(dB)
2. Correction Factor(dB/m) = Antenna Factor (dB/m) + Cable Factor (dB)
3. The other emission levels were very low against the limit.
4. Margin value = Emission level – Limit value.
5. “ * ” : Fundamental frequency



EUT	Wireless Serial Device Server	MODEL	NPort W2004
CHANNEL	6	FREQUENCY RANGE	1~25 GHz
INPUT POWER (SYSTEM)	120 Vac, 60 Hz	DETECTOR FUNCTION	Peak (PK) Average (AV)
ENVIRONMENTAL CONDITIONS	25 deg. C, 62% RH, 991 hPa	TESTED BY	Leo Hung

ANTENNA POLARITY & TEST DISTANCE: HORIZONTAL AT 3 M

No.	Freq. (MHz)	Emission Level (dBuV/m)	Limit (dBuV/m)	Margin (dB)	Antenna Height (m)	Table Angle (Degree)	Raw Value (dBuV)	Correction Factor (dB/m)
1	1056.00	50.78 PK	74.00	-23.22	1.17 H	34	23.02	27.76
2	*2437.00	103.40 PK			1.07 H	54	71.55	31.85
2	*2437.00	94.06 AV			1.07 H	54	62.21	31.85
3	2808.00	42.91 PK	74.00	-31.09	1.45 H	34	9.85	33.06
4	4874.00	50.06 PK	74.00	-23.94	1.00 H	175	12.40	37.66

ANTENNA POLARITY & TEST DISTANCE: VERTICAL AT 3 M

No.	Freq. (MHz)	Emission Level (dBuV/m)	Limit (dBuV/m)	Margin (dB)	Antenna Height (m)	Table Angle (Degree)	Raw Value (dBuV)	Correction Factor (dB/m)
1	1056.00	45.94 PK	74.00	-28.06	1.46 V	165	18.18	27.76
2	*2437.00	110.06 PK			1.11 V	324	78.21	31.85
2	*2437.00	102.17 AV			1.11 V	324	70.32	31.85
3	2808.00	55.99 PK	74.00	-18.01	1.00 V	301	22.93	33.06
3	2808.00	43.38 AV	54.00	-10.62	1.00 V	301	10.32	33.06
4	4874.00	53.89 PK	74.00	-20.11	1.06 V	159	16.23	37.66
4	4874.00	41.08 AV	54.00	-12.92	1.06 V	159	3.42	37.66

REMARKS:

1. Emission level(dBuV/m)=Raw Value(dBuV) + Correction Factor(dB)
2. Correction Factor(dB/m) = Antenna Factor (dB/m) + Cable Factor (dB)
3. The other emission levels were very low against the limit.
4. Margin value = Emission level – Limit value.
5. " * " : Fundamental frequency



EUT	Wireless Serial Device Server	MODEL	NPort W2004
CHANNEL	11	FREQUENCY RANGE	1~25 GHz
INPUT POWER (SYSTEM)	120 Vac, 60 Hz	DETECTOR FUNCTION	Peak (PK) Average (AV)
ENVIRONMENTAL CONDITIONS	25 deg. C, 62% RH, 991 hPa	TESTED BY	Leo Hung

ANTENNA POLARITY & TEST DISTANCE: HORIZONTAL AT 3 M

No.	Freq. (MHz)	Emission Level (dBuV/m)	Limit (dBuV/m)	Margin (dB)	Antenna Height (m)	Table Angle (Degree)	Raw Value (dBuV)	Correction Factor (dB/m)
1	1056.00	43.50 PK	74.00	-30.50	1.32 H	36	15.74	27.76
2	*2462.00	102.22 PK			1.02 H	11	70.22	32.00
2	*2462.00	93.21 AV			1.02 H	11	61.21	32.00
3	2483.50	54.30 PK	74.00	-19.70	1.02 H	11	22.17	32.13
3	2483.50	45.29 AV	54.00	-8.71	1.02 H	11	13.16	32.13
4	2786.00	48.23 PK	74.00	-25.77	1.02 H	11	15.23	33.00
5	4924.00	49.21 PK	74.00	-24.79	1.00 H	113	11.47	37.74

ANTENNA POLARITY & TEST DISTANCE: VERTICAL AT 3 M

No.	Freq. (MHz)	Emission Level (dBuV/m)	Limit (dBuV/m)	Margin (dB)	Antenna Height (m)	Table Angle (Degree)	Raw Value (dBuV)	Correction Factor (dB/m)
1	1056.00	44.98 PK	74.00	-29.02	1.40 V	165	17.22	27.76
2	*2462.00	109.31 PK			1.16 V	28	77.31	32.00
2	*2462.00	100.21 AV			1.16 V	28	68.21	32.00
3	2483.50	61.39 PK	74.00	-12.61	1.16 V	28	29.26	32.13
3	2483.50	52.39 AV	54.00	-1.61	1.16 V	28	20.26	32.13
4	2838.00	52.03 PK	74.00	-21.97	1.00 V	112	18.91	33.12
4	2838.00	47.29 AV	54.00	-6.71	1.00 V	112	14.17	33.12
5	4924.00	50.06 PK	74.00	-23.94	1.05 V	154	12.32	37.74

REMARKS:

1. Emission level(dBuV/m)=Raw Value(dBuV) + Correction Factor(dB)
2. Correction Factor(dB/m) = Antenna Factor (dB/m) + Cable Factor (dB)
3. The other emission levels were very low against the limit.
4. Margin value = Emission level – Limit value.
5. “ * ” : Fundamental frequency



4.3 6dB BANDWIDTH MEASUREMENT

4.3.1 LIMITS OF 6dB BANDWIDTH MEASUREMENT

The minimum of 6dB Bandwidth Measurement is 0.5MHz.

4.3.2 TEST INSTRUMENTS

Description & Manufacturer	Model No.	Serial No.	Calibrated Until
SPECTRUM ANALYZER	FSEK30	100049	Aug. 12, 2005

NOTE:

The calibration interval of the above test instruments is 12 months and the calibrations are traceable to NML/ROC and NIST/USA.

4.3.3 TEST PROCEDURE

The transmitter output was connected to the spectrum analyzer through an attenuator. The bandwidth of the fundamental frequency was measured by spectrum analyzer with 100kHz RBW and 100kHz VBW. The 6dB bandwidth is defined as the total spectrum the power of which is higher than peak power minus 6dB.

4.3.4 DEVIATION FROM TEST STANDARD

No deviation.

4.3.5 TEST SETUP

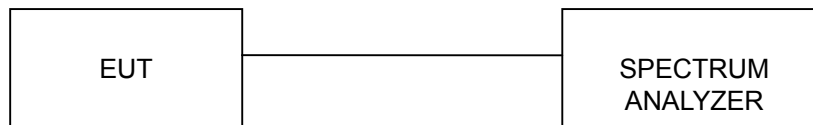

For the actual test configuration, please refer to the related Item – Photographs of the Test Configuration.

4.3.6 EUT OPERATING CONDITIONS

The software provided by client to enable the EUT under transmission condition continuously at lowest, middle and highest channel frequencies individually.



4.3.7 TEST RESULTS (A)

EUT	Wireless Serial Device Server	MODEL	NPort W2004
ENVIRONMENTAL CONDITIONS	24 deg. C, 64% RH, 991 hPa	INPUT POWER (SYSTEM)	120 Vac, 60 Hz
TESTED BY	Leo Hung		

CHANNEL	CHANNEL FREQUENCY (MHz)	6dB BANDWIDTH (MHz)	MINIMUM LIMIT (MHz)	PASS/FAIL
1	2412	11.72	0.5	PASS
6	2437	11.68	0.5	PASS
11	2462	11.96	0.5	PASS



CH1

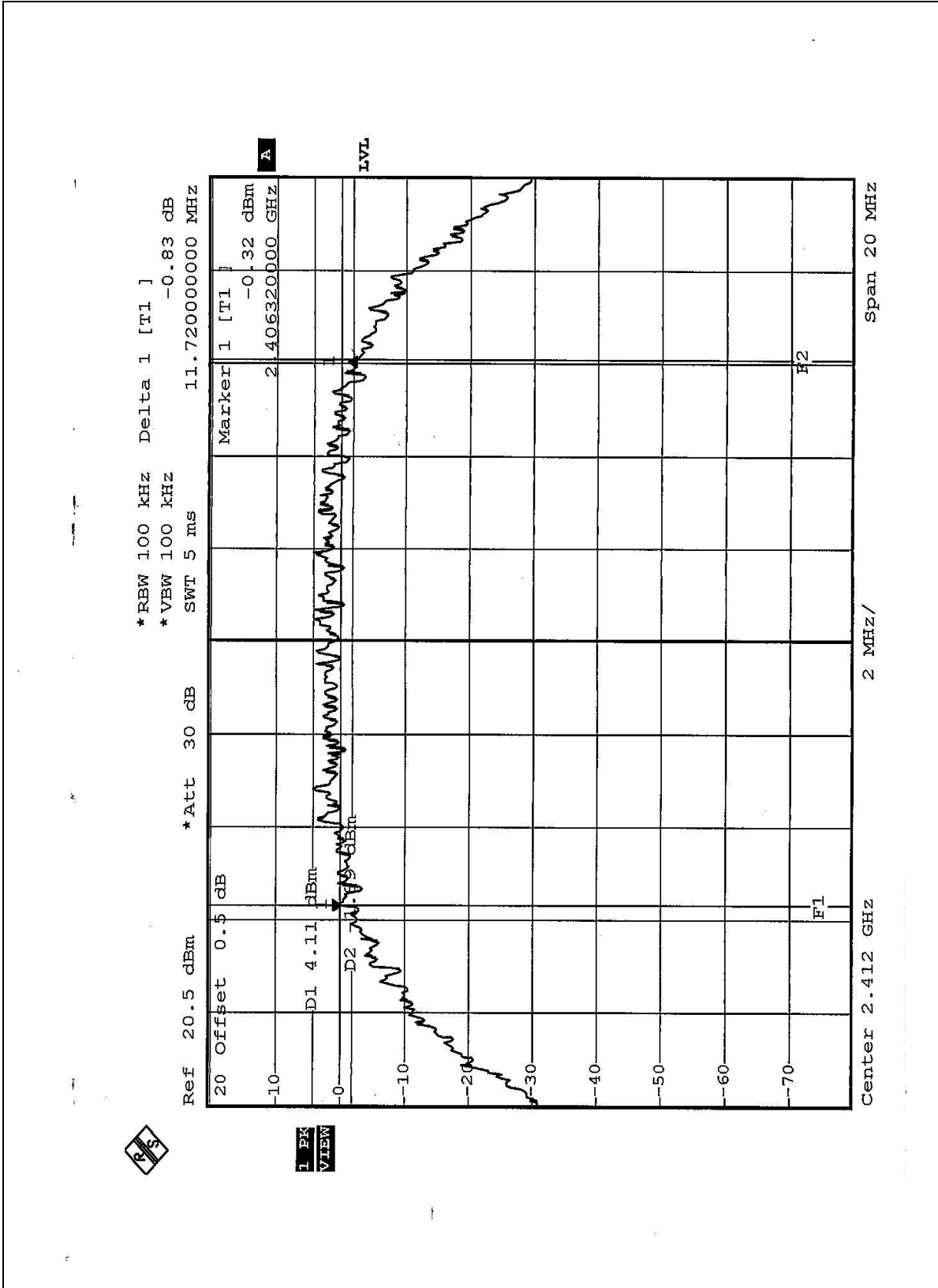



CH6

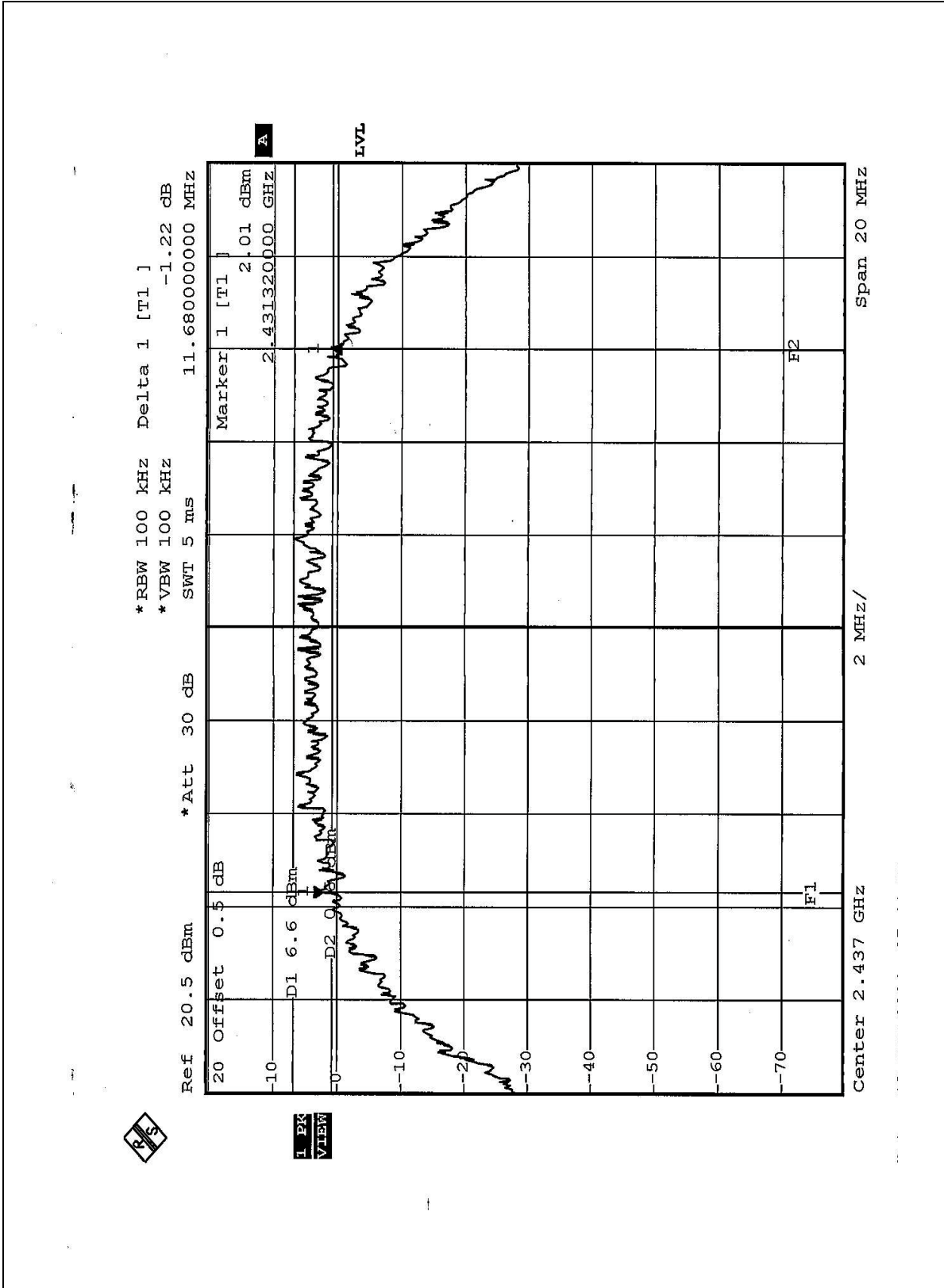



CH11

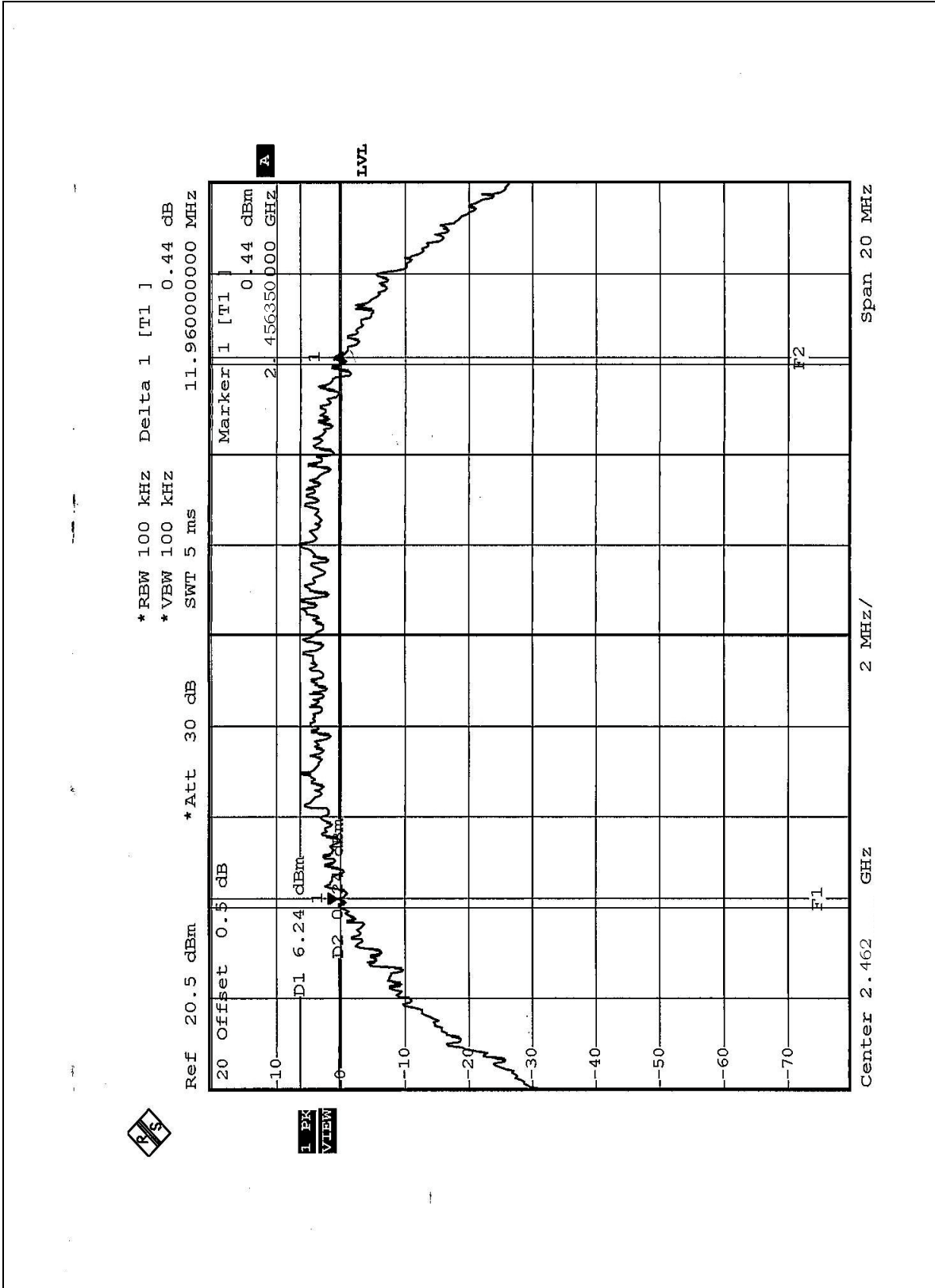



4.3.8 TEST RESULTS (B)

EUT	Wireless Serial Device Server	MODEL	NPort W2004
ENVIRONMENTAL CONDITIONS	24 deg. C, 64% RH, 991 hPa	INPUT POWER (SYSTEM)	120 Vac, 60 Hz
TESTED BY	Leo Hung		

CHANNEL	CHANNEL FREQUENCY (MHz)	6 dB BANDWIDTH (MHz)	MINIMUM LIMIT (MHz)	PASS/FAIL
1	2412	16.56	0.5	PASS
6	2437	16.60	0.5	PASS
11	2462	16.56	0.5	PASS



CH1

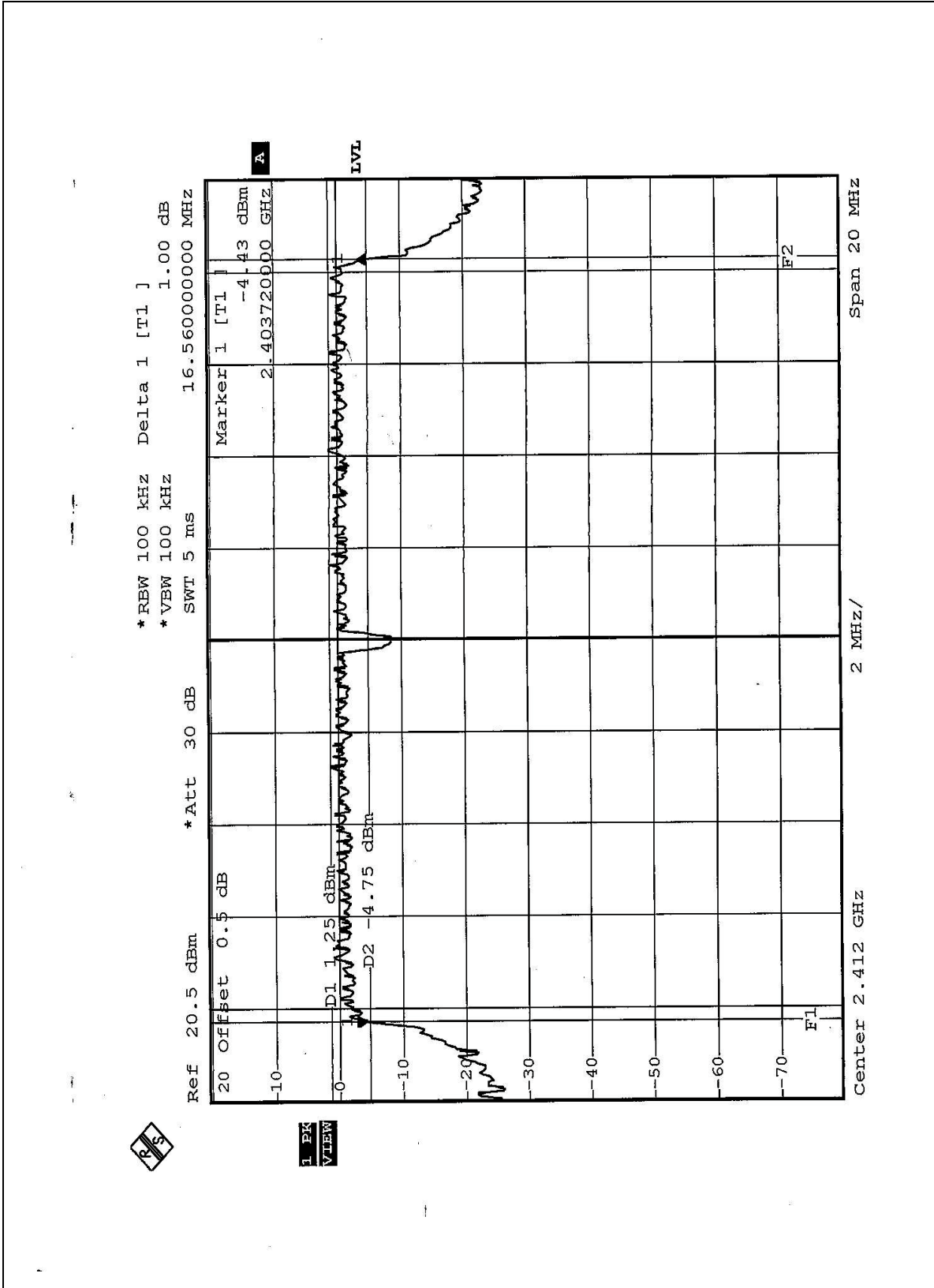

CH6

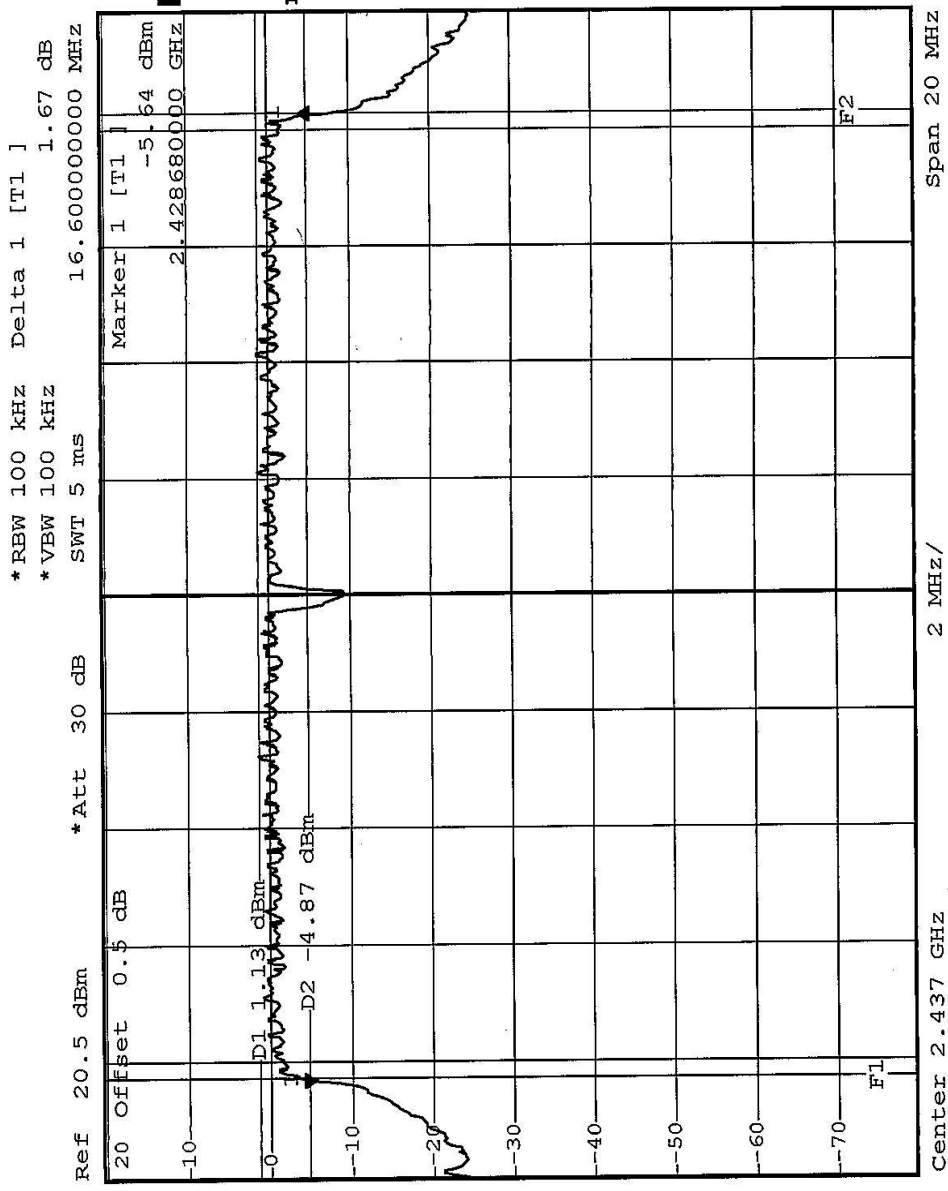

1 PK VIEW



CH11

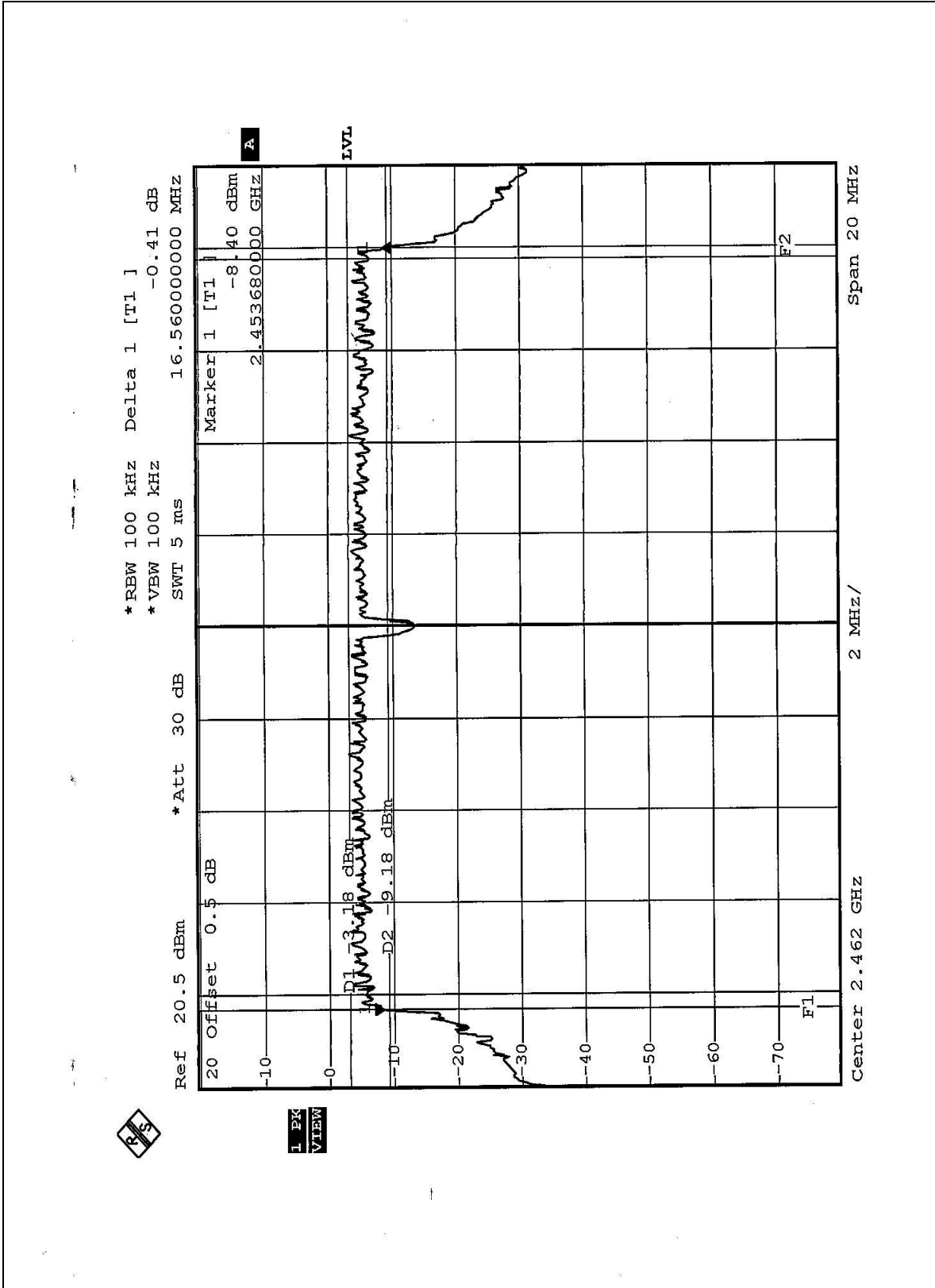

4.4 MAXIMUM PEAK OUTPUT POWER

4.4.1 LIMITS OF MAXIMUM PEAK OUTPUT POWER MEASUREMENT

The Maximum Peak Output Power Measurement is 30dBm.

4.4.2 TEST INSTRUMENTS

Description & Manufacturer	Model No.	Serial No.	Calibrated Until
R&S SPECTRUM ANALYZER	FSEK30	100049	Aug. 12, 2005
AGILENT SIGNAL GENERATOR	E8257C	MY43320668	Dec. 31, 2004
TEKTRONIX OSCILLOSCOPE	TDS 220	C019167	Feb. 1, 2005
NARDA DETECTOR	4503A	FSCM99899	NA

NOTE:

The calibration interval of the above test instruments is 12 months and the calibrations are traceable to NML/ROC and NIST/USA.

4.4.3 TEST PROCEDURES

1. A detector was used on the output port of the EUT. An oscilloscope was used to read the response of the detector.
2. Replaced the EUT by the signal generator. The center frequency of the S.G. was adjusted to the center frequency of the measured channel.
3. Adjusted the power to have the same reading on oscilloscope. Record the power level.

4.4.4 DEVIATION FROM TEST STANDARD

No deviation.

4.4.5 TEST SETUP

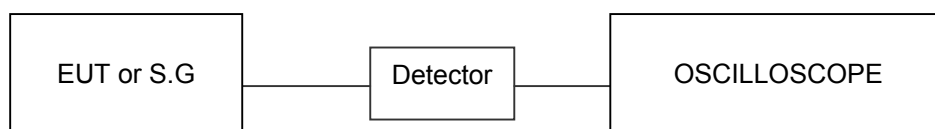

4.4.6 EUT OPERATING CONDITIONS

Same as Item 4.3.6.



4.4.7 TEST RESULTS (A)

EUT	Wireless Serial Device Server	MODEL	NPort W2004
ENVIRONMENTAL CONDITIONS	24 deg. C, 64% RH, 991 hPa	INPUT POWER (SYSTEM)	120 Vac, 60 Hz
TESTED BY	Leo Hung		

CHANNEL	CHANNEL FREQUENCY (MHz)	PEAK POWER OUTPUT (mW)	PEAK POWER OUTPUT (dBm)	PEAK POWER LIMIT (dBm)	PASS/FAIL
1	2412	64.417	18.09	30	PASS
6	2437	64.121	18.07	30	PASS
11	2462	63.533	18.03	30	PASS

4.4.8 TEST RESULTS (B)

EUT	Wireless Serial Device Server	MODEL	NPort W2004
ENVIRONMENTAL CONDITIONS	24 deg. C, 64% RH, 991 hPa	INPUT POWER (SYSTEM)	120 Vac, 60 Hz
TESTED BY	Leo Hung		

CHANNEL	CHANNEL FREQUENCY (MHz)	PEAK POWER OUTPUT (mW)	PEAK POWER OUTPUT (dBm)	PEAK POWER LIMIT (dBm)	PASS/FAIL
1	2412	63.533	18.03	30	PASS
6	2437	63.533	18.03	30	PASS
11	2462	39.902	16.01	30	PASS