

# 1. Specification

## 1.1 Drawing

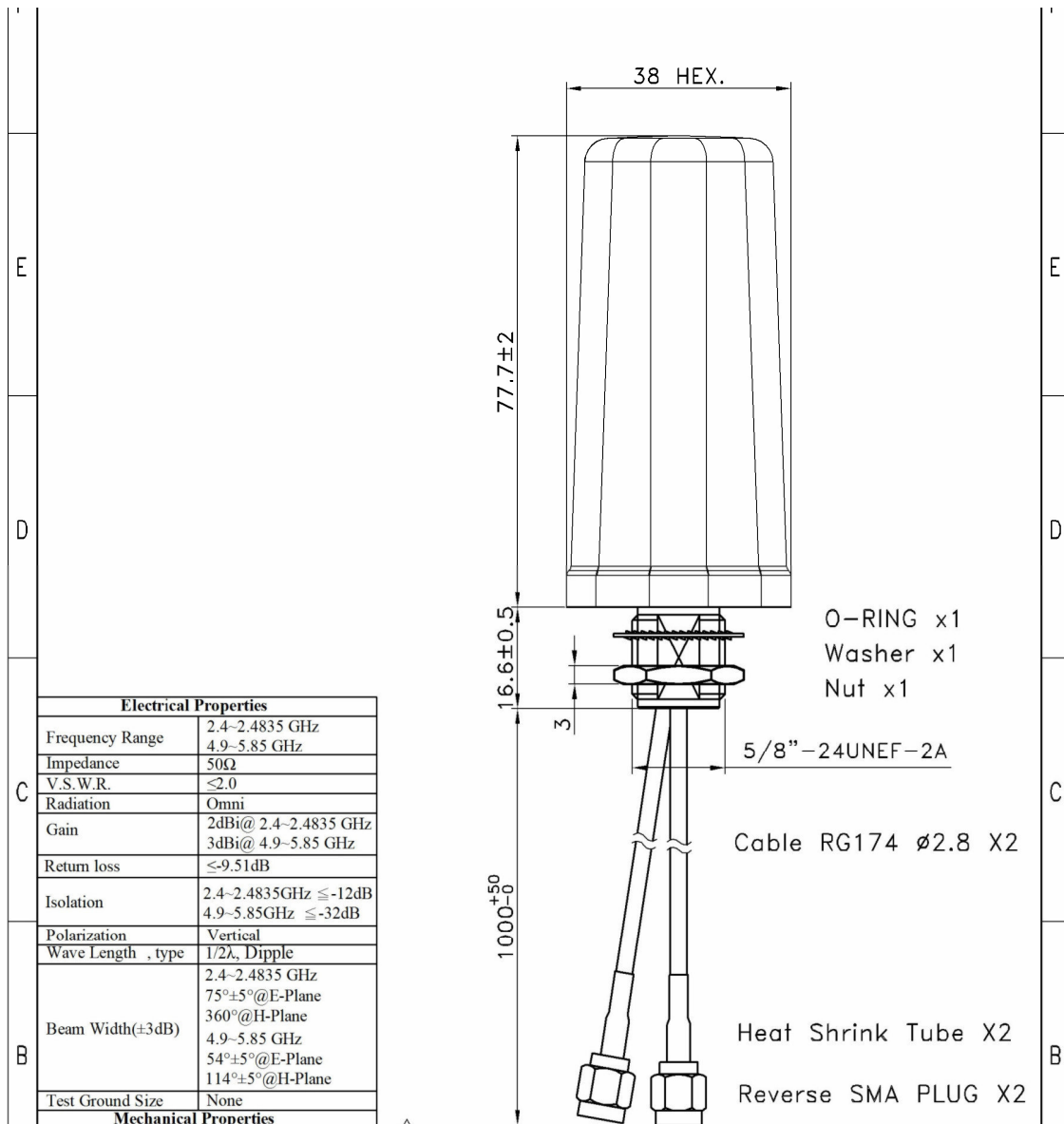

## 2.4G XZ-Plane,Co-Pol

Port 1

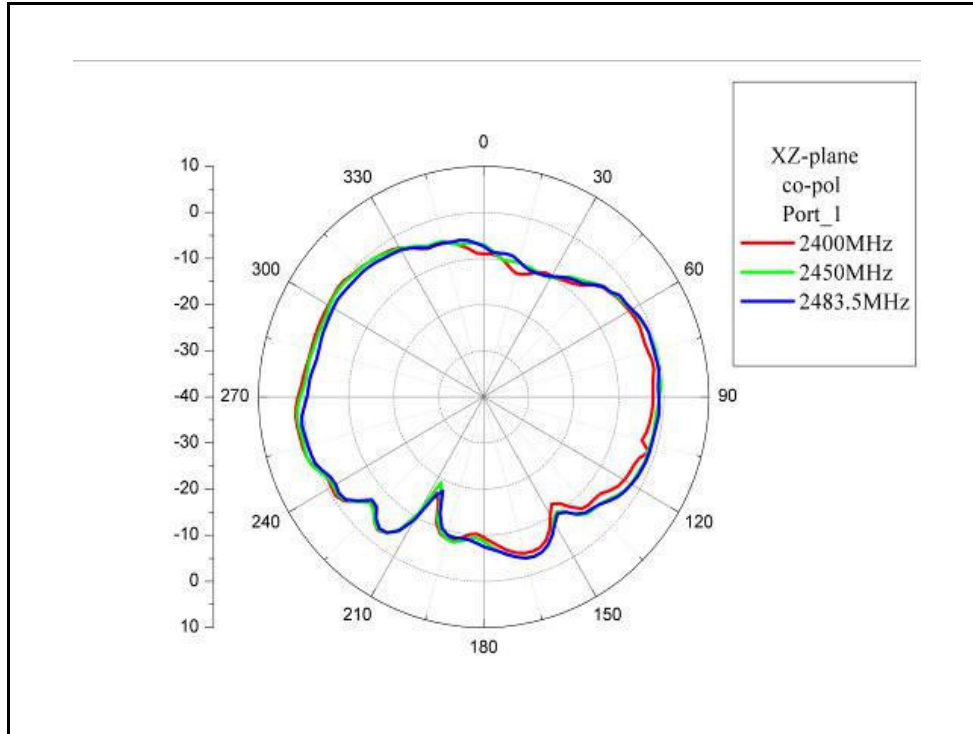

Port 2

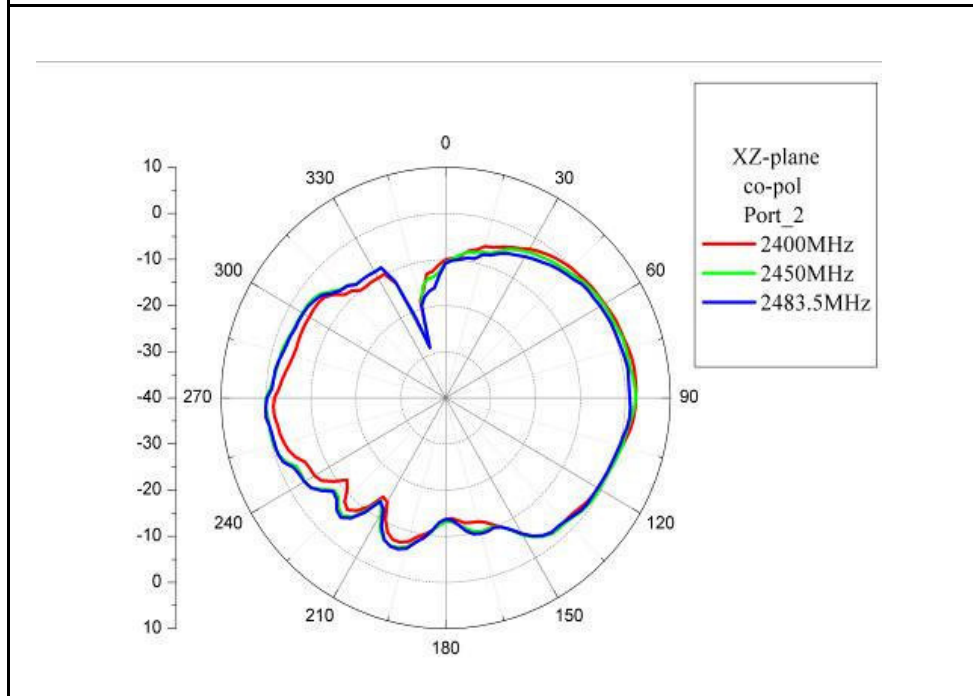

## 2.4G XZ-Plane,Cross-Pol

Port 1

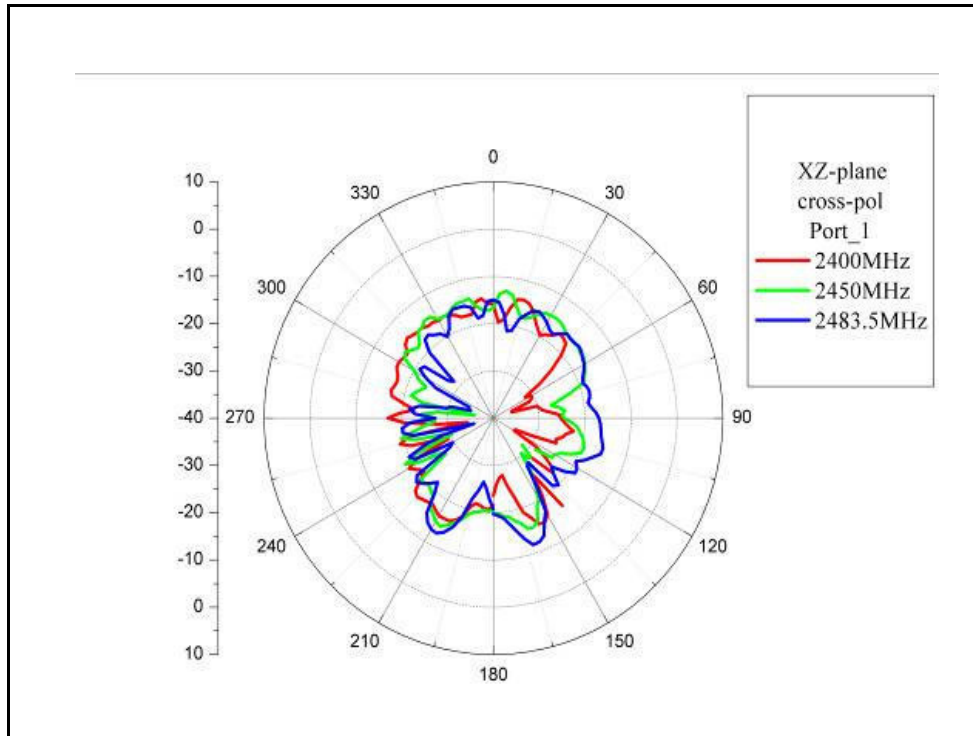

Port 2

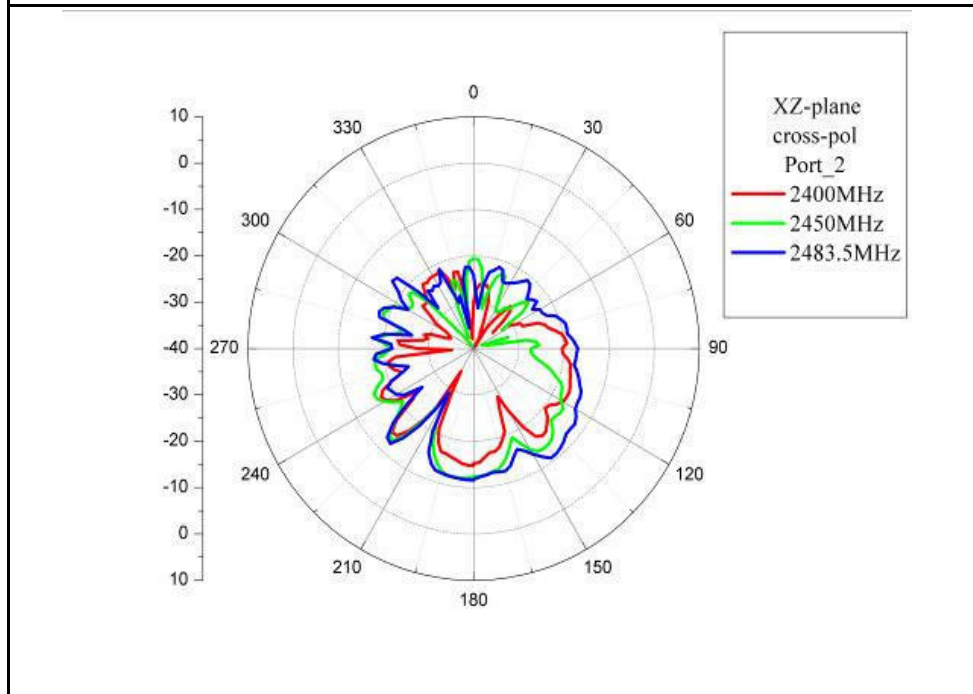

## 2.4G YZ-Plane,Co-Pol

Port 1

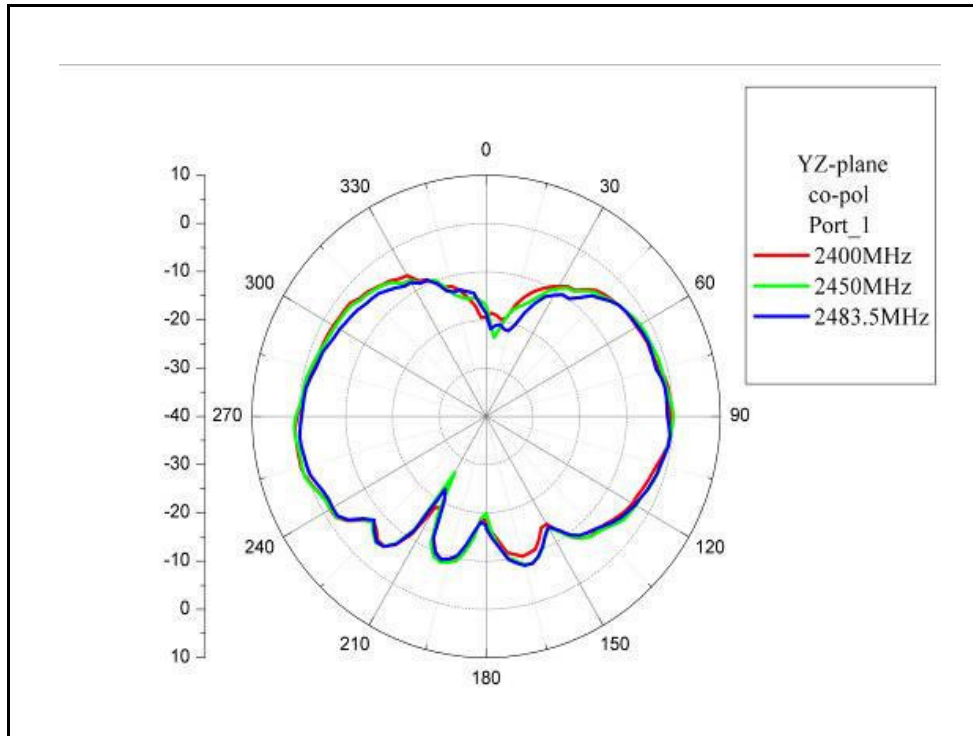

Port 2

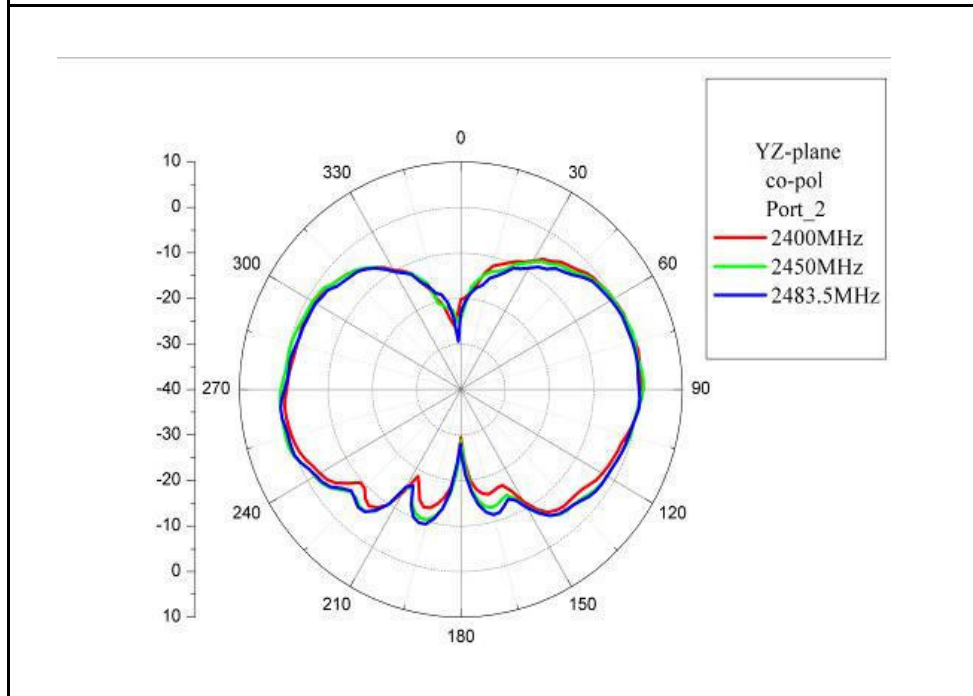

## 2.4G YZ-Plane,Cross-Pol

Port 1

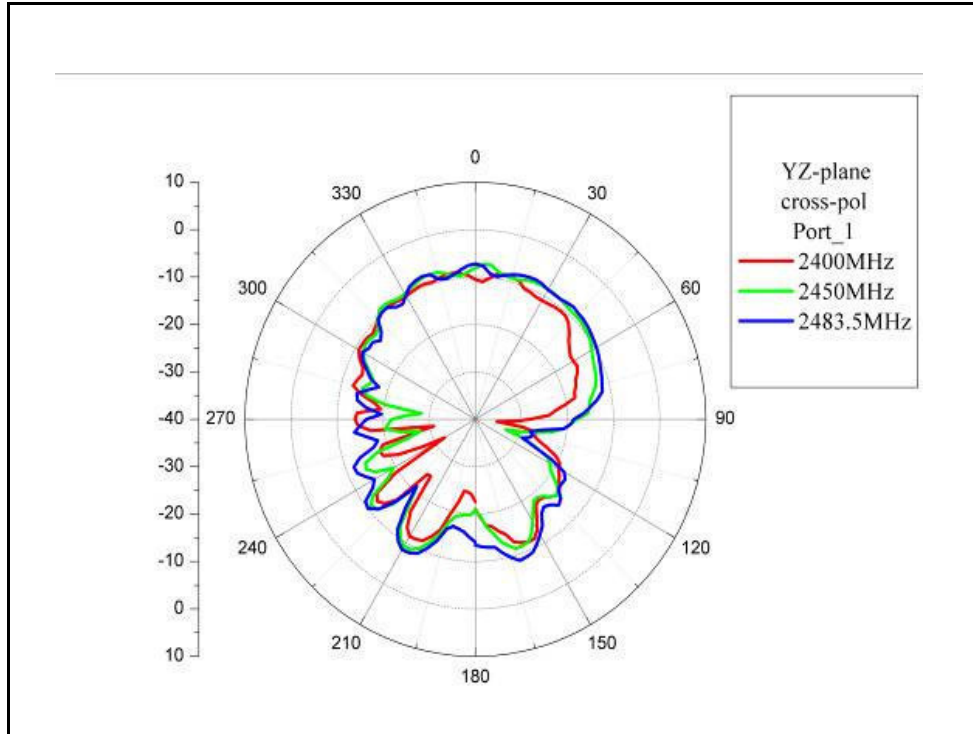

Port 2

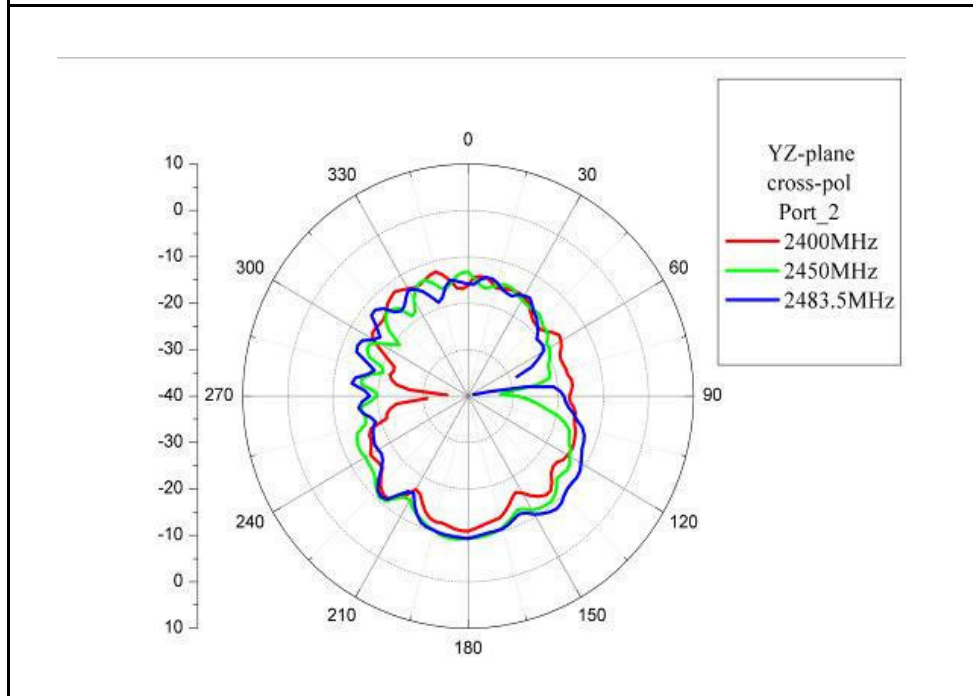

## 2.4G XY-Plane, Co-Pol

Port 1

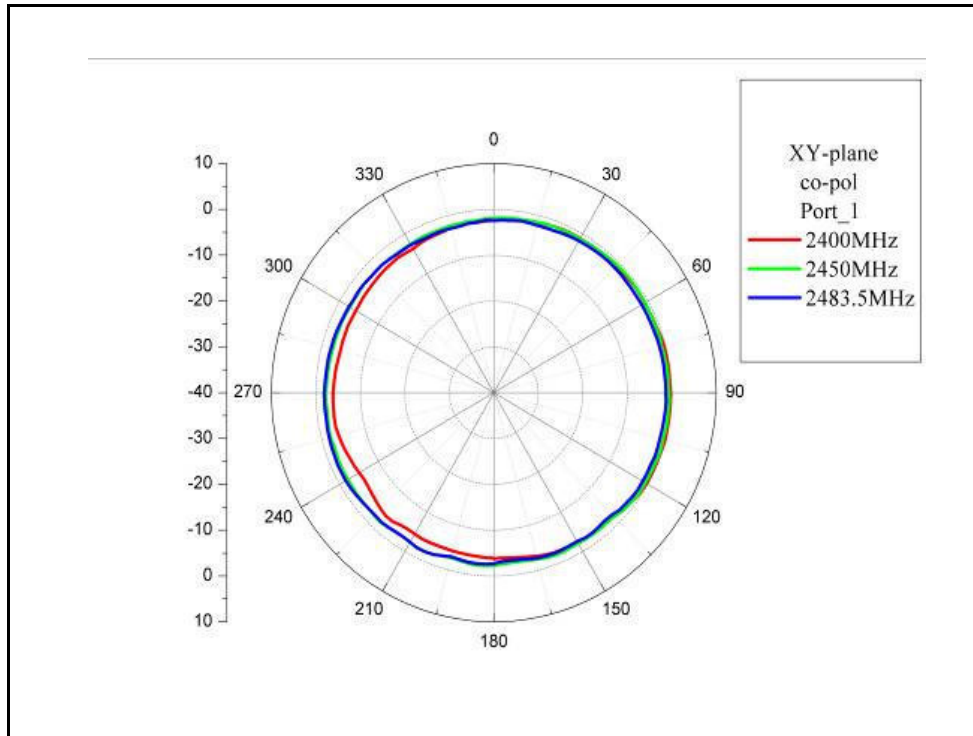

Port 2

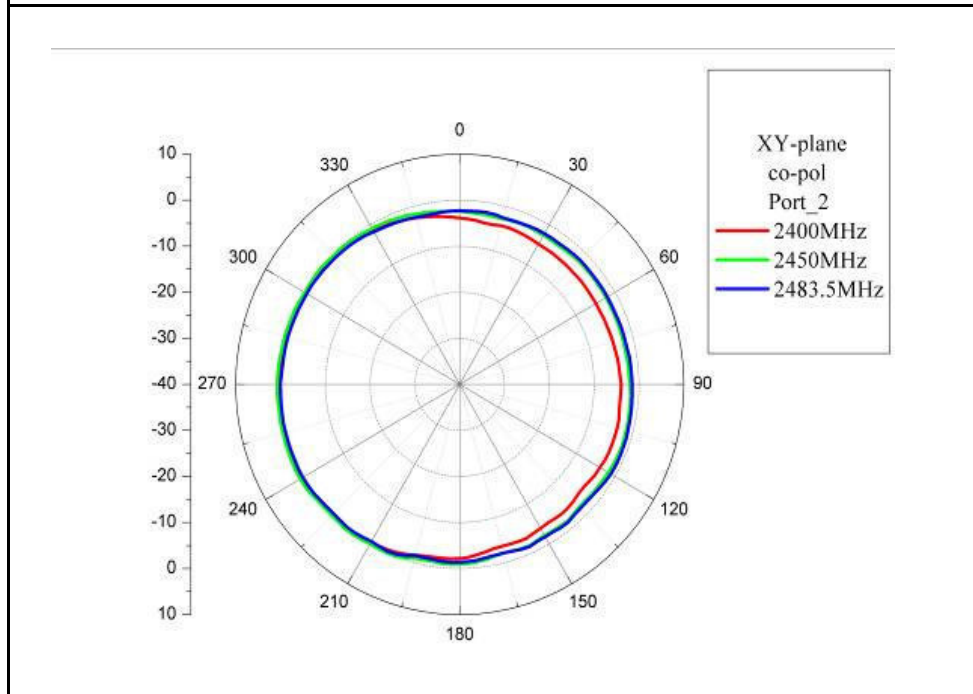

## 2.4G XY-Plane,Cross-Pol

Port 1

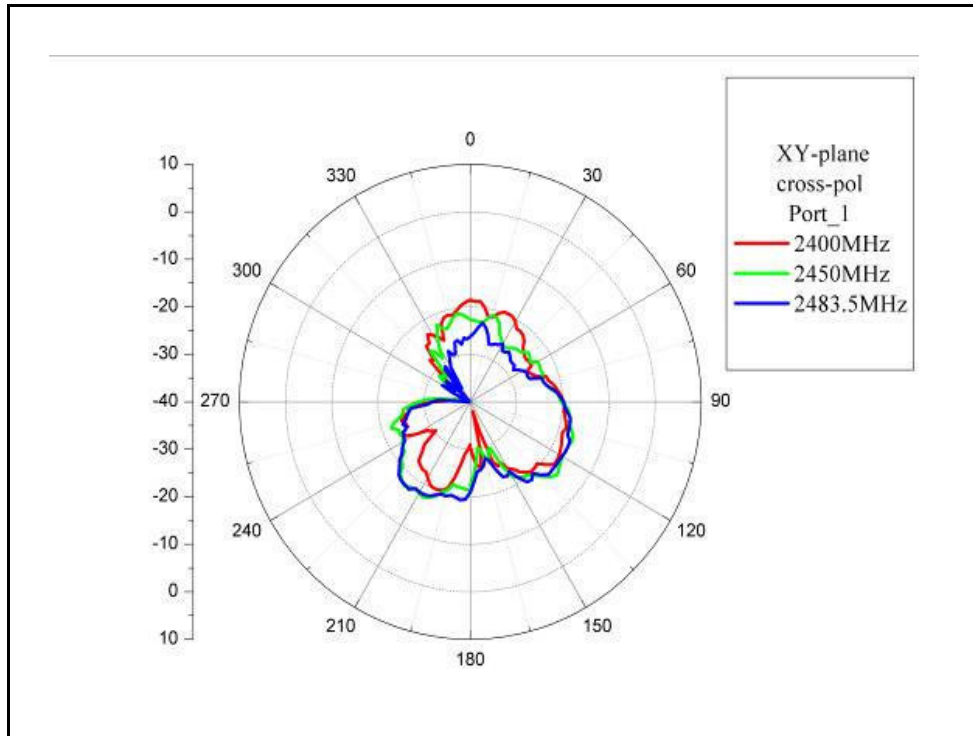

Port 2

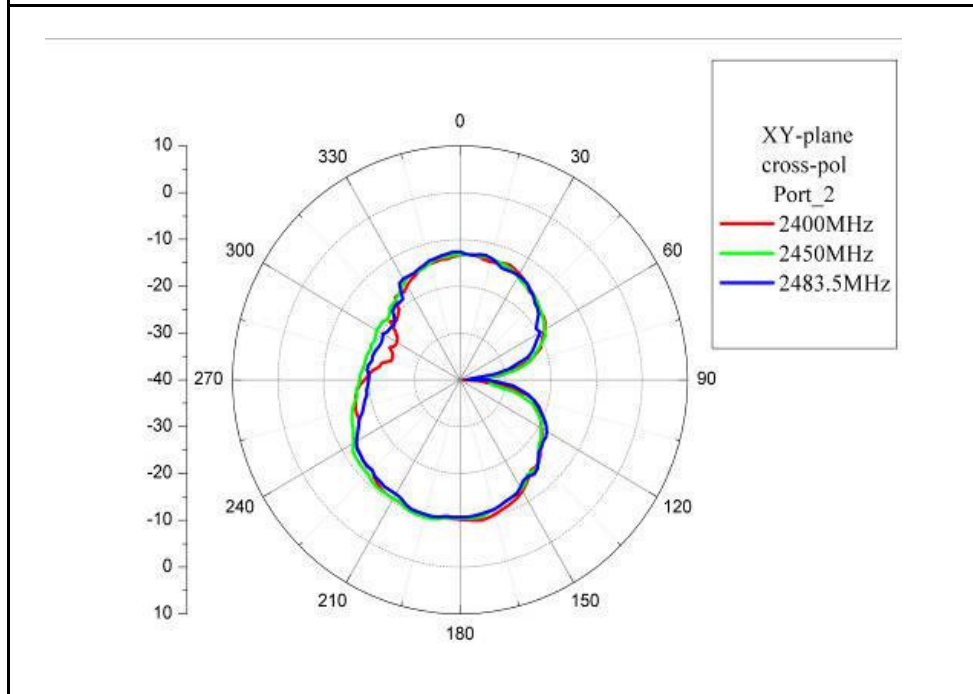

# 5G XZ-Plane,Co-Pol

Port 1

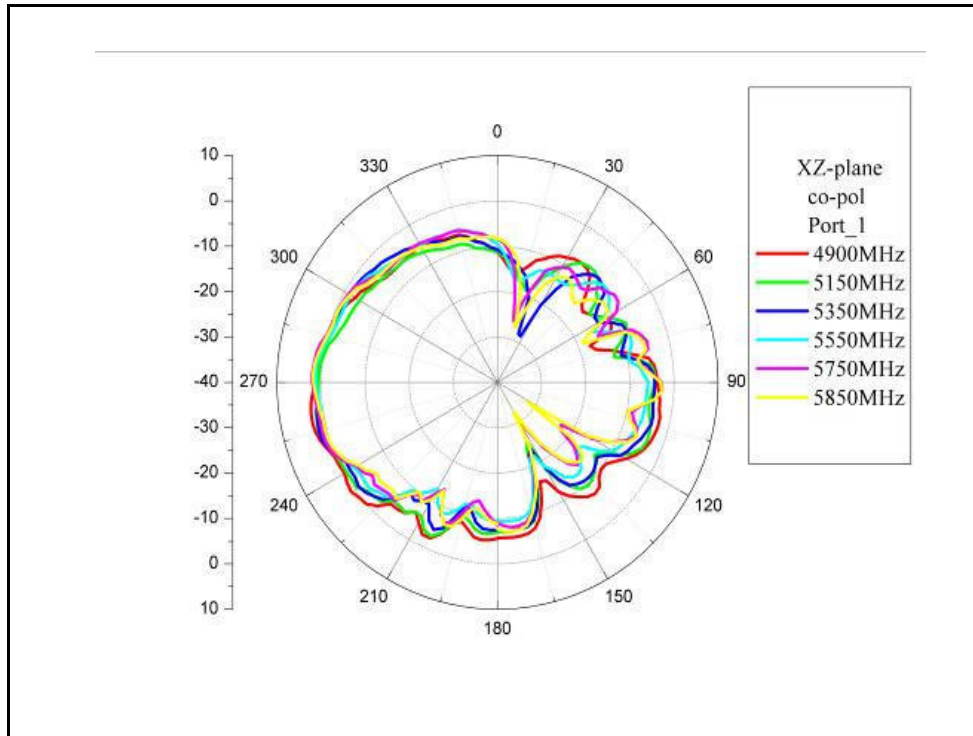

Port 2

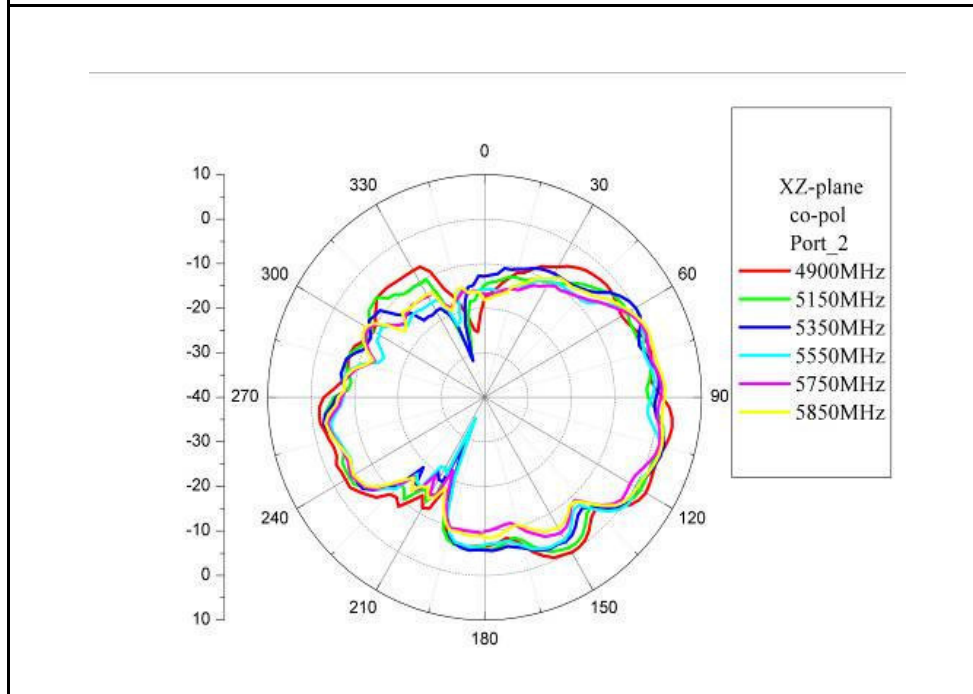



# 5G XZ-Plane,Cross-Pol

Port 1

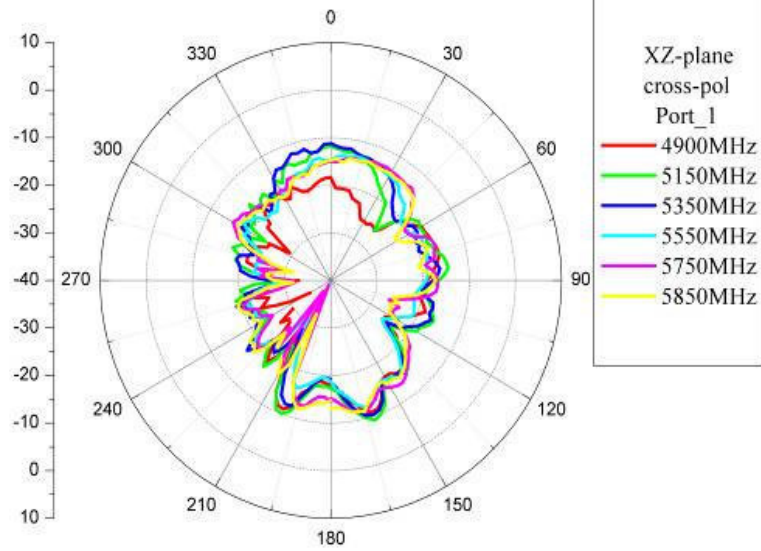

Port 2

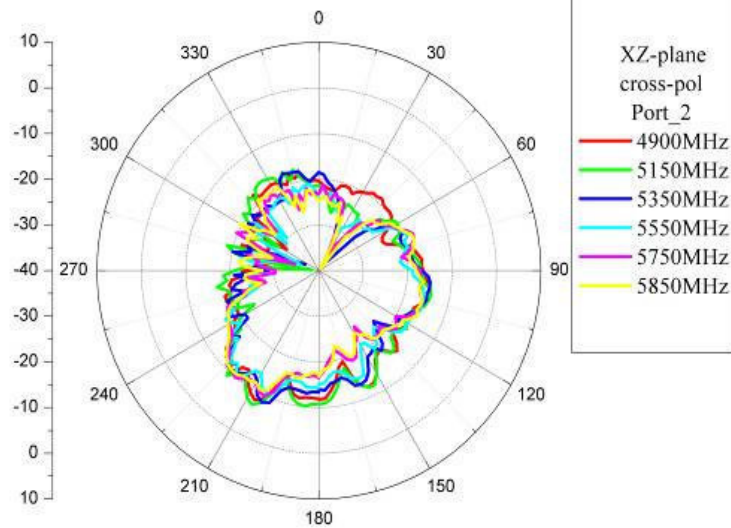

# 5G YZ-Plane,Co-Pol

Port 1

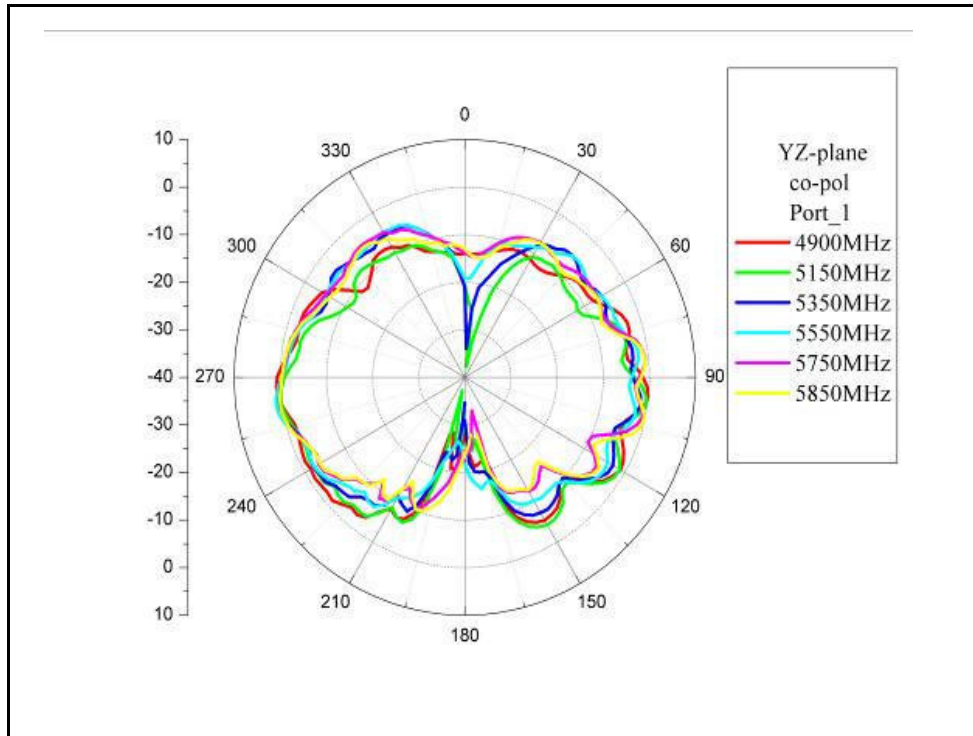

Port 2

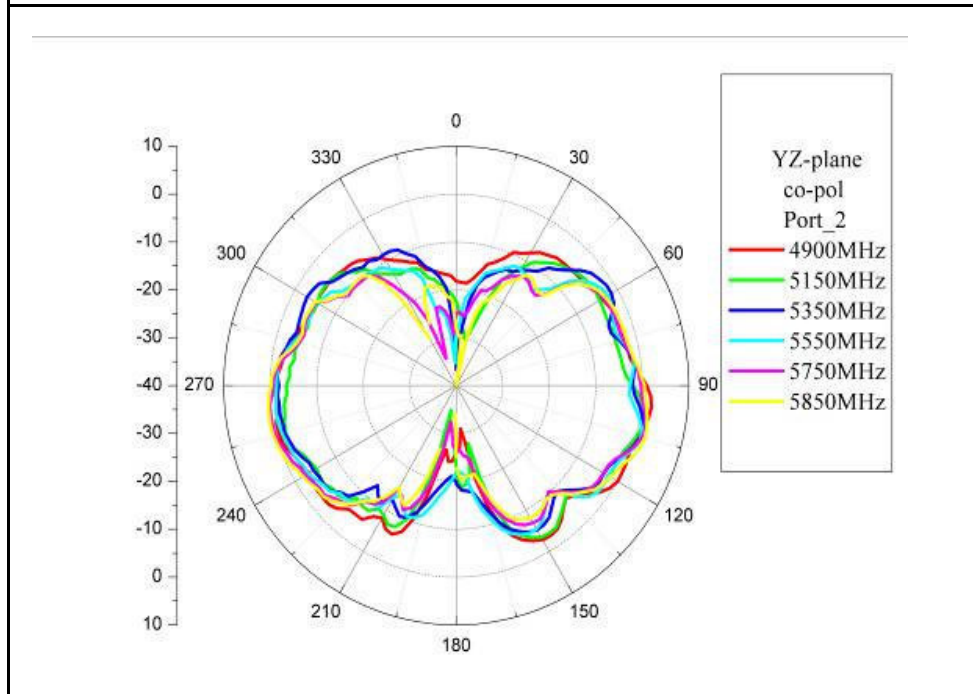

# 5G YZ-Plane,Cross-Pol

Port 1

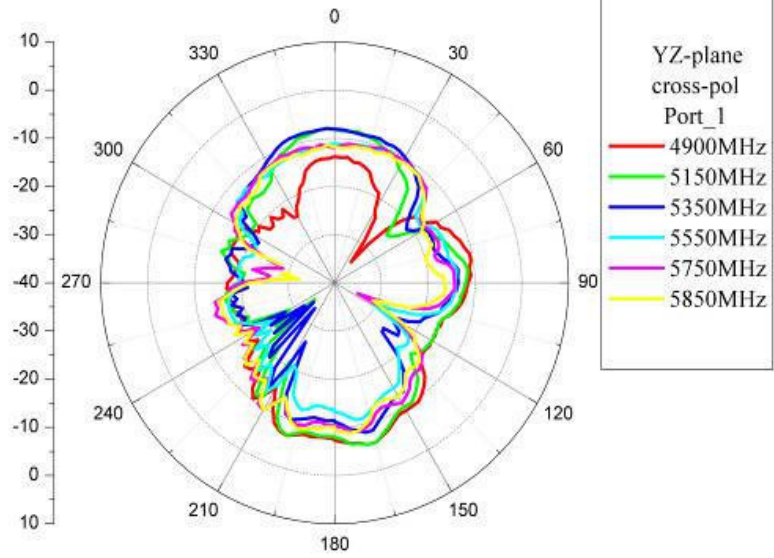

Port 2

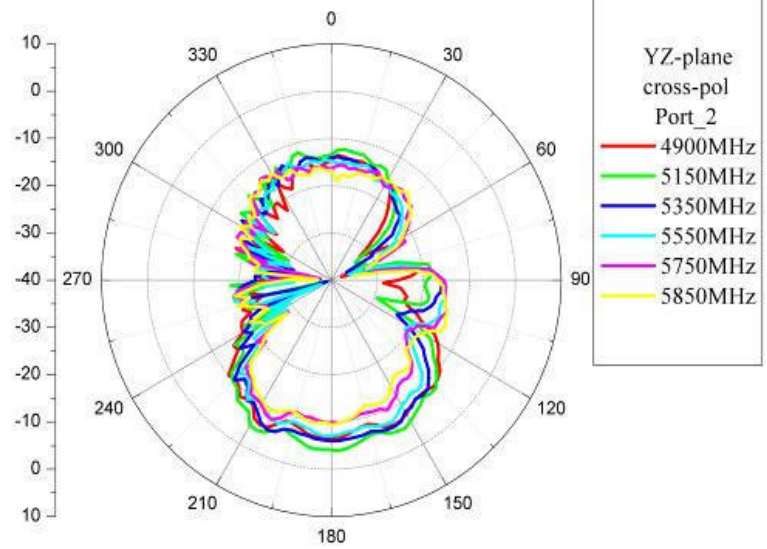

# 5G XY-Plane,Co-Pol

Port 1

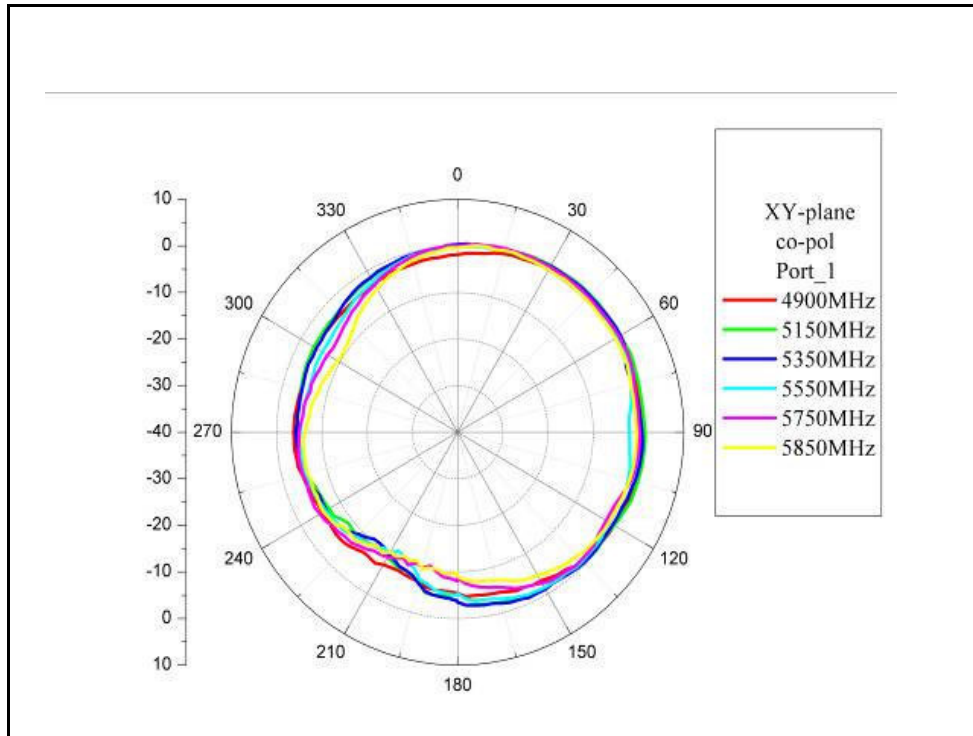

Port 2

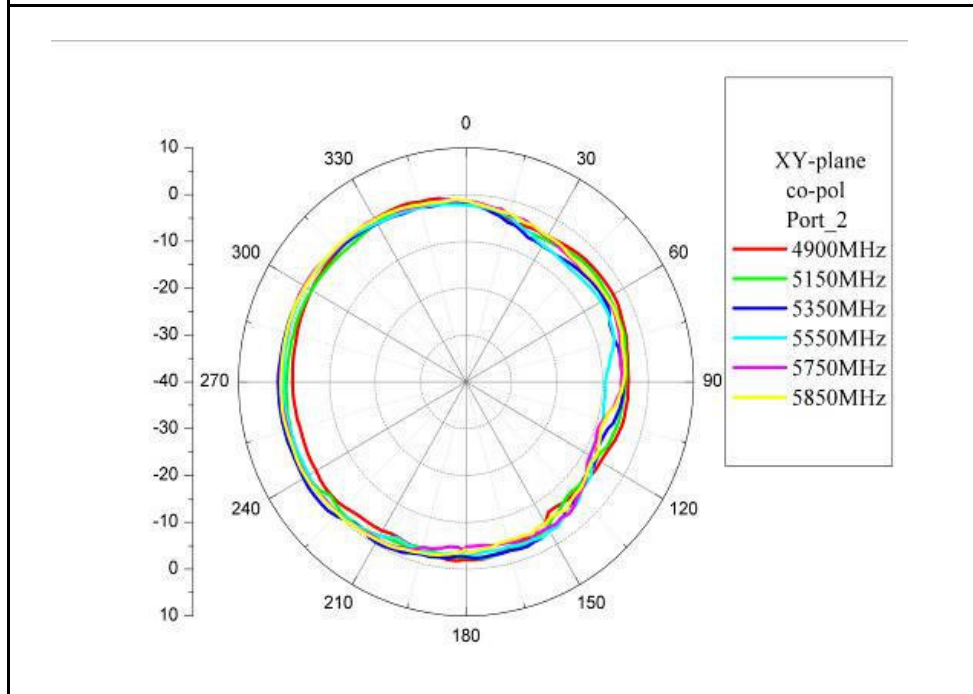

# 5G XY-Plane,Cross-Pol

Port 1

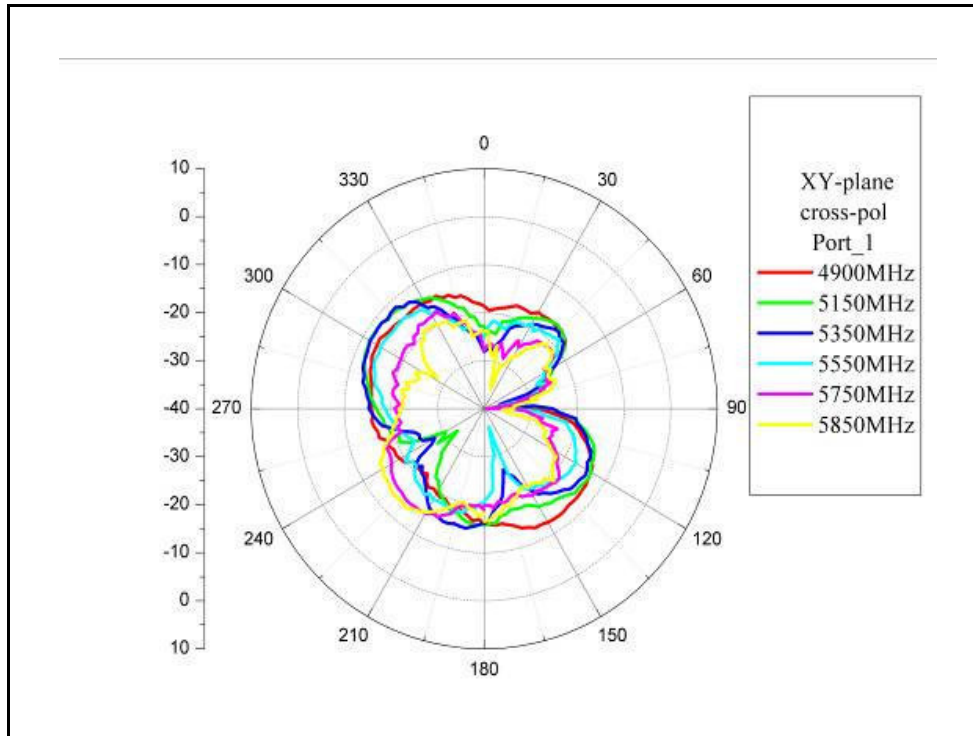

Port 2

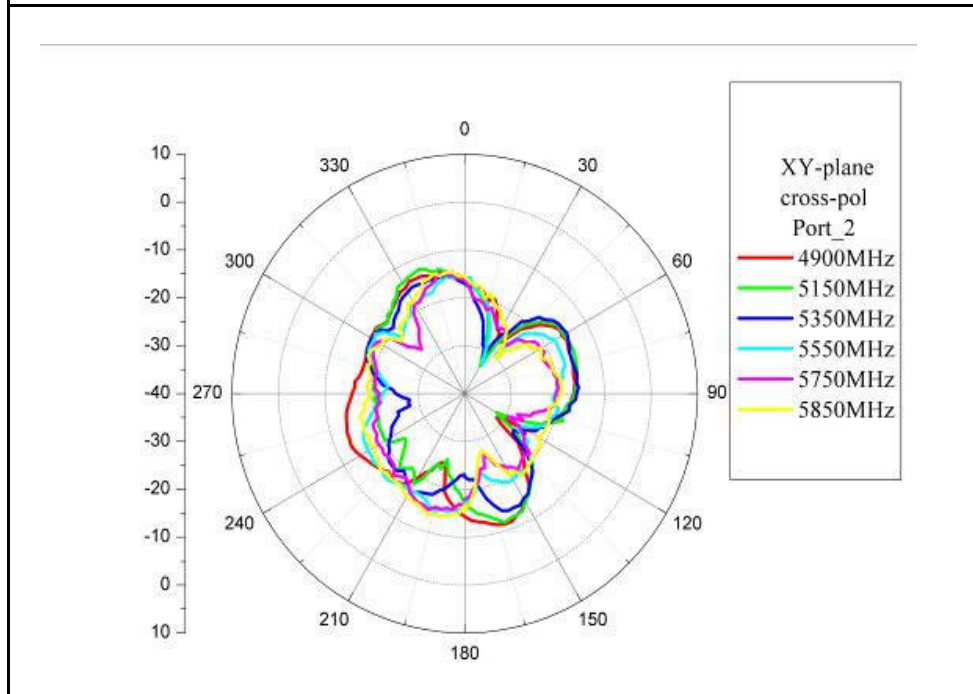

## 2.4G XZ-Plane, Total

Port 1

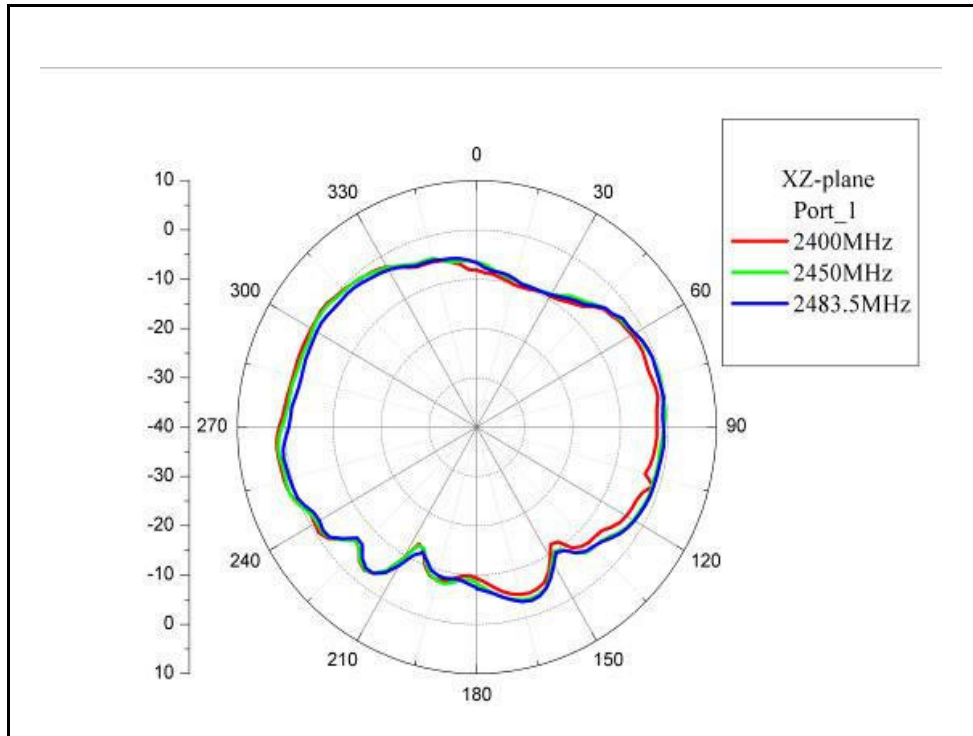

Port 2

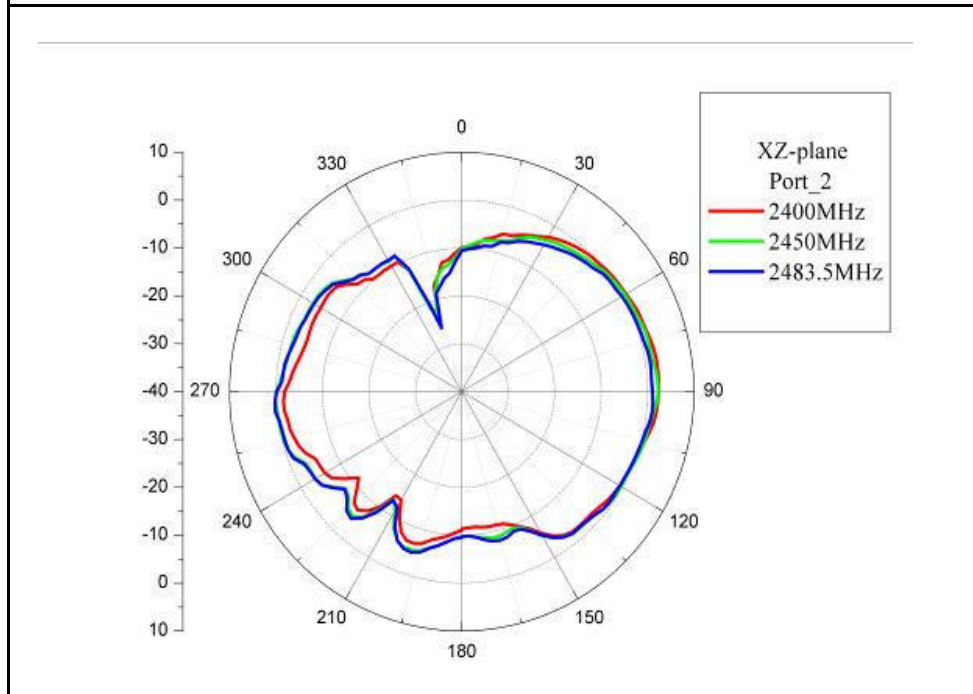

## 2.4G YZ-Plane, Total

Port 1

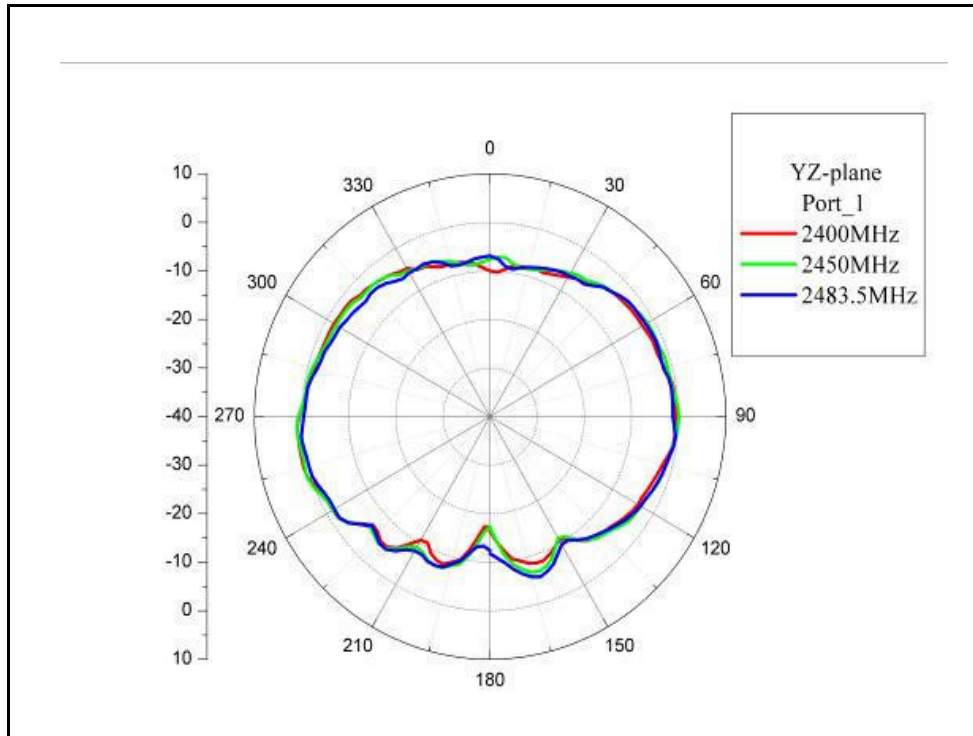

Port 2

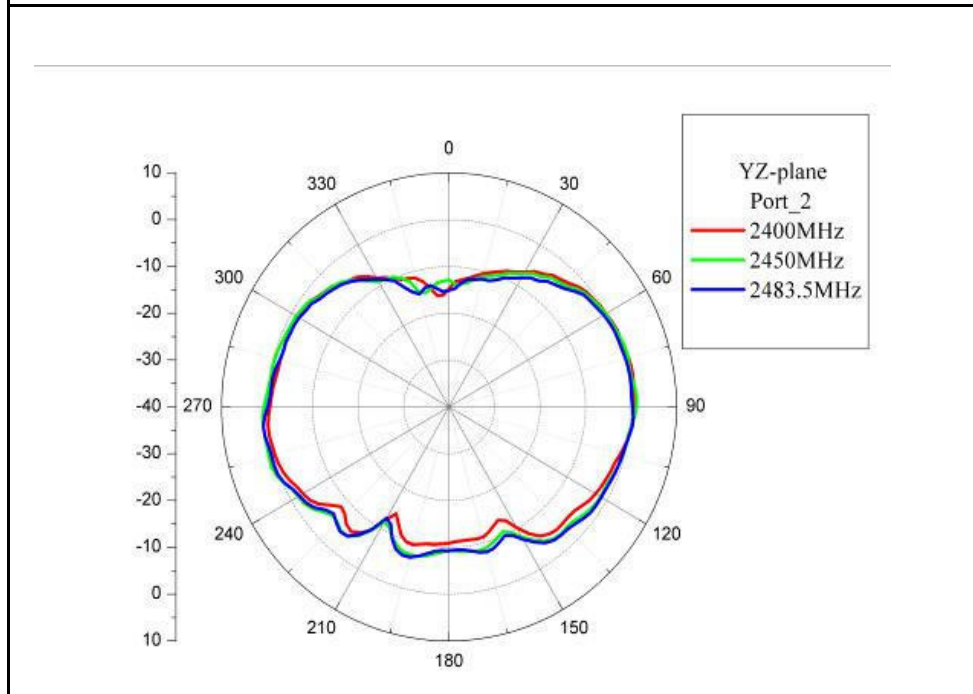

---

---

## 2.4G XY-Plane, Total

---

---

**Port 1**

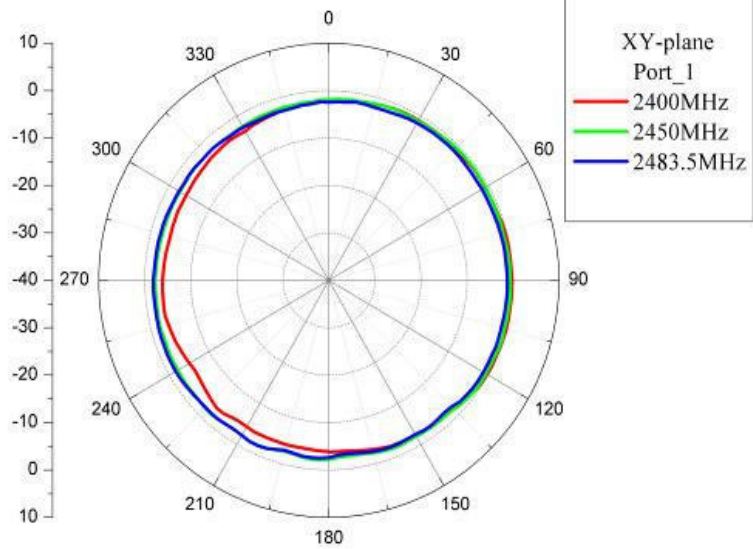

**Port 2**

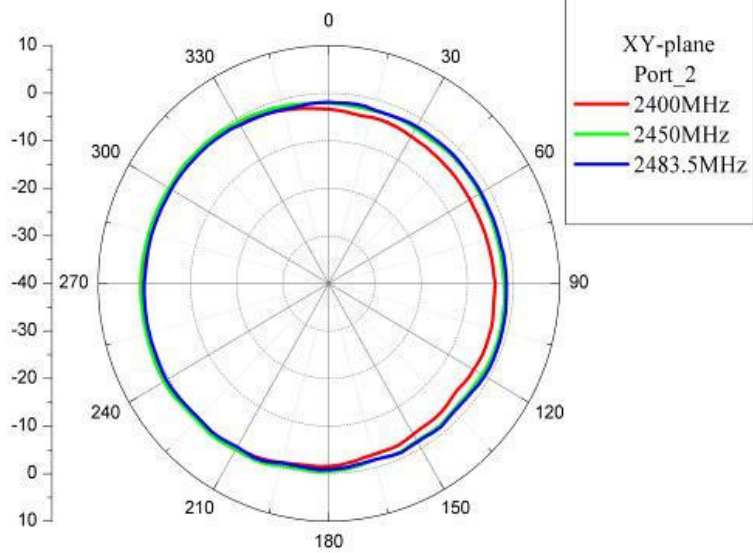



# 5G XZ-Plane, Total

Port 1

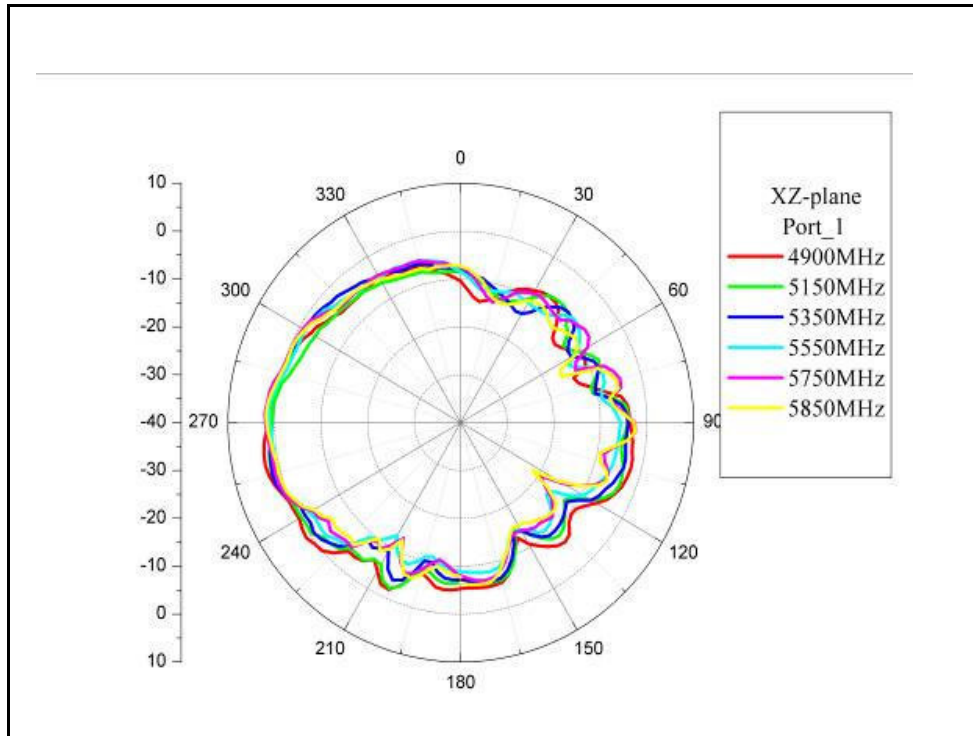

Port 2

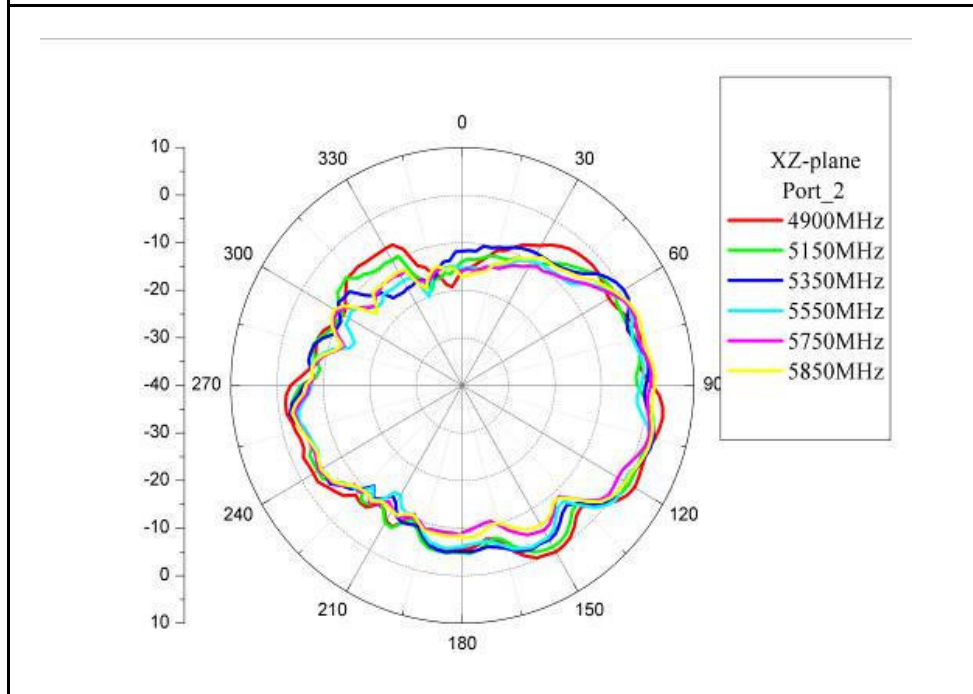

# 5G YZ-Plane,Total

Port 1

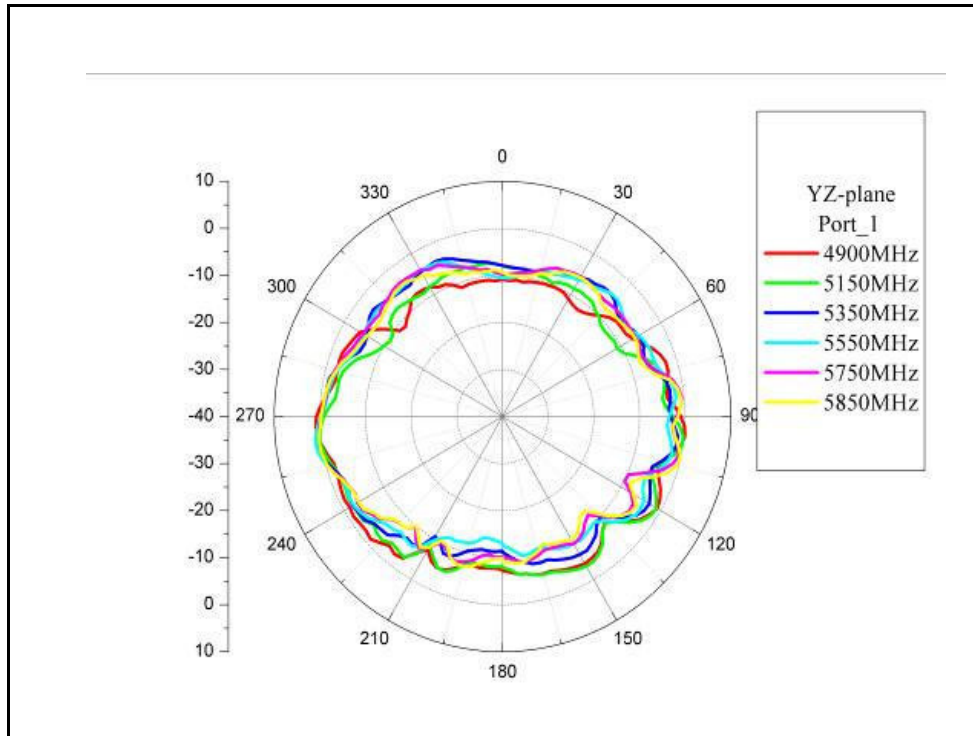

Port 2

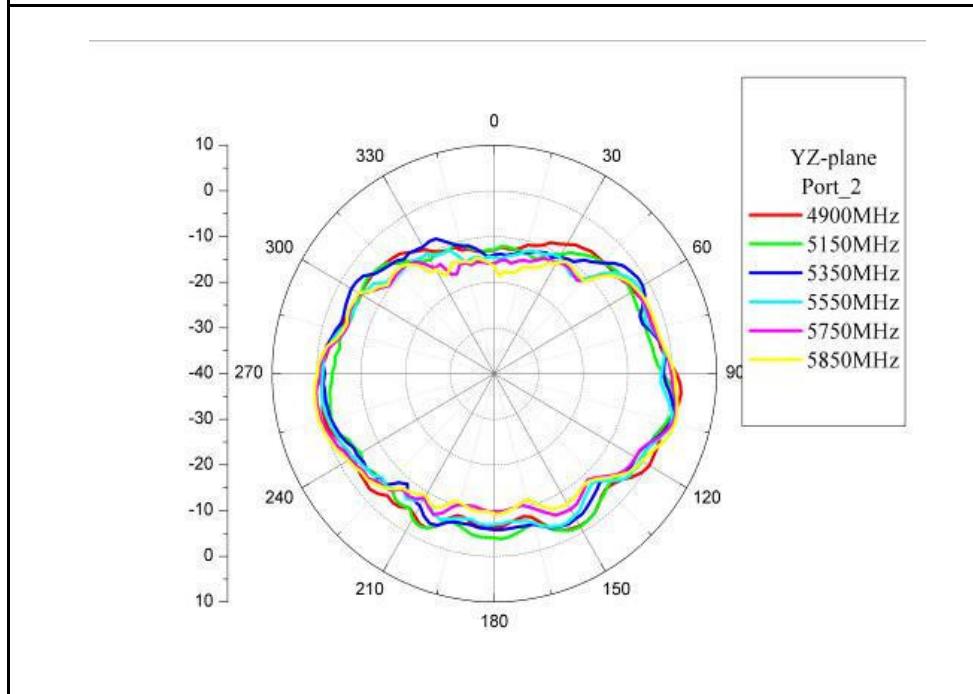

# 5G XY-Plane, Total

Port 1

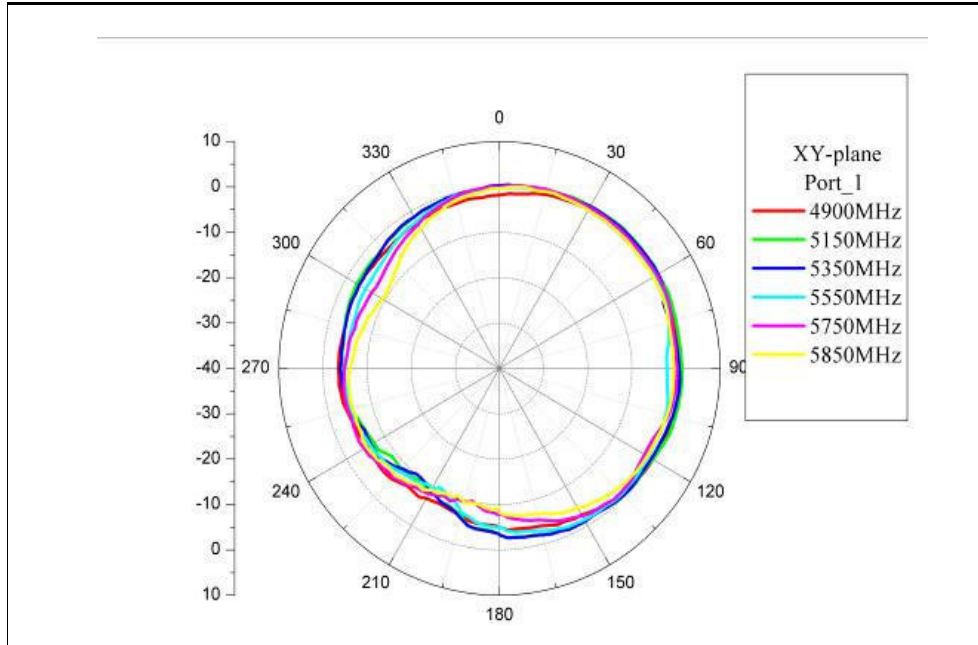

Port 2

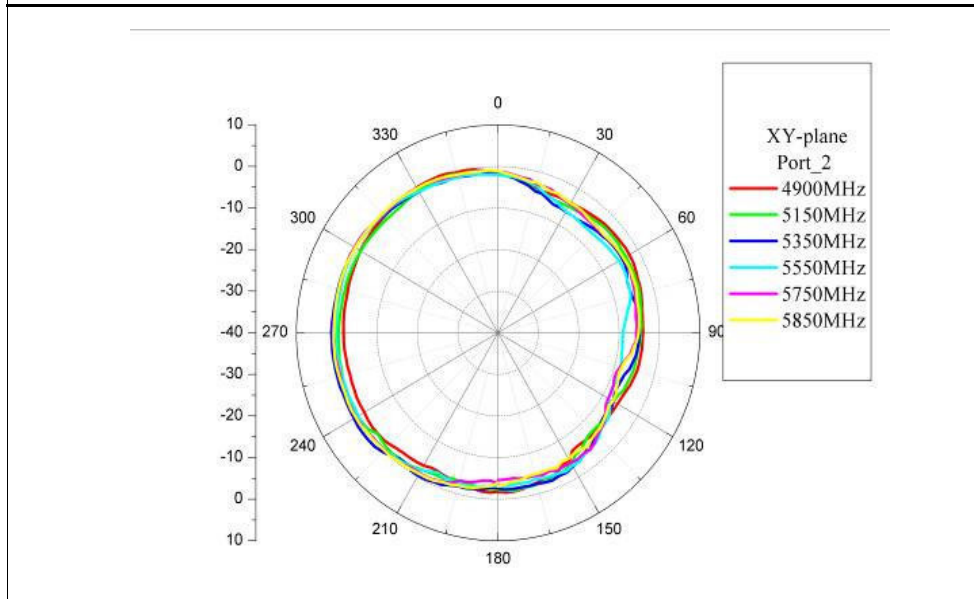

**Total  
Port 1  
(dBi)**

port_1	2400MHz	2450MHz	2483.5MHz
XZ	1.98	1.66	0.85
YZ	0.97	1.04	0.21
XY	-0.12	-0.38	-1.12

**Total  
Port 2  
(dBi)**

port_2	2400MHz	2450MHz	2483.5MHz
XZ	2.45	2.31	1.23
YZ	1.00	1.26	1.02
XY	0.68	1.27	0.61

**Total  
Port 1  
(dBi)**

port_1	4900MHz	5150MHz	5350MHz	5550MHz	5750MHz	5850MHz
XZ	2.87	1.96	1.87	1.20	2.05	1.78
YZ	0.95	0.24	1.03	1.32	0.51	0.51
XY	1.28	1.85	1.59	0.97	1.23	0.58

**Total  
Port 2  
(dBi)**

port_2	4900MHz	5150MHz	5350MHz	5550MHz	5750MHz	5850MHz
XZ	3.80	2.24	2.72	2.26	1.77	2.34
YZ	2.22	1.04	1.12	1.26	1.71	2.10
XY	0.41	0.06	1.35	0.86	1.09	1.07