

# CFR 47 FCC Part 15.407

## DFS TEST REPORT

Product : **IEEE 802.11a/b/g miniPCI module**

Trade Name : MOXA

Model Number : WAPA003

FCC ID : SLE-WAPA003

Prepared for

**MOXA Inc.**

Fl.4, No.135, Lane 235, Pao-Chiao Rd., Shing Tien City, Taipei, R.O.C.

TEL. : +886 2 8919 1230

FAX. : +886 2 8919 1231

Prepared by

**Interocean EMC Technology Corp.**

244 No.5-2, Lin 1, Tin-Fu Tsun, Lin-Kou Hsiang,  
Taipei County, Taiwan, R.O.C.

TEL.: +886 2 2600 6861

FAX.: +886 2 2600 6859

**Remark :**

The test report consists of 37pages in total. It shall not be reproduced except in full, without the written approval of IETC. This document may be altered or revised by IETC only, and shall be noted in the revision section of the document.  
The test results in the report only to the tested sample.

Report Issued: 2009/06/30

Project Engineer: Anya lee  
Anya Lee

Approved: Jerry Liu  
Jerry Liu

# Table of Contents

<b>1</b>	<b>General Information</b>	<b>3</b>
1.1	Description of Equipment Under Test	3
1.2	Test Equipment	4
1.3	Test peripheral	4
1.4	STATEMENT OF COMPLIANCE	4
1.5	DEVIATIONS FROM THE STANDARD	4
<b>2</b>	<b>Dynamic Frequency Selection (DFS) test</b>	<b>5</b>
2.1	Operating environment	5
2.2	UNII Device Description	5
2.3	Operating mode	5
2.4	Test Protocol and Requirement	6
2.5	DFS Detection Thresholds and Limitations of each Parameter	7
2.6	Radar Test Waveforms	7
2.7	Radar Waveform Calibration	11
2.8	Test setup	16
2.9	DFS Test summary	16
2.10	DFS test result	16
<b>3</b>	<b>Photographs of Test</b>	<b>37</b>
3.1	DFS Test Measurement	37

# 1 General Information

## 1.1 Description of Equipment Under Test

- Product** : IEEE 802.11a/b/g miniPCI module
- Model Number** : WAPA003
- Applicant** : **MOXA Inc.**  
Fl.4, No.135, Lane 235, Pao-Chiao Rd., Shing Tien City, Taipei, R.O.C.
- Manufacturer** : **MOXA Inc.**  
Fl.4, No.135, Lane 235, Pao-Chiao Rd., Shing Tien City, Taipei, R.O.C.
- Operating Frequency** : 5180MHz~5240MHz; 5260MHz~5320MHz; 5500MHz~5700MHz
- Channel Number** : Refer to section 1.2
- Type of Modulation** : OFDM
- Antenna Description** : The product contains 3 sets of antenna. One set antenna only support 2.4GHz band others antenna contain dual band (2.4GHz and 5GHz). Those antenna information as below.

Model No.	Frequency Band	Antenna Type	Antenna Gain
SMA-Male-RP	2.4GHz / 5GHz	Dipole	2dBi
ANT-WSB-ANM-05 Black	2.4GHz	Dipole	5dBi
ANT-WDB-ANM-0609	2.4GHz / 5GHz	Dipole	6dBi / 9dBi

When the device equipped with single band antenna (2.4GHz band only), then the 5GHz band function will be disabled.

- Sample Receive date** : May 14, 2009
- Date of Test** : Jun. 22 ~ Jun. 23, 2009
- Additional Description** : 1.) The EUT is **IEEE 802.11a/b/g miniPCI module**.  
2.) The test model is "**WAPA003**" and included in this report.  
3.) For more detail specification about EUT, please refer to the user's manual.

## 1.2 Test Equipment

Instrument	Manufacturer	Model	Serial No.	Next Cal. Date
Spectrum Analyzer	Rohde & Schwarz	FSEK 30	100186	2009/1/17
WiMAX ESG Vector Signal Generator	Agilent	E4438C	MY45094290	2009/5/6
WiMAX ESG Vector Signal Generator	Agilent	E4438C	MY45094140	2009/5/6

Note: The above equipments are within the valid calibration period.

## 1.3 Test peripheral

Instrument	Manufacturer	Model	FCC ID
Master AP	Cisco-Linksys	AIR-AP1242AG-A-K9	LDK102056

## 1.4 STATEMENT OF COMPLIANCE

The tested sample complied with the DFS requirements of:

FCC Part 15.407(h)(2)

Maintenance of compliance is the responsibility of the manufacturer. Any modifications to the product should be assessed to determine their potential impact on the compliance status of the device with respect to the standards detailed in this test report.

## 1.5 DEVIATIONS FROM THE STANDARD

No deviations were made from the test methods and requirements covered by the scope of this report.

## 2 Dynamic Frequency Selection (DFS) test

### 2.1 Operating environment

Ambient temperature : 26°C

Relative humidity : 56%

### 2.2 UNII Device Description

2.2.1 The Master device operates in the following UNII bands:

a. 5150-5250 MHz

b. 5250-5350 MHz

c. 5470-5725 MHz

d. 5725-5825 MHz

2.2.2 Client (Slave) EUT:

Operating mode:

The EUT was defined as the client without radar detection function.

There are no “ad-hoc” or “peer-to-peer” mode for this device (please refer the declaration letter).

Associating peripheral:

The device was set up to associate with the master device (Model Name : AIR-AP1242AG-A-K9).

2.2.3 The maximum EIRP of this device is 23.33 dBm from UNII band. This device doesn't exceed 27dBm EIRP, so no transmit power control is implemented.

2.2.4 Below are the available 50 ohm antenna assemblies and their corresponding gains. 0dBi gain was used to set the -61dBm threshold level (-62dBm+1dB) during calibration of the conducted test setup.

### 2.3 Operating mode

Performance was measured at an active frequency of 5320 and 5520MHz

One laptop PC is connected to the AP via a wire Ethernet connection. A separate laptop PC is used as a host computer for the Station. The AP and the Station transmit output levels are set to normal operating condition.

System architectures were used under **IP based mode**.

## 2.4 Test Protocol and Requirement

- 2.4.1 For a Master Device, the DFS conformance requirement will be verified utilizing one short pulse radar type. Additionally, the Channel Move Time and Channel Closing Transmission Time requirements will be verified utilizing the long pulse radar type. The statistical performance check will be verified utilizing all radar type.
- 2.4.2 For a Client Device without DFS, the channel move time and channel closing transmission time requirements will be verified with one short pulse radar type.  
 For testing a Client Device with In-Service Monitoring, two configurations must be tested.
- a. The Client Device detects the radar waveform:  
 The channel move time and channel closing transmission time requirements will be verified utilizing short pulse radar type and the long pulse radar type. The statistical performance check will be verified utilizing all radar types.
  - b. The Master Device detects the radar waveform:  
 The channel move time and channel closing transmission time requirements will be verified utilizing short pulse radar type.
- 2.4.3 A UNII network will employ a DFS function to:
- detect signals from radar systems and to avoid co-channel operation with these systems
  - provide on aggregate a Uniform Spreading of the Operating Channels across the entire band. This applies to the 5250-5350 MHz and/ or 5470-5725 MHz bands.
- 2.4.4 Within the context of the operation of the DFS function, a UNII device will operate in either Master Mode or Client Mode. UNII devices operating in Client Mode can only operate in a network controlled by a UNII device operating in Master Mode.  
 The tables as below summarize the information contained.

### Applicability of DFS Requirements Prior to Use of a Channel

Requirement	Operational Mode		
	Master	Client Without Radar Detection	Client With Radar Detection
Non-Occupancy Period	Yes	Not required	Yes
DFS Detection Threshold	Yes	Not required	Yes
Channel Availability Check Time	Yes	Not required	Not required
Uniform Spreading	Yes	Not required	Not required
UNII Detection Bandwidth	Yes	Not required	Yes

### Applicability of DFS requirements during normal operation

Requirement	Operational Mode		
	Master	Client Without Radar Detection	Client With Radar Detection
DFS Detection Threshold	Yes	Not required	Yes
Channel Closing Transmission Time	Yes	Yes	Yes
Channel Move Time	Yes	Yes	Yes
UNII Detection Bandwidth	Yes	Not required	Yes

## 2.5 DFS Detection Thresholds and Limitations of each Parameter

Maximum Transmit Power	Value (See Notes 1 and 2)
$\geq 200$ mW	-64 dBm
$\leq 200$ mW	-62 dBm

Note 1: This is the level at the input of the receiver assuming a 0 dBi receive antenna.  
 Note 2: Throughout these test procedures an additional 1 dB has been added to the amplitude of the test transmission waveforms to account for variations in measurement equipment. This will ensure that the test signal is at or above the detection threshold level to trigger a DFS response.

Parameter	Value
Non-occupancy Period	Minimum 30 minutes
Channel Availability Check Time	60 seconds
Channel Move Time	10 seconds (See Note 1)
Channel Closing Transmission Time	200 milliseconds + an aggregate of 60 milliseconds over remaining 10 second period (See Note 1 and 2)
UNII Detection Bandwidth	Minimum 80% of the UNII 99% transmission power bandwidth. (See Note 3)

Note 1: The instant that the Channel Move Time and the Channel Closing Transmission Time begins is as follows:

- For the Short Pulse Radar Test Signals this instant is the end of the Burst.
- For the Frequency Hopping radar Test Signal, this instant is the end of the last radar Burst generated.
- For the Long Pulse Radar Test Signal this instant is the end of the 12 second period defining the Radar Waveform.

Note 2: The Channel Closing Transmission Time is comprised of 200 milliseconds starting at the beginning of the Channel Move Time plus any additional intermittent control signals required to facilitate a Channel move (an aggregate of 60 milliseconds) during the remainder of the 10 second period. The aggregate duration of control signals will not count quiet periods in between transmissions.

Note 3: During the U-NII Detection Bandwidth detection test, radar type 1 is used and for each frequency step the minimum percentage of detection is 90 percent. Measurements are performed with no data traffic.

## 2.6 Radar Test Waveforms

2.6.1 This section provides the parameters for required test waveforms, minimum percentage of successful detections, and the minimum number of trials that must be used for determining DFS conformance. Step intervals of 0.1 microsecond for Pulse Width, 1 microsecond for PRI, 1 MHz for chirp width and 1 for the number of pulses will be utilized for the random determination of specific test waveforms.

**Short Pulse Radar Test Waveforms**

Radar Type	Pulse Width (µsec)	PRI (µsec)	Number of Pulses	Minimum Percentage of Successful Detection	Minimum Number of Trials
1	1	1428	18	60%	30
2	1-5	150-230	23-29	60%	30
3	6-10	200-500	16-18	60%	30
4	11-20	200-500	12-16	60%	30
Aggregate (Radar Types 1-4)				80%	120

2.6.2 A minimum of 30 unique waveforms is required for each of the Short Pulse Radar Type 2 through 4. For Short Pulse Radar Type 1, the same waveform is used a minimum of 30 times. If more than 30 waveforms are used for Short Pulse Radar Type 2 through 4, then each additional waveform must also be unique and not repeated from the previous waveforms.

2.6.3 The aggregate is the average of the percentage of successful detections of Short Pulse Radar Type 1-4.

**Long Pulse Radar Test Waveforms**

Radar Type	Pulse Width (µsec)	Chirp Width (MHz)	PRI (µsec)	Number of Pulses per Burst	Number of Bursts	Minimum Percentage of Successful Detection	Minimum Number of Trials
5	50-100	5-20	1000-2000	1-3	8-20	80%	30

2.6.4 The parameters for this waveform are randomly chosen. Thirty unique waveforms are required for the Long Pulse radar test signal. If more than 30 waveforms are used for the Long Pulse radar test signal, then each additional waveform must also be unique and not repeated from the previous waveforms.

Each waveform is defined as follows:

1. The transmission period for the Long Pulse Radar test signal is 12 second.
2. There are a total of 8 to 20 Bursts in the 12 second period, with the number of Bursts being randomly chosen. This number is Burst Count.
3. Each Burst consists of 1 to 3 pulses, with the number of pulses being randomly chosen. Each Burst within the 12 second sequence may have a different number of pulses.
4. The pulse width is between 50 and 100 microsecond, with the pulse width being randomly chosen. Each pulse within a Burst will have the same pulse width. Pulses in different Bursts may have different pulse widths.
5. Each pulse has a linear FM chirp between 5 and 20 MHz, with the chirp width being randomly chosen. Each pulse within a Burst will have the same chirp width. Pulses in different Bursts may have different chirp widths. The chirp is centered on the pulse. For example, with radar frequency of 5300 MHz and a 20 MHz chirped signal, the chirp starts at 5290 MHz and ends at 5310 MHz.



6. If more than one pulse is present in a Burst, the time between the pulses will be between 1000 and 2000 microsecond, with the time being randomly chosen. If three pulses are present in a Burst, the time between the first and second pulses is chosen independently of the time between the second and third pulses.
7. The 12 second transmission period is divided into even intervals. The number of intervals is equal to Burst Count. Each interval is of length  $(12,000,000 / \text{Burst Count})$  microseconds. Each interval contains one Burst. The start time for the Burst, relative to the beginning of the interval, is between 1 and  $[(12,000,000 / \text{Burst Count}) - (\text{Total Burst Length}) + (\text{One Random PRI Interval})]$  microsecond, with the start time being randomly chosen. The step interval for the start time is 1 microsecond. The start time for each Burst is chosen independently.

A representative example of a Long Pulse radar test waveform:

1. The total test signal length is 12 second.
2. 8 Bursts are randomly generated for the Burst Count.
3. Burst 1 has 2 randomly generated pulses.
4. The pulse width (for both pulses) is randomly selected to be 75 microsecond.
5. The PRI is randomly selected to be at 1213 microsecond.
6. Bursts 2 through 8 are generated using steps 3 – 5.
7. Each Burst is contained in even intervals of 1,500,000 microseconds. The starting location for Pulse 1, Burst 1 is randomly generated (1 to 1,500,000 minus the total Burst 1 length + 1 random PRI interval) at the 325, 001 microsecond step. Bursts 2 through 8 randomly fall in successive 1,500,000 microsecond intervals (i.e. Burst 2 falls in the 1,500,001 – 3,000,000 microsecond range).

*Graphical Representation of a Long Pulse radar Test Waveform*

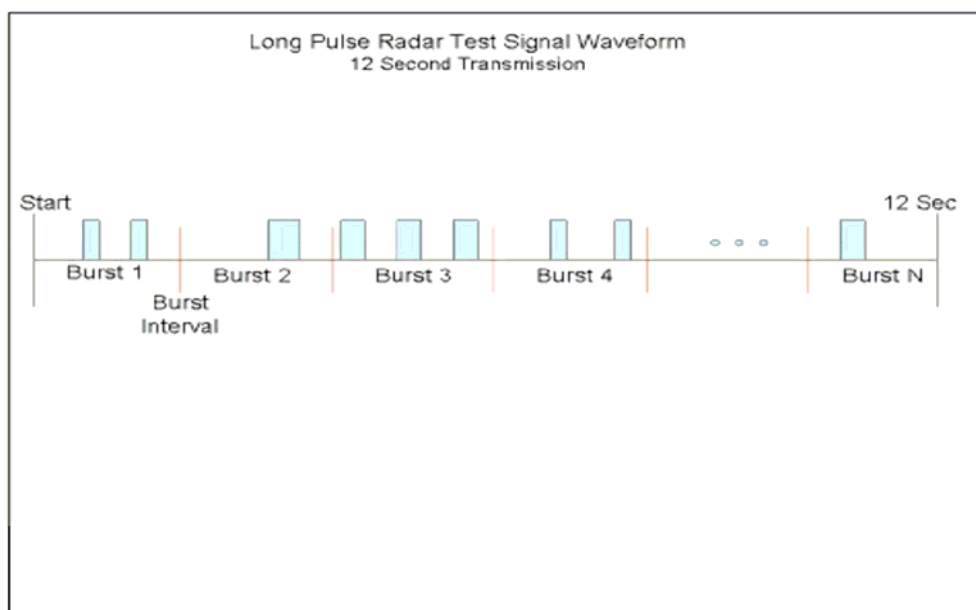

**Frequency Hopping Radar Test Waveforms**

Radar Type	Pulse Width ( $\mu$ sec)	PRI ( $\mu$ sec)	Pulses per Hop	Hopping Rate (kHz)	Hopping Sequence Length (msec)	Minimum Percentage of Successful Detection	Minimum Number of Trials
6	1	333	9	0.333	300	70%	30

2.6.5 For the Frequency Hopping Radar Type, the same *Burst* parameters are used for each waveform.

2.6.6 The hopping sequence is different for each waveform and a 100-length segment is selected<sup>1</sup> from the hopping sequence defined by the following algorithm:  
 The first frequency in a hopping sequence is selected randomly from the group of 475 integer frequencies from 5250 – 5724 MHz. Next, the frequency that was just chosen is removed from the group and a frequency is randomly selected from the remaining 474 frequencies in the group. This process continues until all 475 frequencies are chosen for the set. For selection of a random frequency, the frequencies remaining within the group are always treated as equally likely.

## 2.7 Radar Waveform Calibration

The following equipment setup was used to calibrate the conducted radar waveform. A spectrum analyzer is used to establish the test signal level for each radar type. During this process, there were no transmissions by either Master or Client device. The spectrum analyzer was switched to the zero span (time domain) mode at the frequency of the radar waveform generator. The peak detection was utilized. The spectrum analyzer RBW and VBW were set to at least 3MHz.

The signal generator amplitude and/ or step attenuators were set so that the power level measured at the spectrum analyzer was equal to the DFS detection threshold that is required for the tests.

The signal generator amplitude was set so that the power level measured at the spectrum analyzer was -61dBm.

Conducted calibrated setup diagram:

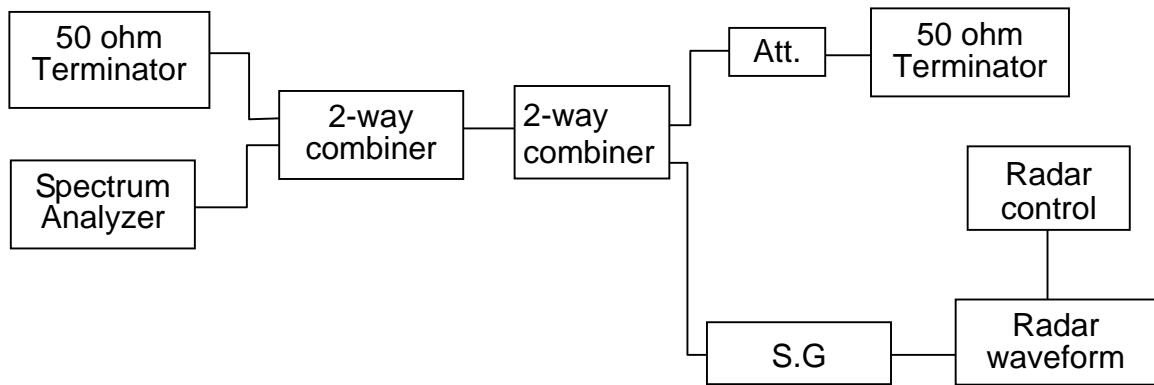

### 2.7.1 Radar Waveform Calibration Plots

The following are the calibration plots for radar waveform of testing required.

Radar type1:

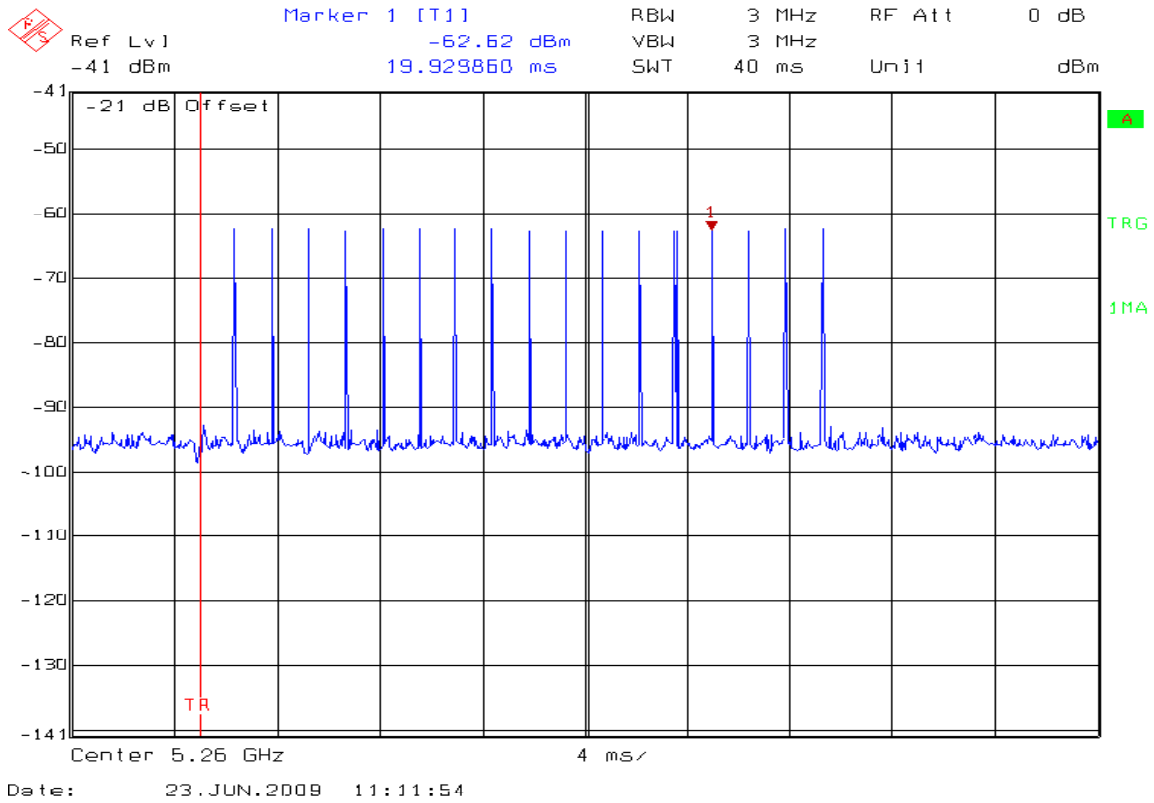

Radar type2:

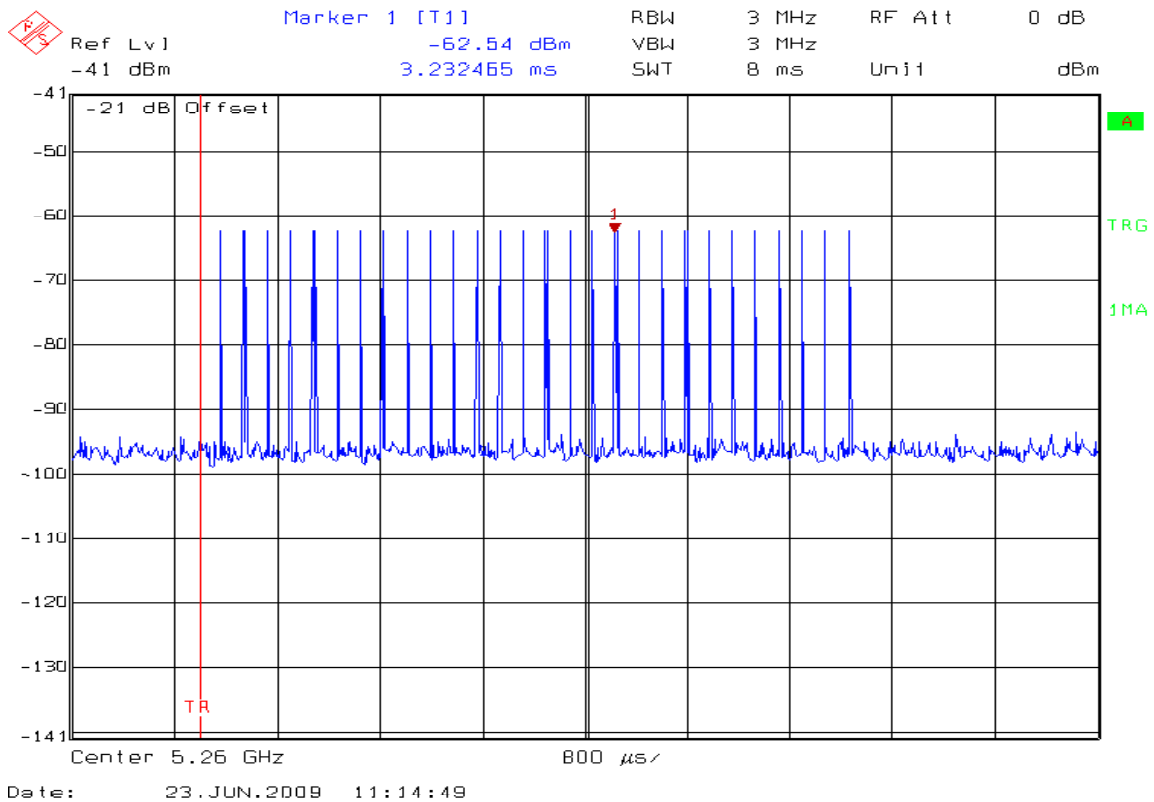

### Radar type3:

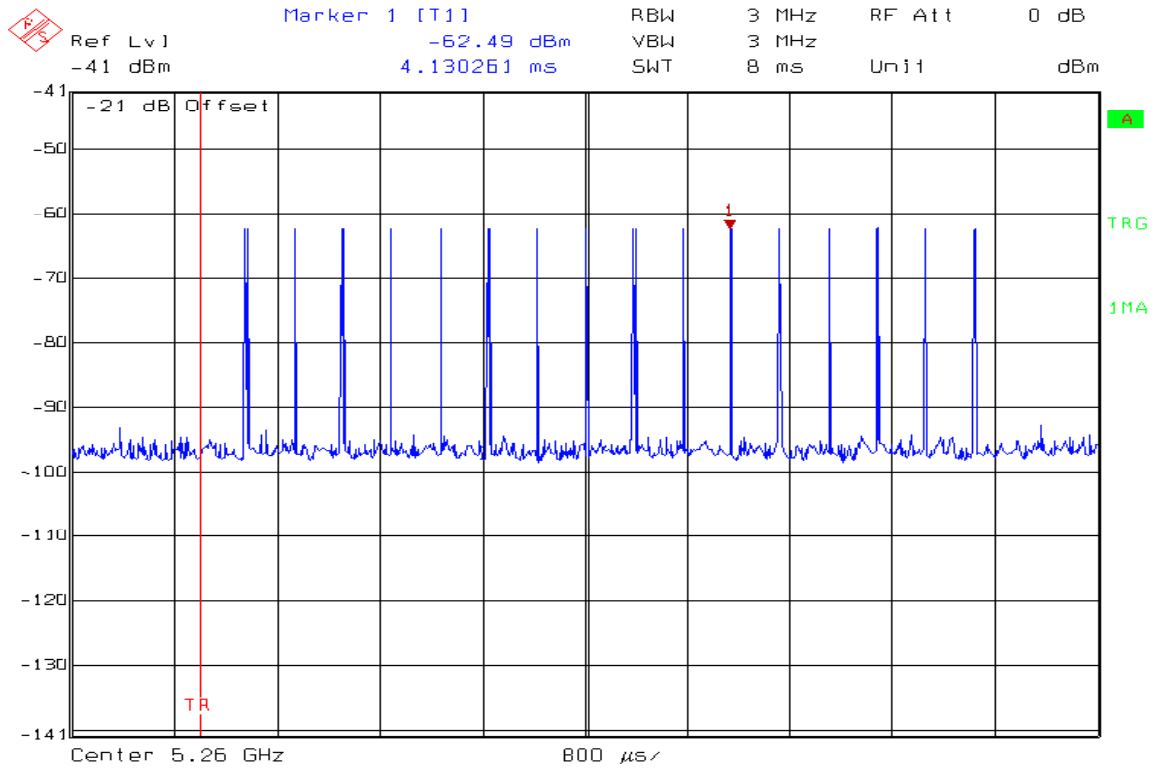

### Radar type4:

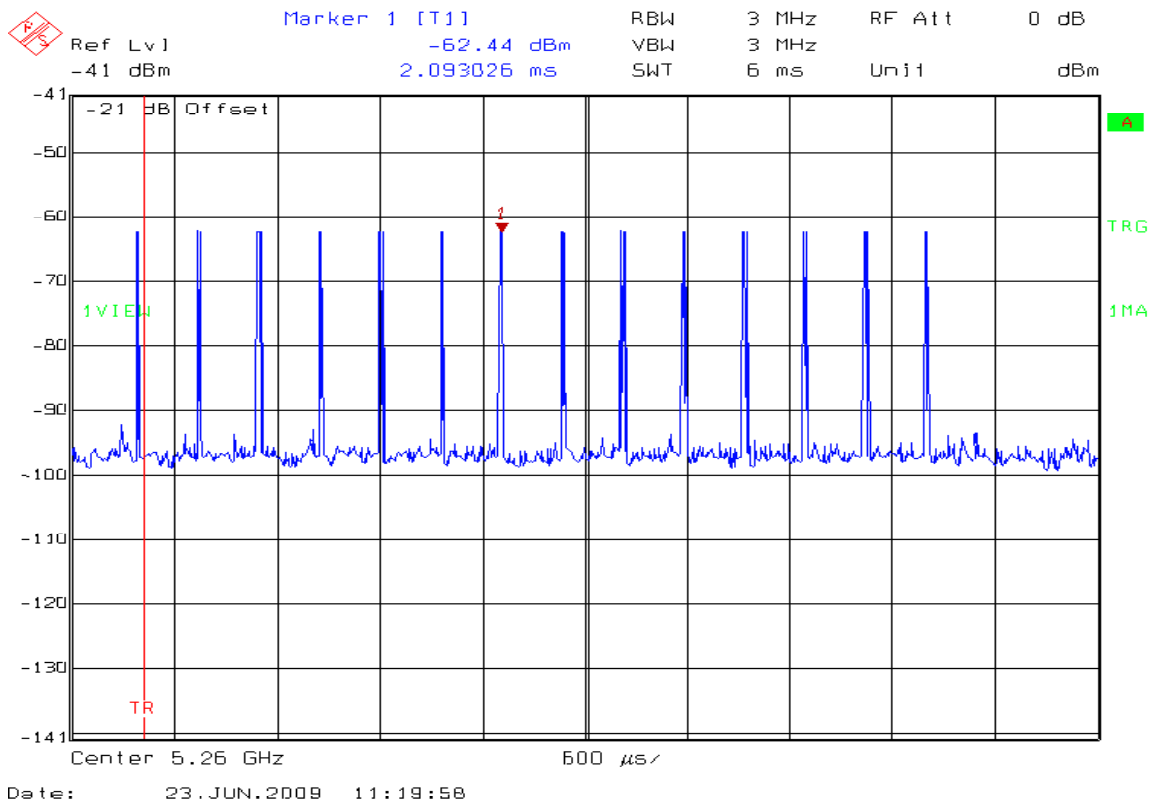

### Radar type5:

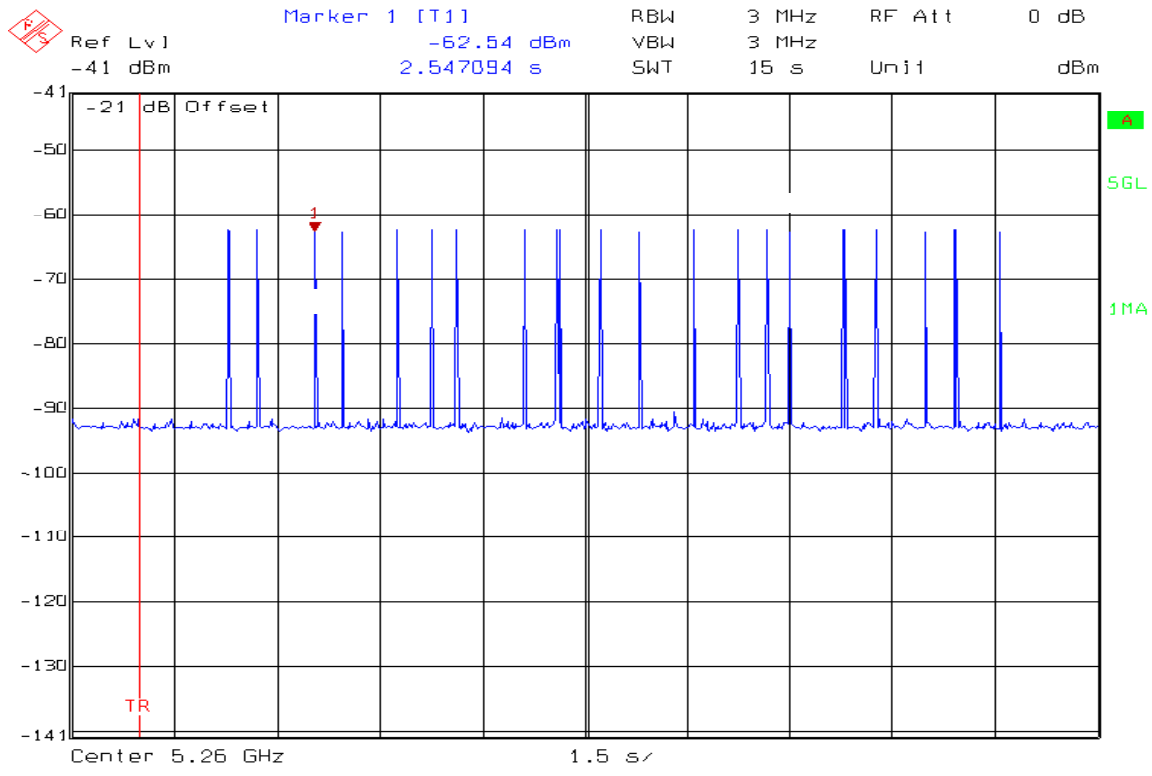

Date: 23.JUN.2009 11:26:15

### Radar type6:

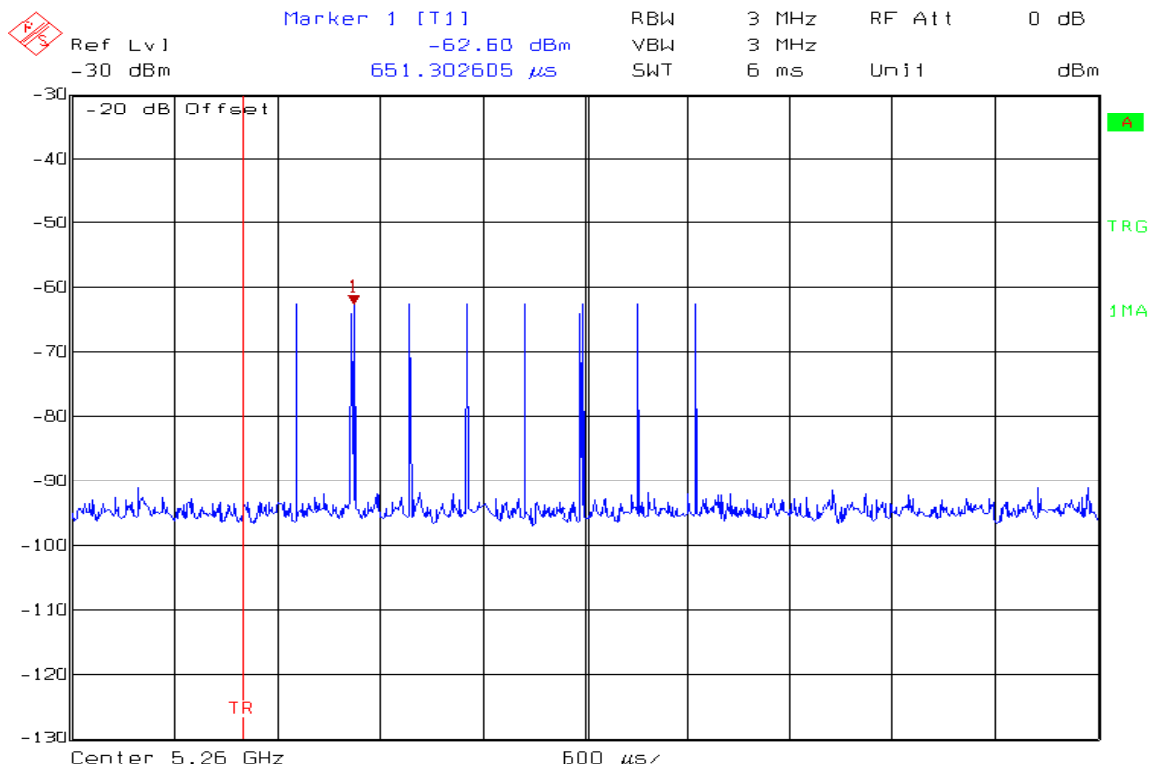

Date: 23.JUN.2009 17:45:51

### Radar type6:

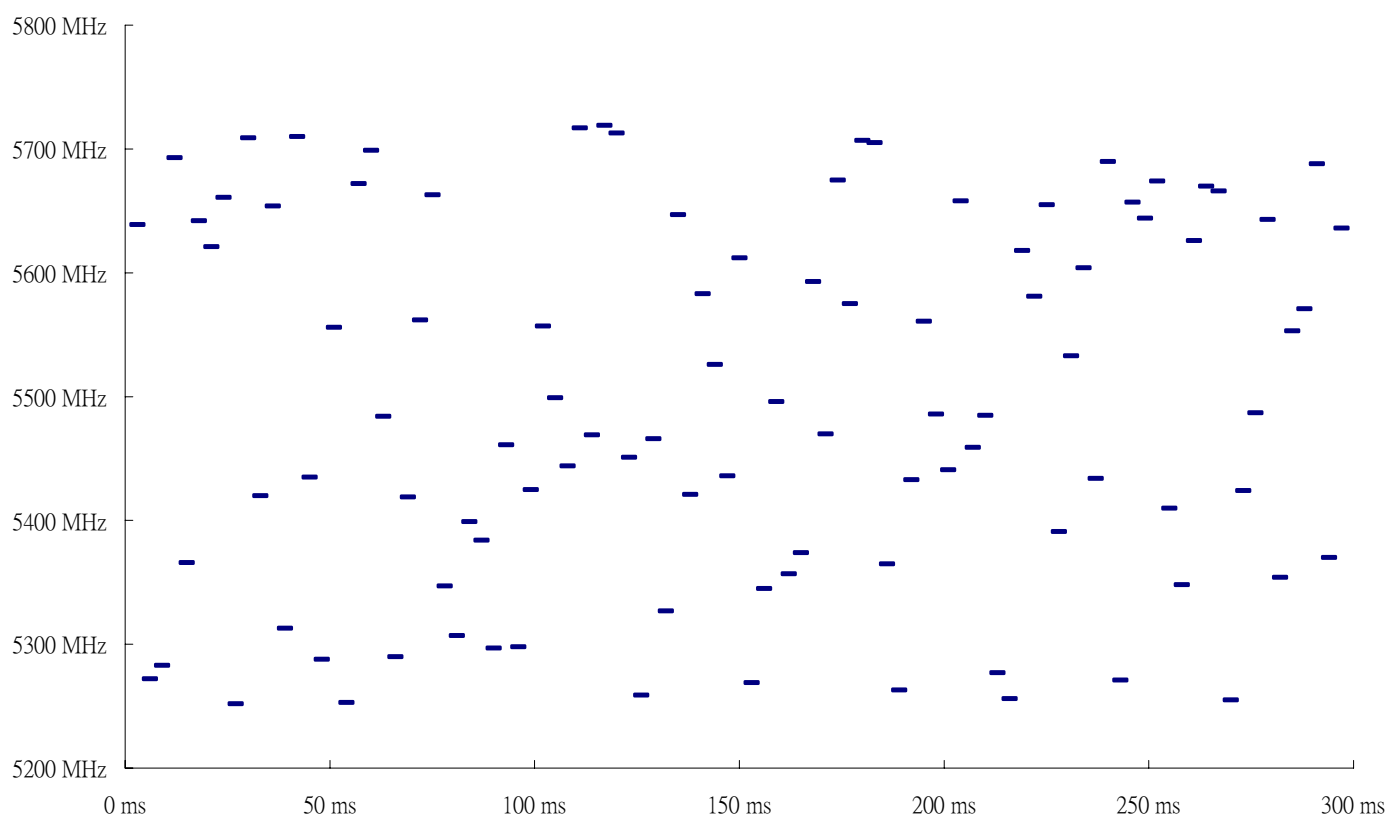

## 2.8 Test setup

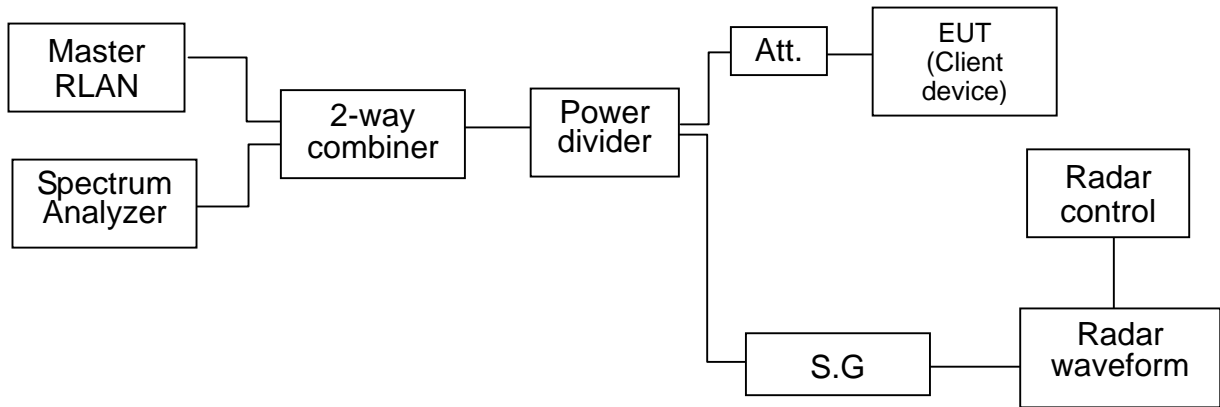

## 2.9 DFS Test summary

This EUT was defined as the Client without DFS detection.

Clause	Parameter	Applicable	Pass/Fail
15.407	DFS Detection Threshold	Not Required	N/A
15.407	Channel Availability Check Time	Not Required	N/A
15.407	Channel Move Time	Applicable	Pass
15.407	Channel Closing Transmission Time	Applicable	Pass
15.407	Non-Occupancy Period	Applicable	Pass
15.407	Uniform Spreading	Not Required	N/A
15.407	UNII Detection Bandwidth	Not Required	N/A

## 2.10 DFS test result

### 2.10.1 Channel Move time

Client Mode (without DFS detection):



### Test plots

#### Frequency 5320MHz (Radar type1)

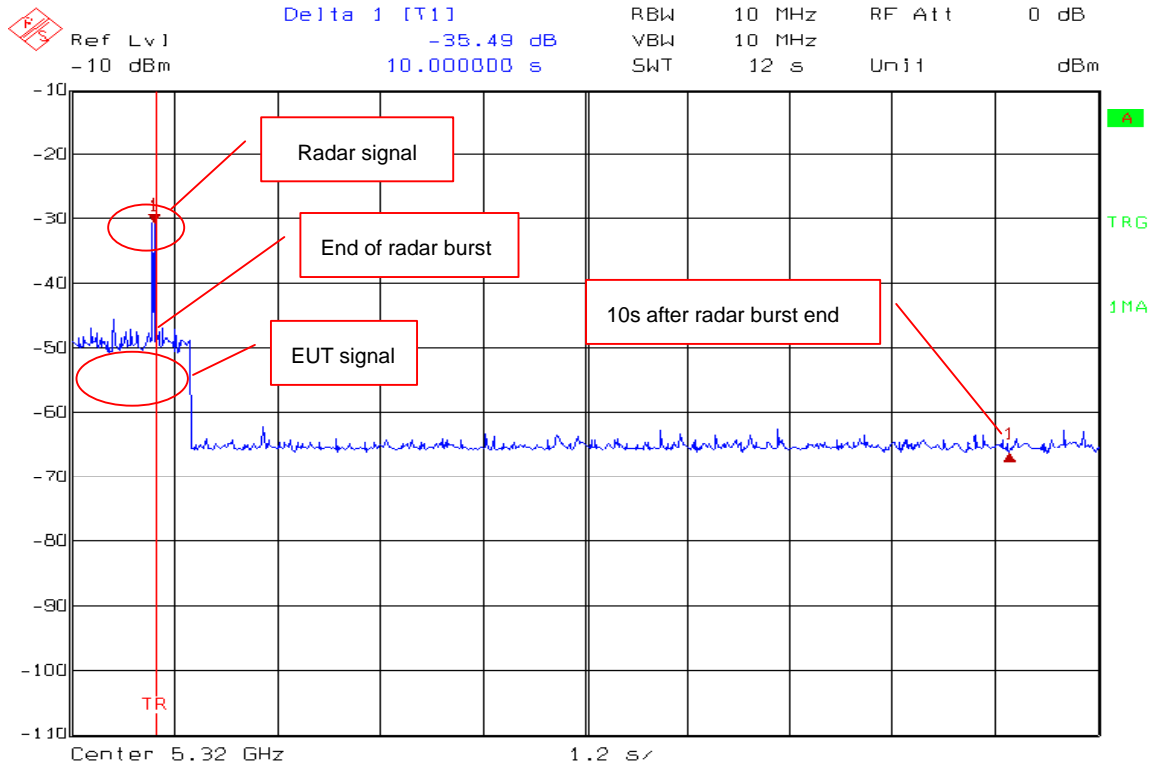

Date: 23.JUN.2009 14:50:38

#### Frequency 5520MHz (Radar type1)

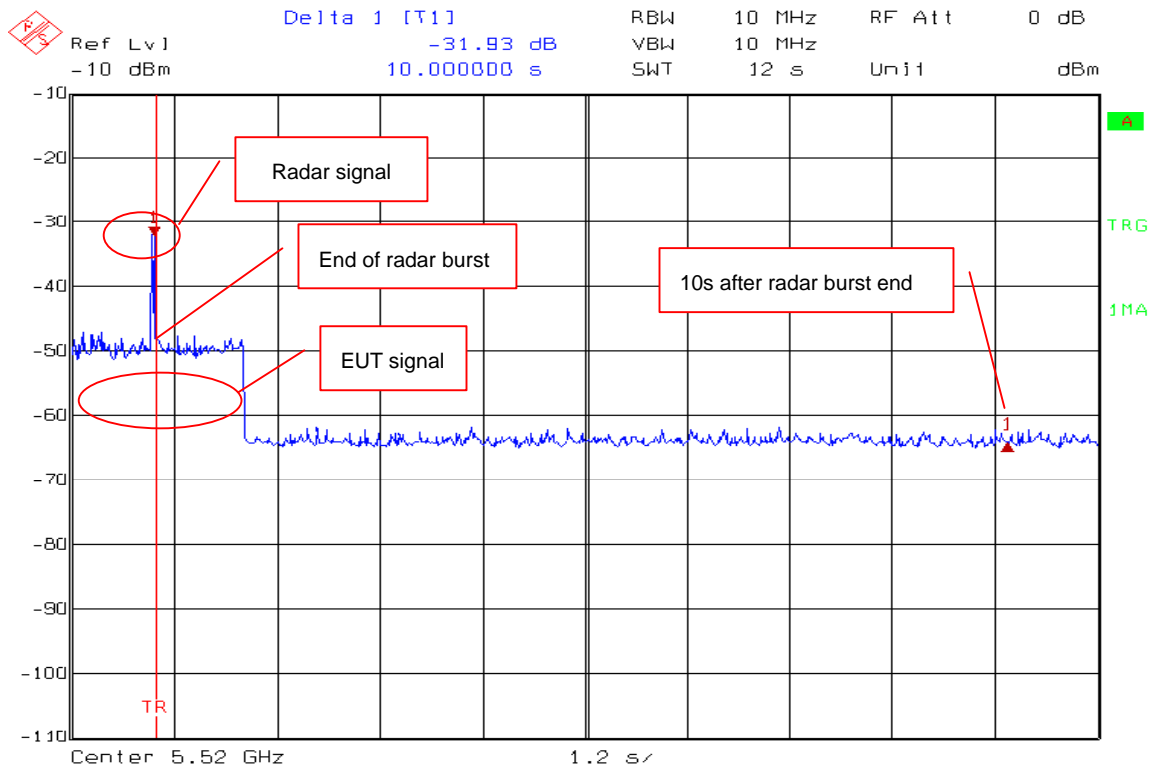

Date: 23.JUN.2009 14:44:58

### Frequency 5320MHz (Radar type2)

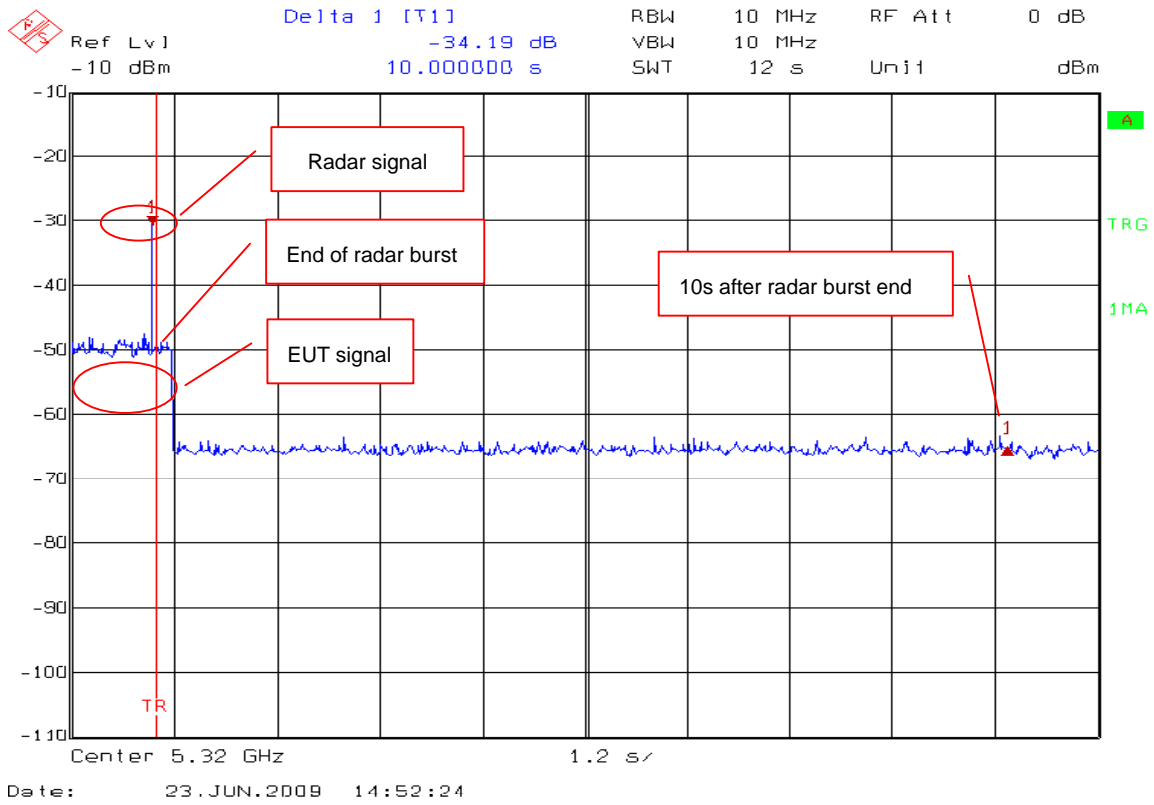

### Frequency 5520MHz (Radar type2)

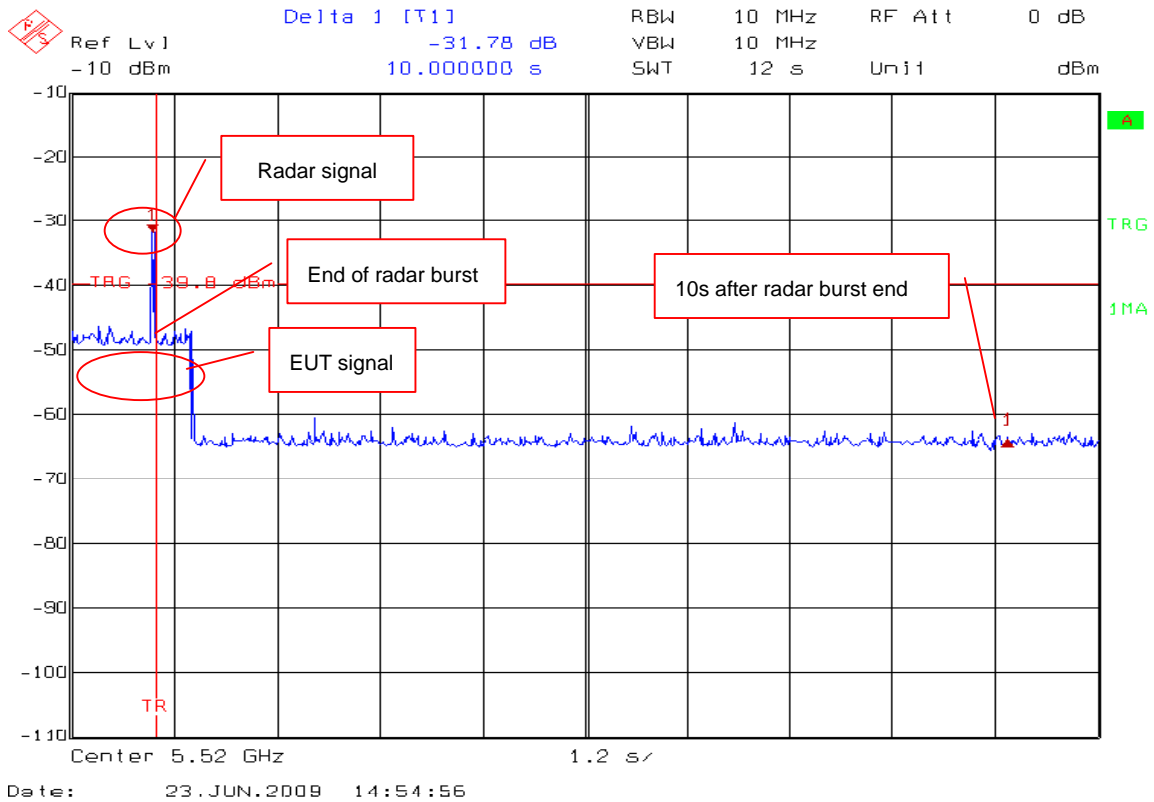

### Frequency 5320MHz (Radar type3)

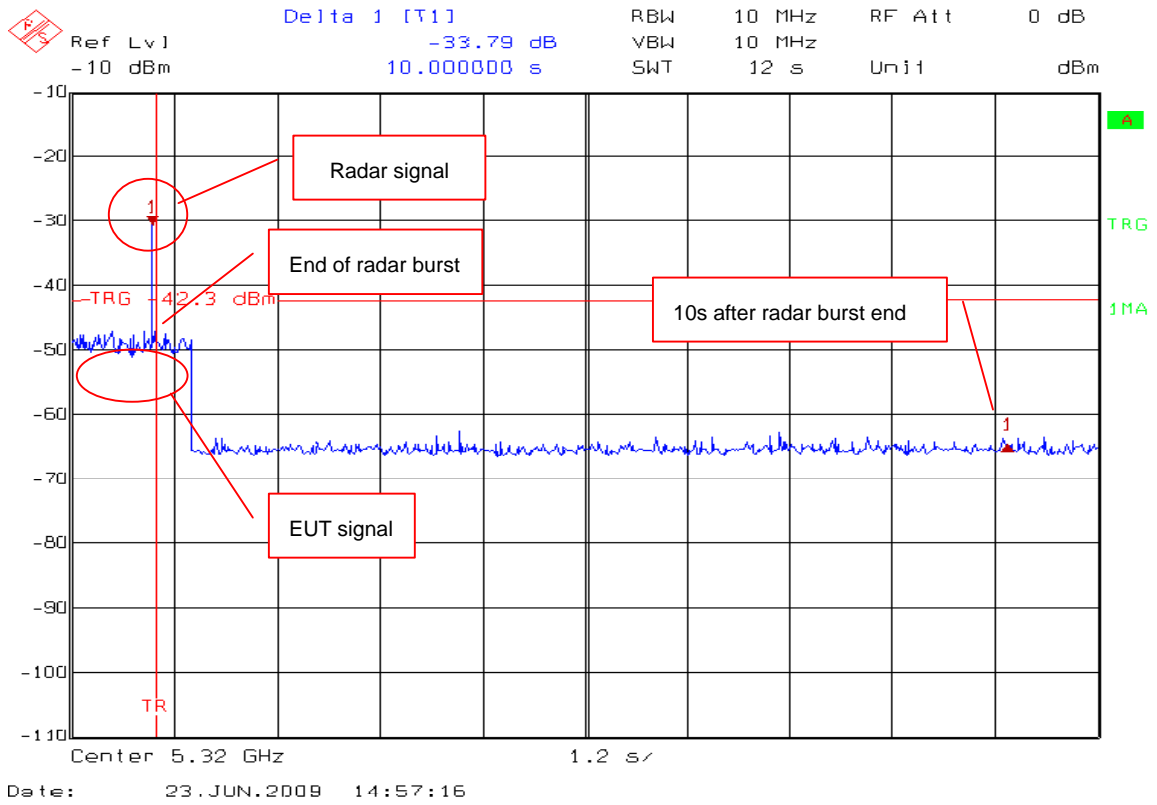

### Frequency 5520MHz (Radar type3)

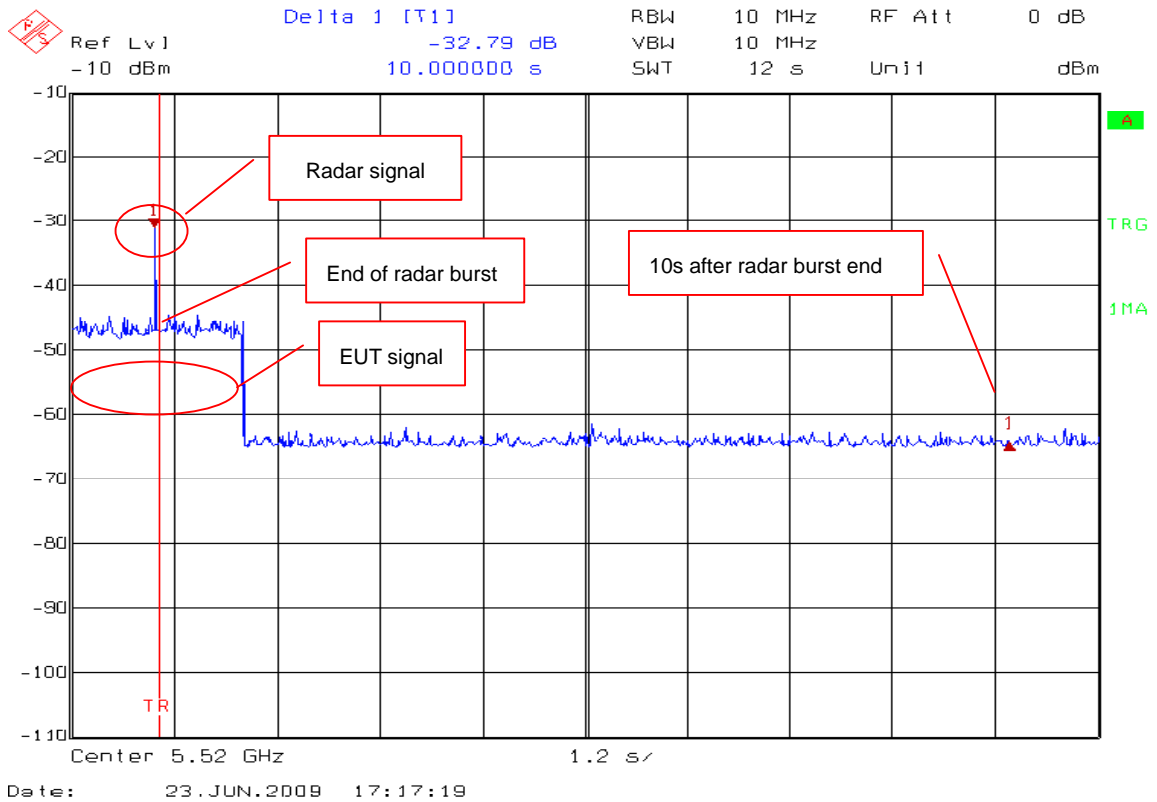

### Frequency 5320MHz (Radar type4)

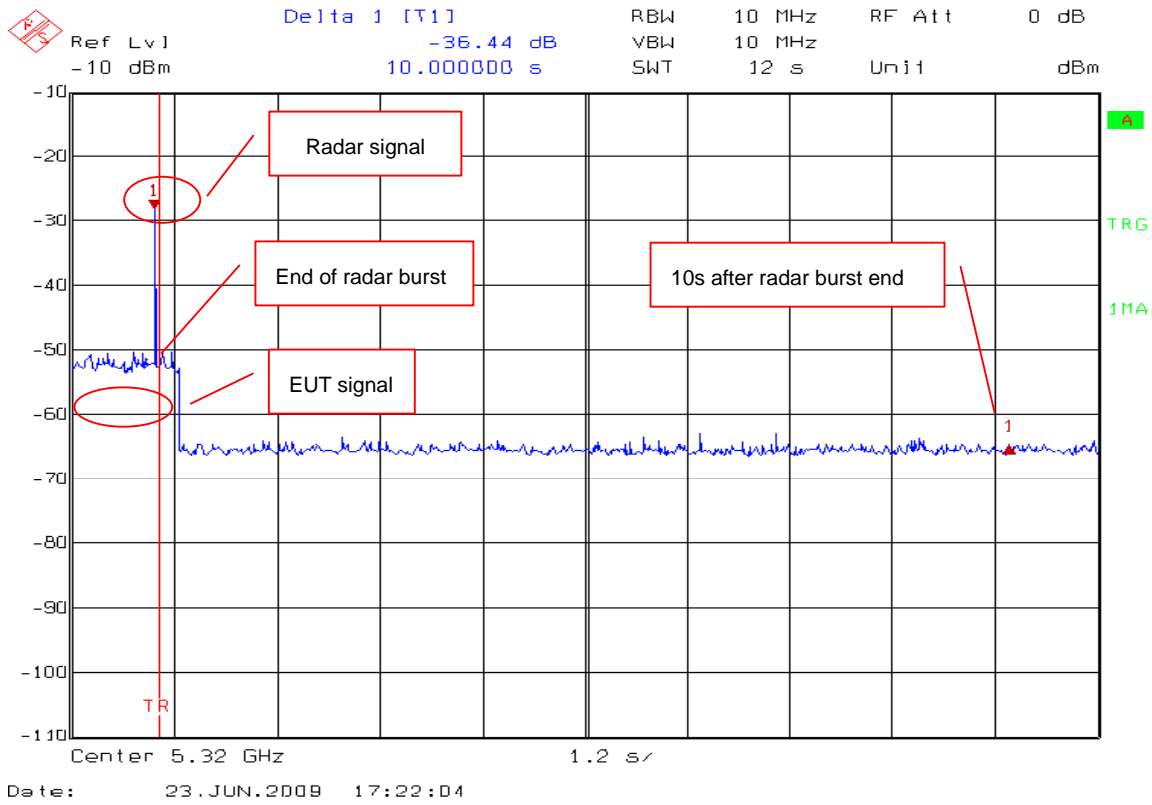

### Frequency 5520MHz (Radar type4)

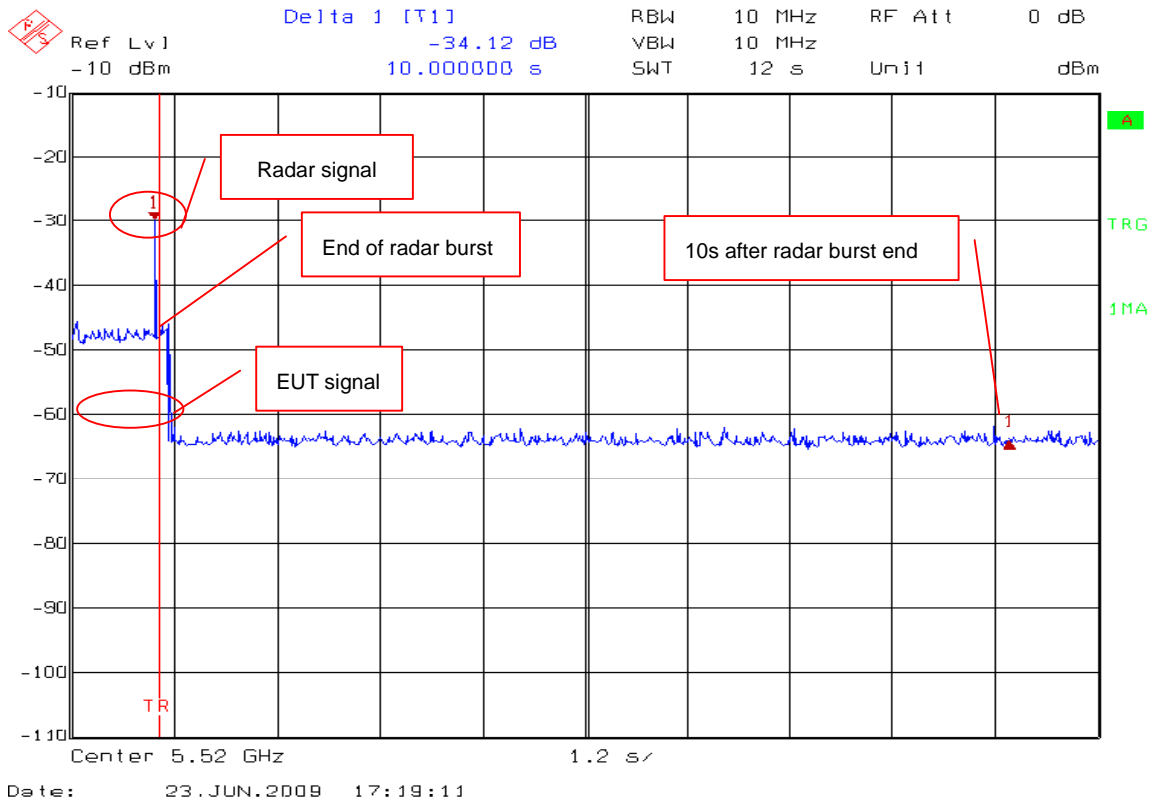

### Frequency 5320MHz (Radar type5)

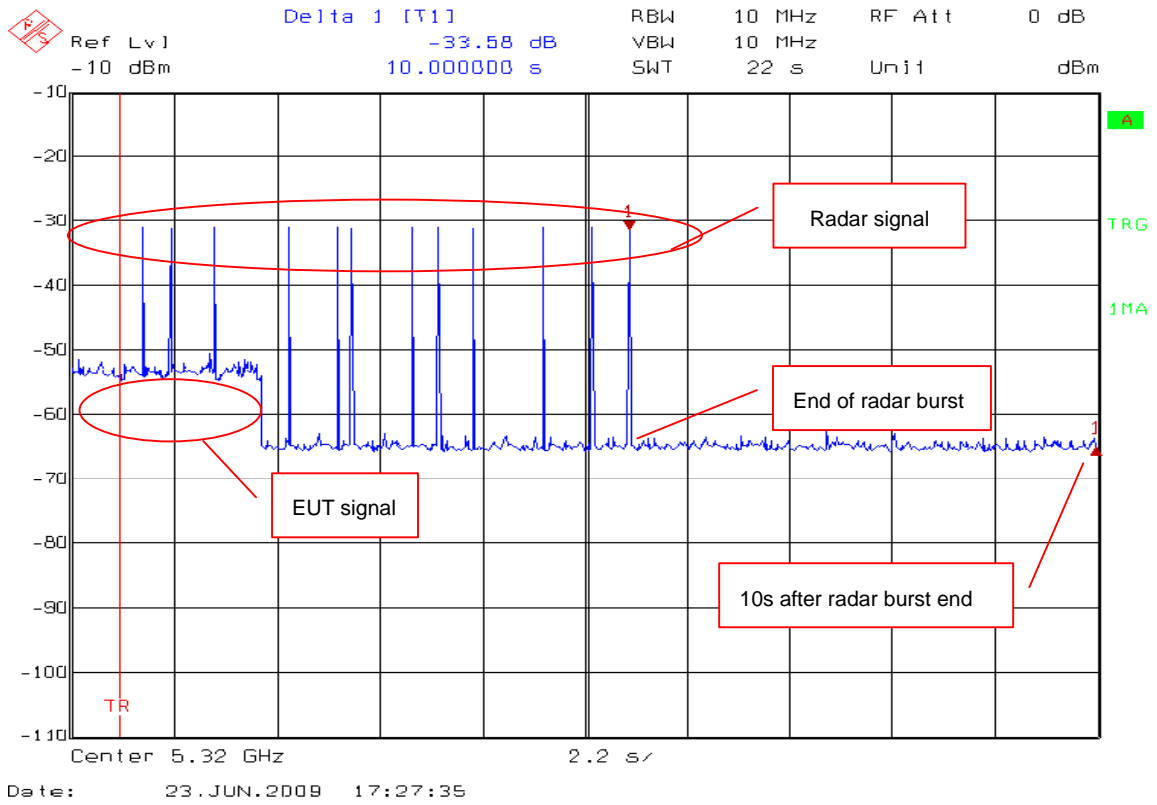

### Frequency 5520MHz (Radar type5)

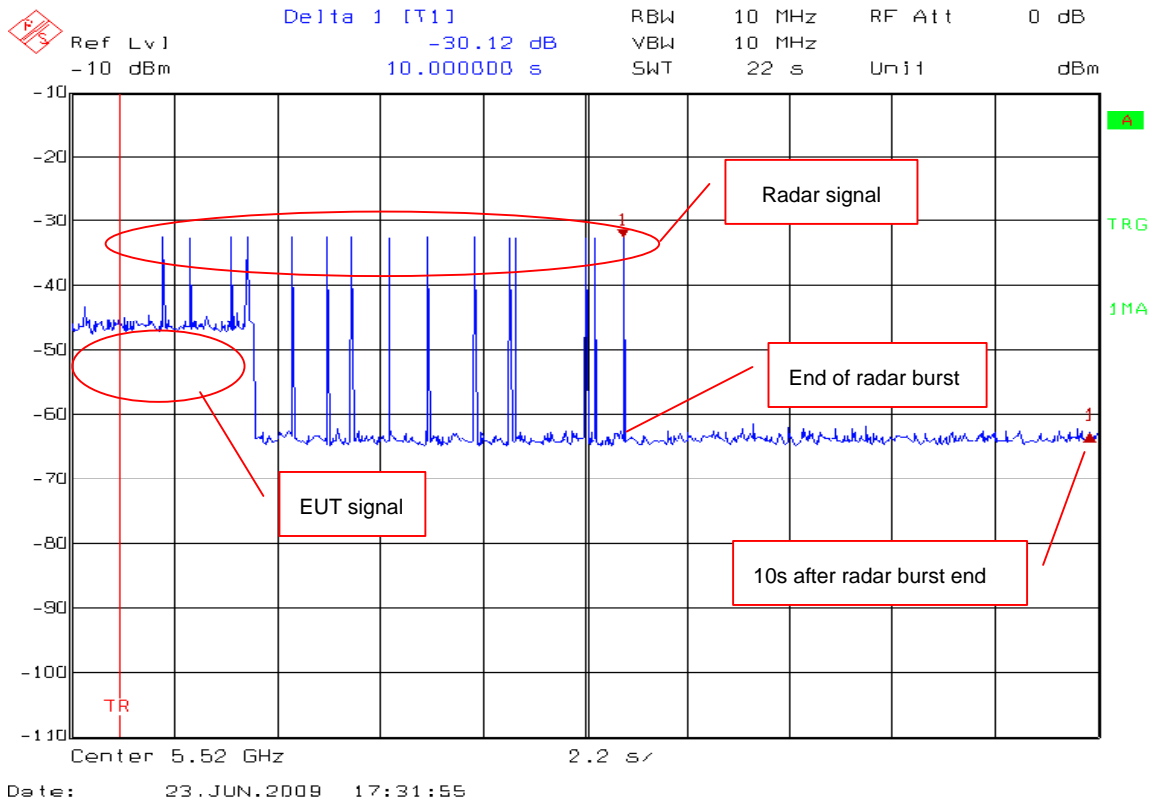

### Frequency 5320MHz (Radar type6)

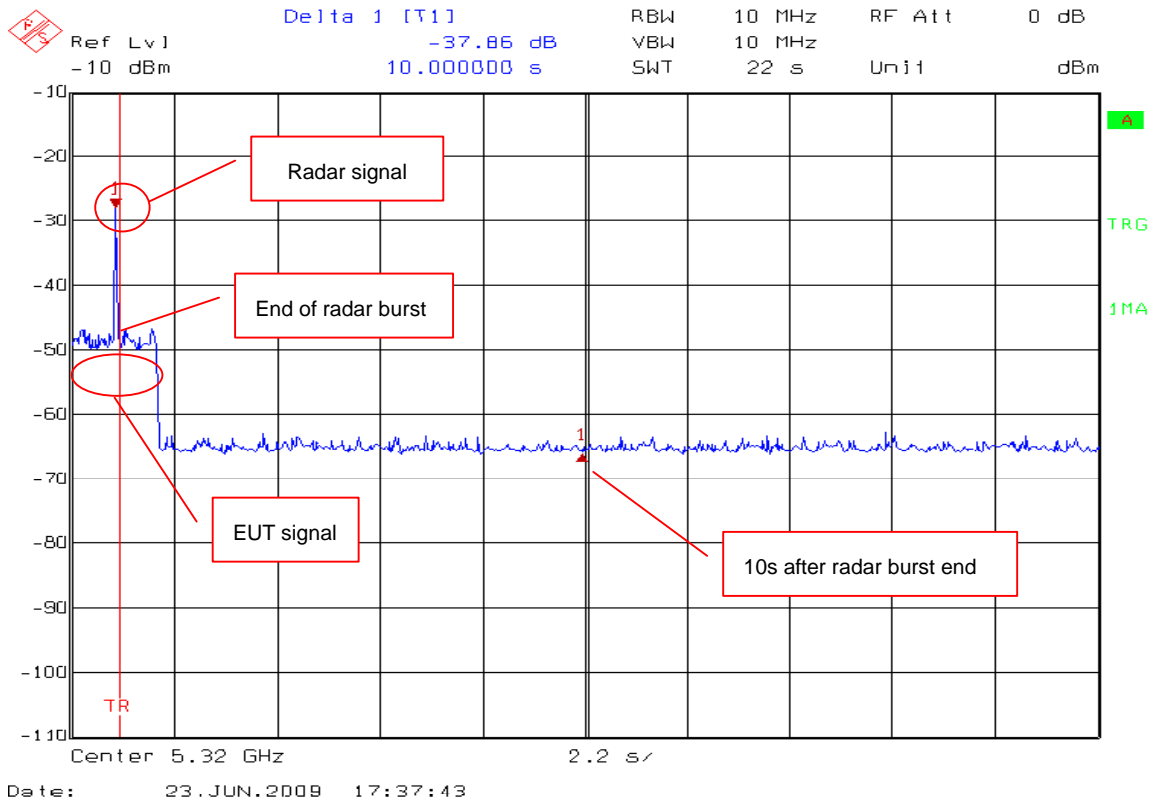

### Frequency 5520MHz (Radar type6)

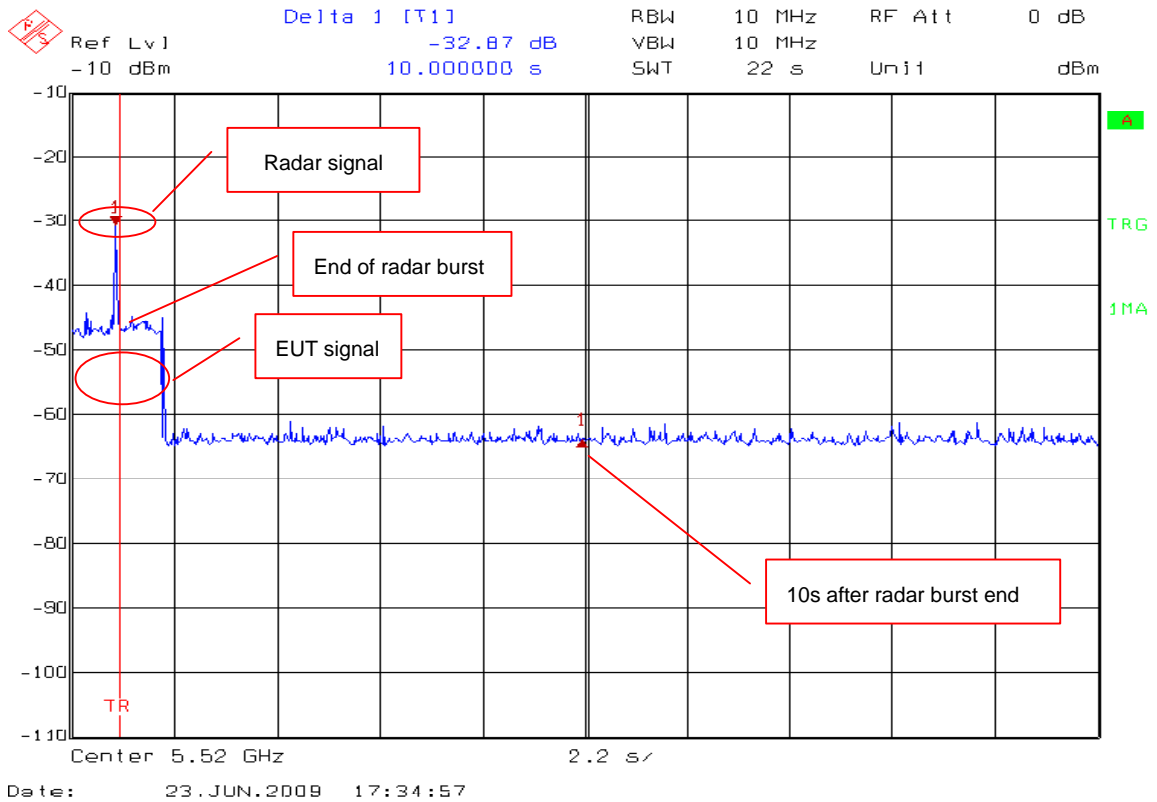

2.10.2 Channel Closing Transmission Time

(Radar type 1)

*For EUT operating at 5320MHz*

The Width of single AP packet is 292.277  $\mu$ s.

With Radar type 1 there is 1 AP packet during the channel move time, so an aggregate of intermittent control signals width is  $2 \times 292.277 \mu\text{s} = 0.585\text{ms}$

*For EUT operating at 5520MHz*

The Width of single AP packet is 292.277  $\mu$ s.

With Radar type 1 there is 5 AP packet during the channel move time, so an aggregate of intermittent control signals width is  $5 \times 292.277 \mu\text{s} = 1.461\text{ms}$

Operating Frequency (MHz)	Radar Type	Channel Closing Transmission Time (ms)	Limit (ms)	Result
5320	1	<10ms	200	Compliance
5520	1	<10ms	200	Compliance

Operating Frequency (MHz)	Radar Type	Aggregate of intermittent control signals width (ms)	Limit (ms)	Result
5320	1	0.585	60	Compliance
5520	1	1.461	60	Compliance

Note: please see the test plots as below pages.

### Single AP packet width (5320MHz)

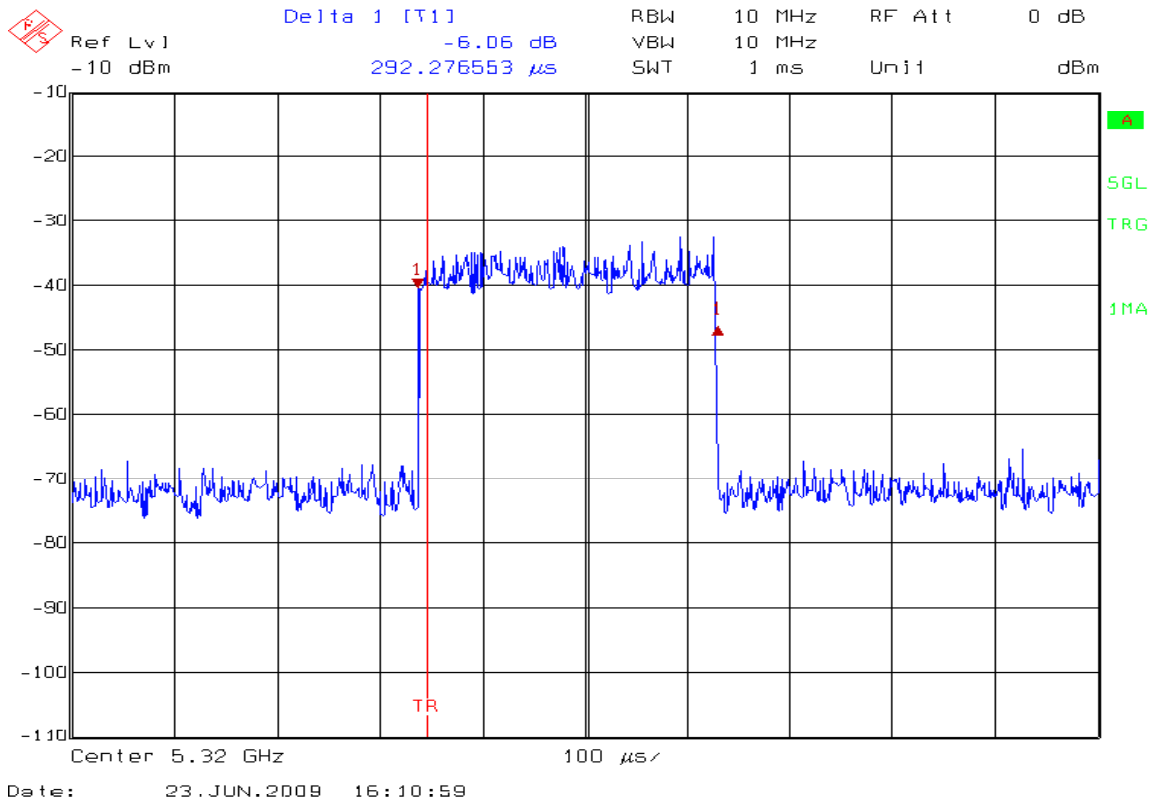

### Single AP packet width (5520MHz)

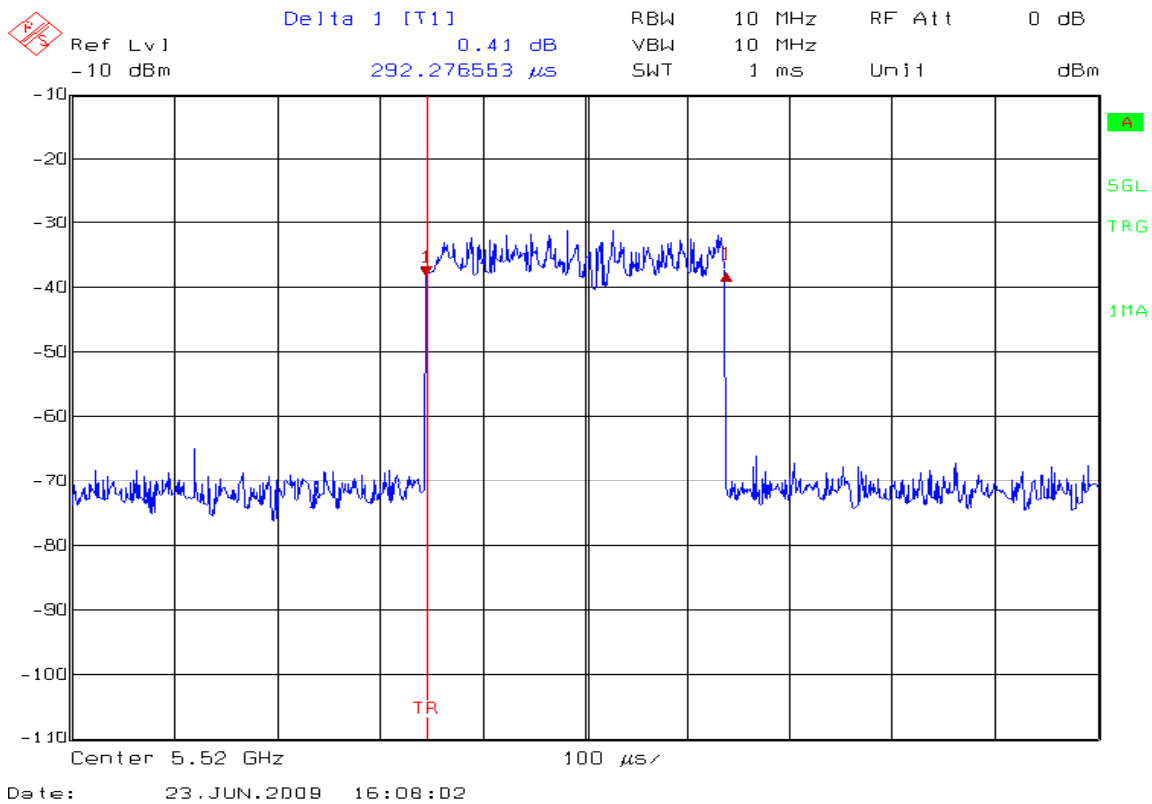



### Closing transmission AP packet number (5320MHz)

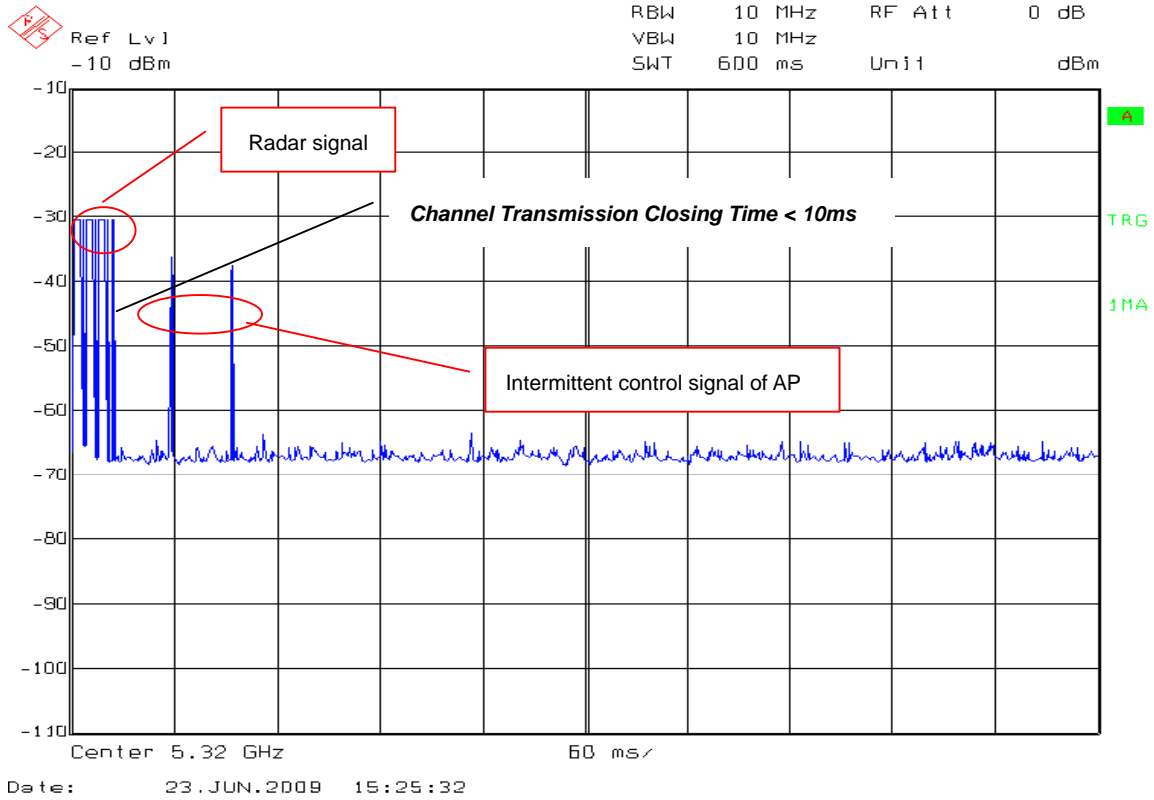

### Closing transmission AP packet number (5520MHz)

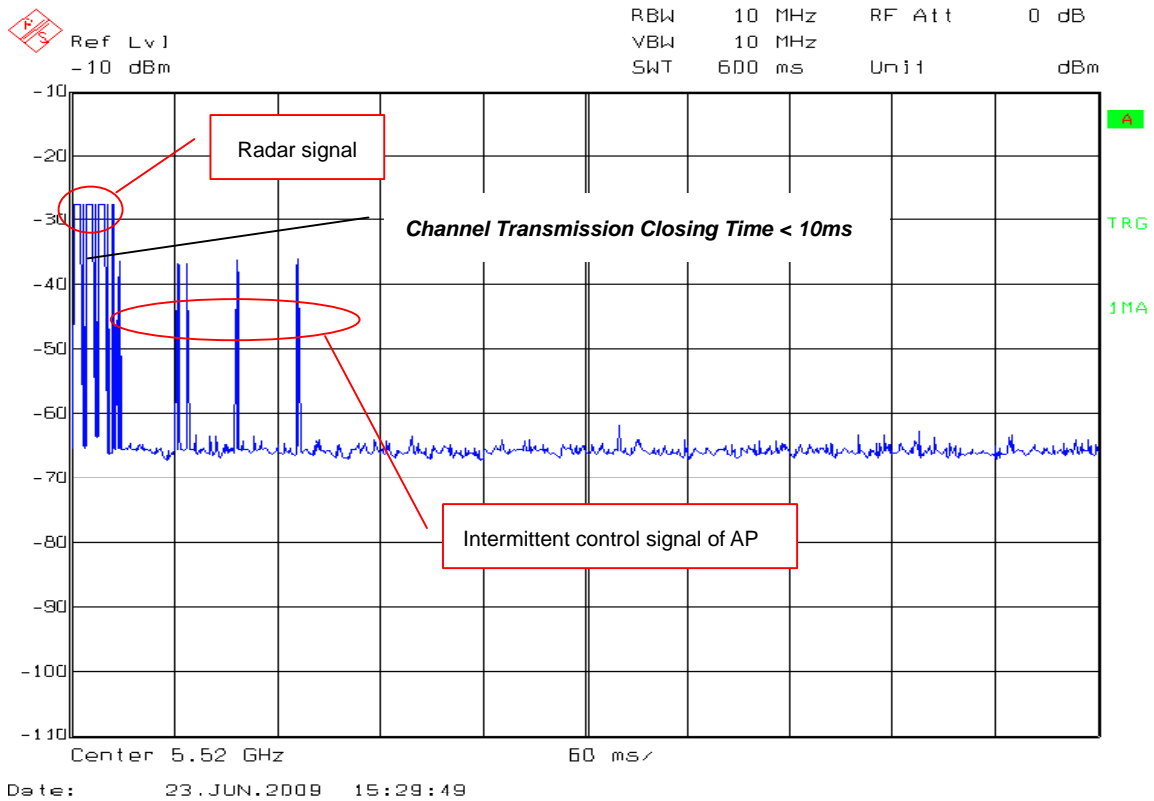

(Radar type 2)

*For EUT operating at 5320MHz*

The Width of single AP packet is 292.277  $\mu$ s.

With Radar type 1 there is 1 AP packet during the channel move time, so an aggregate of intermittent control signals width is  $4 \times 292.277 \mu\text{s} = 1.169\text{ms}$

*For EUT operating at 5520MHz*

The Width of single AP packet is 292.277  $\mu$ s.

With Radar type 1 there is 1 AP packet during the channel move time, so an aggregate of intermittent control signals width is  $6 \times 292.277 \mu\text{s} = 1.753\text{ms}$

Operating Frequency (MHz)	Radar Type	Channel Closing Transmission Time (ms)	Limit (ms)	Result
5320	1	<10ms	200	Compliance
5520	1	<10ms	200	Compliance

Operating Frequency (MHz)	Radar Type	Aggregate of intermittent control signals width (ms)	Limit (ms)	Result
5320	1	1.169	60	Compliance
5520	1	1.753	60	Compliance

Note: please see the test plots as below pages.

### Closing transmission AP packet number (5320MHz)

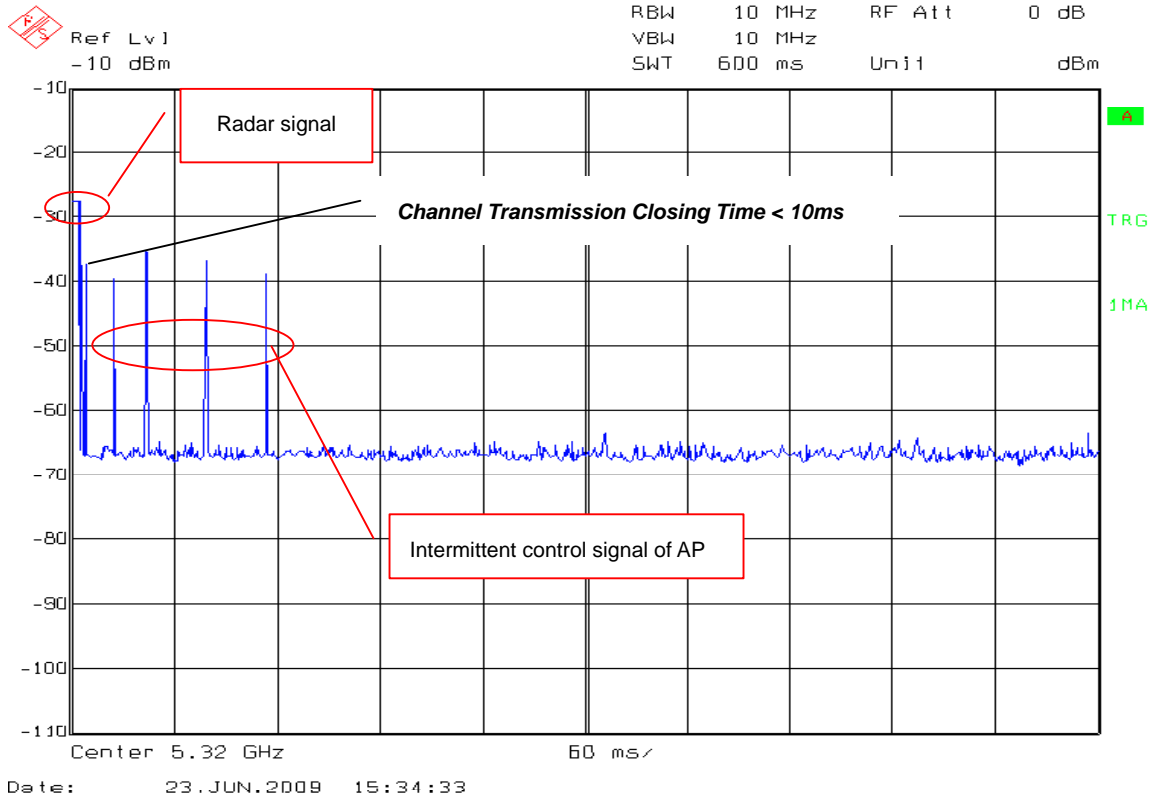

### Closing transmission AP packet number (5520MHz)

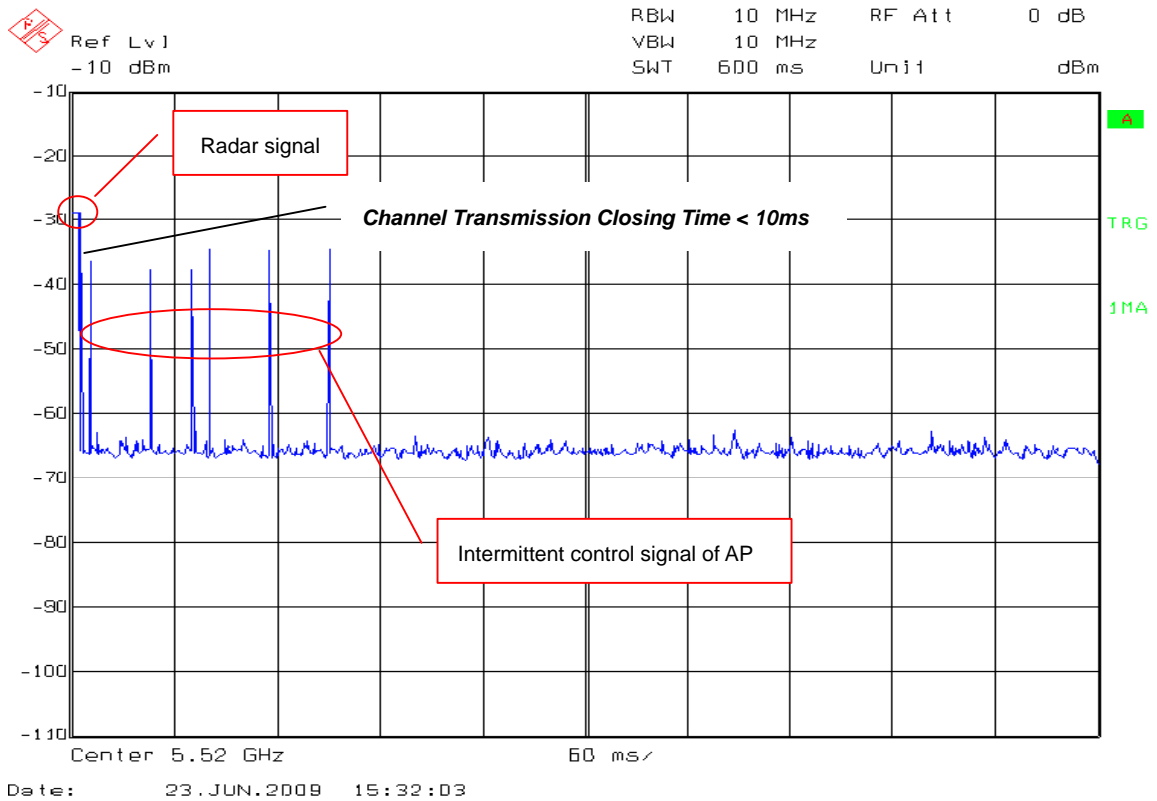

(Radar type 3)

*For EUT operating at 5320MHz*

The Width of single AP packet is 292.277  $\mu$ s.

With Radar type 3 there is 1 AP packet during the channel move time, so an aggregate of intermittent control signals width is  $3 \times 292.277 \mu\text{s} = 0.876\text{ms}$

*For EUT operating at 5520MHz*

The Width of single AP packet is 292.277  $\mu$ s.

With Radar type 1 there is 1 AP packet during the channel move time, so an aggregate of intermittent control signals width is  $7 \times 292.277 \mu\text{s} = 2.045\text{ms}$

Operating Frequency (MHz)	Radar Type	Channel Closing Transmission Time (ms)	Limit (ms)	Result
5320	3	<10ms	200	Compliance
5520	3	<10ms	200	Compliance

Operating Frequency (MHz)	Radar Type	Aggregate of intermittent control signals width (ms)	Limit (ms)	Result
5320	3	0.876	60	Compliance
5520	3	2.045	60	Compliance

Note: please see the test plots as below pages.

### Closing transmission AP packet number (5320MHz)

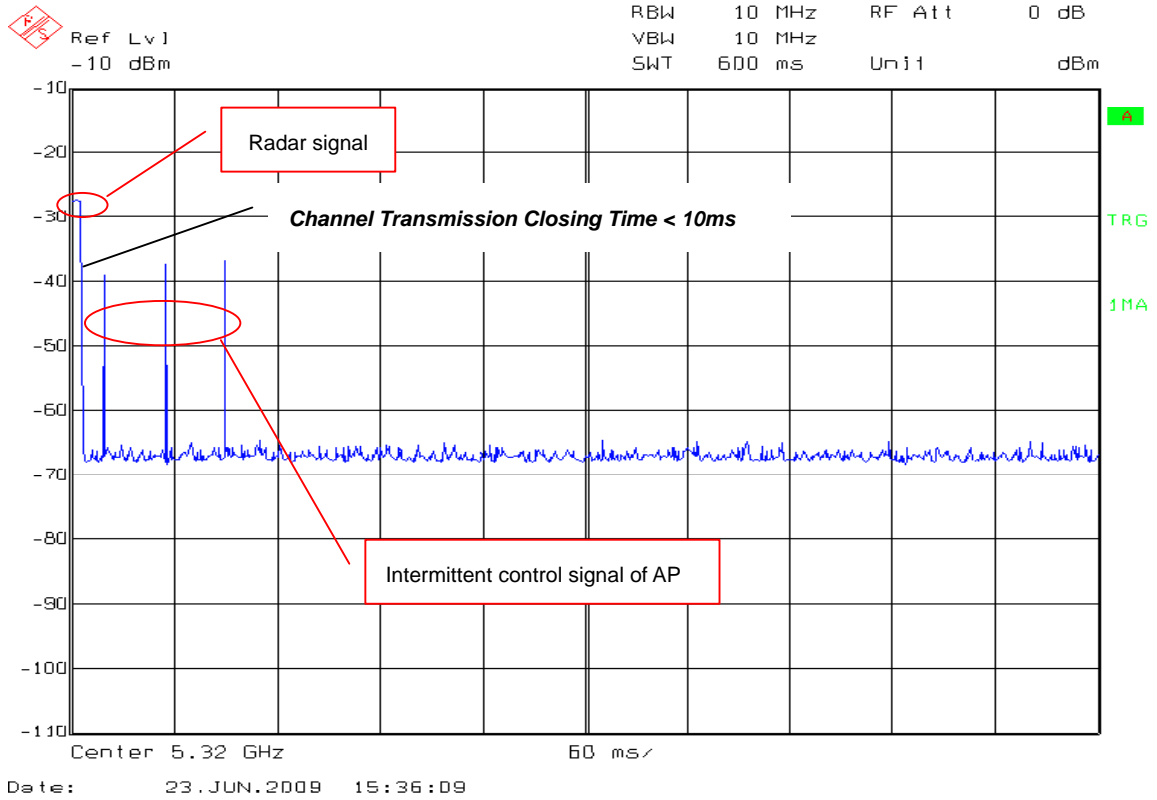

### Closing transmission AP packet number (5520MHz)

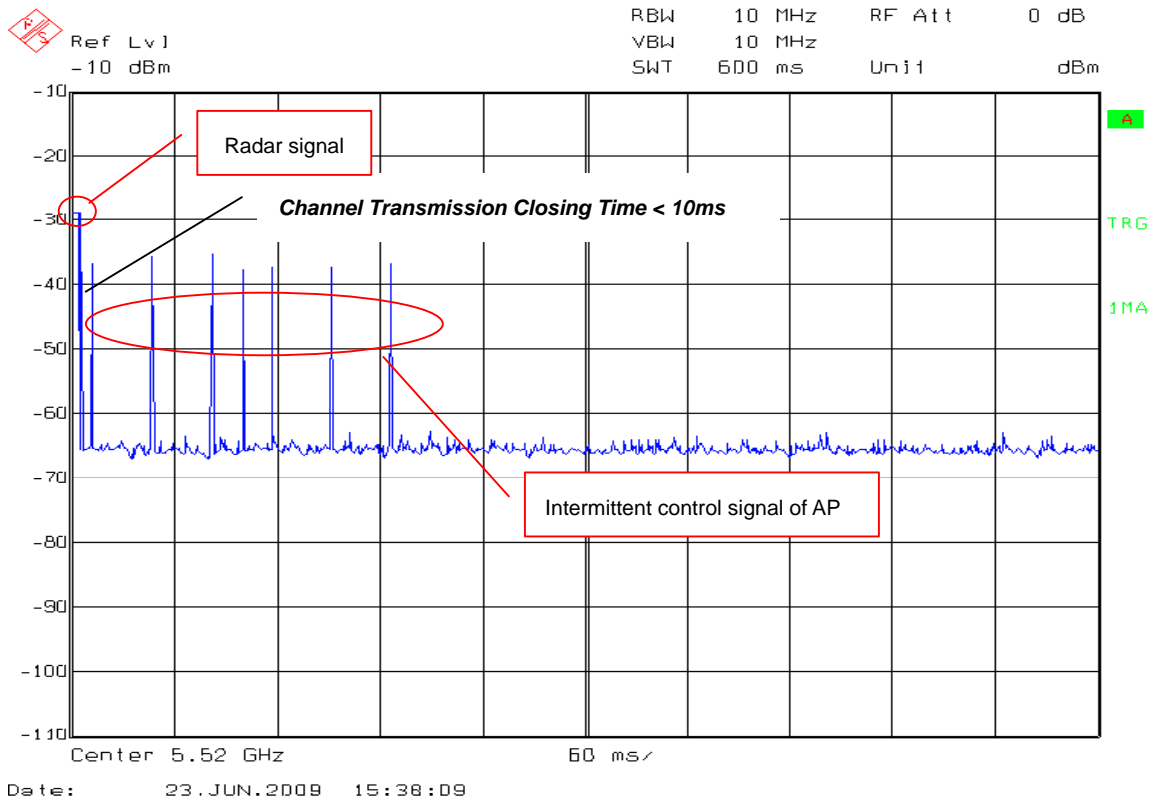

(Radar type 4)

*For EUT operating at 5320MHz*

The Width of single AP packet is 292.277  $\mu$ s.

With Radar type 4 there is 1 AP packet during the channel move time, so an aggregate of intermittent control signals width is  $5 \times 292.277 \mu\text{s} = 1.461 \text{ms}$

*For EUT operating at 5520MHz*

The Width of single AP packet is 292.277  $\mu$ s.

With Radar type 1 there is 1 AP packet during the channel move time, so an aggregate of intermittent control signals width is  $5 \times 292.277 \mu\text{s} = 1.461 \text{ms}$

Operating Frequency (MHz)	Radar Type	Channel Closing Transmission Time (ms)	Limit (ms)	Result
5320	4	<10ms	200	Compliance
5520	4	<10ms	200	Compliance

Operating Frequency (MHz)	Radar Type	Aggregate of intermittent control signals width (ms)	Limit (ms)	Result
5320	4	1.461	60	Compliance
5520	4	1.461	60	Compliance

Note: please see the test plots as below pages.

### Closing transmission AP packet number (5320MHz)

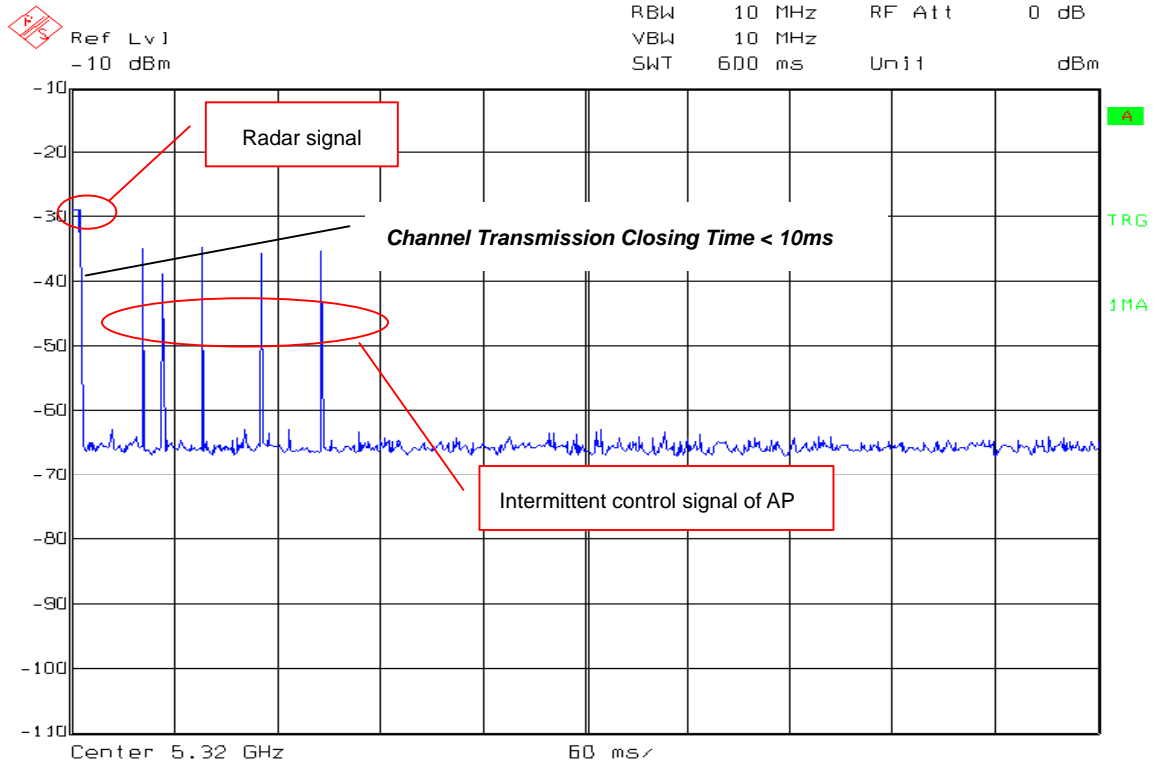

### Closing transmission AP packet number (5520MHz)

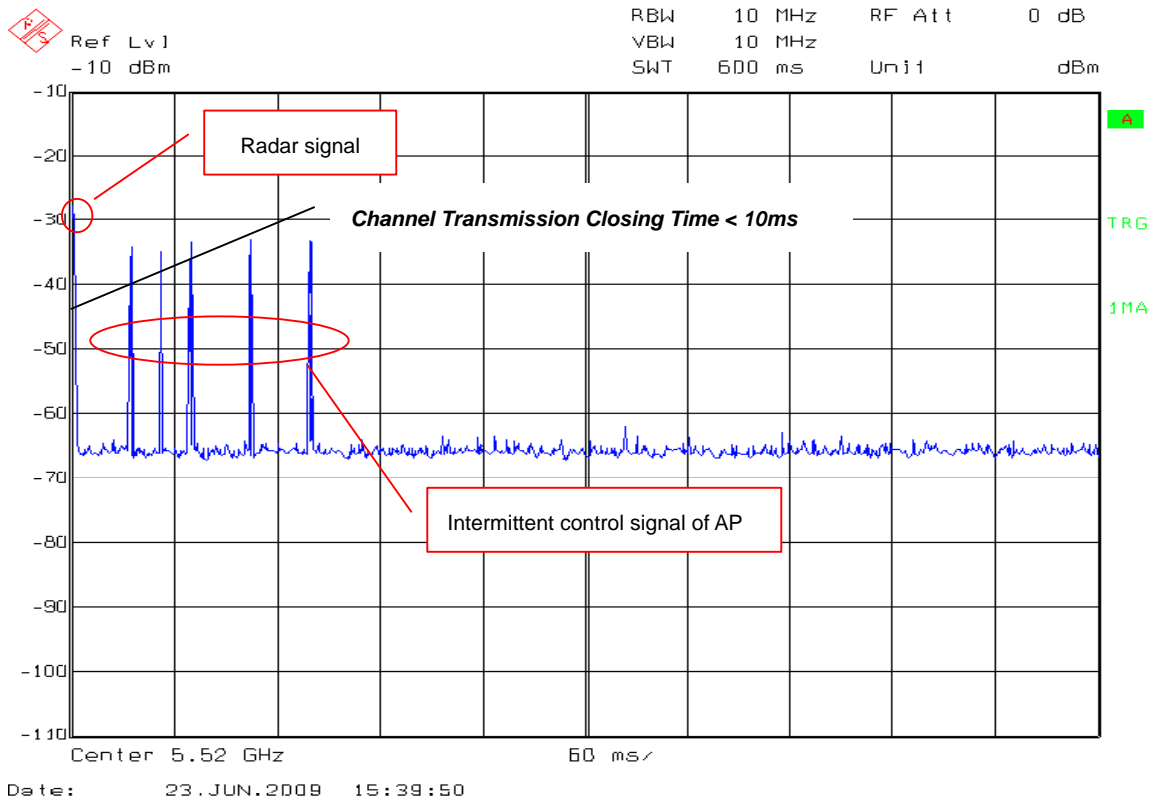

(Radar type 5)

*For EUT operating at 5320MHz*

The Width of single AP packet is 292.277  $\mu$ s.

With Radar type 5 there is 1 AP packet during the channel move time, so an aggregate of intermittent control signals width is  $3 \times 292.277 \mu\text{s} = 0.876\text{ms}$

*For EUT operating at 5520MHz*

The Width of single AP packet is 292.277  $\mu$ s.

With Radar type 5 there is 1 AP packet during the channel move time, so an aggregate of intermittent control signals width is  $4 \times 292.277 \mu\text{s} = 1.169\text{ms}$

Operating Frequency (MHz)	Radar Type	Channel Closing Transmission Time (ms)	Limit (ms)	Result
5320	5	<10ms	200	Compliance
5520	5	<10ms	200	Compliance

Operating Frequency (MHz)	Radar Type	Aggregate of intermittent control signals width (ms)	Limit (ms)	Result
5320	5	0.876	60	Compliance
5520	5	1.169	60	Compliance

Note: please see the test plots as below pages.



### Closing transmission AP packet number (5320MHz)

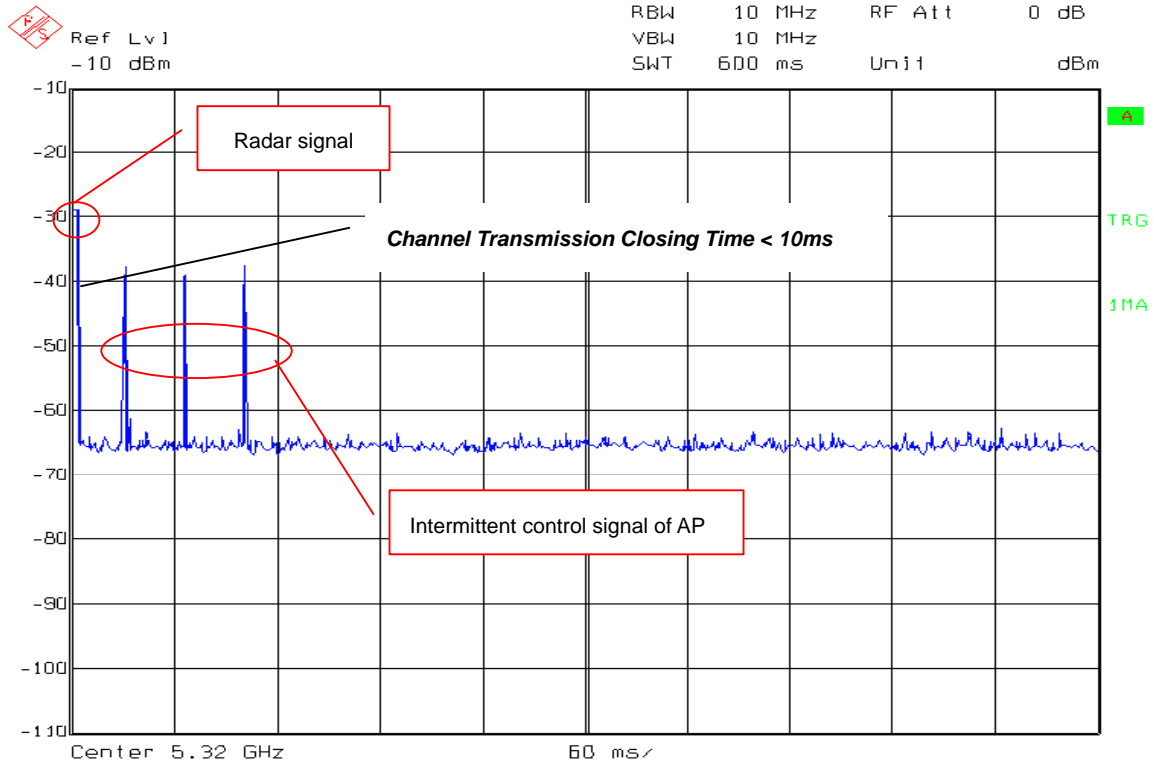

Date: 23.JUN.2009 15:45:59

### Closing transmission AP packet number (5520MHz)

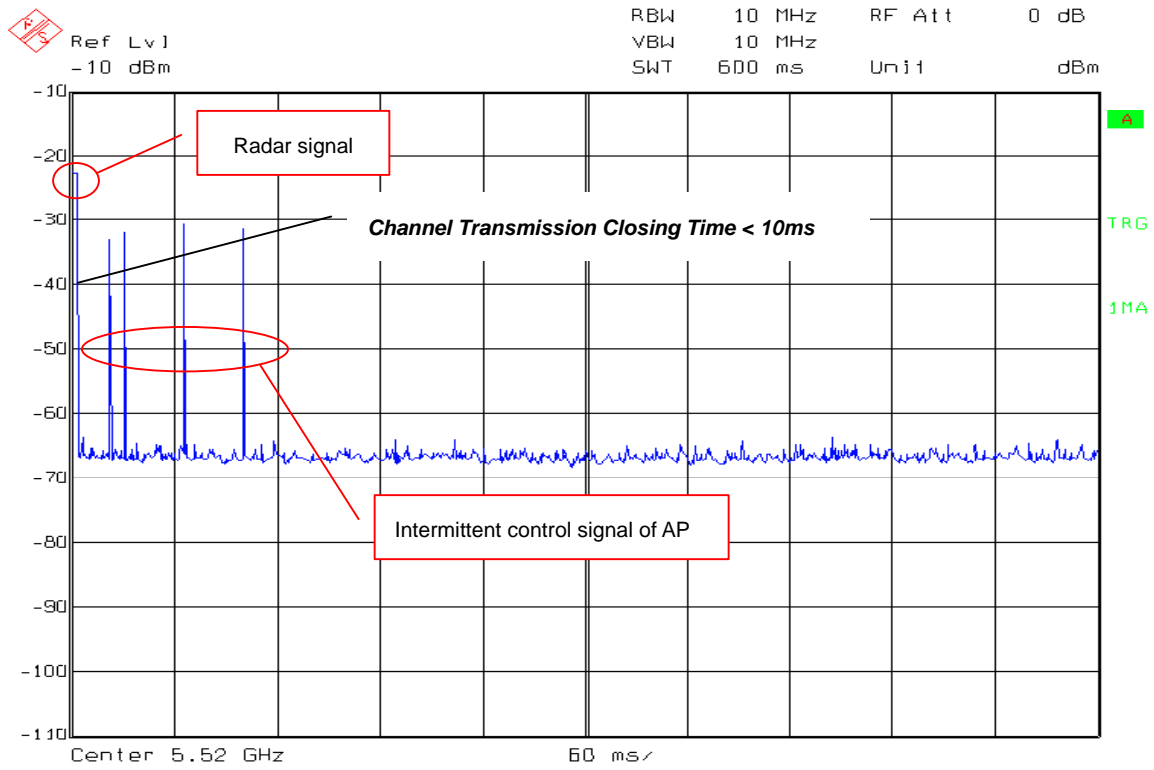

Date: 23.JUN.2009 16:01:36

(Radar type 6)

*For EUT operating at 5320MHz*

The Width of single AP packet is 292.277  $\mu$ s.

With Radar type 6 there is 1 AP packet during the channel move time, so an aggregate of intermittent control signals width is  $5 \times 292.277 \mu\text{s} = 1.461 \text{ms}$

*For EUT operating at 5520MHz*

The Width of single AP packet is 292.277  $\mu$ s.

With Radar type 6 there is 1 AP packet during the channel move time, so an aggregate of intermittent control signals width is  $1 \times 292.277 \mu\text{s} = 0.292 \text{ms}$

Operating Frequency (MHz)	Radar Type	Channel Closing Transmission Time (ms)	Limit (ms)	Result
5320	6	<10ms	200	Compliance
5520	6	<10ms	200	Compliance

Operating Frequency (MHz)	Radar Type	Aggregate of intermittent control signals width (ms)	Limit (ms)	Result
5320	6	1.461	60	Compliance
5520	6	0.292	60	Compliance

Note: please see the test plots as below pages.

### Closing transmission AP packet number (5320MHz)

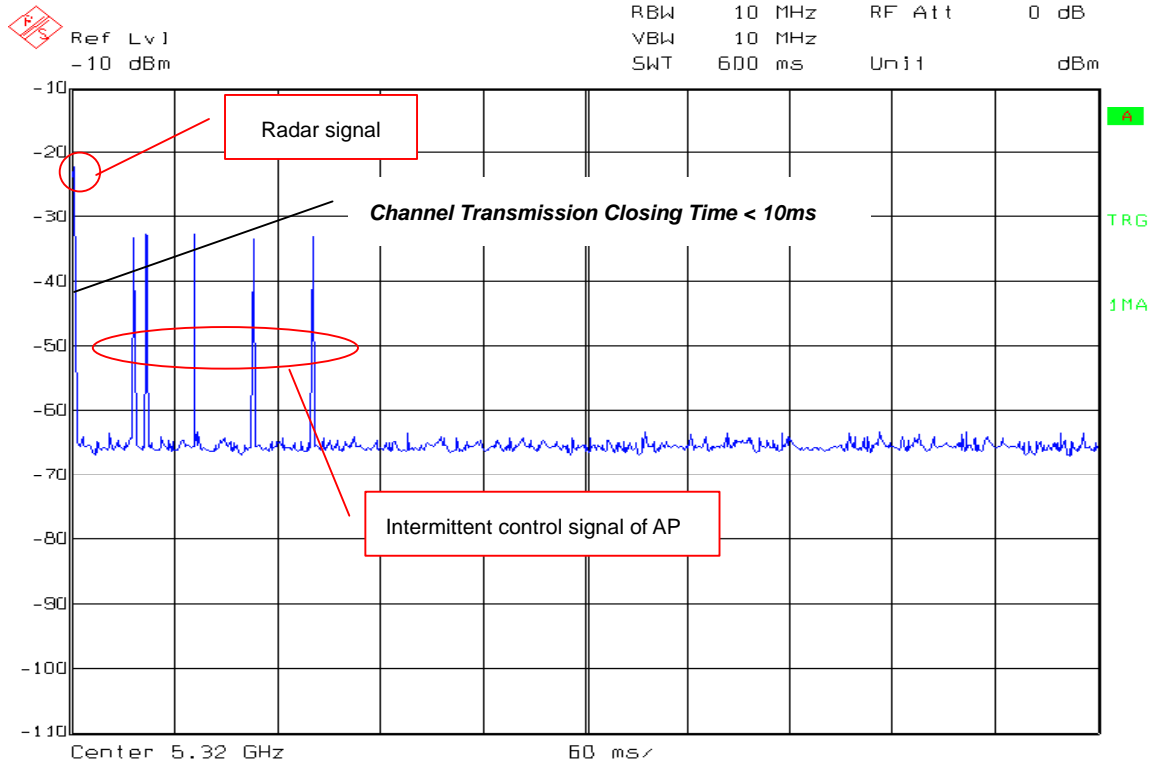

### Closing transmission AP packet number (5520MHz)

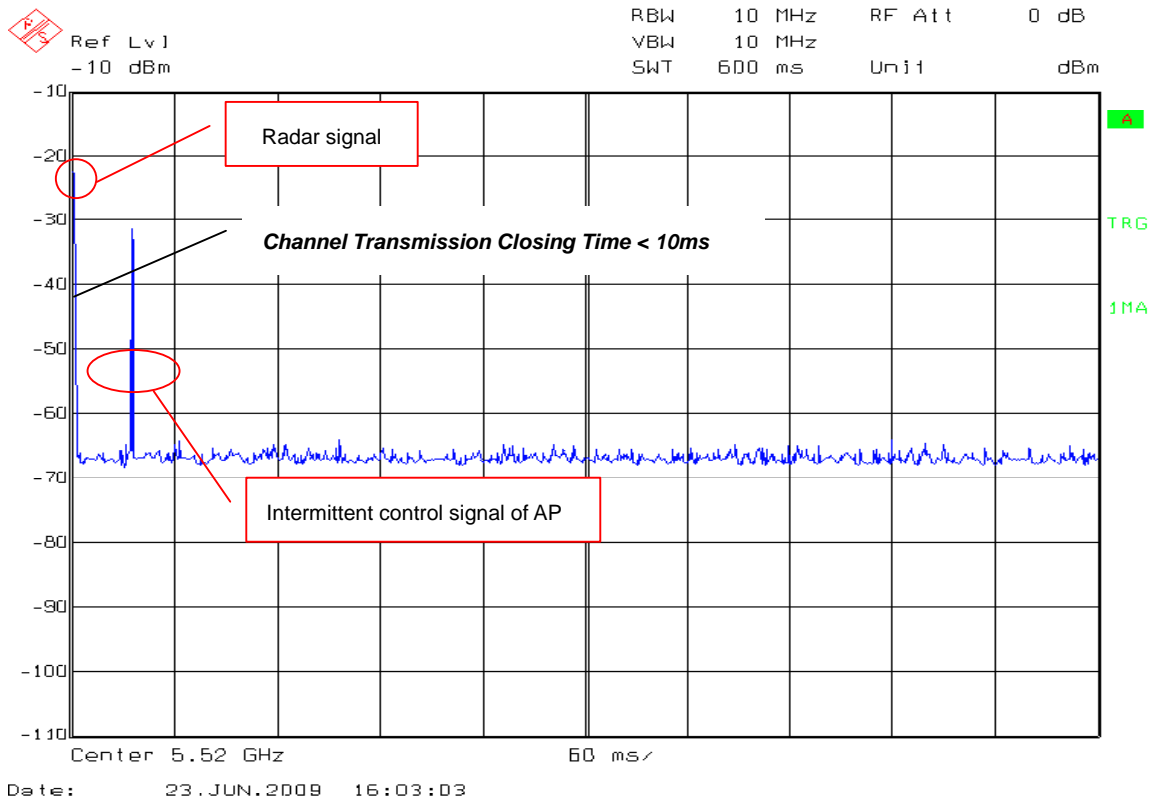

### 2.10.3 Non-Occupancy Period

No transmissions were observed on the previously active channel during 30 minutes observation time for the EUT.

Test plots

#### Frequency 5320MHz

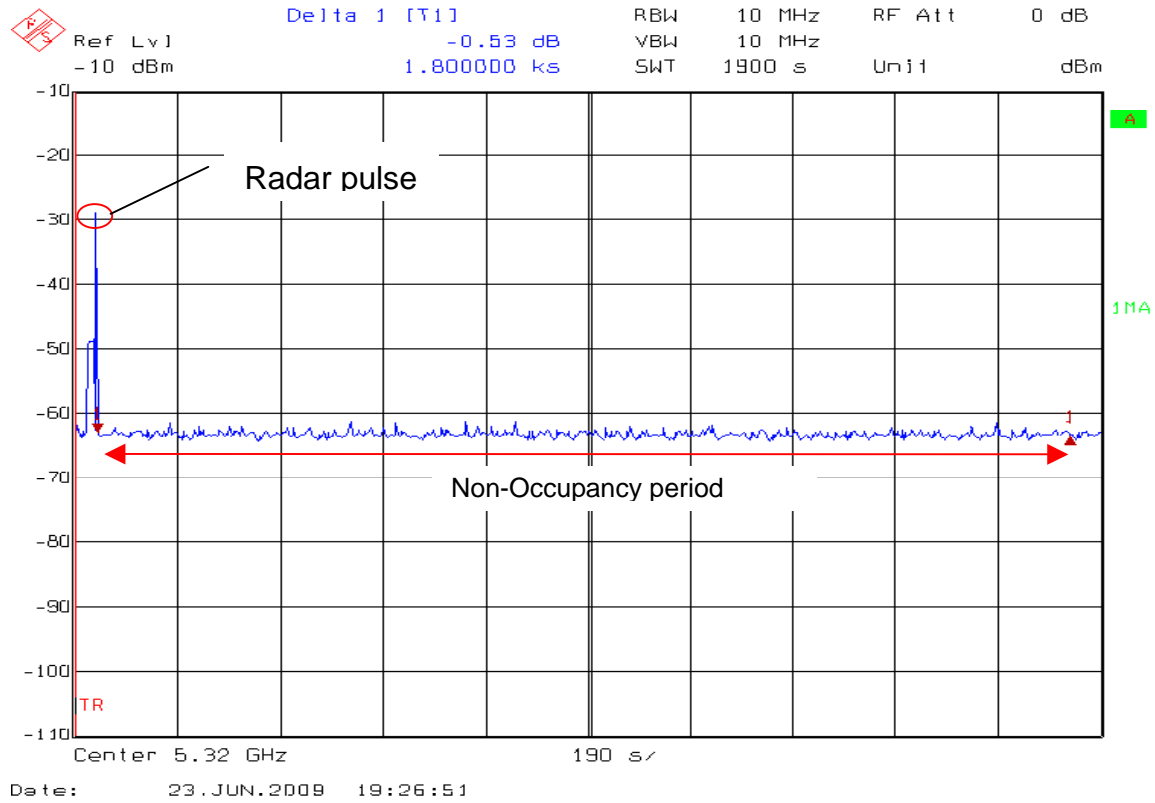

#### Frequency 5520MHz

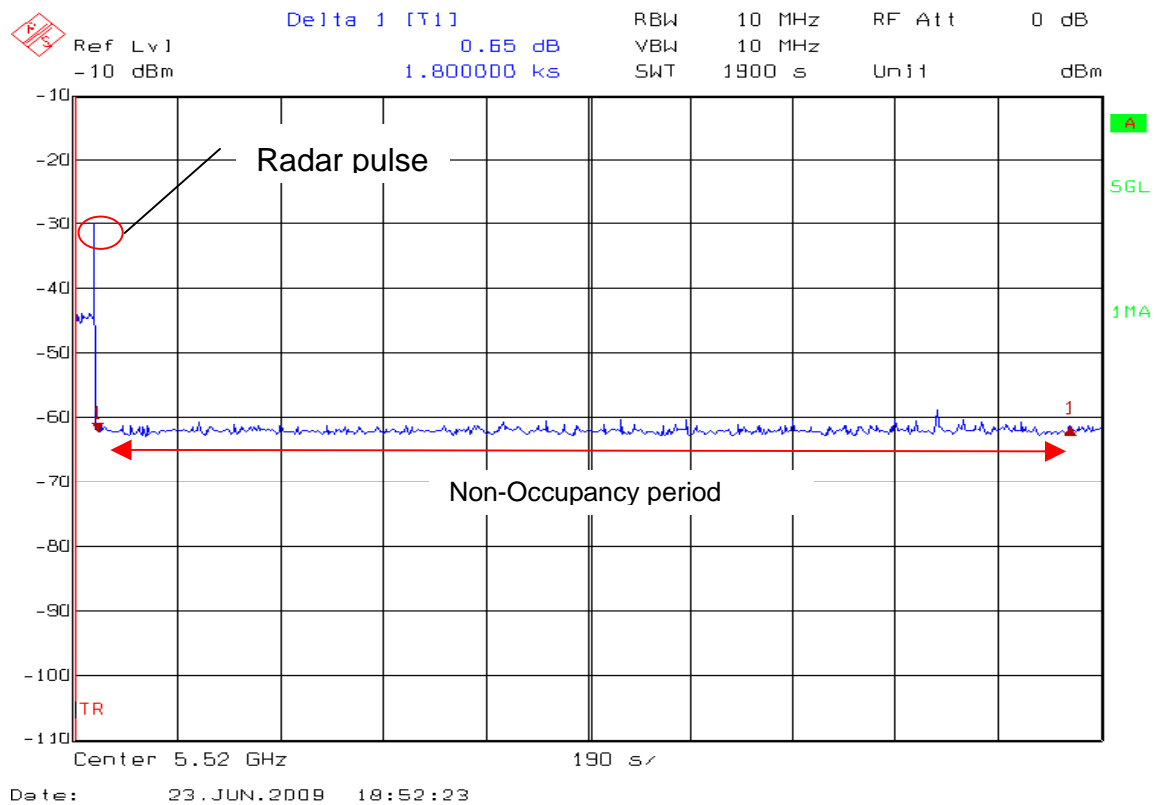

### 3 Photographs of Test

#### 3.1 DFS Test Measurement

