

# Dynamic Frequency Selection (DFS) Test Report

Product Name	Wireless gateway
Model No	MGate W5xyz, MGate W5xyz-T x represent the number of serial port. yz represent series number. -T represent wide temperature model
FCC ID	SLE-W5X08

Applicant	MOXA Inc.
Address	FL.4, NO.135 LANE 235, BAOQIAO RD. XINDIAN DIST., NEW TAIPEI CITY, TAIWAN

Date of Receipt	Jul. 01, 2015
Issued Date	Sep. 23, 2015
Report No.	1570097R-RFUSP47V00-A
Report Version	V1.0



The test results relate only to the samples tested.  
 The test results shown in the test report are traceable to the national/international standard through the calibration report of the equipment and evaluated measurement uncertainty herein.  
 This report must not be used to claim product endorsement by TAF or any agency of the government.  
 The test report shall not be reproduced without the written approval of Quietek Corporation.

# DFS Test Report

Issued Date: Sep. 23, 2015

Report No.: 1570097R-RFUSP47V00-A



Product Name	Wireless gateway
Applicant	MOXA Inc.
Address	FL.4, NO.135 LANE 235, BAOQIAO RD. XINDIAN DIST., NEW TAIPEI CITY, TAIWAN
Manufacturer	MOXA Inc.
Model No.	MGate W5xyz, MGate W5xyz-T x represent the number of serial port. yz represent series number. -T represent wide temperature model
FCC ID.	SLE-W5X08
EUT Rated Voltage	DC 12V
EUT Test Voltage	DC 12V
Trade Name	MOXA
Applicable Standard	FCC CFR Title 47 Part 15 Subpart E 15.407 (h): 2014 KDB 905462 D02 UNII DFS Compliance Procedures KDB 905462 D03 UNII Clients Without Radar Detection FCC 14-30
Test Result	Complied

Documented By :   
 \_\_\_\_\_  
 ( Senior Adm. Specialist / Joanne Lin )

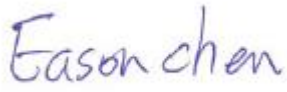
Tested By :   
 \_\_\_\_\_  
 ( Engineer / Eason Chen )

Approved By :   
 \_\_\_\_\_  
 ( Director / Vincent Lin )

## TABLE OF CONTENTS

Description	Page
<b>1. GENERAL INFORMATION .....</b>	<b>4</b>
1.1. EUT Description .....	4
1.2. Standard Requirement .....	6
1.3. UNII Device Description .....	6
1.4. Test Equipment .....	7
1.5. Test Setup .....	8
1.6. DFS Requirements Prior to Use of a Channel .....	8
1.7. DFS requirements during normal operation.....	9
1.8. DFS Detection Thresholds .....	9
1.9. Radar Test Waveforms .....	10
1.10. Radar Waveform Calibration .....	15
1.11. Radar Waveform Calibration Result .....	16
1.12. Slave Data Traffic Plot Result.....	17
<b>2. IN-SERVICE MONITORING FOR CHANNEL MOVE TIME AND CHANNEL CLOSING</b>	
<b>TRANSMISSION TIME AND NON-OCCUPANCY PERIOD .....</b>	<b>18</b>
2.1. Test Procedure .....	18
2.2. Test Requirement .....	18
2.3. Uncertainty .....	18
2.4. Test Result of Channel Move Time and Channel Closing Transmission Time and Non-Occupancy Period .....	19
<b>3. DFS TEST SETUP PHOTO.....</b>	<b>25</b>

Attachment 1: EUT Test Photographs

## 1. GENERAL INFORMATION

### 1.1. EUT Description

Product Name	Wireless gateway
Trade Name	MOXA
FCC ID.	SLE-W5X08
Model No.	MGate W5xyz, MGate W5xyz-T x represent the number of serial port. yz represent series number. -T represent wide temperature model
Frequency Range	802.11a/n-20MHz: 5180-5320MHz, 5500-5700MHz, 5745-5825MHz 802.11n-40MHz: 5190-5310, 5510-5670MHz, 5755-5795MHz
Number of Channels	802.11a/n-20MHz: 24; 802.11n-40MHz: 11
Data Rate	802.11a: 6 - 54Mbps, 802.11n: up to 150Mbps
Type of Modulation	OFDM, BPSK, QPSK, 16QAM, 64QAM
Channel Control	Auto
DFS Function	<input type="checkbox"/> Master <input checked="" type="checkbox"/> Slave (Without Radar Detection)
TPC Function	<input checked="" type="checkbox"/> <500mW not required <input type="checkbox"/> $\geq$ 500mW employ a TPC
Communication Mode	<input checked="" type="checkbox"/> IP Based Systems <input type="checkbox"/> Frame Based System <input type="checkbox"/> Other System
Antenna type	Dipole Antenna

#### Antenna List

No.	Manufacturer	Part No.	Antenna Type	Peak Gain
1	KINSUN	6602D03081	Dipole	1.73dBi For 5.15~5.25GHz 1.73dBi For 5.25~5.35GHz 1.73dBi For 5.47~5.725GHz 1.73dBi For 5.725~5.825GHz

802.11a/n-20MHz Center Working Frequency of Each Channel:

Channel	Frequency	Channel	Frequency	Channel	Frequency	Channel	Frequency
Channel 36:	5180 MHz	Channel 40:	5200 MHz	Channel 44:	5220 MHz	Channel 48:	5240 MHz
Channel 52:	5260 MHz	Channel 56:	5280 MHz	Channel 60:	5300 MHz	Channel 64:	5320 MHz
Channel 100:	5500 MHz	Channel 104:	5520 MHz	Channel 108:	5540 MHz	Channel 112:	5560 MHz
Channel 116:	5580 MHz	Channel 120:	5600 MHz	Channel 124:	5620 MHz	Channel 128:	5640 MHz
Channel 132:	5660 MHz	Channel 136:	5680 MHz	Channel 140:	5700 MHz	Channel 149:	5745 MHz
Channel 153:	5765 MHz	Channel 157:	5785 MHz	Channel 161:	5805 MHz	Channel 165:	5825 MHz

802.11n-40MHz Center Working Frequency of Each Channel:

Channel	Frequency	Channel	Frequency	Channel	Frequency	Channel	Frequency
Channel 38:	5190 MHz	Channel 46:	5230 MHz	Channel 54:	5270 MHz	Channel 62:	5310 MHz
Channel 102:	5510 MHz	Channel 110:	5550 MHz	Channel 118:	5590 MHz	Channel 126:	5630 MHz
Channel 134:	5670 MHz	Channel 151:	5755 MHz	Channel 159:	5795 MHz		

Test Mode	Mode 1: Transmit
-----------	------------------

## 1.2. Standard Requirement

### FCC Part 15.407:

U-NII devices operating in the 5.25-5.35 GHz band and the 5.47-5.725 GHz band shall employ a TPC mechanism. The U-NII device is required to have the capability to operate at least 6 dB below the mean EIRP value of 30dBm. A TPC mechanism is not required for systems with an E.I.R.P. of less than 500mW.

U-NII devices operating in the 5.25-5.35 GHz and 5.47-5.725 GHz bands shall employ a DFS radar detection mechanism to detect the presence of radar systems and to avoid co-channel operation with radar systems.

## 1.3. UNII Device Description

(1) The EUT operates in the following DFS band:

1. 5250-5350 MHz
2. 5470-5725 MHz

(2) The maximum EIRP of the 5GHz equipment is 16.93dBm.

Below are the available 50 ohm antenna assemblies and their corresponding gains. 0dBi gain was used to set the -63 dBm threshold level (-64dBm +1 dB) during calibration of the test setup.

No.	Manufacturer	Part No.	Antenna Type	Peak Gain
1	KINSUN	6602D03081	Dipole	1.73dBi For 5.15~5.25GHz 1.73dBi For 5.25~5.35GHz 1.73dBi For 5.47~5.725GHz 1.73dBi For 5.725~5.825GHz

(3) DFS operation description:

WLAN traffic is generated by streaming the video file "TestFile.mp2" from the Master device to the Slave device in full motion video mode using the media player with the V2.61 Codec package.

(4) This device does not exceed 27dBm eirp, so no transmit power control is implemented.

(5) The master device is an Access Point and FCC ID: SLE-W5X08.

## 1.4. Test Equipment

### Dynamic Frequency Selection (DFS) / CTR

Instrument	Manufacturer	Type No.	Serial No	Cal. Date
Spectrum Analyzer	Agilent	E4440A	MY46185846	Nov, 29, 2014
Vector Signal Generator	Agilent	E4438C	MY49070137	May, 2, 2015

Instrument	Manufacturer	Type No.	Serial No
Splitter/Combiner (Qty: 2)	Mini-Circuits	ZFRSC-123-S+	SN331000910
Notebook Pc	Hp	HSTNN-155C	CNU8476RVZ
Notebook Pc	Compaq	CPQ511VT5870Q4X320MIBN CN2Pa	CNU0060M23
8-WAY Power Divider	JFW	50PD-647-SMA	517518
8-WAY Power Divider	JFW	50PD-647-SMA	--
RF Cable (Qty: 4)	GORE	C86	N/A
ATT (Qty: 2)	Mini-Circuits	15542	30912
ATT (Qty: 2)	Mini-Circuits	15542	30909
RF Cable	SUHNER	SUCOFLEX 104	309180/4
RF Cable	SUHNER	SUCOFLEX 106	3474516
Splitter/Combiner (Qty: 2)	Mini-Circuits	ZFRSC-123-S+	SN331000910
Access Point	XiRRUS	XR300	X103502006E80
Notebook PC	Dell	M65	DYTKN1S

Software	Manufacturer	Function
Agilent Signal Studio for Pulse Building V1.3.13.0	Agilent	Radar Signal Generation Software
Agilent DFS_TEST V1.0.0.73	Agilent	Radar Signal Generation Software

### 1.5. Test Setup

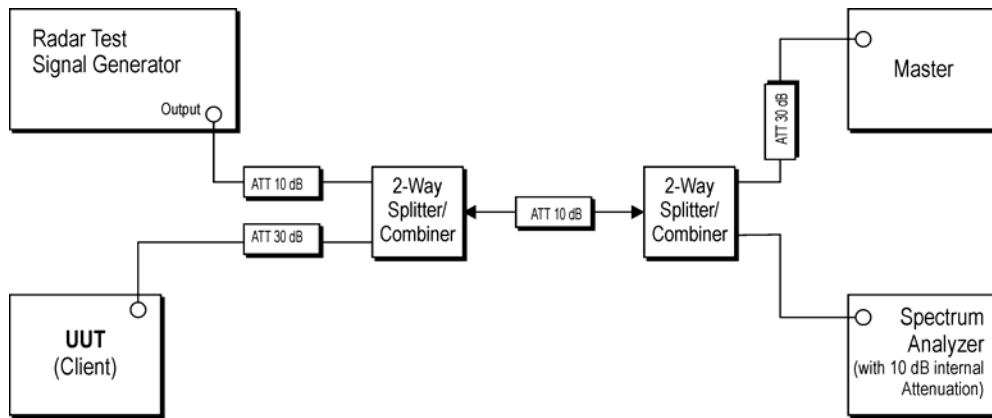

### 1.6. DFS Requirements Prior to Use of a Channel

Requirement	Operational Mode		
	Master	Client Without Radar Detection	Client With Radar Detection
<i>Non-Occupancy Period</i>	Yes	Not required	Yes
<i>DFS Detection Threshold</i>	Yes	Not required	Yes
<i>Channel Availability Check Time</i>	Yes	Not required	Not required
<i>Uniform Spreading</i>	Yes	Not required	Not required
<i>U-NII Detection Bandwidth</i>	Yes	Not required	Yes



**1.7. DFS requirements during normal operation**

Requirement	Operational Mode		
	Master	Client Without Radar Detection	Client With Radar Detection
<i>DFS Detection Threshold</i>	Yes	Not required	Yes
<i>Channel Closing Transmission Time</i>	Yes	Yes	Yes
<i>Channel Move Time</i>	Yes	Yes	Yes
<i>U-NII Detection Bandwidth</i>	Yes	Not required	Yes

**1.8. DFS Detection Thresholds**

**(1) Interference Threshold value, Master or Client incorporating In-Service Monitoring**

Maximum Transmit Power	Value (see note)
≥ 200 milliwatt	-64 dBm
EIRP < 200 milliwatt and power spectral density < 10 dBm/MHz	-62 dBm
EIRP < 200 milliwatt that do not meet the power spectral density requirement	-64 dBm
<p>Note 1: This is the level at the input of the receiver assuming a 0 dBi receive antenna.</p> <p>Note 2: Throughout these test procedures an additional 1 dB has been added to the amplitude of the test transmission waveforms to account for variations in measurement equipment. This will ensure that the test signal is at or above the detection threshold level to trigger a DFS response.</p> <p>Note3: EIRP is based on the highest antenna gain. For MIMO devices refer to KDB Publication 662911 D01.</p>	

**(2) DFS Response requirement values**

Parameter	Value
Non-Occupancy Period	30 Minutes
Channel Availability Check Time	60 Seconds
Channel Move Time	10 seconds See Note 1.
Channel Closing Transmission Time	200 milliseconds + an aggregate of 60 milliseconds over remaining 10 second period. See Notes 1 and 2.
U-NII Detection Bandwidth	Minimum 100% of the U-NII 99% transmission power bandwidth. See Note 3.
<p>Note 1: Channel Move Time and the Channel Closing Transmission Time should be performed with Radar Type 0. The measurement timing begins at the end of the Radar Type 0 burst.</p> <p>Note 2: The Channel Closing Transmission Time is comprised of 200 milliseconds starting at the beginning of the Channel Move Time plus any additional intermittent control signals required to facilitate a Channel move (an aggregate of 60 milliseconds) during the remainder of the 10 second period. The aggregate duration of control signals will not count quiet periods in between transmissions.</p> <p>Note 3: During the U-NII Detection Bandwidth detection test, radar type 0 should be used. For each frequency step the minimum percentage of detection is 90 percent. Measurements are performed with no data traffic.</p>	

**1.9. Radar Test Waveforms**

This section provides the parameters for required test waveforms, minimum percentage of successful detections, and the minimum number of trials that must be used for determining DFS conformance. Step intervals of 0.1 microsecond for Pulse Width, 1 microsecond for PRI, 1 MHz for chirp width and 1 for the number of pulses will be utilized for the random determination of specific test waveforms.

(1) Short Pulse Radar Test Waveforms

Radar Type	Pulse Width (μsec)	PRI (μsec)	Number of Pulses	Minimum Percentage of Successful Detection	Minimum Number of Trials
0	1	1428	18	See Note 1	See Note 1
1	1	Test A: 15 unique PRI values randomly selected from the list of 23 PRI values in Table 5a	Roundup $\left\{ \left( \frac{1}{360} \right) \cdot \left( \frac{19 \cdot 10^6}{PRI_{\mu sec}} \right) \right\}$	60%	30
		Test B: 15 unique PRI values randomly selected within the range of 518-3066 μ sec, with a minimum increment of 1 μ sec, excluding PRI values selected in Test A			
2	1-5	150-230	23-29	60%	30
3	6-10	200-500	16-18	60%	30
4	11-20	200-500	12-16	60%	30
Aggregate (Radar Types 1-4)				80%	120
<b>Note 1:</b> Short Pulse Radar Type 0 should be used for the detection bandwidth test, channel move time, and channel closing time tests.					

A minimum of 30 unique waveforms are required for each of the Short Pulse Radar Types 2 through 4. If more than 30 waveforms are used for Short Pulse Radar Types 2 through 4, then each additional waveform must also be unique and not repeated from the previous waveforms. If more than 30 waveforms are used for Short Pulse Radar Type 1, then each additional waveform is 905462 D02 UNII DFS Compliance Procedures v01 Page 10 generated with Test B and must also be unique and not repeated from the previous waveforms in Tests A or B.

**(2) Long Pulse Radar Test Signal**

Radar Waveform	Bursts	Pulses Per Burst	Pulse Width (usec)	Chirp Width (MHz)	PRI (usec)	Minimum Percentage of Successful Detection	Minimum Trials
5	8-20	1-3	50-100	5-20	1000-2000	80%	30

The parameters for this waveform are randomly chosen. Thirty unique waveforms are required for the long pulse radar test signal. If more than 30 waveforms are used for the long pulse radar test signal, then each additional waveform must also be unique and not repeated from the previous waveforms.

Each waveform is defined as follows:

- 1) The transmission period for the Long Pulse Radar test signal is 12 seconds.
- 2) There are a total of 8 to 20 Bursts in the 12 second period, with the number of Bursts being randomly chosen. This number is Burst\_Count.
- 3) Each Burst consists of 1 to 3 pulses, with the number of pulses being randomly chosen. Each Burst within the 12 second sequence may have a different number of pulses.
- 4) The pulse width is between 50 and 100 microseconds, with the pulse width being randomly chosen. Each pulse within a Burst will have the same pulse width. Pulses in different Bursts may have different pulse widths.
- 5) Each pulse has a linear FM chirp between 5 and 20 MHz, with the chirp width being randomly chosen. Each pulse within a Burst will have the same chirp width. Pulses in different Bursts may have different chirp widths. The chirp is centered on the pulse. For example, with radar frequency of 5310 MHz and a 20 MHz chirped signal, the chirp starts at 5300 MHz and ends at 5320 MHz.
- 6) If more than one pulse is present in a Burst, the time between the pulses will be between 1000 and 2000 microseconds, with the time being randomly chosen. If three pulses are present in a Burst, the time between the first and second pulses is chosen independently of the time between the second and third pulses.
- 7) The 12 second transmission period is divided into even intervals. The number of intervals is equal to Burst\_Count. Each interval is of length  $(12,000,000 / \text{Burst\_Count})$  microseconds. Each interval contains one Burst. The start time for the Burst, relative to the beginning of the interval, is between 1 and  $[(12,000,000 / \text{Burst\_Count}) - (\text{Total Burst Length}) + (\text{One Random PRI Interval})]$  microseconds, with the start time being randomly chosen. The step interval for the start time is 1 microsecond. The start time for each Burst is chosen independently.

**A representative example of a Long Pulse radar test waveform:**

- 1) The total test signal length is 12 seconds.
- 2) 8 Bursts are randomly generated for the Burst\_Count.
- 3) Burst 1 has 2 randomly generated pulses.
- 4) The pulse width (for both pulses) is randomly selected to be 75 microseconds.
- 5) The PRI is randomly selected to be at 1213 microseconds.
- 6) Bursts 2 through 8 are generated using steps 3 – 5.
- 7) Each Burst is contained in even intervals of 1,500,000 microseconds. The starting location for Pulse 1, Burst 1 is randomly generated (1 to 1,500,000 minus the total Burst 1 length + 1 random PRI interval) at the 325,001 microsecond step. Bursts 2 through 8 randomly fall in successive 1,500,000 microsecond intervals (i.e. Burst 2 falls in the 1,500,001 – 3,000,000 microsecond range).

*Graphical Representation of a Long Pulse radar Test Waveform*

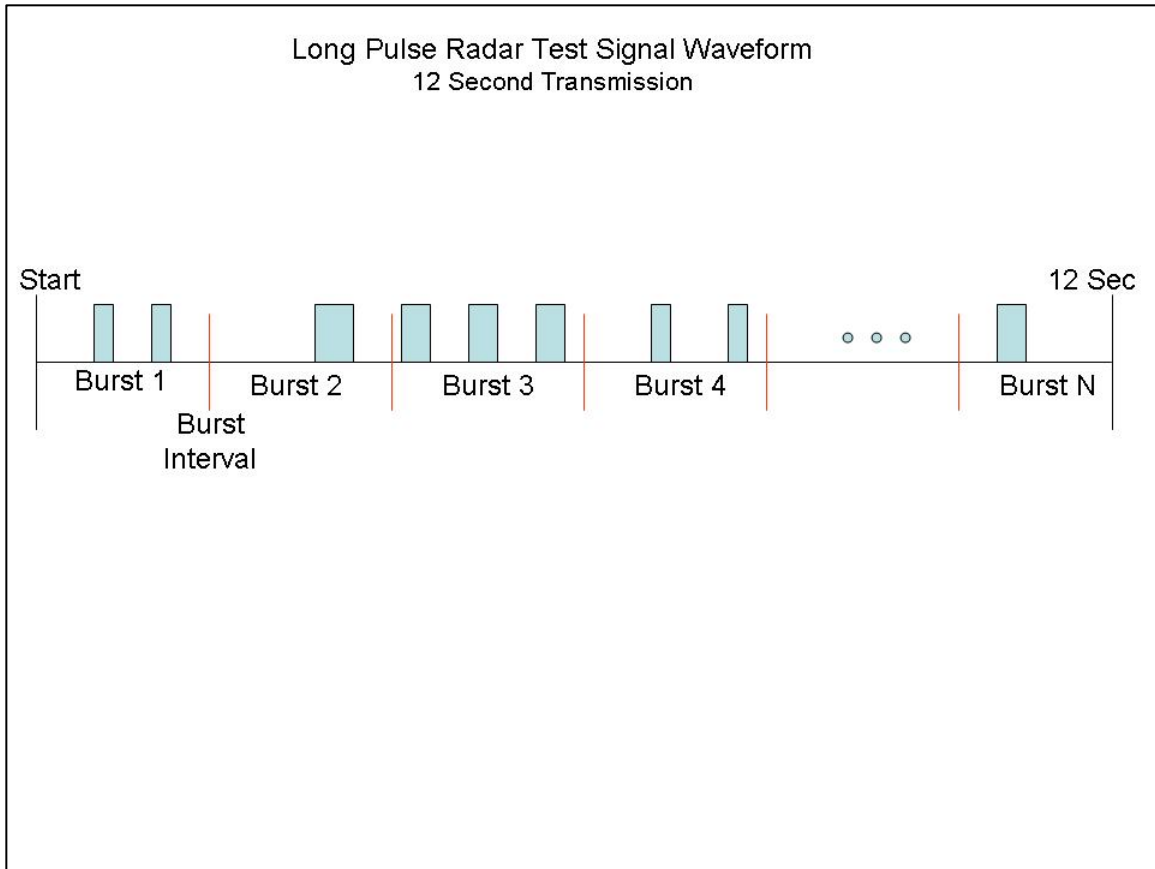

**(3) Frequency Hopping Radar Test Signal**

Radar Waveform	Pulse Width ( $\mu\text{sec}$ )	PRI ( $\mu\text{sec}$ )	Hopping Sequence Length (msec)	Pulses Per Hop	Hopping Rate (kHz)	Minimum Percentage of Successful Detection	Minimum Trials
6	1	333	300	9	0.333	70%	30

For the Frequency Hopping Radar Type, the same *Burst* parameters are used for each waveform. The hopping sequence is different for each waveform and a 100-length segment is selected from the hopping sequence defined by the following algorithm:

The first frequency in a hopping sequence is selected randomly from the group of 475 integer frequencies from 5250 – 5724 MHz. Next, the frequency that was just chosen is removed from the group and a frequency is randomly selected from the remaining 474 frequencies in the group. This process continues until all 475 frequencies are chosen for the set. For selection of a random frequency, the frequencies remaining within the group are always treated as equally likely.

### 1.10. Radar Waveform Calibration

The following equipment setup was used to calibrate the conducted radar waveform. A spectrum analyzer was used to establish the test signal level for each radar type. During this process there were replace 50ohm terminal from master and client device and no transmissions by either the master or client device. The spectrum analyzer was switched to the zero span (time domain) at the frequency of the radar waveform generator. Peak detection was utilized. The spectrum analyzer resolution bandwidth (RBW) and video bandwidth (VBW) were set to 3MHz and 3 MHz.

The signal generator amplitude was set so that the power level measured at the spectrum analyzer was -64dBm due to the interference threshold level is not required.

#### Conducted Calibration Setup

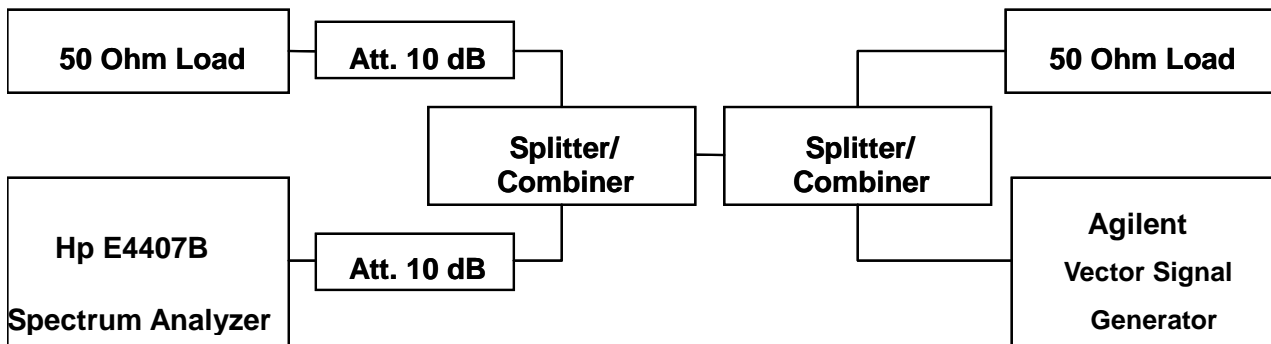

### 1.11. Radar Waveform Calibration Result

**Radar Type 0 Calibration Plot (5300MHz)**

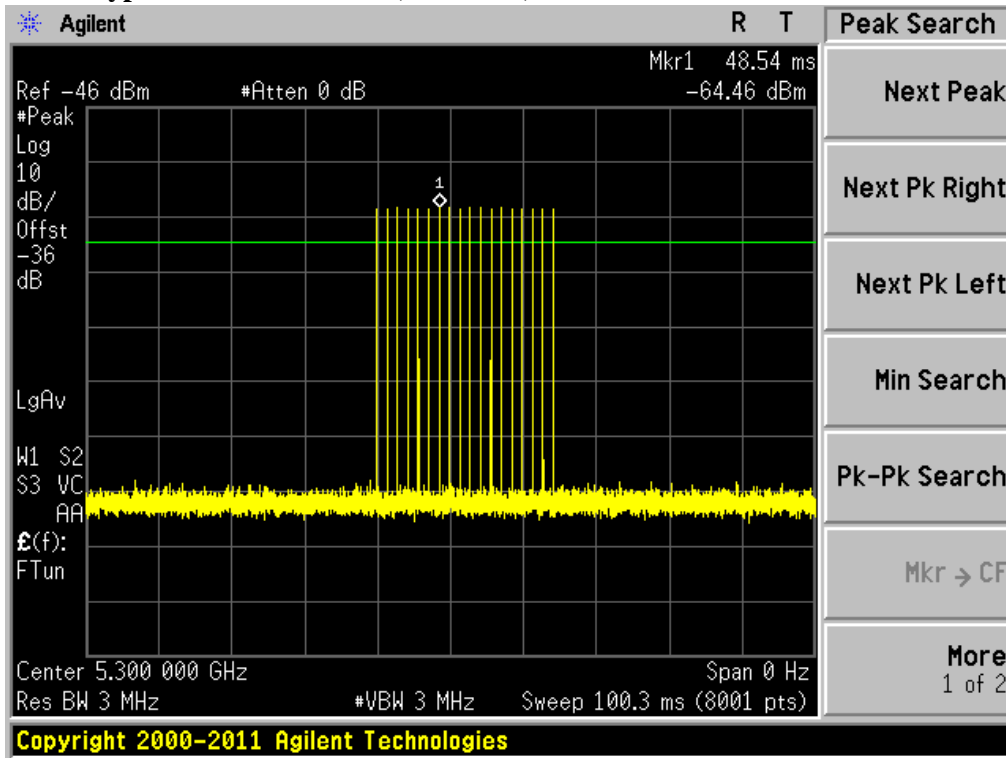

**Radar Type 0 Calibration Plot (5510MHz)**

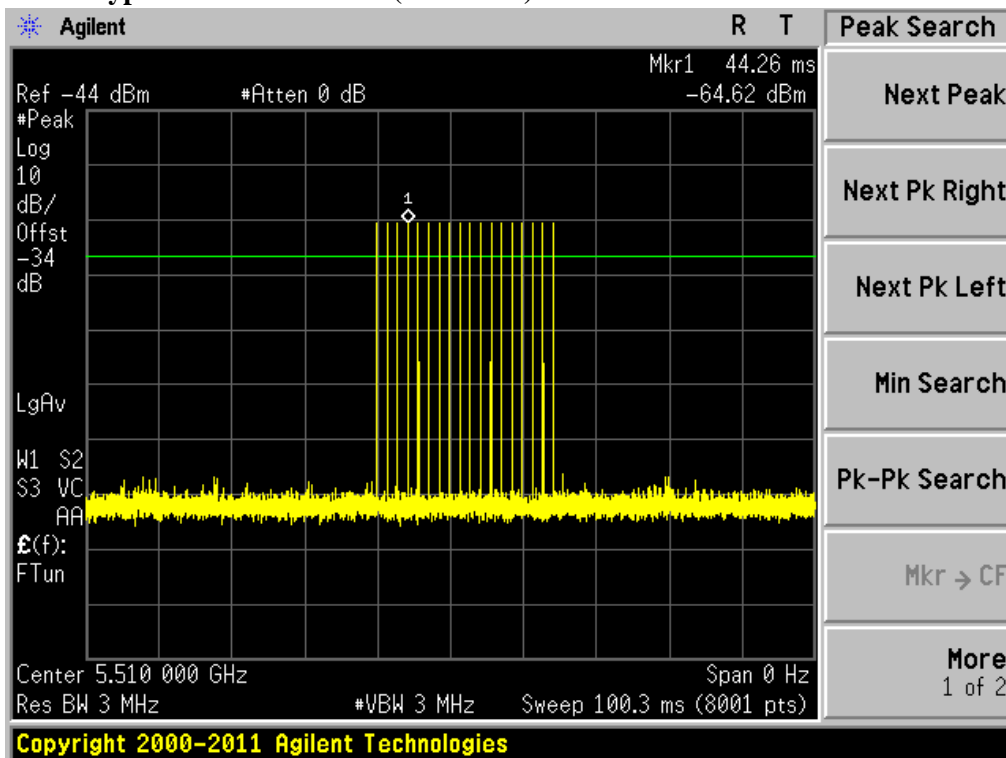



### 1.12. Slave Data Traffic Plot Result

Plot of Slave Traffic at 5300MHz

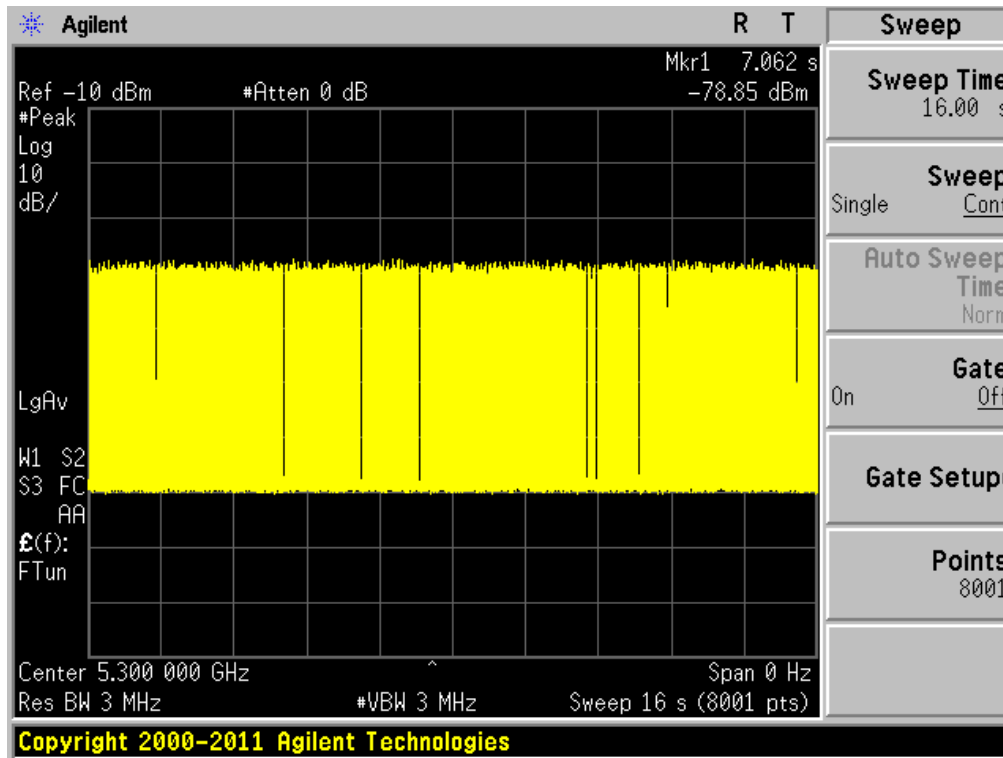

Plot of Slave Traffic at 5510MHz

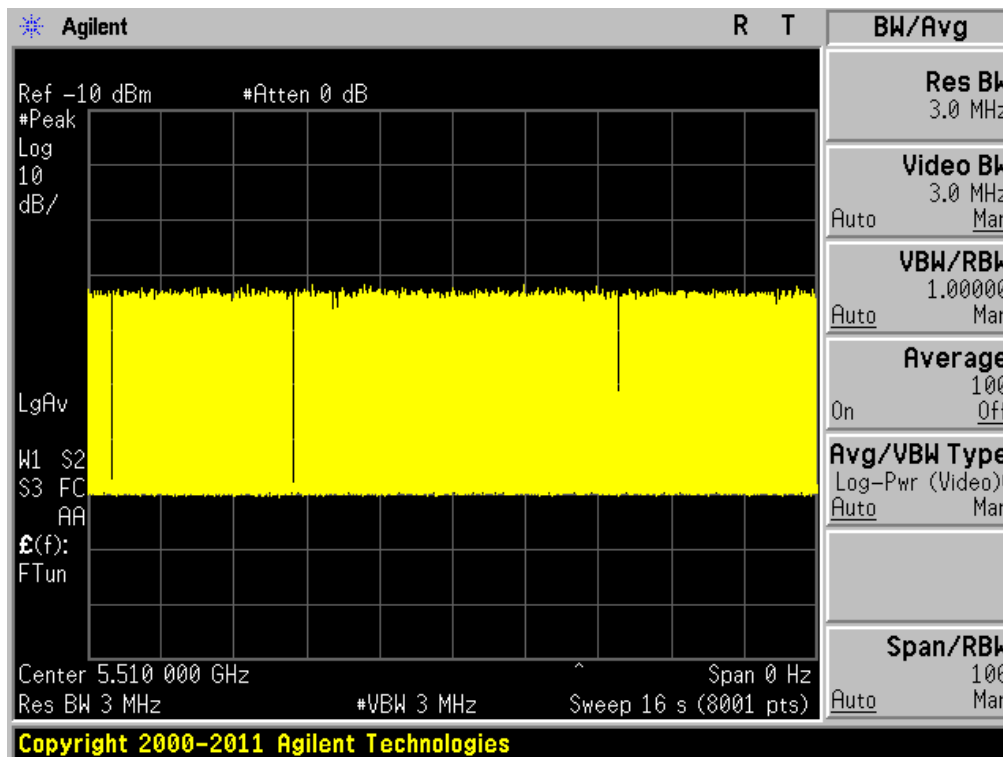

## 2. In-Service Monitoring for Channel Move Time and Channel Closing Transmission Time and Non-Occupancy Period

### 2.1. Test Procedure

These tests define how the following DFS parameters are verified during In-Service Monitoring;

Channel Closing Transmission Time, Channel Move Time, and Non-Occupancy Period.. The steps below define the procedure to determine the above mentioned parameters when a radar Burst with a level equal to the DFS Detection Threshold + 1dB (-63dBm) is generated on the Operating Channel of the U-NII device.

A U-NII device operating as a Master Device will associate with the UUT (Client) at 5300 MHz and 5500MHz.

Stream the MPEG test file from the Client (TX) Device to the Master (RX) Device on the selected Channel for the entire period of the test.

At time  $T_0$  the Radar Waveform generator sends a Burst of pulses for each of the radar types at -63dBm.

Observe the transmissions of the UUT at the end of the radar Burst on the Operating Channel for duration greater than 10 seconds. Measure and record the transmissions from the UUT during the observation time (Channel Move Time). Compare the Channel Move Time and Channel Closing

Transmission Time results to the limits defined in the DFS Response requirement values table.

Measure the UUT for more than 30 minutes following the channel close/move time to verify that the UUT does not resume any transmissions on this Channel.

### 2.2. Test Requirement

Parameter	Value
Channel Move Time	10 Seconds
Channel Closing Transmission Time	200 milliseconds + an aggregate of 60 milliseconds over remaining 10 seconds period
Non-Occupancy Period	Minimum 30 minutes

### 2.3. Uncertainty

$\pm 1$ ms.

**2.4. Test Result of Channel Move Time and Channel Closing Transmission Time and Non-Occupancy Period**

Product : Wireless gateway  
 Test Item : Channel Move Time Test  
 Radar Type : Type 0  
 Test Mode : Mode 1: Transmit

**Channel Move Time for Radar Test Type 0 at 5300MHz**

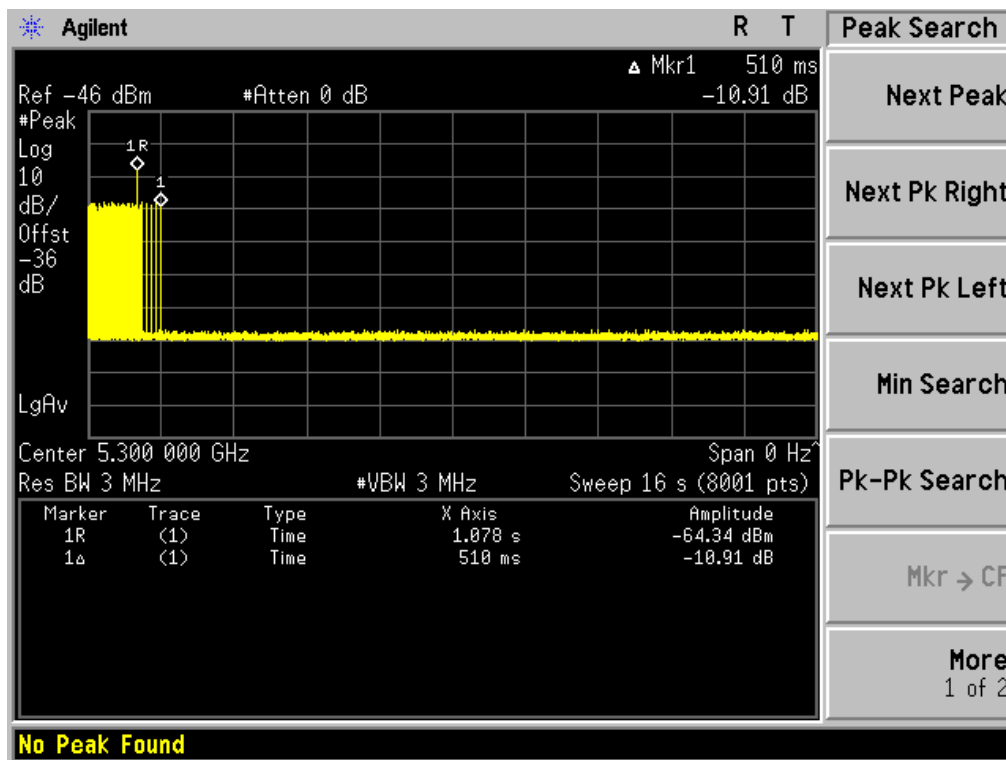

Test Item	Test Result (Sec)	Limit (Sec)
Channel Move Time	0.510	10

The results showed that after radar signal injected the channel move time was less than 10 seconds.

**Channel Move Time for Radar Test Type 0 at 5510MHz**

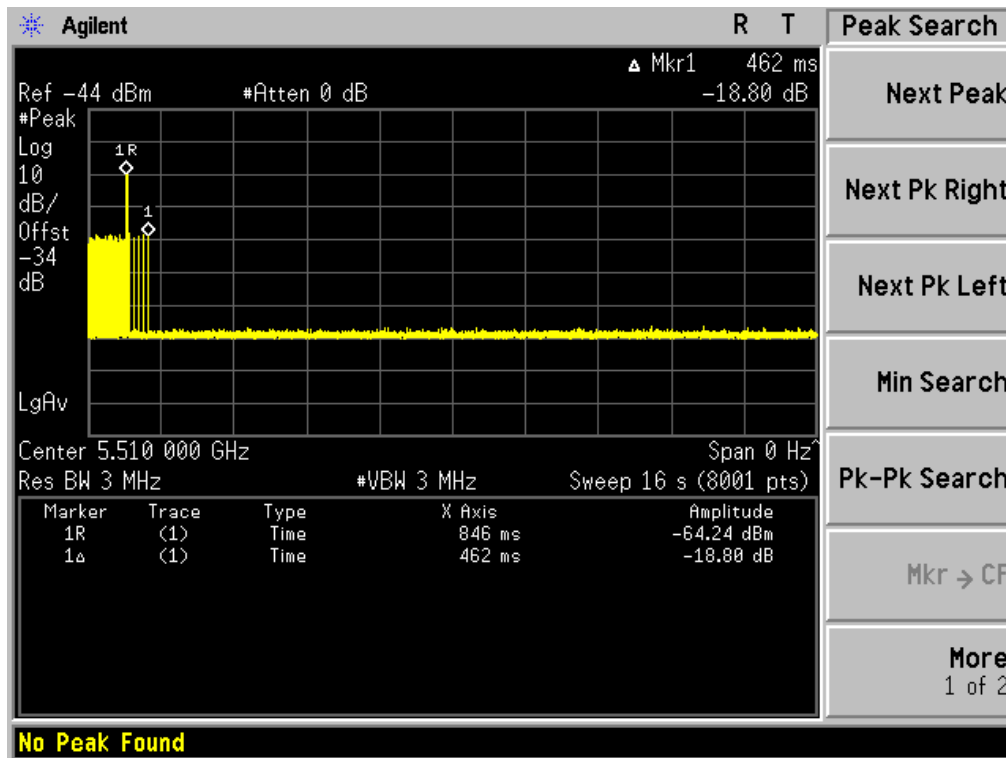

Test Item	Test Result (Sec)	Limit (Sec)
Channel Move Time	0.462	10

The results showed that after radar signal injected the channel move time was less than 10 seconds.

Product : Wireless gateway  
 Test Item : Channel Closing Transmission Time Test  
 Radar Type : Type 0  
 Test Mode : Mode 1: Transmit

**Channel Closing Transmission Time for Radar Test Type 0 at 5300 MHz**

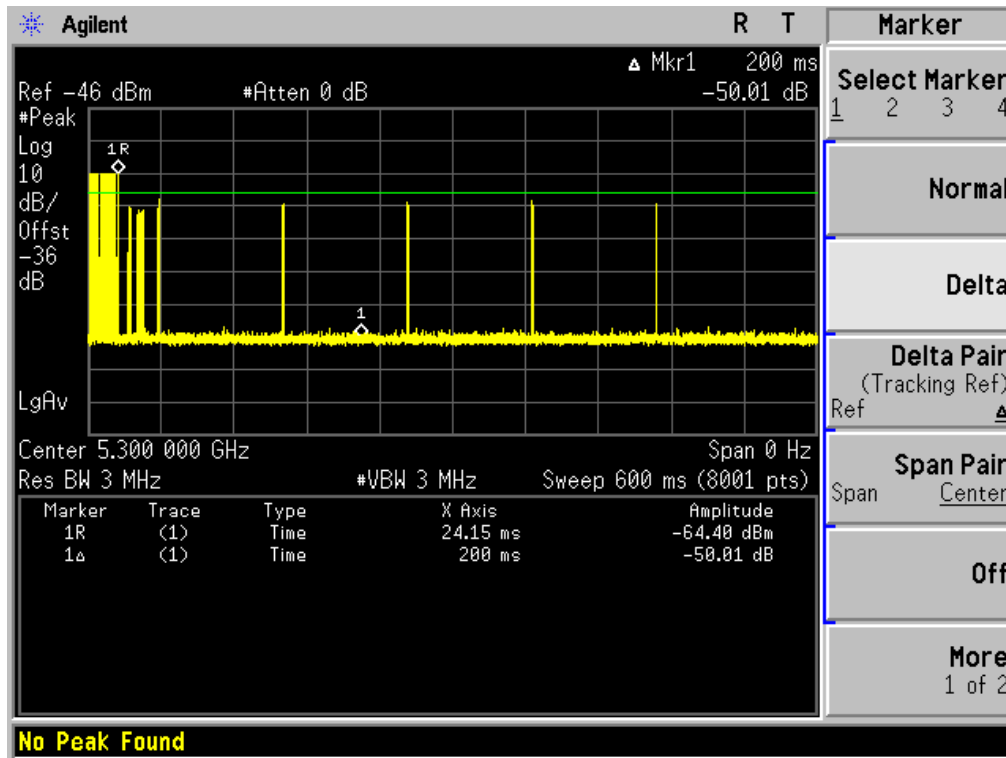

Test Item	Test Result (ms)	Limit (ms)
Channel Closing Transmission	0.375	200 milliseconds + approx. 60 milliseconds over remaining 10 seconds period

\*Note: The test result is “bin number X time per bin (600 ms / 8000)”

The results showed that after radar signal injected the channel transmission closing time less than 200 milliseconds and an aggregate of no more than 60 milliseconds.

**Channel Closing Transmission Time for Radar Test Type 0 at 5510 MHz**

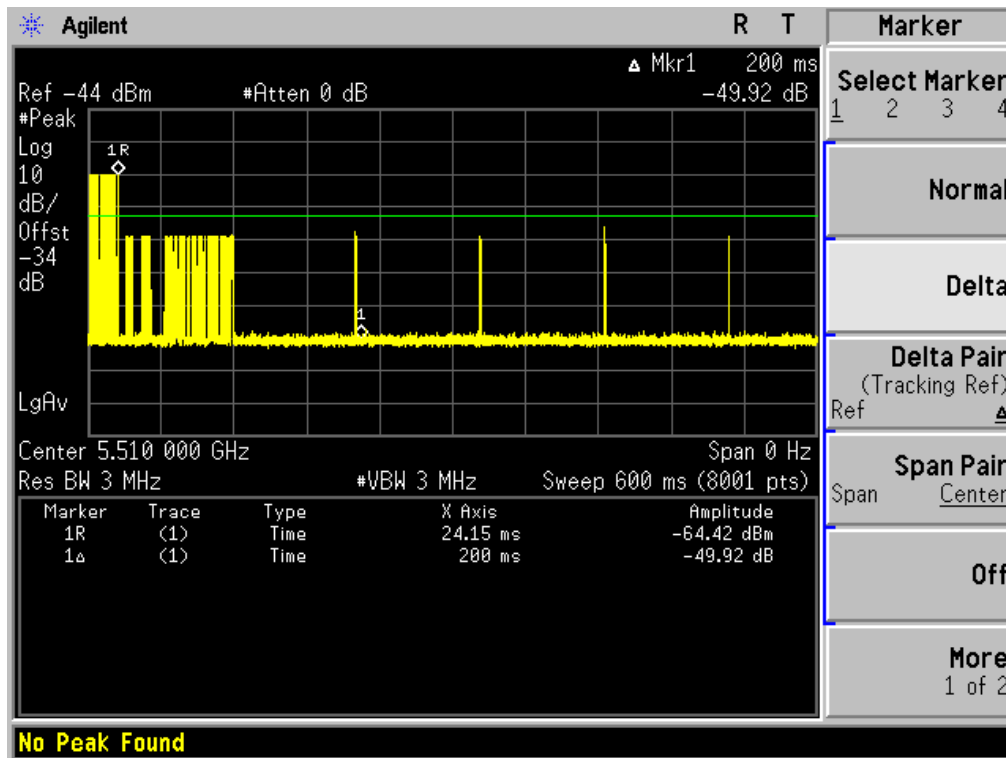

Test Item	Test Result (ms)	Limit (ms)
Channel Closing Transmission	0.375	200 milliseconds + approx. 60 milliseconds over remaining 10 seconds period

\*Note: The test result is “bin number X time per bin (600 ms / 8000)”

The results showed that after radar signal injected the channel transmission closing time less than 200 milliseconds and an aggregate of no more than 60 milliseconds.

Product : Wireless gateway  
 Test Item : Non-Occupancy Period  
 Radar Type : Type 0  
 Test Mode : Mode 1: Transmit

**Non-Occupancy Period at 5300 MHz**

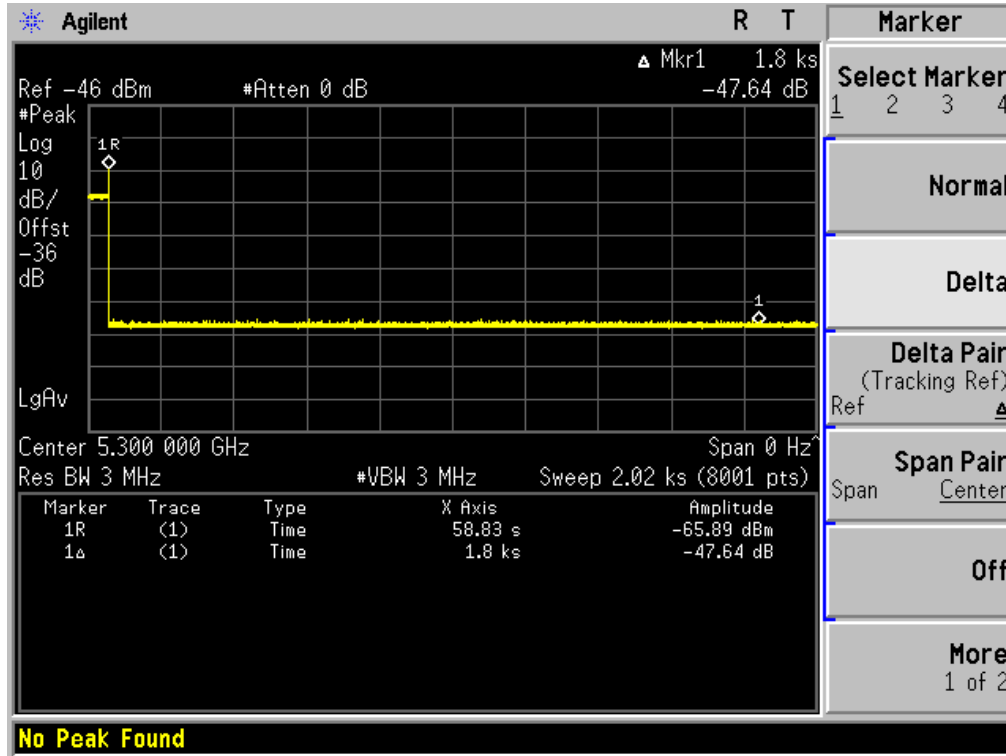

Test Item	Test Result (Minutes)	Limit (Minutes)
Non-Occupancy Period	>30	≥ 30

No EUT transmissions were observed on the test channel during 30 minutes observation time.

**Non-Occupancy Period at 5510 MHz**

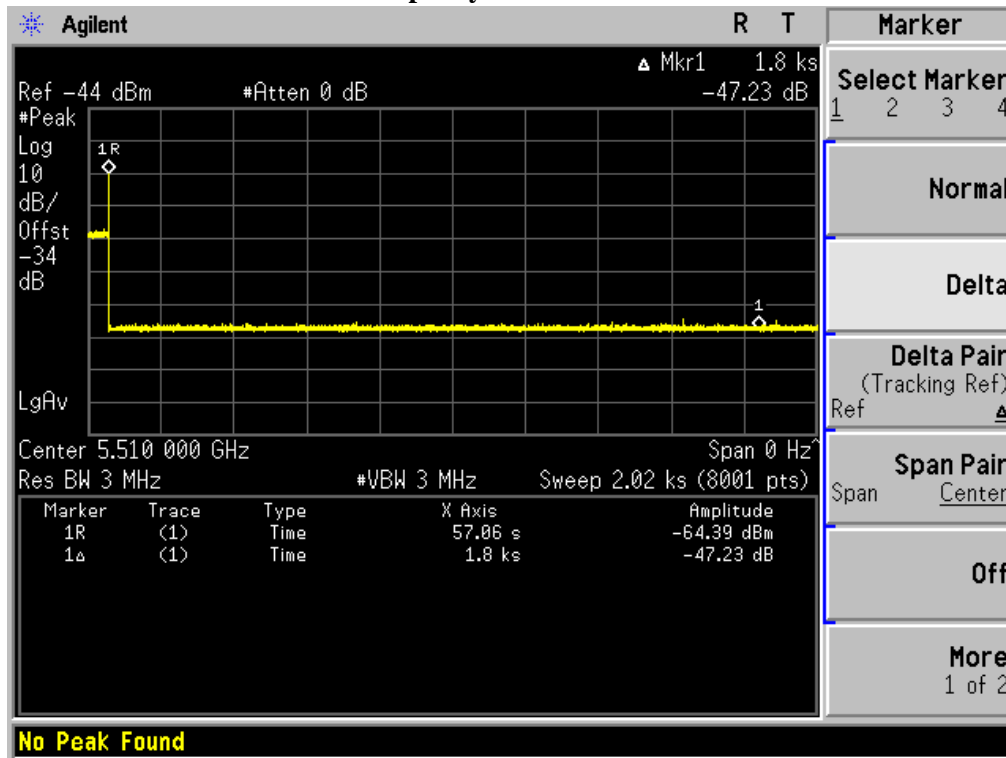

Test Item	Test Result (Minutes)	Limit (Minutes)
Non-Occupancy Period	>30	>30

No EUT transmissions were observed on the test channel during 30 minutes observation time.



### 3. DFS Test Setup Photo

#### Full DFS Test Setup Photo



#### DFS Set-up Photo: Master and Slave (UUT)

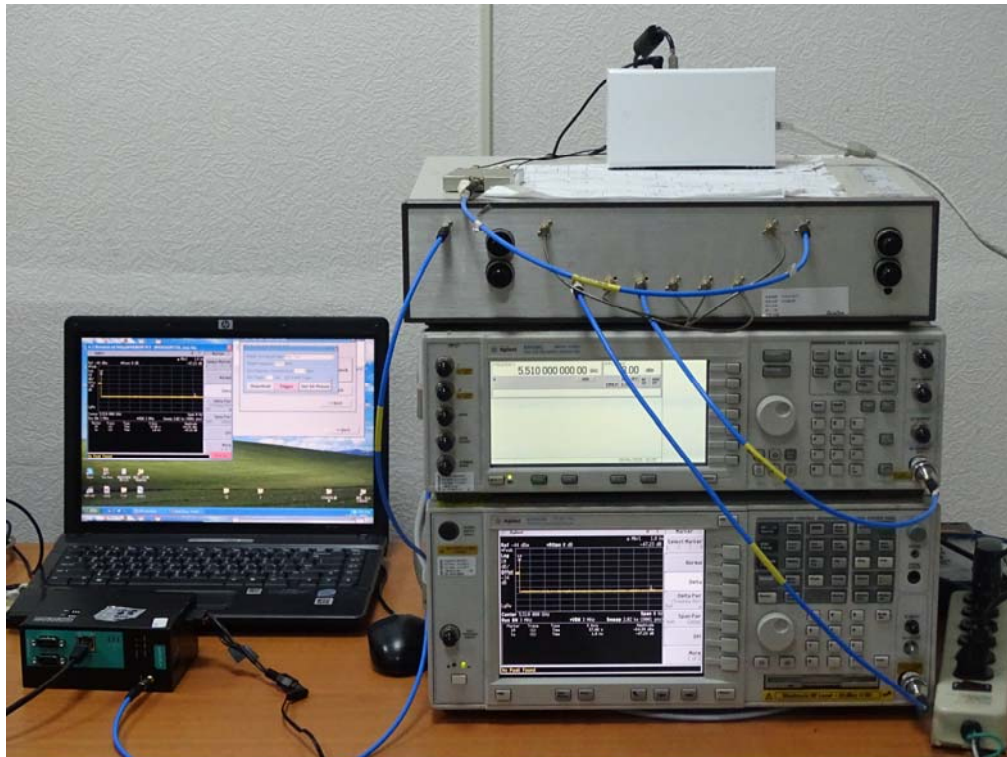

**Spectrum Analyzer and Radar Generator**

