

RF Antenna Assembly

Specification

1. Electrical Properties :

- 1.1 Frequency Range.....2.4GHz ~ 2.5GHz ;4.9GHz~5.825GHz
- 1.2 Impedance50Ω Nominal
- 1.3 VSWR2.1 :1Max.
- 1.4 Return Loss.....-9 dB Max.
- 1.5 RadiationOmni-directional
- 1.6 Gain(peak).....3.5±0.5dBi @ 2.4GHz ~ 2.5GHz
6.0±1.0dBi@ 4.9GHz ~ 5.825GHz
- 1.7 Polarization.....Linear; Vertical
- 1.8 Admitted Power.....1W
- 1.9 Cable..... RG-178 Coaxial Cable
- 1.10 Connector..... N-type Plug Standard

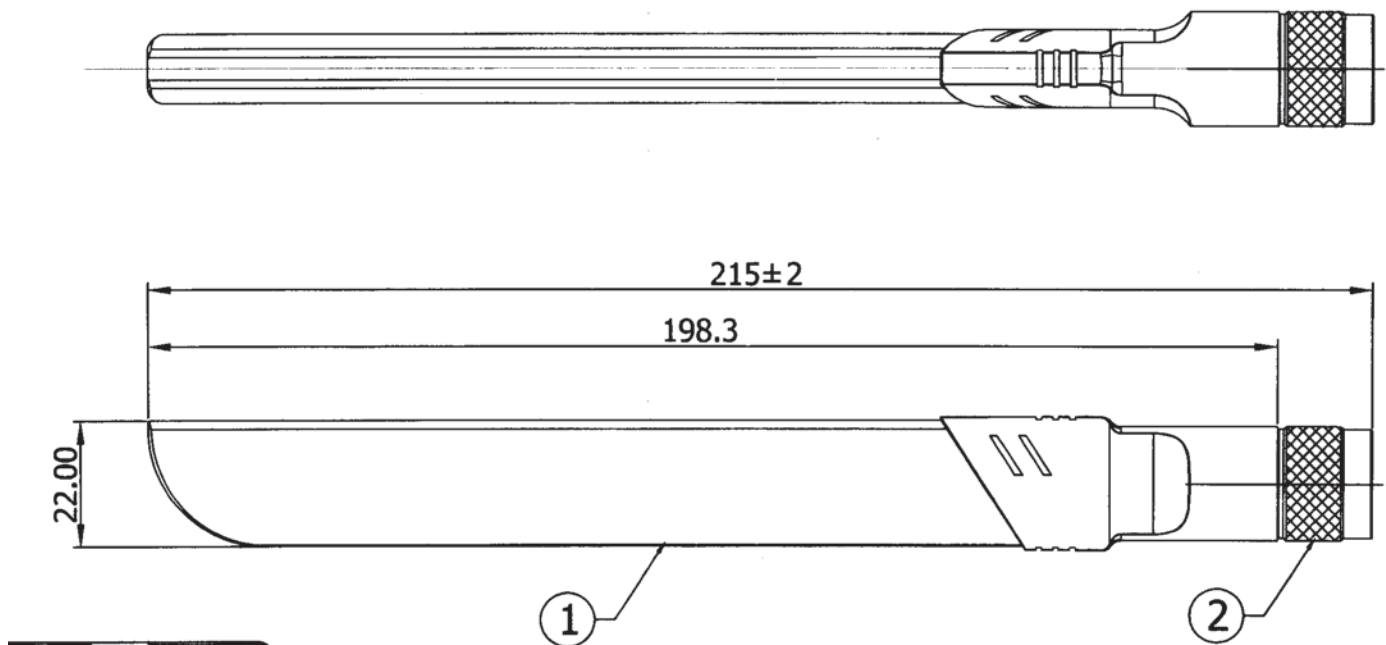

4.2 2D patterns

4.2.1 Ant 1

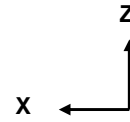
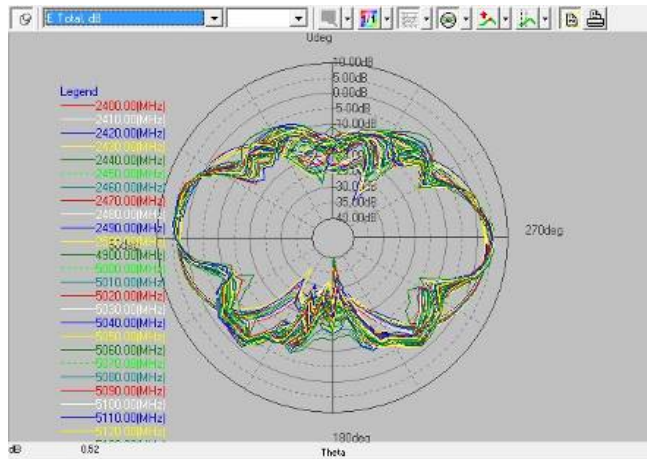

X-Z Plane

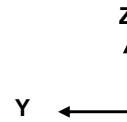
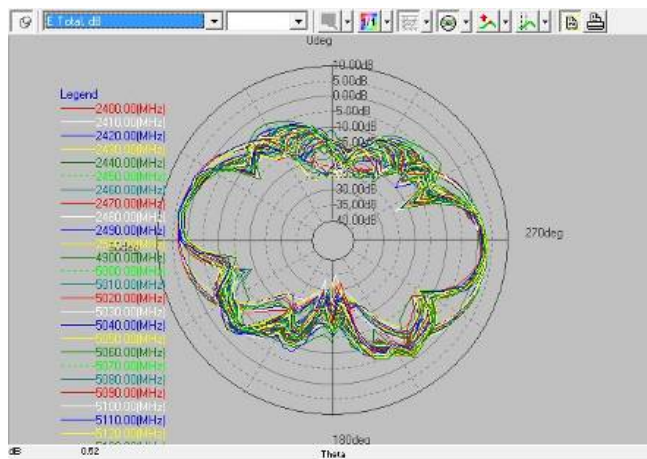

Y-Z Plane

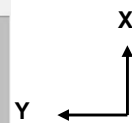
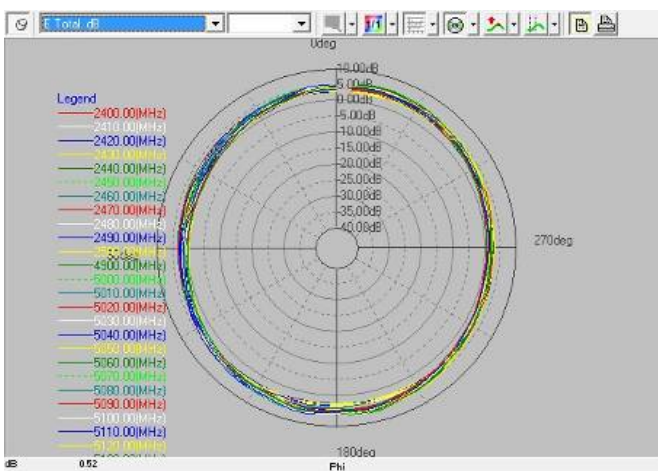

X-Y Plane

4.3 co port & cross port

4.3.1 2400MHz

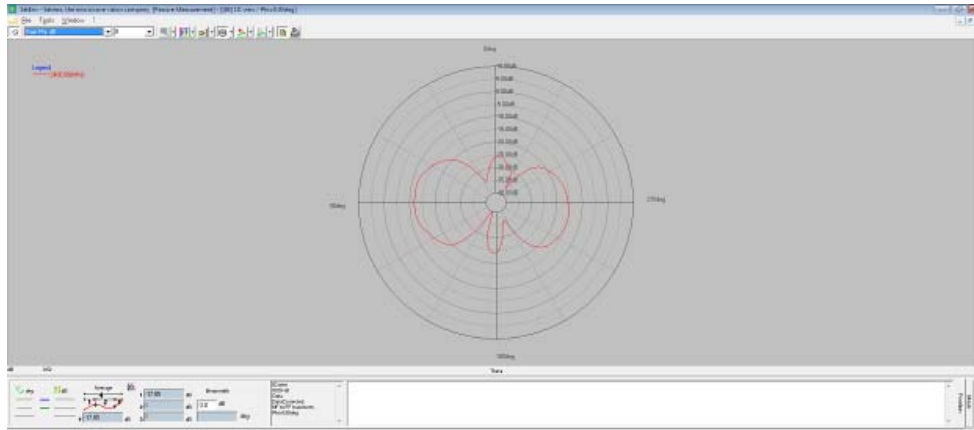

XZ-Phi

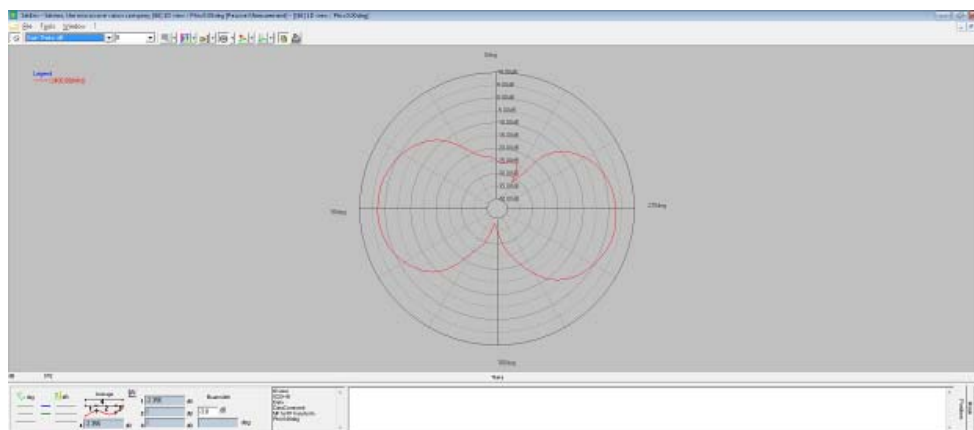

XZ-Theta

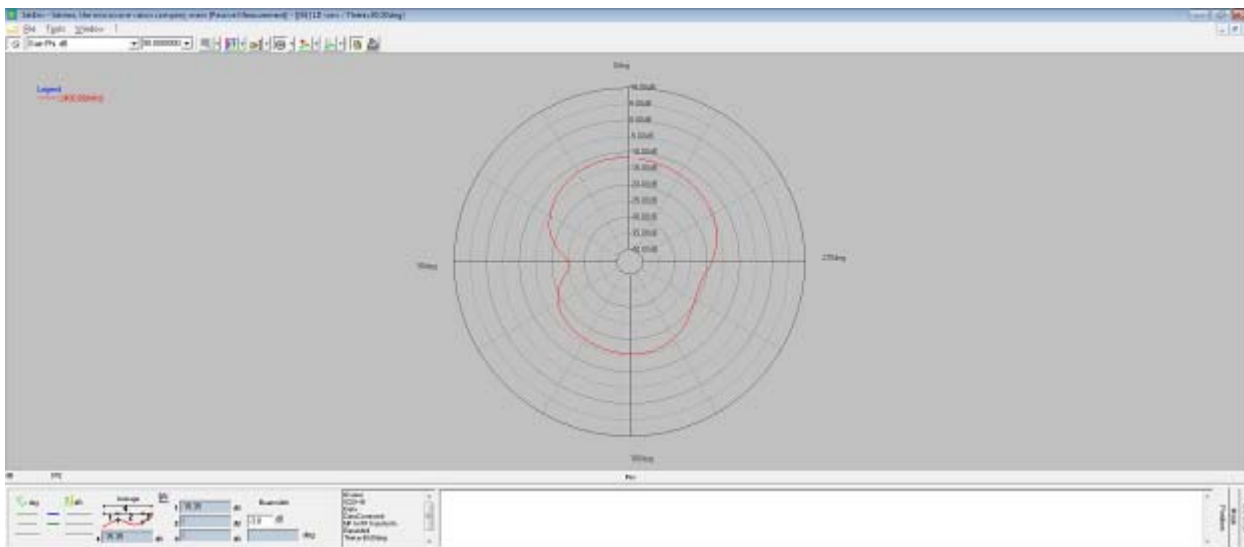

XY-Phi

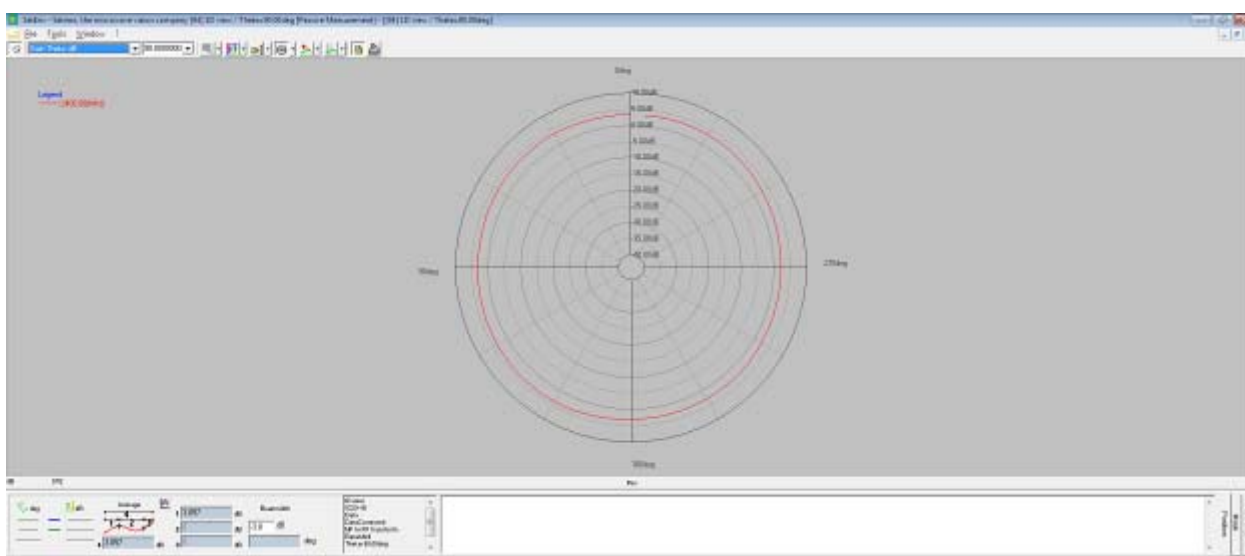

XY-Theta

4.3.2 2450MHz

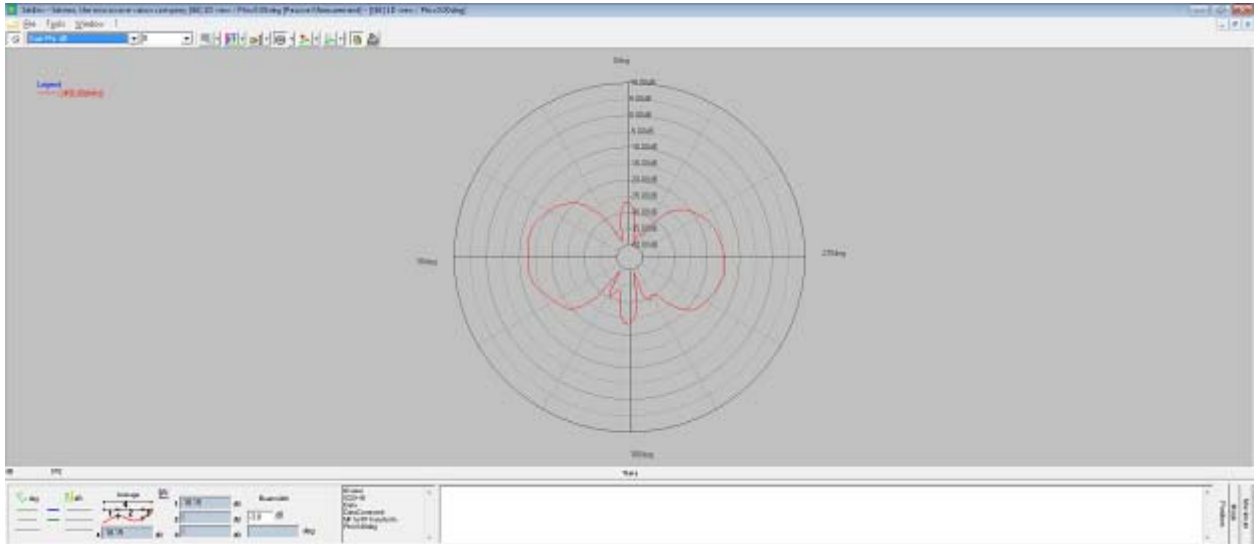

XZ-Phi

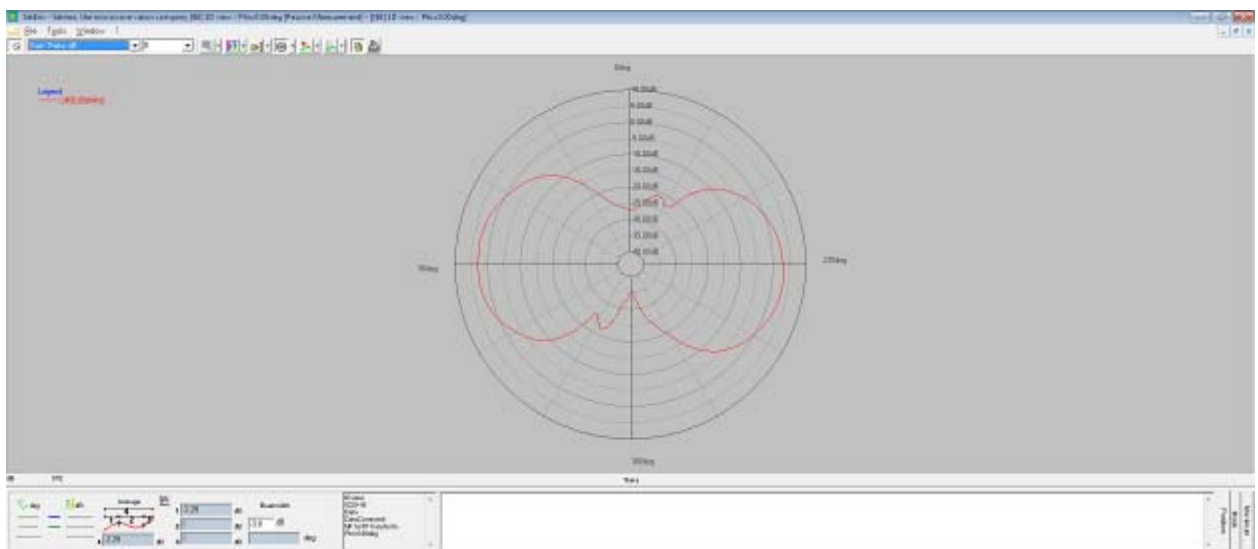

XZ-Theta

4.3.3 2500MHz

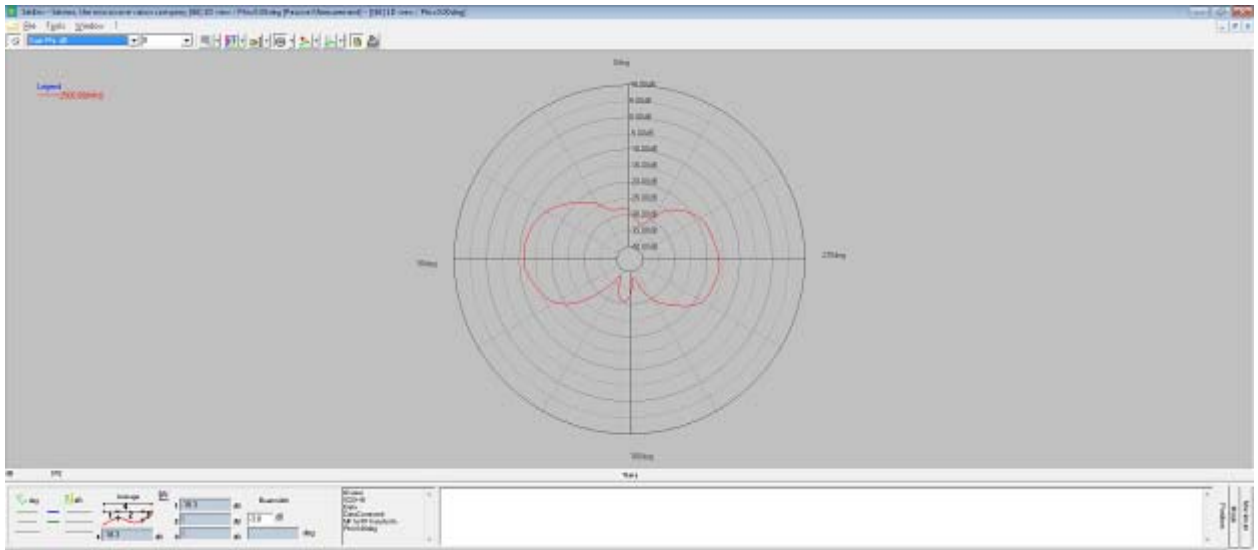

XZ-Phi

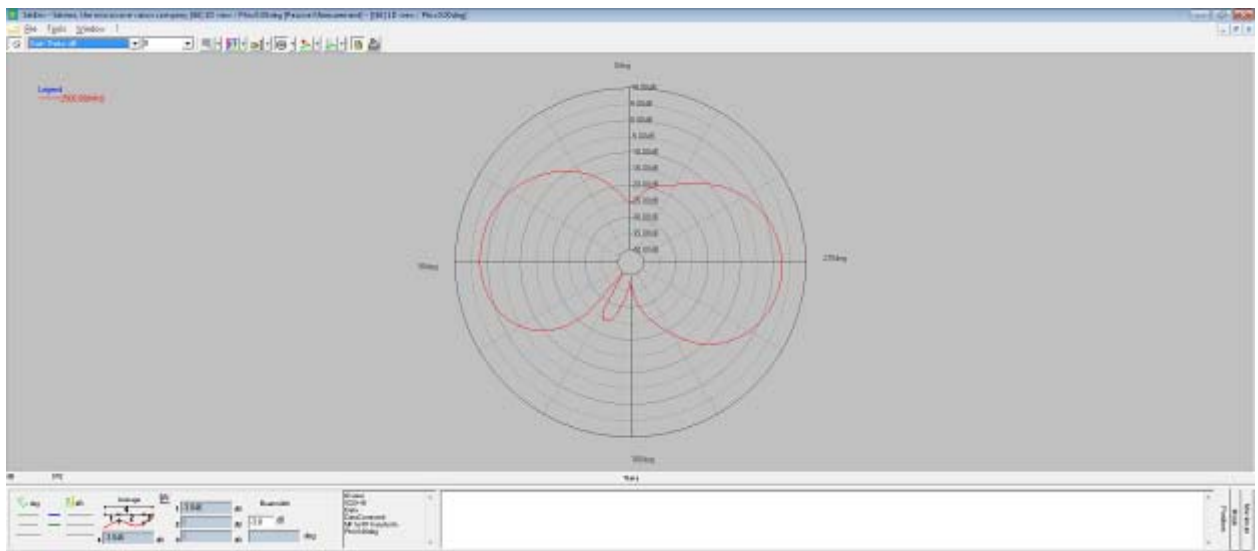

XZ-Theta

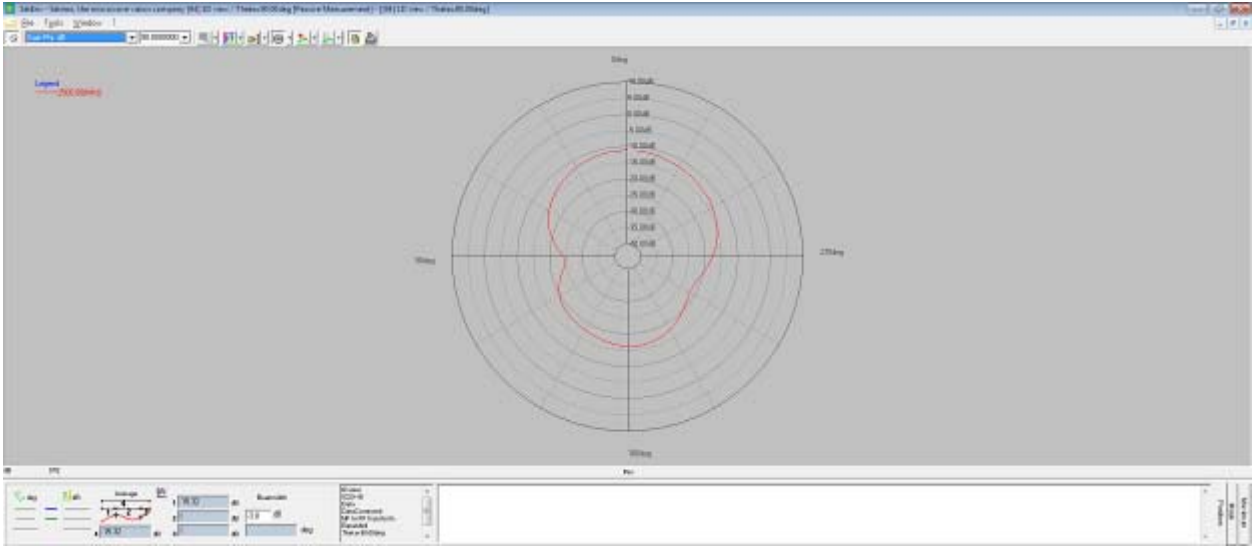

XY-Phi

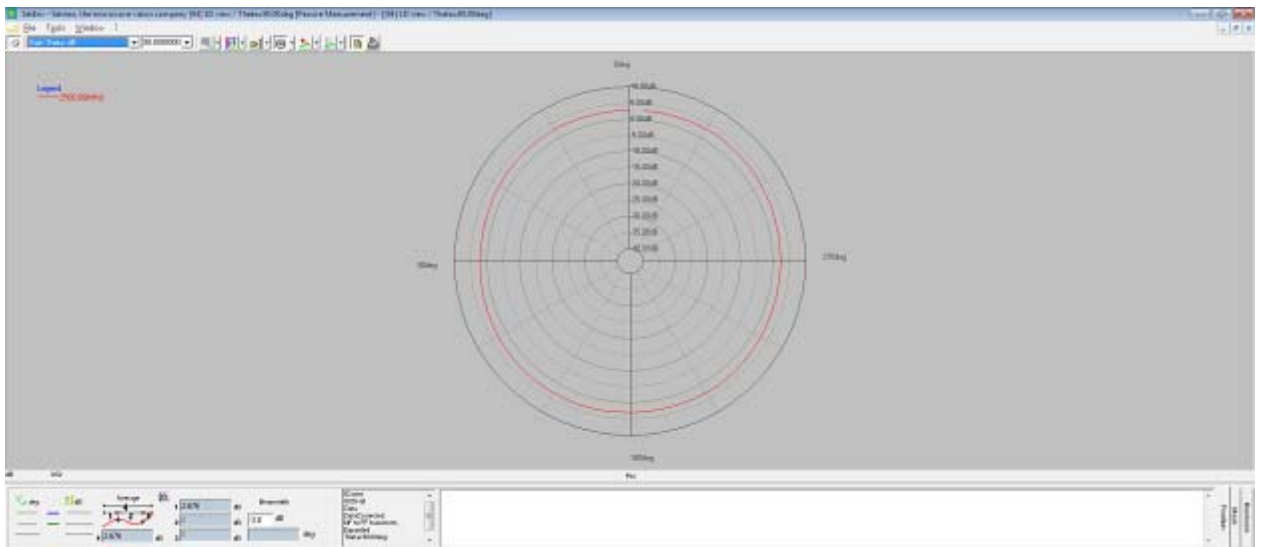

XY-Theta

4.3.4 4900MHz

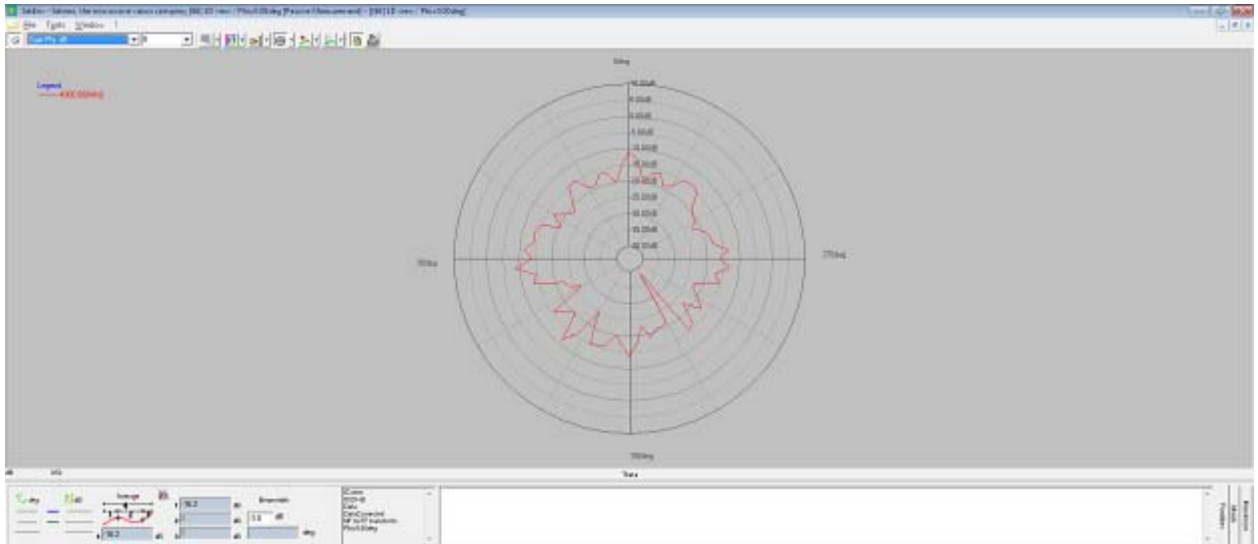

XZ-Phi

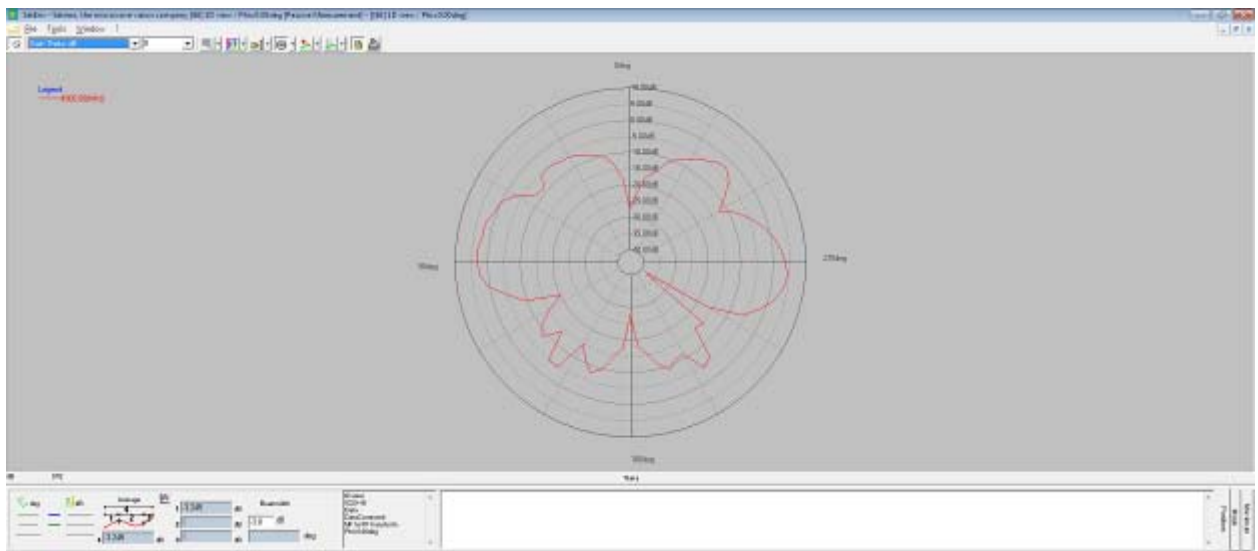

XZ-Theta

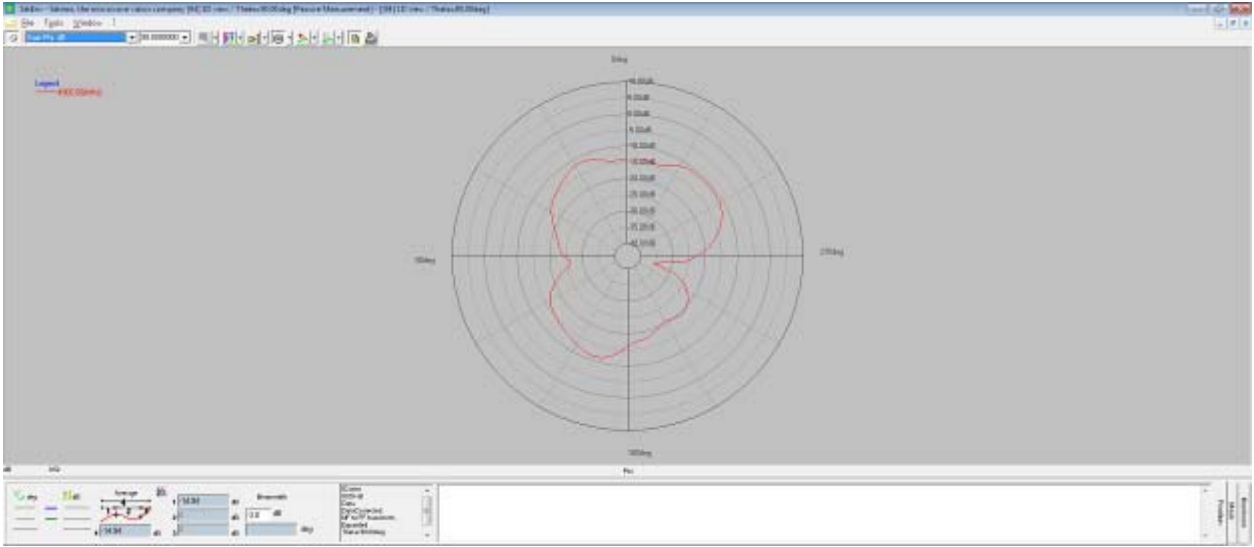

XY-Phi

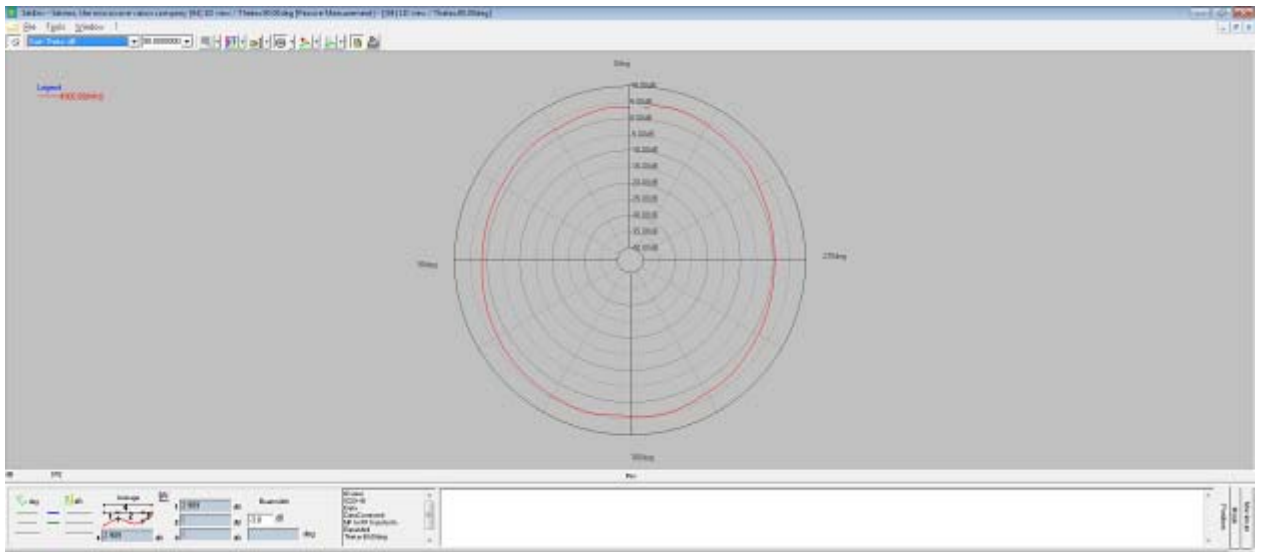

XY-Theta

4.3.5 5150MHz

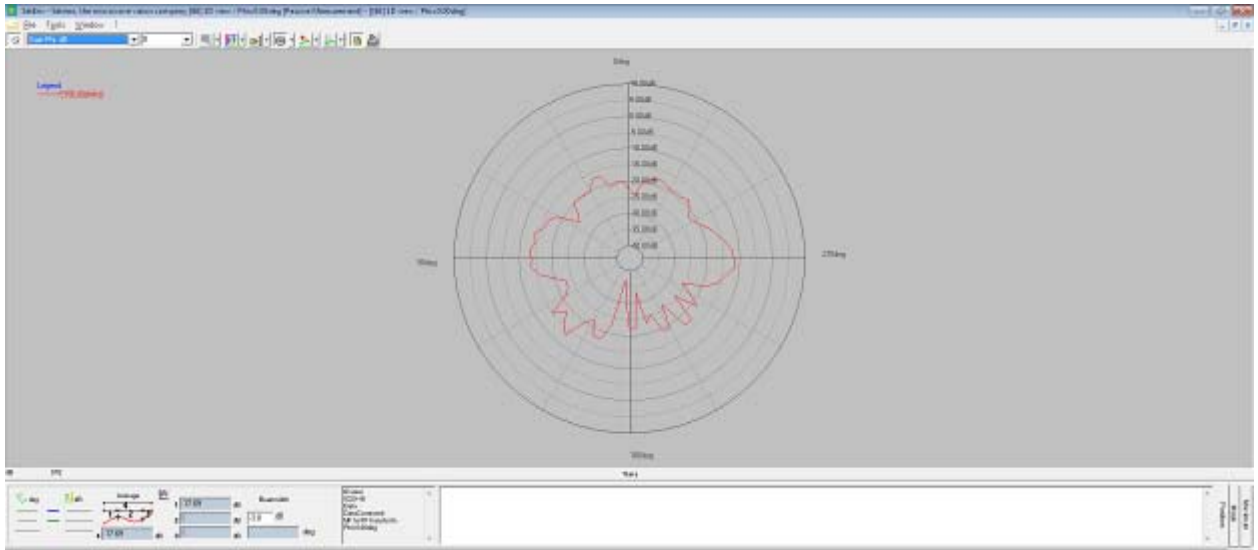

XZ-Phi

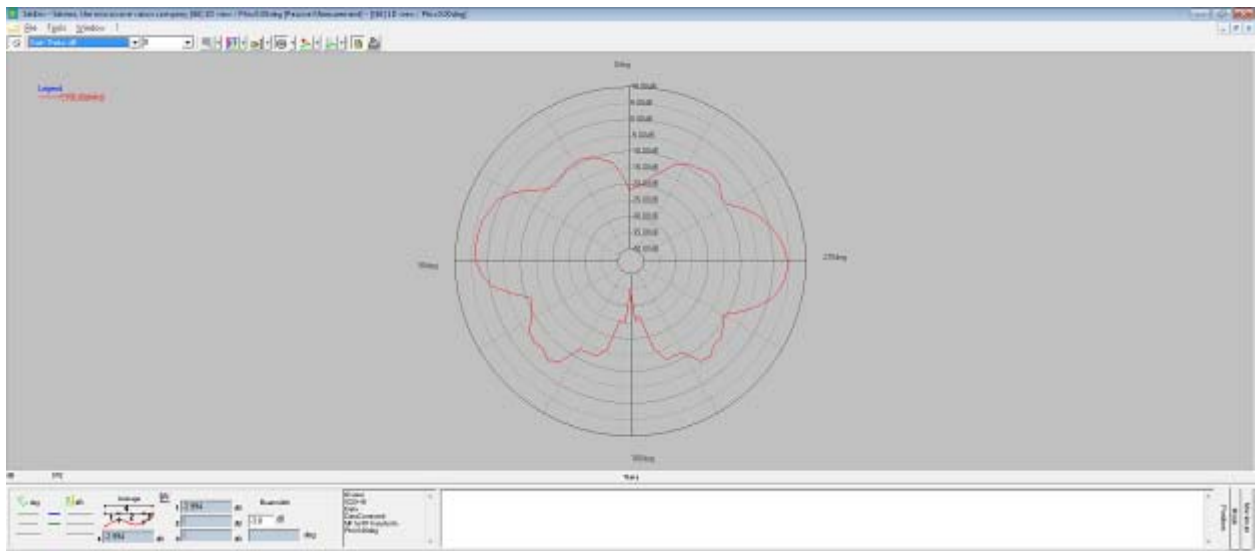

XZ-Theta

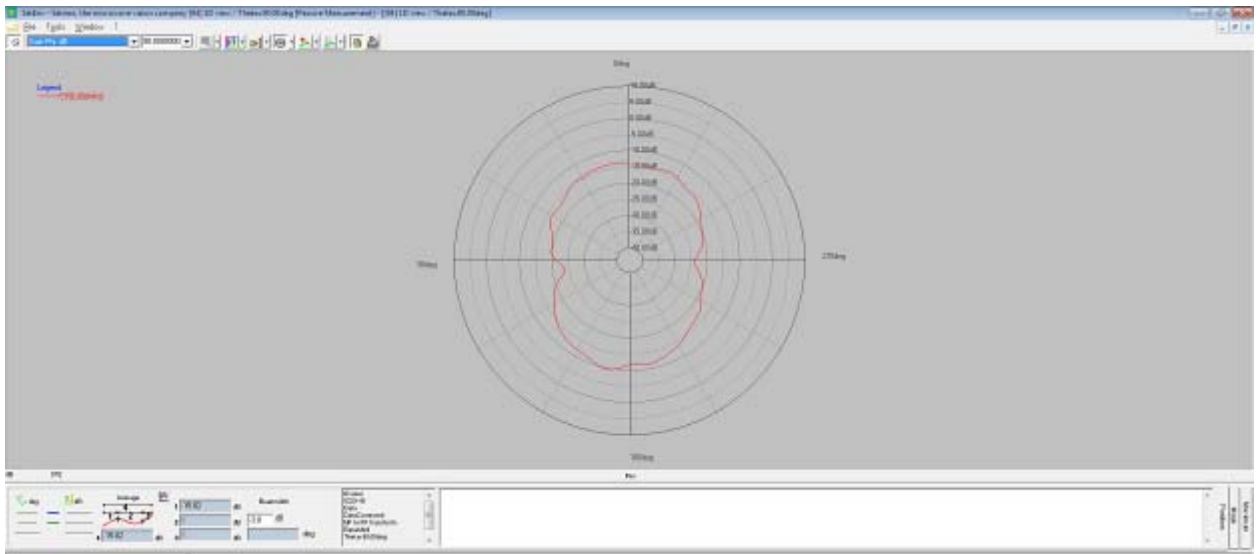

XY-Phi

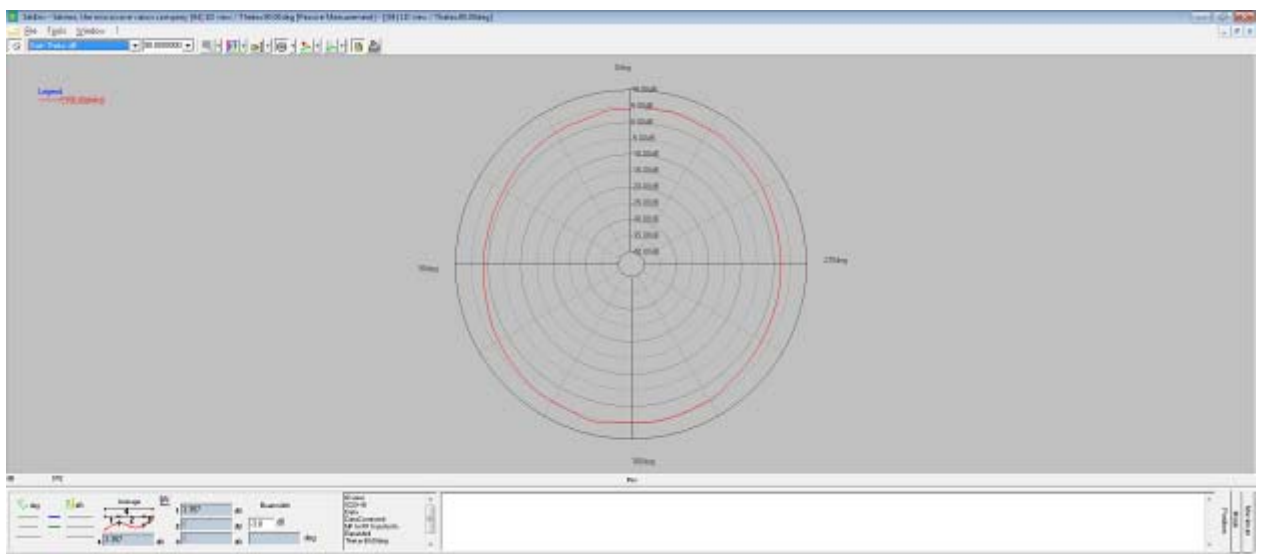

XY-Theta

4.3.6 5350MHz

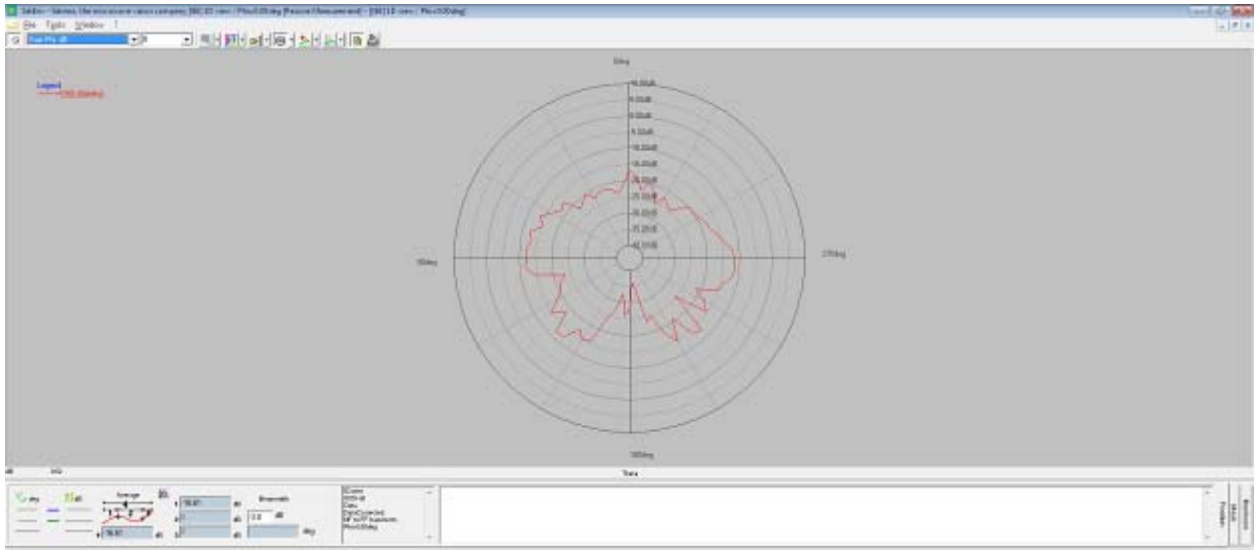

XZ-Phi

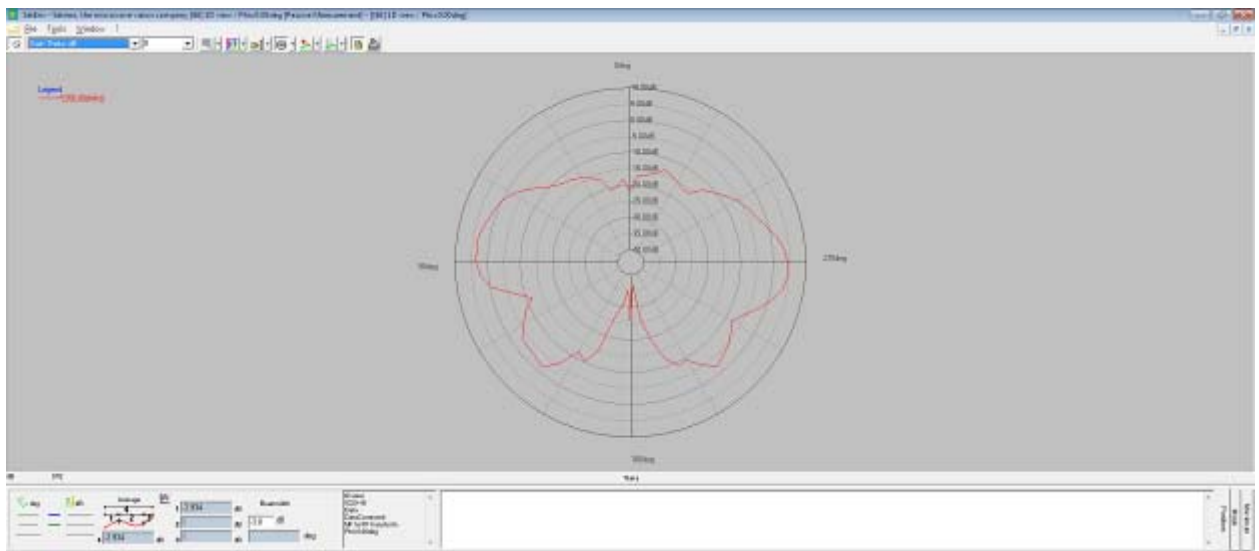

XZ-Theta

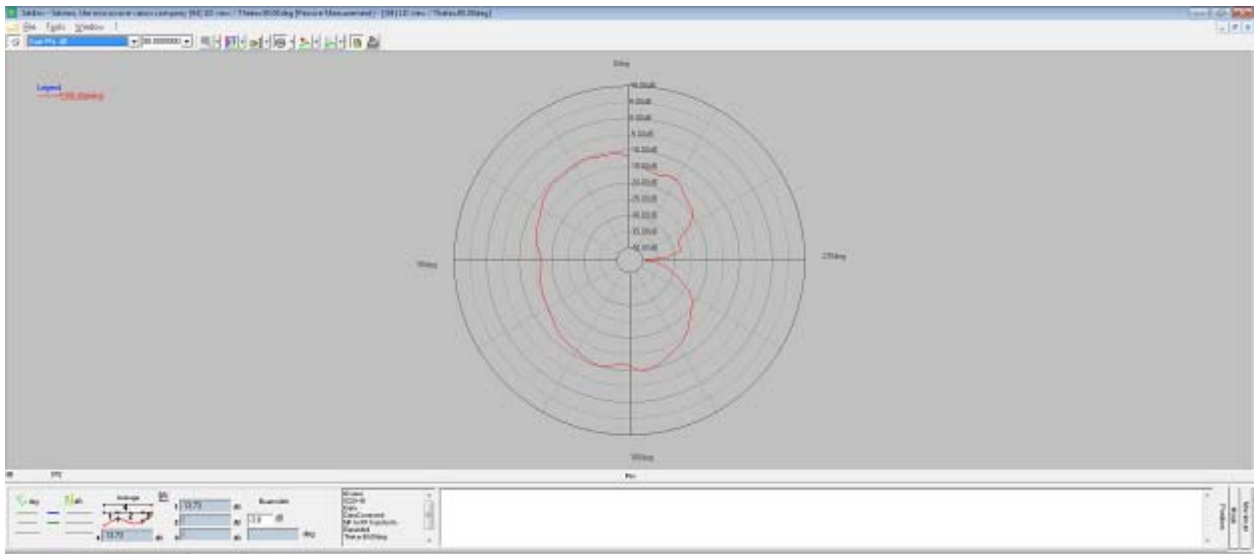

XY-Phi

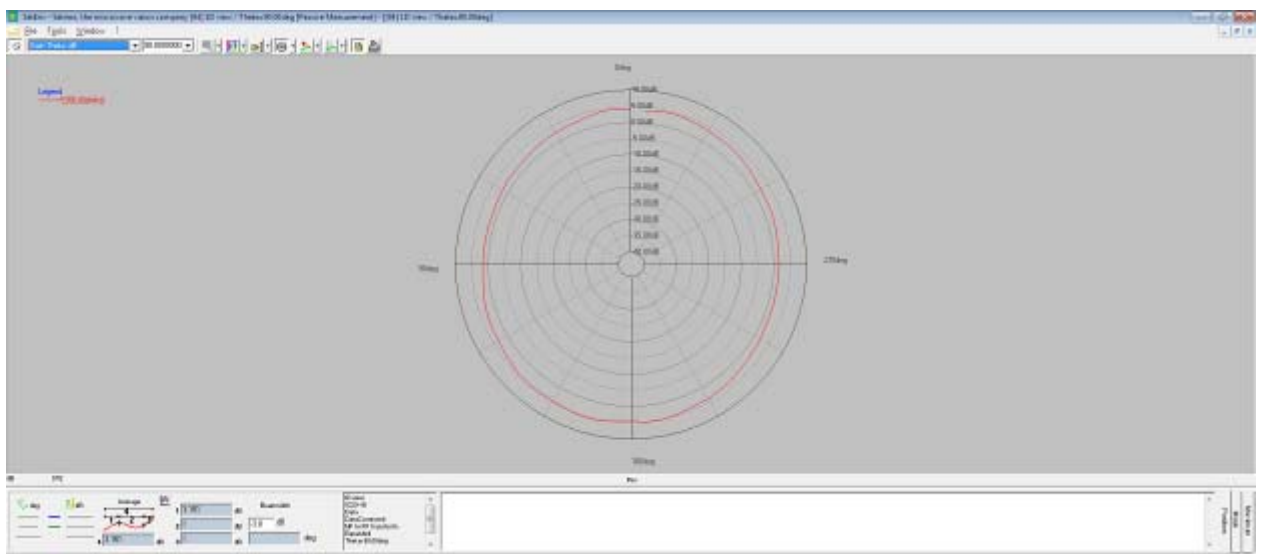

XY-Theta

4.3.7 5550MHz

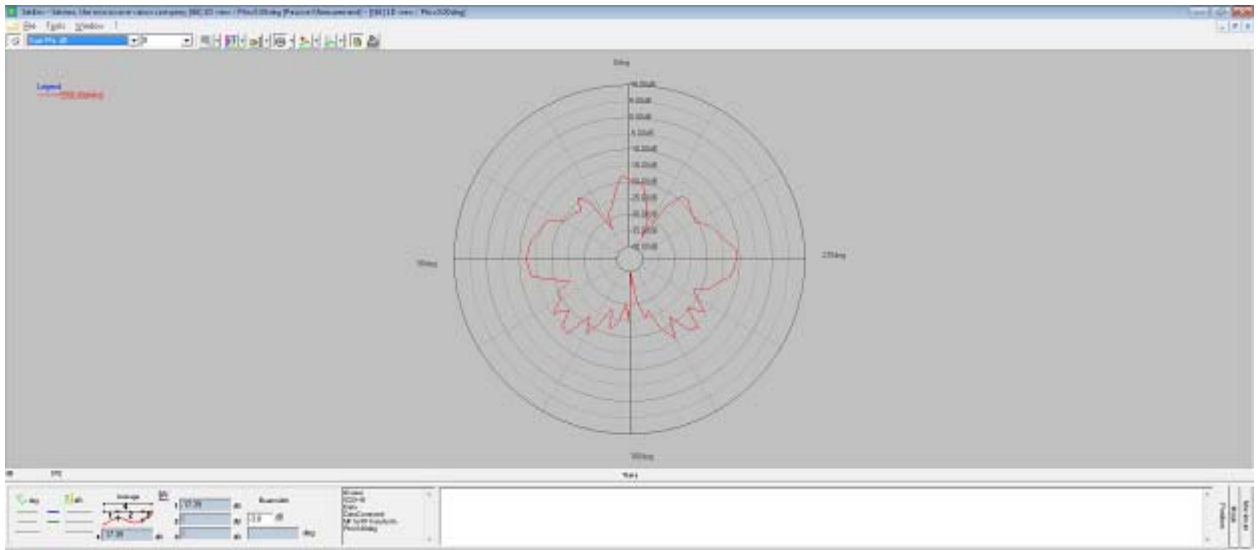

XZ-Phi

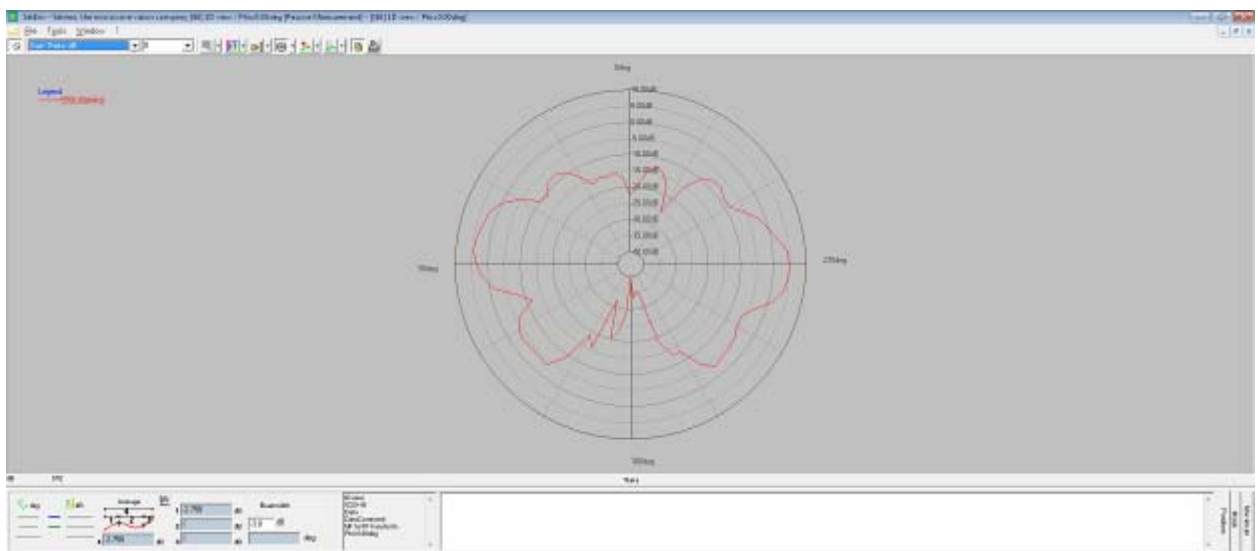

XZ-Theta

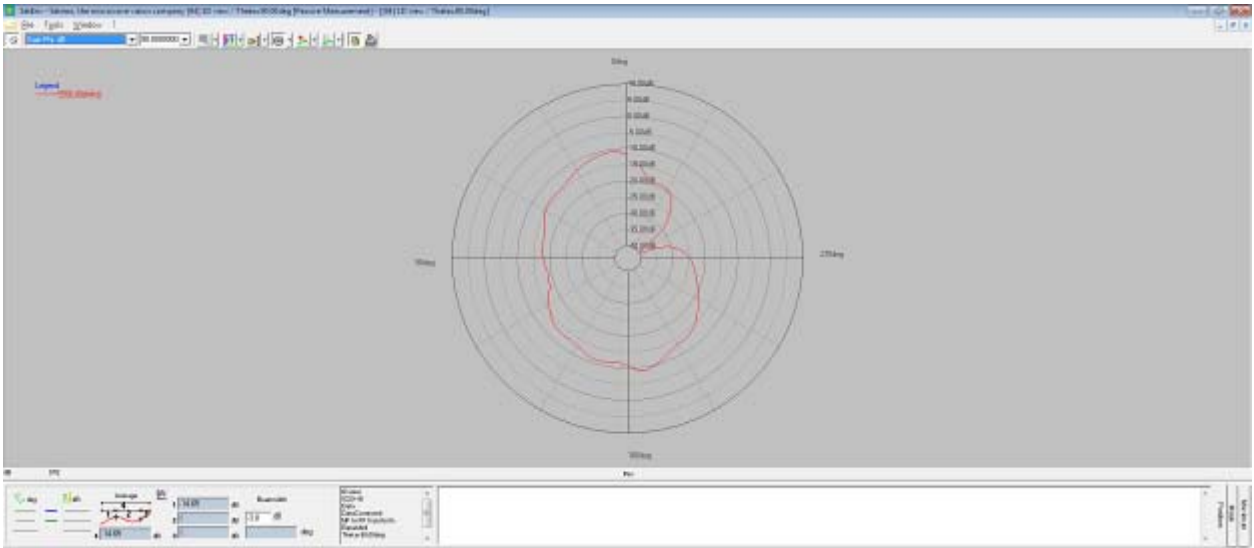

XY-Phi

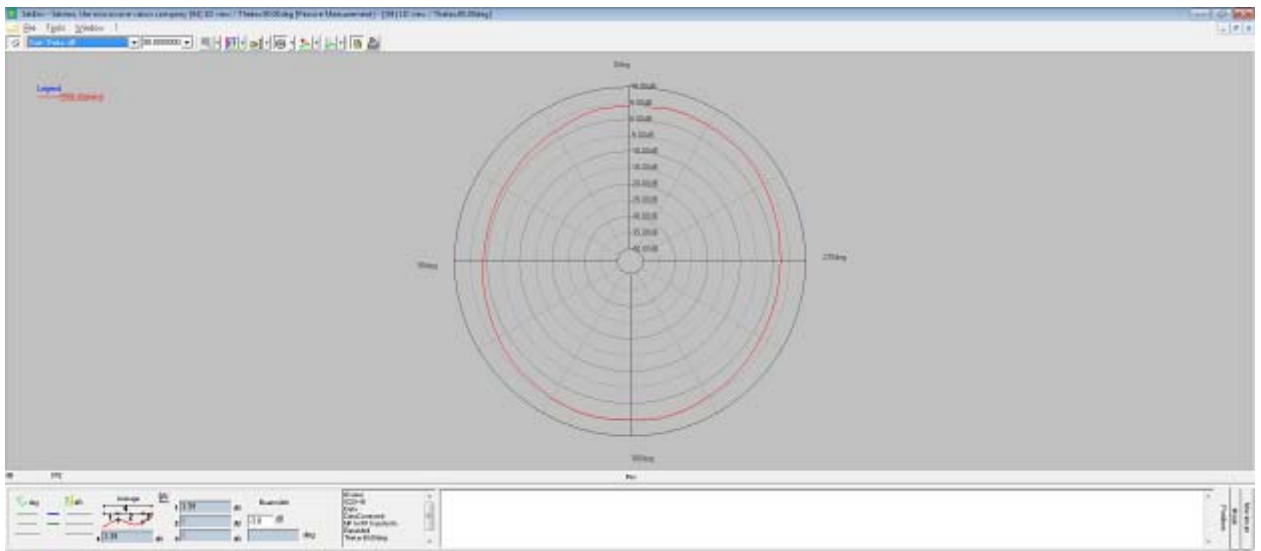

XY-Theta

4.3.8 5750MHz

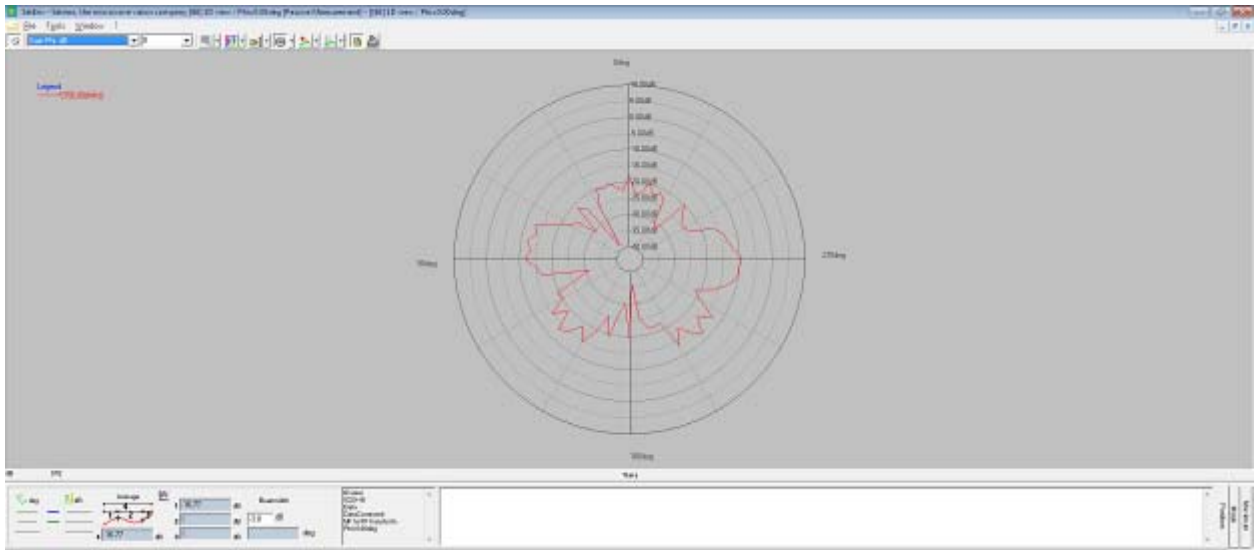

XZ-Phi

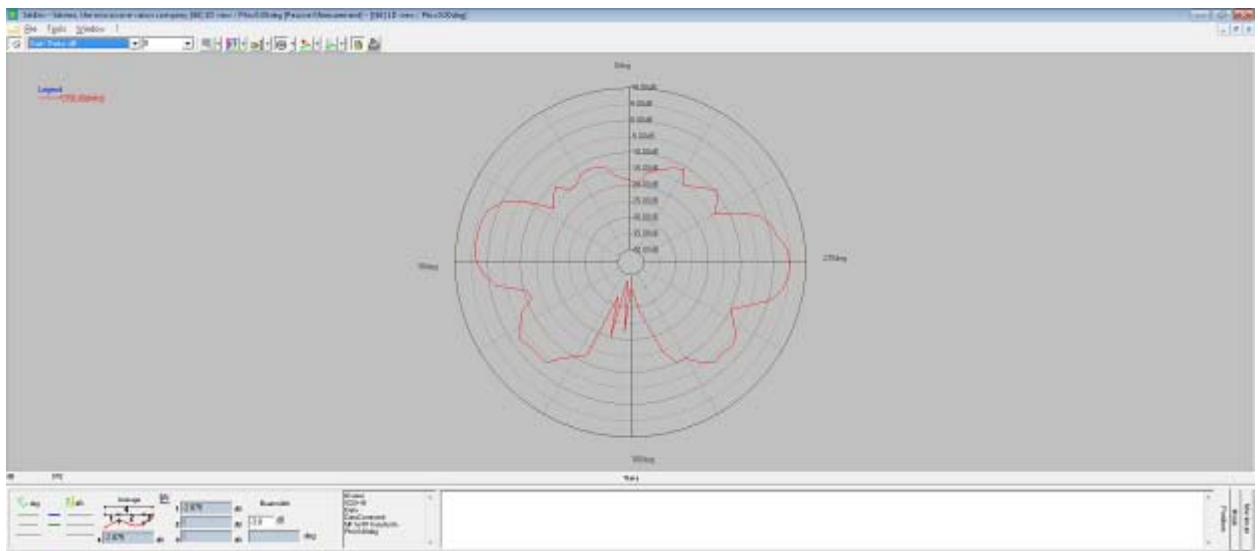

XZ-Theta

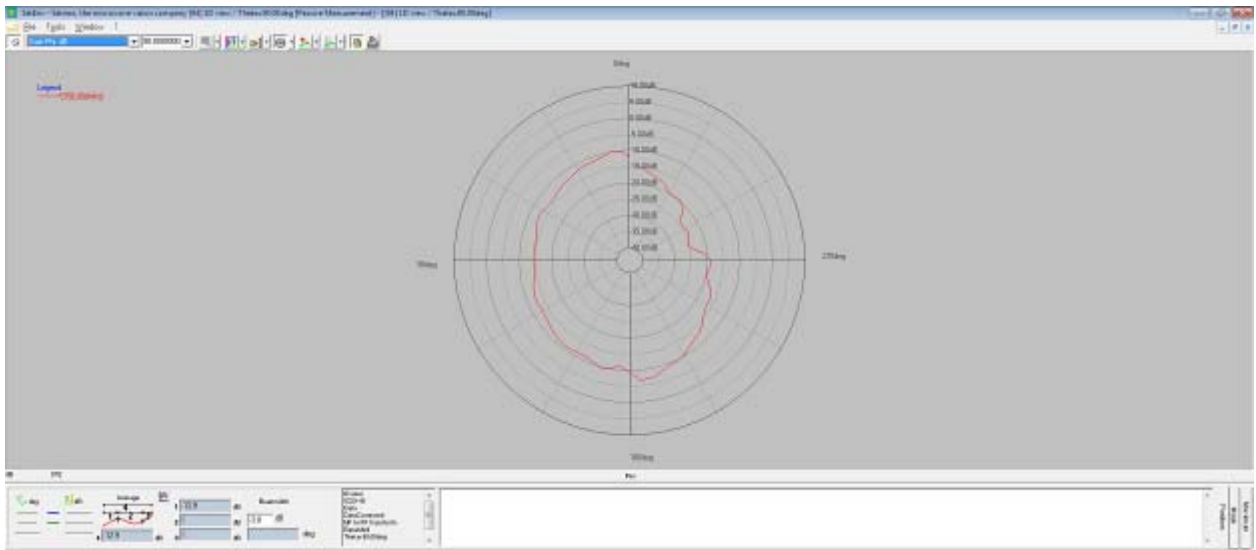

XY-Phi

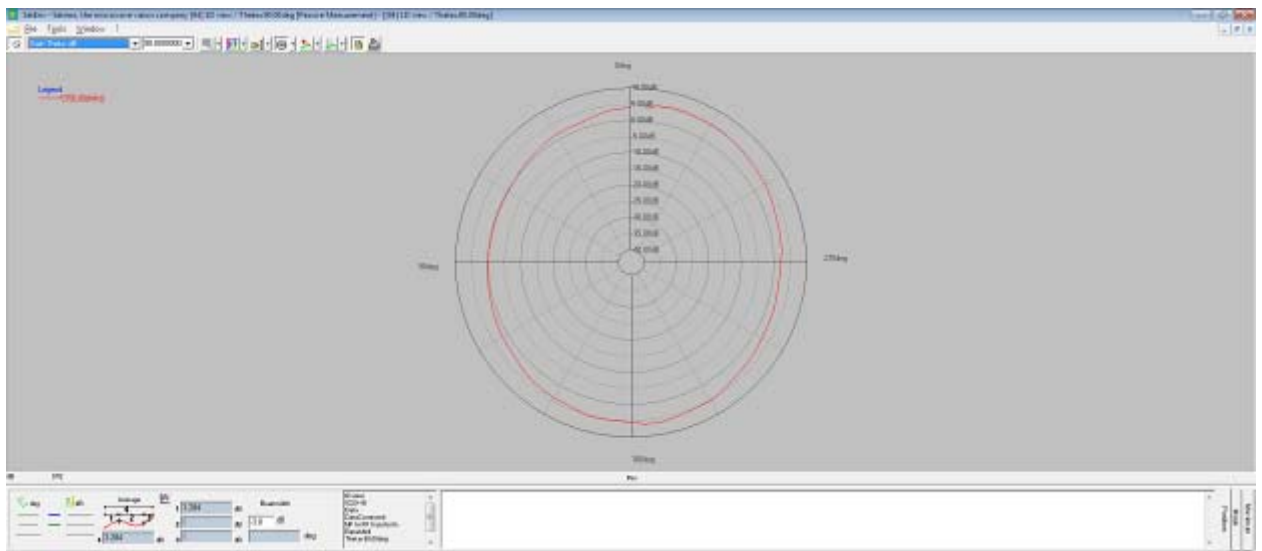

XY-Theta

4.3.9 5825MHz

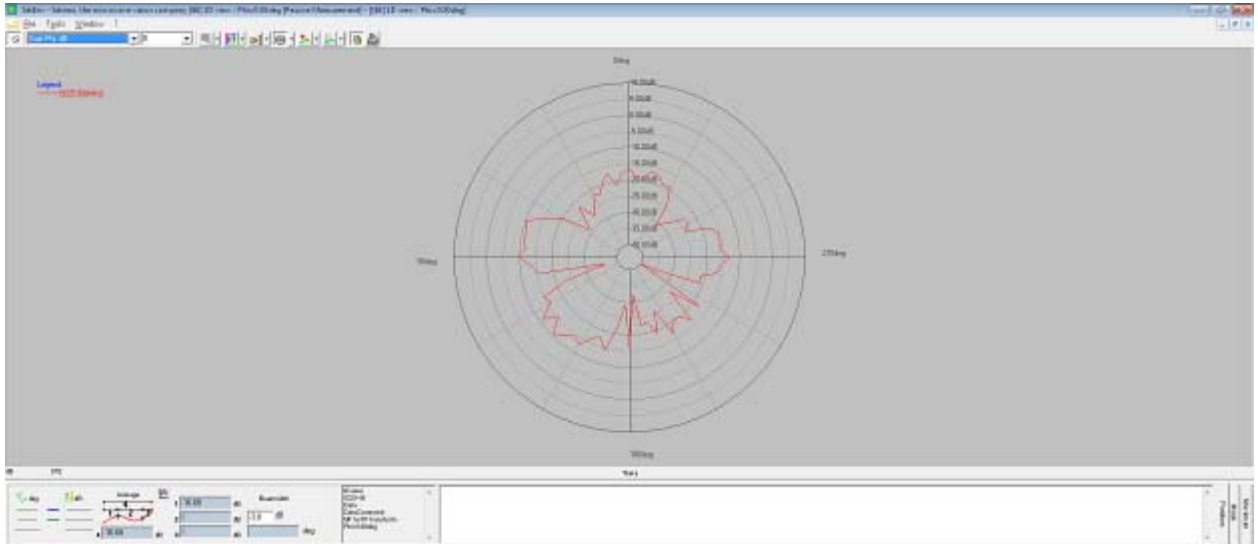

XZ-Phi

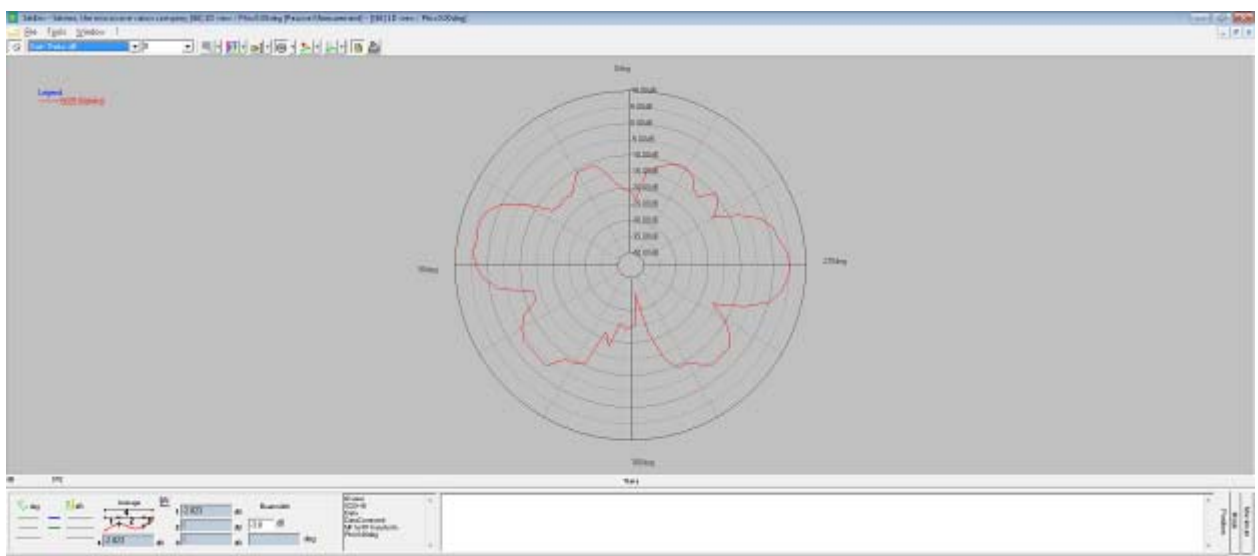

XZ-Theta

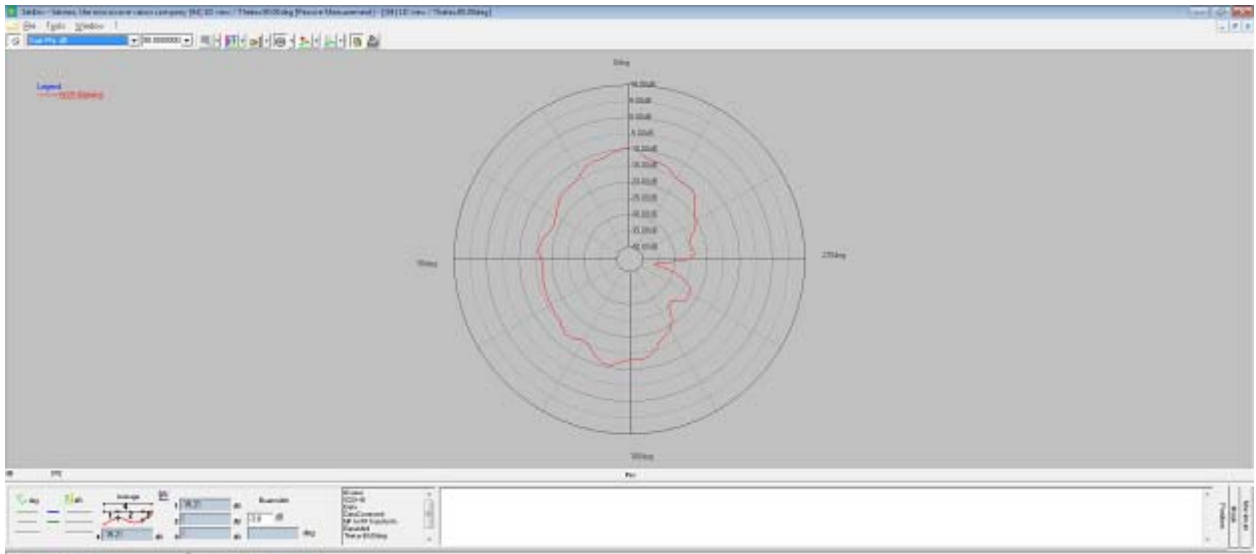

XY-Phi

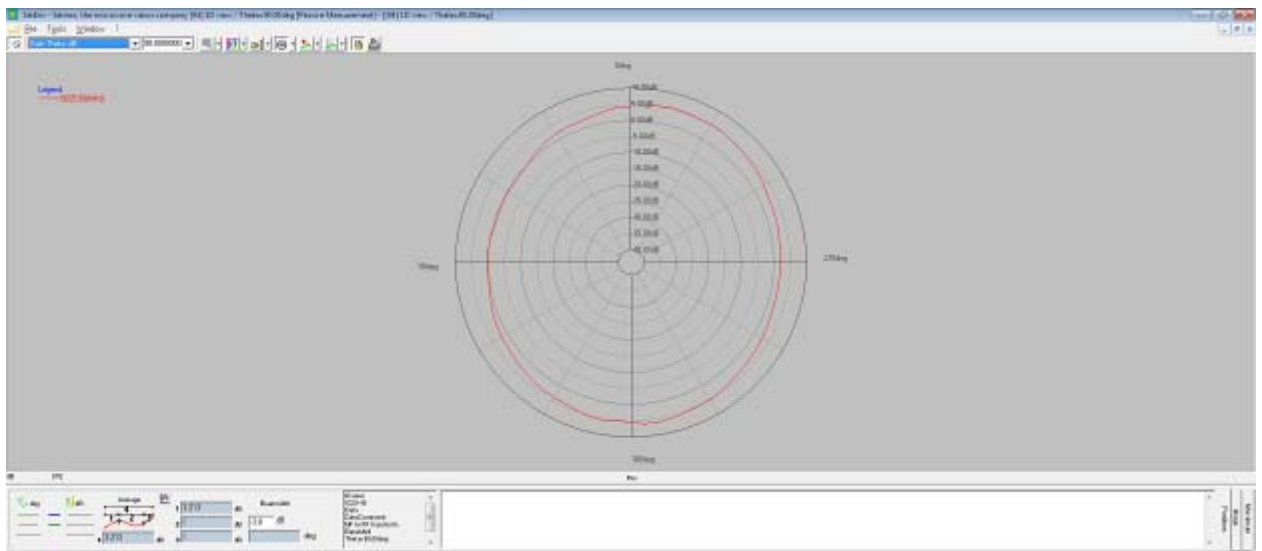

XY-Theta