



Test Report No.: RF2309WDG0035-2



TEST REPORT



Applicant	Fujian Newland Auto-ID Tech.Co., Ltd.
Address	Newland Science & Technology Park, No.1 Rujiang West Rd, Mawei, Fuzhou, P.R. China

Manufacturer or Supplier	Fujian Newland Auto-ID Tech.Co., Ltd.
Address	Newland Science & Technology Park, No.1 Rujiang West Rd, Mawei, Fuzhou, P.R. China
Product	Wearable Data Collector
Brand Name	Newland
Model	NLS-WD1
Additional Model & Model Difference	WD1, NLS-NW10, NW10, NLS-NW20, NW20, Smart Watch, Watch Pro, Smart Watch Lite, See item 3.1
Date of tests	Sep. 06, 2023 ~ Oct. 12, 2023

the tests have been carried out according to the requirements of the following standard:

FCC Part 15, Subpart C, Section 15.247

CONCLUSION: The submitted sample was found to COMPLY with the test requirement

Tested by Andy Zhu Supervisor / EMC Department	Approved by Glyn He Assistant Manager / EMC Department
	 Date: Mar. 22, 2024

This report is governed by, and incorporates by reference, the Conditions of Testing as posted at the date of issuance of this report at <http://www.bureauveritas.com/home/about-us/our-business/cps/about-us/terms-conditions/> and is intended for your exclusive use. Any copying or replication of this report to or for any other person or entity, or use of our name or trademark, is permitted only with our prior written permission. This report sets forth our findings solely with respect to the test samples identified herein. The results set forth in this report are not indicative or representative of the quality or characteristics of the lot from which a test sample was taken or any similar or identical product unless specifically and expressly noted. Our report includes all of the tests requested by you and the results thereof based upon the information that you provided to us. Measurement uncertainty is only provided upon request for accredited tests. Statements of conformity are based on simple acceptance criteria without taking measurement uncertainty into account, unless otherwise requested in writing. You have 60 days from date of issuance of this report to notify us of any material error or omission caused by our negligence or if you require measurement uncertainty; provided, however, that such notice shall be in writing and shall specifically address the issue you wish to raise. A failure to raise such issue within the prescribed time shall constitute your unqualified acceptance of the completeness of this report, the tests conducted and the correctness of the report contents.

Bureau Veritas Shenzhen Co., Ltd.
Dongguan Branch

No. 96, Guantai Road (Houjie Section), Houjie
Town, Dongguan City, Guangdong Province.
523942. People's Republic of China.

Tel: +86 769 8998 2098
Fax: +86 769 8593 1080
Email: customerservice.dg@bureauveritas.com



TABLE OF CONTENTS

RELEASE CONTROL RECORD	4
1 SUMMARY OF TEST RESULTS.....	5
2 MEASUREMENT UNCERTAINTY	5
3 GENERAL INFORMATION	6
3.1 GENERAL DESCRIPTION OF EUT	6
3.2 DESCRIPTION OF TEST MODES	7
3.2.1. CONFIGURATION OF SYSTEM UNDER TEST	7
3.2.2. TEST MODE APPLICABILITY AND TESTED CHANNEL DETAIL.....	7
3.3 GENERAL DESCRIPTION OF APPLIED STANDARDS	10
3.4 DESCRIPTION OF SUPPORT UNITS	10
3.5 CONFIGURATION OF SYSTEM UNDER TEST	10
3.6 DUTY CYCLE OF TESET SIGNAL.....	11
4 TEST TYPES AND RESULTS.....	12
4.1 CONDUCTED EMISSION MEASUREMENT	12
4.1.1 LIMITS OF CONDUCTED EMISSION MEASUREMENT	12
4.1.2 TEST INSTRUMENTS.....	12
4.1.3 TEST PROCEDURES	13
4.1.4 DEVIATION FROM TEST STANDARD	13
4.1.5 TEST SETUP.....	14
4.1.6 EUT OPERATING CONDITIONS	14
4.1.7 TEST RESULTS	15
4.2 RADIATED EMISSION MEASUREMENT	17
4.2.1 LIMITS OF RADIATED EMISSION MEASUREMENT	17
4.2.2 TEST INSTRUMENTS.....	18
4.2.3 TEST PROCEDURES	19
4.2.4 DEVIATION FROM TEST STANDARD	20
4.2.5 TEST SETUP.....	20
4.2.6 EUT OPERATING CONDITIONS	21
4.2.7 TEST RESULTS	22
4.3 6DB BANDWIDTH MEASUREMENT	30
4.3.1 LIMITS OF 6DB BANDWIDTH MEASUREMENT	30
4.3.2 TEST INSTRUMENTS.....	30
4.3.3 TEST PROCEDURE.....	31



4.3.4	DEVIATION FROM TEST STANDARD	31
4.3.5	TEST SETUP	32
4.3.6	EUT OPERATING CONDITIONS	32
4.3.7	TEST RESULTS	33
4.4	CONDUCTED OUTPUT POWER.....	35
4.4.1	LIMITS OF CONDUCTED OUTPUT POWER MEASUREMENT	35
4.4.2	TEST SETUP	35
4.4.3	TEST INSTRUMENTS.....	35
4.4.4	TEST PROCEDURES	35
4.4.5	DEVIATION FROM TEST STANDARD	35
4.4.6	EUT OPERATING CONDITIONS	35
4.4.7	TEST RESULTS	36
4.4.7.1	MAXIMUM PEAK OUTPUT POWER	36
4.4.7.2	AVERAGE OUTPUT POWER (FOR REFERENCE).....	37
4.5	POWER SPECTRAL DENSITY MEASUREMENT	38
4.5.1	LIMITS OF POWER SPECTRAL DENSITY MEASUREMENT	38
4.5.2	TEST SETUP	38
4.5.3	TEST INSTRUMENTS.....	38
4.5.4	TEST PROCEDURE.....	38
4.5.5	DEVIATION FROM TEST STANDARD	38
4.5.6	EUT OPERATING CONDITION	38
4.5.7	TEST RESULTS	39
4.6	OUT OF BAND EMISSION MEASUREMENT	41
4.6.1	LIMITS OF OUT OF BAND EMISSION MEASUREMENT	41
4.6.2	TEST SETUP	41
4.6.3	TEST INSTRUMENTS.....	41
4.6.4	TEST PROCEDURE.....	41
4.6.5	DEVIATION FROM TEST STANDARD	42
4.6.6	EUT OPERATING CONDITION	42
4.6.7	TEST RESULTS	43
5	PHOTOGRAPHS OF THE TEST CONFIGURATION	46
6	APPENDIX A - MODIFICATIONS RECORDERS FOR ENGINEERING CHANGES TO THE EUT BY THE LAB	47



Test Report No.: RF2309WDG0035-2

RELEASE CONTROL RECORD

ISSUE NO.	REASON FOR CHANGE	DATE ISSUED
RF2309WDG0035-2	Original release	Mar. 22, 2024

1 SUMMARY OF TEST RESULTS

The EUT has been tested according to the following specifications:

APPLIED STANDARD: FCC PART 15, SUBPART C (SECTION 15.247)			
STANDARD SECTION	TEST TYPE AND LIMIT	RESULT	REMARK
15.207	AC Power Conducted Emission	PASS	Meet the requirement of limit.
15.205 15.209	Radiated Emission	PASS	Meet the requirement of limit.
15.247(d)	Out of band Emission Measurement	PASS	Meet the requirement of limit.
15.247(a)(2)	6dB bandwidth	PASS	Meet the requirement of limit.
15.247(b)	Conducted Output power	PASS	Meet the requirement of limit.
15.247(e)	Power Spectral Density	PASS	Meet the requirement of limit.
15.203	Antenna Requirement	PASS	No antenna connector is used

2 MEASUREMENT UNCERTAINTY

Where relevant, the following measurement uncertainty levels have been estimated for tests performed on the EUT as specified in CISPR 16-4-2:

MEASUREMENT	FREQUENCY	UNCERTAINTY
Conducted emissions	0.15MHz ~ 30MHz	2.68dB
Radiated emissions	9KHz ~ 30MHz	2.80dB
	30MHz ~ 1GMHz	4.24dB
	1GHz ~ 18GHz	4.76dB
	18GHz ~ 40GHz	4.50dB

This uncertainty represents an expanded uncertainty expressed at approximately the 95% confidence level using a coverage factor of $k = 2$.

3 GENERAL INFORMATION

3.1 GENERAL DESCRIPTION OF EUT

PRODUCT	Wearable Data Collector
MODEL NO.	NLS-WD1
ADDITIONAL MODEL	WD1, NLS-NW10, NW10, NLS-NW20, NW20, Smart Watch, Watch Pro, Smart Watch Lite,
FCC ID	SL9NLS-WD1
NOMINAL VOLTAGE	5V/9V/12V (adapter or host equipment) 3.8Vdc (Li-ion Polyme, battery)
MODULATION TECHNOLOGY	DTS
MODULATION TYPE	BT-LE GFSK(1, 2 Mbps)
OPERATING FREQUENCY	2402-2480MHz
PEAK OUTPUT POWER	0.6561mW (Max. Measured)
ANTENNA TYPE	LDS Antenna, 0.17dBi Gain
CABLE SUPPLIED	USB Line: Shielded, Detachable 0.95m
ACCESSORY	Adapter

NOTES:

- For a more detailed features description, please refer to the manufacturer's specifications or the user's manual.
- For the test results, the EUT had been tested with all conditions. But only the worst case was shown in test report.
- Please refer to the EUT photo document (Reference No.: 2309WDG0035) for detailed product photo.
- Additional models (see above table) are identical with the test model NLS-WD1 except model number for trading purpose.
- Details of the Adapter are as follows:

Adapter	Brand:	ACT
	Model:	QC18W-G
	Input:	100-240V ~ 50/60Hz 0.5A Max.
	Output:	DC 5V/3A, 9V2A, 12V/1.5A

3.2 DESCRIPTION OF TEST MODES

40 channels are provided for BT-LE (GFSK):

CHANNEL	FREQ. (MHZ)	CHANNEL	FREQ. (MHZ)	CHANNEL	FREQ. (MHZ)	CHANNEL	FREQ. (MHZ)
0	2402	10	2422	20	2442	30	2462
1	2404	11	2424	21	2444	31	2464
2	2406	12	2426	22	2446	32	2466
3	2408	13	2428	23	2448	33	2468
4	2410	14	2430	24	2450	34	2470
5	2412	15	2432	25	2452	35	2472
6	2414	16	2434	26	2454	36	2474
7	2416	17	2436	27	2456	37	2476
8	2418	18	2438	28	2458	38	2478
9	2420	19	2440	29	2460	39	2480

3.2.1. CONFIGURATION OF SYSTEM UNDER TEST

Please see section 5 photographs of the test configuration for reference.

3.2.2. TEST MODE APPLICABILITY AND TESTED CHANNEL DETAIL

Pre-Scan has been conducted to determine the worst-case mode from all possible combinations between available modulations, data rates, XYZ axis, power supply voltage range and antenna ports. The worst case was found when positioned on X axis for radiated emission. Following test modes were selected for the final test, and the final worst case is marked in boldface and recorded in the report:

EUT CONFIGURE MODE	APPLICABLE TO				DESCRIPTION
	RE<1G	RE≥1G	PLC	APCM	
A	√	√	√	√	BT function

Where **RE<1G**: Radiated Emission below 1GHz **RE≥1G**: Radiated Emission above 1GHz
PLC: Power Line Conducted Emission **APCM**: Antenna Port Conducted Measurement

RADIATED EMISSION TEST (BELOW 1GHz):

- Pre-Scan has been conducted to determine the worst-case mode from all possible combinations between available modulations, data rates, XYZ axis and antenna ports (if EUT with antenna diversity architecture).
- Following channel(s) was (were) selected for the final test as listed below.

EUT CONFIGURE MODE	AVAILABLE CHANNEL	TESTED CHANNEL	MODULATION TECHNOLOGY	MODULATION TYPE	DATA RATE (Mbps)
A	0 to 39	39	DTS	GFSK	1

For the test results, only the worst case was shown in test report.

RADIATED EMISSION TEST (ABOVE 1GHz):

- Pre-Scan has been conducted to determine the worst-case mode from all possible combinations between available modulations, data rates, XYZ axis and antenna ports (if EUT with antenna diversity architecture).
- Following channel(s) was (were) selected for the final test as listed below.

EUT CONFIGURE MODE	AVAILABLE CHANNEL	TESTED CHANNEL	MODULATION TECHNOLOGY	MODULATION TYPE	DATA RATE (Mbps)
A	0 to 39	0,19, 39	DTS	GFSK	1
A	0 to 39	0,19, 39	DTS	GFSK	2

POWER LINE CONDUCTED EMISSION TEST:

- Pre-Scan has been conducted to determine the worst-case mode from all possible combinations between available modulations, antenna ports (if EUT with antenna diversity architecture), and packet types.
- Following channel(s) was (were) selected for the final test as listed below.

EUT CONFIGURE MODE	TESTED CONDITION
A	BT Link

ANTENNA PORT CONDUCTED MEASUREMENT:

- This item includes all test value of each mode, but only includes spectrum plot of worst value of each mode.
- Pre-Scan has been conducted to determine the worst-case mode from all possible combinations between available modulations, antenna ports (if EUT with antenna diversity architecture), and packet types.
- Following channel(s) was (were) selected for the final test as listed below.

EUT CONFIGURE MODE	AVAILABLE CHANNEL	TESTED CHANNEL	MODULATION TECHNOLOGY	MODULATION TYPE	DATA RATE (Mbps)
A	0 to 39	0,19, 39	DTS	GFSK	1
A	0 to 39	0,19, 39	DTS	GFSK	2



**BUREAU
VERITAS**

Test Report No.: RF2309WDG0035-2

TEST CONDITION:

APPLICABLE TO	ENVIRONMENTAL CONDITIONS	TEST VOLTAGE (Adapter)	TESTED BY
RE<1G	25deg. C, 53%RH	AC 120V 60Hz	Jelly
RE≥1G	25deg. C, 53%RH	AC 120V 60Hz	Jelly
PLC	20deg. C, 56%RH	AC 120V 60Hz	Ming Bai
APCM	25deg. C, 60%RH	AC 120V 60Hz	Vincent

**Bureau Veritas Shenzhen Co., Ltd.
Dongguan Branch**

No. 96, Guantai Road (Houjie Section), Houjie
Town, Dongguan City, Guangdong Province.
523942. People's Republic of China.

Tel: +86 769 8998 2098
Fax: +86 769 8593 1080
Email: customerservice.dg@bureauveritas.com

3.3 GENERAL DESCRIPTION OF APPLIED STANDARDS

The EUT is a RF Product. According to the specifications of the manufacturer, it must comply with the requirements of the following standards:

FCC Part 15, Subpart C, Section 15.247

558074 D01 15.247 Meas Guidance v05r02

ANSI C63.10-2013

Note: All test items have been performed and recorded as per the above standards.

3.4 DESCRIPTION OF SUPPORT UNITS

The EUT has been tested as an independent unit together with other necessary accessories or support units. The following support units or accessories were used to form a representative test configuration during the tests.

NO.	PRODUCT	BRAND	MODEL NO.	SERIAL NO.	FCC ID
1	N/A	N/A	N/A	N/A	N/A

NO.	SIGNAL CABLE DESCRIPTION OF THE ABOVE SUPPORT UNITS
2	N/A

3.5 CONFIGURATION OF SYSTEM UNDER TEST

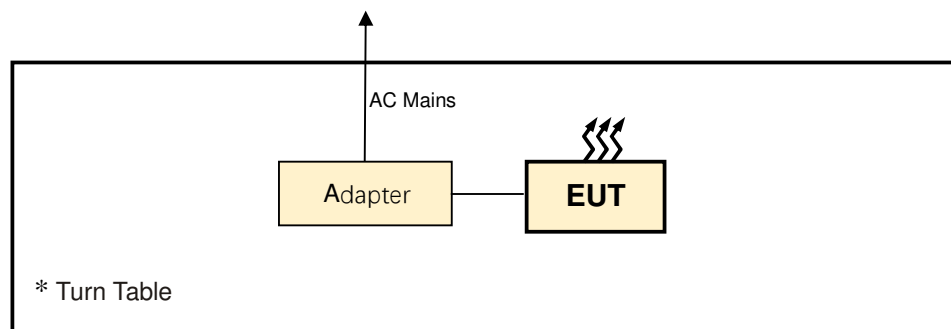

3.6 DUTY CYCLE OF TESET SIGNAL

Test Mode	On Time (ms)	Period (ms)	Duty Cycle (%)	1/T Min. VBW (KHz)	VBW Setting
BT-LE 1M	0.378	0.626	60.4	2.646	3KHz
BT-LE 2M	0.194	0.624	31.1	5.155	10KHz

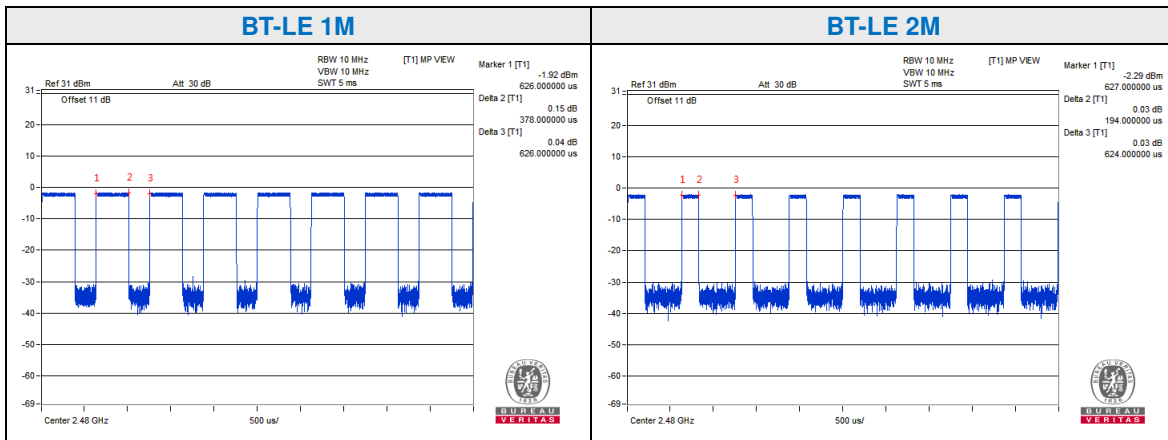

4 TEST TYPES AND RESULTS

4.1 CONDUCTED EMISSION MEASUREMENT

4.1.1 LIMITS OF CONDUCTED EMISSION MEASUREMENT

FREQUENCY OF EMISSION (MHz)	CONDUCTED LIMIT (dB μ V)	
	Quasi-peak	Average
0.15 ~ 0.5	66 to 56	56 to 46
0.5 ~ 5	56	46
5 ~ 30	60	50

- NOTES:**
1. The lower limit shall apply at the transition frequencies.
 2. The limit decreases in line with the logarithm of the frequency in the range of 0.15 to 0.50MHz.
 3. All emanations from a class A/B digital device or system, including any network of conductors and apparatus connected thereto, shall not exceed the level of field strengths specified above.

4.1.2 TEST INSTRUMENTS

Equipment	Manufacturer	Model No.	Serial No.	Next Cal.
EMI Test Receiver	Rohde&Schwarz	ESR7	101494	Jan. 10,24
Artificial Mains Network	Rohde&Schwarz	ENV216	101173	Jan. 11,24
Artificial Mains Network	Rohde&Schwarz	ESH3-Z5	100317	Jan. 10,24
V-LISN (CISPR 25)	SCHWARZBECK	NNBM 8124-200	8124-200 05857	Jun. 14, 24
V-LISN (CISPR 25)	SCHWARZBECK	NNBM 8124-200	8124-200 05858	Jun. 14, 24
Voltage probe	SCHWARZBECK	TK 9421	TK 9421-176	Jul. 27, 24
Coaxial RF Cable	SUHNER	RG 223/U-CE	C2310066DG	Jul. 24, 24
Test software	ADT	ADT_Cond_V7.3.7	N/A	N/A

- NOTES:**
1. The test was performed in shielded room 553.
 2. The calibration interval of the above test instruments is 12 months. And the calibrations are traceable to CEPREI/CHINA, GRGT/CHINA and NIM/CHINA.



Test Report No.: RF2309WDG0035-2

4.1.3 TEST PROCEDURES

- a. The EUT was placed 0.4 meters from the conducting wall of the shielded room with EUT being connected to the power mains through a line impedance stabilization network (LISN). Other support units were connected to the power mains through another LISN. The two LISNs provide 50 ohm/ 50uH of coupling impedance for the measuring instrument.
- b. Both lines of the power mains connected to the EUT were checked for maximum conducted interference.
- c. The frequency range from 150kHz to 30MHz was searched. Emission levels under (Limit - 20dB) was not recorded.

NOTE: All modes of operation were investigated and the worst-case emissions are reported.

4.1.4 DEVIATION FROM TEST STANDARD

No deviation.

4.1.5 TEST SETUP

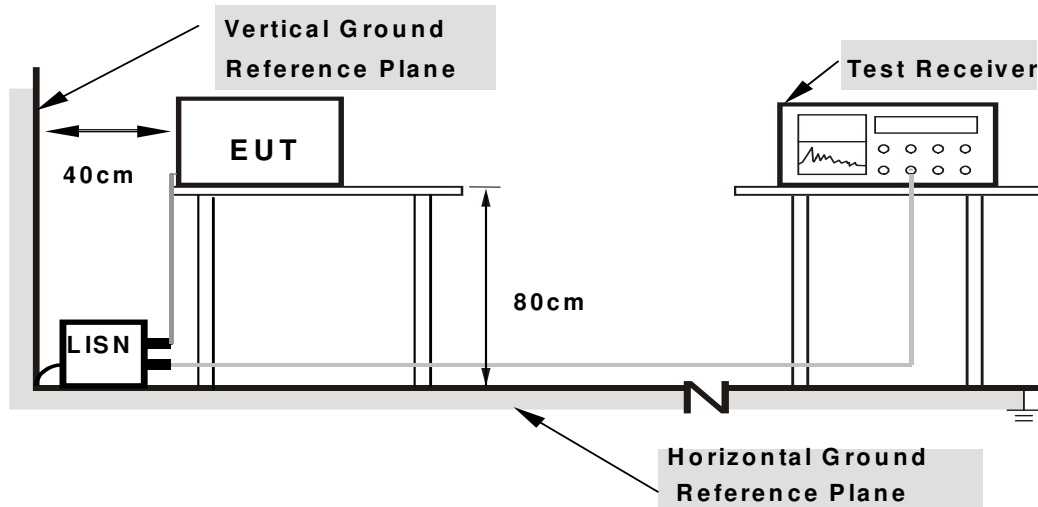

Note: 1. Support units were connected to second LISN.

2. Both of LISNs (AMN) are 80 cm from EUT and at least 80 cm from other units and other metal planes

For the actual test configuration, please refer to the attached file (Test Setup Photo).

4.1.6 EUT OPERATING CONDITIONS

- a. Turned on the power and connected of all equipment.
- b. EUT was operated according to the type used was description in manufacturer's specifications or the User's Manual.

4.1.7 TEST RESULTS

CONDUCTED WORST-CASE DATA: BT Link

PHASE	Line	6dB BANDWIDTH	9kHz
--------------	------	----------------------	------

No.	Freq. [MHz]	Corr. Factor (dB)	Reading Value		Emission Level		Limit		Margin	
			[dB (uV)]		[dB (uV)]		[dB (uV)]		(dB)	
			Q.P.	AV.	Q.P.	AV.	Q.P.	AV.	Q.P.	AV.
1	0.15000	9.98	42.18	28.76	52.16	38.74	66.00	56.00	-13.84	-17.26
2	0.17475	10.00	38.42	23.01	48.42	33.01	64.73	54.73	-16.31	-21.72
3	0.42860	10.13	29.23	19.55	39.36	29.68	57.28	47.28	-17.92	-17.60
4	0.53503	10.14	32.99	23.00	43.13	33.14	56.00	46.00	-12.87	-12.86
5	0.60675	10.15	28.80	18.41	38.95	28.56	56.00	46.00	-17.05	-17.44
6	0.69670	10.17	28.02	18.37	38.19	28.54	56.00	46.00	-17.81	-17.46

REMARKS: The emission levels of other frequencies were very low against the limit.

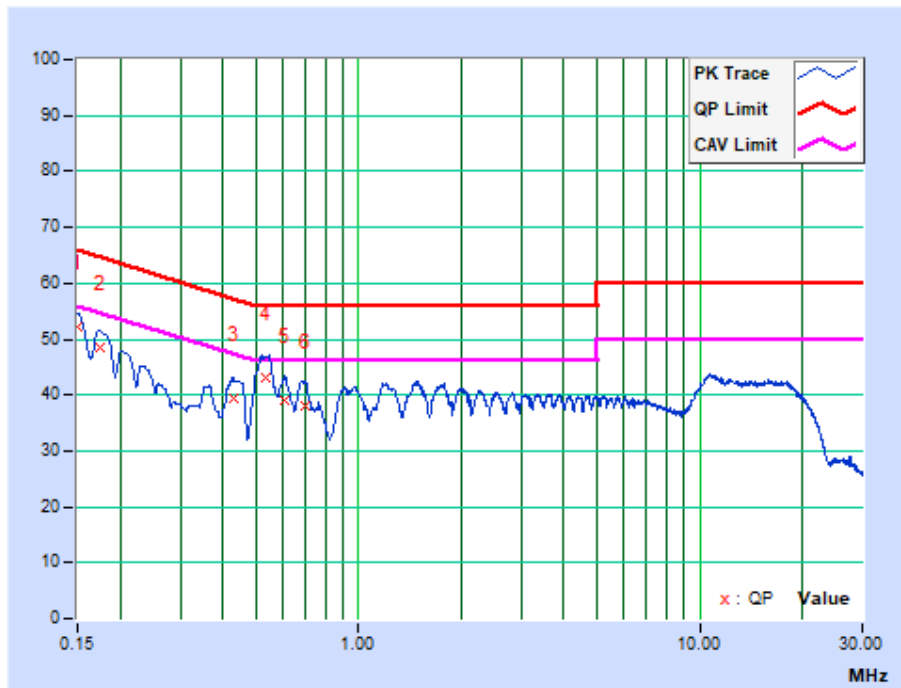

PHASE	Neutral	6dB BANDWIDTH	9kHz
--------------	---------	----------------------	------

No.	Freq. [MHz]	Corr. Factor (dB)	Reading Value		Emission Level		Limit		Margin	
			[dB (uV)]		[dB (uV)]		[dB (uV)]		(dB)	
			Q.P.	AV.	Q.P.	AV.	Q.P.	AV.	Q.P.	AV.
1	0.17605	9.98	37.06	22.31	47.04	32.29	64.67	54.67	-17.63	-22.38
2	0.24000	10.04	29.99	18.67	40.03	28.71	62.10	52.10	-22.06	-23.38
3	0.35068	10.08	23.18	15.90	33.26	25.98	58.95	48.95	-25.69	-22.97
4	0.43891	10.09	26.74	18.67	36.83	28.76	57.08	47.08	-20.25	-18.32
5	0.51971	10.09	32.15	23.61	42.24	33.70	56.00	46.00	-13.76	-12.30
6	1.49100	10.17	26.51	18.48	36.68	28.65	56.00	46.00	-19.32	-17.35

REMARKS: The emission levels of other frequencies were very low against the limit.

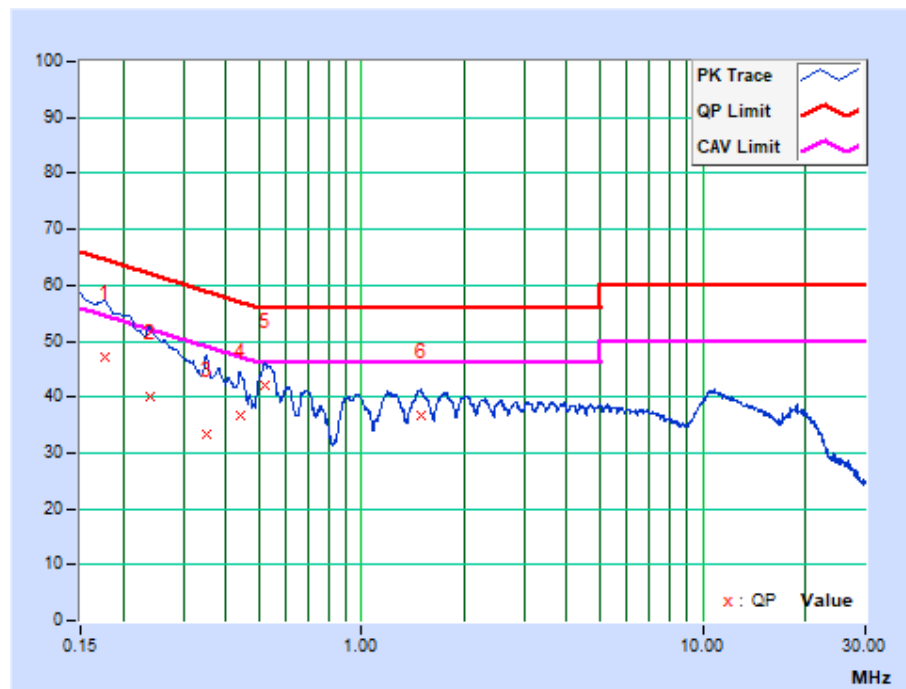

4.2 RADIATED EMISSION MEASUREMENT

4.2.1 LIMITS OF RADIATED EMISSION MEASUREMENT

Radiated emissions which fall in the restricted bands, as defined in Section 15.205(a), must also comply with the radiated emission limits specified in Section 15.209(a).

FREQUENCIES (MHz)	FIELD STRENGTH (microvolts/meter)	MEASUREMENT DISTANCE (meters)
0.009 ~ 0.490	2400/F(kHz)	300
0.490 ~ 1.705	24000/F(kHz)	30
1.705 ~ 30.0	30	30
30 ~ 88	100	3
88 ~ 216	150	3
216 ~ 960	200	3
Above 960	500	3

NOTE:

1. The lower limit shall apply at the transition frequencies.
2. Emission level (dBuV/m) = 20 log Emission level (uV/m).
3. As shown in 15.35(b), for frequencies above 1000MHz, the field strength limits are based on average detector, however, the peak field strength of any emission shall not exceed the maximum permitted average limits, specified above by more than 20dB under any condition of modulation.



Test Report No.: RF2309WDG0035-2

4.2.2 TEST INSTRUMENTS

Equipment	Manufacturer	Model No.	Serial No.	Next Cal.
EMI Test Receiver	Rohde&Schwarz	ESU40	100449	Jan. 10, 24
Signal and Spectrum Analyzer	Rohde&Schwarz	FSV7	102331	May. 09, 24
Active Loop Antenna (9KHz -30MHz)	SCHWARZBECK	FMZB 1519B	1519B-045	Apr. 27, 24
Amplifier (9KHz -1GHz)	Burgeon	BPA-530	100210	Mar. 06, 24
Trilog-Broadband Antenna(20M-2G)	SCHWARZBECK	VULB 9168	01282	Aug. 21, 24
Horn Antenna (1GHz -18GHz)	ETS -Lindgren	3117	00062558	Apr. 27, 24
Horn Antenna (18GHz -40GHz)	SCHWARZBECK	BBHA 9170	BBHA9170147	Apr. 28, 24
3m Semi-anechoic Chamber	ETS-LINDGREN	9m*6m*6m	NSEMC003	May 22, 24
Test Software	ADT	ADT_Radiated_V7.6.15.9.2	N/A	N/A
Broadband Pre-amplifier (1GHz~18GHz)	SCHWARZBECK	BBV9718	305	Apr. 26, 24
Pre-Amplifier (18GHz-40GHz)	EMCI	EMC 184045	980102	Jan. 16, 24
BLUETOOTH TESTER	Rohde&Schwarz	CBT32	100811	N/A

NOTES:

1. The test was performed in 966 Chamber.
2. The calibration interval of the above test instruments is 12 months and the calibrations are traceable to CEPREI/CHINA, GRGT/CHINA and NIM/CHINA.
3. The horn antenna is used only for the measurement of emission frequency above 1GHz if tested.
4. The FCC Site Registration No. is 749762.

4.2.3 TEST PROCEDURES

- a. The EUT was placed on the top of a rotating table 1.5 meters (above 1GHz) and 0.8 meters (below 1GHz) above the ground at a 3 meters semi-anechoic chamber. The table was rotated 360 degrees to determine the position of the highest radiation.
- b. The EUT was set 3 meters away from the interference-receiving antenna, which was mounted on the top of a variable-height antenna tower.
- c. The antenna is a broadband antenna, and its height is varied from one meter to four meters above the ground to determine the maximum value of the field strength. Both horizontal and vertical polarizations of the antenna are set to make the measurement.
- d. For each suspected emission, the EUT was arranged to its worst case and then the antenna was tuned to heights from 1 meter to 4 meters and the rotatable table was turned from 0 degrees to 360 degrees to find the maximum reading.
- e. The test-receiver system was set to Peak Detect Function and Specified Bandwidth with Maximum Hold Mode.
- f. For below 30MHz, a loop antenna with its vertical plane is place 3m from the EUT and rotated about its vertical axis for maximum response at each azimuth about the EUT. And the centre of the loop shall be 1.3m above the ground.
- g. During the test, each emission was maximized by: having the EUT continuously working, investigated all operating modes, rotated about all 3 axis (X, Y & Z) and considered typical configuration to obtain worst position, manipulating interconnecting cables, For battery operated equipment, the equipment tests shall be perform using fresh batteries. The turntable was rotated to maximize the emission level.

NOTES:

1. The resolution bandwidth and video bandwidth of test receiver/spectrum analyzer is 120kHz for Quasi-peak detection at frequency below 1GHz.
2. The resolution bandwidth of test receiver/spectrum analyzer is 1 MHz and video bandwidth is 3MHz for Peak detection at frequency above 1GHz.
3. The resolution bandwidth of test receiver/spectrum analyzer is 1MHz and the video bandwidth is $\geq 1/T$ (Duty cycle < 98%) or 10Hz(Duty cycle > 98%) for Average detection (AV) at frequency above 1GHz.
4. All modes of operation were investigated and the worst-case emissions are reported.
5. The testing of the EUT was performed on all 3 orthogonal axes; the worst-case test configuration was reported on the file test setup photo.

4.2.4 DEVIATION FROM TEST STANDARD

No deviation.

4.2.5 TEST SETUP

Below 30MHz test setup

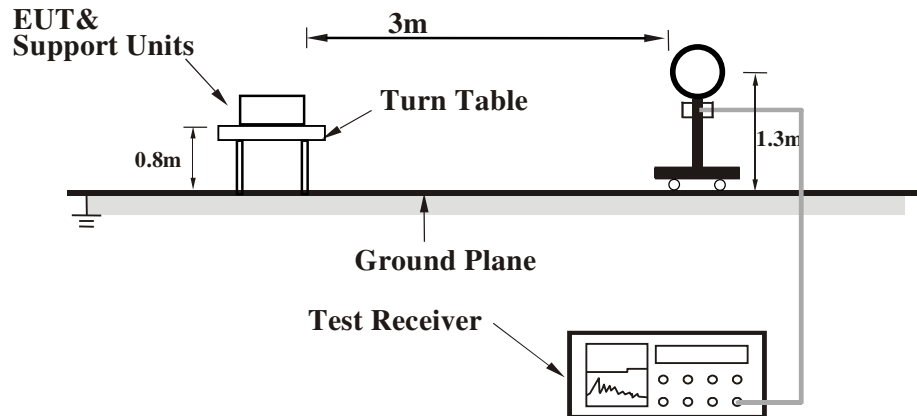

Below 1GHz test setup

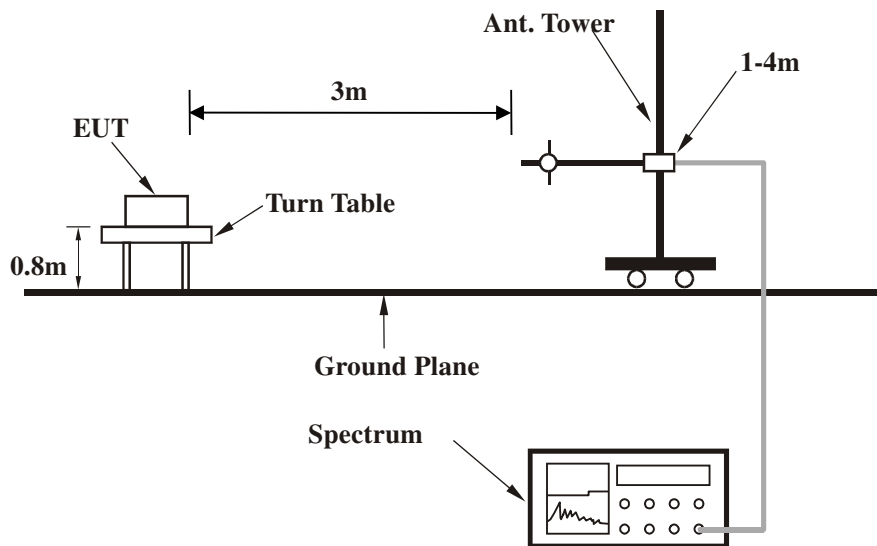

Note: For the actual test configuration, please refer to the attached file (Test Setup Photo).

Above 1GHz test setup

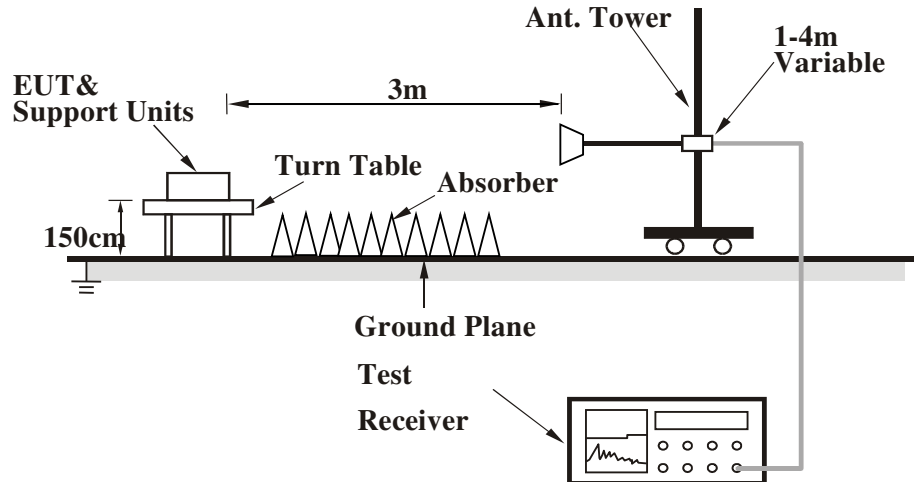

Note: For the actual test configuration, please refer to the attached file (Test Setup Photo).

4.2.6 EUT OPERATING CONDITIONS

- Set the EUT under full load condition and placed them on a testing table.
- Set the transmitter part of EUT under transmission condition continuously at specific channel frequency.
- The necessary accessories enable the EUT in full functions.

4.2.7 TEST RESULTS

BELOW 1GHz WORST-CASE DATA:

BT-LE (GFSK)

CHANNEL	TX Channel 39	DETECTOR FUNCTION	Quasi-Peak (QP)
FREQUENCY RANGE	9KHz ~ 1GHz		

ANTENNA POLARITY & TEST DISTANCE: HORIZONTAL AT 3 M								
NO.	FREQ. (MHz)	EMISSION LEVEL (dBuV/m)	LIMIT (dBuV/m)	MARGIN (dB)	ANTENNA HEIGHT (m)	TABLE ANGLE (Degree)	RAW VALUE (dBuV)	CORRECTION FACTOR (dB/m)
1	82.85	27.65 QP	40.00	-12.35	1.00 H	49	49.31	-21.66
2	120.16	24.87 QP	43.50	-18.63	1.00 H	34	43.57	-18.70
3	199.44	33.39 QP	43.50	-10.11	1.00 H	113	52.77	-19.38
4	216.00	31.70 QP	43.50	-11.80	1.00 H	19	50.51	-18.81
5	353.33	23.91 QP	46.00	-22.09	1.00 H	19	37.82	-13.91
6	413.96	22.18 QP	46.00	-23.82	1.00 H	55	34.68	-12.50

REMARKS:

1. Emission level (dBuV/m) = Raw Value (dBuV) + Correction Factor (dB/m).
2. Correction Factor (dB/m) = Antenna Factor (dB/m) + Cable Factor (dB).
3. The emission levels of other frequencies were greater than 20dB margin.
4. 9KHz~30MHz have been test and test data more than 20dB margin.
5. Margin value = Emission level – Limit value

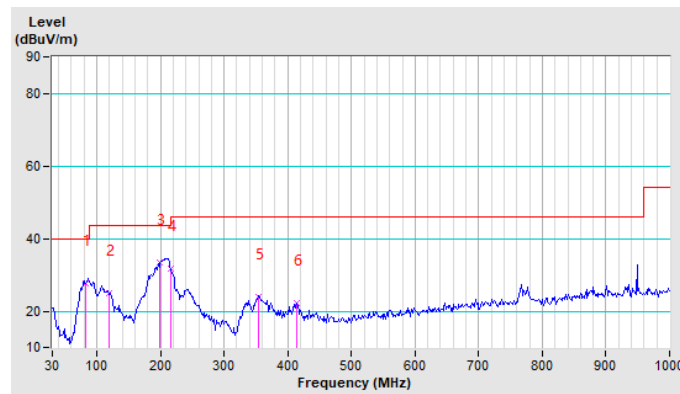

CHANNEL	TX Channel 39	DETECTOR FUNCTION	Quasi-Peak (QP)
FREQUENCY RANGE	9KHz ~ 1GHz		

ANTENNA POLARITY & TEST DISTANCE: VERTICAL AT 3 M								
NO.	FREQ. (MHz)	EMISSION LEVEL (dBuV/m)	LIMIT (dBuV/m)	MARGIN (dB)	ANTENNA HEIGHT (m)	TABLE ANGLE (Degree)	RAW VALUE (dBuV)	CORRECTION FACTOR (dB/m)
1	30.00	32.47 QP	40.00	-7.53	1.77 V	212	51.13	-18.66
2	79.74	34.56 QP	40.00	-5.44	1.60 V	229	56.23	-21.67
3	118.61	32.33 QP	43.50	-11.17	1.96 V	192	51.15	-18.82
4	196.33	24.19 QP	43.50	-19.31	2.00 V	178	43.16	-18.97
5	264.73	19.88 QP	46.00	-26.12	2.00 V	163	36.71	-16.83
6	356.44	26.45 QP	46.00	-19.55	2.00 V	148	40.30	-13.85

REMARKS:

1. Emission level (dBuV/m) = Raw Value (dBuV) + Correction Factor (dB/m).
2. Correction Factor (dB/m) = Antenna Factor (dB/m) + Cable Factor (dB).
3. The emission levels of other frequencies were greater than 20dB margin.
4. 9KHz~30MHz have been test and test data more than 20dB margin.
5. Margin value = Emission level – Limit value

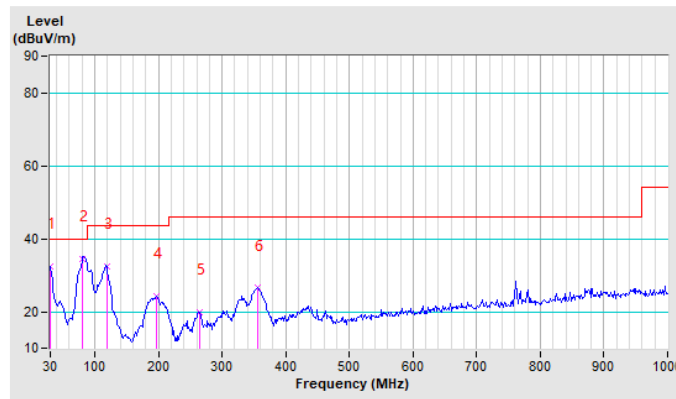



ABOVE 1GHz TEST DATA:

BT-LE (GFSK) 1M

CHANNEL	TX Channel 0	DETECTOR FUNCTION	Peak (PK)
FREQUENCY RANGE	1GHz ~ 25GHz		Average (AV)

ANTENNA POLARITY & TEST DISTANCE : HORIZONTAL AT 3 M

NO.	FREQ. (MHz)	EMISSION LEVEL (dBuV/m)	LIMIT (dBuV/m)	MARGIN (dB)	ANTENNA HEIGHT (m)	TABLE ANGLE (Degree)	RAW VALUE (dBuV)	CORRECTION FACTOR (dB/m)
1	2390.00	47.31 PK	74.00	-26.69	1.40 H	150	50.56	-3.25
2	2390.00	35.82 AV	54.00	-18.18	1.40 H	150	39.07	-3.25
3	*2402.00	103.17 PK			1.40 H	150	106.39	-3.22
4	*2402.00	100.83 AV			1.40 H	150	104.05	-3.22
5	4804.00	48.22 PK	74.00	-25.78	1.52 H	147	50.44	-2.22
6	4804.00	36.72 AV	54.00	-17.28	1.52 H	147	38.94	-2.22
7	#7206.00	50.16 PK	74.00	-23.84	1.53 H	188	48.79	1.37
8	#7206.00	38.21 AV	54.00	-15.79	1.53 H	188	36.84	1.37

ANTENNA POLARITY & TEST DISTANCE : VERTICAL AT 3 M

NO.	FREQ. (MHz)	EMISSION LEVEL (dBuV/m)	LIMIT (dBuV/m)	MARGIN (dB)	ANTENNA HEIGHT (m)	TABLE ANGLE (Degree)	RAW VALUE (dBuV)	CORRECTION FACTOR (dB/m)
1	2390.00	46.16 PK	74.00	-27.84	1.20 V	130	49.41	-3.25
2	2390.00	35.77 AV	54.00	-18.23	1.20 V	130	39.02	-3.25
3	*2402.00	102.76 PK			1.20 V	130	105.98	-3.22
4	*2402.00	99.73 AV			1.20 V	130	102.95	-3.22
5	4804.00	47.63 PK	74.00	-26.37	1.56 V	248	49.85	-2.22
6	4804.00	37.81 AV	54.00	-16.19	1.56 V	248	40.03	-2.22
7	#7206.00	51.73 PK	74.00	-22.27	1.00 V	185	50.36	1.37
8	#7206.00	36.24 AV	54.00	-17.76	1.00 V	185	34.87	1.37

REMARKS:

1. Emission level (dBuV/m) = Raw Value (dBuV) + Correction Factor (dB/m).
2. Correction Factor (dB/m) = Antenna Factor (dB/m) + Cable Factor (dB).
3. The emission levels of other frequencies were greater than 20dB margin.
4. Margin value = Emission level – Limit value.
5. " * ": Fundamental frequency.
6. " # ": The radiated frequency is out of the restricted band.

CHANNEL	TX Channel 19	DETECTOR FUNCTION	Peak (PK)
FREQUENCY RANGE	1GHz ~ 25GHz		Average (AV)

ANTENNA POLARITY & TEST DISTANCE : HORIZONTAL AT 3 M								
NO.	FREQ. (MHz)	EMISSION LEVEL (dBuV/m)	LIMIT (dBuV/m)	MARGIN (dB)	ANTENNA HEIGHT (m)	TABLE ANGLE (Degree)	RAW VALUE (dBuV)	CORRECTION FACTOR (dB/m)
1	*2440.00	102.84 PK			1.00 H	158	105.96	-3.12
2	*2440.00	99.13 AV			1.00 H	158	102.25	-3.12
3	4880.00	47.14 PK	74.00	-26.86	1.25 H	48	49.33	-2.19
4	4880.00	35.81 AV	54.00	-18.19	1.25 H	48	38.00	-2.19
5	7320.00	50.17 PK	74.00	-23.83	1.00 H	184	49.31	0.86
6	7320.00	36.26 AV	54.00	-17.74	1.00 H	184	35.40	0.86
ANTENNA POLARITY & TEST DISTANCE : VERTICAL AT 3 M								
NO.	FREQ. (MHz)	EMISSION LEVEL (dBuV/m)	LIMIT (dBuV/m)	MARGIN (dB)	ANTENNA HEIGHT (m)	TABLE ANGLE (Degree)	RAW VALUE (dBuV)	CORRECTION FACTOR (dB/m)
1	*2440.00	101.72 PK			1.00 V	175	104.84	-3.12
2	*2440.00	98.02 AV			1.00 V	175	101.14	-3.12
3	4880.00	46.26 PK	74.00	-27.74	1.25 V	163	48.45	-2.19
4	4880.00	36.11 AV	54.00	-17.89	1.25 V	163	38.30	-2.19
5	7320.00	51.73 PK	74.00	-22.27	1.00 V	174	50.87	0.86
6	7320.00	35.21 AV	54.00	-18.79	1.00 V	174	34.35	0.86

REMARKS:

1. Emission level (dBuV/m) = Raw Value (dBuV) + Correction Factor (dB/m).
2. Correction Factor (dB/m) = Antenna Factor (dB/m) + Cable Factor (dB).
3. The emission levels of other frequencies were greater than 20dB margin.
4. Margin value = Emission level – Limit value.
5. " * " : Fundamental frequency.

CHANNEL	TX Channel 39	DETECTOR FUNCTION	Peak (PK)
FREQUENCY RANGE	1GHz ~ 25GHz		Average (AV)

ANTENNA POLARITY & TEST DISTANCE : HORIZONTAL AT 3 M								
NO.	FREQ. (MHz)	EMISSION LEVEL (dBuV/m)	LIMIT (dBuV/m)	MARGIN (dB)	ANTENNA HEIGHT (m)	TABLE ANGLE (Degree)	RAW VALUE (dBuV)	CORRECTION FACTOR (dB/m)
1	*2480.00	103.17 PK			1.40 H	160	106.19	-3.02
2	*2480.00	99.38 AV			1.40 H	160	102.40	-3.02
3	2483.50	44.33 PK	74.00	-29.67	1.40 H	160	47.33	-3.00
4	2483.50	35.82 AV	54.00	-18.18	1.40 H	160	38.82	-3.00
5	4960.00	48.61 PK	74.00	-25.39	1.20 H	185	50.76	-2.15
6	4960.00	36.24 AV	54.00	-17.76	1.20 H	185	38.39	-2.15
7	7440.00	50.11 PK	74.00	-23.89	1.00 H	146	49.78	0.33
8	7440.00	36.17 AV	54.00	-17.83	1.00 H	146	35.84	0.33
ANTENNA POLARITY & TEST DISTANCE : VERTICAL AT 3 M								
NO.	FREQ. (MHz)	EMISSION LEVEL (dBuV/m)	LIMIT (dBuV/m)	MARGIN (dB)	ANTENNA HEIGHT (m)	TABLE ANGLE (Degree)	RAW VALUE (dBuV)	CORRECTION FACTOR (dB/m)
1	*2480.00	102.85 PK			1.20 V	130	105.87	-3.02
2	*2480.00	100.16 AV			1.20 V	130	103.18	-3.02
3	2483.50	46.17 PK	74.00	-27.83	1.20 V	130	49.17	-3.00
4	2483.50	36.22 AV	54.00	-17.78	1.20 V	130	39.22	-3.00
5	4960.00	49.03 PK	74.00	-24.97	1.00 V	185	51.18	-2.15
6	4960.00	35.14 AV	54.00	-18.86	1.00 V	185	37.29	-2.15
7	7440.00	51.28 PK	74.00	-22.72	1.55 V	185	50.95	0.33
8	7440.00	35.77 AV	54.00	-18.23	1.55 V	185	35.44	0.33

REMARKS:

1. Emission level (dBuV/m) = Raw Value (dBuV) + Correction Factor (dB/m).
2. Correction Factor (dB/m) = Antenna Factor (dB/m) + Cable Factor (dB).
3. The emission levels of other frequencies were greater than 20dB margin.
4. Margin value = Emission level – Limit value.
5. " * " : Fundamental frequency.

BT-LE (GFSK) 2M

CHANNEL	TX Channel 0	DETECTOR FUNCTION	Peak (PK)
FREQUENCY RANGE	1GHz ~ 25GHz		Average (AV)

ANTENNA POLARITY & TEST DISTANCE : HORIZONTAL AT 3 M								
NO.	FREQ. (MHz)	EMISSION LEVEL (dBuV/m)	LIMIT (dBuV/m)	MARGIN (dB)	ANTENNA HEIGHT (m)	TABLE ANGLE (Degree)	RAW VALUE (dBuV)	CORRECTION FACTOR (dB/m)
1	2390.00	46.22 PK	74.00	-27.78	1.20 H	130	49.47	-3.25
2	2390.00	35.21 AV	54.00	-18.79	1.20 H	130	38.46	-3.25
3	*2402.00	103.75 PK			1.20 H	130	106.97	-3.22
4	*2402.00	100.26 AV			1.20 H	130	103.48	-3.22
5	4804.00	47.39 PK	74.00	-26.61	1.20 H	188	49.61	-2.22
6	4804.00	34.82 AV	54.00	-19.18	1.20 H	188	37.04	-2.22
7	#7206.00	50.16 PK	74.00	-23.84	1.00 H	130	48.79	1.37
8	#7206.00	37.15 AV	54.00	-16.85	1.00 H	130	35.78	1.37
ANTENNA POLARITY & TEST DISTANCE : VERTICAL AT 3 M								
NO.	FREQ. (MHz)	EMISSION LEVEL (dBuV/m)	LIMIT (dBuV/m)	MARGIN (dB)	ANTENNA HEIGHT (m)	TABLE ANGLE (Degree)	RAW VALUE (dBuV)	CORRECTION FACTOR (dB/m)
1	2390.00	45.28 PK	74.00	-28.72	1.20 V	180	48.53	-3.25
2	2390.00	35.33 AV	54.00	-18.67	1.20 V	180	38.58	-3.25
3	*2402.00	102.47 PK			1.20 V	180	105.69	-3.22
4	*2402.00	99.47 AV			1.20 V	180	102.69	-3.22
5	4804.00	46.39 PK	74.00	-27.61	1.00 V	185	48.61	-2.22
6	4804.00	34.82 AV	54.00	-19.18	1.00 V	185	37.04	-2.22
7	#7206.00	52.31 PK	74.00	-21.69	1.50 V	236	50.94	1.37
8	#7206.00	37.59 AV	54.00	-16.41	1.50 V	236	36.22	1.37

REMARKS:

1. Emission level (dBuV/m) = Raw Value (dBuV) + Correction Factor (dB/m).
2. Correction Factor (dB/m) = Antenna Factor (dB/m) + Cable Factor (dB).
3. The emission levels of other frequencies were greater than 20dB margin.
4. Margin value = Emission level – Limit value.
5. " * " : Fundamental frequency.
6. " # " : The radiated frequency is out of the restricted band.

CHANNEL	TX Channel 19	DETECTOR FUNCTION	Peak (PK)
FREQUENCY RANGE	1GHz ~ 25GHz		Average (AV)

ANTENNA POLARITY & TEST DISTANCE : HORIZONTAL AT 3 M								
NO.	FREQ. (MHz)	EMISSION LEVEL (dBuV/m)	LIMIT (dBuV/m)	MARGIN (dB)	ANTENNA HEIGHT (m)	TABLE ANGLE (Degree)	RAW VALUE (dBuV)	CORRECTION FACTOR (dB/m)
1	*2440.00	101.48 PK			1.00 H	178	104.60	-3.12
2	*2440.00	99.32 AV			1.00 H	178	102.44	-3.12
3	4880.00	46.18 PK	74.00	-27.82	1.00 H	82	48.37	-2.19
4	4880.00	37.23 AV	54.00	-16.77	1.00 H	82	39.42	-2.19
5	7320.00	50.17 PK	74.00	-23.83	1.00 H	246	49.31	0.86
6	7320.00	35.89 AV	54.00	-18.11	1.00 H	246	35.03	0.86
ANTENNA POLARITY & TEST DISTANCE : VERTICAL AT 3 M								
NO.	FREQ. (MHz)	EMISSION LEVEL (dBuV/m)	LIMIT (dBuV/m)	MARGIN (dB)	ANTENNA HEIGHT (m)	TABLE ANGLE (Degree)	RAW VALUE (dBuV)	CORRECTION FACTOR (dB/m)
1	*2440.00	102.88 PK			1.00 V	177	106.00	-3.12
2	*2440.00	98.36 AV			1.00 V	177	101.48	-3.12
3	4880.00	46.98 PK	74.00	-27.02	1.00 V	125	49.17	-2.19
4	4880.00	36.28 AV	54.00	-17.72	1.00 V	125	38.47	-2.19
5	7320.00	50.18 PK	74.00	-23.82	1.00 V	177	49.32	0.86
6	7320.00	36.95 AV	54.00	-17.05	1.00 V	177	36.09	0.86

REMARKS:

1. Emission level (dBuV/m) = Raw Value (dBuV) + Correction Factor (dB/m).
2. Correction Factor (dB/m) = Antenna Factor (dB/m) + Cable Factor (dB).
3. The emission levels of other frequencies were greater than 20dB margin.
4. Margin value = Emission level – Limit value.
5. " * " : Fundamental frequency.

CHANNEL	TX Channel 39	DETECTOR FUNCTION	Peak (PK)
FREQUENCY RANGE	1GHz ~ 25GHz		Average (AV)

ANTENNA POLARITY & TEST DISTANCE : HORIZONTAL AT 3 M								
NO.	FREQ. (MHz)	EMISSION LEVEL (dBuV/m)	LIMIT (dBuV/m)	MARGIN (dB)	ANTENNA HEIGHT (m)	TABLE ANGLE (Degree)	RAW VALUE (dBuV)	CORRECTION FACTOR (dB/m)
1	*2480.00	101.52 PK			1.50 H	140	104.54	-3.02
2	*2480.00	100.24 AV			1.50 H	140	103.26	-3.02
3	2483.50	46.28 PK	74.00	-27.72	1.50 H	140	49.28	-3.00
4	2483.50	35.62 AV	54.00	-18.38	1.50 H	140	38.62	-3.00
5	4960.00	47.15 PK	74.00	-26.85	1.00 H	153	49.30	-2.15
6	4960.00	37.62 AV	54.00	-16.38	1.00 H	153	39.77	-2.15
7	7440.00	50.36 PK	74.00	-23.64	1.00 H	133	50.03	0.33
8	7440.00	37.23 AV	54.00	-16.77	1.00 H	133	36.90	0.33
ANTENNA POLARITY & TEST DISTANCE : VERTICAL AT 3 M								
NO.	FREQ. (MHz)	EMISSION LEVEL (dBuV/m)	LIMIT (dBuV/m)	MARGIN (dB)	ANTENNA HEIGHT (m)	TABLE ANGLE (Degree)	RAW VALUE (dBuV)	CORRECTION FACTOR (dB/m)
1	*2480.00	103.25 PK			1.20 V	130	106.27	-3.02
2	*2480.00	100.88 AV			1.20 V	130	103.90	-3.02
3	2483.50	47.23 PK	74.00	-26.77	1.20 V	130	50.23	-3.00
4	2483.50	35.88 AV	54.00	-18.12	1.20 V	130	38.88	-3.00
5	4960.00	46.22 PK	74.00	-27.78	1.00 V	153	48.37	-2.15
6	4960.00	35.82 AV	54.00	-18.18	1.00 V	153	37.97	-2.15
7	7440.00	52.03 PK	74.00	-21.97	1.00 V	44	51.70	0.33
8	7440.00	38.14 AV	54.00	-15.86	1.00 V	44	37.81	0.33

REMARKS:

1. Emission level (dBuV/m) = Raw Value (dBuV) + Correction Factor (dB/m).
2. Correction Factor (dB/m) = Antenna Factor (dB/m) + Cable Factor (dB).
3. The emission levels of other frequencies were greater than 20dB margin.
4. Margin value = Emission level – Limit value.
5. " * " : Fundamental frequency.



4.3 6dB BANDWIDTH MEASUREMENT

4.3.1 LIMITS OF 6dB BANDWIDTH MEASUREMENT

The minimum of 6dB Bandwidth Measurement is 0.5 MHz.

4.3.2 TEST INSTRUMENTS

Equipment	Manufacturer	Model No.	Serial No.	Next Cal.
Power Sensor	Keysight	U2021XA	MY57320002	Jan. 11, 24
Power Meter	Anritsu	ML2495A	1139001	Aug. 22, 24
Power Sensor	Anritsu	MA2411B	1531155	Aug. 22, 24
Digital Multimeter	FLUKE	15B	A1220010DG	N/A
Humid & Temp Programmable Tester	Haida	HD-225T	110807201	Nov. 02, 23
Oscilloscope	Agilent	DSO9254A	MY51260160	Jul. 27, 24
Signal and Spectrum Analyzer	Rohde&Schwarz	FSV40	101094	Jan. 11, 24
Signal Generator	Agilent	N5183A	MY50140980	Jul. 20, 24
MXG-B RF Vector Signal Generator	Keysight	N5182B	MY56200288	Jul. 20, 24
BLUETOOTH TESTER	Rohde&Schwarz	CBT32	100811	N/A
Attenuator	MINI	BW-S10W2+	S130129FGE2	N/A
DC Source	Keysight	E3642A	MY56146098	N/A
Test software	ADT	ADT_RF Test Software V6.6.5.3	N/A	N/A

NOTES:

1. The test was performed in RF Oven room.
2. The calibration interval of the above test instruments is 12 months and the calibrations are traceable to CEPREI/CHINA, GRGT/CHINA and NIM/CHINA.



Test Report No.: RF2309WDG0035-2

4.3.3 TEST PROCEDURE

1. Set RBW = 100 kHz.
2. Set the video bandwidth (VBW) ≥ 3 RBW.
3. Detector = Peak.
4. Trace mode = max hold.
5. Sweep = auto couple.
6. Allow the trace to stabilize.
7. Measure the maximum width of the emission that is constrained by the frequencies associated with the two outermost amplitude points (upper and lower frequencies) that are attenuated by 6 dB relative to the maximum level measured in the fundamental emission.

4.3.4 DEVIATION FROM TEST STANDARD

No deviation.

4.3.5 TEST SETUP

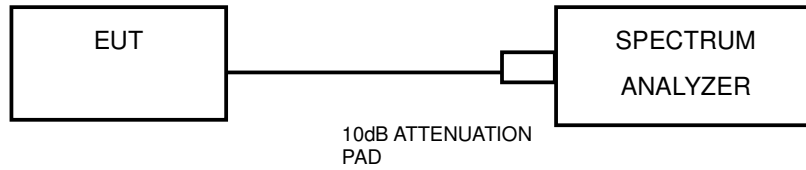

4.3.6 EUT OPERATING CONDITIONS

The software provided by client to enable the EUT under transmission condition continuously at lowest, middle and highest channel frequencies individually.

4.3.7 TEST RESULTS

BT-LE (GFSK) 1M

CHANNEL	CHANNEL FREQUENCY (MHz)	6dB BANDWIDTH (MHz)	MINIMUM LIMIT (MHz)	PASS / FAIL
0	2402	0.65	0.5	PASS
19	2440	0.65	0.5	PASS
39	2480	0.65	0.5	PASS

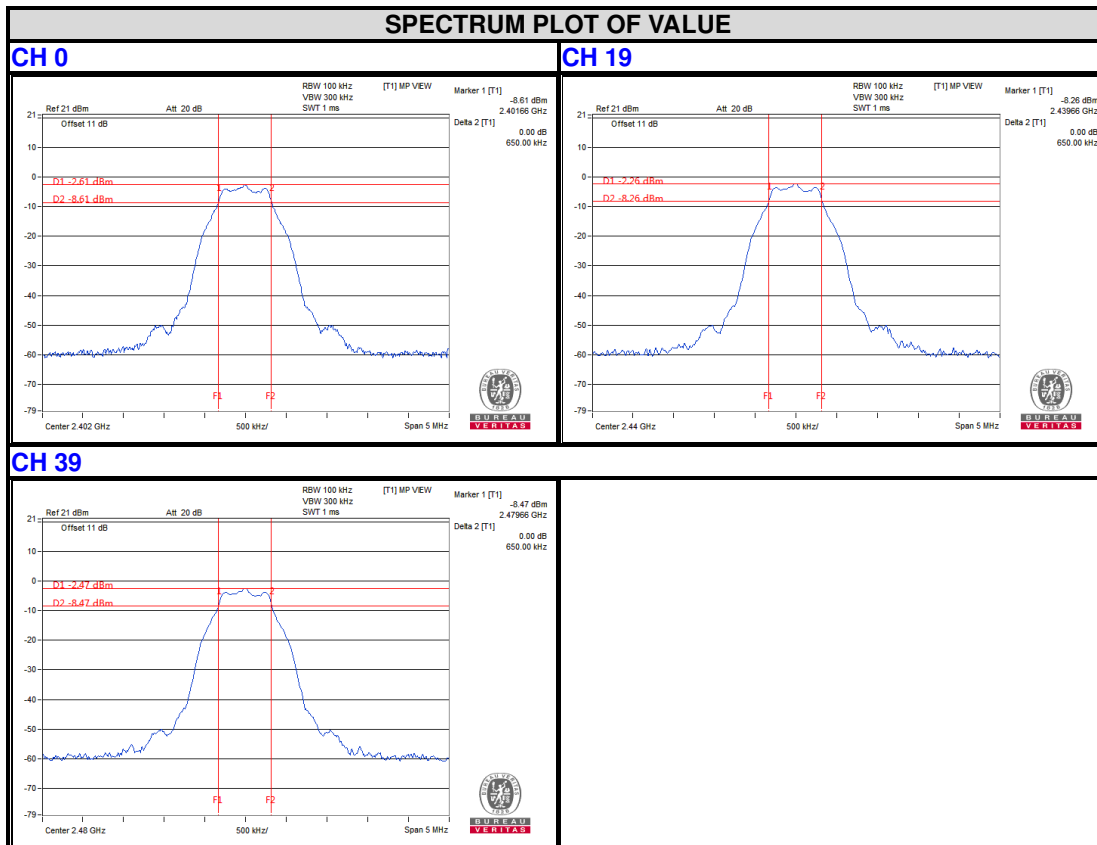

BT-LE (GFSK) 2M

CHANNEL	CHANNEL FREQUENCY (MHz)	6dB BANDWIDTH (MHz)	MINIMUM LIMIT (MHz)	PASS / FAIL
0	2402	1.12	0.5	PASS
19	2440	1.12	0.5	PASS
39	2480	1.13	0.5	PASS

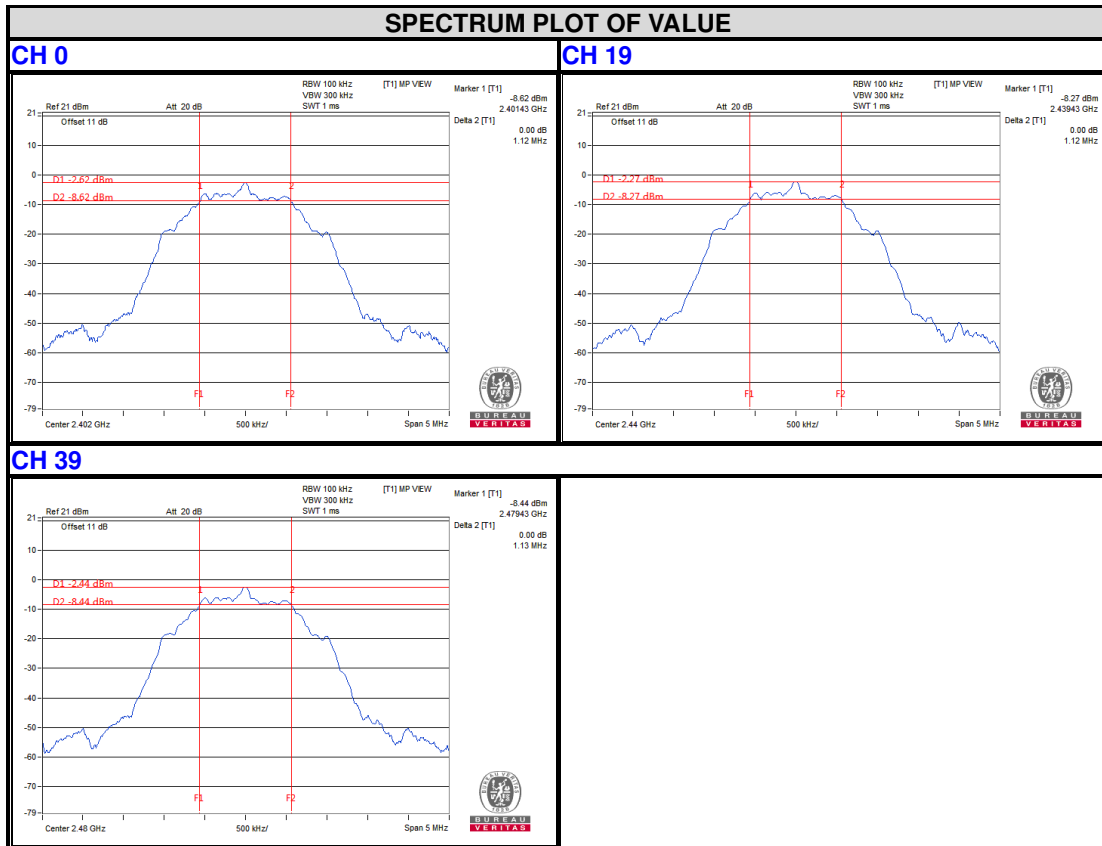

4.4 CONDUCTED OUTPUT POWER

4.4.1 LIMITS OF CONDUCTED OUTPUT POWER MEASUREMENT

For systems using digital modulation in the 2400–2483.5 MHz band: 1 Watt (30dBm)

4.4.2 TEST SETUP

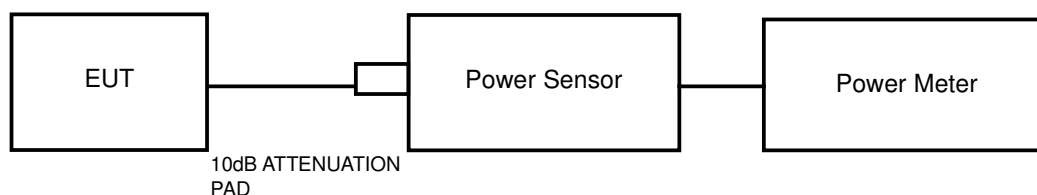

4.4.3 TEST INSTRUMENTS

Refer to section 4.3.2 to get information of above instrument.

4.4.4 TEST PROCEDURES

A peak power sensor was used on the output port of the EUT. A power meter was used to read the response of the peak power sensor and set the detector to PEAK. Record the power level.

An average power sensor was used on the output port of the EUT. A power meter was used to read the response of the average power sensor and set the detector to AVERAGE. Record the power level.

4.4.5 DEVIATION FROM TEST STANDARD

No deviation.

4.4.6 EUT OPERATING CONDITIONS

The software provided by client to enable the EUT under transmission condition continuously at lowest, middle and highest channel frequencies individually.

4.4.7 TEST RESULTS

4.4.7.1 MAXIMUM PEAK OUTPUT POWER

BT-LE (GFSK) 1M

CHANNEL	CHANNEL FREQUENCY (MHz)	PEAK POWER (dBm)	PEAK POWER (mW)	PEAK POWER LIMIT (W)	PASS/FAIL
0	2402	-2.13	0.6124	1	PASS
19	2440	-1.83	0.6561	1	PASS
39	2480	-2.13	0.6124	1	PASS

BT-LE (GFSK) 2M

CHANNEL	CHANNEL FREQUENCY (MHz)	PEAK POWER (dBm)	PEAK POWER (mW)	PEAK POWER LIMIT (W)	PASS/FAIL
0	2402	-2.23	0.5984	1	PASS
19	2440	-1.90	0.6457	1	PASS
39	2480	-2.20	0.6026	1	PASS



4.4.7.2 AVERAGE OUTPUT POWER (FOR REFERENCE)

The average power sensor was used on the output port of the EUT. A power meter was used to read the response of the power sensor. Record the power level.

BT-LE (GFSK) 1M

CHANNEL	CHANNEL FREQUENCY (MHz)	AVERAGE POWER (dBm)	AVERAGE POWER (mW)
0	2402	-3.30	0.4677
19	2440	-2.82	0.5224
39	2480	-2.79	0.526

BT-LE (GFSK) 2M

CHANNEL	CHANNEL FREQUENCY (MHz)	AVERAGE POWER (dBm)	AVERAGE POWER (mW)
0	2402	-2.87	0.5164
19	2440	-2.40	0.5754
39	2480	-2.35	0.5821

4.5 POWER SPECTRAL DENSITY MEASUREMENT

4.5.1 LIMITS OF POWER SPECTRAL DENSITY MEASUREMENT

The Maximum of Power Spectral Density Measurement is 8dBm/3KHz.

4.5.2 TEST SETUP

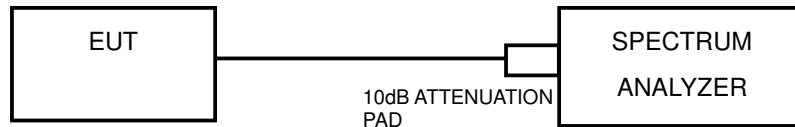

4.5.3 TEST INSTRUMENTS

Refer to section 4.3.2 to get information of above instrument.

4.5.4 TEST PROCEDURE

1. Set the span to 1.5 times the DTS bandwidth
2. Set the RBW = 3 kHz, VBW $\geq 3 \times$ RBW, Detector = peak.
3. Sweep time = auto couple, Trace mode = max hold, allow trace to fully stabilize.
4. Use the peak marker function to determine the maximum amplitude level.

4.5.5 DEVIATION FROM TEST STANDARD

No deviation.

4.5.6 EUT OPERATING CONDITION

The software provided by client to enable the EUT under transmission condition continuously at lowest, middle and highest channel frequencies individually.

4.5.7 TEST RESULTS

BT-LE (GFSK) 1M

Channel	FREQ. (MHz)	PSD (dBm/3kHz)	Limit (dBm/3kHz)	PASS /FAIL
0	2402	-16.94	8	PASS
19	2440	-16.56	8	PASS
39	2480	-16.78	8	PASS

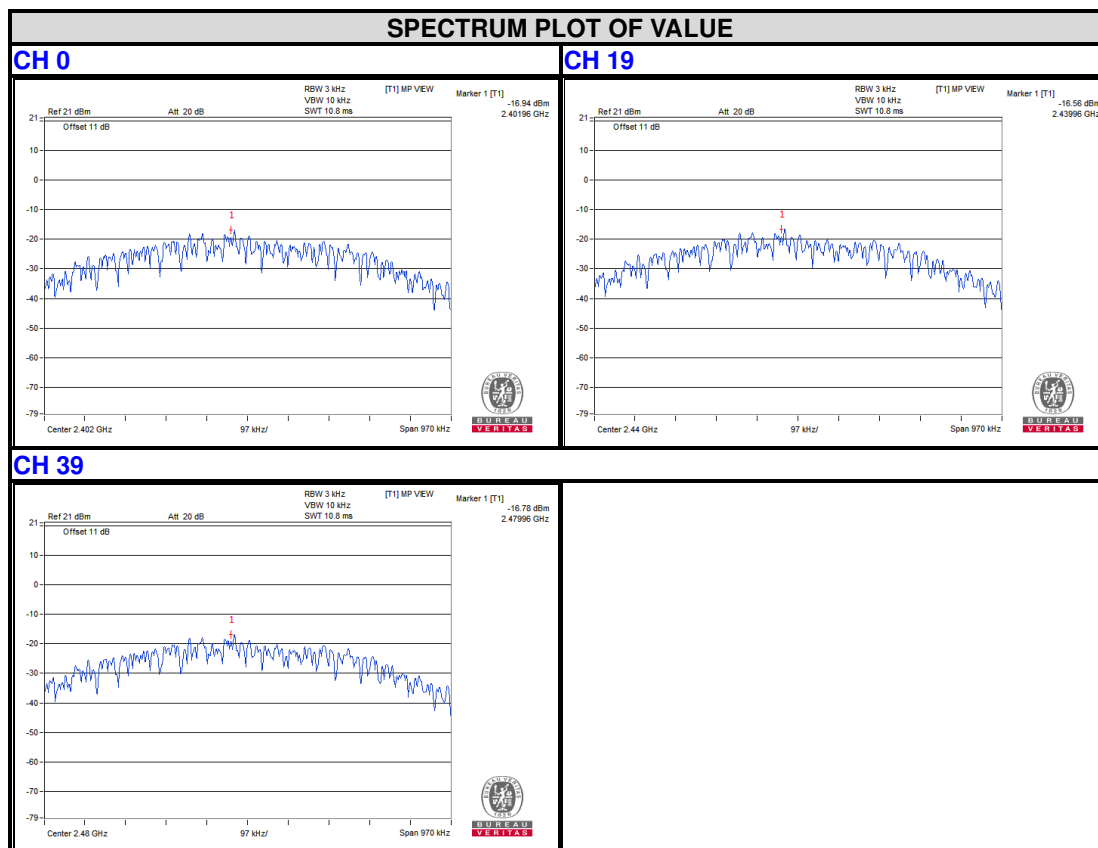

BT-LE (GFSK) 2M

Channel	FREQ. (MHz)	PSD (dBm/3kHz)	Limit (dBm/3kHz)	PASS /FAIL
0	2402	-19.48	8	PASS
19	2440	-19.10	8	PASS
39	2480	-19.30	8	PASS

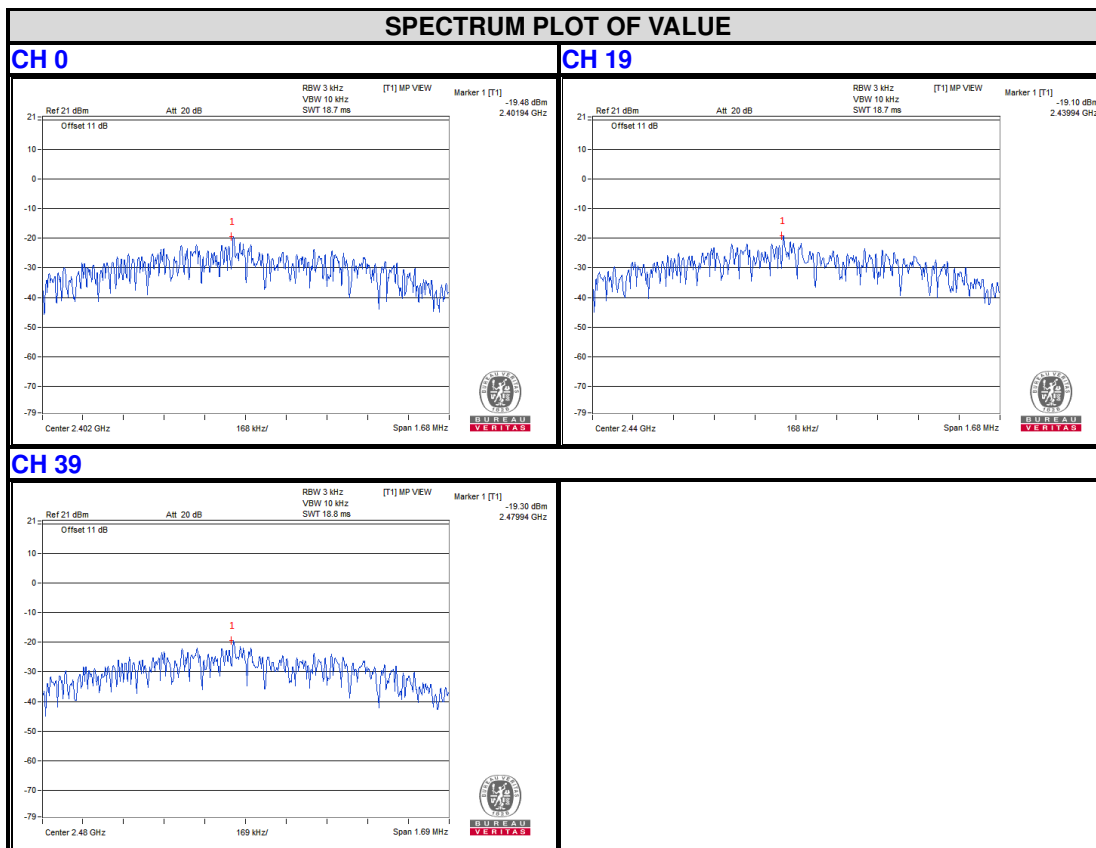

4.6 OUT OF BAND EMISSION MEASUREMENT

4.6.1 LIMITS OF OUT OF BAND EMISSION MEASUREMENT

Below -20dB of the highest emission level of operating band (in 100kHz Resolution Bandwidth).

4.6.2 TEST SETUP

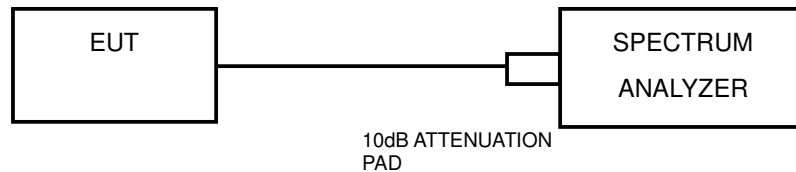

4.6.3 TEST INSTRUMENTS

Refer to section 4.3.2 to get information of above instrument.

4.6.4 TEST PROCEDURE

MEASUREMENT PROCEDURE REF

1. Set the RBW = 100 kHz.
2. Set the VBW \geq 300 kHz.
3. Detector = peak.
4. Sweep time = auto couple.
5. Trace mode = max hold.
6. Allow trace to fully stabilize.
7. Use the peak marker function to determine the maximum power level in any 100 kHz band segment within the fundamental EBW.



Test Report No.: RF2309WDG0035-2

MEASUREMENT PROCEDURE OOB

1. Set RBW = 100 kHz.
2. Set VBW \geq 300 kHz.
3. Set span to encompass the spectrum to be examined
4. Detector = peak.
5. Trace Mode = max hold.
6. Sweep = auto couple.

4.6.5 DEVIATION FROM TEST STANDARD

No deviation.

4.6.6 EUT OPERATING CONDITION

The software provided by client to enable the EUT under transmission condition continuously at lowest, middle and highest channel frequencies individually.

4.6.7 TEST RESULTS

BT-LE (GFSK) 1M

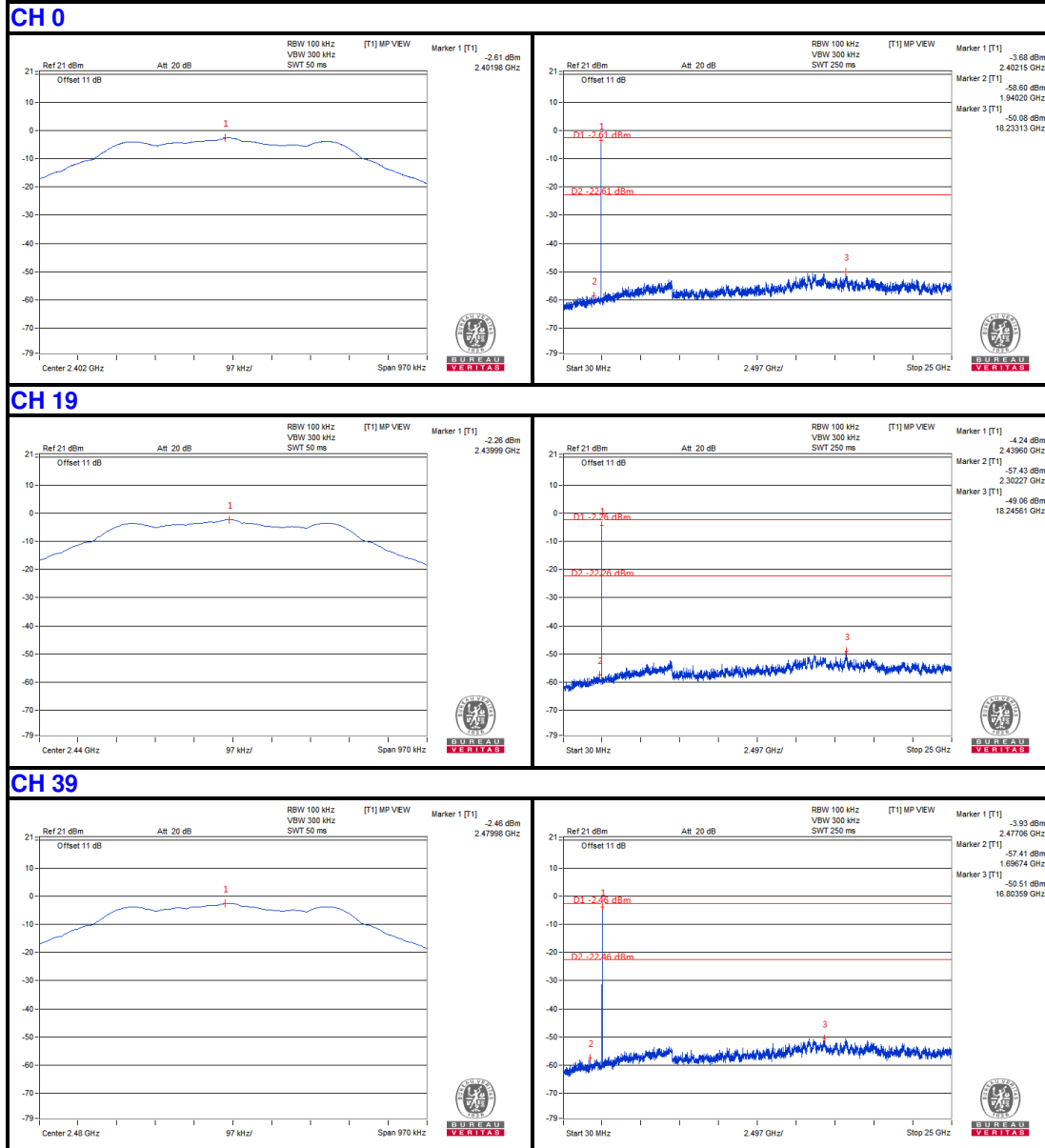

BT-LE (GFSK) 2M

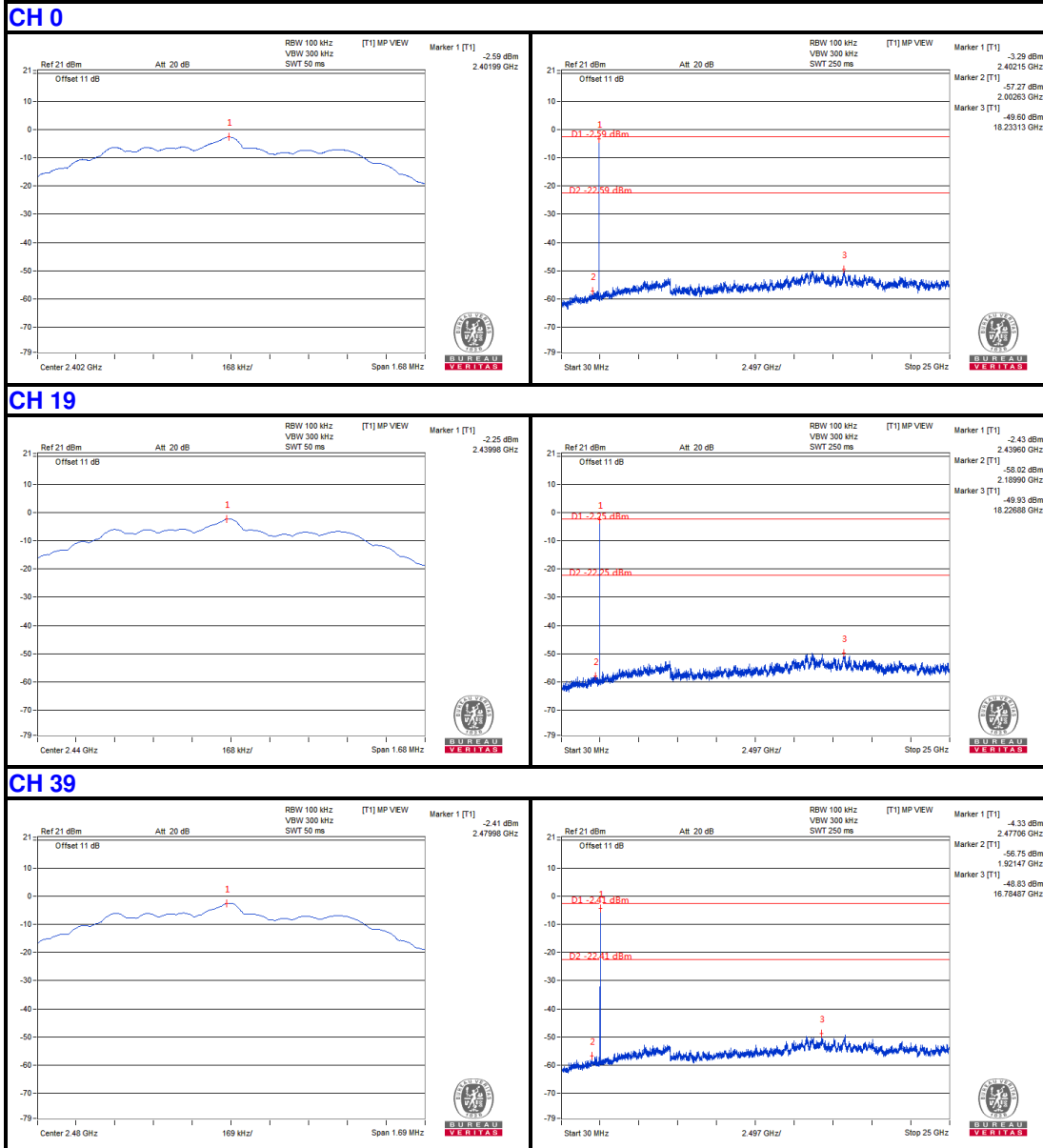

Band Edge 1M:

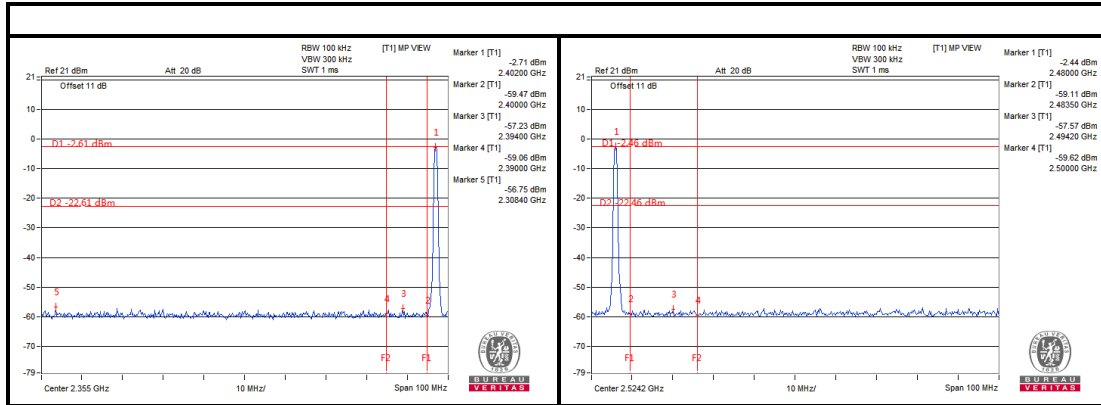

Band Edge 2M:

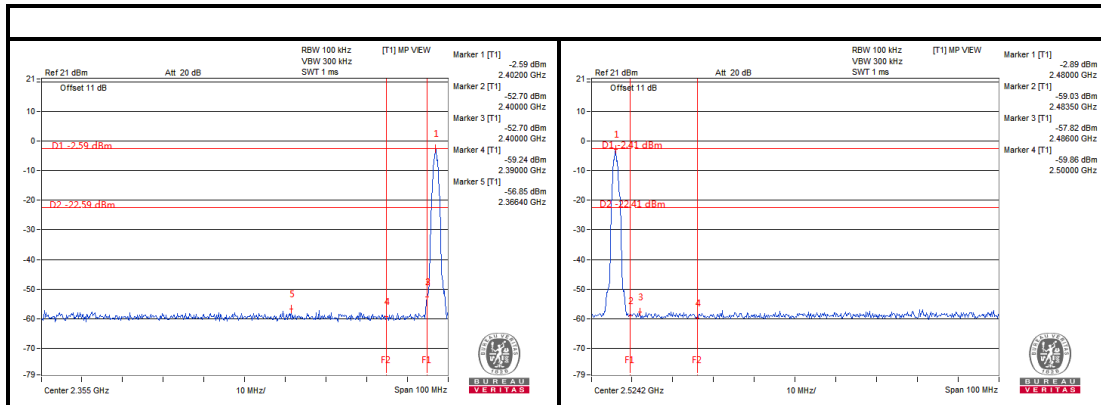



Test Report No.: RF2309WDG0035-2

5 PHOTOGRAPHS OF THE TEST CONFIGURATION

Please refer to the attached file (Test Setup Photo).



Test Report No.: RF2309WDG0035-2

6 APPENDIX A - MODIFICATIONS RECORDERS FOR ENGINEERING CHANGES TO THE EUT BY THE LAB

No any modifications are made to the EUT by the lab during the test.

---END---