

FCC TEST REPORT

For

Fujian Newland Auto-ID Tech Co., Ltd.

Portable (Barcode) Data Collector

Model No.: NLS-MT70

Prepared for : Fujian Newland Auto-ID Tech Co., Ltd.
Address : Newland Science & Technology Park, No.1 Rujiang West Rd.,
Mawei district, Fuzhou, Fujian, China

Prepared by : Shenzhen LCS Compliance Testing Laboratory Ltd.
Address : 1/F., Xingyuan Industrial Park, Tongda Road, Bao'an Avenue,
Bao'an District, Shenzhen, Guangdong, China

Date of receipt of test sample : April 03, 2013
Number of tested samples : 1
Serial number : Prototype
Date of Test : April 03, 2013 - February 24, 2014
Date of Report : February 24, 2014

FCC TEST REPORT
FCC CFR 47 PART 15 C(15.247): 2012

Report Reference No. : LCS130403174TF

Date of Issue : February 24, 2014

Testing Laboratory Name : Shenzhen LCS Compliance Testing Laboratory Ltd.

Address : 1/F., Xingyuan Industrial Park, Tongda Road, Bao'an Avenue, Bao'an District, Shenzhen, Guangdong, China

Testing Location/ Procedure : Full application of Harmonised standards [checked]
Partial application of Harmonised standards []
Other standard testing method []

Applicant's Name : Fujian Newland Auto-ID Tech Co., Ltd.

Address : Newland Science & Technology Park, No.1 Rujiang West Rd., Mawei district, Fuzhou, Fujian, China

Test Specification

Standard : FCC CFR 47 PART 15 C(15.247): 2012

Test Report Form No. : LCSEMC-1.0

TRF Originator : Shenzhen LCS Compliance Testing Laboratory Ltd.

Master TRF : Dated 2011-03

Shenzhen LCS Compliance Testing Laboratory Ltd. All rights reserved.

This publication may be reproduced in whole or in part for non-commercial purposes as long as the Shenzhen LCS Compliance Testing Laboratory Ltd. is acknowledged as copyright owner and source of the material. Shenzhen LCS Compliance Testing Laboratory Ltd. takes no responsibility for and will not assume liability for damages resulting from the reader's interpretation of the reproduced material due to its placement and context.

Test Item Description. : Portable (Barcode) Data Collector

Trade Mark : [Newland logo]

Model/ Type reference : NLS-MT70
DC 3.7V by battery(3300mAh)

Ratings : Adapter Parameters: Input: AC 100~240V, 50/60Hz, 0.4A
Output: DC 5V, 1.5A

Result : Positive

Compiled by:

[Signature: Leo Lee]

Leo Lee/ File administrators

Supervised by:

[Signature: Fox Zhang]

Fox Zhang/ Technique principal

Approved by:

[Signature: Gavin Liang]

Gavin Liang/ Manager

FCC -- TEST REPORT

Test Report No. : LCS130403174TF	<u>February 24, 2014</u> Date of issue
---	---

Type / Model.....	: NLS-MT70
EUT.....	: Portable (Barcode) Data Collector
Applicant.....	: Fujian Newland Auto-ID Tech Co., Ltd.
Address.....	: Newland Science & Technology Park, No.1 Rujiang West Rd., Mawei district, Fuzhou, Fujian, China
Telephone.....	: /
Fax.....	: /
Manufacturer.....	: Fujian Newland Auto-ID Tech Co., Ltd.
Address.....	: Newland Science & Technology Park, No.1 Rujiang West Rd., Mawei district, Fuzhou, Fujian, China
Telephone.....	: /
Fax.....	: /
Factory.....	: Fujian Newland Auto-ID Tech Co., Ltd.
Address.....	: Newland Science & Technology Park, No.1 Rujiang West Rd., Mawei district, Fuzhou, Fujian, China
Telephone.....	: /
Fax.....	: /

Test Result	Positive
--------------------	-----------------

The test report merely corresponds to the test sample.
 It is not permitted to copy extracts of these test result without the written permission of the test laboratory.

TABLE OF CONTENTS

- 1. GENERAL INFORMATION5**
 - 1.1. DESCRIPTION OF DEVICE (EUT)5
 - 1.2. HOST SYSTEM CONFIGURATION LIST AND DETAILS6
 - 1.3. EXTERNAL I/O CABLE6
 - 1.4. DESCRIPTION OF TEST FACILITY7
 - 1.5. STATEMENT OF THE MEASUREMENT UNCERTAINTY7
 - 1.6. MEASUREMENT UNCERTAINTY7
 - 1.7. DESCRIPTION OF TEST MODES8
- 2. TEST METHODOLOGY9**
 - 2.1. EUT CONFIGURATION9
 - 2.2. EUT EXERCISE9
 - 2.3. GENERAL TEST PROCEDURES9
- 3. SYSTEM TEST CONFIGURATION10**
 - 3.1. JUSTIFICATION10
 - 3.2. EUT EXERCISE SOFTWARE10
 - 3.3. SPECIAL ACCESSORIES10
 - 3.4. BLOCK DIAGRAM/SCHEMATICS10
 - 3.5. EQUIPMENT MODIFICATIONS10
 - 3.6. TEST SETUP10
- 4. SUMMARY OF TEST RESULTS.....11**
- 5. TEST RESULT12**
 - 5.1. MAXIMUM CONDUCTED OUTPUT POWER MEASUREMENT12
 - 5.2. POWER SPECTRAL DENSITY MEASUREMENT14
 - 5.3. 6 dB SPECTRUM BANDWIDTH MEASUREMENT19
 - 5.4. OCCUPIED BANDWIDTH24
 - 5.5. RADIATED EMISSIONS MEASUREMENT29
 - 5.6. CONDUCTED SPURIOUS EMISSIONS AND BAND EDGES TEST38
 - 5.7. POWER LINE CONDUCTED EMISSIONS44
 - 5.8. ANTENNA REQUIREMENTS46
- 6. LIST OF MEASURING EQUIPMENTS.....47**
- 7. MANUFACTURER/ APPROVAL HOLDER DECLARATION48**

1. GENERAL INFORMATION

1.1. Description of Device (EUT)

EUT : Portable (Barcode) Data Collector

Model Number : NLS-MT70

Power Supply : DC 3.7V by battery(3300mAh)
Adapter Parameters: Input: AC 100~240V, 50/60Hz, 0.4A
Output: DC 5V, 1.5A

Frequency Range : 2412.00-2462.00MHz

Channel Spacing : 5MHz

Channel Number : 11 Channels for 20MHz Bandwidth

Modulation Technology : 802.11b: DSSS(CCK,DQPSK,DBPSK)
802.11g: OFDM(64QAM, 16QAM, QPSK, BPSK)

Data Rates : 802.11b: 1-11Mbps
802.11g: 6-54Mbps

Antenna Type And Gain : Integral antenna, 2.0dBi(Max.)

1.2. Host System Configuration List and Details

Manufacturer	Description	Model	Serial Number	Certificate
Guande Technology Co., Ltd.	Adapter	KSAS0100500150D5	--	VOC

1.3. External I/O Cable

Cable Description	Length (M)	From/Port	To
--	--	--	--

1.4. Description of Test Facility

Site Description

EMC Lab.

: Accredited by CNAS, June 04, 2010

The Certificate Registration Number. is L4595.

Accredited by FCC, July 14, 2011

The Certificate Registration Number. is 899208.

Accredited by Industry Canada, May. 02, 2011

The Certificate Registration Number. is 9642A-1

1.5. Statement of The Measurement Uncertainty

The data and results referenced in this document are true and accurate. The reader is cautioned that there may be errors within the calibration limits of the equipment and facilities. The measurement uncertainty was calculated for all measurements listed in this test report acc. To CISPR 16 – 4 “Specification for radio disturbance and immunity measuring apparatus and methods – Part 4: Uncertainty in EMC Measurements” and is documented in the LCS quality system acc. To DIN EN ISO/IEC 17025. Furthermore, component and process variability of devices similar to that tested may result in additional deviation. The manufacturer has the sole responsibility of continued compliance of the device.

1.6. Measurement Uncertainty

Test Item	Frequency Range	Uncertainty	Note
Radiation Uncertainty	9KHz~30MHz	$\pm 3.10\text{dB}$	(1)
	30MHz~200MHz	$\pm 2.96\text{dB}$	(1)
	200MHz~1000MHz	$\pm 3.10\text{dB}$	(1)
	1GHz~26.5GHz	$\pm 3.80\text{dB}$	(1)
	26.5GHz~40GHz	$\pm 3.90\text{dB}$	(1)
Conduction Uncertainty	150kHz~30MHz	$\pm 1.63\text{dB}$	(1)
Power disturbance	30MHz~300MHz	$\pm 1.60\text{dB}$	(1)

(1). This uncertainty represents an expanded uncertainty expressed at approximately the 95% confidence level using a coverage factor of $k=2$.

1.7. Description Of Test Modes

The EUT has been tested under operating condition.

This test was performed with EUT in X, Y, Z position and the worse case was found when EUT in X position.

Worst-case mode and channel used for 150kHz-30 MHz power line conducted emissions was the mode and channel with the highest output power, that was determined to be 802.11b mode(Low Channel).

Worst-case mode and channel used for 9kHz-1000 MHz radiated emissions was the mode and channel with the highest output power, that was determined to be 802.11b mode(Low Channel).

Worst-Case data rates were utilized from preliminary testing of the Chipset, worst-case data rates used during the testing are as follows:

802.11b Mode : 1 Mbps, DSSS.

802.11g Mode : 6 Mbps, OFDM.

Channel List & Frequency

802.11b/g

Frequency Band	Channel No.	Frequency(MHz)	Channel No.	Frequency(MHz)
2412~2462MHz	1	2412	7	2442
	2	2417	8	2447
	3	2422	9	2452
	4	2427	10	2457
	5	2432	11	2462
	6	2437	--	--

2. TEST METHODOLOGY

All measurements contained in this report were conducted with ANSI C63.4-2003, American National Standard for Methods of Measurement of Radio-Noise Emissions from Low-Voltage Electrical and Electronic Equipment in the range of 9 kHz to 40 GHz.

The radiated testing was performed at an antenna-to-EUT distance of 3 meters. All radiated and conducted emissions measurement was performed at Shenzhen LCS Compliance Testing Laboratory Ltd..

2.1. EUT Configuration

The EUT configuration for testing is installed on RF field strength measurement to meet the Commissions requirement and operating in a manner that intends to maximize its emission characteristics in a continuous normal application.

2.2. EUT Exercise

The EUT was operated in the engineering mode to fix the TX frequency that was for the purpose of the measurements.

According to FCC's request, Test Procedure KDB558074 D01 DTS Meas. Guidance v03r01 is required to be used for this kind of FCC 15.247 digital modulation device.

According to its specifications, the EUT must comply with the requirements of the Section 15.203, 15.205, 15.207, 15.209 and 15.247 under the FCC Rules Part 15 Subpart C.

2.3. General Test Procedures

2.3.1 Conducted Emissions

The EUT is placed on the turntable, which is 0.8 m above ground plane. According to the requirements in Section 13.1.4.1 of ANSI C63.4 Conducted emissions from the EUT measured in the frequency range between 0.15 MHz and 30MHz using Quasi-peak and average detector modes.

2.3.2 Radiated Emissions

The EUT is placed on a turn table, which is 0.8 m above ground plane. The turntable shall rotate 360 degrees to determine the position of maximum emission level. EUT is set 3m away from the receiving antenna, which varied from 1m to 4m to find out the highest emission. And also, each emission was to be maximized by changing the polarization of receiving antenna both horizontal and vertical. In order to find out the maximum emissions, exploratory radiated emission measurements were made according to the requirements in Section 13.1.4.1 of ANSI C63.4

3. SYSTEM TEST CONFIGURATION

3.1. Justification

The system was configured for testing in a continuous transmit condition.

3.2. EUT Exercise Software

N/A

3.3. Special Accessories

N/A

3.4. Block Diagram/Schematics

Please refer to the related document

3.5. Equipment Modifications

Shenzhen LCS Compliance Testing Laboratory Ltd. has not done any modification on the EUT.

3.6. Test Setup

Please refer to the test setup photo.

4. SUMMARY OF TEST RESULTS

Applied Standard: FCC Part 15 Subpart C		
FCC Rules	Description of Test	Result
§15.247(b)	Maximum Conducted Output Power	Compliant
§15.247(e)	Power Spectral Density	Compliant
§15.247(a)(2)	6dB Bandwidth	Compliant
§15.247(a)	Occupied Bandwidth	Compliant
§15.209, §15.247(d)	Radiated and Conducted Spurious Emissions	Compliant
§15.205	Emissions at Restricted Band	Compliant
§15.207(a)	Conducted Emissions	Compliant
§15.203	Antenna Requirements	Compliant
§15.247(i)§2.1093	RF Exposure	Compliant

5. TEST RESULT

5.1. Maximum Conducted Output Power Measurement

5.1.1. Standard Applicable

According to §15.247(b): For systems using digital modulation in the 2400-2483.5 MHz and 5725-5850 MHz band, the limit for maximum peak conducted output power is 30dBm. The limit has to be reduced by the amount in dB that the gain of the antenna exceed 6dBi. In case of point-to-point operation, the limit has to be reduced by 1dB for every 3dB that the directional gain of the antenna exceeds 6dBi.

Systems operating in the 5725-5850 MHz band that are used exclusively for fixed, point-to-point operations may employ transmitting antennas with directional gain greater than 6dBi without any corresponding reduction in transmitter peak output power.

5.1.2. Measuring Instruments

Please refer to section 6 of equipments list in this report.

5.1.3. Test Procedures

The transmitter output (antenna port) was connected to the power meter.

5.1.4. Test Setup Layout

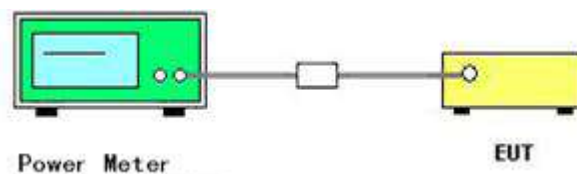

5.1.5. EUT Operation during Test

The EUT was programmed to be in continuously transmitting mode.

5.1.6. Test Result of Maximum Conducted Output Power

Temperature	25°C	Humidity	60%
Test Engineer	Tree	Configurations	802.11b/g

802.11b

Channel	Frequency (MHz)	Conducted Peak Power (dBm)	Max. Limit (dBm)	Result
1	2412	11.75	30	Complies
6	2437	11.63	30	Complies
11	2462	11.19	30	Complies

802.11g

Channel	Frequency (MHz)	Conducted Peak Power (dBm)	Max. Limit (dBm)	Result
1	2412	11.06	30	Complies
6	2437	10.91	30	Complies
11	2462	10.53	30	Complies

5.2. Power Spectral Density Measurement

5.2.1. Standard Applicable

According to §15.247(e): For digitally modulated systems, the power spectral density conducted from the intentional radiator to the antenna shall not be greater than 8 dBm in any 3 kHz band during any time interval of continuous transmission.

5.2.2. Measuring Instruments

Please refer to section 6 of equipments list in this report.

5.2.3. Test Procedures

1. The transmitter was connected directly to a Spectrum Analyzer through a directional couple.
2. The power was monitored at the coupler port with a Spectrum Analyzer. The power level was set to the maximum level.
3. Set the RBW = 3 kHz.
4. Set the VBW $\geq 3 \times$ RBW
5. Set the span to 1.5 times the DTS channel bandwidth.
6. Detector = peak.
7. Sweep time = auto couple.
8. Trace mode = max hold.
9. Allow trace to fully stabilize.
10. Use the peak marker function to determine the maximum power level in any 3 kHz band segment within the fundamental EBW.

5.2.4. Test Setup Layout

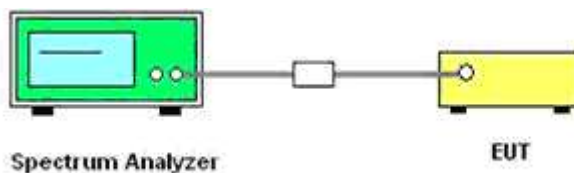

5.2.5. EUT Operation during Test

The EUT was programmed to be in continuously transmitting mode.

5.2.6. Test Result of Power Spectral Density

Temperature	25°C	Humidity	60%
Test Engineer	Tree	Configurations	802.11b/g

802.11b

Channel	Frequency (MHz)	Power Density (dBm/3KHz)	Max. Limit (dBm/3KHz)	Result
1	2412	-10.00	8	Complies
6	2437	-10.93	8	Complies
11	2462	-11.81	8	Complies

802.11g

Channel	Frequency (MHz)	Power Density (dBm/3KHz)	Max. Limit (dBm/3KHz)	Result
1	2412	-11.12	8	Complies
6	2437	-12.93	8	Complies
11	2462	-14.18	8	Complies

802.11b power density

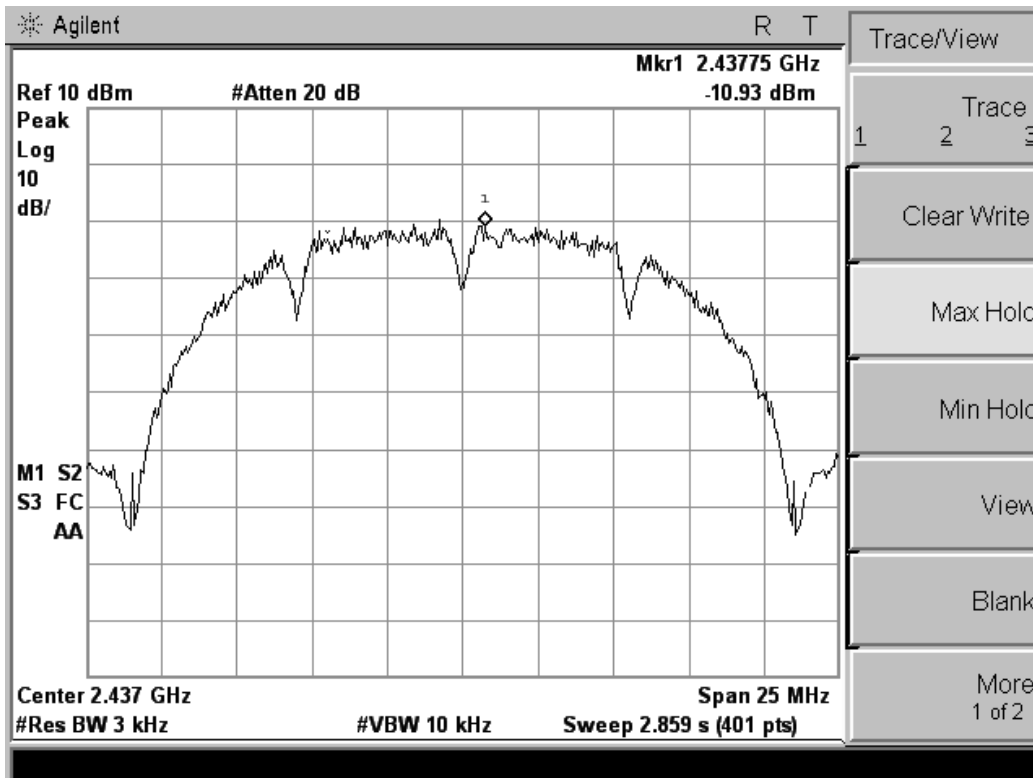
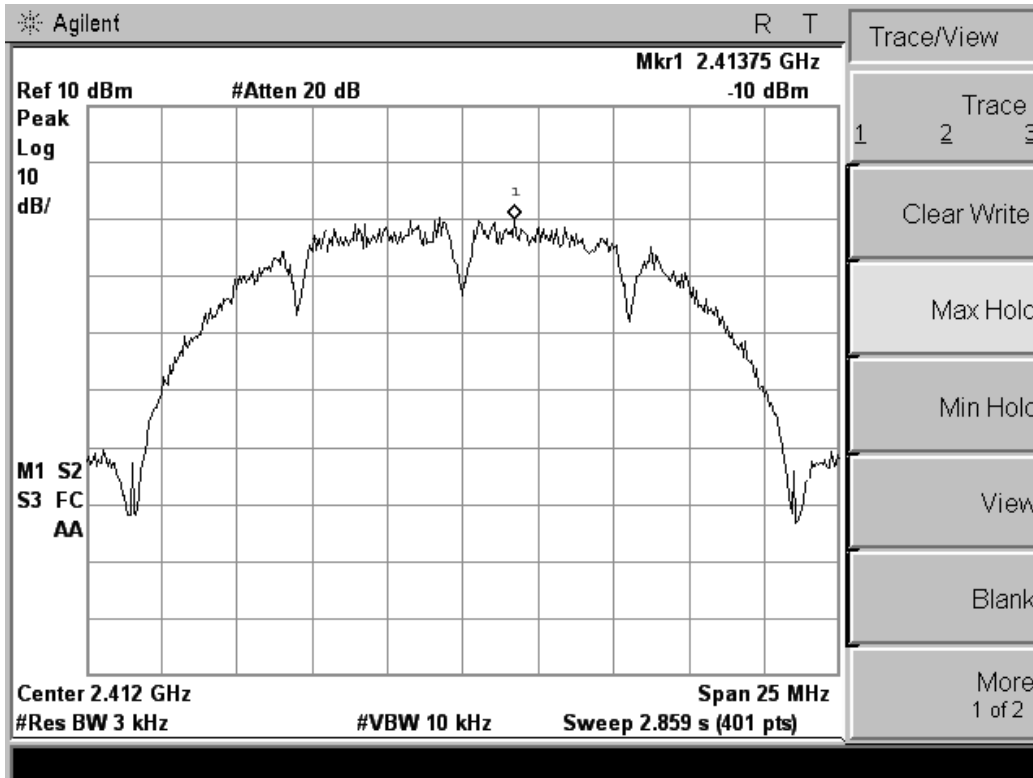

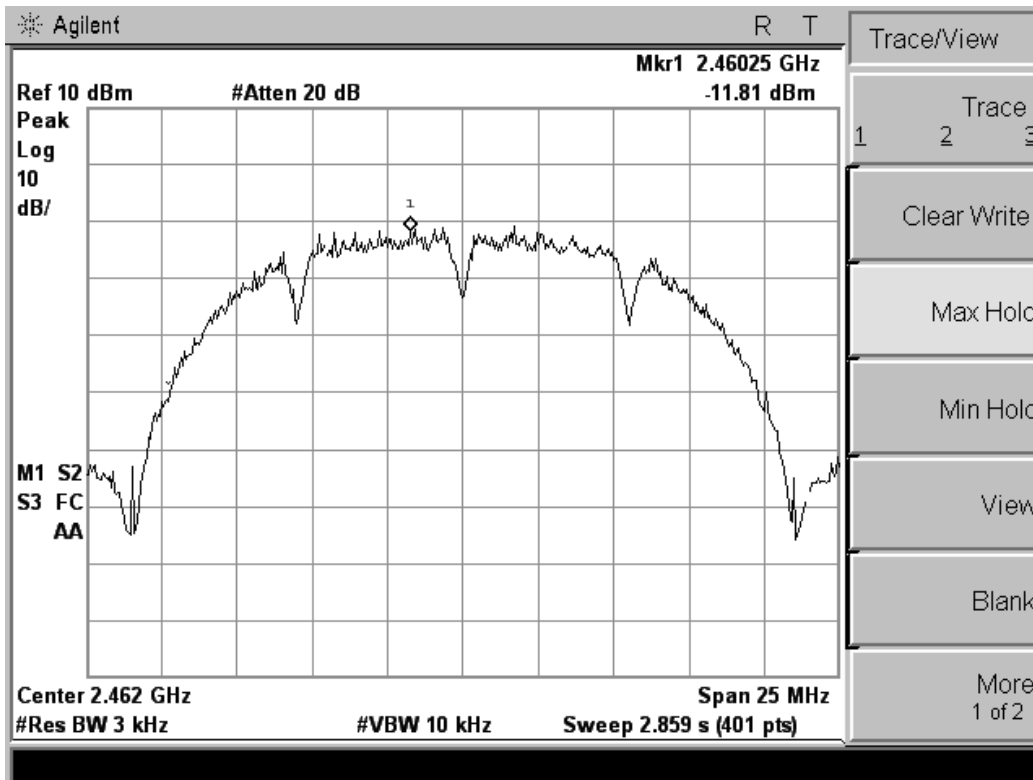

802.11g power density

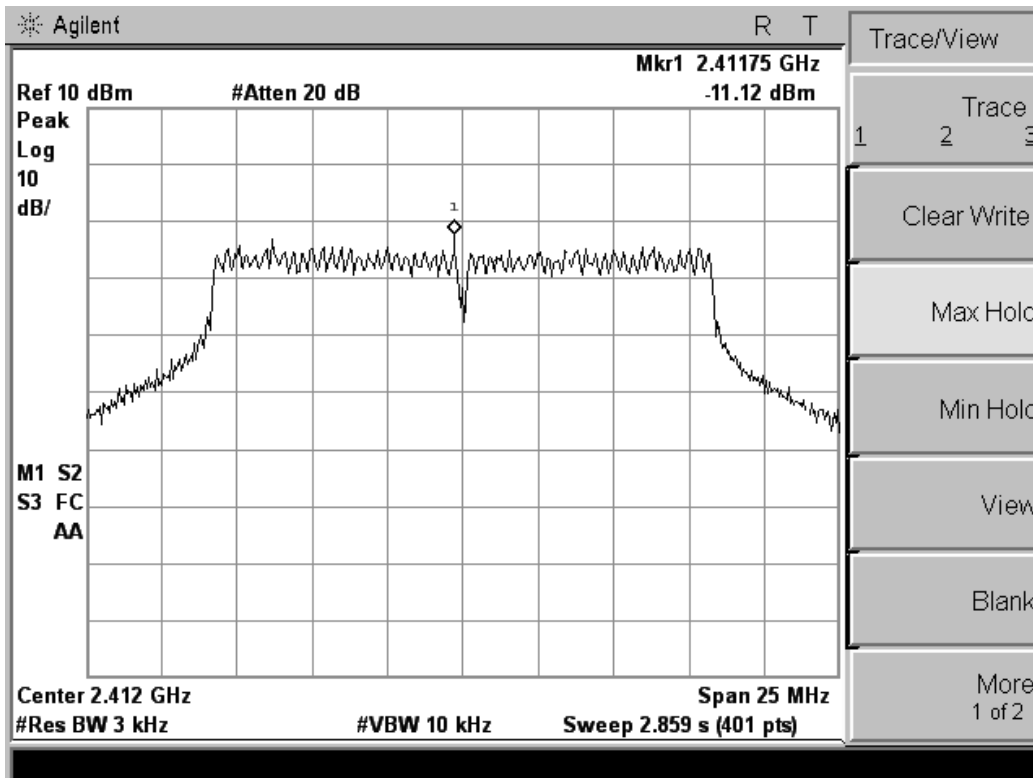

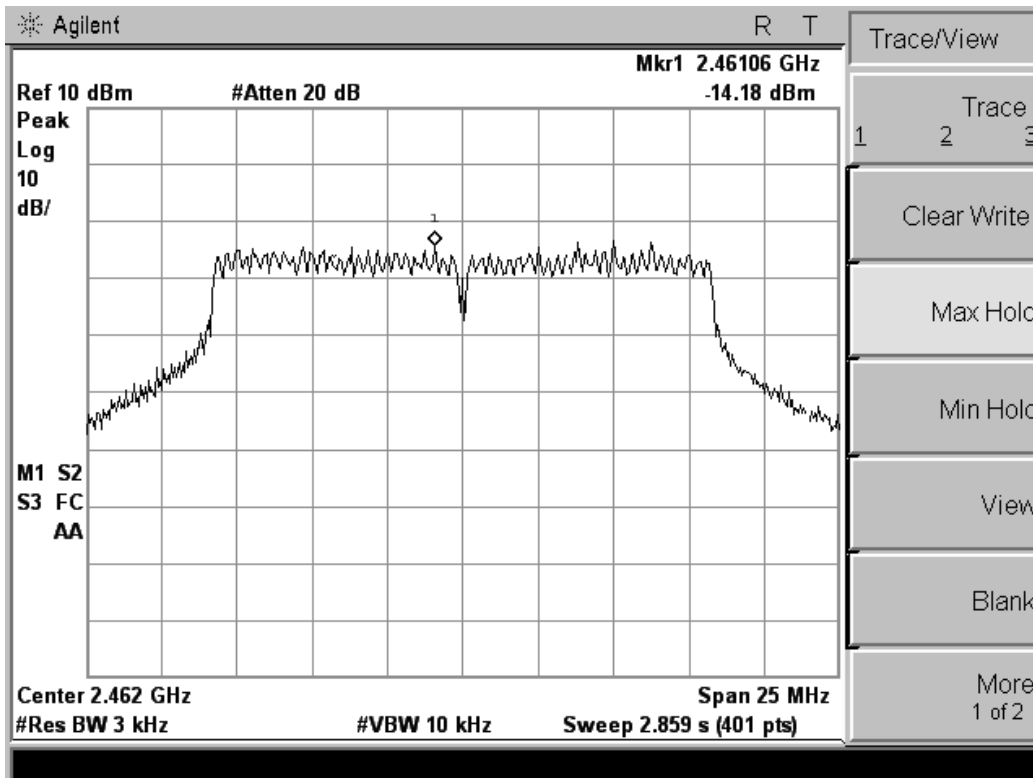
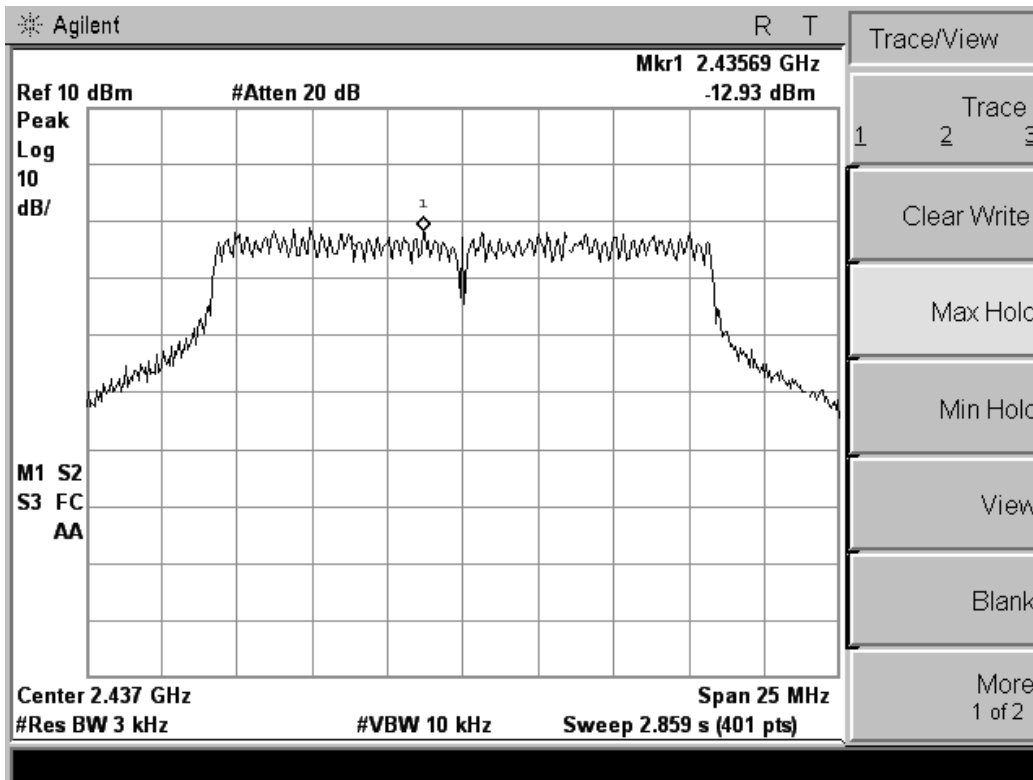

5.3. 6 dB Spectrum Bandwidth Measurement

5.3.1. Standard Applicable

According to §15.247(a)(2): For digital modulation systems, the minimum 6 dB bandwidth shall be at least 500 kHz.

5.3.2. Measuring Instruments and Setting

Please refer to section 6 of equipments list in this report. The following table is the setting of the Spectrum Analyzer.

Spectrum Parameter	Setting
Attenuation	Auto
Span Frequency	> RBW
Detector	Peak
Trace	Max Hold
Sweep Time	100ms

5.3.3. Test Procedures

1. The transmitter output (antenna port) was connected to the spectrum analyser in peak hold mode.
2. The resolution bandwidth and the video bandwidth were set according to KDB558074.
3. Measured the spectrum width with power higher than 6dB below carrier.

5.3.4. Test Setup Layout

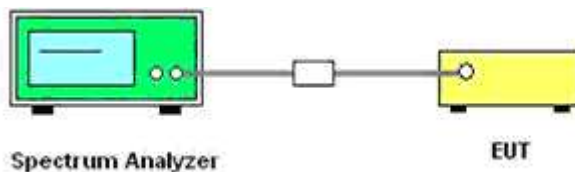

5.3.5. EUT Operation during Test

The EUT was programmed to be in continuously transmitting mode.

5.3.6. Test Result of 6dB Spectrum Bandwidth

Temperature	25°C	Humidity	60%
Test Engineer	Tree	Configurations	802.11b/g

802.11b

Channel	Frequency	6dB Bandwidth (MHz)	Min. Limit (kHz)	Result
1	2412	12.532	500	Complies
6	2437	12.520	500	Complies
11	2462	11.197	500	Complies

802.11g

Channel	Frequency	6dB Bandwidth (MHz)	Min. Limit (kHz)	Result
1	2412	16.369	500	Complies
6	2437	16.440	500	Complies
11	2462	16.398	500	Complies

802.11b channel, 6dB bandwidth

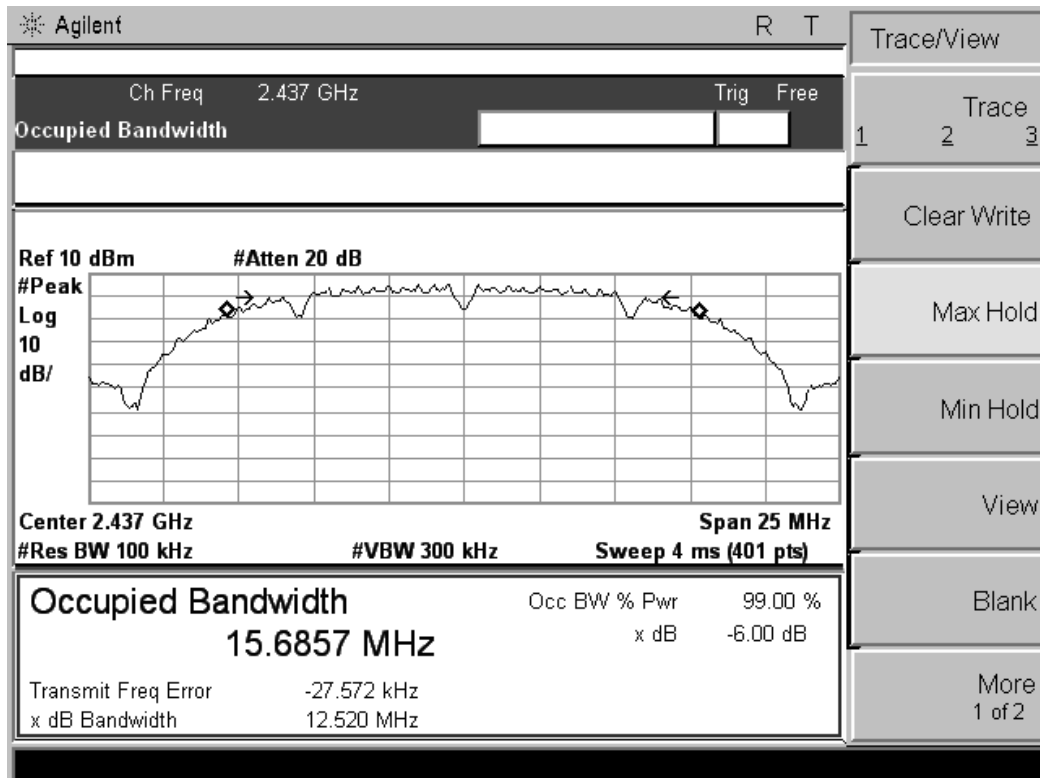
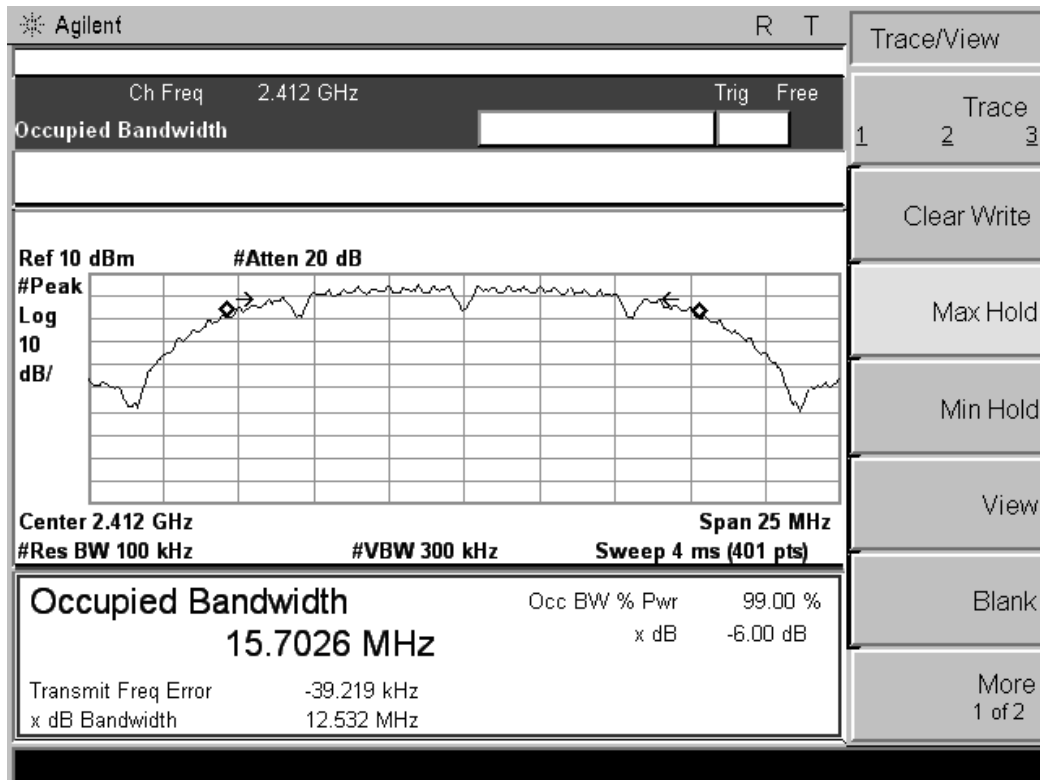

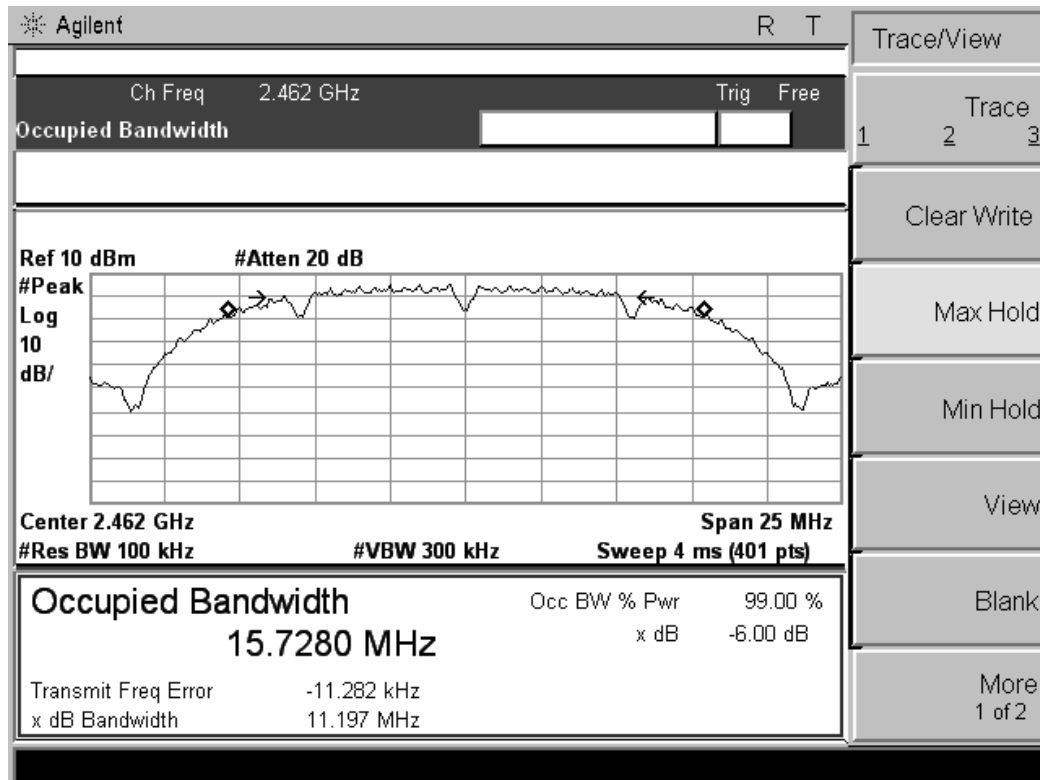

802.11g channel, 6dB bandwidth

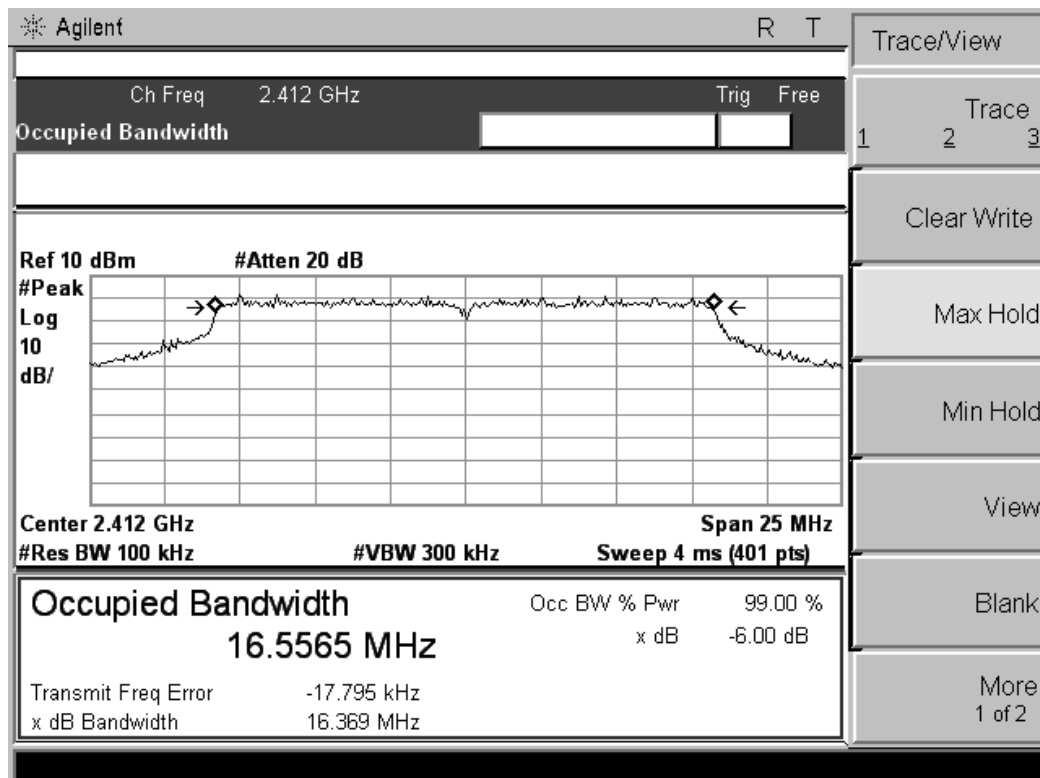

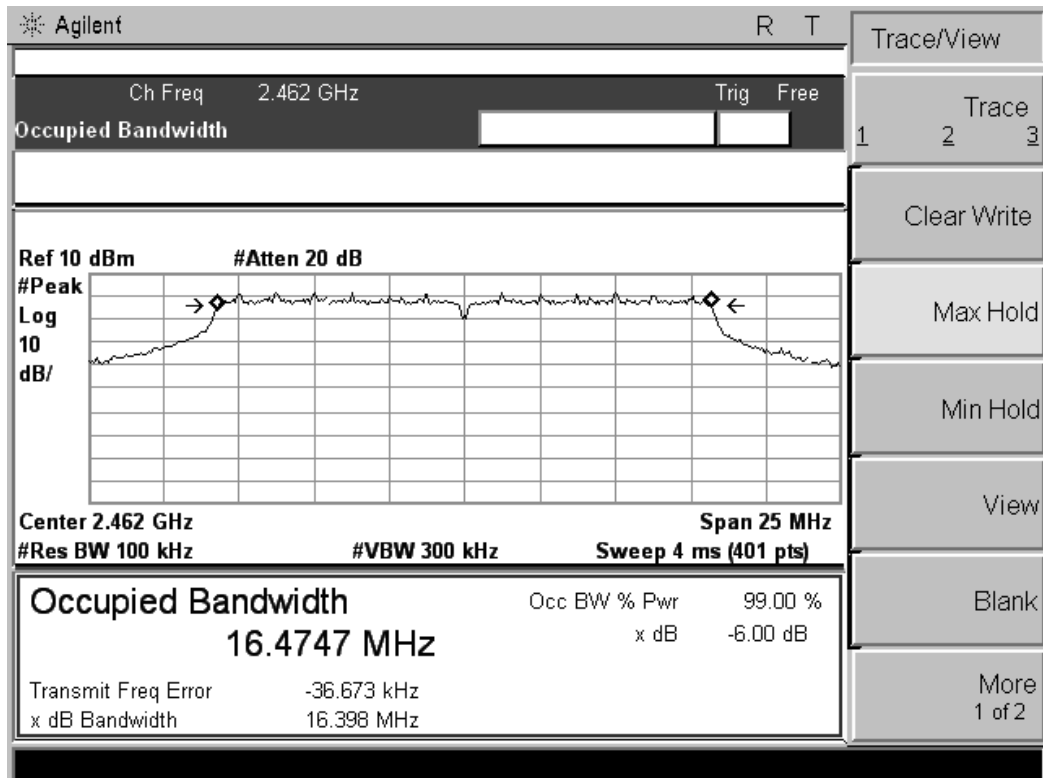
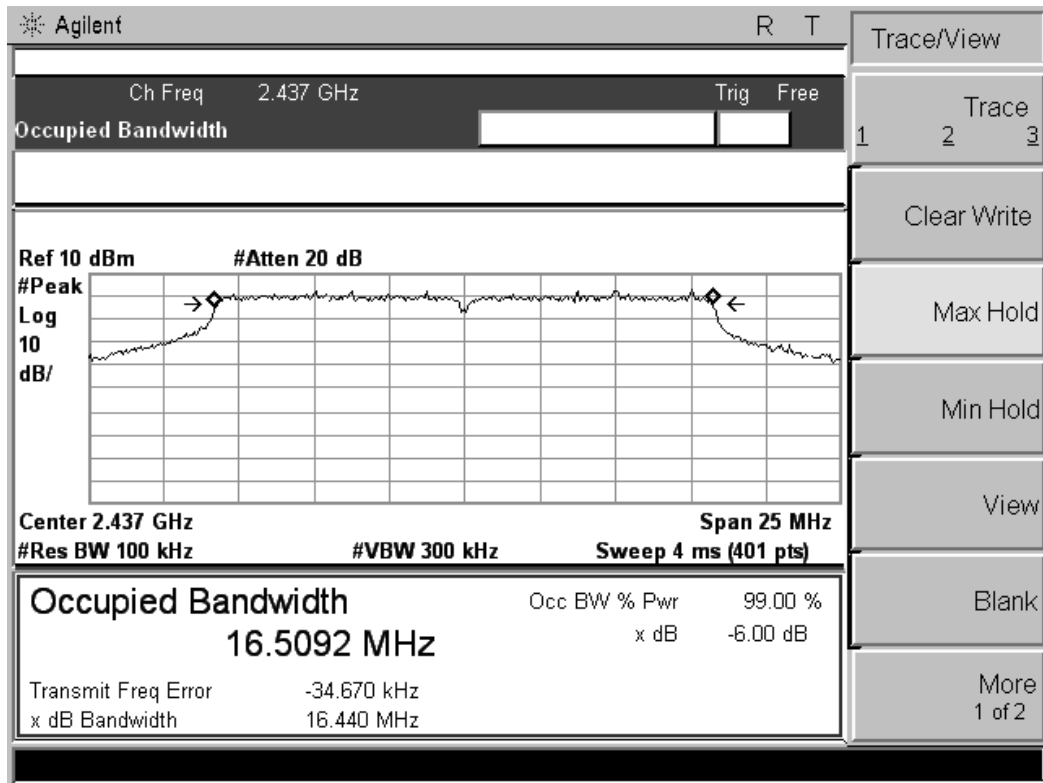

5.4. Occupied Bandwidth

5.4.1. Standard Applicable

According to §15.247(a): Operation under the provisions of this section is limited to frequency hopping and digitally modulated intentional radiators that comply with the following provisions:

For systems using digital modulation techniques, the EUT may operate in the 902-928 MHz, 2400-2483.5 MHz and 5725-5850 MHz bands. The minimum 6dB bandwidth shall be at least 500 kHz.

5.4.2. Measuring Instruments and Setting

Please refer to section 6 of equipments list in this report. The following table is the setting of the Spectrum Analyzer.

Spectrum Parameter	Setting
Attenuation	Auto
Span Frequency	> RBW
RBW	1% to 3% of the band
VBW	3 times the RBW
Detector	Peak
Trace	Max Hold
Sweep Time	100ms

5

5.4.3. Test Procedures

The transmitter output is connected to the spectrum analyzer. The RBW is set to 1% to 3% of the bandwidth. The VBW is set to 3 times the RBW. The sweep time is coupled. The spectrum analyzer internal bandwidth measurement function is utilized.

5.4.4. Test Setup Layout

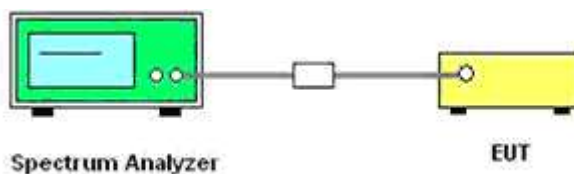

5.4.5. EUT Operation during Test

The EUT was programmed to be in continuously transmitting mode.

5.4.6. Test Result of 99% Occupied Bandwidth.

Temperature	25°C	Humidity	60%
Test Engineer	Tree	Configurations	802.11b/g

802.11b

Channel	Frequency (MHz)	99% OBW (MHz)
1	2412	15.682
6	2437	15.681
11	2462	15.726

802.11g

Channel	Frequency (MHz)	99% OBW (MHz)
1	2412	16.551
6	2437	16.516
11	2462	16.477

802.11b channel, 99% Occupied Bandwidth

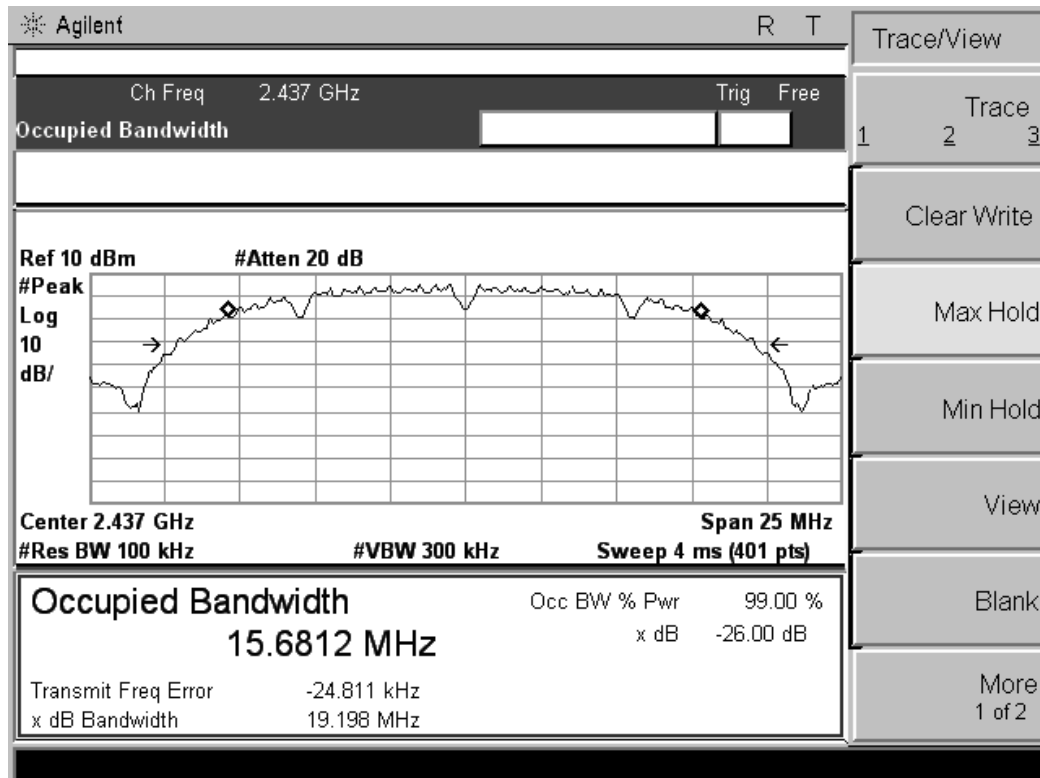
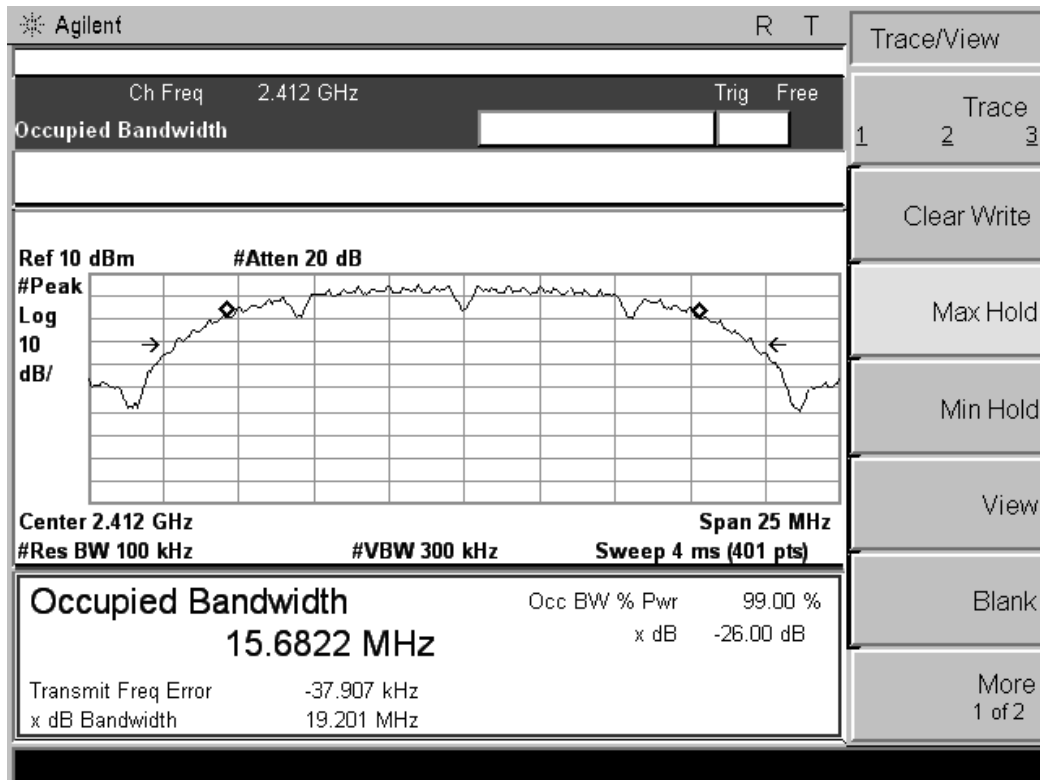

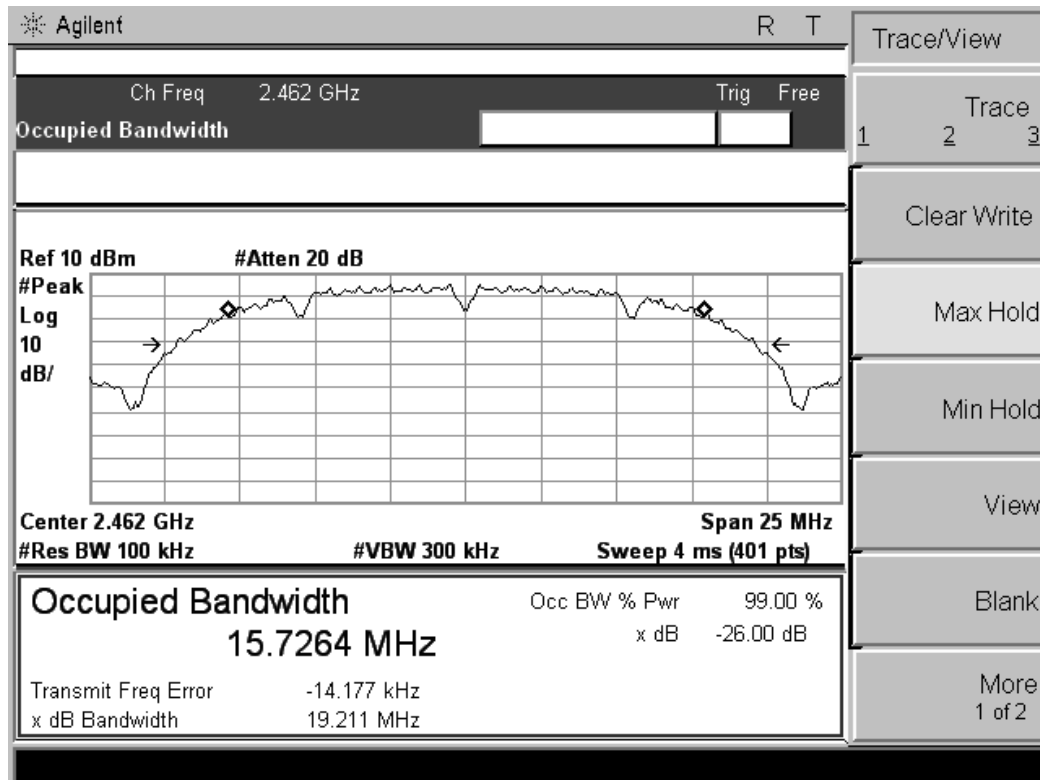

802.11g channel, 99% Occupied Bandwidth

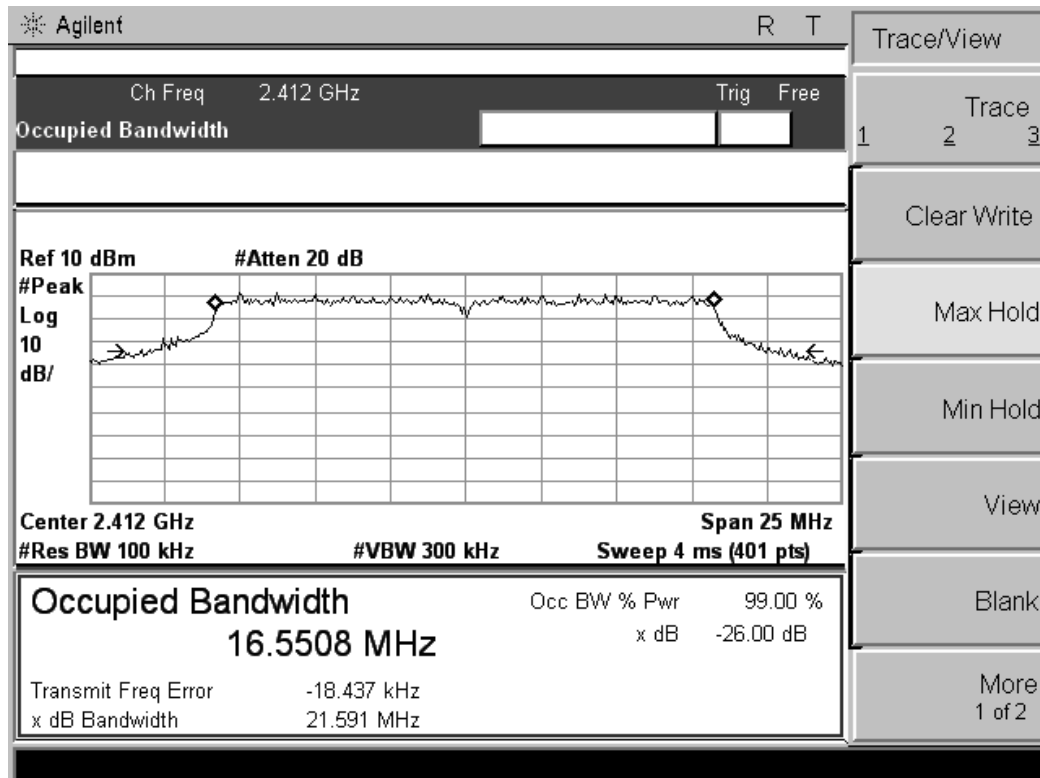

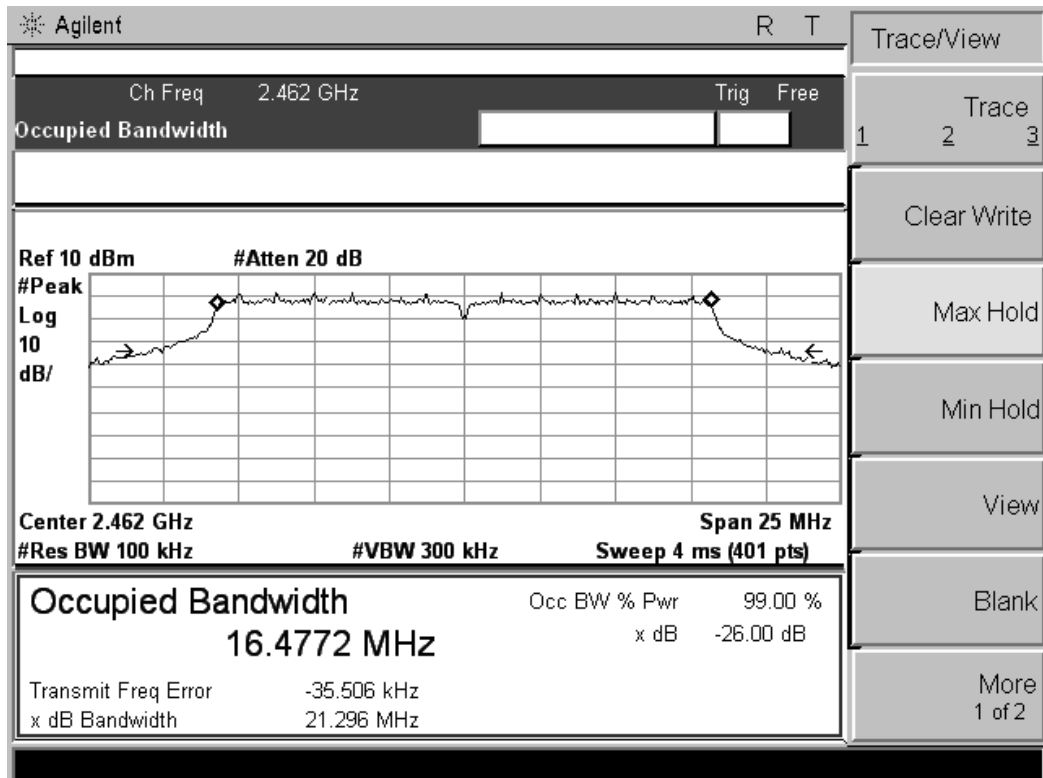
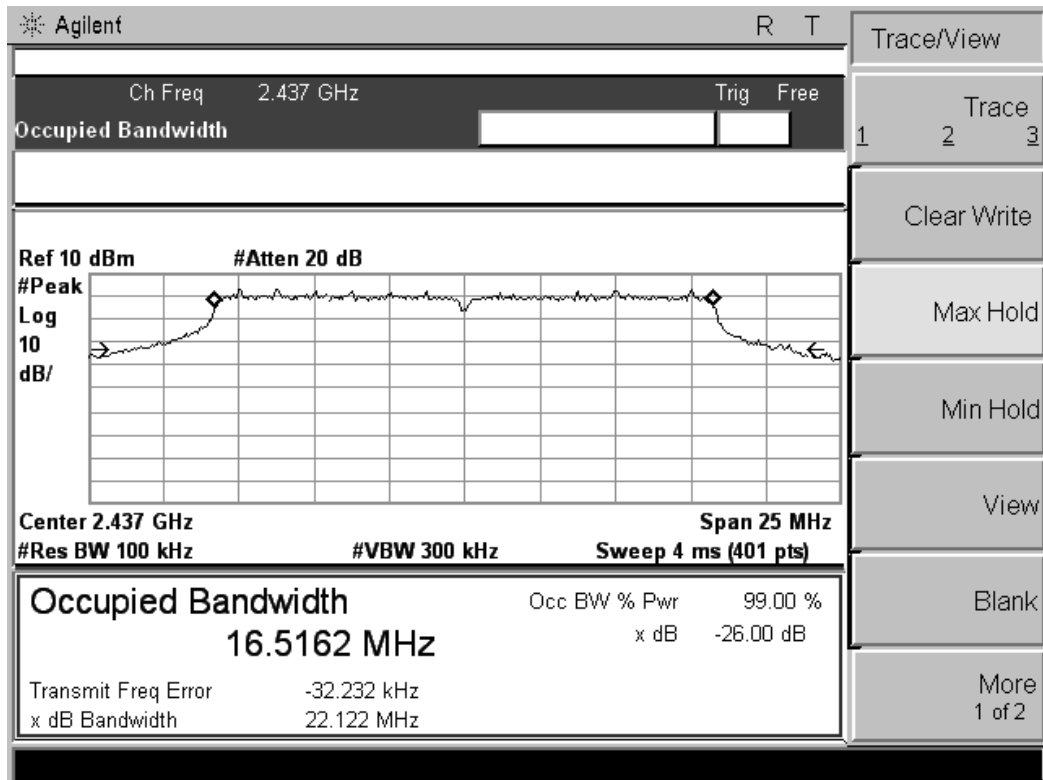

5.5. Radiated Emissions Measurement

5.5.1. Standard Applicable

According to §15.247 (d): 20dBc in any 100 kHz bandwidth outside the operating frequency band. In case the emission fall within the restricted band specified on 15.205(a), then the 15.209(a) limit in the table below has to be followed.

Frequencies(MHz)	Field Strength(microvolts/meter)	Measurement Distance(meters)
0.009~0.490	2400/F(KHz)	300
0.490~1.705	24000/F(KHz)	30
1.705~30.0	30	30
30~88	100	3
88~216	150	3
216~960	200	3
Above 960	500	3

5.5.2. Measuring Instruments and Setting

Please refer to section 6 of equipments list in this report. The following table is the setting of spectrum analyzer and receiver.

Spectrum Parameter	Setting
Attenuation	Auto
Start Frequency	1000 MHz
Stop Frequency	10th carrier harmonic
RB / VB (Emission in restricted band)	1MHz / 1MHz for Peak, 1 MHz / 10Hz for Average
RB / VB (Emission in non-restricted band)	1MHz / 1MHz for Peak, 1 MHz / 10Hz for Average

Receiver Parameter	Setting
Attenuation	Auto
Start ~ Stop Frequency	9kHz~150kHz / RB 200Hz for QP
Start ~ Stop Frequency	150kHz~30MHz / RB 9kHz for QP
Start ~ Stop Frequency	30MHz~1000MHz / RB 100kHz for QP

5.5.3. Test Procedures

1. Configure the EUT according to ANSI C63.4. The EUT was placed on the top of the turntable 0.8 meter above ground. The phase center of the receiving antenna mounted on the top of a height-variable antenna tower was placed 3 meters far away from the turntable.
2. Power on the EUT and all the supporting units. The turntable was rotated by 360 degrees to determine the position of the highest radiation.
3. The height of the broadband receiving antenna was varied between one meter and four meters above ground to find the maximum emissions field strength of both horizontal and vertical polarization.

4. For each suspected emissions, the antenna tower was scan (from 1 m to 4 m) and then the turntable was rotated (from 0 degree to 360 degrees) to find the maximum reading
5. Set the test-receiver system to Peak or CISPR quasi-peak Detect Function with specified bandwidth under Maximum Hold Mode.
6. For emissions above 1GHz, use 1MHz VBW and RBW for peak reading. Then 1MHz RBW and 10Hz VBW for average reading in spectrum analyzer.
7. When the radiated emissions limits are expressed in terms of the average value of the emissions, and pulsed operation is employed, the measurement field strength shall be determined by averaging over one complete pulse train, including blanking intervals, as long as the pulse train does not exceed 0.1 seconds. As an alternative (provided the transmitter operates for longer than 0.1 seconds) or in cases where the pulse train exceeds 0.1 seconds, the measured field strength shall be determined from the average absolute voltage during a 0.1 second interval during which the field strength is at its maximum value.
8. If the emissions level of the EUT in peak mode was 3 dB lower than the average limit specified, then testing will be stopped and peak values of EUT will be reported, otherwise, the emissions which do not have 3 dB margin will be repeated one by one using the quasi-peak method for below 1GHz.
9. For testing above 1GHz, the emissions level of the EUT in peak mode was lower than average limit (that means the emissions level in peak mode also complies with the limit in average mode), then testing will be stopped and peak values of EUT will be reported, otherwise, the emissions will be measured in average mode again and reported.
10. In case the emission is lower than 30MHz, loop antenna has to be used for measurement and the recorded data should be QP measured by receiver. High – Low scan is not required in this case.

5.5.4. Test Setup Layout

For radiated emissions below 30MHz

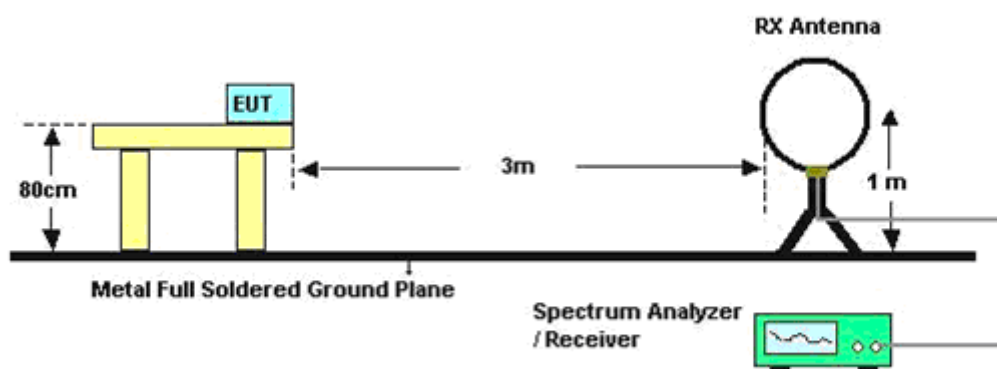

For radiated emissions above 30MHz

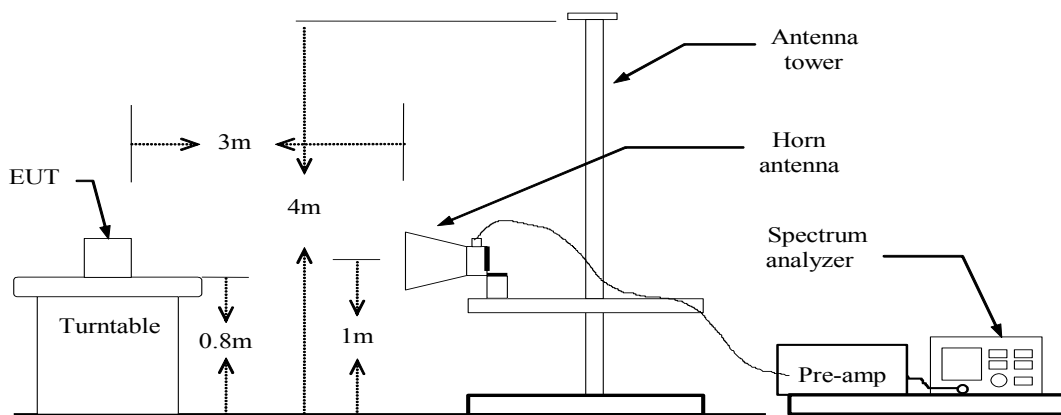
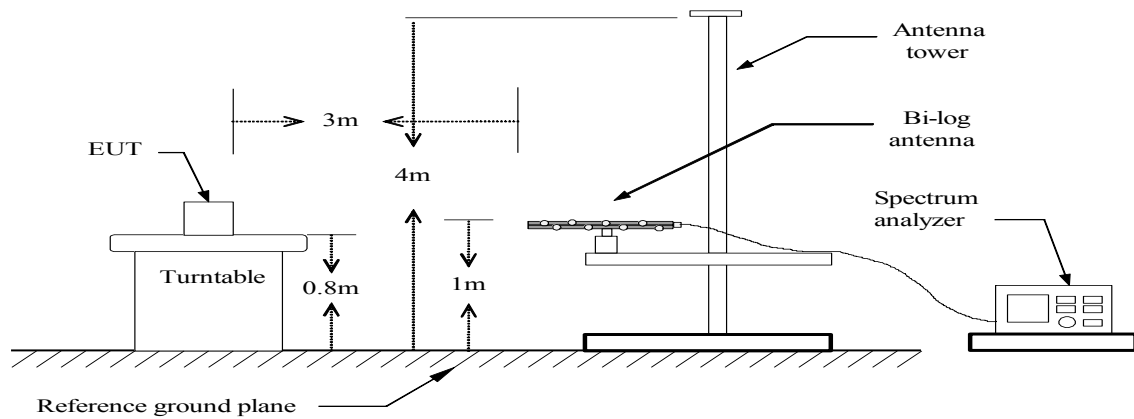

Above 10 GHz shall be extrapolated to the specified distance using an extrapolation factor of 20 dB/decade from 3m to 1.5m.

Distance extrapolation factor = $20 \log (\text{specific distance [3m]} / \text{test distance [1.5m]})$ (dB);

Limit line = specific limits (dBuV) + distance extrapolation factor [6 dB].

5.5.5. EUT Operation during Test

The EUT was programmed to be in continuously transmitting mode.

5.5.6. Results of Radiated Emissions (9kHz~30MHz)

Temperature	25°C	Humidity	60%
Test Engineer	Tree	Configurations	802.11b/g

Freq. (MHz)	Level (dBuV)	Over Limit (dB)	Over Limit (dBuV)	Remark
-	-	-	-	See Note

Note:

The amplitude of spurious emissions which are attenuated by more than 20 dB below the permissible value has no need to be reported.

Distance extrapolation factor = 40 log (specific distance / test distance) (dB);

Limit line = specific limits (dBuV) + distance extrapolation factor.

5.5.7. Results of Radiated Emissions (30MHz~1GHz)

Temperature	25°C	Humidity	60%
Test Engineer	Tree	Configurations	802.11b (Low CH)

Test result for 802.11b (Low Channel)

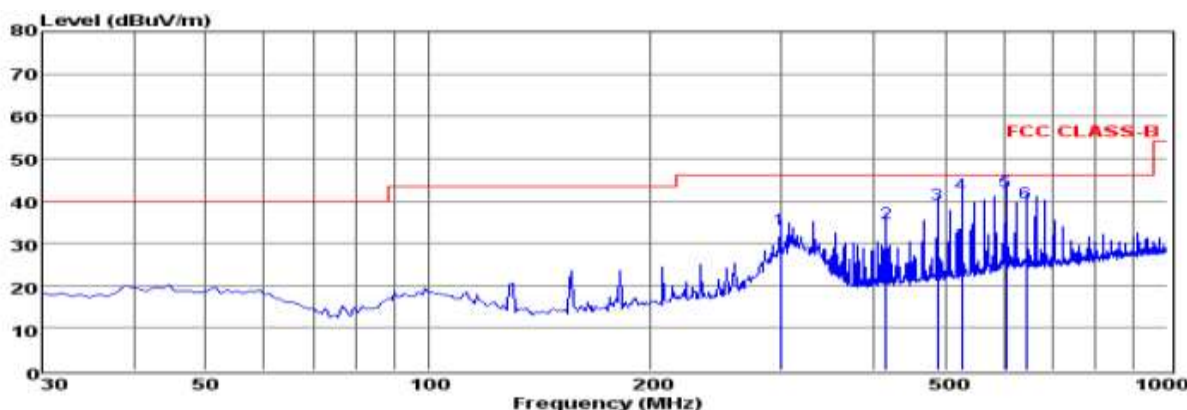

```

Env./Ins:          24°C/56%
EUT:              Portable (Barcode) Data Collector
M/N:              NLS-MT70
Power Rating:     AC 120V/60Hz
Test Mode:        TX-2412 (802.11b)
Operator:         Tree
Memo:
pol:              HORIZONTAL
    
```

	Freq MHz	Reading dBuV	CabLos dB	Antfac dB/m	Measured dBuV/m	Limit dBuV/m	Over dB	Remark
1	299.66	19.12	1.13	13.05	33.30	46.00	-12.70	QP
2	416.06	18.26	1.17	15.39	34.82	46.00	-11.18	QP
3	487.84	21.54	1.37	16.27	39.18	46.00	-6.82	QP
4	526.64	23.00	1.45	17.08	41.53	46.00	-4.47	QP
5	604.24	22.33	1.55	18.47	42.35	46.00	-3.65	QP
6	644.01	19.29	1.74	18.61	39.64	46.00	-6.36	QP

Note: 1. All readings are Quasi-peak values.
 2. Measured= Reading + Antenna Factor + Cable Loss
 3. The emission that are 20db below the official limit are not reported

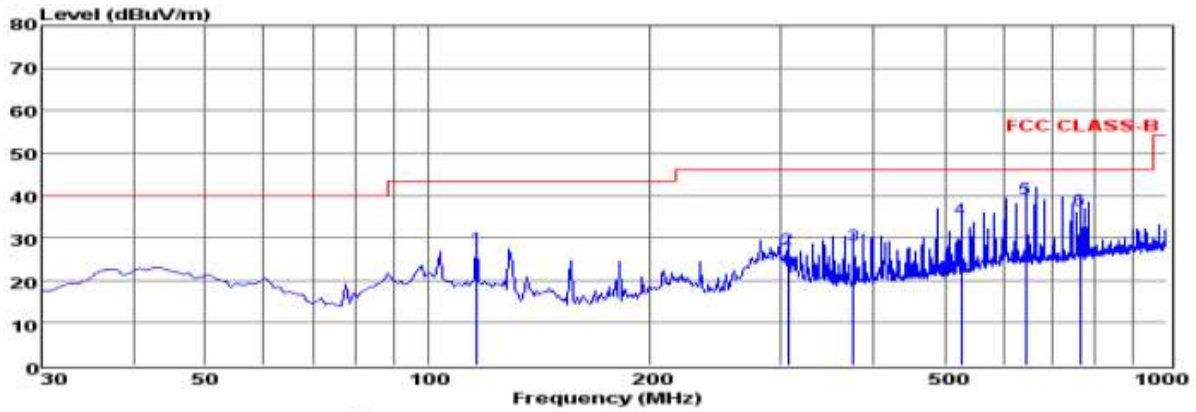

Env./Ins: 24°C/56%
 EUT: Portable (Barcode) Data Collector
 M/N: NLS-MT70
 Power Rating: AC 120V/60Hz
 Test Mode: TX-2412 (802.11b)
 Operator: Tree
 Memo:
 pol: VERTICAL

	Freq	Reading	CabLos	Antfac	Measured	Limit	Over	Remark
	MHz	dBuV	dB	dB/m	dBuV/m	dBuV/m	dB	
1	116.33	15.83	0.68	11.13	27.64	43.50	-15.86	QP
2	307.42	13.19	1.05	13.16	27.40	46.00	-18.60	QP
3	376.29	12.44	1.30	14.56	28.30	46.00	-17.70	QP
4	526.64	16.00	1.45	17.08	34.53	46.00	-11.47	QP
5	644.01	18.79	1.74	18.61	39.14	46.00	-6.86	QP
6	763.32	15.45	1.60	19.60	36.65	46.00	-9.35	QP

- Note: 1. All readings are Quasi-peak values.
 2. Measured= Reading + Antenna Factor + Cable Loss
 3. The emission that are 20db below the official limit are not reported

Note:

Pre-scan all mode and recorded the worst case results in this report (802.11b (Low Channel)).

Emission level (dBuV/m) = 20 log Emission level (uV/m).

Corrected Reading: Antenna Factor + Cable Loss + Read Level - Preamp Factor = Level.

5.5.8. Results for Radiated Emissions (Above 1GHz)

802.11b

Channel 1

Freq. MHz	Reading dBuv	Ant. Fac. dB/m	Pre. Fac. dB	Cab. Loss dB	Measured dBuv/m	Limit dBuv/m	Margin dB	Remark	Pol.
4824.11	53.41	33.06	35.04	3.94	55.37	74	-18.63	Peak	Horizontal
4824.13	44.54	33.06	35.04	3.94	46.50	54	-7.50	Average	Horizontal
4824.11	53.69	33.06	35.04	3.94	55.65	74	-18.35	Peak	Vertical
4824.13	44.71	33.06	35.04	3.94	46.67	54	-7.33	Average	Vertical

Channel 6

Freq. MHz	Reading dBuv	Ant. Fac. dB/m	Pre. Fac. dB	Cab. Loss dB	Measured dBuv/m	Limit dBuv/m	Margin dB	Remark	Pol.
4874.17	52.91	33.16	35.15	3.96	54.88	74	-19.12	Peak	Horizontal
4874.21	43.84	33.16	35.15	3.96	45.81	54	-8.19	Average	Horizontal
4874.17	53.11	33.16	35.15	3.96	55.08	74	-18.92	Peak	Vertical
4874.21	44.26	33.16	35.15	3.96	46.23	54	-7.77	Average	Vertical

Channel 11

Freq. MHz	Reading dBuv	Ant. Fac. dB/m	Pre. Fac. dB	Cab. Loss dB	Measured dBuv/m	Limit dBuv/m	Margin dB	Remark	Pol.
4924.19	50.78	33.26	35.14	3.98	52.88	74	-21.12	Peak	Horizontal
4924.21	42.91	33.26	35.14	3.98	45.01	54	-8.99	Average	Horizontal
4924.19	49.95	33.26	35.14	3.98	52.05	74	-21.95	Peak	Vertical
4924.21	43.31	33.26	35.14	3.98	45.41	54	-8.59	Average	Vertical

802.11g

Channel 1

Freq. MHz	Reading dBuV	Ant. Fac. dB/m	Pre. Fac. dB	Cab. Loss dB	Measured dBuV/m	Limit dBuV/m	Margin dB	Remark	Pol.
4824.51	49.61	33.06	35.04	3.94	51.57	74	-22.43	Peak	Horizontal
4824.54	39.78	33.06	35.04	3.94	41.74	54	-12.26	Average	Horizontal
4824.52	50.57	33.06	35.04	3.94	52.53	74	-21.47	Peak	Vertical
4824.54	39.94	33.06	35.04	3.94	41.90	54	-12.10	Average	Vertical

Channel 6

Freq. MHz	Reading dBuV	Ant. Fac. dB/m	Pre. Fac. dB	Cab. Loss dB	Measured dBuV/m	Limit dBuV/m	Margin dB	Remark	Pol.
4874.33	49.43	33.16	35.15	3.96	51.40	74	-22.60	Peak	Horizontal
4874.37	38.96	33.16	35.15	3.96	40.93	54	-13.07	Average	Horizontal
4874.34	49.87	33.16	35.15	3.96	51.84	74	-22.16	Peak	Vertical
4874.37	39.11	33.16	35.15	3.96	41.08	54	-12.92	Average	Vertical

Channel 11

Freq. MHz	Reading dBuV	Ant. Fac. dB/m	Pre. Fac. dB	Cab. Loss dB	Measured dBuV/m	Limit dBuV/m	Margin dB	Remark	Pol.
4924.46	48.87	33.26	35.14	3.98	50.97	74	-23.03	Peak	Horizontal
4924.49	38.66	33.26	35.14	3.98	40.76	54	-13.24	Average	Horizontal
4924.46	49.13	33.26	35.14	3.98	51.23	74	-22.77	Peak	Vertical
4924.50	39.25	33.26	35.14	3.98	41.35	54	-12.65	Average	Vertical

Notes:

1. Measuring frequencies from 9k~10th harmonic or 26.5GHz (which is less), No emission found between lowest internal used/generated frequency to 30MHz.
2. Radiated emissions measured in frequency range from 9k~10th harmonic or 40GHz (which is less) were made with an instrument using Peak detector mode.
3. Data of measurement within this frequency range shown " --- " in the table above means the reading of emissions are attenuated more than 20dB below the permissible limits or the field strength is too small to be measured.

5.5.9. Results of Band Edges Test (Radiated)

802.11b

Tx-2412

Freq. MHz	Reading dBuV	Ant. Fac. dB/m	Pre. Fac. dB	Cab. Loss dB	Measured dBuV/m	Limit dBuV/m	Margin dB	Remark	Pol.
2371.64	45.43	32.89	35.16	3.51	46.67	74	-27.33	Peak	Horizontal
2371.67	36.14	32.90	35.16	3.51	37.39	54	-16.61	Average	Horizontal
2400.00	47.69	32.92	35.16	3.54	48.99	74	-25.01	Peak	Horizontal
2399.99	37.51	32.92	35.16	3.54	38.81	54	-15.19	Average	Horizontal
2371.77	45.78	32.89	35.16	3.51	47.02	74	-26.98	Peak	Vertical
2371.81	36.57	32.90	35.16	3.51	37.82	54	-16.18	Average	Vertical
2400.00	47.83	32.92	35.16	3.54	49.13	74	-24.87	Peak	Vertical
2399.99	37.66	32.92	35.16	3.54	38.96	54	-15.04	Average	Vertical

Tx-2462

Freq. MHz	Reading dBuV	Ant. Fac. dB/m	Pre. Fac. dB	Cab. Loss dB	Measured dBuV/m	Limit dBuV/m	Margin dB	Remark	Pol.
2483.50	47.97	33.06	35.18	3.60	49.45	74	-24.55	Peak	Horizontal
2483.51	37.81	33.08	35.18	3.60	39.31	54	-14.69	Average	Horizontal
2487.96	44.65	33.08	35.18	3.62	46.17	74	-27.83	Peak	Horizontal
2488.01	35.32	33.08	35.18	3.62	36.84	54	-17.16	Average	Horizontal
2483.50	47.76	33.06	35.18	3.60	49.24	74	-24.76	Peak	Vertical
2483.51	38.03	33.08	35.18	3.60	39.53	54	-14.47	Average	Vertical
2488.09	44.21	33.08	35.18	3.62	45.73	74	-28.27	Peak	Vertical
2488.11	34.88	33.08	35.18	3.62	36.40	54	-17.60	Average	Vertical

802.11g

Tx-2412

Freq. MHz	Reading dBuV	Ant. Fac. dB/m	Pre. Fac. dB	Cab. Loss dB	Measured dBuV/m	Limit dBuV/m	Margin dB	Remark	Pol.
2375.14	44.56	32.89	35.16	3.51	45.80	74	-28.20	Peak	Horizontal
2375.17	35.73	32.90	35.16	3.51	36.98	54	-17.02	Average	Horizontal
2400.00	46.81	32.92	35.16	3.54	48.11	74	-25.89	Peak	Horizontal
2399.99	36.37	32.92	35.16	3.54	37.67	54	-16.33	Average	Horizontal
2374.97	44.77	32.89	35.16	3.51	46.01	74	-27.99	Peak	Vertical
2375.03	35.12	32.90	35.16	3.51	36.37	54	-17.63	Average	Vertical
2400.00	46.93	32.92	35.16	3.54	48.23	74	-25.77	Peak	Vertical
2399.99	36.59	32.92	35.16	3.54	37.89	54	-16.11	Average	Vertical

Tx-2462

Freq. MHz	Reading dBuV	Ant. Fac. dB/m	Pre. Fac. dB	Cab. Loss dB	Measured dBuV/m	Limit dBuV/m	Margin dB	Remark	Pol.
2483.50	46.31	33.06	35.18	3.60	47.79	74	-26.21	Peak	Horizontal
2483.51	37.54	33.08	35.18	3.60	39.04	54	-14.96	Average	Horizontal
2489.88	44.67	33.08	35.18	3.62	46.19	74	-27.81	Peak	Horizontal
2489.91	34.18	33.08	35.18	3.62	35.70	54	-18.30	Average	Horizontal
2483.50	46.57	33.06	35.18	3.60	48.05	74	-25.95	Peak	Vertical
2483.51	36.26	33.08	35.18	3.60	37.76	54	-16.24	Average	Vertical
2490.01	44.82	33.08	35.18	3.62	46.34	74	-27.66	Peak	Vertical
2490.06	35.16	33.08	35.18	3.62	36.68	54	-17.32	Average	Vertical

5.6. Conducted Spurious Emissions and Band Edges Test

5.6.1. Standard Applicable

According to §15.247 (d): In any 100 kHz bandwidth outside the frequency band in which the spread spectrum or digitally modulated intentional radiator is operating, the radio frequency power that is produced by the intentional radiator shall be at least 20 dB below that in the 100 kHz bandwidth within the band that contains the highest level of the desired power, based on either an RF conducted or a radiated measurement. Attenuation below the general limits specified in Section 15.209(a) is not required. In addition, radiated emissions which fall in the restricted bands, as defined in Section 15.205(a), must also comply with the radiated emission limits specified in Section 15.209(a) (see Section 15.205(c)).

5.6.2. Measuring Instruments and Setting

Please refer to section 6 of equipments list in this report. The following table is the setting of the spectrum analyzer.

Spectrum Parameter	Setting
Detector	Peak
Attenuation	Auto
RB / VB (Emission in restricted band)	100KHz/300KHz
RB / VB (Emission in non-restricted band)	100KHz/300KHz

5.6.3. Test Procedures

The transmitter output is connected to a spectrum analyzer. The resolution bandwidth is set to 100 kHz. The video bandwidth is set to 100 kHz

The spectrum from 9kHz to 40GHz is investigated with the transmitter set to the lowest, middle, and highest channels.

Preliminary tests on individual chains, and on all chains with a combiner, were performed. The worst-case configuration was with a combiner, therefore final test were performed with all chains feeding a combiner.

5.6.4. Test Setup Layout

This test setup layout is the same as that shown in section 5.4.4.

5.6.5. EUT Operation during Test

The EUT was programmed to be in continuously transmitting mode.

5.6.6. Test Results of Conducted Spurious Emissions

802.11b

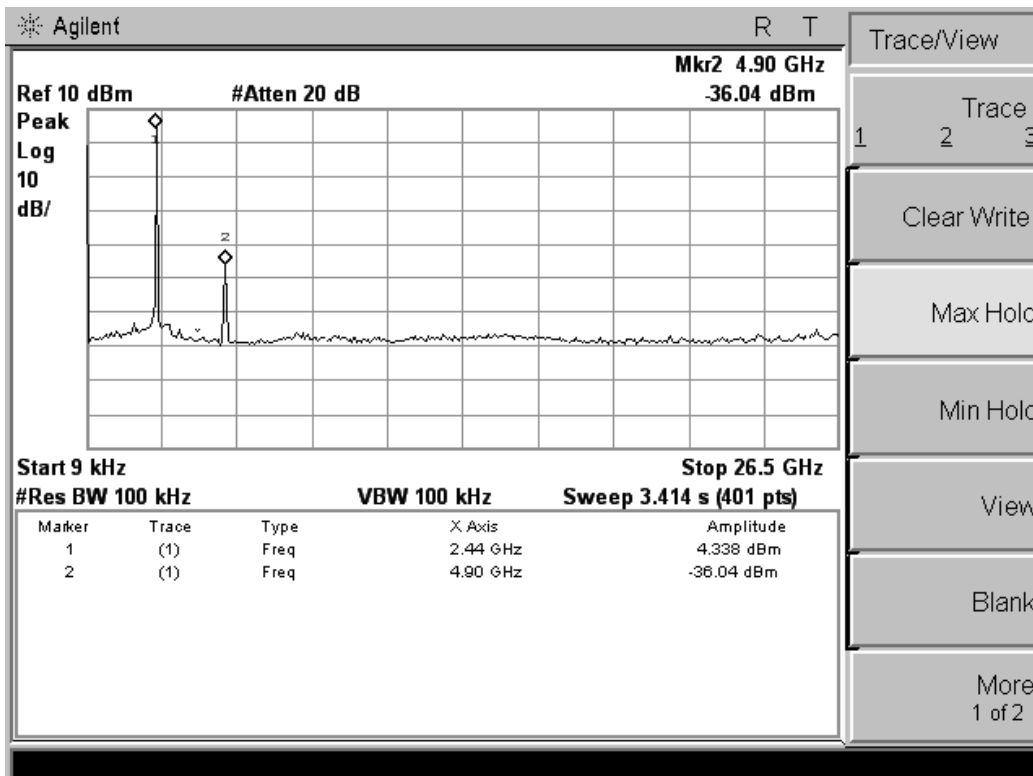
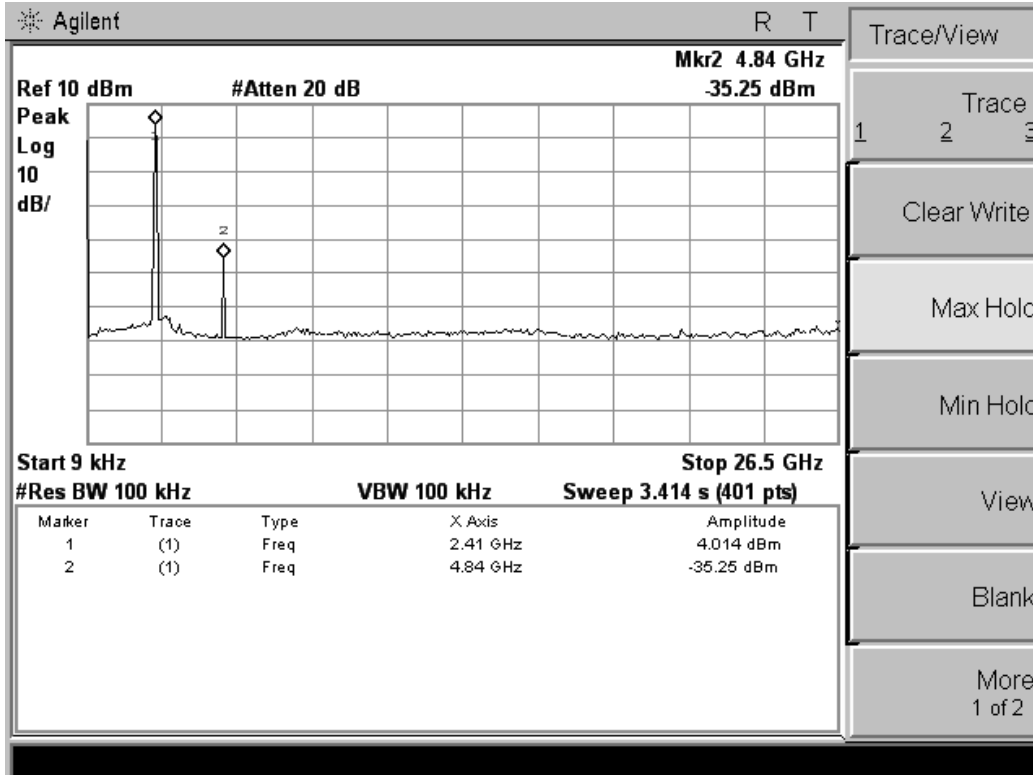

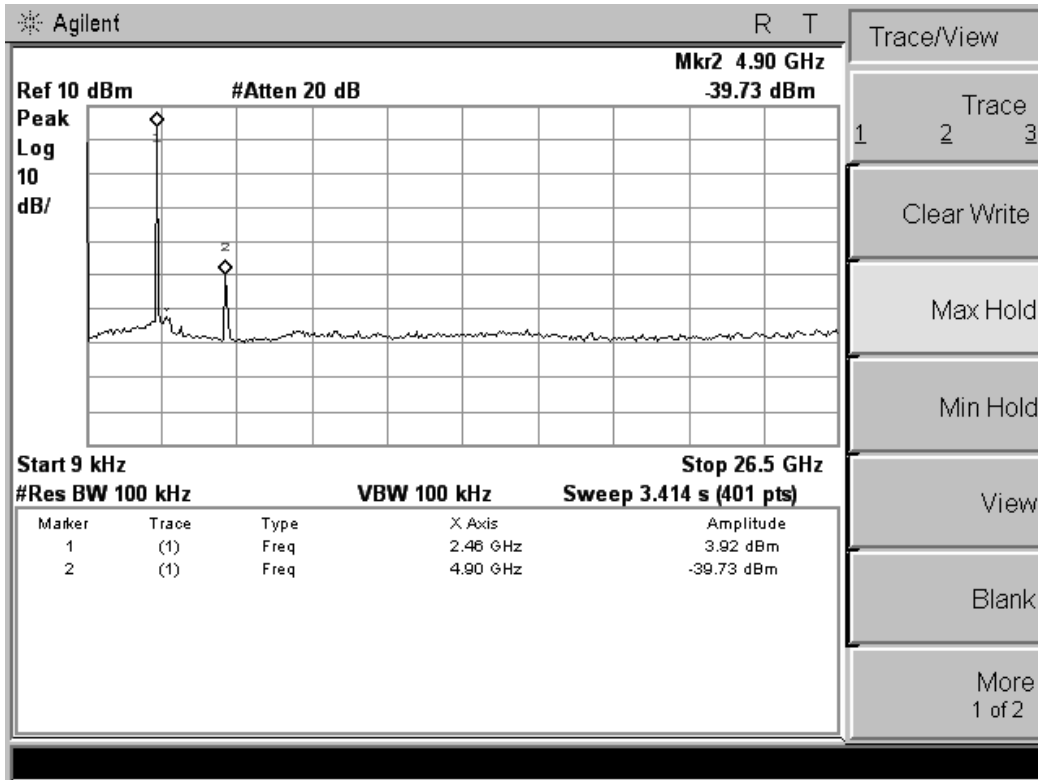

802.11g

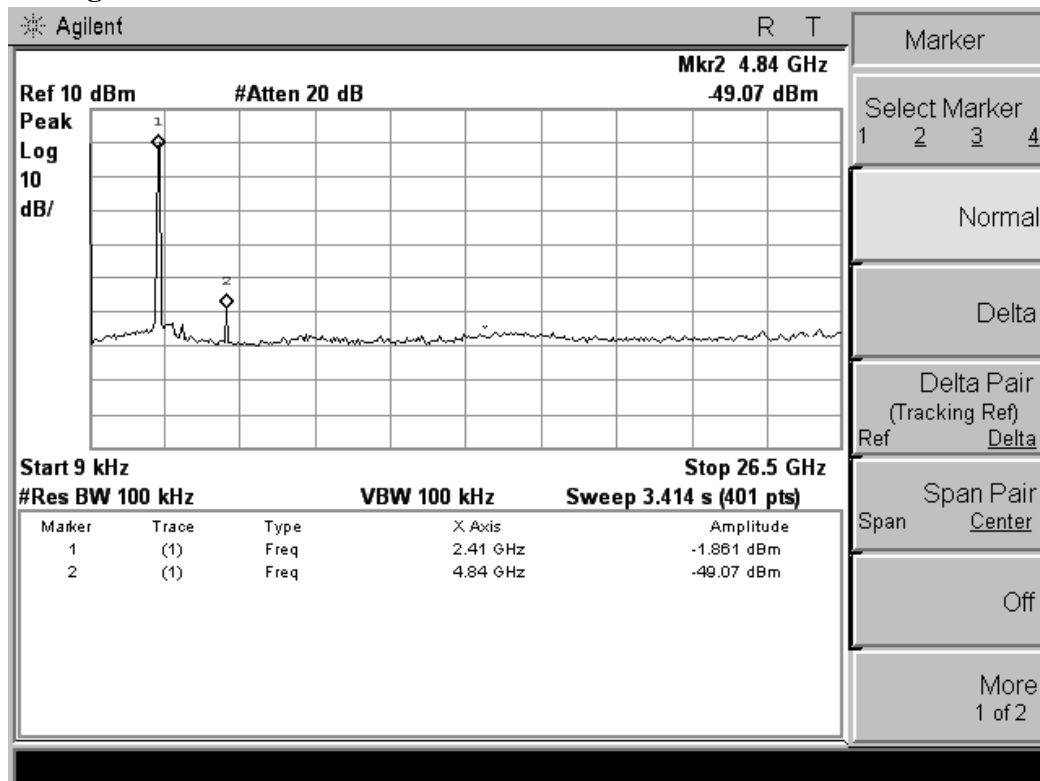

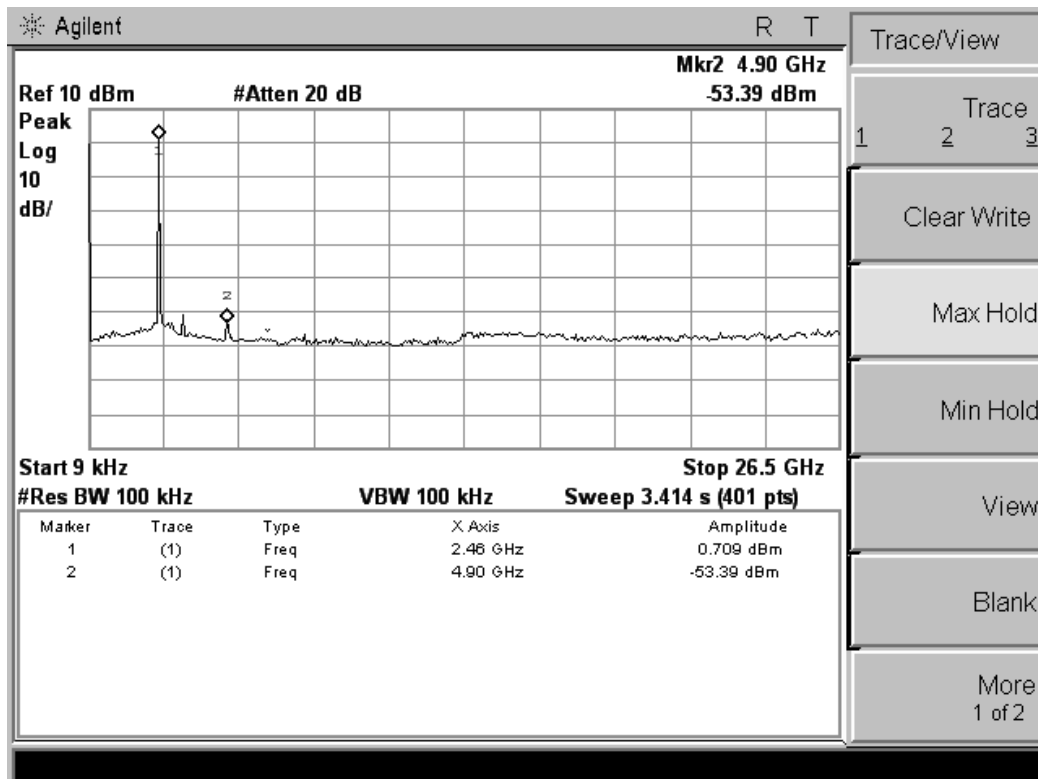
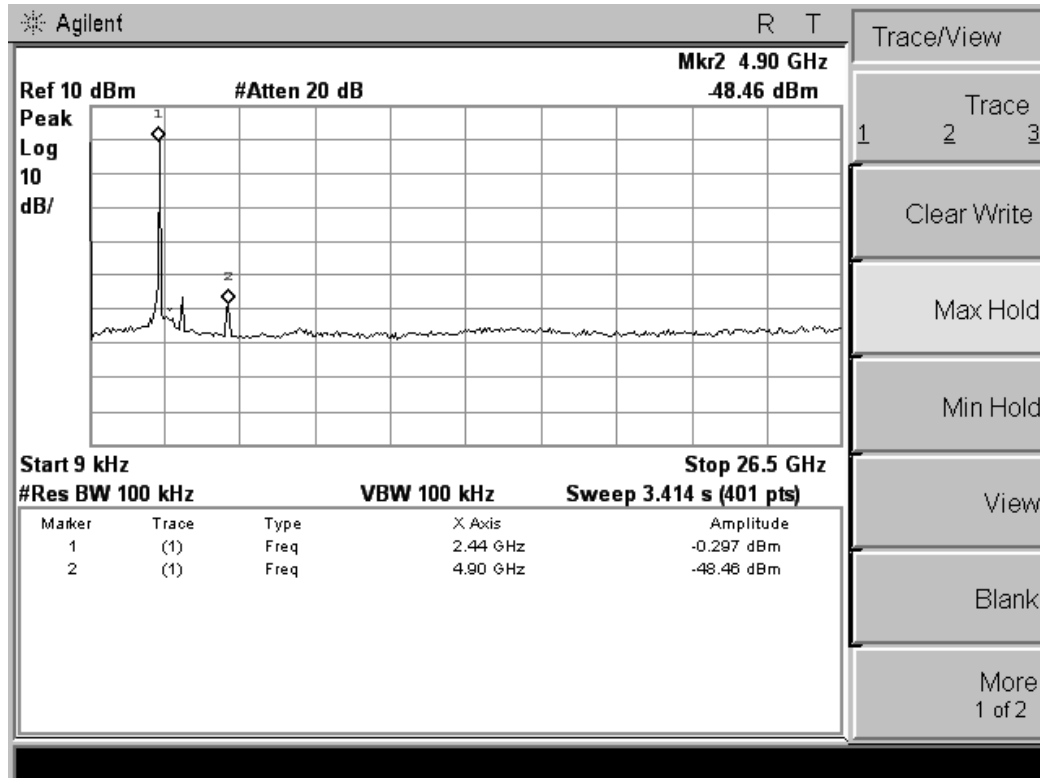

5.6.7. Test Results of Band Edges Test

802.11b

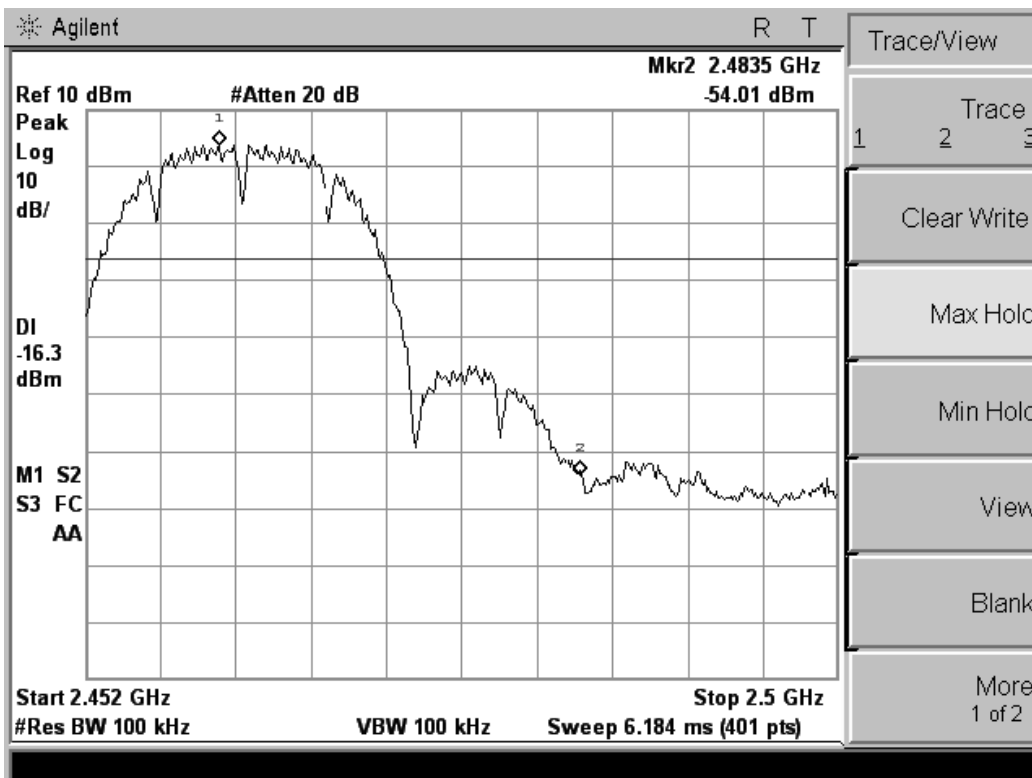
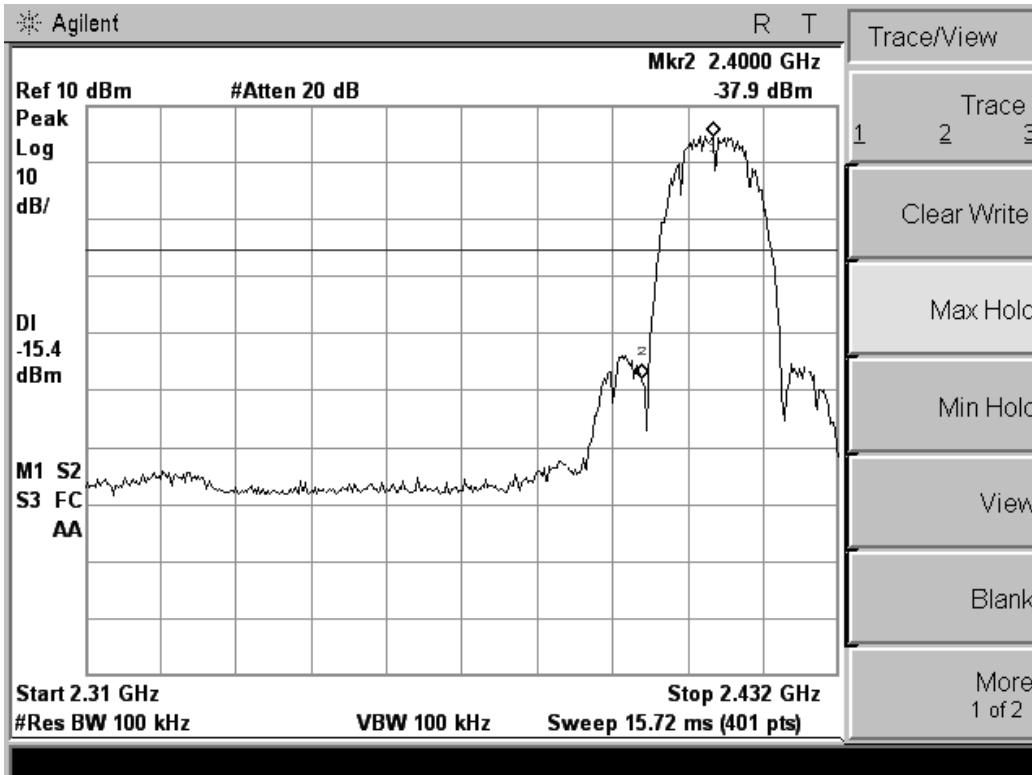

802.11g

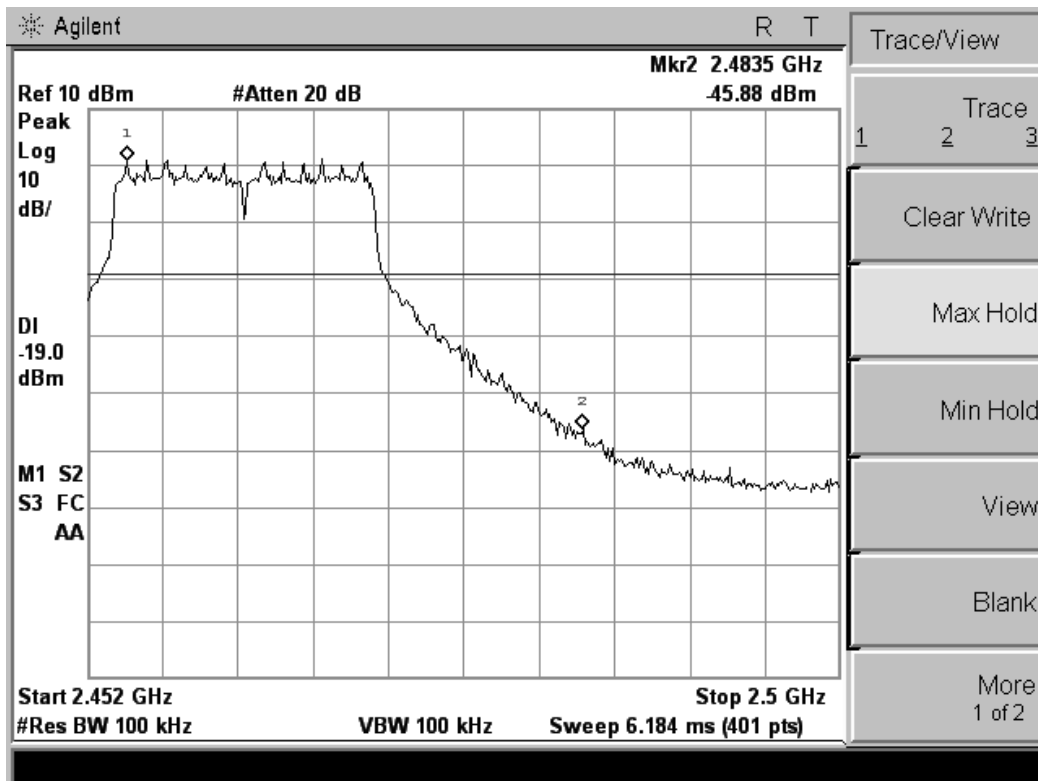
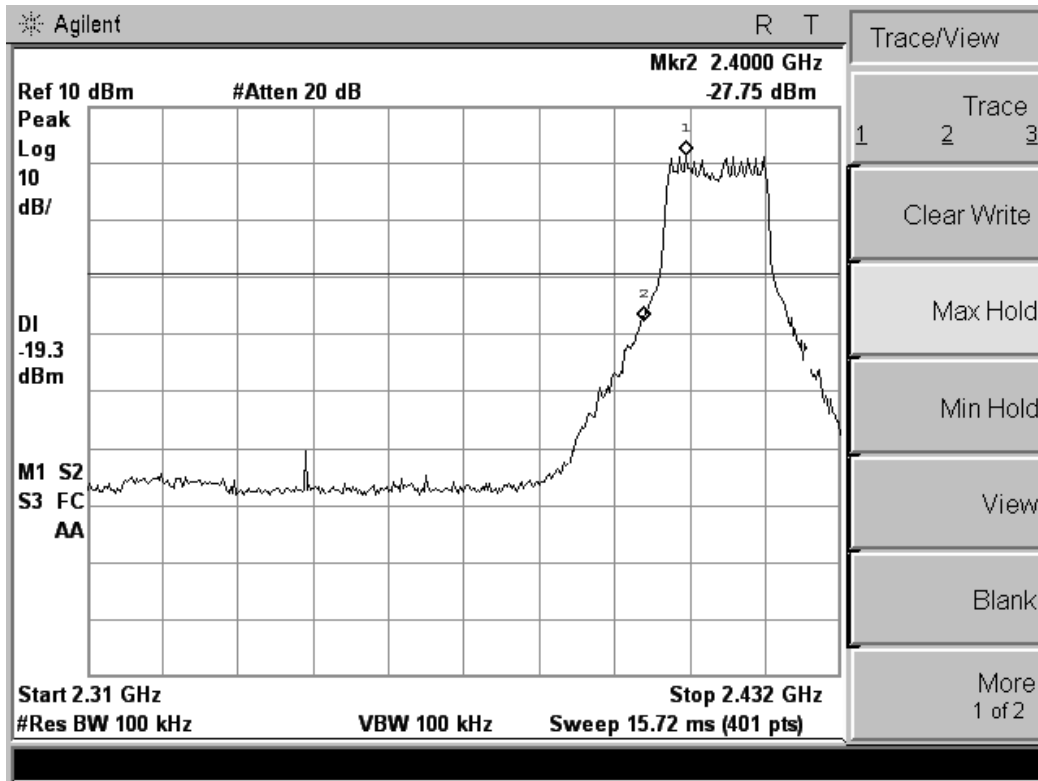

5.7. Power line conducted emissions

5.7.1 Standard Applicable

According to §15.207 (a): For an intentional radiator which is designed to be connected to the public utility (AC) power line, the radio frequency voltage that is conducted back onto the AC power line on any frequency or frequencies within the band 150 kHz to 30 MHz shall not exceed 250 microvolts (The limit decreases linearly with the logarithm of the frequency in the range 0.15 MHz to 0.50 MHz). The limits at specific frequency range is listed as follows:

Frequency Range (MHz)	Limits (dBµV)	
	Quasi-peak	Average
0.15 to 0.50	66 to 56	56 to 46
0.50 to 5	56	46
5 to 30	60	50

5.7.2 Block Diagram of Test Setup

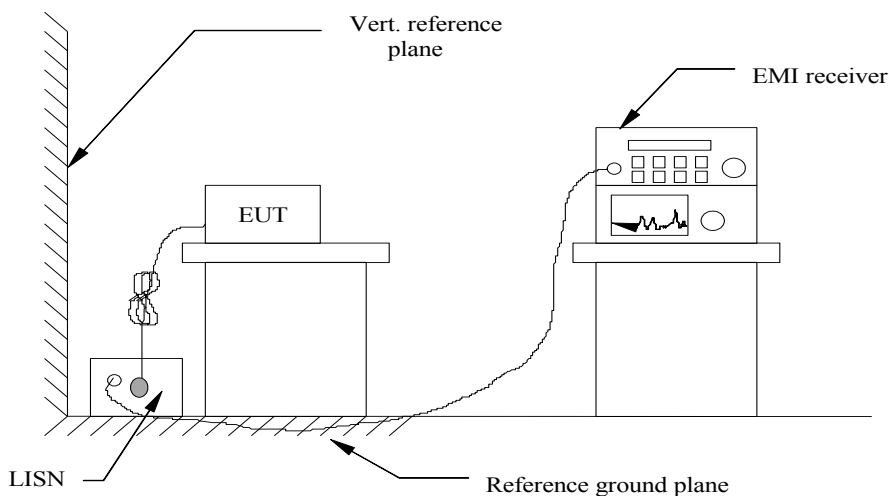

5.7.3 Test Results

PASS.

The test data please refer to following page.

Test result for 802.11b (Low Channel)

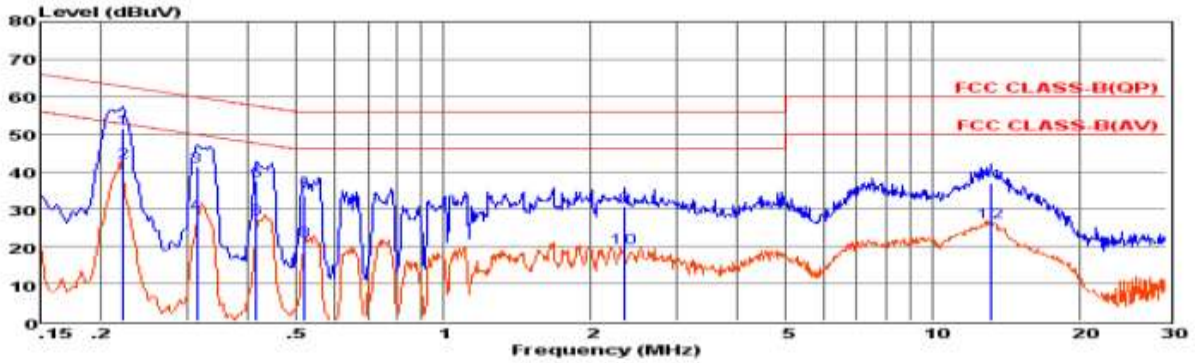

Env. Ins: 24*/56z
 EUT: Portable (Barcode) Data Collector
 M/N: NLS-MT70
 Power Rating: AC 120V/60Hz
 Test Mode: TX-2412(802.11b)
 Operator: Tree
 Memo:
 Pol: LINE

	Freq	Reading	LisnFac	CabLos	Measured	Limit	Over	Remark
	MHz	dBuV	dB	dB	dBuV	dBuV	dB	
1	0.22	41.60	9.63	0.03	51.34	62.74	-11.40	QP
2	0.22	32.88	9.63	0.03	42.54	52.74	-10.20	Average
3	0.31	31.76	9.63	0.03	41.42	59.88	-18.46	QP
4	0.31	19.05	9.63	0.03	28.71	49.88	-21.17	Average
5	0.41	27.86	9.62	0.04	37.52	57.55	-20.03	QP
6	0.41	17.68	9.62	0.04	27.34	47.55	-20.21	Average
7	0.52	24.03	9.62	0.04	33.69	56.00	-22.31	QP
8	0.52	11.85	9.62	0.04	21.51	46.00	-24.49	Average
9	2.35	21.03	9.64	0.05	30.72	56.00	-25.28	QP
10	2.35	9.86	9.64	0.05	19.55	46.00	-26.45	Average
11	13.13	27.16	9.70	0.09	36.95	60.00	-23.05	QP
12	13.13	16.73	9.70	0.09	26.52	50.00	-23.48	Average

Remarks: 1. Measured = Reading + Lisn Factor +Cable Loss.
 2. The emission levels that are 20dB below the official limit are not reported.

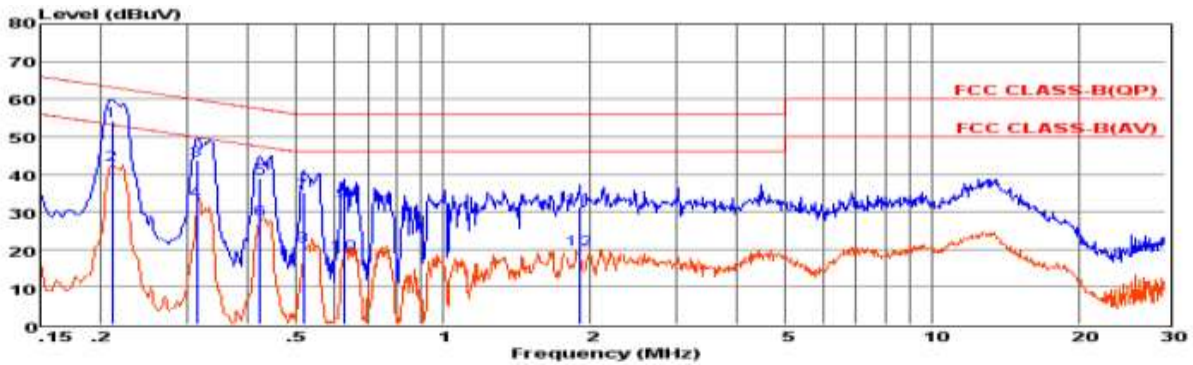

Env. Ins: 24*/56z
 EUT: Portable (Barcode) Data Collector
 M/N: NLS-MT70
 Power Rating: AC 120V/60Hz
 Test Mode: TX-2412(802.11b)
 Operator: Tree
 Memo:
 Pol: NEUTRAL

	Freq	Reading	LisnFac	CabLos	Measured	Limit	Over	Remark
	MHz	dBuV	dB	dB	dBuV	dBuV	dB	
1	0.21	44.41	9.59	0.03	54.03	63.18	-9.15	QP
2	0.21	33.05	9.59	0.03	42.67	53.18	-10.51	Average
3	0.31	34.15	9.60	0.03	43.78	59.88	-16.10	QP
4	0.31	23.49	9.60	0.03	33.12	49.88	-16.76	Average
5	0.42	29.20	9.61	0.04	38.85	57.42	-18.57	QP
6	0.42	18.37	9.61	0.04	28.02	47.42	-19.40	Average
7	0.52	25.43	9.62	0.04	35.09	56.00	-20.91	QP
8	0.52	11.19	9.62	0.04	20.85	46.00	-25.15	Average
9	0.63	23.02	9.63	0.04	32.69	56.00	-23.31	QP
10	0.63	9.07	9.63	0.04	18.74	46.00	-27.26	Average
11	1.91	21.52	9.63	0.05	31.20	56.00	-24.80	QP
12	1.91	10.22	9.63	0.05	19.90	46.00	-26.10	Average

Remarks: 1. Measured = Reading + Lisn Factor +Cable Loss.
 2. The emission levels that are 20dB below the official limit are not reported.

***Note: Pre-scan all mode and recorded the worst case results in this report (802.11b (Low Channel)).

5.8. Antenna Requirements

5.8.1. Standard Applicable

According to § 15.203 & RSS-Gen, an intentional radiator shall be designed to ensure that no antenna other than that furnished by the responsible party shall be used with the device.

5.8.2. Antenna Connector Construction

The integral antenna (which max. gain is 2.0dBi) is permanently attached and no consideration of replacement. Please see EUT photo for details.

5.8.3. Results: Compliance.

6. LIST OF MEASURING EQUIPMENTS

Instrument	Manufacturer	Model No.	Serial No.	Characteristics	Cal Date	Due Date
EMC Receiver	R&S	ESCS 30	100174	9kHz – 2.75GHz	June 18,2013	June 17,2014
Signal analyzer	Agilent	E4448A(External mixers to 40GHz)	US44300469	9kHz-40GHz	July 16,2013	July 15,2014
LISN	MESS Tec	NNB-2/16Z	99079	9KHz-30MHz	June 18,2013	June 17,2014
LISN (Support Unit)	EMCO	3819/2NM	9703-1839	9KHz-30MHz	June 18,2013	June 17,2014
RF Cable-CON	UTIFLEX	3102-26886-4	CB049	9KHz-30MHz	June 18,2013	June 17,2014
ISN	SCHAFFNER	ISN ST08	21653	9KHz-30MHz	June 18,2013	June 17,2014
3m Semi Anechoic Chamber	SIDT FRANKONIA	SAC-3M	03CH03-HY	30M-1GHz 3m	June 18,2013	June 17,2014
Amplifier	SCHAFFNER	COA9231A	18667	9kHz-2GHz	June 18,2013	June 17,2014
Amplifier	Agilent	8449B	3008A02120	1GHz-26.5GHz	July 16,2013	July 15,2014
Amplifier	MITEQ	AMF-6F-260400	9121372	26.5GHz-40GHz	July 16,2013	July 15,2014
Spectrum Analyzer	Agilent	E4407B	MY41440292	9k-26.5GHz	July 16,2013	July 15,2014
Loop Antenna	R&S	HFH2-Z2	860004/001	9k-30MHz	June 18,2013	June 17,2014
By-log Antenna	SCHWARZBECK	VULB9163	9163-470	30MHz-1GHz	June 10,2013	June 09,2014
Horn Antenna	EMCO	3115	6741	1GHz-18GHz	June 10,2013	June 09,2014
Horn Antenna	SCHWARZBECK	BBHA9170	BBHA9170154	15GHz-40GHz	June 10,2013	June 09,2014
RF Cable-R03m	Jye Bao	RG142	CB021	30MHz-1GHz	June 18,2013	June 17,2014
RF Cable-HIGH	SUHNER	SUCOFLEX 106	03CH03-HY	1GHz-40GHz	June 18,2013	June 17,2014
Spectrum Meter	R&S	FSP 30	100023	9kHz-30GHz	July 16,2013	July 15,2014
Power Meter	R&S	NRVS	100444	DC-40GHz	June 18,2013	June 17,2014
Power Sensor	R&S	NRV-Z51	100458	DC-30GHz	June 18,2013	June 17,2014
Power Sensor	R&S	NRV-Z32	10057	30MHz-6GHz	June 18,2013	June 17,2014
AC Power Source	HPC	HPA-500E	HPA-9100024	AC 0~300V	June 18,2013	June 17,2014
DC power Source	GW	GPC-6030D	C671845	DC 1V-60V	June 18,2013	June 17,2014
Temp. and Humidity	Giant Force	GTH-225-20-S	MAB0103-00	N/A	June 18,2013	June 17,2014
RF CABLE-1m	JYE Bao	RG142	CB034-1m	20MHz-7GHz	June 18,2013	June 17,2014
RF CABLE-2m	JYE Bao	RG142	CB)35-2m	20MHz-1GHz	June 18,2013	June 17,2014
Vector signal Generator	R&S	SMU200A	102098	100kHz~6GHz	June 18,2013	June 17,2014
Signal Generator	R&S	SMR40	10016	10MHz~40GHz	July 16,2013	July 15,2014
Universal Radio Communication	R&S	CMU200	112012	N/A	July 18,2013	July 17,2014

Note: All equipment through GRGT EST calibration

7. MANUFACTURER/ APPROVAL HOLDER DECLARATION

The following series model(s):

--	--	--	--
----	----	----	----

Belong to the tested device:

Product description : Portable (Barcode) Data Collector

Model name : NLS-MT70

Remark: No additional models were tested.

-----THE END OF REPORT-----