



EMI TEST REPORT

FCC ID : SL6-MOD001
Equipment : BEEKS BLE Module
Brand Name : HID
Model Name : MOD001
Applicant : HID Global Corporation
611 Center Ridge Drive Austin TX 78753
United States Of America
Manufacturer : HID Global Corporation
611 Center Ridge Drive Austin TX 78753
United States Of America
Standard : 47 CFR FCC Rules and Regulations Part 15
Subpart B, Class B Digital Device

The product was received on Jan. 25, 2021, and testing was started from Dec. 21, 2021 and completed on Jan. 06, 2022. We, SPORTON INTERNATIONAL INC. Hsinhua Laboratory, would like to declare that the tested sample has been evaluated in accordance with the procedures given in ANSI C63.4-2014 and shown compliance with the applicable technical standards.

The test results in this report apply exclusively to the tested model / sample. Without written approval of SPORTON INTERNATIONAL INC. Hsinhua Laboratory, the test report shall not be reproduced except in full.



Approved by: William Li

SPORTON INTERNATIONAL INC. Hsinhua Laboratory
No.52, Huaya 1st Rd., Guishan Dist., Taoyuan City 333411, Taiwan (R.O.C.)



Table of Contents

History of this test report	3
Summary of Test Result	4
1. General Description of Equipment under Test	5
1.1. Basic Description of Equipment under Test	5
1.2. Feature of Equipment under Test	5
1.3. Modification of EUT	5
2. Test Configuration of Equipment under Test	6
2.1. Details of EUT Test Modes.....	6
2.2. Description of Test System.....	6
2.3. Connection Diagram of Test System	7
2.4. Details of EUT Test Setup	9
3. General Information of Test	10
3.1. Test Facilities	10
3.2. Test Standards.....	10
3.3. Test Voltage/Frequencies	10
3.4. Test Distance and Frequency Range Investigated	10
3.5. Operating Condition	10
3.6. Labelling requirements	11
3.7. User Information.....	11
4. Conducted Emissions Measurement	12
4.1. Limit	12
4.2. Test Procedures.....	13
4.3. Measurement Results Calculation	13
4.4. Typical Test Setup Layout	14
4.5. Test Result.....	16
5. Radiated Emissions Measurement	18
5.1. Radiated Emission below 1GHz	18
5.2. Radiated Emission above 1GHz.....	25
6. Uncertainty of Test Site	31
6.1. Measurement Uncertainty	31
7. List of Measuring Equipment Used	32
Appendix A. Test Photos	
Photographs of EUT v01	



Summary of Test Result

REGULATIONS REQUIREMENTS TEST STANDARD: 47 CFR FCC Rules and Regulations Part 15 Subpart B				
Report Clause	Ref Std. Clause	Test Items	Result (PASS/FAIL)	Remark
4	15.107	Conducted Emissions of Powerline	PASS	Under limit 7.01 dB at 30.00 MHz
5.1	15.109	Radiated Emissions below 1GHz	PASS	Under limit 1.90 dB at 479.200 MHz
5.2	15.109	Radiated Emissions above 1GHz	PASS	Under limit 24.32 dB at 5.97 GHz

Declaration of Conformity:
<ol style="list-style-type: none">1. The Radiated Emission and Conducted Transient Disturbances test result (Pass/Fail) which exclude measurement uncertainty. Note that measurement values may risk exceeding the limit of regulation standard. If measurement uncertainty is included in test results.2. The Radiated Emission and Conducted Transient Disturbances measurement uncertainty please refer to report chapter 6.1 "Measurement Uncertainty".
Comments and explanations:
None

Reviewed by: Mark Ma

Report Producer: Debby Hung



1. General Description of Equipment under Test

1.1. Basic Description of Equipment under Test

Equipment : BEEKS BLE Module
Model No. : MOD001
Power Supply Type : From Host System
AC Power Cord : Non-Shielded, 1.8 m, 3 pin
The maximum operating frequency :2.4 GHz

1.2. Feature of Equipment under Test

For a more detailed features description, please refer to the manufacturer's specifications or the User's Manual.

1.3. Modification of EUT

No modifications to the EUT were made.



2. Test Configuration of Equipment under Test

2.1. Details of EUT Test Modes

Model No.: MOD001 was selected as the main test model and its data was recorded in this report. The equipment under test was performed the following test modes:

Test Items	Description of test modes
Conducted Emission	Mode 1. SYSTEM ON
Radiated Emissions <below 1GHz>	Mode 1. SYSTEM ON
Radiated Emissions <above 1GHz>	Mode 1. SYSTEM ON

2.2. Description of Test System

Conducted emission and radiated emission below 1GHz

No.	Peripheral	Manufacturer	Model Number	FCC ID	Remarks
For Local					
A	Personal Computer	ASUS	M32CD	DoC	-
B	LCD Monitor	ASUS	VS197DE	DoC	-
C	Keyboard	ASUS	AW211	DoC	-
D	Mouse	ASUS	MOBTUO	DoC	-
E	Printer	Fuji Xerox	Phaser 3121	DoC	-
F	Portable External HDD	PQI	H566	DoC	-
G	USB JIG	N/A	N/A	N/A	-

Radiated emission above 1GHz

No.	Peripheral	Manufacturer	Model Number	FCC ID	Remarks
For Local					
A	Personal Computer	HP	HP EliteDesk 800 G4 TWR	DoC	-
B	LCD Monitor	DELL	UltraSharp U2410f	DoC	-
C	Keyboard	Microsoft	1366	DoC	-
D	Mouse	Microsoft	1113	DoC	-
E	Printer	EPSON	C61	N/A	-
F	Portable External HDD	PQI	H566	DoC	-
G	USB JIG	N/A	N/A	N/A	-

2.3. Connection Diagram of Test System

Test Setup Diagram - Conducted emission and Radiated emission below 1GHz

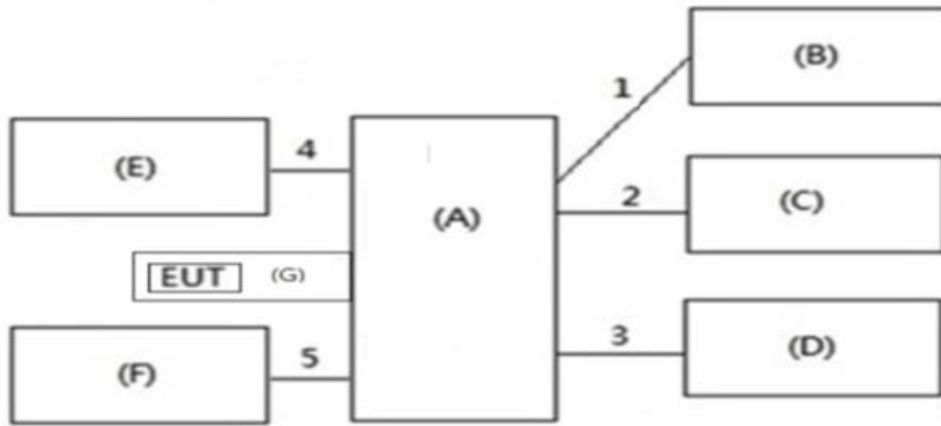

No.	Types of Cables	Shielding on Cable	Length (m)	Remarks
1	D-SUB Cable	D-Shielded	1.5	-
2	USB Cable	AL-F-Shielded	2.0	-
3	USB Cable	AL-F-Shielded	1.8	-
4	USB Cable	D-Shielded	1.8	-
5	USB Cable	D-Shielded	1.0	-

Test Setup Diagram – Radiated above 1GHz

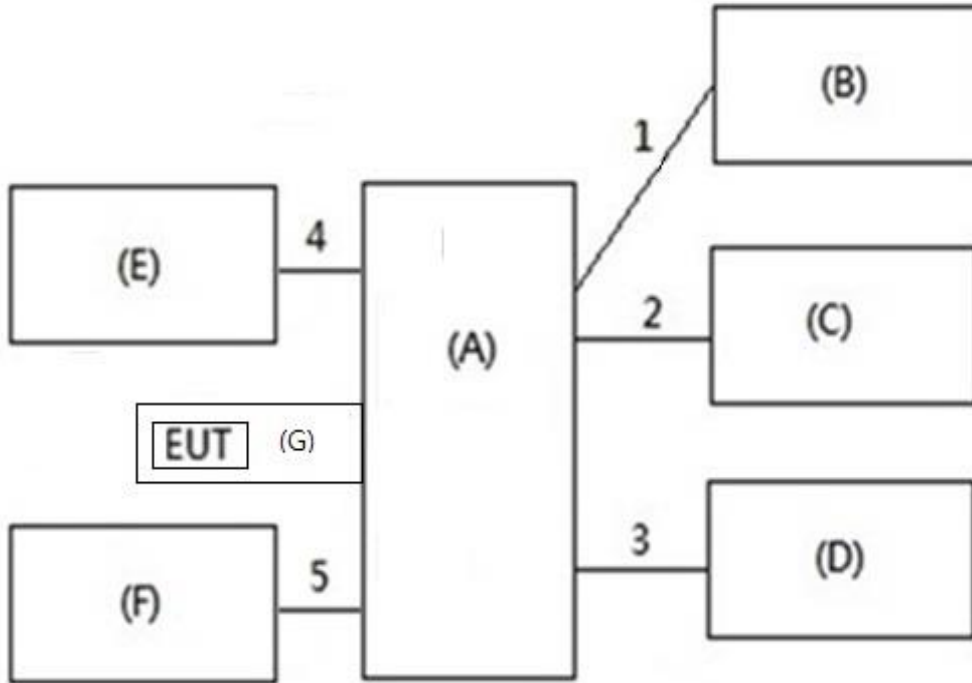

No.	Types of Cables	Shielding on Cable	Length (m)	Remarks
1	D-SUB Cable	D-Shielded	1.5	-
2	USB Cable	AL-F-Shielded	2.0	-
3	USB Cable	AL-F-Shielded	1.8	-
4	USB Cable	D-Shielded	1.8	-
5	USB Cable	D-Shielded	1.0	-



2.4. Details of EUT Test Setup

EMI

An executive program, "EMlprogram.exe" under WIN 10 was used as the test software. The program was executed as follows:

- Turn on the power of all equipment.
- The PC executed "BurnInTest" to access data by portable hard disk.
- The PC executed "Word" for printer printing.
- The PC executed "nRFgo Studio" to continuously transmit 2.4G signal by EUT.
- The PC executed "BurnInTest" to display "H" pattern on the screen.



3. General Information of Test

3.1. Test Facilities

Test Lab : Sporton International Inc. Hsinhua Laboratory						
<input checked="" type="checkbox"/>	Hsinhua (TAF: 3785)	ADD : No.52, Huaya 1st Rd., Guishan Dist., Taoyuan City 333411, Taiwan (R.O.C.)				
		TEL : 886-3-327-3456		FAX : 886-3-327-0973		
		FCC Designation Number: TW1129				
<input checked="" type="checkbox"/>	Hsinhua (TAF: 3785)	ADD : No.3, Ln. 238, Kangle St., Neihu Dist., Taipei City 114040, Taiwan (R.O.C.)				
		TEL : 886-2-2631-5551		FAX : 886-2-2631-9740		
		FCC Designation Number: TW1133				
Test Items	Test Site No.	Test Engineer	Test Environment		Test Date	Remark
			temp °C	humidity %		
Powerline Conducted Emissions	CO01-NH	Willy Lee	22.1~22.2	74~75	24/Dec/2021	-
Radiated Emissions (below 1GHz)	OS03-NH	Louis Lin	21.5~21.6	59.1~59.2	23/Dec/2021	-
Radiated Emissions (above 1GHz)	03CH01-HY	Yen-Liang	21.5~22.5	57~58	06/Jan/2022	-

3.2. Test Standards

Test items	Test Standards and Test Procedures
Radiated and Conducted Emissions	ANSI C63.4:2014 with FCC Method 47 CFR Part 15, Subpart B, Class B Digital Device, CISPR PUB. 22

3.3. Test Voltage/Frequencies

Power Supply Type	Voltage/Frequencies
Host System	120V / 60Hz

3.4. Test Distance and Frequency Range Investigated

Test Items	Frequency Range	Remark
Powerline Conducted Emissions	150 kHz to 30 MHz	-
Radiated Emissions (below 1GHz)	30 MHz to 1,000 MHz	Measurement distance is 10 m.
Radiated Emissions (above 1GHz)	1,000 MHz to 18,000 MHz	Measurement distance is 3 m.
	Above 18,000 MHz	Measurement distance is 1 m.

3.5. Operating Condition

- Full system.



3.6. Labelling requirements

The devices shall bear the following statement in a conspicuous location on the device:

This device complies with part 15 of the FCC Rules. Operation is subject to the following two conditions: (1) This device may not cause harmful interference, and (2) this device must accept any interference received, including interference that may cause undesired operation.

3.7. User Information

The users manual or instruction manual for an intentional or unintentional radiator shall caution the user that changes or modifications not expressly approved by the party responsible for compliance could void the user's authority to operate the equipment.

For a Class B digital device or peripheral, the instructions furnished the user shall include the following or similar statement, placed in a prominent location in the text of the manual:

This equipment has been tested and found to comply with the limits for a Class B digital device, pursuant to part 15 of the FCC Rules. These limits are designed to provide reasonable protection against harmful interference in a residential installation.

This equipment generates, uses and can radiate radio frequency energy and, if not installed and used in accordance with the instructions, may cause harmful interference to radio communications. However, there is no guarantee that interference will not occur in a particular installation.

If this equipment does cause harmful interference to radio or television reception, which can be determined by turning the equipment off and on, the user is encouraged to try to correct the interference by one or more of the following measures:

- Reorient or relocate the receiving antenna.
- Increase the separation between the equipment and receiver.
- Connect the equipment into an outlet on a circuit different from that to which the receiver is connected.
- Consult the dealer or an experienced radio/TV technician for help.

For a Class A digital device or peripheral, the instructions furnished the user shall include the following or similar statement, placed in a prominent location in the text of the manual:

This equipment has been tested and found to comply with the limits for a Class A digital device, pursuant to part 15 of the FCC Rules. These limits are designed to provide reasonable protection against harmful interference when the equipment is operated in a commercial environment. This equipment generates, uses, and can radiate radio frequency energy and, if not installed and used in accordance with the instruction manual, may cause harmful interference to radio communications. Operation of this equipment in a residential area is likely to cause harmful interference in which case the user will be required to correct the interference at his own expense.

4. Conducted Emissions Measurement

Conducted Emissions were measured according to the methods defined in ANSI C63.4-2014 Section 7.
The EUT is which satisfies the Class B disturbance limits.

4.1. Limit

Limits for conducted disturbance at the mains ports of class A			
Frequency range MHz	Coupling device	Detector type / bandwidth	Class A limits dB(μV)
0,15 – 0,5	AMN	Quasi-peak / 9 kHz	79
0,50 – 30			73
0,15 – 0,5	AMN	Average / 9 kHz	66
0,50 – 30			60
Note 1: The lower limit shall apply at the transition frequency.			
Limits for conducted disturbance at the mains ports of class B			
Frequency range MHz	Coupling device	Detector type / bandwidth	Class B limits dB(μV)
0,15 – 0,5	AMN	Quasi-peak / 9 kHz	66 - 56
0,5 – 5			56
5 – 30			60
0,15 – 0,5	AMN	Average / 9 kHz	56 - 46
0,5 – 5			46
5 – 30			50
Note 1: The lower limit shall apply at the transition frequencies.			
Note 2: The limit decreases linearly with the logarithm of the frequency in the range 0.15 MHz to 0.50 MHz.			



4.2. Test Procedures

Tabletop equipment:

- a). The EUT was warmed up for 15 minutes before testing started.
- b). The EUT was placed on a desk 0.8 meter height from the metal ground plane and 0.4 meter from the conducting wall of the shielding room and it was kept at least 0.8 meter from any other grounded conducting surface.
- c). Connect EUT to the power mains through a line impedance stabilization network (LISN).
- d). All the support units are connect to the other LISN.
- e). The LISN provides 50 ohm, coupling impedance for the measuring instrument.
- f). The FCC states that a 50 ohm, 50 microhenry LISN should be used.
- g). Both sides of AC line were checked for maximum conducted interference.
- h). The frequency range from 150 kHz to 30 MHz was searched.
- i). Set the test-receiver system to Peak Detect Function and Specified Bandwidth with Maximum Hold Mode.
- j). All emissions not reported here are more than 10 dB below the prescribed limit.

Floor-standing equipment:

- a). The EUT was warmed up for 15 minutes before testing started.
- b). The EUT was placed on the horizontal ground reference plane, 12mm above ground.
- c). Connect EUT to the power mains through a line impedance stabilization network (LISN).
- d). All the support units are connect to the other LISN.
- e). The LISN provides 50 ohm, coupling impedance for the measuring instrument.
- f). The CISPR states that a 50 ohm, 50 microhenry LISN should be used.
- g). Both sides of AC line were checked for maximum conducted interference.
- h). The frequency range from 150 kHz to 30 MHz was searched.
- i). Set the test-receiver system to Peak Detect Function and Specified Bandwidth with Maximum Hold Mode.
- j). All emissions not reported here are more than 10 dB below the prescribed limit.

4.3. Measurement Results Calculation

The measured Level is calculated using:

$$\text{Corrected Reading (dB}\mu\text{V)} = \text{LISN Factor} + \text{Cable Loss} + \text{Read Level}$$

For example at 0.3 MHz if the LISN Factor is 10.48 dB, the cable loss is 0.10 dB, the measured voltage is 36.39 dB μ V, the signal strength would be calculated:

$$\text{Corrected Reading (dB}\mu\text{V)} = 10.48 \text{ dB} + 0.10 \text{ dB} + 36.39 \text{ dB}\mu\text{V} = 46.97 \text{ dB}\mu\text{V}$$

4.4. Typical Test Setup Layout

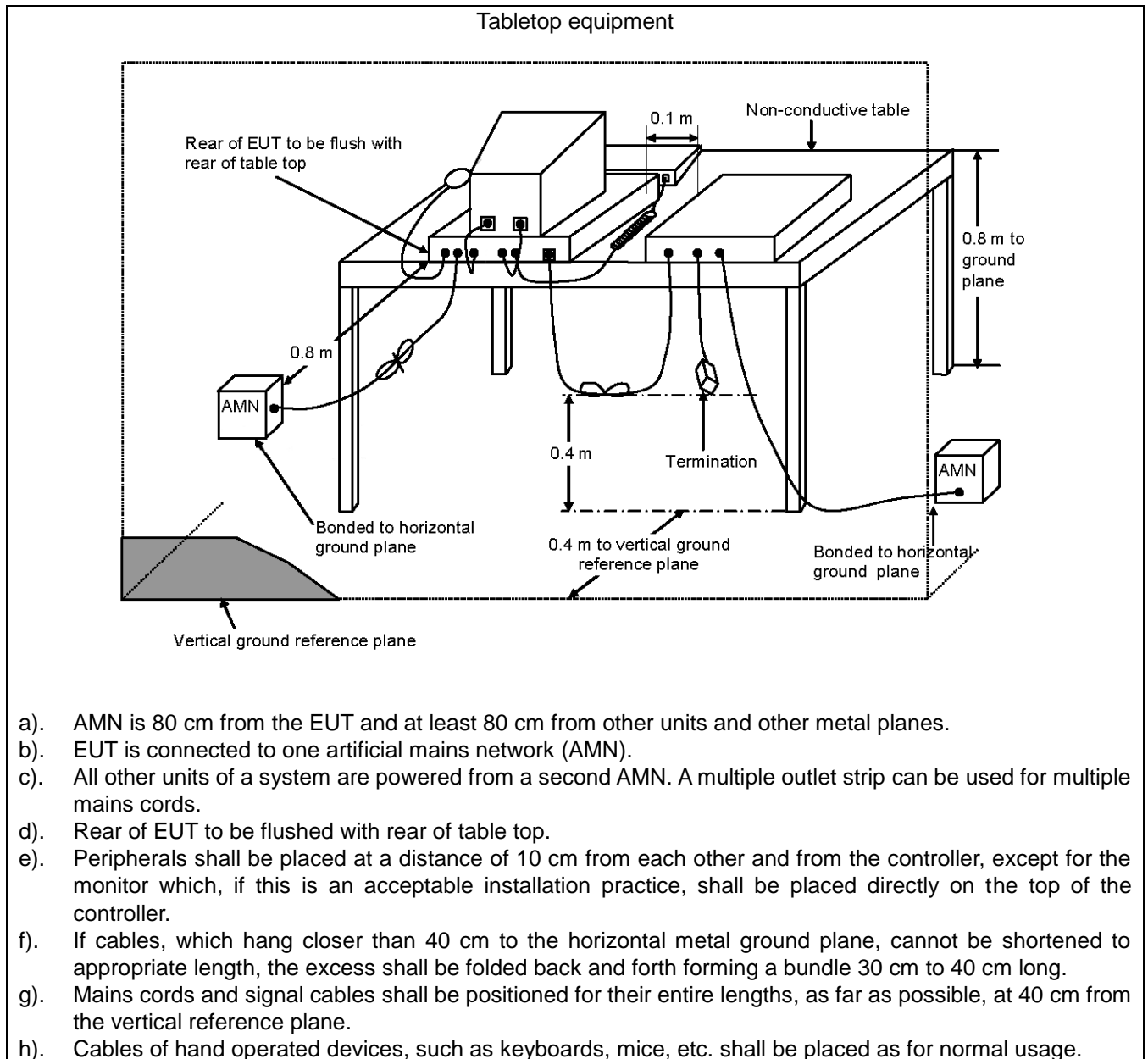

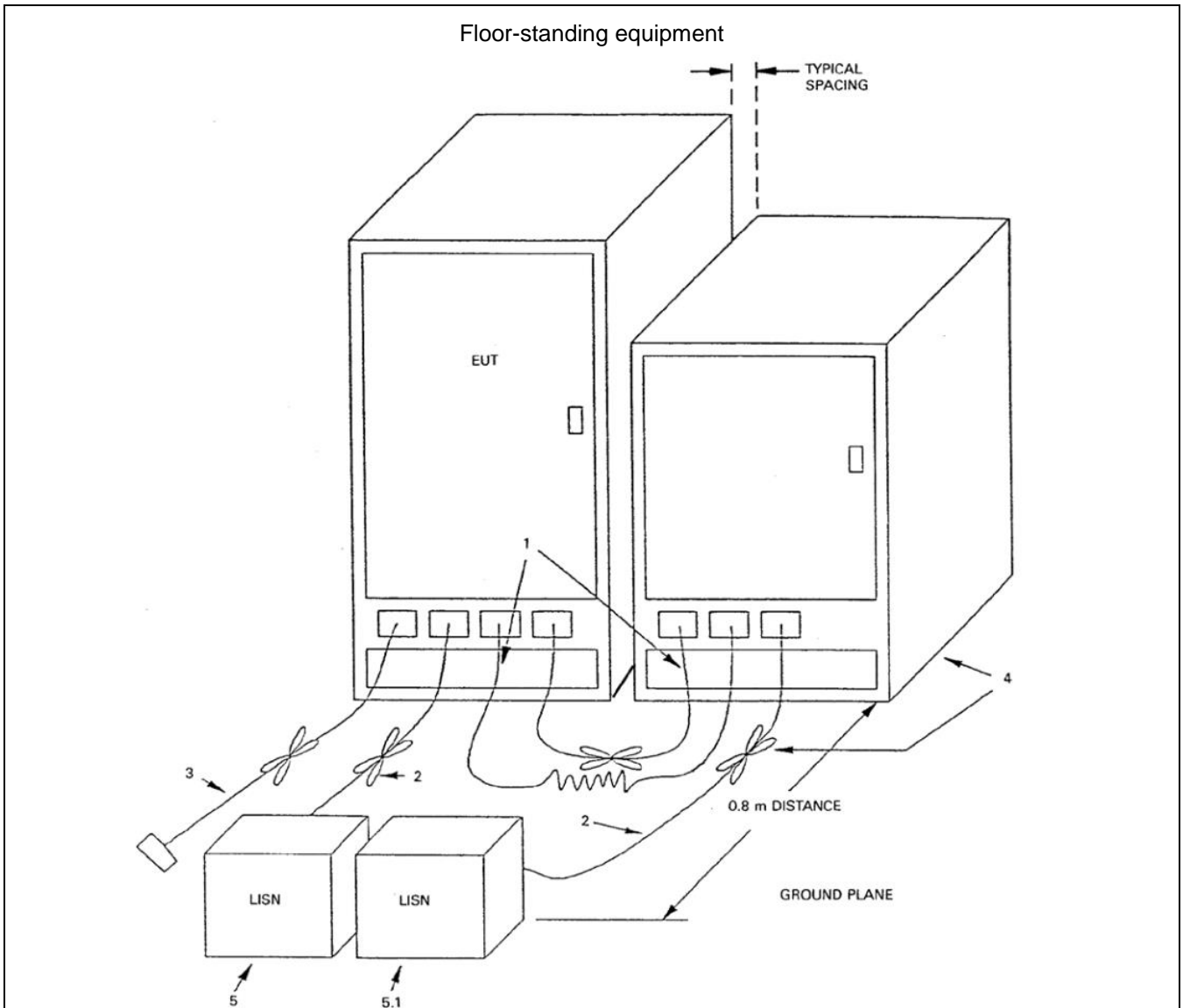

- a). Excess I/O cables shall be bundled in the center. If bundling is not possible, the cables shall be arranged in a serpentine fashion. Bundling shall not exceed 40 cm in length.
- b). Excess power cords shall be bundled in the center or shortened to appropriate length.
- c). I/O cables that are not connected to a peripheral shall be bundled in the center. The end of the cable may be terminated, if required, using the correct terminating impedance. If bundling is not possible, the cable shall be arranged in a serpentine fashion.
- d). EUT and all cables shall be insulated, if required, from the ground plane by up to 12 mm of insulating material.
- e). EUT connected to one LISN. LISN can be placed on top of, or immediately beneath, the ground plane.
 - 5.1 All other equipment powered from a second LISN or additional LISN(s).
 - 5.2 A multiple outlet strip can be used for multiple power cords of non-EUT equipment.



4.5. Test Result

Test Mode	Mode 1		
Test Frequency	0.15 MHz ~ 30 MHz	Test Voltage	AC 120V / 60Hz
<p>■ The test was passed at the minimum margin that marked by the frame in the following data</p>			

Line

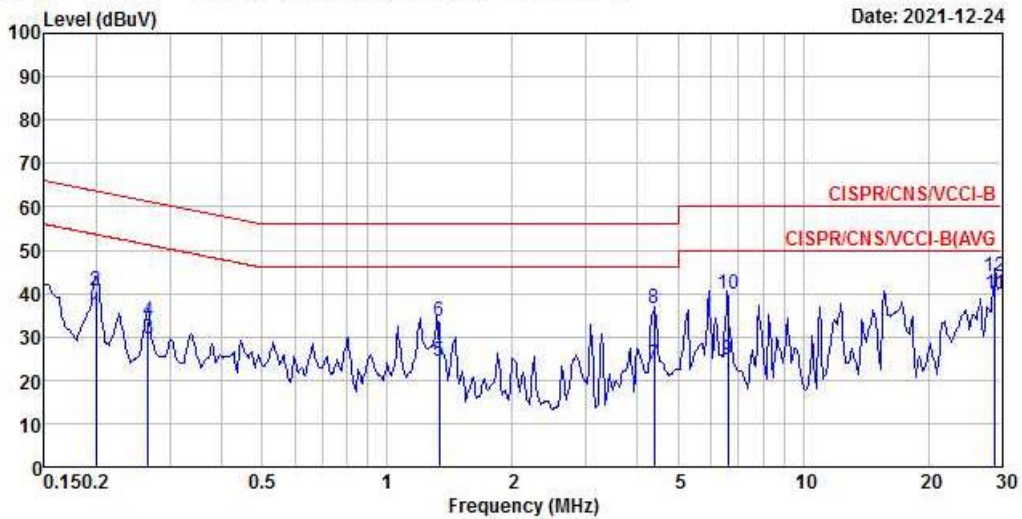

	Freq	Level	Over Limit	Limit Line	Read Level	LISN Factor	Cable Loss	Remark
	MHz	dBuV	dB	dBuV	dBuV	dB	dB	
1	0.20	35.23	-18.39	53.62	24.85	10.28	0.10	Average
2	0.20	40.43	-23.19	63.62	30.05	10.28	0.10	QP
3	0.27	29.49	-21.76	51.25	19.11	10.28	0.10	Average
4	0.27	33.47	-27.78	61.25	23.09	10.28	0.10	QP
5	1.34	24.37	-21.63	46.00	13.96	10.28	0.13	Average
6	1.34	33.43	-22.57	56.00	23.02	10.28	0.13	QP
7	4.39	23.79	-22.21	46.00	13.30	10.32	0.17	Average
8	4.39	36.68	-19.32	56.00	26.19	10.32	0.17	QP
9	6.59	24.67	-25.33	50.00	14.10	10.37	0.20	Average
10	6.59	39.68	-20.32	60.00	29.11	10.37	0.20	QP
11 @	28.95	39.72	-10.28	50.00	28.17	10.80	0.75	Average
12	28.95	43.91	-16.09	60.00	32.36	10.80	0.75	QP



Neutral

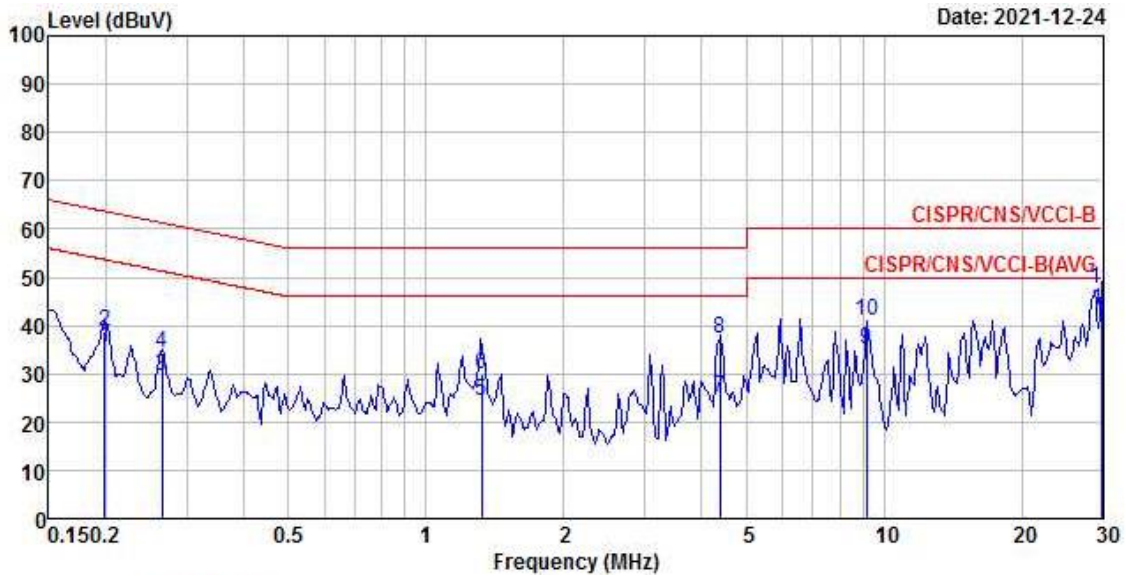

	Freq	Level	Over Limit	Limit Line	Read Level	LISN Factor	Cable Loss	Remark
	MHz	dBuV	dB	dBuV	dBuV	dB	dB	
1	0.20	35.28	-18.40	53.68	24.89	10.29	0.10	Average
2	0.20	38.61	-25.07	63.68	28.22	10.29	0.10	QP
3	0.27	29.57	-21.68	51.25	19.18	10.29	0.10	Average
4	0.27	34.34	-26.91	61.25	23.95	10.29	0.10	QP
5	1.32	24.32	-21.68	46.00	13.90	10.29	0.13	Average
6	1.32	29.85	-26.15	56.00	19.43	10.29	0.13	QP
7	4.39	25.09	-20.91	46.00	14.57	10.35	0.17	Average
8	4.39	37.32	-18.68	56.00	26.80	10.35	0.17	QP
9	9.16	35.17	-14.83	50.00	24.51	10.44	0.22	Average
10	9.16	40.81	-19.19	60.00	30.15	10.44	0.22	QP
11 @	30.00	42.99	-7.01	50.00	31.22	10.95	0.82	Average
12	30.00	47.57	-12.43	60.00	35.80	10.95	0.82	QP



5. Radiated Emissions Measurement

Radiated Emissions were measured according to the methods defined in ANSI C63.4-2014 Section 8. The EUT is which satisfies the Class B disturbance limits.

5.1. Radiated Emission below 1GHz

5.1.1.Limit

radiated emissions at frequencies up to 1 GHz for Class A equipment			
Frequency range MHz	Measurement		Class A limits
	Distance (m)	Detector type / bandwidth	dB(µV/m)
30 – 230	10	Quasi Peak / 120 kHz	40
230 – 1000			47
radiated emissions at frequencies up to 1 GHz for Class B equipment			
Frequency range MHz	Measurement		Class B limits
	Distance (m)	Detector type / bandwidth	dB(µV/m)
30 – 230	10	Quasi Peak / 120 kHz	30
230 – 1000			37

5.1.2. Test Procedures

Tabletop equipment:

- a). The EUT was placed on a rotatable table top 0.8 meter above ground.
- b). The EUT was set 10 meters from the interference-receiving antenna which was mounted on the top of a variable height antenna tower.
- c). The table was rotated 360 degrees to determine the position of the highest radiation.
- d). The antenna is a half wave dipole and its height is varied between one meter and four meters above ground to find the maximum value of the field strength both horizontal polarization and vertical polarization of the antenna are set to make the measurement.
- e). For each suspected emission the EUT was arranged to its worst case and then tune the antenna tower (from 1 M to 4 M) and turn table (from 0 degree to 360 degrees) to find the maximum reading.
- f). Set the test-receiver system to Peak Detect Function and specified bandwidth with Maximum Hold Mode.
- g). If the emission level of the EUT in peak mode was 3 dB lower than the limit specified, then testing will be stopped and peak values of EUT will be reported, otherwise, the emissions which do not have 3 dB margin will be repeated one by one using the quasi-peak method and reported.
- h). The FCC Part 15.109(g) permit parties seeking to authorize a digital device to choose to demonstrate that the device complies with either the Part 15 standards or the international standards found in Publication 22 of the International Special Committee on Radio Interference (CISPR).
- i). If the EUT is having a Wireless modular, can choose to install the filter at the input connector of test-receiver system.

Floor-standing equipment:

- a). The EUT was placed on the horizontal ground reference plane, 12 mm above ground.
- b). The EUT was set 10 meters from the interference-receiving antenna which was mounted on the top of a variable height antenna tower.
- c). The table was rotated 360 degrees to determine the position of the highest radiation.
- d). The antenna is a half wave dipole and its height is varied between one meter and four meters above ground to find the maximum value of the field strength both horizontal polarization and vertical polarization of the antenna are set to make the measurement.



- e). For each suspected emission the EUT was arranged to its worst case and then tune the antenna tower (from 1 M to 4 M) and turn table (from 0 degree to 360 degrees) to find the maximum reading.
- f). Set the test-receiver system to Peak Detect Function and specified bandwidth with Maximum Hold Mode.
- g). If the emission level of the EUT in peak mode was 3 dB lower than the limit specified, then testing will be stopped and peak values of EUT will be reported, otherwise, the emissions which do not have 3 dB margin will be repeated one by one using the quasi-peak method and reported.
- h). The FCC Part 15.109(g) permit parties seeking to authorize a digital device to choose to demonstrate that the device complies with either the Part 15 standards or the international standards found in Publication 22 of the International Special Committee on Radio Interference (CISPR).
- i). If the EUT is having a Wireless modular, can choose to install the filter at the input connector of test-receiver system.

5.1.3.Measurement Results Calculation

The measured Level is calculated using:
Corrected Reading (dB μ V/m) = Antenna Factor + Cable Loss + Read Level – Preamp Factor
For example at 125 MHz if the Antenna Factor is 17.24 dB/m, the cable loss is 1.20 dB, the measured voltage is 35.80 dB μ V and the Preamp Factor is 27.18 dB, the signal strength would be calculated:
Corrected Reading (dB μ V/m) = 17.24 dB/m + 1.20 dB + 35.80 dB μ V - 27.18 dB = 27.06 dB μ V/m
Note: If a hybrid antenna is used, the antenna factor shall be the sum of the Antenna Factor + Attenuator Factor.

5.1.4. Typical Test Setup Layout

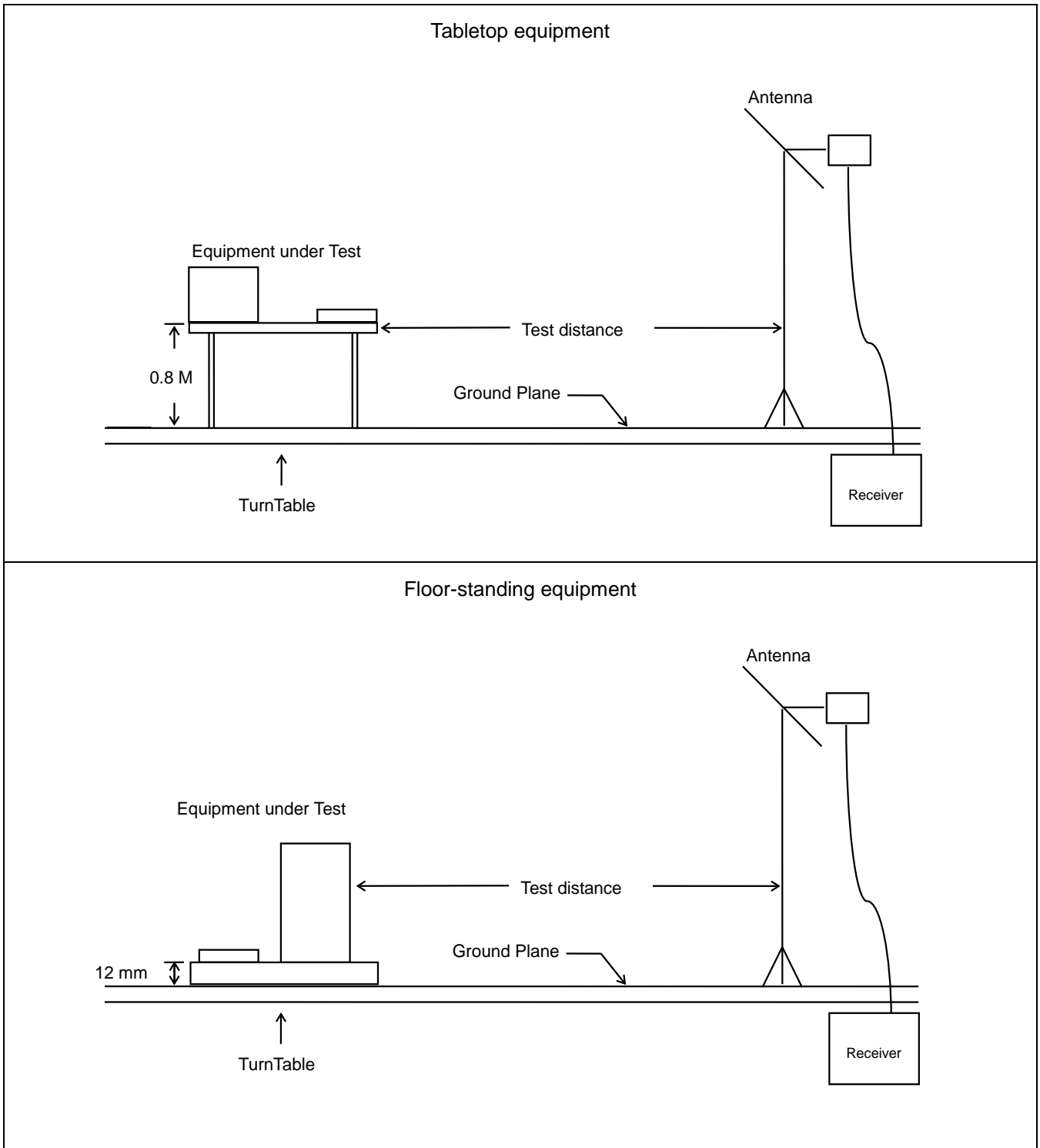



5.1.5. Test Result

Test mode	Mode 1		
Test frequency	30 MHz ~ 1000 MHz	Test Voltage	AC 120V / 60Hz
<p>■ The test was passed at the minimum margin that marked by the frame in the following data</p>			

Vertical

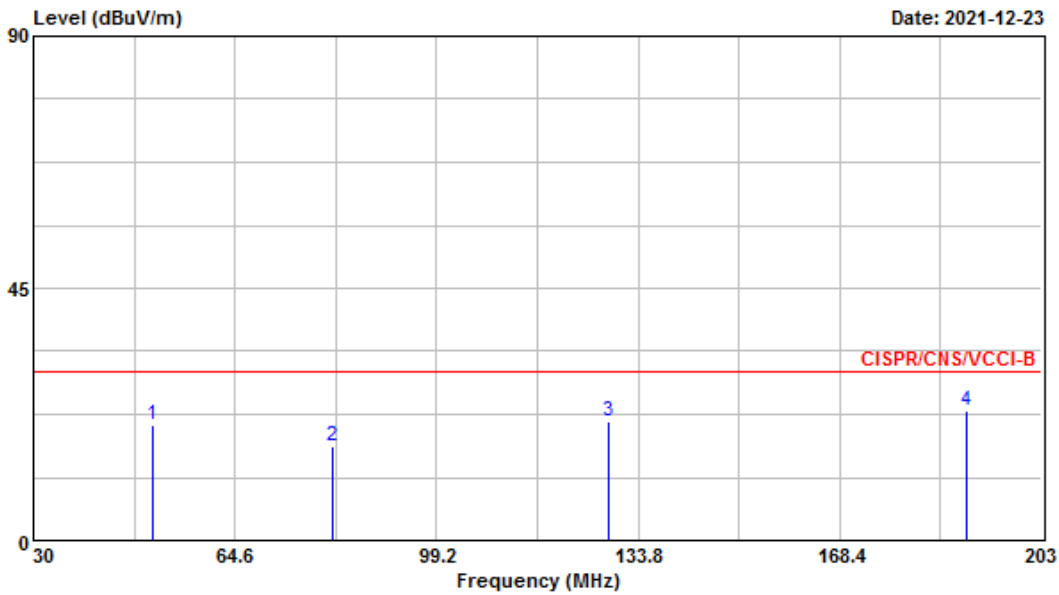

	Freq	Level	Over Limit	Limit Line	ReadAntenna Level	Antenna Factor	Cable Loss	Preamp Factor	Remark	Ant Pos	Table Pos
	MHz	dBuV/m	dB	dBuV/m	dBuV	dB/m	dB	dB		cm	deg
1	50.410	20.51	-9.49	30.00	34.42	13.35	1.20	28.46	Peak	---	---
2	81.380	16.95	-13.05	30.00	31.43	12.25	1.68	28.41	Peak	---	---
3	128.780	21.36	-8.64	30.00	30.02	17.53	2.09	28.28	Peak	---	---
4	190.200	23.04	-6.96	30.00	33.99	14.50	2.60	28.05	Peak	---	---



Vertical

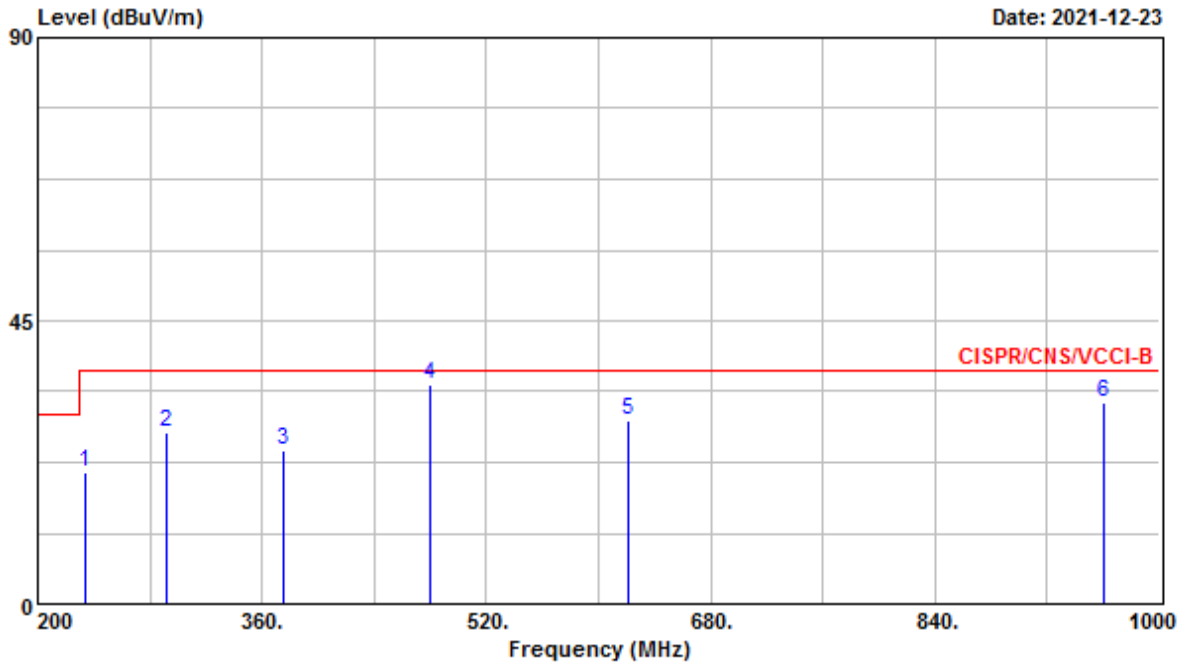

	Freq	Level	Over Limit	Limit Line	ReadAntenna Level	Antenna Factor	Cable Loss	Preamp Factor	Remark	Ant Pos	Table Pos
	MHz	dBuV/m	dB	dBuV/m	dBuV	dB/m	dB	dB		cm	deg
1	233.600	21.07	-15.93	37.00	30.11	15.77	3.04	27.85	Peak	---	---
2	292.000	27.21	-9.79	37.00	33.52	18.24	3.28	27.83	Peak	---	---
3	375.200	24.45	-12.55	37.00	28.76	20.01	4.00	28.32	Peak	---	---
4 @	480.000	34.91	-2.09	37.00	36.99	22.49	4.38	28.95	QP	---	---
5 @	620.800	29.30	-7.70	37.00	29.19	23.86	5.42	29.17	Peak	---	---
6 @	960.000	31.88	-5.12	37.00	27.11	26.12	7.25	28.60	Peak	---	---



Horizontal

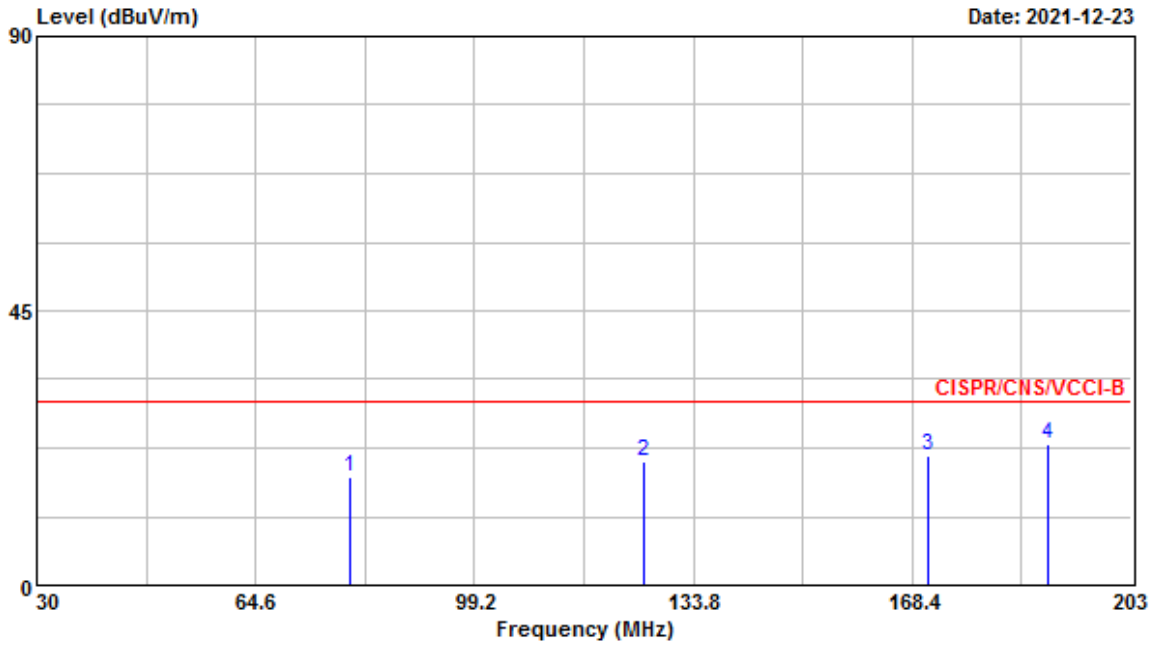

	Freq	Level	Over Limit	Limit Line	ReadAntenna Level	Antenna Factor	Cable Loss	Preamp Factor	Remark	Ant Pos	Table Pos
	MHz	dBuV/m	dB	dBuV/m	dBuV	dB/m	dB	dB		cm	deg
1	79.480	17.64	-12.36	30.00	32.44	11.93	1.68	28.41	Peak	---	---
2	126.020	20.21	-9.79	30.00	28.71	17.73	2.06	28.29	Peak	---	---
3 @	171.000	21.23	-8.77	30.00	32.06	14.86	2.45	28.14	Peak	---	---
4 @	189.850	23.21	-6.79	30.00	34.16	14.50	2.60	28.05	Peak	---	---



Horizontal

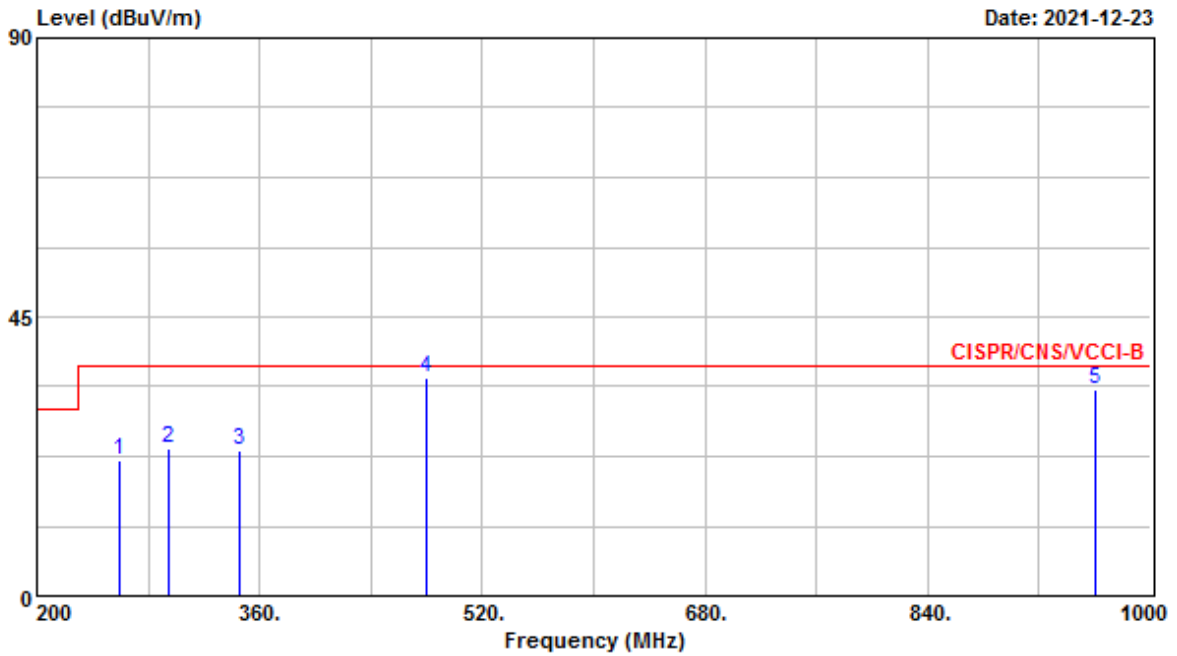

	Freq	Level	Over Limit	Limit Line	ReadAntenna Level	Antenna Factor	Cable Loss	Preamp Factor	Remark	Ant Pos	Table Pos
	MHz	dBuV/m	dB	dBuV/m	dBuV	dB/m	dB	dB		cm	deg
1	259.200	22.02	-14.98	37.00	28.08	18.52	3.22	27.80	Peak	---	---
2	294.400	23.80	-13.20	37.00	30.03	18.32	3.29	27.84	Peak	---	---
3	345.600	23.42	-13.58	37.00	28.21	19.36	3.93	28.08	Peak	---	---
4 @	479.200	35.10	-1.90	37.00	37.20	22.48	4.37	28.95	QP	400	178
5 @	960.000	33.41	-3.59	37.00	28.64	26.12	7.25	28.60	QP	---	---



5.2. Radiated Emission above 1GHz

The EUT is which satisfies the Class B disturbance limits.

5.2.1.Limit

radiated emissions at frequencies above 1 GHz for Class A equipment			
Frequency range GHz	Measurement		Class A limits
	Distance (m)	Detector type / bandwidth	dB(µV/m)
1 – 18	3	Average / 1 MHz	60
1 – 18		Peak / 1 MHz	80
18 – 40	1	Average / 1 MHz	69.54
18 – 40		Peak / 1 MHz	89.54
radiated emissions at frequencies above 1 GHz for Class B equipment			
Frequency range GHz	Measurement		Class B limits
	Distance (m)	Detector type / bandwidth	dB(µV/m)
1 – 18	3	Average / 1 MHz	54
1 – 18		Peak / 1 MHz	74
18 – 40	1	Average / 1 MHz	63.54
18 – 40		Peak / 1 MHz	83.54
Test distance for frequencies at or above 30 MHz, measurements may be performed at a distance other than the limit distance provided they are not performed in the near field and the emissions to be measured can be detected by the measurement equipment. When performing measurements at a distance other than that specified, the results shall be extrapolated to the specified distance using an extrapolation factor of 20 dB/decade (inverse of linear distance for field-strength measurements, inverse of linear distance-squared for power-density measurements).			
Remark: It should be noted that the field strength is inversely proportional to distance, so the field strength at 3m is 1/3 the strength at 1m, i.e. $L3m/Lx = X/3$. Ex. $L3m\ dB-Lx\ dB = 20\log(3/x)$; $L1m\ dB = 60 + 20\log(3/1) = 69.54\ dB(\mu V/m)$ Ex. $L3m\ dB-Lx\ dB = 20\log(3/x)$; $L1m\ dB = 54 + 20\log(3/1) = 63.54\ dB(\mu V/m)$			

Required highest frequency for radiated measurement	
Highest internal frequency (F_x)	Highest measured frequency
$F_x \leq 108\ MHz$	1 GHz
$108\ MHz < F_x \leq 500\ MHz$	2 GHz
$500\ MHz < F_x \leq 1\ GHz$	5 GHz
$F_x > 1\ GHz$	$5 \times F_x$ up to a maximum of 40 GHz



5.2.2. Test Procedures

Tabletop equipment:

- a). Same test set up as below 1GHz radiated testing.
- b). The EUT was set 3m (1 – 18GHz) / 1m (18 – 40GHz) from the interference-receiving antenna which was mounted on the top of a variable height antenna tower.
- c). There should be absorber placed between the EUT and Antenna and its located size should let the test site meet CISPR16-1-4 requirement.
- d). The table was rotated 360 degrees to determine the position of the highest radiation.
- e). The measured using a test-receiver system with both a peak and CISPR average detector.
- f). If the EUT is having a Wireless or Bluetooth modular, can choose to install the filter at the input connector of test-receiver system.
- g). Set the DRG Horn Antenna at 1M height, then run the turn table to get the maximum noise reading from Horizontal and Vertical polarity separately the test-receiver system to Peak Detect Function and specified bandwidth with Maximum Hold Mode.
- h). When EUT locating on the turn-table, and its height is over 172cm (Antenna’s 3dB beam width of 6GHz is 27°), the DRG Horn Antenna must be raised up and descended down, while keeping the antenna in the cone of radiation from that area and pointed at the area both in azimuth and elevation, then turning around the turn-table to get the maximum noise reading of the Horizontal and Vertical polarity separately.
- i). If emission level of the EUT in peak mode was 23dB lower than average limit (that means the emission level in peak mode also complies with the limit in average mode), then testing will be stopped and peak values of EUT will be reported, otherwise, the emissions will be measured in average mode again and reported.

Floor-standing equipment:

- a). Same test set up as below 1GHz radiated testing.
- b). The EUT was set 3m (1 – 18GHz) / 1m (18 – 40GHz) from the interference-receiving antenna which was mounted on the top of a variable height antenna tower.
- c). There should be absorber placed between the EUT and Antenna and its located size should let the test site meet CISPR16-1-4 requirement.
- d). The table was rotated 360 degrees to determine the position of the highest radiation.
- e). The measured using a test-receiver system with both a peak and CISPR average detector.
- f). If the EUT is having a Wireless or Bluetooth modular, can choose to install the filter at the input connector of test-receiver system.
- g). Set the DRG Horn Antenna at 1M height, then run the turn table to get the maximum noise reading from Horizontal and Vertical polarity separately the test-receiver system to Peak Detect Function and specified bandwidth with Maximum Hold Mode.
- h). When EUT locating on the turn-table, and its height is over 172cm (Antenna’s 3dB beam width of 6GHz is 27°), the DRG Horn Antenna must be raised up and descended down, while keeping the antenna in the cone of radiation from that area and pointed at the area both in azimuth and elevation, then turning around the turn-table to get the maximum noise reading of the Horizontal and Vertical polarity separately.
- i). If emission level of the EUT in peak mode was 23dB lower than average limit (that means the emission level in peak mode also complies with the limit in average mode), then testing will be stopped and peak values of EUT will be reported, otherwise, the emissions will be measured in average mode again and reported.

5.2.3. Measurement Results Calculation

The measured Level is calculated using:
 Corrected Reading (dB μ V/m) = Raw(Read Level)+AF(Antenna Factor)+CL(Cable Loss)-PA(Preamp Factor)
 For example at 1980 MHz if the Antenna Factor is 26.19 dB/m, the cable loss is 4.08 dB, the measured voltage is 51.30 dB μ V and the Preamp Factor is 33.34 dB, the signal strength would be calculated:
 Corrected Reading (dB μ V/m) = 51.30 dB μ V + 26.19 dB/m + 4.08 dB - 33.34 dB = 48.23 dB μ V/m
 Note: If a Band reject filter is used, this factor will be added to the sum of the factors.

5.2.4. Typical Test Setup Layout

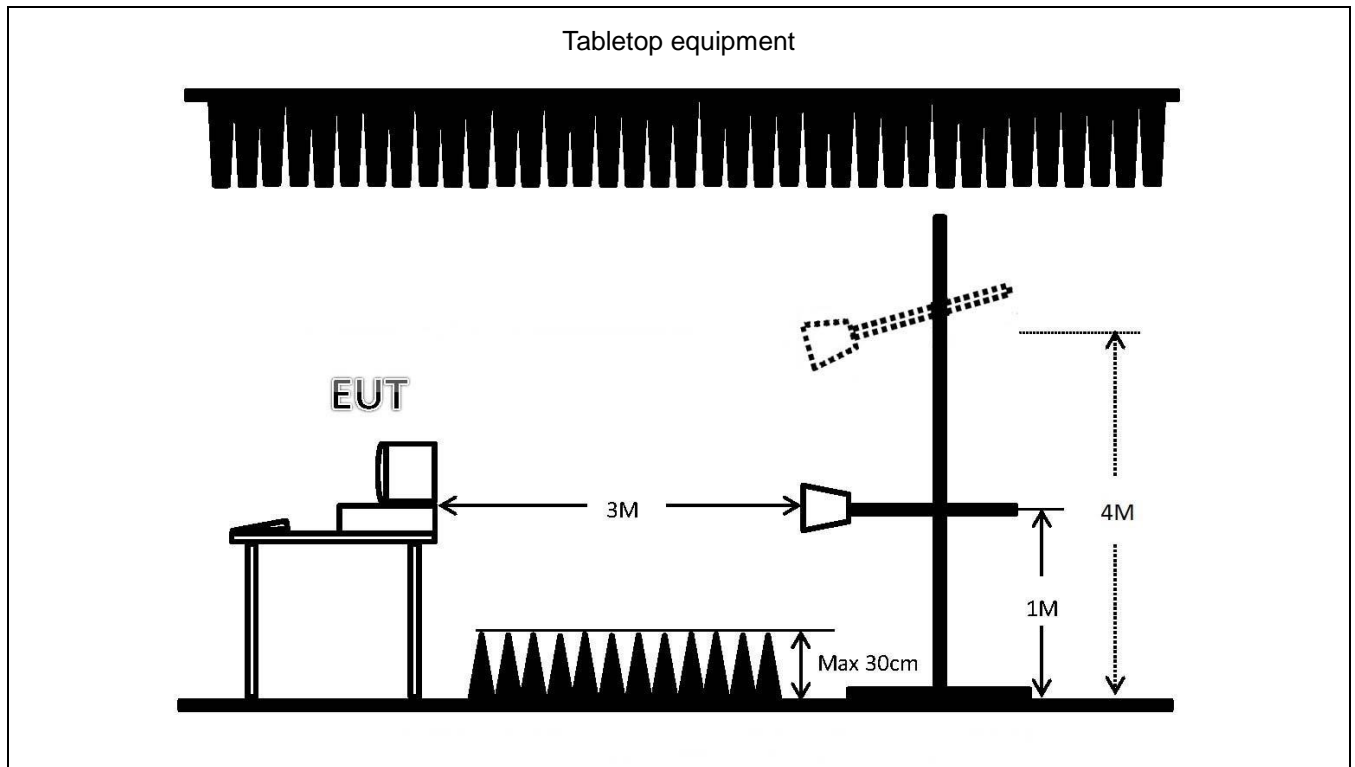

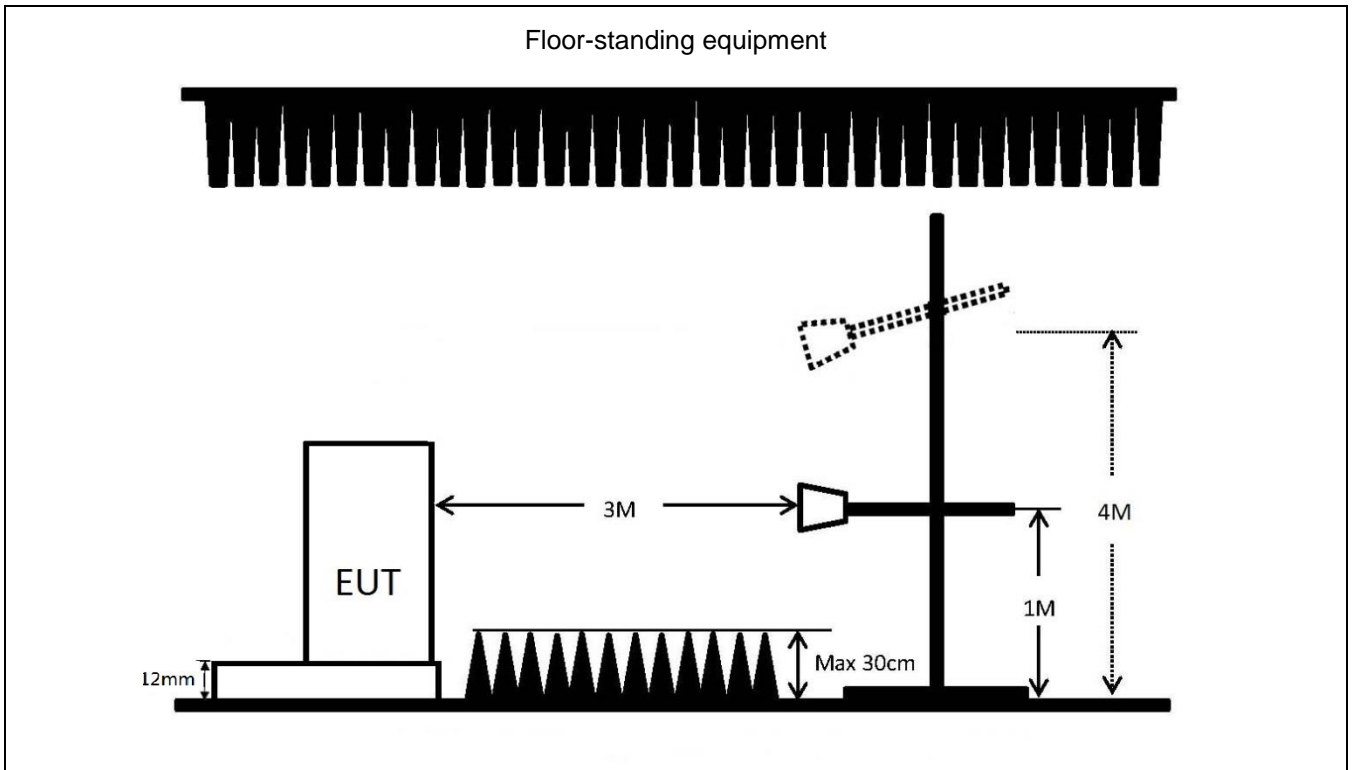



5.2.5. Test Result

Test mode	Mode 1		
Test frequency	Above 1GHz	Test Voltage	AC 120V / 60Hz
<p>■ The test was passed at the minimum margin that marked by the frame in the following data</p>			

Vertical

Mode 1

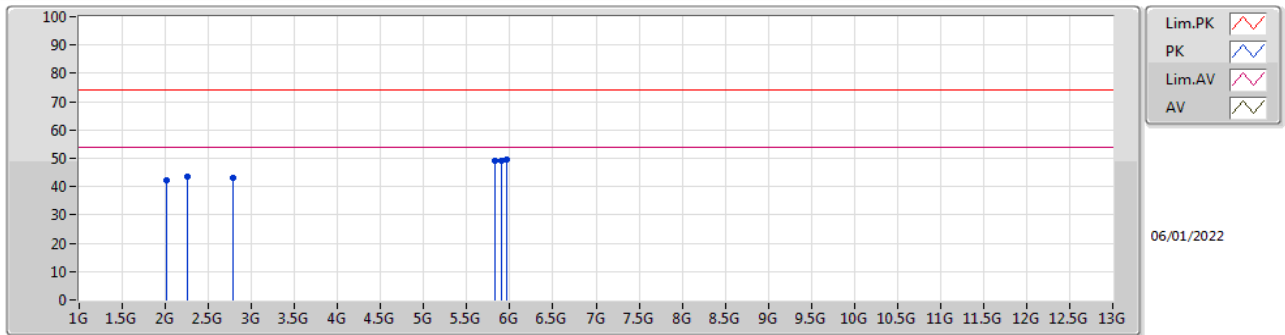

Type	Freq (Hz)	Level (dBuV/m)	Limit (dBuV/m)	Margin (dB)	Factor (dB/m)	Dist (m)	Condition	Azimuth (°)	Height (m)	Comment	Raw (dBuV)	AF (dB/m)	CL (dB)	PA (dB)
PK	2.02G	42.19	74.00	-31.81	-4.18	3	Vertical	-	-	-	46.37	26.98	3.95	35.11
PK	2.25G	43.42	74.00	-30.58	-2.34	3	Vertical	-	-	-	45.76	28.60	4.16	35.10
PK	2.785G	43.03	74.00	-30.97	-2.57	3	Vertical	-	-	-	45.60	28.31	4.26	35.14
PK	5.825G	49.03	74.00	-24.97	5.39	3	Vertical	-	-	-	43.64	32.35	7.66	34.62
PK	5.905G	49.05	74.00	-24.95	5.61	3	Vertical	-	-	-	43.44	32.51	7.72	34.62
PK	5.97G	49.68	74.00	-24.32	5.76	3	Vertical	174	1	"Worst"	43.92	32.60	7.77	34.61



Horizontal

Mode 1

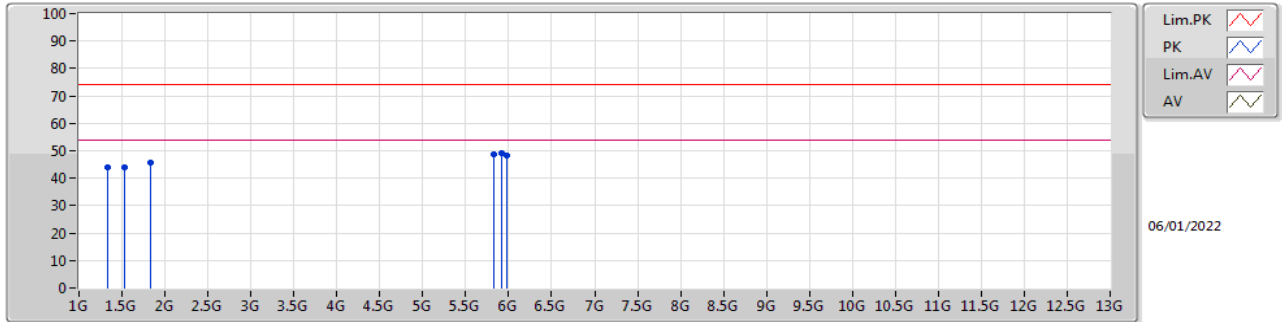

Type	Freq (Hz)	Level (dBuV/m)	Limit (dBuV/m)	Margin (dB)	Factor (dB/m)	Dist (m)	Condition	Azimuth (°)	Height (m)	Comment	Raw (dBuV)	AF (dB/m)	CL (dB)	PA (dB)
PK	1.33G	43.94	74.00	-30.06	-6.08	3	Horizontal	-	-	-	50.02	26.28	3.26	35.62
PK	1.525G	43.77	74.00	-30.23	-5.96	3	Horizontal	-	-	-	49.73	25.80	3.56	35.32
PK	1.83G	45.62	74.00	-28.38	-5.35	3	Horizontal	-	-	-	50.97	25.96	3.87	35.18
PK	5.825G	48.69	74.00	-25.31	5.39	3	Horizontal	-	-	-	43.30	32.35	7.66	34.62
PK	5.915G	49.05	74.00	-24.95	5.64	3	Horizontal	194	1	"Worst"	43.41	32.53	7.73	34.62
PK	5.985G	48.45	74.00	-25.55	5.77	3	Horizontal	-	-	-	42.68	32.60	7.78	34.61



6. Uncertainty of Test Site

ISO/IEC 17025 requires that an estimate of the measurement uncertainties associated with the emissions test results be included in the report. The measurement uncertainties given below are based on a 95% confidence level (based on a coverage factor (k=2)).

6.1. Measurement Uncertainty

Test Items	Test Site No.	U_{LAB}
Conducted Emissions	CO01-NH	2.66 dB
Radiated Emissions below 1GHz	OS03-NH	5.07 dB
Radiated Emissions above 1GHz	03CH01-HY	3.59 dB



7. List of Measuring Equipment Used

Conducted Emission - Test Date: 24/Dec/2021

Instrument	Manufacturer/ Brand	Model No.	Serial No.	Characteristics	Calibration Date	Calibration Due Date	Remark
EMI Receiver	R&S	ESR	102318	9k Hz - 3.6 GHz	26/Jul/2021	25/Jul/2022	Conduction (CO01-NH)
LISN	SCHAFFNER	NNB41	06/10024	9kHz - 30MHz	28/Dec/2020	27/Dec/2021	Conduction (CO01-NH)
LISN (Support Unit)	MessTec	NNB-2/16Z	99079	9kHz - 30MHz	03/Feb/2021	02/Feb/2022	Conduction (CO01-NH)
Power Filter	CORCOM	MR12030	N/A	30A*2	NCR	NCR	Conduction (CO01-NH)
RF Cable-CON	Suhner Switzerland	RG223/U	CB004	9kHz - 30MHz	25/Dec/2020	24/Dec/2021	Conduction (CO01-NH)
software	Audix	E3	6.12160806	-	NCR	NCR	Conduction (CO01-NH)

NCR: No Calibration Required

Radiated Emission below 1GHz - Test Date: 23/Dec/2021

Instrument	Manufacturer/ Brand	Model No.	Serial No.	Characteristics	Calibration Date	Calibration Due Date	Remark
Open Area Test Site	SPORTON	OATS-10	OS03-NH	30 MHz - 1 GHz 10m, 3m	16/Oct/2021	15/Oct/2022	Radiation (OS03-NH)
Amplifier	HP	8447D	2944A08292	0.1 MHz - 1.3 GHz	02/Jul/2021	01/Jul/2022	Radiation (OS03-NH)
Spectrum Analyzer	R&S	FSP7	838858/038	9 kHz - 7GHz	21/Jun/2021	20/Jun/2022	Radiation (OS03-NH)
Receiver	R&S	ESCS30	100357	9 kHz - 2.75 GHz	07/May/2021	06/May/2022	Radiation (OS03-NH)
Bilog Antenna With 5dB Attenuator	CHASE	CBL6112D	25234	30 MHz - 2 GHz	24/Apr/2021	23/Apr/2022	Radiation (OS03-NH)
Turn Table	EMCO	2080	9805-2065	0 - 360 degree	NCR	NCR	Radiation (OS03-NH)
Antenna Mast	EMCO	2075	9804-2151	1 m - 4 m	NCR	NCR	Radiation (OS03-NH)
RF Cable-R10m	HSCN	RG213U	2X11N	30 MHz - 1 GHz	13/Jul/2021	12/Jul/2022	Radiation (OS03-NH)
Software	Audix	E3	Ver.4	-	NCR	NCR	Radiation (OS03-NH)

NCR: No Calibration Required

**Radiated Emission above 1GHz - Test Date: 06/Jan/2022**

Instrument	Manufacturer/ Brand	Model No.	Serial No.	Characteristics	Calibration Date	Calibration Due Date	Remark
Microwave Preamplifier	Agilent	8449B	3008A02602	1GHz~26.5GHz	19/Mar/2021	18/Mar/2022	Radiation (03CH01-HY)
EMI Test Receiver	R&S	ESU-26	100422	20Hz ~ 26.5GHz	05/Nov/2021	04/Nov/2022	Radiation (03CH01-HY)
Site V.S.W.R	Riken	3m SAC	03CH01-HY	1 GHz ~ 18 GHz 3m	08/Jan/2021	07/Jan/2022	Radiation (03CH01-HY)
Horn Antenna	SCHWARZBEC K	BBHA9120	BBHA9120D01834	1 GHz ~ 18 GHz	23/Feb/2021	22/Feb/2022	Radiation (03CH01-HY)
RF Cable	SUHNER	SUCOFLEX 104	CB001-03CH01	30MHz~18GHz	25/Feb/2021	24/Feb/2022	Radiation (03CH01-HY)
Turn Table	MF	DS 420	420/648/00	0 ~ 360 degree	NCR	NCR	Radiation (03CH01-HY)
Antenna Mast	MF	MFA-515BSN	MFA-515BSN13 08261	1 m ~ 4 m	NCR	NCR	Radiation (03CH01-HY)
Software	Sporton	SENSE-EMI	V5.10.7	-	NCR	NCR	Radiation (03CH01-HY)

NCR: No Calibration Required