



## Certification Test Report

**FCC ID: SK9SNIC1  
IC: 864G-SNIC1**

**FCC Rule Part: 15.247  
ISED Canada Radio Standards Specification: RSS-247**

**Report Number: AT72124916-1C1**

**Manufacturer: Itron, Inc.  
Model: SNIC1**

**Test Begin Date: March 3, 2017  
Test End Date: April 10, 2017**

**Report Issue Date: July 11, 2017**



FOR THE SCOPE OF ACCREDITATION UNDER Certificate Number: AT-2021

This report must not be used by the client to claim product certification, approval, or endorsement by ANAB, NIST, or any agency of the Federal Government.

**Prepared by:**

**Ryan McGann  
Senior Engineer  
TÜV SÜD America Inc.**

**Reviewed by:**

**Thierry Jean-Charles  
EMC Engineer  
TÜV SÜD America Inc.**

This test report shall not be reproduced except in full. This report may be reproduced in part with prior written consent of TÜV SÜD America Inc. The results contained in this report are representative of the sample(s) submitted for evaluation.

**This report contains 40 pages**

# TABLE OF CONTENTS

<b>1</b>	<b>GENERAL</b> .....	<b>3</b>
1.1	PURPOSE.....	3
1.2	PRODUCT DESCRIPTION .....	3
1.3	TEST METHODOLOGY AND CONSIDERATIONS .....	4
<b>2</b>	<b>TEST FACILITIES</b> .....	<b>5</b>
2.1	LOCATION .....	5
2.2	LABORATORY ACCREDITATIONS/RECOGNITIONS/CERTIFICATIONS .....	5
2.3	RADIATED EMISSIONS TEST SITE DESCRIPTION .....	6
2.3.1	<i>Semi-Anechoic Chamber Test Site</i> .....	6
2.3.2	<i>Open Area Tests Site (OATS)</i> .....	7
2.4	CONDUCTED EMISSIONS TEST SITE DESCRIPTION.....	8
<b>3</b>	<b>APPLICABLE STANDARD REFERENCES</b> .....	<b>8</b>
<b>4</b>	<b>LIST OF TEST EQUIPMENT</b> .....	<b>9</b>
<b>5</b>	<b>SUPPORT EQUIPMENT</b> .....	<b>10</b>
<b>6</b>	<b>EQUIPMENT UNDER TEST SETUP BLOCK DIAGRAM</b> .....	<b>11</b>
<b>7</b>	<b>SUMMARY OF TESTS</b> .....	<b>12</b>
7.1	ANTENNA REQUIREMENT – FCC: SECTION 15.203.....	12
7.2	POWER LINE CONDUCTED EMISSIONS – FCC: SECTION 15.207; ISED CANADA: RSS-GEN 8.8 .....	12
7.2.1	<i>Measurement Procedure</i> .....	12
7.2.2	<i>Measurement Results</i> .....	12
7.3	PEAK OUTPUT POWER – FCC: SECTION 15.247(B)(2); ISED CANADA: RSS-247 5.4(A).....	14
7.3.1	<i>Measurement Procedure</i> .....	14
7.3.2	<i>Measurement Results</i> .....	14
7.4	CHANNEL USAGE REQUIREMENTS.....	15
7.4.1	<i>Carrier Frequency Separation – FCC: Section 15.247(a)(1); ISED Canada: RSS-247 5.1(b)</i> .....	15
7.4.1.1	<i>Measurement Procedure</i> .....	15
7.4.1.2	<i>Measurement Results</i> .....	16
7.4.2	<i>Number of Hopping Channels – FCC: Section 15.247(a)(1)(i); ISED Canada: RSS-247 5.1(c)</i> ...	17
7.4.2.1	<i>Measurement Procedure</i> .....	17
7.4.2.2	<i>Measurement Results</i> .....	18
7.4.3	<i>Channel Dwell Time – FCC: Section 15.247(a)(1)(i); ISED Canada: RSS-247 5.1(c)</i> .....	19
7.4.3.1	<i>Measurement Procedure</i> .....	19
7.4.4	<i>20dB / 99% Bandwidth – FCC: Section 15.247(a)(1)(i); ISED Canada: RSS-247 5.1(c)</i> .....	20
7.4.4.1	<i>Measurement Procedure</i> .....	20
7.4.4.2	<i>Measurement Results</i> .....	20
7.5	BAND-EDGE COMPLIANCE AND SPURIOUS EMISSIONS.....	27
7.5.1	<i>Band-Edge Compliance of RF Conducted Emissions – FCC: Section 15.247(d); ISED Canada: RSS-247 5.5</i> .....	27
7.5.1.1	<i>Measurement Procedure</i> .....	27
7.5.1.2	<i>Measurement Results</i> .....	27
7.5.2	<i>RF Conducted Spurious Emissions – FCC: Section 15.247(d); ISED Canada: RSS-247 5.5</i> .....	32
7.5.2.1	<i>Measurement Procedure</i> .....	32
7.5.2.2	<i>Measurement Results</i> .....	32
7.5.3	<i>Radiated Spurious Emissions – FCC: Sections 15.205, 15.209; ISED Canada: RSS-Gen 8.9/8.10</i> ..	36
7.5.3.1	<i>Measurement Procedure</i> .....	36
7.5.3.2	<i>Measurement Results</i> .....	36
7.5.3.3	<i>Sample Calculation:</i> .....	38
<b>8</b>	<b>ESTIMATION OF MEASUREMENT UNCERTAINTY</b> .....	<b>39</b>
<b>9</b>	<b>CONCLUSION</b> .....	<b>40</b>

## 1 GENERAL

### 1.1 Purpose

The purpose of this report is to demonstrate compliance with Part 15 Subpart C of the FCC's Code of Federal Regulations and Innovation, Science, and Economic Development Canada's Radio Standards Specification RSS-247 Certification for modular approval.

### 1.2 Product description

The Itron Smart Network Interface Card (model: SNIC1) module is built on Itron's IPv6 OpenWay platform, and includes the Adaptive Communications Technology (ACT). It can process, analyze, communicate and react in real-time. Adaptive communications enable devices to interact with each other while dynamically switching between Radio Frequency (RF) and Power Line Carrier (PLC) to ensure the fastest and most reliable communications path. The communication module utilizes 900 MHz radio frequency (RF), power line carrier (carrier current system) and 2.4 GHz Wi-Fi operation bands.

This test report documents the compliance of the 900 MHz transceiver frequency hopping spread spectrum mode of operation.

Technical Details:

Detail	Description
Frequency Range	902.4 – 927.6 MHz
Number of Channels	64
Modulation Format	FSK, OFDM, DSSS
Data Rates	FSK: 50kbps, 150kbps OFDM: 200kbps, 600kbps DSSS: 6.25kbps, 12.5kbps
Operating Voltage	24Vdc
Antenna Type(s) / Gain(s)	Micro Strip Patch Antenna / 2.5 dBi

Manufacturer Information:

Itron, Inc.  
313 N Hwy 11  
West Union, SC 29696

EUT Serial Numbers: Radiated Emissions (FSK 150k, OFDM, DSSS): #1  
Radiated Emissions (FSK 50k): #4  
Power Line Conducted Emissions: #2  
RF Conducted Emissions (FSK 50k): #5  
RF Conducted Emissions (FSK 50k): #7

Test Sample Condition: The test samples were provided in good working order with no visible defects.

### 1.3 Test Methodology and Considerations

All modes of operation, including all available data rates, were evaluated for each mode. The data presented in this report represents the worst case where applicable. A single test sample was not capable of supporting all modulation formats for test mode, therefore multiple samples were used to evaluate the compliance of all available modulation formats.

For radiated emissions, the EUT was evaluated in three orthogonal orientations. The worst-case orientation was the Z-orientation. See test setup photos for more information. All data rates were evaluated for worst case operation for each modulation format. The worst-case data rates evaluated were FSK 50kbps, FSK 150kbps, OFDM 600kbps, and DSSS 6.25kbps.

For AC power line conducted emissions the EUT was evaluated with a typical host power supply.

For RF conducted emissions, the EUT was modified with a temporary SMA connector for coupling to the measurement equipment.

Radiated inter-modulation testing was performed for all combinations of simultaneous transmission and found to comply.

Power setting during test – FSK 50kbps:	-4
Power setting during test – FSK 150kbps:	-3
Power setting during test – OFDM:	-2
Power setting during test – DSSS:	-2

## 2 TEST FACILITIES

### 2.1 Location

The radiated and conducted emissions test sites are located at the following address:

TÜV SÜD America, Inc.  
5015 B.U. Bowman Drive  
Buford, GA 30518  
Phone: (770) 831-8048  
Fax: (770) 831-8598

### 2.2 Laboratory Accreditations/Recognitions/Certifications

TÜV SÜD America, Inc. is accredited to ISO/IEC 17025 by the ANSI-ASQ National Accreditation Board/ANAB accreditation program, and has been issued certificate number AT-2021 in recognition of this accreditation. Unless otherwise specified, all tests methods described within this report are covered under the ISO/IEC 17025 scope of accreditation.

The Semi-Anechoic Chamber Test Site, Open Area Test Site (OATS) and Conducted Emissions Site have been fully described, submitted to, and accepted by the FCC, Innovation, Science, and Economic Development Canada and the Japanese Voluntary Control Council for Interference by information technology equipment.

FCC Registration Number: 391271

Innovation, Science, and Economic Development Canada Lab Code: IC 4175A

VCCI Member Number: 1831

- VCCI OATS Registration Number R-1526
- VCCI Conducted Emissions Site Registration Number: C-1608

## 2.3 Radiated Emissions Test Site Description

### 2.3.1 Semi-Anechoic Chamber Test Site

The Semi-Anechoic Chamber Test Site consists of a 20' x 30' x 18' shielded enclosure. The chamber is lined with Toyo Ferrite Grid Absorber, model number FFG-1000. The ferrite tile grid is 101 x 101 x 19mm thick and weighs approximately 550 grams. These tiles are mounted on steel panels and installed directly on the inner walls of the chamber.

The turntable is 150cm in diameter and is located 160cm from the back wall of the chamber. The chamber is grounded via 1 – 8' copper ground rod, installed at the center of the back wall, it is bound to the ground plane using 3/4" stainless steel braided cable.

The turntable is all steel, flush mounted table installed in an all steel frame. The table is remotely operated from inside the control room located 25' from the range. The turntable is electrically bonded to the surrounding ground plane via steel fingers installed on the edge of the turn table. The steel fingers make constant contact with the ground plane during operation.

Behind the turntable is a 3' x 6' x 4' deep shielded pit used for support equipment if necessary. The pit is equipped with 1 – 4" PVC chases from the turntable to the pit that allow for cabling to the EUT if necessary. The underside of the turntable can be accessed from the pit so cables can be supplied to the EUT from the pit.

A diagram of the Semi-Anechoic Chamber Test Site is shown in Figure 2.3-1 below:

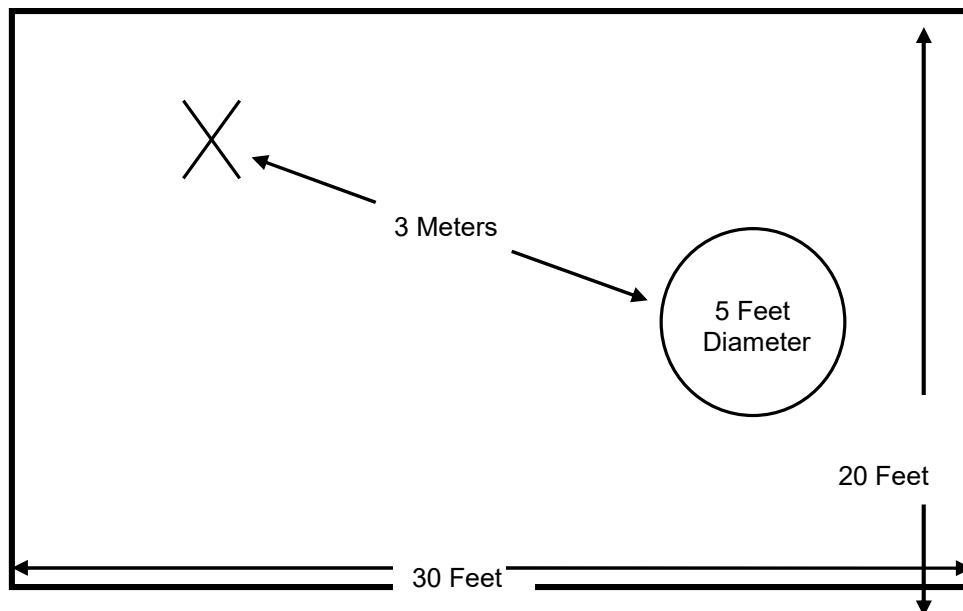

Figure 2.3-1: Semi-Anechoic Chamber Test Site

### 2.3.2 Open Area Tests Site (OATS)

The open area test site consists of a 40' x 66' concrete pad covered with a perforated electro-plated galvanized sheet metal. The perforations in the sheet metal are 1/8" holes that are staggered every 3/16". The individual sheets are placed to overlap each other by 1/4" and are riveted together to provide a continuous seam. Rivets are spaced every 3" in a 3 x 20 meter perimeter around the antenna mast and EUT area. Rivets in the remaining area are spaced as necessary to properly secure the ground plane and maintain the electrical continuity.

The entire ground plane extends 12' beyond the turntable edge and 16' beyond the antenna mast when set to a 10 meter measurement distance. The ground plane is grounded via 4 – 8' copper ground rods, each installed at a corner of the ground plane and bound to the ground plane using 3/4" stainless steel braided cable.

The turntable is an all aluminum 10' flush mounted table installed in an all aluminum frame. The table is remotely operated from inside the control room located 40' from the range. The turntable is electrically bonded to the surrounding ground plane via steel fingers installed on the edge of the turn table. The steel fingers make constant contact with the ground plane during operation.

Adjacent to the turntable is a 7' x 7' square and 4' deep concrete pit used for support equipment if necessary. The pit is equipped with 5 – 4" PVC chases from the pit to the control room that allow for cabling to the EUT if necessary. The underside of the turntable can be accessed from the pit so cables can be supplied to the EUT from the pit. The pit is covered with 2 sheets of 1/4" diamond style re-enforced steel sheets. The sheets are painted to match the perforated steel ground plane; however the underside edges have been masked off to maintain the electrical continuity of the ground plane. All reflecting objects are located outside of the ellipse defined in ANSI C63.4.

A diagram of the Open Area Test Site is shown in Figure 2.3-2 below:

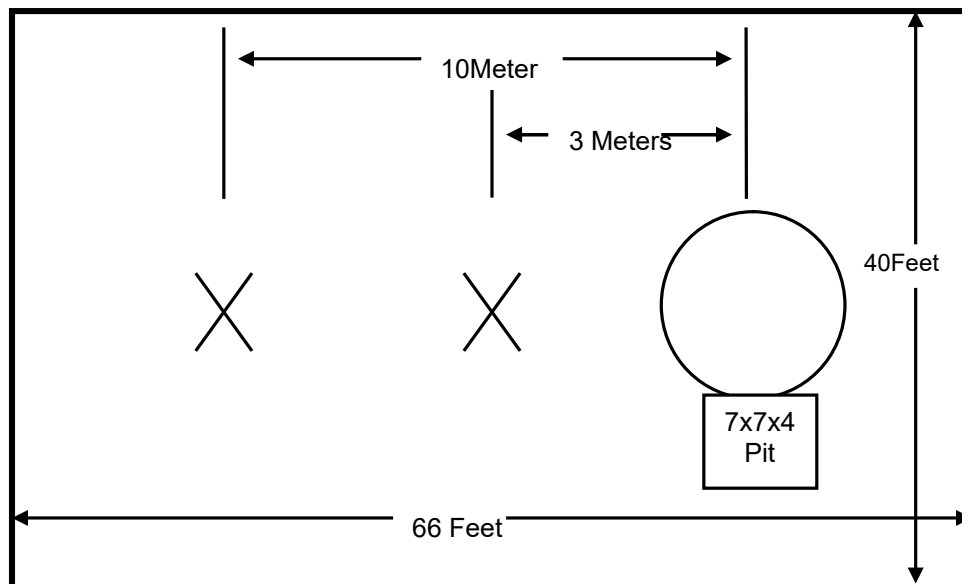

Figure 2.3-2: Open Area Test Site

## 2.4 Conducted Emissions Test Site Description

The AC mains conducted EMI site is located in the main EMC lab. It consists of an 8' x 8' solid aluminum horizontal ground reference plane (GRP) bonded every 3" to an 8' X 8' vertical ground plane.

The site is of sufficient size to test table top and floor standing equipment in accordance with ANSI C63.10.

A diagram of the room is shown below in figure 2.4-1:

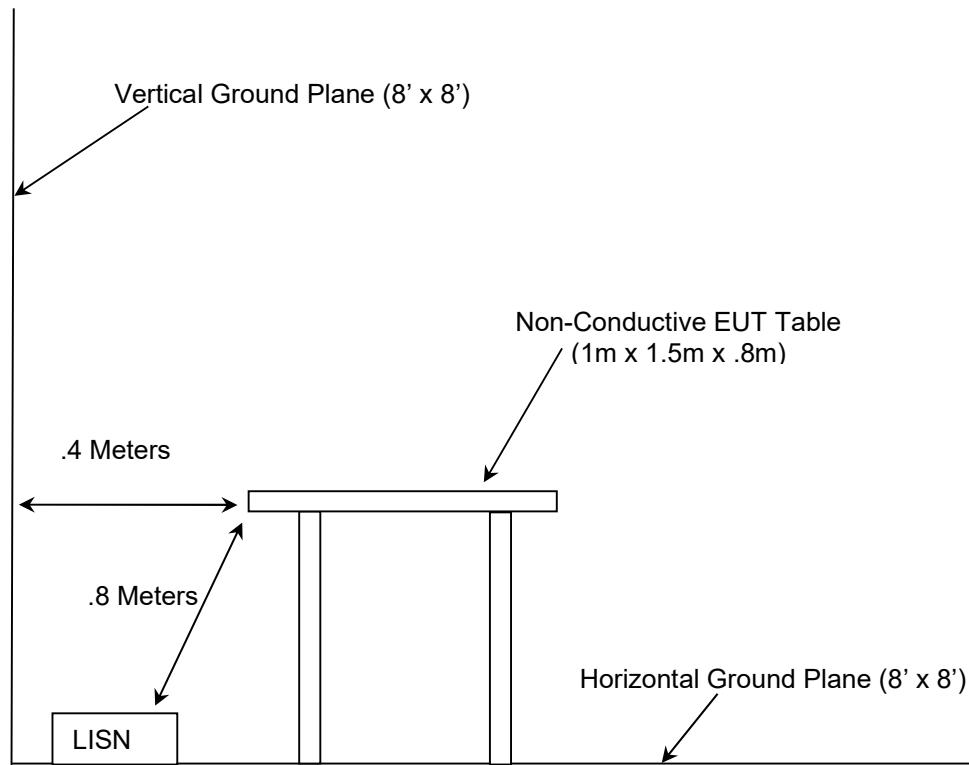

Figure 2.4-1: AC Mains Conducted EMI Site

## 3 APPLICABLE STANDARD REFERENCES

The following standards were used:

- ❖ ANSI C63.4-2014: American National Standard for Methods of Measurement of Radio-Noise Emissions from Low-Voltage Electrical and Electronic Equipment in the Range of 9 kHz to 40 GHz.
- ❖ ANSI C63.10-2013: American National Standard of Procedures for Compliance Testing of Unlicensed Wireless Devices
- ❖ US Code of Federal Regulations (CFR): Title 47, Part 2, Subpart J: Equipment Authorization Procedures, 2017
- ❖ US Code of Federal Regulations (CFR): Title 47, Part 15, Subpart C: Radio Frequency Devices, Intentional Radiators, 2017
- ❖ ISED Canada Radio Standards Specification: RSS-247 – Digital Transmission Systems (DTSs), Frequency Hopping Systems (FHSs) and License-Exempt Local Area Network (LE-LAN) Devices, Issue 2, Feb 2017
- ❖ ISED Canada Radio Standards Specification: RSS-GEN – General Requirements and Information for the Certification of Radiocommunication Equipment, Issue 4, Nov 2014.



#### 4 LIST OF TEST EQUIPMENT

The calibration interval of test equipment is annually or the manufacturer's recommendations. Where the calibration interval deviates from the annual cycle based on the instrument manufacturer's recommendations, it shall be stated below.

**Table 4-1: Test Equipment**

AssetID	Manufacturer	Model #	Equipment Type	Serial #	Last Calibration Date	Calibration Due Date
30	Spectrum Technologies	DRH-0118	Antennas	970102	4/30/2015	4/30/2017
40	EMCO	3104	Antennas	3211	6/8/2016	6/8/2018
73	Agilent	8447D	Amplifiers	2727A05624	7/21/2016	7/21/2017
167	ACS	Hammer EMI Cable S	Cable Set	167	9/30/2016	9/30/2017
267	Agilent	N1911A	Meters	MY45100129	8/24/2015	8/24/2017
268	Agilent	N1911A	Meters	MY45100129	8/13/2015	8/13/2017
324	ACS	Belden	Cables	8214	5/2/2016	5/2/2017
331	Microwave Circuits	H1G513G1	Filters	31417	5/13/2016	5/13/2017
338	Hewlett Packard	8449B	Amplifiers	3008A01111	8/21/2015	8/21/2017
340	Aeroflex/Weinschel	AS-20	Attenuators	7136	7/12/2016	7/12/2017
412	Electro Metrics	LPA-25	Antennas	1241	8/8/2016	8/8/2018
422	Florida RF	SMS-200AW-72.0-SMR	Cables	805	10/27/2016	10/27/2017
616	Florida RF Cables	SMRE-200W-12.0-SMRE	Cables	N/A	9/2/2016	9/2/2017
622	Rohde & Schwarz	FSV40	Analyzers	101338	7/15/2016	7/15/2018
676	Florida RF Labs	SMS-290AW-480.0-SMS	Cables	MFR2Y194	11/4/2016	11/4/2017
3010	Rohde & Schwarz	ENV216	LISN	3010	7/11/2016	7/11/2017
RE135	Rohde & Schwarz	FSP30	Spectrum Analyzers	835618/031	10/31/2016	10/31/2017
RE619	Rhode & Schwarz	ESU26	Spectrum Analyzers	1302.6005K26 Ser. 100190	11/5/2014	4/5/2017

**NCR = No Calibration Required**

**NOTE: All test equipment was used only during active calibration cycles.**

## 5 SUPPORT EQUIPMENT

Table 5-1: Support Equipment – Radiated Emissions

Item	Equipment Type	Manufacturer	Model/Part Number	Serial Number
1	Power Supply	Itron, Inc.	574294-BRD1	9370057241

Table 5-2: Cable Description – Radiated Emissions

Cable	Cable Type	Length	Shield	Termination
A	DC Power Cable (Twisted)	1.9 m	No	EUT to Power Supply
B	AC Power Cable	1.75 m	No	Power Supply to AC Mains

Table 5-3: Support Equipment – Power Line Conducted Emissions

Item	Equipment Type	Manufacturer	Model/Part Number	Serial Number
1	Power Supply	Itron, Inc.	574294-BRD7	9370057263

Table 5-4: Cable Description – Power Line Conducted Emissions

Cable	Cable Type	Length	Shield	Termination
A	AC Power Cable	1.75 m	No	Power Supply to AC Mains

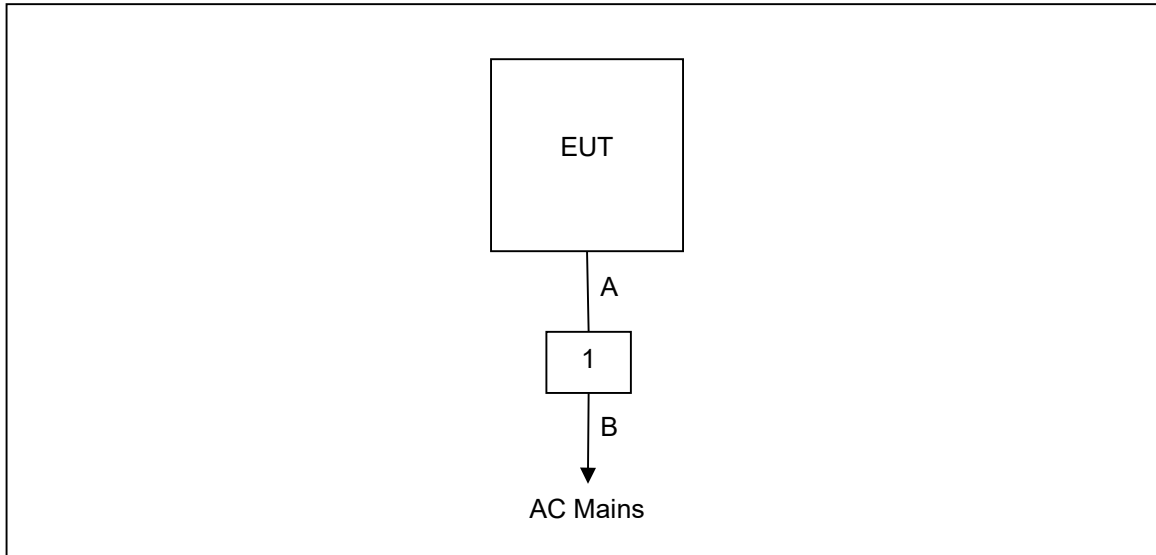
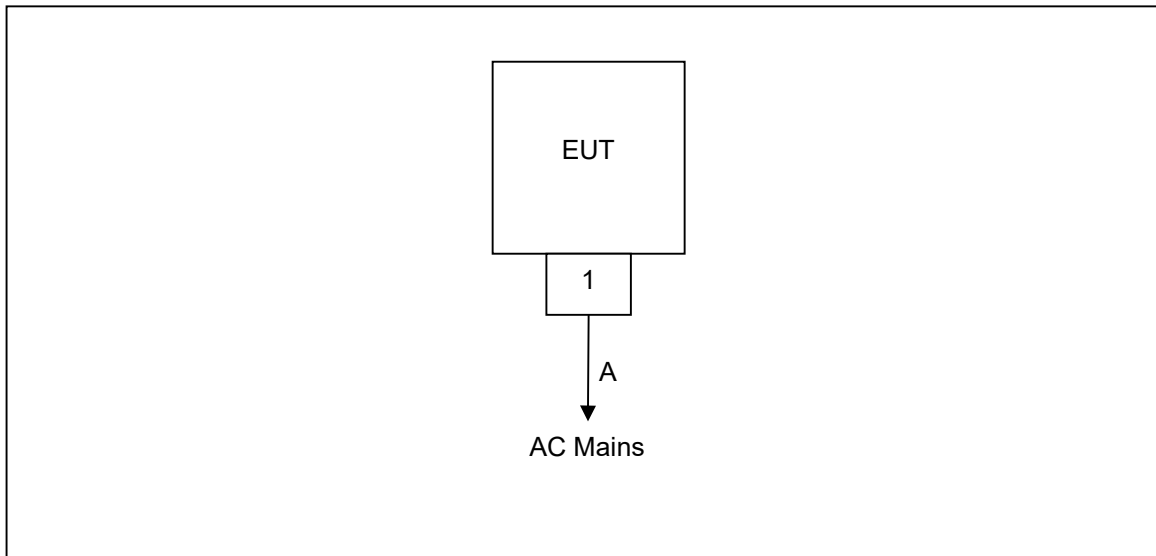
**6 EQUIPMENT UNDER TEST SETUP BLOCK DIAGRAM****Figure 6-1: Test Setup Block Diagram – Radiated Emissions****Figure 6-2: Test Setup Block Diagram – Power Line Conducted Emissions**

## 7 SUMMARY OF TESTS

Along with the tabular data shown below, plots were taken of all signals deemed important enough to document.

### 7.1 Antenna Requirement – FCC: Section 15.203

The EUT utilizes a micro strip patch antenna. The antenna is integral to the device and cannot be removed or replaced by the end user. The gain of the antenna is 2.5 dBi.

### 7.2 Power Line Conducted Emissions – FCC: Section 15.207; ISED Canada: RSS-Gen 8.8

#### 7.2.1 Measurement Procedure

Conducted emissions were performed from 150 kHz to 30 MHz with the spectrum analyzer's resolution bandwidth set to 9 kHz and the video bandwidth set to 30 kHz. The calculation for the conducted emissions is as follows:

$$\text{Corrected Reading} = \text{Analyzer Reading} + \text{LISN Loss} + \text{Cable Loss}$$

$$\text{Margin} = \text{Applicable Limit} - \text{Corrected Reading}$$

#### 7.2.2 Measurement Results

Performed by: Christopher O'Steen

**Table 7.2.2-1: Conducted EMI Results Line 1**

Frequency (MHz)	Corrected Reading		Limit (dBuV)	Margin (dB)	Line	Correction (dB)
	Quasi-Peak (dBuV)	Average (dBuV)				
0.490375	---	37.34	46.16	8.82	L1	9.7
0.490375	44.08	---	56.16	12.08	L1	9.7
0.984375	---	21.34	46.00	24.66	L1	9.7
0.984375	34.38	---	56.00	21.62	L1	9.7
1.374375	---	22.24	46.00	23.76	L1	9.8
1.374375	33.51	---	56.00	22.49	L1	9.8
1.553375	---	20.63	46.00	25.37	L1	9.8
1.553375	33.08	---	56.00	22.92	L1	9.8
1.560250	---	22.07	46.00	23.93	L1	9.8
1.560250	33.20	---	56.00	22.80	L1	9.8
1.655500	---	20.80	46.00	25.20	L1	9.8
1.655500	32.93	---	56.00	23.07	L1	9.8

Table 7.2.2-2: Conducted EMI Results Line 2

Frequency (MHz)	Corrected Reading		Limit (dBuV)	Margin (dB)	Line	Correction (dB)
	Quasi-Peak (dBuV)	Average (dBuV)				
0.493875	---	37.07	46.10	9.03	N	9.7
0.493875	43.91	---	56.10	12.19	N	9.7
4.296834	---	18.64	46.00	27.36	N	9.9
4.296834	36.05	---	56.00	19.95	N	9.9
4.343333	---	17.05	46.00	28.95	N	9.9
4.343333	36.05	---	56.00	19.95	N	9.9
4.476500	---	17.12	46.00	28.88	N	9.9
4.476500	36.50	---	56.00	19.50	N	9.9
4.591166	---	19.11	46.00	26.89	N	9.9
4.591166	36.40	---	56.00	19.60	N	9.9
4.670666	---	16.67	46.00	29.33	N	9.9
4.670666	35.80	---	56.00	20.20	N	9.9

### 7.3 Peak Output Power – FCC: Section 15.247(b)(2); ISED Canada: RSS-247 5.4(a)

#### 7.3.1 Measurement Procedure

The RF output port of the EUT was directly connected to the input of a power meter using suitable attenuation. The device employs > 50 channels at any given time therefore the power is limited to 1 Watt.

#### 7.3.2 Measurement Results

Performed by: Ryan McGann

**Table 7.3.2-1: Maximum Conducted Peak Output Power**

Frequency [MHz]	Level [dBm]	Modulation Format	Data Rate [kbps]
902.4	29.08	FSK	50
915.2	28.81	FSK	50
927.6	28.26	FSK	50
902.4	29.22	FSK	150
915.2	29.19	FSK	150
927.6	28.75	FSK	150
902.4	29.59	OFDM	200
915.2	29.60	OFDM	200
927.6	29.20	OFDM	200
902.4	29.46	OFDM	600
915.2	29.50	OFDM	600
927.6	29.13	OFDM	600
902.4	29.21	DSSS	6.25
915.2	29.14	DSSS	6.25
927.6	28.73	DSSS	6.25
902.4	28.95	DSSS	12.5
915.2	29.08	DSSS	12.5
927.6	28.75	DSSS	12.5

## 7.4 Channel Usage Requirements

### 7.4.1 Carrier Frequency Separation – FCC: Section 15.247(a)(1); ISED Canada: RSS-247 5.1(b)

#### 7.4.1.1 Measurement Procedure

The RF output port of the EUT was directly connected to the input of the spectrum analyzer using suitable attenuation. The span of the spectrum analyzer was set wide enough to capture two adjacent peaks. The RBW was set to approximately 30 % of the channel spacing and adjusted as necessary to best identify the center of each channel. The VBW was set > RBW.

### 7.4.1.2 Measurement Results

Performed by: Ryan McGann

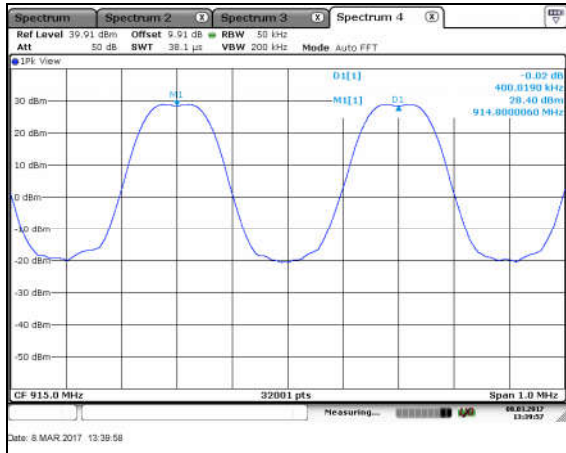

Figure 7.4.1.2-1: Freq. Separation – FSK – 50kbps

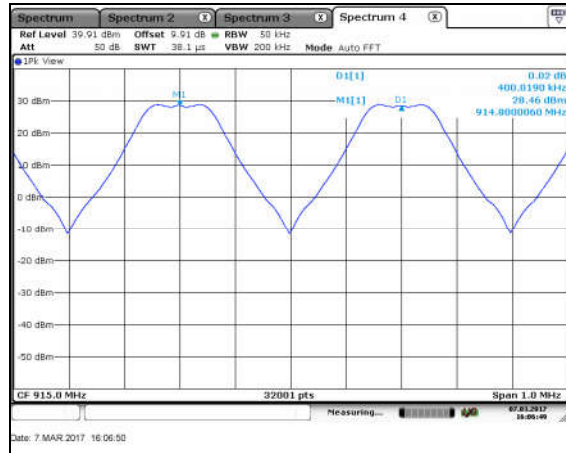

Figure 7.4.1.2-2: Freq. Separation – FSK – 150kbps

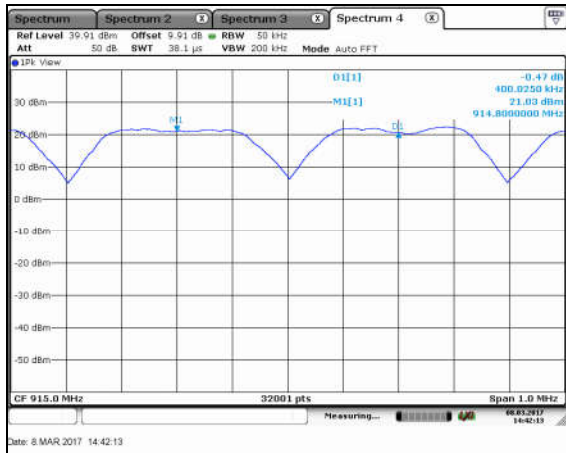

Figure 7.4.1.2-3: Freq. Separation – OFDM – 200kbps

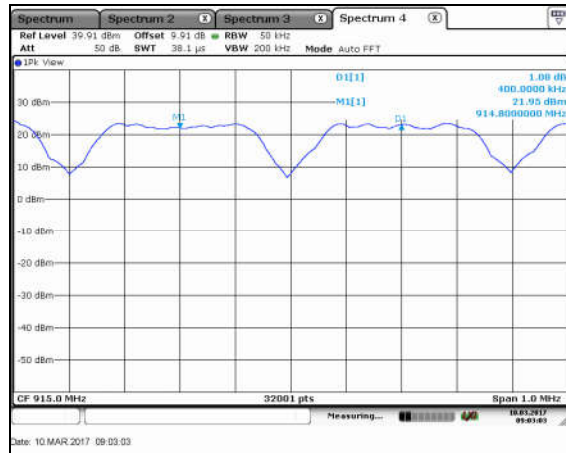

Figure 7.4.1.2-4: Freq. Separation – OFDM – 600kbps

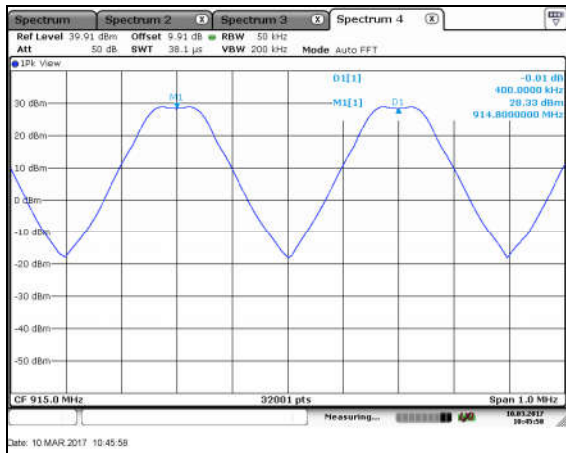

Figure 7.4.1.2-5: Freq. Separation – DSSS – 6.25kbps

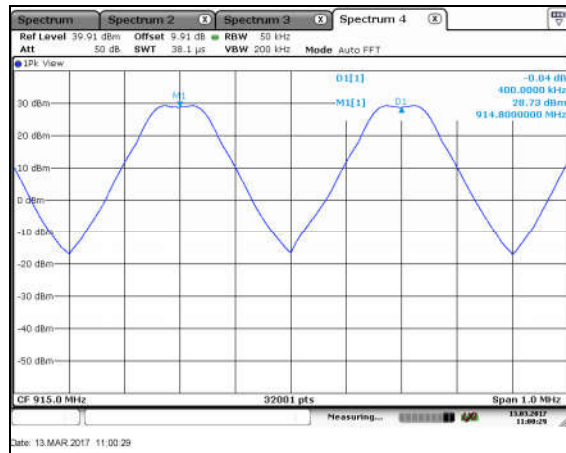

Figure 7.4.1.2-6: Freq. Separation – DSSS – 12.5kbps



#### 7.4.2 Number of Hopping Channels – FCC: Section 15.247(a)(1)(i); ISED Canada: RSS-247 5.1(c)

##### 7.4.2.1 Measurement Procedure

The RF output port of the EUT was directly connected to the input of the spectrum analyzer using suitable attenuation. The span of the spectrum analyzer was set wide enough to capture the frequency band of operation. The RBW was set to < 30 % of the channel spacing and VBW set to  $\geq$  RBW.

### 7.4.2.2 Measurement Results

Performed by: Ryan McGann

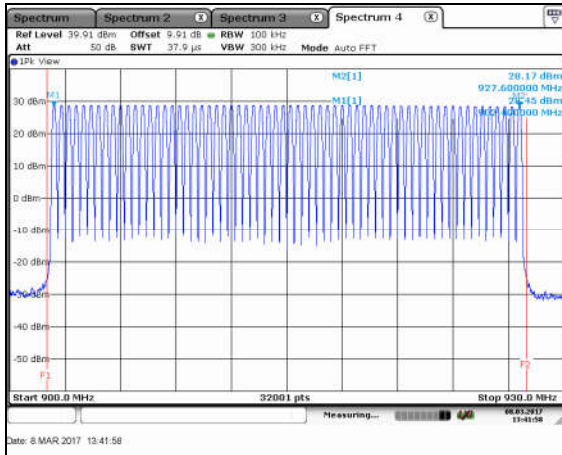

Figure 7.4.2.2-1: No. of Hopping Ch – FSK – 50kbps

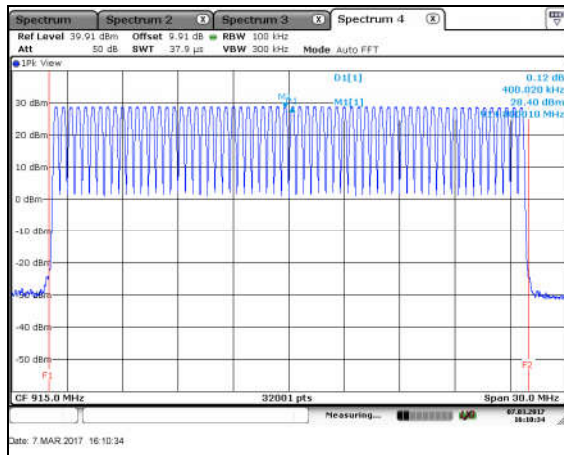

Figure 7.4.2.2-2: No. of Hopping Ch – FSK – 150kbps

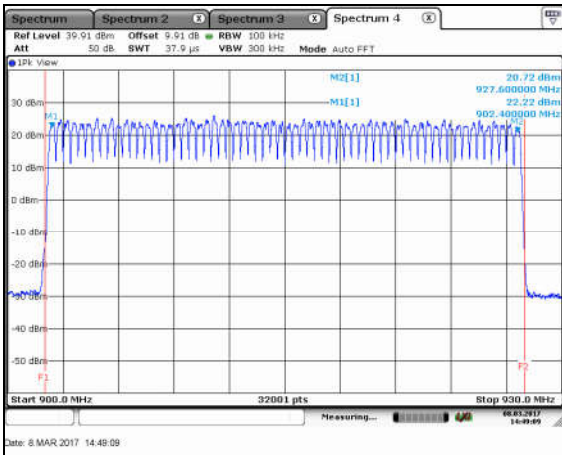

Figure 7.4.2.2-3: No. of Hopping Ch – OFDM – 200kbps

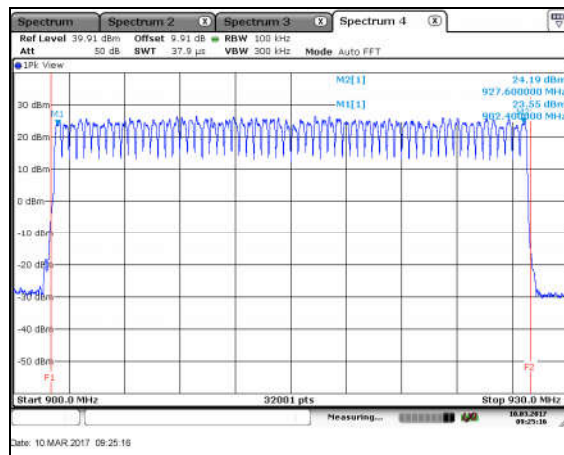

Figure 7.4.2.2-4: No. of Hopping Ch – OFDM – 600kbps

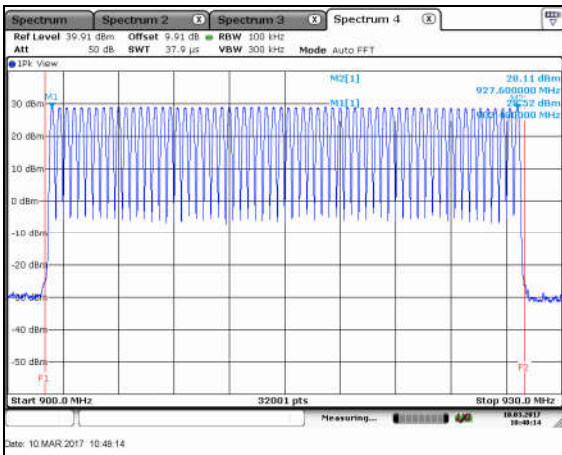

Figure 7.4.2.2-5: No. of Hopping Ch – DSSS – 6.25kbps

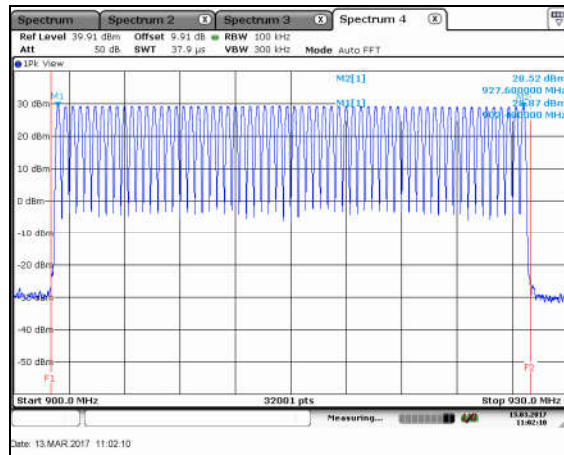

Figure 7.4.2.2-6: No. of Hopping Ch – DSSS – 12.5kbps

**7.4.3 Channel Dwell Time – FCC: Section 15.247(a)(1)(i); ISED Canada: RSS-247 5.1(c)****7.4.3.1 Measurement Procedure**

The EUT was not capable of producing a worst-case channel dwell time. A detailed analysis of the channel dwell time is available in the Theory of Operations accompanying this report.

**7.4.4 20dB / 99% Bandwidth – FCC: Section 15.247(a)(1)(i); ISED Canada: RSS-247 5.1(c)****7.4.4.1 Measurement Procedure**

The RF output port of the EUT was directly connected to the input of the spectrum analyzer using suitable attenuation. The span of the spectrum analyzer display was set between two times and five times the occupied bandwidth (OBW) of the emission. The RBW of the spectrum analyzer was set to approximately 1 % to 5 % of the OBW. The trace was set to max hold with a peak detector active. The marker delta and ndB down measurement functions of the analyzer were utilized to determine the 20 dB bandwidth of the emission.

The occupied bandwidth measurement function of the spectrum analyzer was used to measure the 99% bandwidth. The span of the analyzer was set to capture all products of the modulation process, including the emission sidebands. The resolution bandwidth was set to 1 % to 5 % of the occupied bandwidth. The video bandwidth was set to 3 times the resolution bandwidth. A peak detector was used.

**7.4.4.2 Measurement Results**

Performed by: Ryan McGann

**Table 7.4.4.2-1: 20dB / 99% Bandwidth**

Frequency [MHz]	20dB Bandwidth [kHz]	99% Bandwidth [kHz]	Modulation Format	Data Rate [kbps]
902.4	91.53	85.96	FSK	50
915.2	91.27	85.81	FSK	50
927.6	91.29	86.13	FSK	50
902.4	177.12	154.09	FSK	150
915.2	177.96	154.92	FSK	150
927.6	178.42	154.39	FSK	150
902.4	372.99	304.12	OFDM	200
915.2	374.15	303.68	OFDM	200
927.6	361.30	306.65	OFDM	200
902.4	359.15	309.96	OFDM	600
915.2	364.90	299.58	OFDM	600
927.6	367.24	304.62	OFDM	600
902.4	126.56	111.11	DSSS	6.25
915.2	126.32	110.89	DSSS	6.25
927.6	126.81	110.79	DSSS	6.25
902.4	128.76	112.67	DSSS	12.5
915.2	126.90	112.11	DSSS	12.5
927.6	128.53	111.86	DSSS	12.5

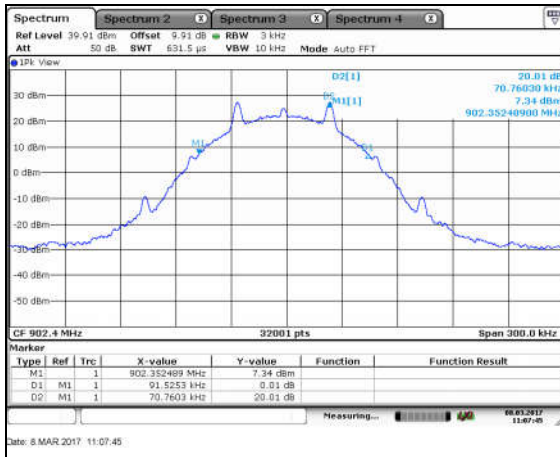

Figure 7.4.4.2-1: 20dB BW Low Ch – FSK – 50kbps

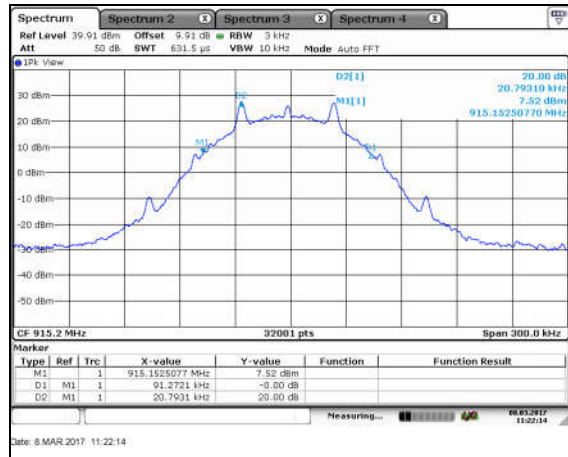

Figure 7.4.4.2-2: 20dB BW Mid Ch – FSK – 50kbps

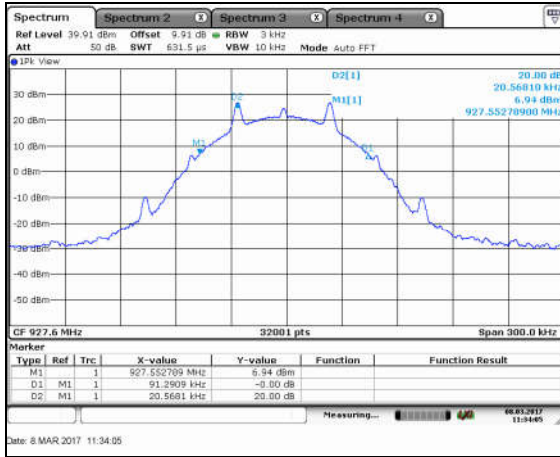

Figure 7.4.4.2-3: 20dB BW High Ch – FSK – 50kbps



Figure 7.4.4.2-4: 99% BW Low Ch – FSK – 50kbps

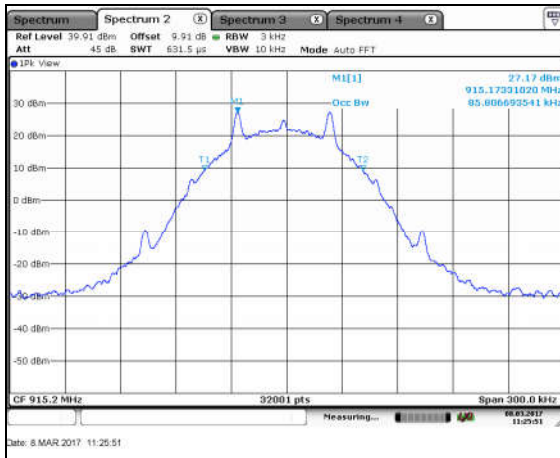

Figure 7.4.4.2-5: 99% BW Mid Ch – FSK – 50kbps

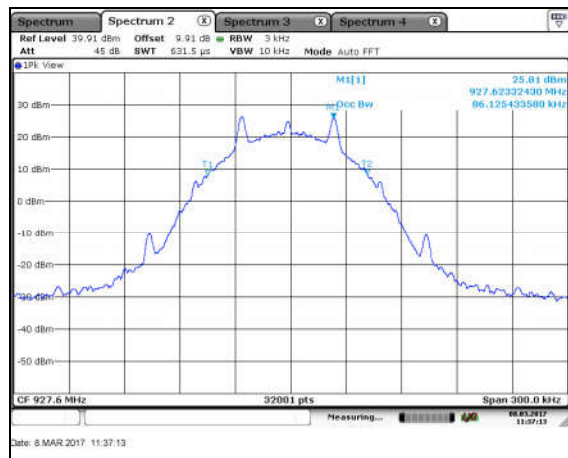

Figure 7.4.4.2-6: 99% BW High Ch – FSK – 50kbps

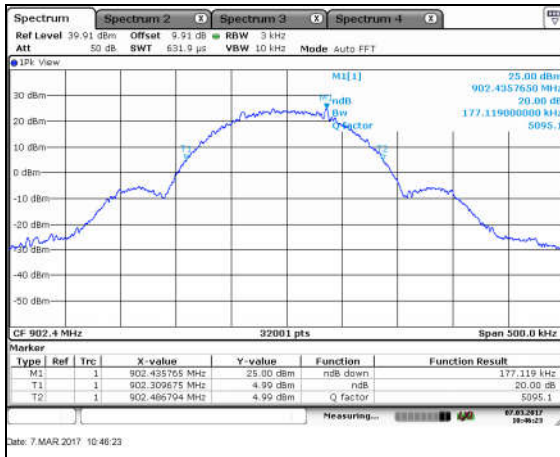

Figure 7.4.4.2-7: 20dB BW Low Ch – FSK – 150kpbs

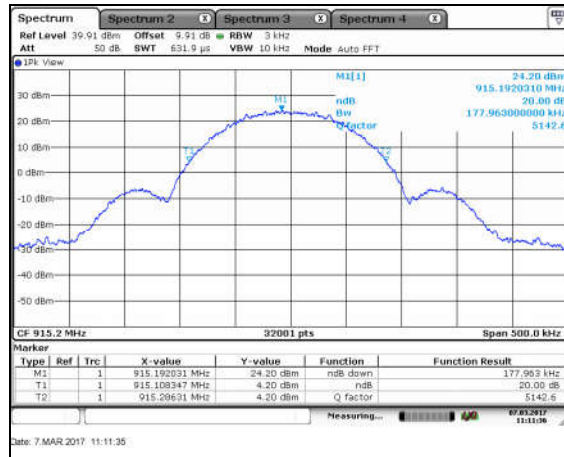

Figure 7.4.4.2-8: 20dB BW Mid Ch – FSK – 150kpbs

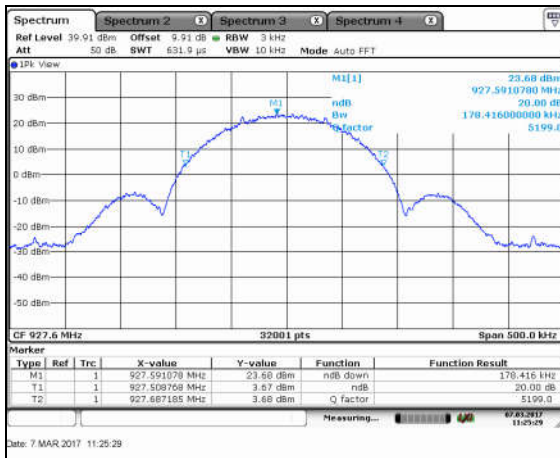

Figure 7.4.4.2-9: 20dB BW High Ch – FSK – 150kpbs

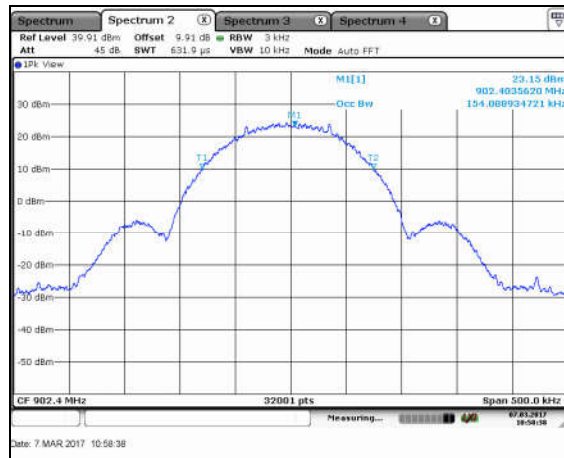

Figure 7.4.4.2-10: 99% BW Low Ch – FSK – 150kpbs

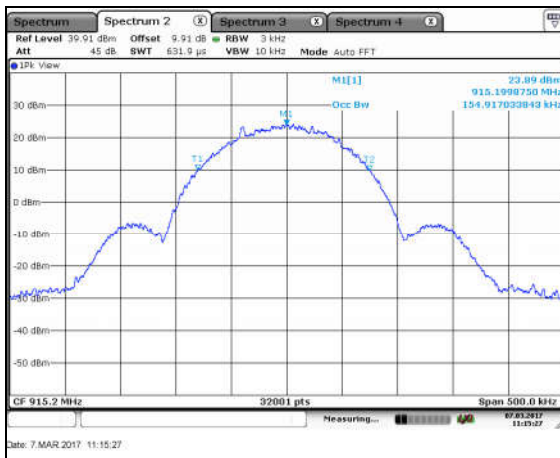

Figure 7.4.4.2-11: 99% BW Mid Ch – FSK – 150kpbs

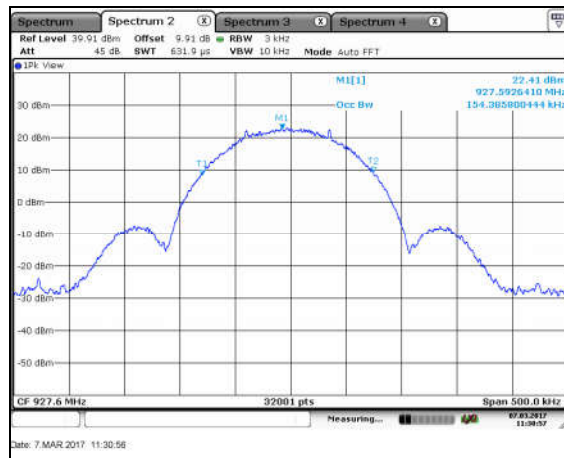

Figure 7.4.4.2-12: 99% BW High Ch – FSK – 150kpbs

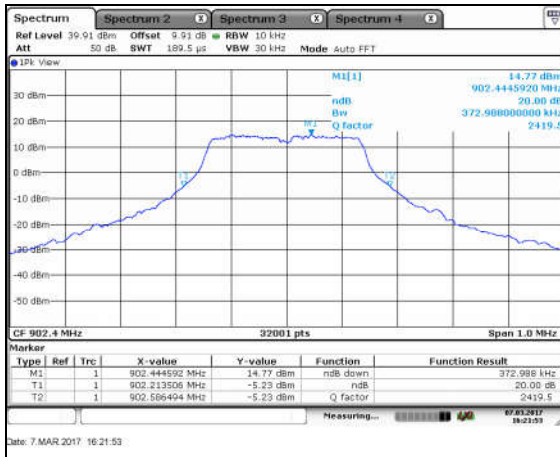

Figure 7.4.4.2-13: 20dB BW Low Ch – OFDM – 200kpbs

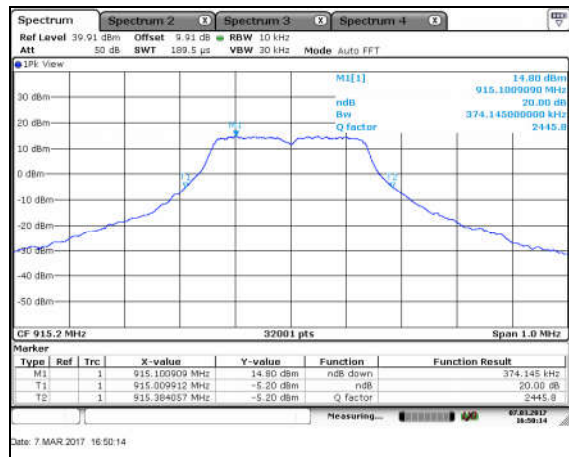

Figure 7.4.4.2-14: 20dB BW Mid Ch – OFDM – 200kpbs

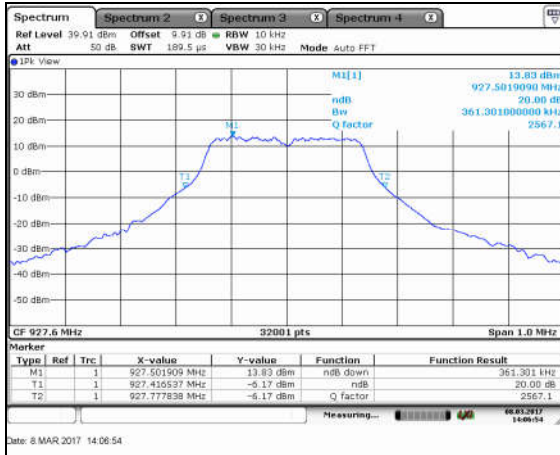

Figure 7.4.4.2-15: 20dB BW High Ch – OFDM – 200kpbs



Figure 7.4.4.2-16: 99% BW Low Ch – OFDM – 200kpbs

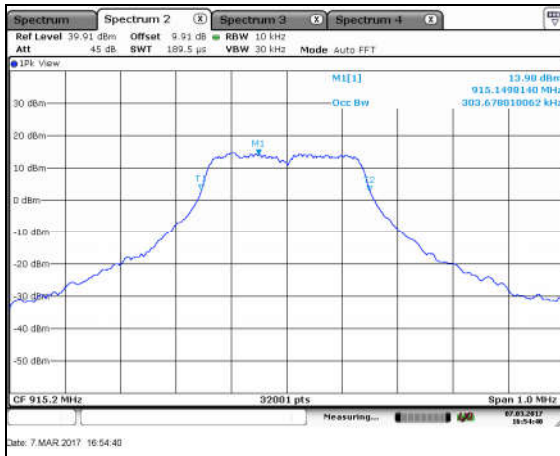

Figure 7.4.4.2-17: 99% BW Mid Ch – OFDM – 200kpbs

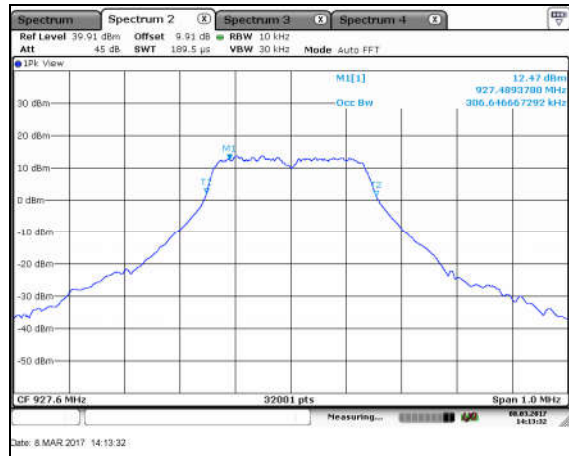

Figure 7.4.4.2-18: 99% BW High Ch – OFDM – 200kpbs

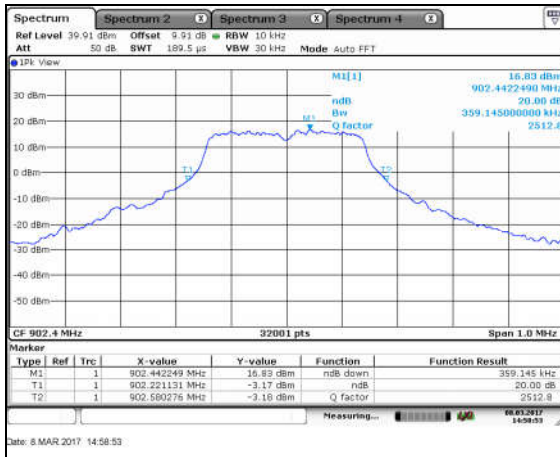

Figure 7.4.4.2-19: 20dB BW Low Ch – OFDM – 600kpbs

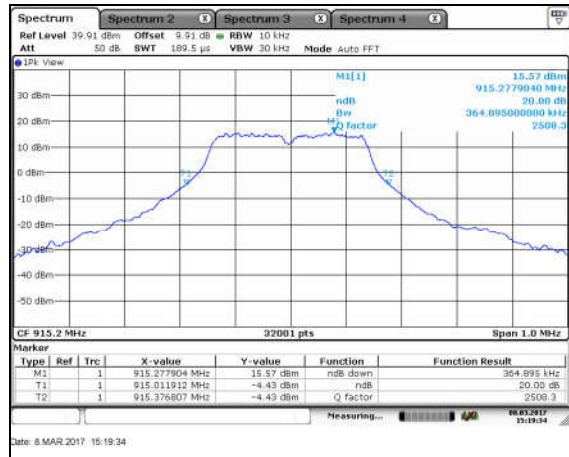

Figure 7.4.4.2-20: 20dB BW Mid Ch – OFDM – 600kpbs

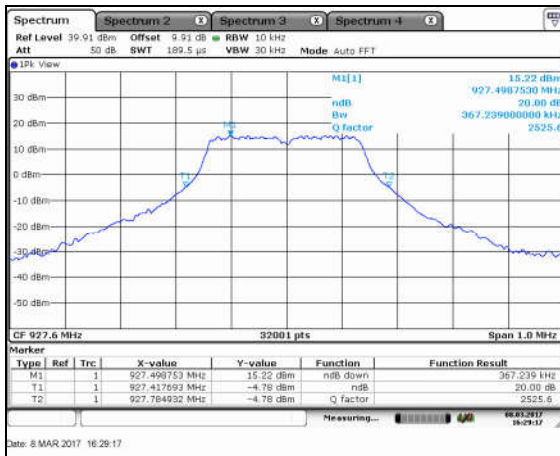

Figure 7.4.4.2-21: 20dB BW High Ch – OFDM – 600kpbs

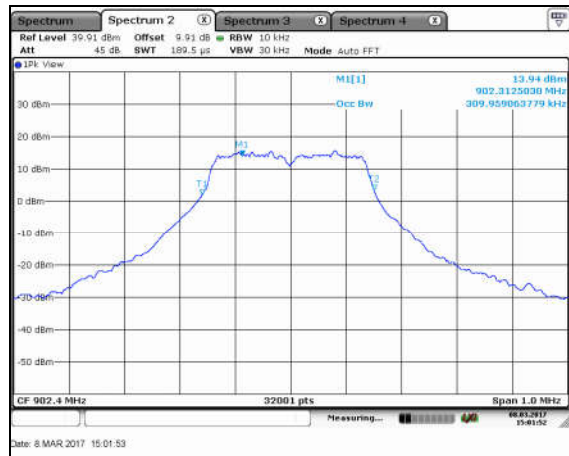

Figure 7.4.4.2-22: 99% BW Low Ch – OFDM – 600kpbs

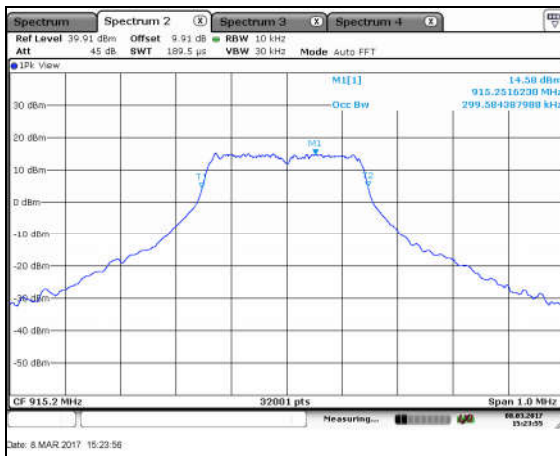

Figure 7.4.4.2-23: 99% BW Mid Ch – OFDM – 600kpbs

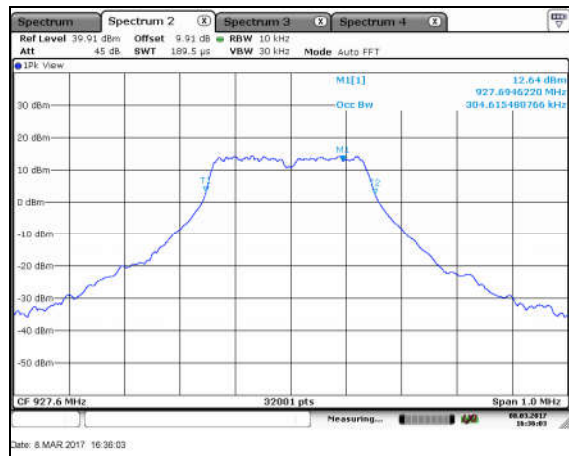

Figure 7.4.4.2-24: 99% BW High Ch – OFDM – 600kpbs



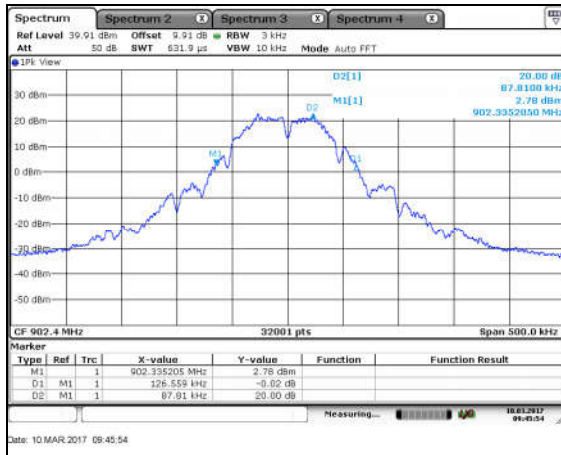

Figure 7.4.4.2-25: 20dB BW Low Ch – DSSS – 6.25kbps

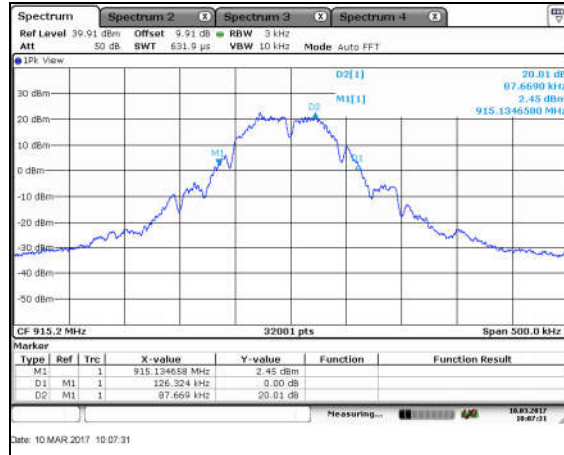

Figure 7.4.4.2-26: 20dB BW Mid Ch – DSSS – 6.25kbps

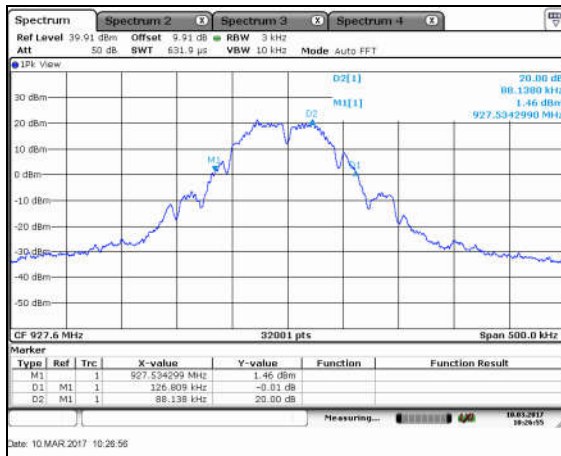

Figure 7.4.4.2-27: 20dB BW High Ch – DSSS – 6.25kbps

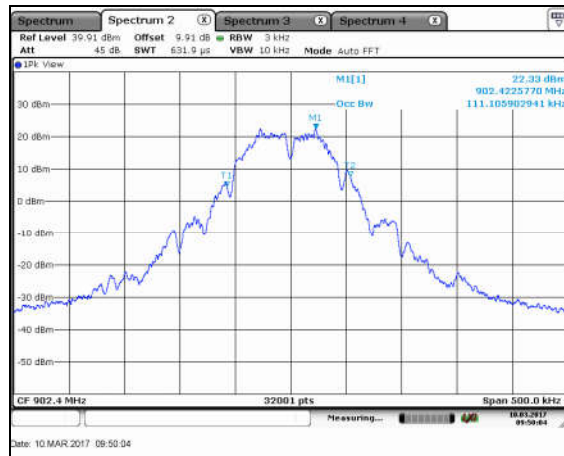

Figure 7.4.4.2-28: 99% BW Low Ch – DSSS – 6.25kbps

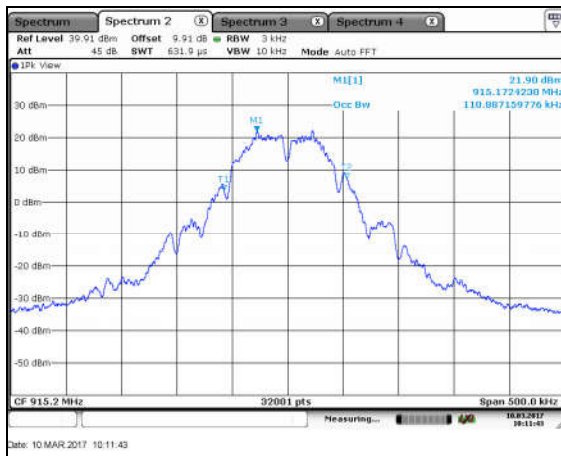

Figure 7.4.4.2-29: 99% BW Mid Ch – DSSS – 6.25kbps

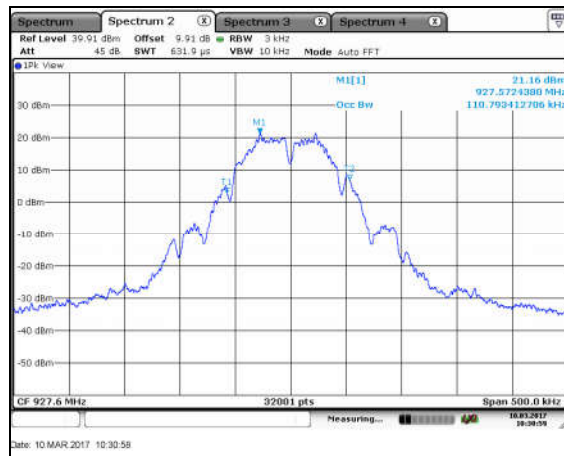
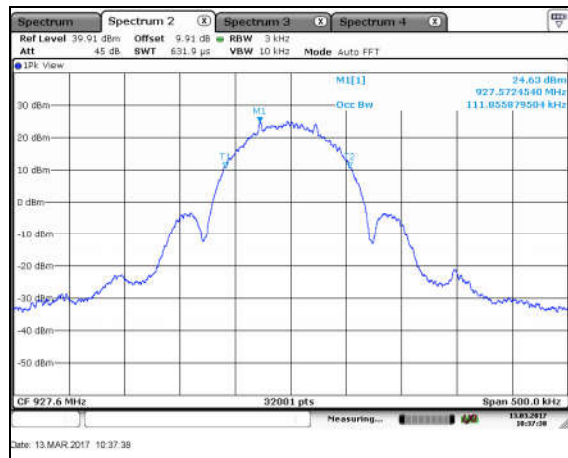
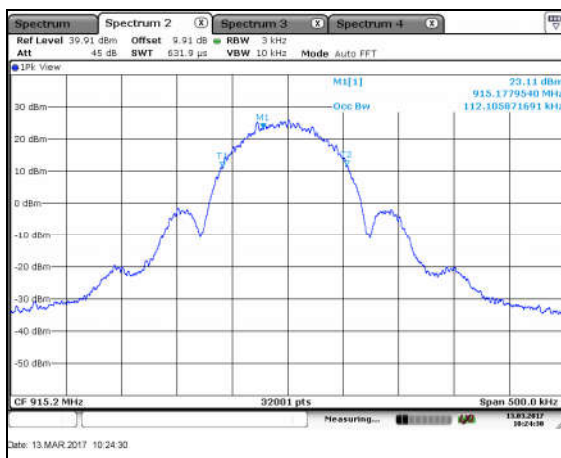
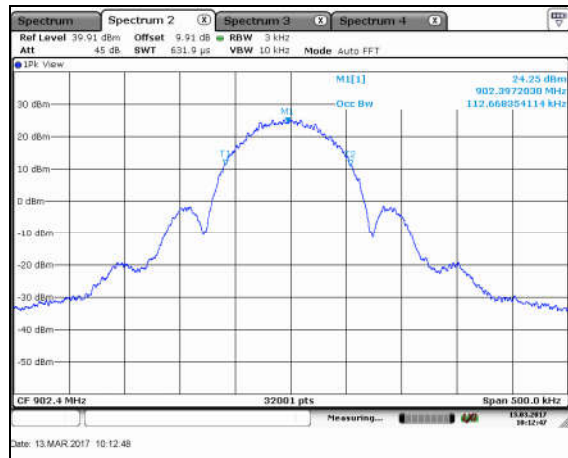
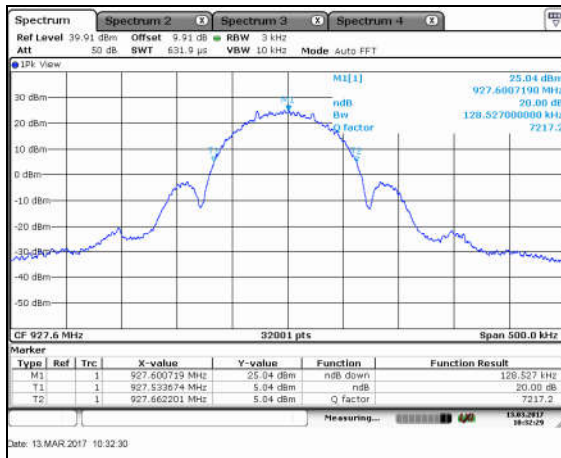
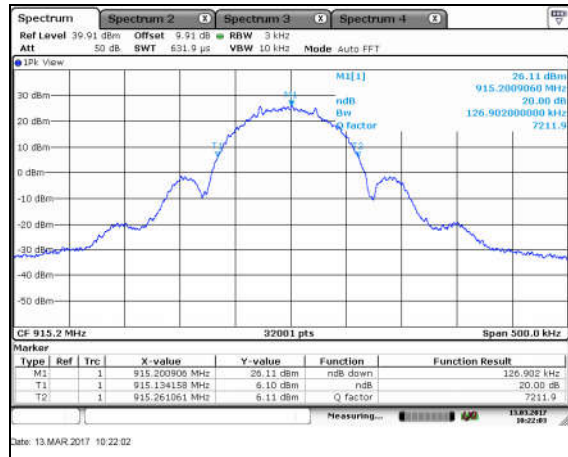
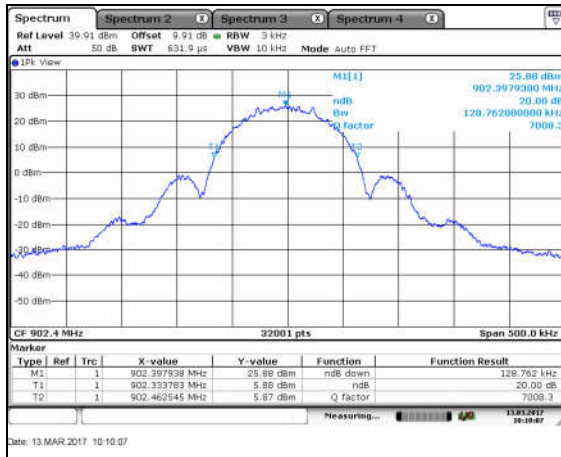

Figure 7.4.4.2-30: 99% BW High Ch – DSSS – 6.25kbps



## 7.5 Band-Edge Compliance and Spurious Emissions

### 7.5.1 Band-Edge Compliance of RF Conducted Emissions – FCC: Section 15.247(d); ISED Canada: RSS-247 5.5

#### 7.5.1.1 Measurement Procedure

The RF output port of the EUT was directly connected to the input of the spectrum analyzer using suitable attenuation. The EUT was investigated at the lowest and highest channel available to determine band-edge compliance. For each measurement, the spectrum analyzer's RBW was set to 100 kHz, and the VBW was set to 300 kHz.

#### 7.5.1.2 Measurement Results

Performed by: Ryan McGann

#### **NON-HOPPING MODE:**

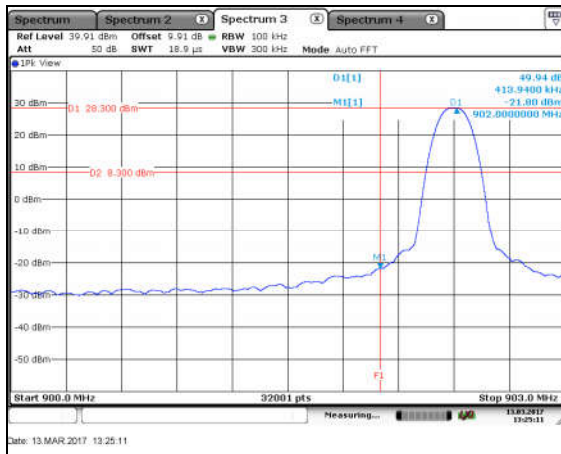

Figure 7.5.1.2-1: Lower BE – FSK – 50kbps

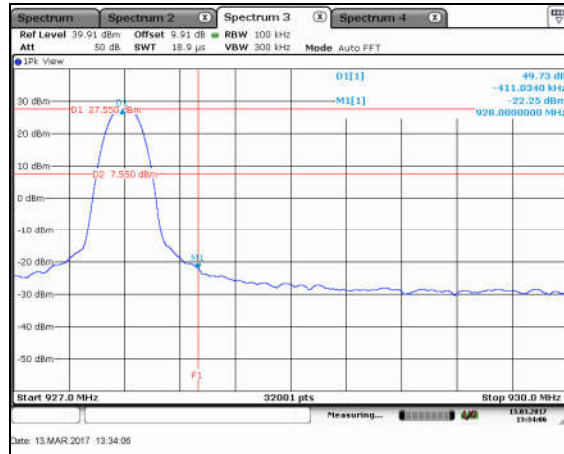

Figure 7.5.1.2-2: Upper BE – FSK – 50kbps

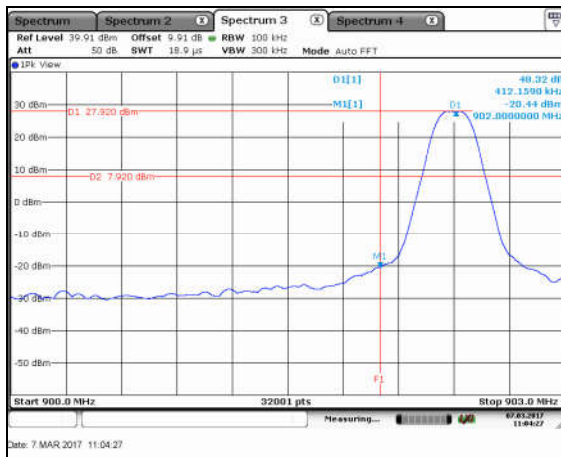

Figure 7.5.1.2-3: Lower BE – FSK – 150kbps

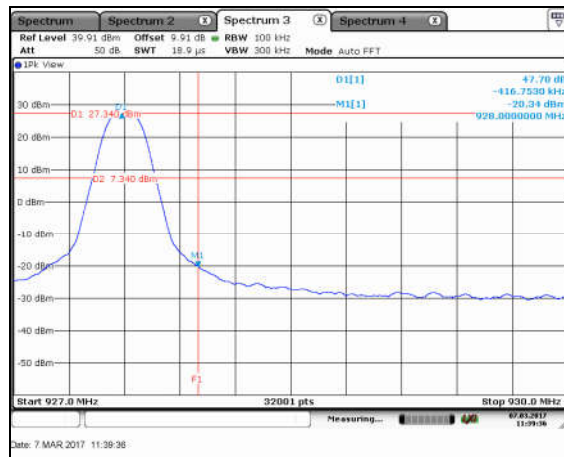

Figure 7.5.1.2-4: Upper BE – FSK – 150kbps

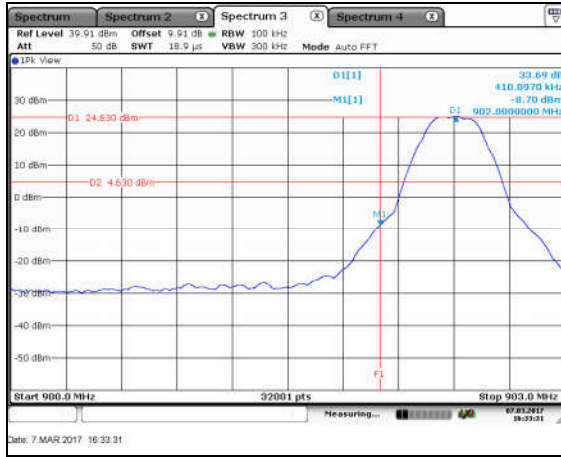

Figure 7.5.1.2-5: Lower BE – OFDM – 200kbps

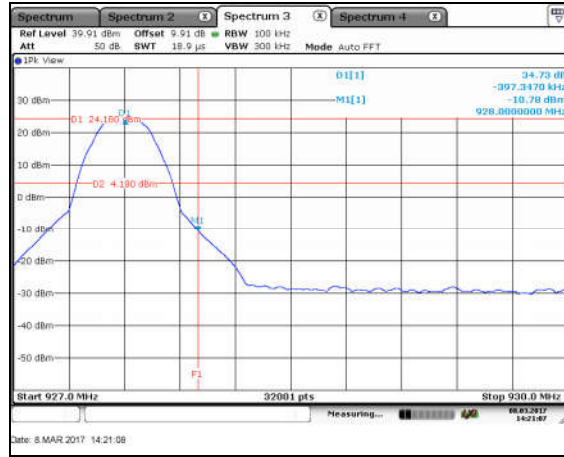

Figure 7.5.1.2-6: Upper BE – OFDM – 200kbps

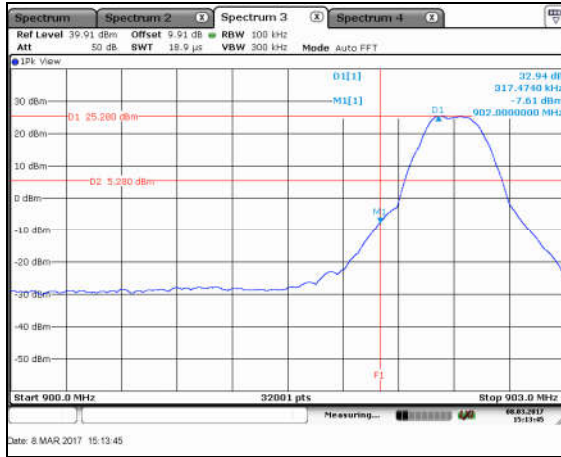

Figure 7.5.1.2-7: Lower BE – OFDM – 600kbps

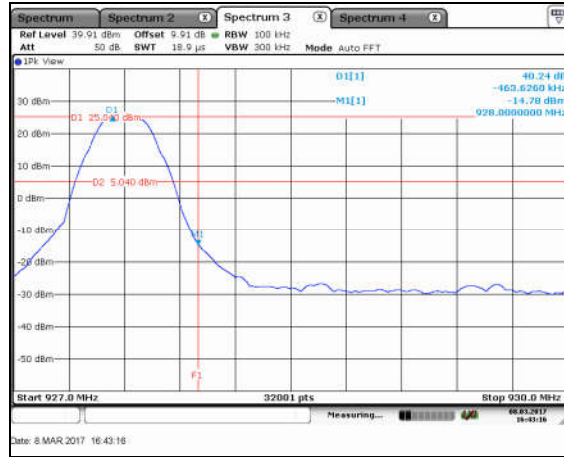

Figure 7.5.1.2-8: Upper BE – OFDM – 600kbps

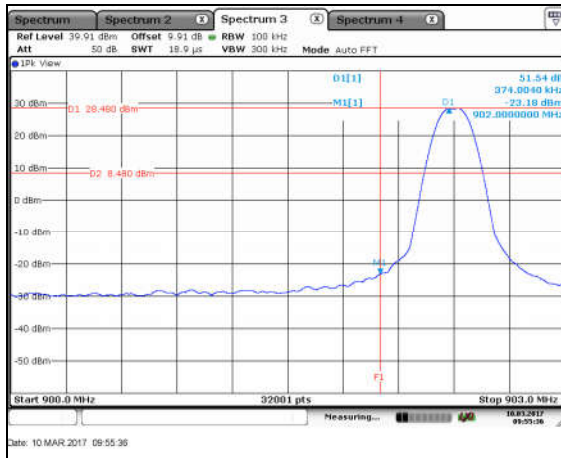

Figure 7.5.1.2-9: Lower BE – DSSS – 6.25kbps

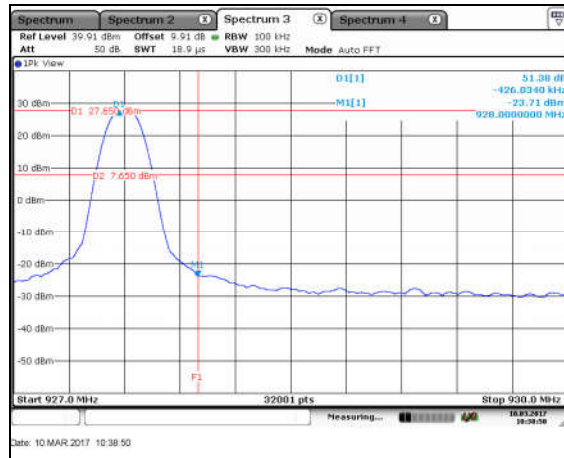
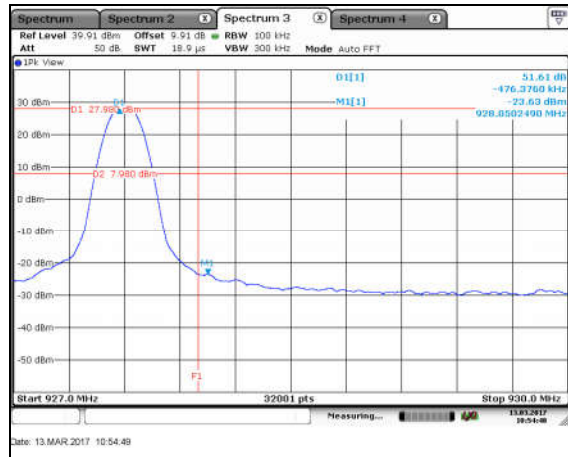
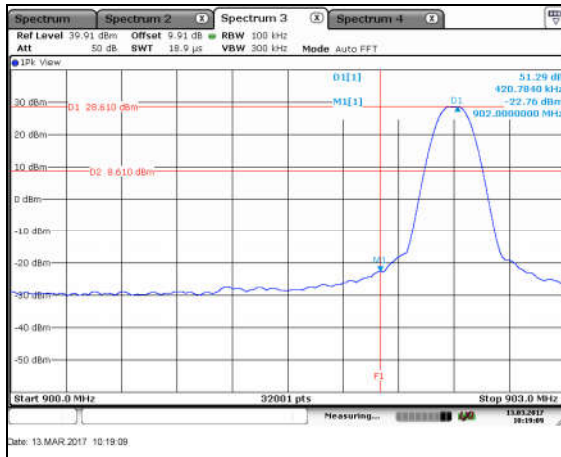

Figure 7.5.1.2-10: Upper BE – DSSS – 6.25kbps



**HOPPING MODE:**

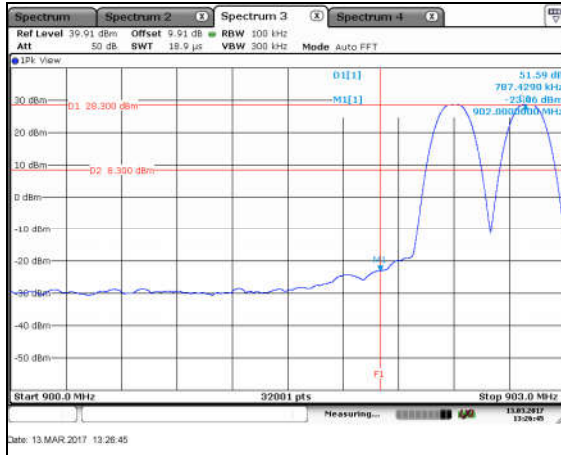

Figure 7.5.1.2-13: Lower BE Hop – FSK – 50kbps

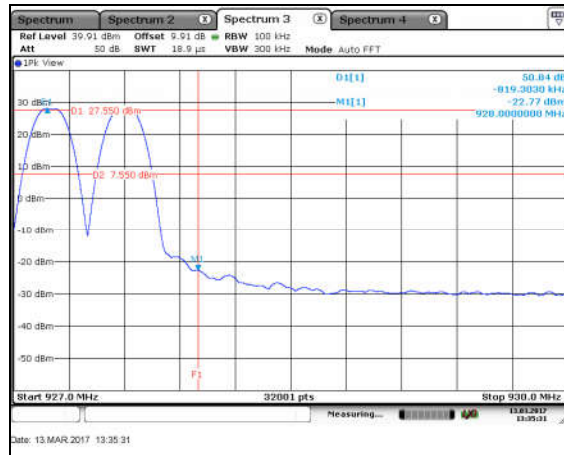

Figure 7.5.1.2-14: Upper BE Hop – FSK – 50kbps

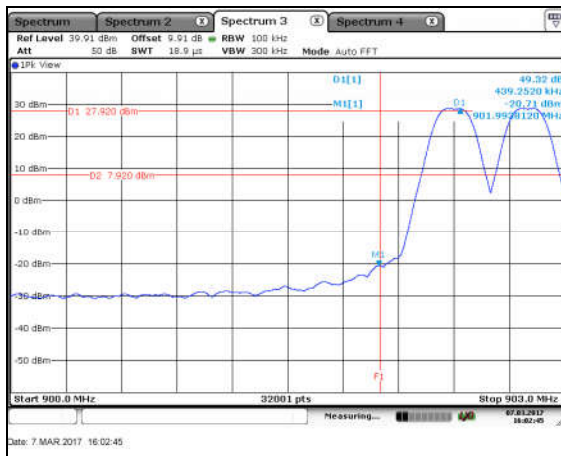

Figure 7.5.1.2-15: Lower BE Hop – FSK – 150kbps

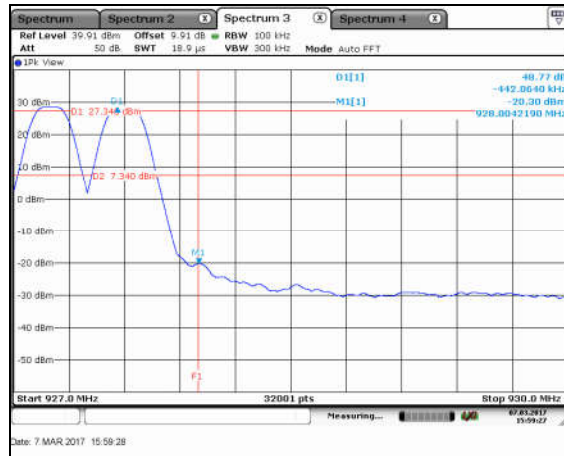

Figure 7.5.1.2-16: Upper BE Hop – FSK – 150kbps

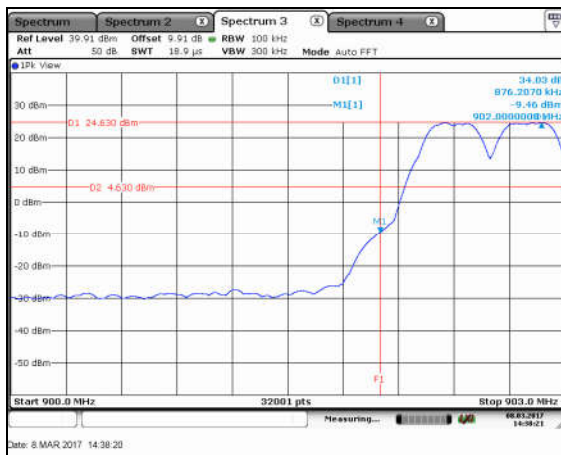

Figure 7.5.1.2-17: Lower BE Hop – OFDM – 200kbps

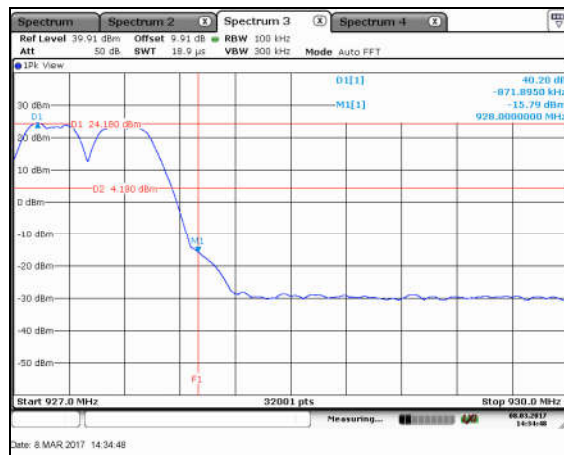

Figure 7.5.1.2-18: Upper BE Hop – OFDM – 200kbps

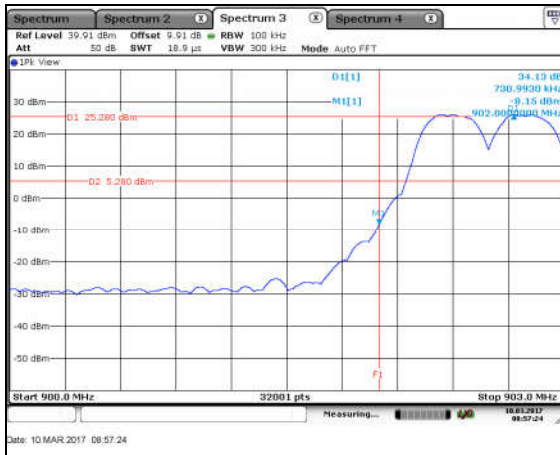

Figure 7.5.1.2-19: Lower BE Hop – OFDM – 600kbps

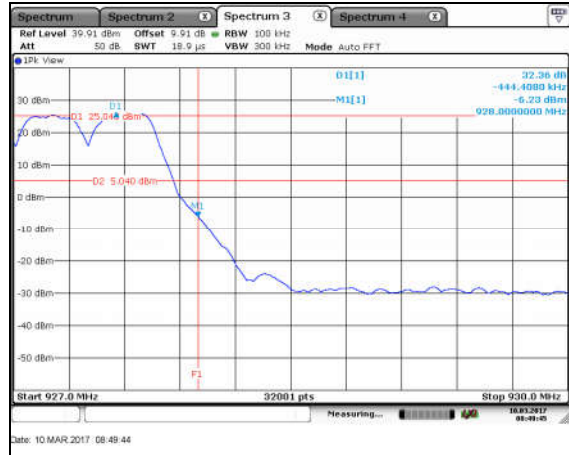

Figure 7.5.1.2-20: Upper BE Hop – OFDM – 600kbps

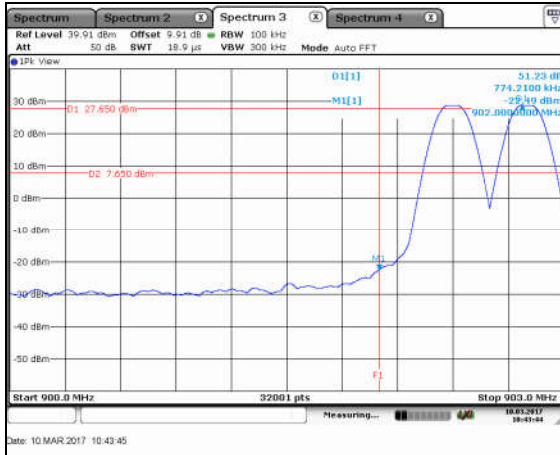

Figure 7.5.1.2-21: Lower BE Hop – DSSS – 6.25kbps

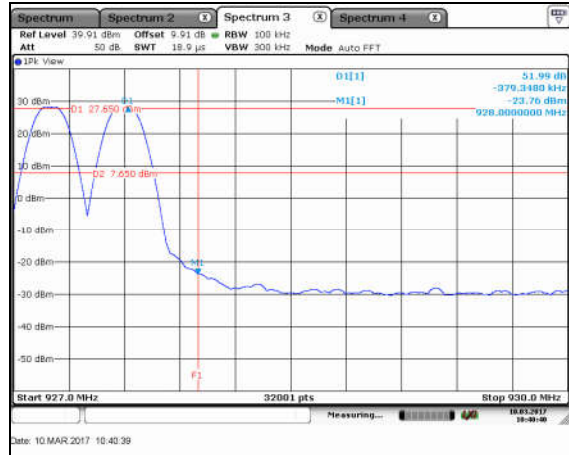

Figure 7.5.1.2-22: Upper BE Hop – DSSS – 6.25kbps

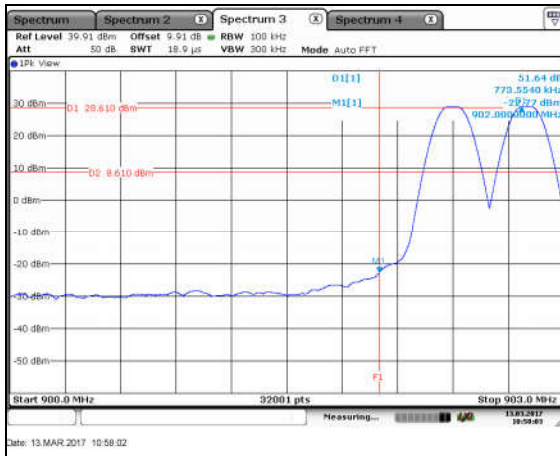

Figure 7.5.1.2-23: Lower BE Hop – DSSS – 12.5kbps

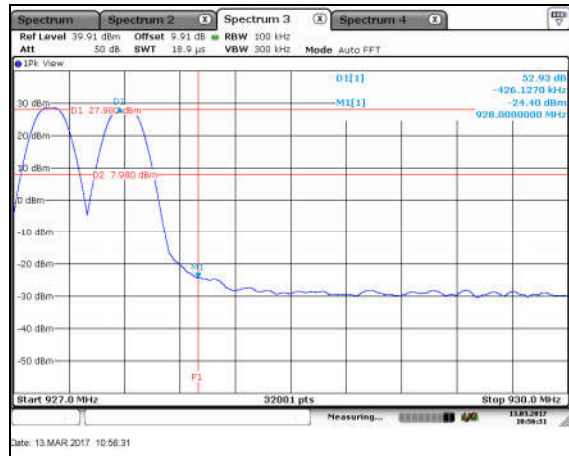

Figure 7.5.1.2-24: Upper BE Hop – DSSS – 12.5kbps

## 7.5.2 RF Conducted Spurious Emissions – FCC: Section 15.247(d); ISED Canada: RSS-247 5.5

### 7.5.2.1 Measurement Procedure

The RF output port of the EUT was directly connected to the input of the spectrum analyzer using suitable attenuation. The EUT was investigated for conducted spurious emissions from 30 MHz to 10 GHz, 10 times the highest fundamental frequency. Measurements were made at the low, center and high channels of the EUT. For each measurement, the spectrum analyzer’s RBW was set to 100 kHz. A peak detector function was used with the trace set to max hold.

### 7.5.2.2 Measurement Results

Performed by: Ryan McGann

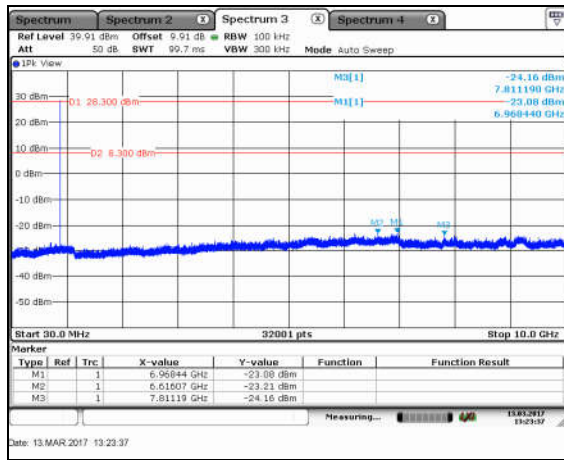

Figure 7.5.2.2-1: CE – FSK – 50kbps – LCH

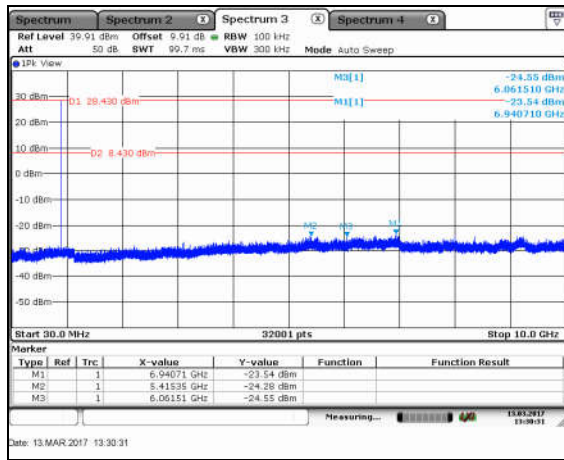

Figure 7.5.2.2-2: CE – FSK – 50kbps – MCH

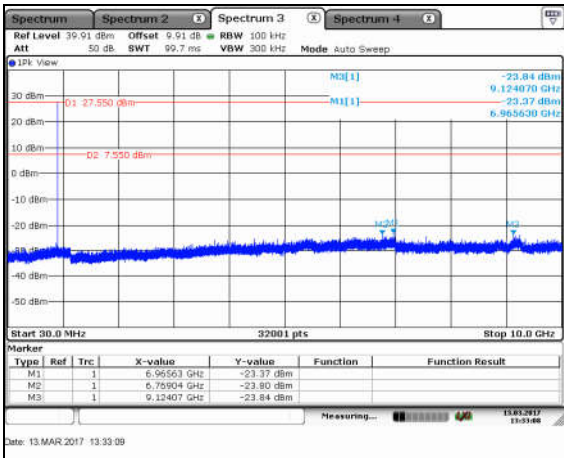

Figure 7.5.2.2-3: CE – FSK – 50kbps – HCH

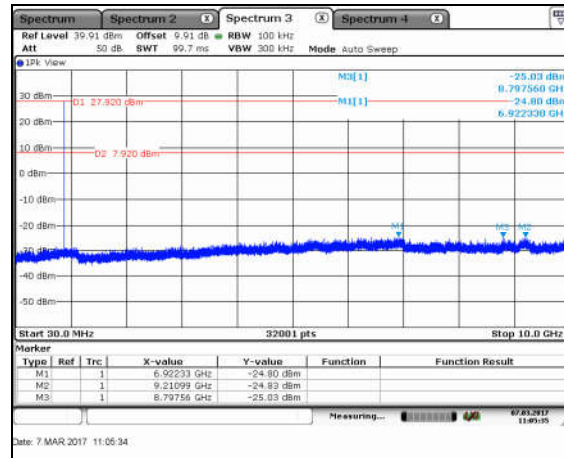

Figure 7.5.2.2-4: CE – FSK – 150kbps – LCH



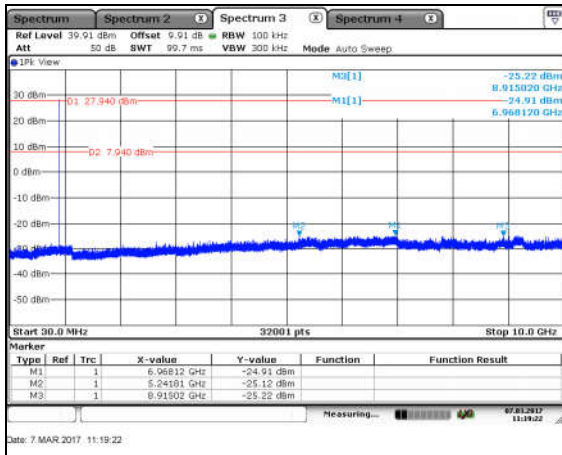

Figure 7.5.2.2-5: CE – FSK – 150kbps – MCH

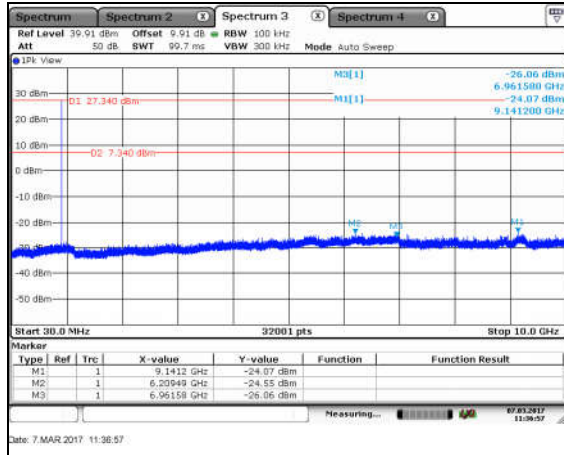

Figure 7.5.2.2-6: CE – FSK – 150kbps – HCH

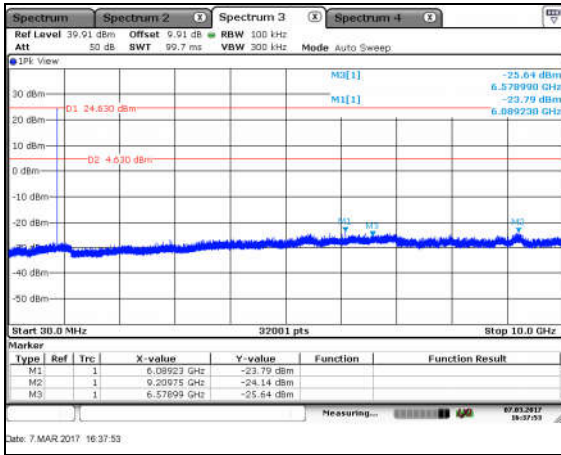

Figure 7.5.2.2-7: CE – OFDM – 200kbps – LCH

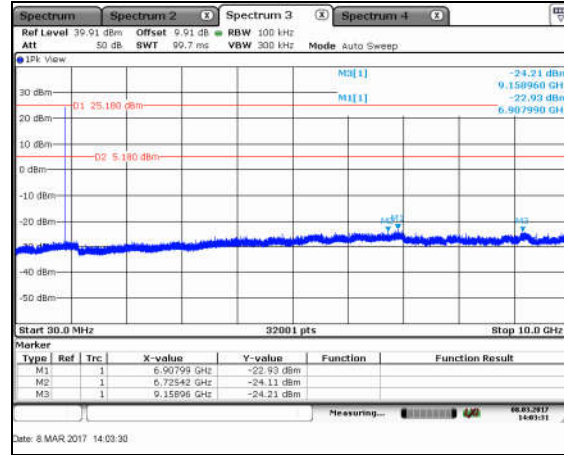

Figure 7.5.2.2-8: CE – OFDM – 200kbps – MCH

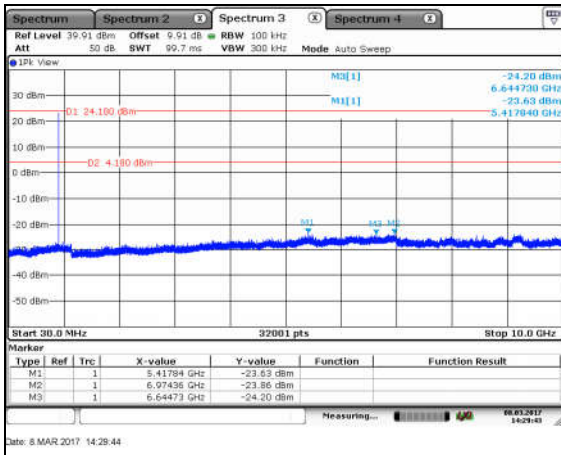

Figure 7.5.2.2-9: CE – OFDM – 200kbps – HCH

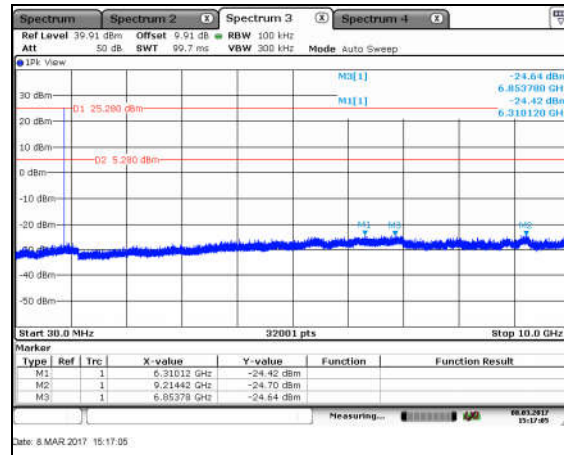

Figure 7.5.2.2-10: CE – OFDM – 600kbps – LCH

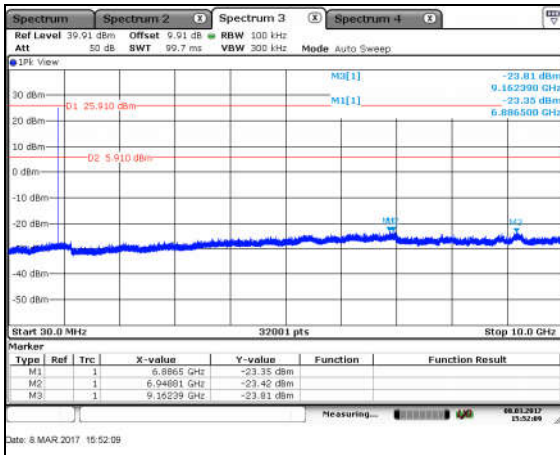

Figure 7.5.2.2-11: CE – OFDM – 600kbps – MCH

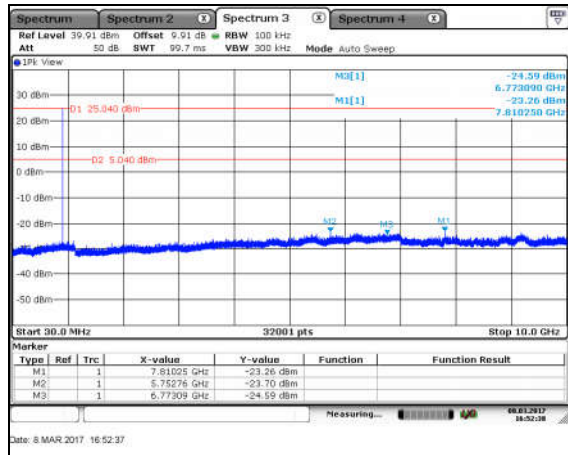

Figure 7.5.2.2-12: CE – OFDM – 600kbps – HCH

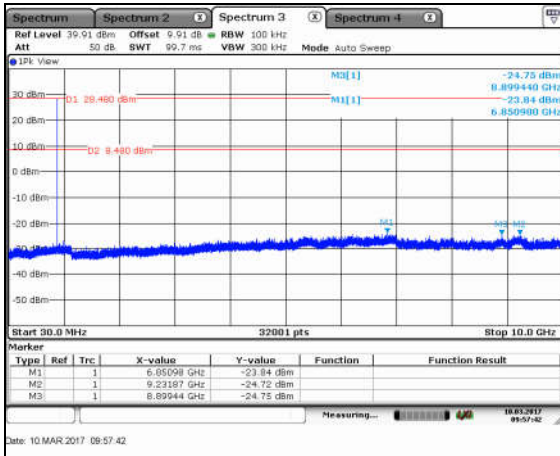

Figure 7.5.2.2-13: CE – DSSS – 6.25kbps – LCH

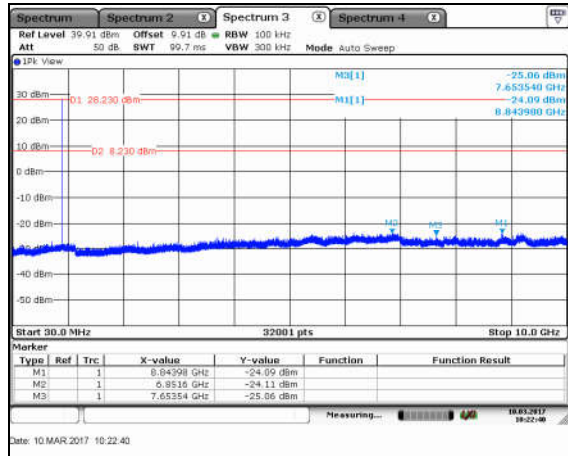

Figure 7.5.2.2-14: CE – DSSS – 6.25kbps – MCH

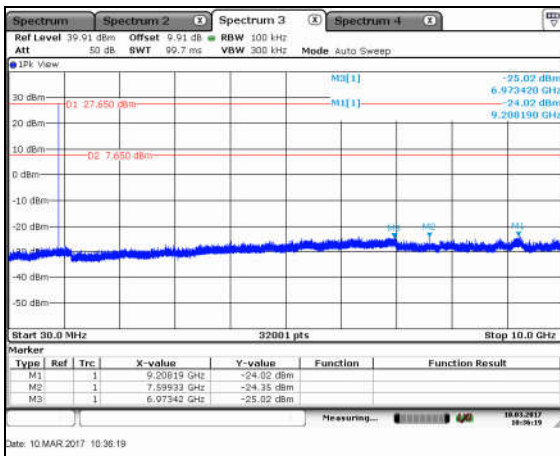

Figure 7.5.2.2-15: CE – DSSS – 6.25kbps – HCH

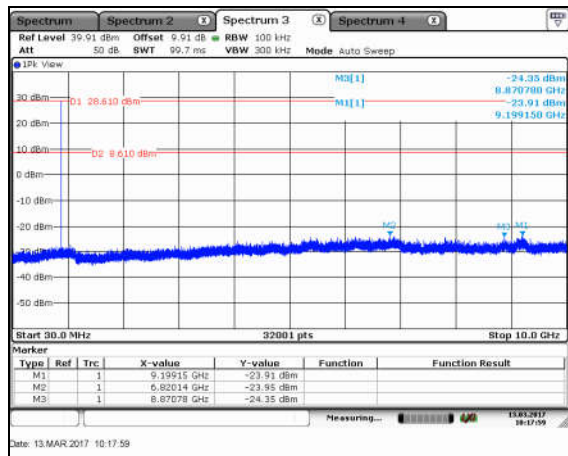

Figure 7.5.2.2-16: CE – DSSS – 12.5kbps – LCH

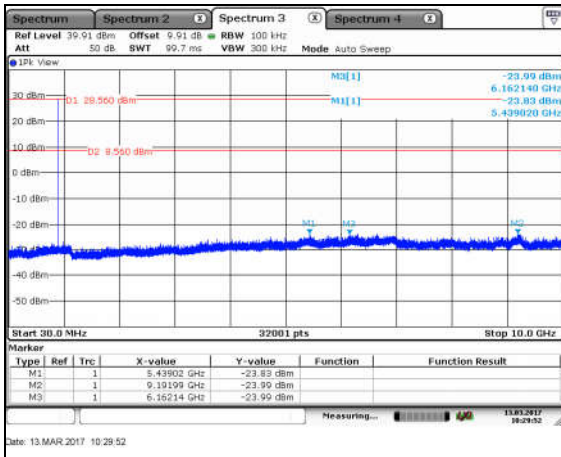

Figure 7.5.2.2-17: CE – DSSS – 12.5kbps – MCH

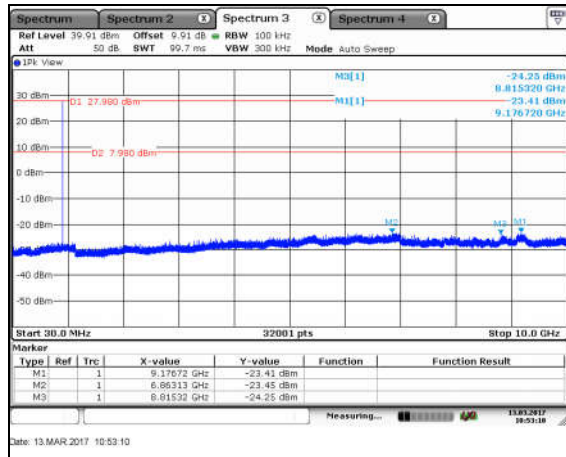

Figure 7.5.2.2-18: CE – DSSS – 12.5kbps – HCH

### 7.5.3 Radiated Spurious Emissions – FCC: Sections 15.205, 15.209; ISED Canada: RSS-Gen 8.9/8.10

#### 7.5.3.1 Measurement Procedure

Radiated emissions tests were made over the frequency range of 30 MHz to 10 GHz, 10 times the highest fundamental frequency.

The EUT was rotated through 360° and the receive antenna height was varied from 1 meter to 4 meters so that the maximum radiated emissions level would be detected. For frequencies below 1000 MHz, quasi-peak measurements were made using a resolution bandwidth RBW of 120 kHz and a video bandwidth VBW of 300 kHz. For frequencies above 1000 MHz, peak and average measurements were made with RBW and VBW of 1 MHz and 3 MHz respectively.

The EUT was caused to generate a continuous modulated carrier on the hopping channel.

Each emission found to be in a restricted band was compared to the applicable radiated emission limits.

#### 7.5.3.2 Measurement Results

Performed by: Ryan McGann

**Table 7.5.3.2-1: Radiated Spurious Emissions Tabulated Data – FSK Modulation 50kbps**

Frequency (MHz)	Level (dBuV)		Antenna Polarity (H/V)	Correction Factors (dB)	Corrected Level (dBuV/m)		Limit (dBuV/m)		Margin (dB)	
	pk	Qpk/Avg			pk	Qpk/Avg	pk	Qpk/Avg	pk	Qpk/Avg
<b>Low Channel</b>										
2707.2	49.13	38.38	H	-3.91	45.22	34.47	74.0	54.0	28.8	19.5
2707.2	49.53	37.72	V	-3.91	45.62	33.81	74.0	54.0	28.4	20.2
3609.6	56.21	52.05	H	-0.98	55.23	51.07	74.0	54.0	18.8	2.9
3609.6	53.44	46.95	V	-0.98	52.46	45.97	74.0	54.0	21.5	8.0
4512	49.61	37.53	H	0.54	50.15	38.07	74.0	54.0	23.8	15.9
4512	49.83	39.95	V	0.54	50.37	40.49	74.0	54.0	23.6	13.5
5414.4	47.93	34.95	H	3.40	51.33	38.35	74.0	54.0	22.7	15.6
5414.4	48.75	38.58	V	3.40	52.15	41.98	74.0	54.0	21.8	12.0
<b>Middle Channel</b>										
2745.6	48.41	40.40	H	-3.80	44.61	36.60	74.0	54.0	29.4	17.4
2745.6	49.91	43.68	V	-3.80	46.11	39.88	74.0	54.0	27.9	14.1
3660.8	56.05	51.84	H	-0.79	55.26	51.05	74.0	54.0	18.7	3.0
3660.8	53.9	49.07	V	-0.79	53.11	48.28	74.0	54.0	20.9	5.7
4576	49.08	42.27	H	0.75	49.83	43.02	74.0	54.0	24.2	11.0
4576	51.10	45.06	V	0.75	51.85	45.81	74.0	54.0	22.2	8.2
<b>High Channel</b>										
3710.4	52.69	45.82	H	-0.61	52.08	45.21	74.0	54.0	21.9	8.8
3710.4	51.73	42.70	V	-0.61	51.12	42.09	74.0	54.0	22.9	11.9
4638	50.06	41.87	H	0.95	51.01	42.82	74.0	54.0	23.0	11.2
4638	51.39	46.34	V	0.95	52.34	47.29	74.0	54.0	21.7	6.7

Table 7.5.3.2-2: Radiated Spurious Emissions Tabulated Data – FSK Modulation 150kbs

Frequency (MHz)	Level (dBuV)		Antenna Polarity (H/V)	Correction Factors (dB)	Corrected Level (dBuV/m)		Limit (dBuV/m)		Margin (dB)	
	pk	Qpk/Avg			pk	Qpk/Avg	pk	Qpk/Avg	pk	Qpk/Avg
<b>Low Channel</b>										
2707.2	48.73	39.92	H	-3.91	44.82	36.01	74.0	54.0	29.2	18.0
2707.2	49.04	41.19	V	-3.91	45.13	37.28	74.0	54.0	28.9	16.7
3609.6	56.20	51.51	H	-0.98	55.22	50.53	74.0	54.0	18.8	3.5
3609.6	54.03	48.54	V	-0.98	53.05	47.56	74.0	54.0	21.0	6.4
4512	50.11	41.97	H	0.54	50.65	42.51	74.0	54.0	23.3	11.5
4512	53.08	46.33	V	0.54	53.62	46.87	74.0	54.0	20.4	7.1
5414.4	46.65	37.17	H	3.40	50.05	40.57	74.0	54.0	23.9	13.4
5414.4	48.50	39.24	V	3.40	51.90	42.64	74.0	54.0	22.1	11.4
<b>Middle Channel</b>										
2745.6	49.78	42.85	H	-3.80	45.98	39.05	74.0	54.0	28.0	14.9
2745.6	50.97	44.63	V	-3.80	47.17	40.83	74.0	54.0	26.8	13.2
3660.8	57.06	53.14	H	-0.79	56.27	52.35	74.0	54.0	17.7	1.7
3660.8	53.23	48.07	V	-0.79	52.44	47.28	74.0	54.0	21.6	6.7
4576	49.91	43.47	H	0.75	50.66	44.22	74.0	54.0	23.3	9.8
4576	52.65	48.09	V	0.75	53.40	48.84	74.0	54.0	20.6	5.2
<b>High Channel</b>										
2782.8	49.87	46.90	H	-3.69	46.18	43.21	74.0	54.0	27.8	10.8
2782.8	51.13	49.54	V	-3.69	47.44	45.85	74.0	54.0	26.6	8.2
3710.4	53.64	48.49	H	-0.61	53.03	47.88	74.0	54.0	21.0	6.1
3710.4	51.94	47.24	V	-0.61	51.33	46.63	74.0	54.0	22.7	7.4
4638	52.49	48.04	H	0.95	53.44	48.99	74.0	54.0	20.6	5.0
4638	52.73	49.12	V	0.95	53.68	50.07	74.0	54.0	20.3	3.9

Table 7.5.3.2-3: Radiated Spurious Emissions Tabulated Data – OFDM Modulation

Frequency (MHz)	Level (dBuV)		Antenna Polarity (H/V)	Correction Factors (dB)	Corrected Level (dBuV/m)		Limit (dBuV/m)		Margin (dB)	
	pk	Qpk/Avg			pk	Qpk/Avg	pk	Qpk/Avg	pk	Qpk/Avg
<b>Low Channel</b>										
3609.6	55.22	41.97	H	-0.98	54.24	40.99	74.0	54.0	19.8	13.0
3609.6	54.50	40.15	V	-0.98	53.52	39.17	74.0	54.0	20.5	14.8
4512	54.47	36.45	H	0.54	55.01	36.99	74.0	54.0	19.0	17.0
4512	55.33	38.09	V	0.54	55.87	38.63	74.0	54.0	18.1	15.4
<b>Middle Channel</b>										
2745.6	47.02	41.79	H	-3.80	43.22	37.99	74.0	54.0	30.8	16.0
2745.6	47.64	41.98	V	-3.80	43.84	38.18	74.0	54.0	30.2	15.8
3660.8	55.15	43.04	H	-0.79	54.36	42.25	74.0	54.0	19.6	11.8
3660.8	52.62	41.07	V	-0.79	51.83	40.28	74.0	54.0	22.2	13.7
4576	52.39	40.61	H	0.75	53.14	41.36	74.0	54.0	20.9	12.6
4576	51.87	41.69	V	0.75	52.62	42.44	74.0	54.0	21.4	11.6
<b>High Channel</b>										
2782.8	50.14	36.14	H	-3.69	46.45	32.45	74.0	54.0	27.6	21.6
2782.8	50.65	38.16	V	-3.69	46.96	34.47	74.0	54.0	27.0	19.5
3710.4	53.70	40.48	H	-0.61	53.09	39.87	74.0	54.0	20.9	14.1
3710.4	51.24	39.25	V	-0.61	50.63	38.64	74.0	54.0	23.4	15.4
4638	50.48	38.09	H	0.95	51.43	39.04	74.0	54.0	22.6	15.0
4638	53.28	38.90	V	0.95	54.23	39.85	74.0	54.0	19.8	14.2

**Table 7.5.3.2-4: Radiated Spurious Emissions Tabulated Data – DSSS Modulation**

Frequency (MHz)	Level (dBuV)		Antenna Polarity (H/V)	Correction Factors (dB)	Corrected Level (dBuV/m)		Limit (dBuV/m)		Margin (dB)	
	pk	Qpk/Avg			pk	Qpk/Avg	pk	Qpk/Avg	pk	Qpk/Avg
<b>Low Channel</b>										
2707.2	49.41	39.34	H	-3.91	45.50	35.43	74.0	54.0	28.5	18.6
2707.2	48.52	38.90	V	-3.91	44.61	34.99	74.0	54.0	29.4	19.0
3609.6	57.19	52.67	H	-0.98	56.21	51.69	74.0	54.0	17.8	2.3
3609.6	54.35	48.93	V	-0.98	53.37	47.95	74.0	54.0	20.6	6.1
4512	50.15	37.83	H	0.54	50.69	38.37	74.0	54.0	23.3	15.6
4512	51.70	42.38	V	0.54	52.24	42.92	74.0	54.0	21.8	11.1
<b>Middle Channel</b>										
2745.6	49.52	39.85	H	-3.80	45.72	36.05	74.0	54.0	28.3	17.9
2745.6	49.42	41.57	V	-3.80	45.62	37.77	74.0	54.0	28.4	16.2
3660.8	57.05	52.62	H	-0.79	56.26	51.83	74.0	54.0	17.7	2.2
3660.8	54.91	50.04	V	-0.79	54.12	49.25	74.0	54.0	19.9	4.8
4576	51.64	44.10	H	0.75	52.39	44.85	74.0	54.0	21.6	9.2
4576	53.91	47.34	V	0.75	54.66	48.09	74.0	54.0	19.3	5.9
<b>High Channel</b>										
2782.8	49.76	41.90	H	-3.36	46.07	38.21	74.0	54.0	27.9	15.8
2782.8	52.11	45.71	V	-3.69	48.42	42.02	74.0	54.0	25.6	12.0
3710.4	53.03	48.22	H	-0.61	52.42	47.61	74.0	54.0	21.6	6.4
3710.4	52.05	45.37	V	-0.61	51.44	44.76	74.0	54.0	22.6	9.2
4638	51.37	45.24	H	0.95	52.32	46.19	74.0	54.0	21.7	7.8
4638	53.73	48.99	V	0.95	54.68	49.94	74.0	54.0	19.3	4.1

**7.5.3.3 Sample Calculation:**

$$R_C = R_U + CF_T$$

Where:

- $CF_T$  = Total Correction Factor (AF+CA+AG)-DC (Average Measurements Only)  
 $R_U$  = Uncorrected Reading  
 $R_C$  = Corrected Level  
AF = Antenna Factor  
CA = Cable Attenuation  
AG = Amplifier Gain  
DC = Duty Cycle Correction Factor

**Example Calculation: Peak – FSK Modulation 50kbps**

Corrected Level: 49.13 - 3.91 = 45.22dBuV/m

Margin: 74dBuV/m – 45.22dBuV/m = 28.8dB

**Example Calculation: Average – FSK Modulation 50kbps**

Corrected Level: 38.38 - 3.91 - 0 = 34.47dBuV

Margin: 54dBuV – 34.47dBuV = 19.5dB

## 8 ESTIMATION OF MEASUREMENT UNCERTAINTY

The expanded laboratory measurement uncertainty figures ( $U_{\text{Lab}}$ ) provided below correspond to an expansion factor (coverage factor)  $k = 1.96$  which provide confidence levels of 95%.

Parameter	$U_{\text{lab}}$
Occupied Channel Bandwidth	$\pm 0.009 \%$
RF Conducted Output Power	$\pm 0.349 \text{ dB}$
Power Spectral Density	$\pm 0.372 \text{ dB}$
Antenna Port Conducted Emissions	$\pm 1.264 \text{ dB}$
Radiated Emissions $\leq 1 \text{ GHz}$	$\pm 5.814 \text{ dB}$
Radiated Emissions $> 1 \text{ GHz}$	$\pm 4.318 \text{ dB}$
Temperature	$\pm 0.860 \text{ }^\circ\text{C}$
Radio Frequency	$\pm 2.832 \times 10^{-8}$
AC Power Line Conducted Emissions	$\pm 3.360 \text{ dB}$

**9 CONCLUSION**

In the opinion of TÜV SÜD America, Inc. the SNIC1, manufactured by Itron, Inc. meets the requirements of FCC Part 15 subpart C and Innovation, Science, and Economic Development Canada's Radio Standards Specification RSS-247 for the tests documented in this test report.

**END REPORT**