



## Certification Test Report

**FCC ID: SK9OW1  
IC: 864G-OW1**

**FCC Rule Part: 15.247  
ISED Canada Radio Standards Specification: RSS-247**

**Report Number: AT72127781-2P1**

**Manufacturer: Itron, Inc.  
Model: OW1**

**Test Begin Date: May 9, 2017  
Test End Date: June 9, 2017**

**Report Issue Date: July 25, 2017**



FOR THE SCOPE OF ACCREDITATION UNDER Certificate Number: AT-2021

This report must not be used by the client to claim product certification, approval, or endorsement by ANAB, NIST, or any agency of the Federal Government.

**Prepared by:**

**Ryan McGann  
Senior Engineer  
TÜV SÜD America Inc.**

**Reviewed by:**

**Thierry Jean-Charles  
EMC Engineer  
TÜV SÜD America Inc.**

This test report shall not be reproduced except in full. This report may be reproduced in part with prior written consent of TÜV SÜD America Inc. The results contained in this report are representative of the sample(s) submitted for evaluation.

**This report contains 22 pages**

# TABLE OF CONTENTS

<b>1</b>	<b>GENERAL</b> .....	<b>3</b>
1.1	PURPOSE.....	3
1.2	PRODUCT DESCRIPTION .....	3
1.3	TEST METHODOLOGY AND CONSIDERATIONS .....	4
<b>2</b>	<b>TEST FACILITIES</b> .....	<b>5</b>
2.1	LOCATION .....	5
2.2	LABORATORY ACCREDITATIONS/RECOGNITIONS/CERTIFICATIONS .....	5
2.3	RADIATED EMISSIONS TEST SITE DESCRIPTION .....	6
2.3.1	<i>Semi-Anechoic Chamber Test Site</i> .....	6
2.3.2	<i>Open Area Tests Site (OATS)</i> .....	7
2.4	CONDUCTED EMISSIONS TEST SITE DESCRIPTION.....	8
<b>3</b>	<b>APPLICABLE STANDARD REFERENCES</b> .....	<b>8</b>
<b>4</b>	<b>LIST OF TEST EQUIPMENT</b> .....	<b>9</b>
<b>5</b>	<b>SUPPORT EQUIPMENT</b> .....	<b>10</b>
<b>6</b>	<b>EQUIPMENT UNDER TEST SETUP BLOCK DIAGRAM</b> .....	<b>10</b>
<b>7</b>	<b>SUMMARY OF TESTS</b> .....	<b>11</b>
7.1	ANTENNA REQUIREMENT – FCC 15.203 .....	11
7.2	POWER LINE CONDUCTED EMISSIONS – FCC 15.207, ISED CANADA: RSS-GEN 8.8.....	11
7.2.1	<i>Measurement Procedure</i> .....	11
7.2.2	<i>Measurement Results</i> .....	11
7.3	20dB / 99% BANDWIDTH – FCC: SECTION 15.247(A)(1); ISED CANADA: RSS-247 5.2(A) .....	13
7.3.1	<i>Measurement Procedure</i> .....	13
7.3.2	<i>Measurement Results</i> .....	13
7.4	FUNDAMENTAL EMISSION OUTPUT POWER – FCC: SECTION 15.247(B)(3); ISED CANADA: RSS-247 5.4(D) ..	15
7.4.1	<i>Measurement Procedure</i> .....	15
7.4.2	<i>Measurement Results</i> .....	15
7.5	CHANNEL USAGE REQUIREMENTS.....	16
7.5.1	<i>Carrier Frequency Separation – FCC: Section 15.247(a)(1); ISED Canada: RSS-247 5.1(b)</i> .....	16
7.5.1.1	<i>Measurement Procedure</i> .....	16
7.5.1.2	<i>Measurement Results</i> .....	16
7.5.2	<i>Channel Dwell Time – FCC: Section 15.247(f); ISED Canada: RSS-247 5.3</i> .....	17
7.5.2.1	<i>Measurement Procedure</i> .....	17
7.6	EMISSION LEVELS .....	18
7.6.1	<i>Emissions into Non-Restricted Frequency Bands – FCC: Section 15.247(d); ISED Canada: RSS-247 5.5</i>	18
7.6.1.1	<i>Measurement Procedure</i> .....	18
7.6.1.2	<i>Measurement Results</i> .....	18
7.6.2	<i>Emissions into Restricted Frequency Bands – FCC: Sections 15.205, 15.209; ISED Canada: RSS-Gen 8.9 / 8.10</i> .....	20
7.6.2.1	<i>Measurement Procedure</i> .....	20
7.6.2.2	<i>Measurement Results</i> .....	20
7.6.2.3	<i>Sample Calculation:</i> .....	20
7.7	MAXIMUM POWER SPECTRAL DENSITY – FCC: SECTION 15.247(E) ISED CANADA: RSS-247 5.3(B).....	21
7.7.1	<i>Measurement Procedure</i> .....	21
7.7.2	<i>Measurement Results</i> .....	21
<b>8</b>	<b>ESTIMATION OF MEASUREMENT UNCERTAINTY</b> .....	<b>22</b>
<b>9</b>	<b>CONCLUSION</b> .....	<b>22</b>

## 1 GENERAL

### 1.1 Purpose

The purpose of this report is to demonstrate compliance with Part 15 Subpart C of the FCC's Code of Federal Regulations and Innovation, Science, and Economic Development Canada's Radio Standards Specification RSS-247 Certification for Class II Permissive Change.

The purpose of this evaluation for Class II Permissive Change is to address a new equipment class for the Itron OW1.

### 1.2 Product Description

The Itron OW1 is a communications module which includes a 902.4 MHz to 927.6 MHz transmitter. The module operates on DC voltage which is supplied by a host device.

This test report documents the compliance of the 900 MHz transceiver hybrid mode of operation.

Technical Information:

Detail	Description	
Frequency Range	902.8 – 926.8 MHz	
Number of Channels	31	
Modulation Format	OFDM	
Data Rates	1200kbps	
Operating Voltage	24Vdc	
Antenna Type / Gain	Monopole Antenna (original):	2.8 dBi
	PCTel BOA9028 Omni Antenna (new):	8.15dBi*
	Antenna Products AMR 360-902-5-T0-N	
	Omni Antenna (new):	5.1 dBi

\* The PCTel BOA9028 Omni Antenna requires a minimum of 2.2dB between the antenna and the EUT.

Manufacturer Information:

Itron, Inc.  
313 N Hwy 11  
West Union, SC 29696

Test Sample Serial Number: 9110000675

Test Sample Condition: The test samples were provided in good working order with no visible defects.

**1.3 Test Methodology and Considerations**

All modes of operation, including all data rates, were evaluated and the data presented in this report represents the worst case where applicable. The new antennas were evaluated for a worst-case configuration with respect to radiated emissions. The worst-case antenna was the PCTel BOA9028 Omni antenna with 8.15dBi gain.

For radiated emissions, the EUT was evaluated in three orthogonal orientations. The worst-case orientation was Z-orientation. See test setup photos for more information.

For AC power line conducted emissions the EUT was evaluated with a commercially available wall wart power supply.

For RF Conducted Emissions, the EUT was coupled to the measurement equipment via SMA connector.

Radiated inter-modulation testing was performed for all combinations of simultaneous transmission and found to comply.

Power setting during test: +8

## 2 TEST FACILITIES

### 2.1 Location

The radiated and conducted emissions test sites are located at the following address:

TÜV SÜD America, Inc.  
5015 B.U. Bowman Drive  
Buford, GA 30518  
Phone: (770) 831-8048  
Fax: (770) 831-8598

### 2.2 Laboratory Accreditations/Recognitions/Certifications

TÜV SÜD America, Inc. is accredited to ISO/IEC 17025 by the ANSI-ASQ National Accreditation Board/ANAB accreditation program, and has been issued certificate number AT-2021 in recognition of this accreditation. Unless otherwise specified, all tests methods described within this report are covered under the ISO/IEC 17025 scope of accreditation.

The Semi-Anechoic Chamber Test Site, Open Area Test Site (OATS) and Conducted Emissions Site have been fully described, submitted to, and accepted by the FCC, ISED Canada and the Japanese Voluntary Control Council for Interference by information technology equipment.

FCC Registration Number: 391271

ISED Canada Lab Code: IC 4175A

VCCI Member Number: 1831

- VCCI OATS Registration Number R-1526
- VCCI Conducted Emissions Site Registration Number: C-1608

## 2.3 Radiated Emissions Test Site Description

### 2.3.1 Semi-Anechoic Chamber Test Site

The Semi-Anechoic Chamber Test Site consists of a 20' x 30' x 18' shielded enclosure. The chamber is lined with Toyo Ferrite Grid Absorber, model number FFG-1000. The ferrite tile grid is 101 x 101 x 19mm thick and weighs approximately 550 grams. These tiles are mounted on steel panels and installed directly on the inner walls of the chamber.

The turntable is 150cm in diameter and is located 160cm from the back wall of the chamber. The chamber is grounded via 1 - 8' copper ground rod, installed at the center of the back wall, it is bound to the ground plane using 3/4" stainless steel braided cable.

The turntable is all steel, flush mounted table installed in an all steel frame. The table is remotely operated from inside the control room located 25' from the range. The turntable is electrically bonded to the surrounding ground plane via steel fingers installed on the edge of the turn table. The steel fingers make constant contact with the ground plane during operation.

Behind the turntable is a 3' x 6' x 4' deep shielded pit used for support equipment if necessary. The pit is equipped with 1 - 4" PVC chases from the turntable to the pit that allow for cabling to the EUT if necessary. The underside of the turntable can be accessed from the pit so cables can be supplied to the EUT from the pit.

A diagram of the Semi-Anechoic Chamber Test Site is shown in Figure 2.3-1 below:

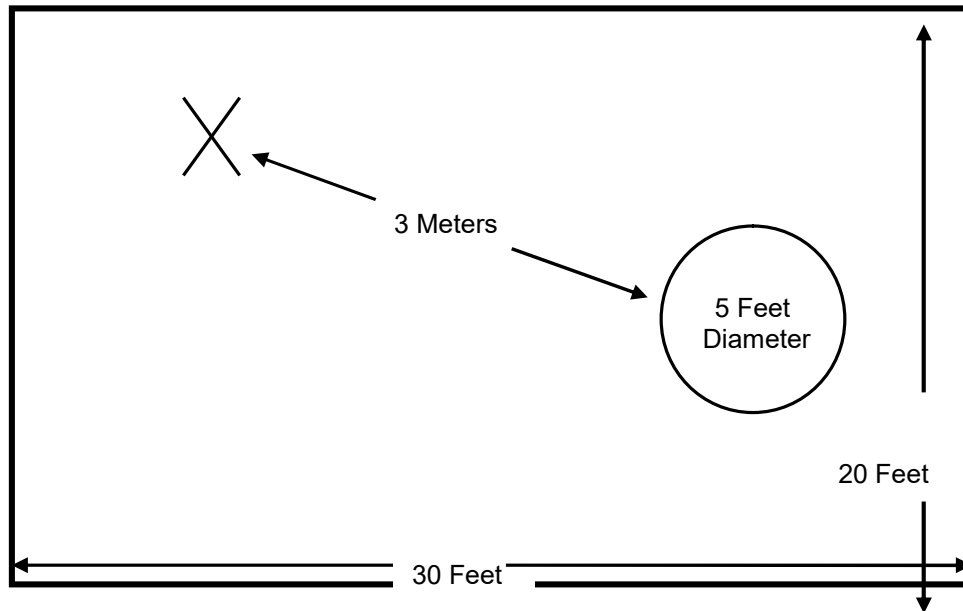

Figure 2.3-1: Semi-Anechoic Chamber Test Site

### 2.3.2 Open Area Tests Site (OATS)

The open area test site consists of a 40' x 66' concrete pad covered with a perforated electro-plated galvanized sheet metal. The perforations in the sheet metal are 1/8" holes that are staggered every 3/16". The individual sheets are placed to overlap each other by 1/4" and are riveted together to provide a continuous seam. Rivets are spaced every 3" in a 3 x 20 meter perimeter around the antenna mast and EUT area. Rivets in the remaining area are spaced as necessary to properly secure the ground plane and maintain the electrical continuity.

The entire ground plane extends 12' beyond the turntable edge and 16' beyond the antenna mast when set to a 10 meter measurement distance. The ground plane is grounded via 4 - 8' copper ground rods, each installed at a corner of the ground plane and bound to the ground plane using 3/4" stainless steel braided cable.

The turntable is an all aluminum 10' flush mounted table installed in an all aluminum frame. The table is remotely operated from inside the control room located 40' from the range. The turntable is electrically bonded to the surrounding ground plane via steel fingers installed on the edge of the turn table. The steel fingers make constant contact with the ground plane during operation.

Adjacent to the turntable is a 7' x 7' square and 4' deep concrete pit used for support equipment if necessary. The pit is equipped with 5 - 4" PVC chases from the pit to the control room that allow for cabling to the EUT if necessary. The underside of the turntable can be accessed from the pit so cables can be supplied to the EUT from the pit. The pit is covered with 2 sheets of 1/4" diamond style re-enforced steel sheets. The sheets are painted to match the perforated steel ground plane; however the underside edges have been masked off to maintain the electrical continuity of the ground plane. All reflecting objects are located outside of the ellipse defined in ANSI C63.10.

A diagram of the Open Area Test Site is shown in Figure 2.3-2 below:

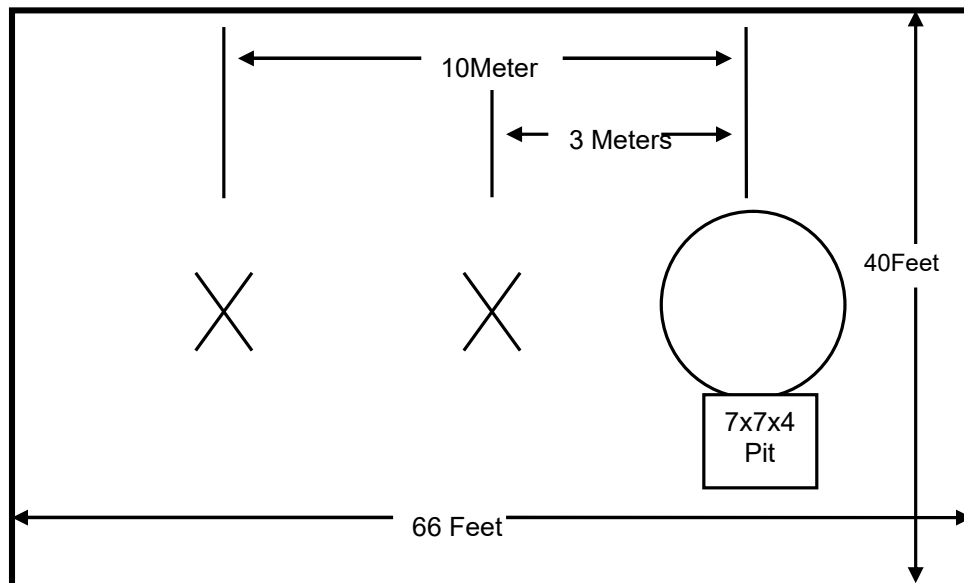

Figure 2.3-2: Open Area Test Site

## 2.4 Conducted Emissions Test Site Description

The AC mains conducted EMI site is located in the main EMC lab. It consists of an 8' x 8' solid aluminum horizontal ground reference plane (GRP) bonded every 3" to an 8' X 8' vertical ground plane.

The site is of sufficient size to test table top and floor standing equipment in accordance with ANSI C63.10.

A diagram of the room is shown below in figure 2.4-1:

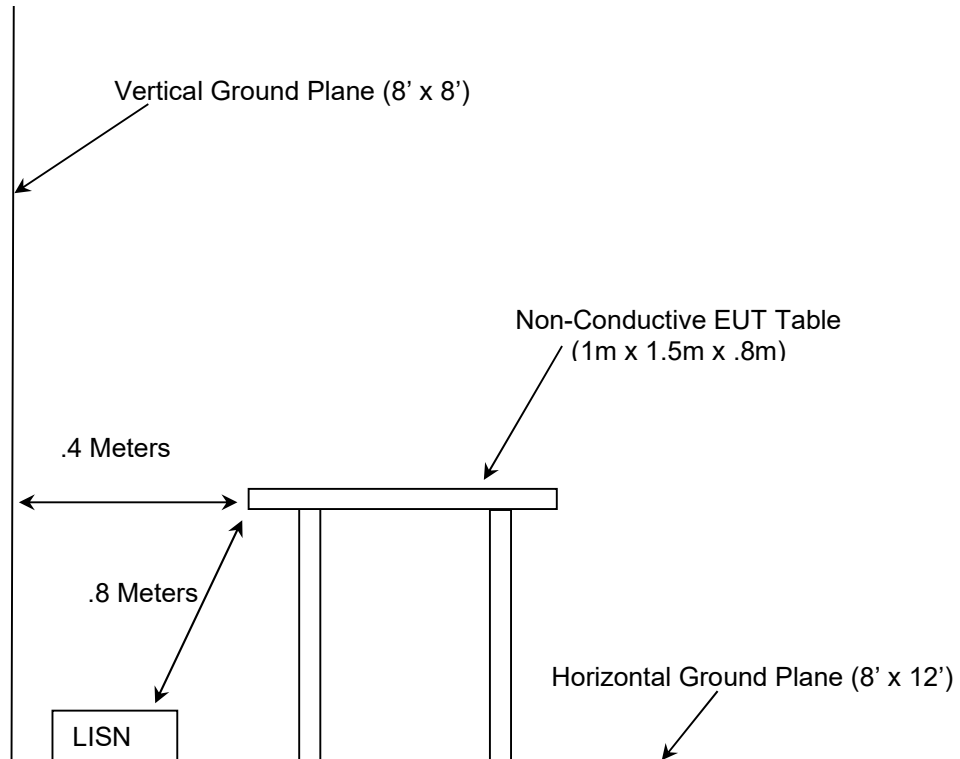

Figure 2.4-1: AC Mains Conducted EMI Site

## 3 APPLICABLE STANDARD REFERENCES

The following standards were used:

- ❖ ANSI C63.10-2013: American National Standard of Procedures for Compliance Testing of Unlicensed Wireless Devices.
- ❖ US Code of Federal Regulations (CFR): Title 47, Part 2, Subpart J: Equipment Authorization Procedures, 2017
- ❖ US Code of Federal Regulations (CFR): Title 47, Part 15, Subpart C: Radio Frequency Devices, Intentional Radiators, 2017
- ❖ FCC KDB 558074 D01 DTS Meas Guidance v04 - Guidance for Performing Compliance Measurements on Digital Transmission Systems (DTS) Operating Under §15.247, April 5, 2017
- ❖ ISED Canada Radio Standards Specification: RSS-247 – Digital Transmission Systems (DTSs), Frequency Hopping Systems (FHSs) and Licence-Exempt Local Area Network (LE-LAN) Devices, Issue 2, Feb 2017.
- ❖ ISED Canada Radio Standards Specification: RSS-GEN – General Requirements for Compliance of Radio Apparatus, Issue 4, Nov 2014.



#### 4 LIST OF TEST EQUIPMENT

The calibration interval of test equipment is annually or the manufacturer's recommendations. Where the calibration interval deviates from the annual cycle based on the instrument manufacturer's recommendations, it shall be stated below.

**Table 4-1: Test Equipment**

AssetID	Manufacturer	Model #	Equipment Type	Serial #	Last Calibration Date	Calibration Due Date
30	Spectrum Technologies	DRH-0118	Antennas	970102	5/9/2017	5/9/2019
40	EMCO	3104	Antennas	3211	6/8/2016	6/8/2018
73	Agilent	8447D	Amplifiers	2727A05624	7/21/2016	7/21/2017
167	ACS	Hammer EMI Cable S	Cable Set	167	9/30/2016	9/30/2017
267	Agilent	N1911A	Meters	MY45100129	8/24/2015	8/24/2017
268	Agilent	N1921A	Sensors	MY45240184	8/13/2015	8/13/2017
324	ACS	Belden	Cables	8214	3/21/2017	3/21/2018
329	A.H.Systems	SAS-571	Antennas	721	7/22/2015	7/22/2017
331	Microwave Circuits	H1G513G1	Filters	31417	5/13/2017	5/13/2018
331	Microwave Circuits	H1G513G1	Filters	31417	5/13/2016	5/13/2017
338	Hewlett Packard	8449B	Amplifiers	3008A01111	8/21/2015	8/21/2017
340	Aeroflex/Weinschel	AS-20	Attenuators	7136	7/12/2016	7/12/2017
412	Electro Metrics	LPA-25	Antennas	1241	8/8/2016	8/8/2018
422	Florida RF	SMS-200AW-72.0-SMR	Cables	805	10/27/2016	10/27/2017
616	Florida RF Cables	SMRE-200W-12.0-SMRE	Cables	N/A	9/2/2016	9/2/2017
622	Rohde & Schwarz	FSV40	Analyzers	101338	7/15/2016	7/15/2018
676	Florida RF Labs	SMS-290AW-480.0-SMS	Cables	MFR2Y194	11/4/2016	11/4/2017
812	PMM	9030	Receiver	121WW30401	2/6/2017	2/6/2018
3010	Rohde & Schwarz	ENV216	LISN	3010	7/11/2016	7/11/2017
RE135	Rohde & Schwarz	FSP30	Spectrum Analyzers	835618/031	10/31/2016	10/31/2017

**NCR = No Calibration Required**

**NOTES: All test equipment was used only during active calibration cycles.**

5 SUPPORT EQUIPMENT

Table 5-1: Support Equipment – Radiated Emissions

Item	Equipment Type	Manufacturer	Model/Part Number	Serial Number
1	Power Supply	TRIAD	WSU120-1000	N/A

Table 5-2: Cable Description – Radiated Emissions

Cable	Cable Type	Length	Shield	Termination
A	DC Power Cable	1.75 m	No	EUT to Power Supply
B	RF Cable	1.85 m	Yes	EUT to Antenna

6 EQUIPMENT UNDER TEST SETUP BLOCK DIAGRAM

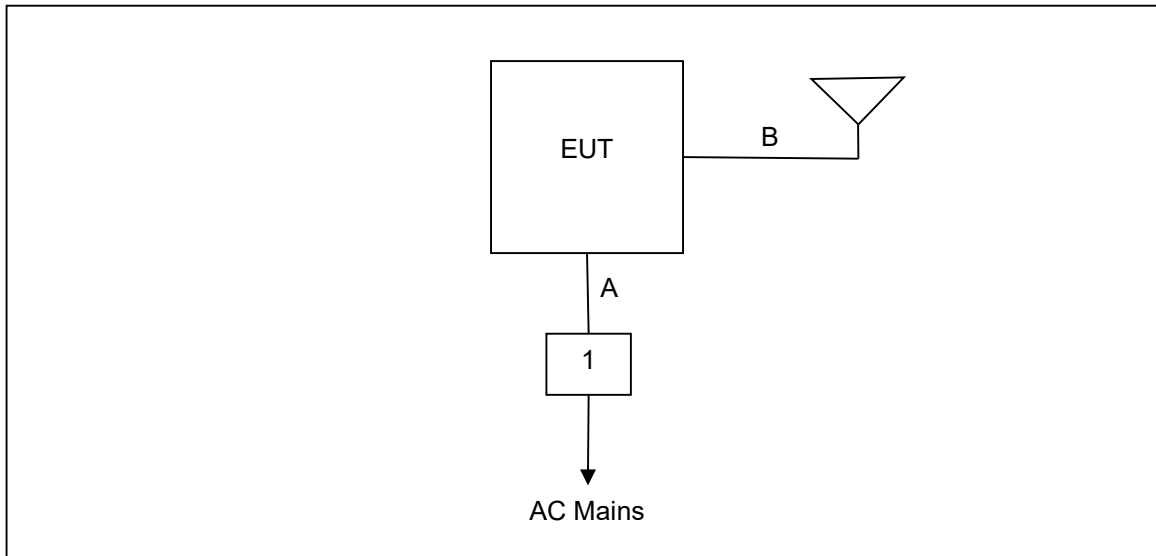

Figure 6-1: Test Setup Block Diagram

## 7 SUMMARY OF TESTS

Along with the tabular data shown below, plots were taken of all signals deemed important enough to document.

### 7.1 Antenna Requirement – FCC 15.203

The EUT utilizes a Monopole Antenna (original) with 2.8 dBi gain, a PCTel BOA9028 Omni Antenna (new) with 8.15dBi gain, and an Antenna Products AMR 360-902-5-T0-N Omni Antenna (new) with 5.1dBi gain. The PCTel BOA9028 Omni Antenna requires a minimum of 2.2dB between the antenna and the EUT. See the product manual for more information. All antennas couple to the EUT via a cable using specialized connectors converted to SMA and then N-Type and require professional installation, therefore meeting the requirements of 15.203.

### 7.2 Power Line Conducted Emissions – FCC 15.207, ISED Canada: RSS-Gen 8.8

#### 7.2.1 Measurement Procedure

Conducted emissions were performed from 150 kHz to 30 MHz with the spectrum analyzer's resolution bandwidth set to 9 kHz and the video bandwidth set to 30 kHz. The calculation for the conducted emissions is as follows:

$$\text{Corrected Reading} = \text{Analyzer Reading} + \text{LISN Loss} + \text{Cable Loss}$$

$$\text{Margin} = \text{Applicable Limit} - \text{Corrected Reading}$$

#### 7.2.2 Measurement Results

Performed by: Ryan McGann

**Table 7.2.2-1: Conducted EMI Results – Line 1**

Frequency (MHz)	Corrected Reading		Limit		Margin		Correction (dB)
	Quasi-Peak (dBuV)	Average (dBuV)	Quasi-Peak (dBuV)	Average (dBuV)	Quasi-Peak (dB)	Average (dB)	
0.378	43	29.47	58.32	48.32	-15.32	-18.85	9.59
0.386	49.88	39.73	58.15	48.15	-8.27	-8.42	9.59
0.394	49.16	37.09	57.98	47.98	-8.82	-10.89	9.59
0.438	47.81	34.9	57.1	47.1	-9.29	-12.2	9.59
0.462	46.25	25.78	56.66	46.66	-10.41	-20.88	9.59
1.35	41.13	28.22	56	46	-14.87	-17.78	9.64
1.386	41.9	28.77	56	46	-14.1	-17.23	9.64
2.01	40.02	24.62	56	46	-15.98	-21.38	9.71
2.174	39.97	24.21	56	46	-16.03	-21.79	9.71
2.874	39.29	26.05	56	46	-16.71	-19.95	9.72

Table 7.2.2-2: Conducted EMI Results – Line 2

Frequency (MHz)	Corrected Reading		Limit		Margin		Correction (dB)
	Quasi-Peak (dBuV)	Average (dBuV)	Quasi-Peak (dBuV)	Average (dBuV)	Quasi-Peak (dB)	Average (dB)	
0.166	40.12	28.58	65.16	55.16	-25.04	-26.58	9.58
0.21	39.12	27.32	63.21	53.21	-24.09	-25.89	9.58
0.374	43.24	24.79	58.41	48.41	-15.17	-23.62	9.59
0.386	44.03	27.82	58.15	48.15	-14.12	-20.33	9.59
0.43	43.99	25.52	57.25	47.25	-13.26	-21.73	9.59
0.458	43.41	25.48	56.73	46.73	-13.32	-21.25	9.59
0.47	43.31	22.5	56.51	46.51	-13.2	-24.01	9.59
1.174	38.31	22.37	56	46	-17.69	-23.63	9.62
1.998	38.41	17.61	56	46	-17.59	-28.39	9.71
2.146	36.53	19.64	56	46	-19.47	-26.36	9.71

7.3 20dB / 99% Bandwidth – FCC: Section 15.247(a)(1); ISED Canada: RSS-247 5.2(a)

7.3.1 Measurement Procedure

The RF output port of the EUT was directly connected to the input of the spectrum analyzer using suitable attenuation. The span of the spectrum analyzer display was set between two times and five times the occupied bandwidth (OBW) of the emission. The RBW of the spectrum analyzer was set to approximately 1 % to 5 % of the OBW. The trace was set to max hold with a peak detector active. The ndB down measurement functions of the analyzer were utilized to determine the 20 dB bandwidth of the emission.

The occupied bandwidth measurement function of the spectrum analyzer was used to measure the 99% bandwidth. The span of the analyzer was set to capture all products of the modulation process, including the emission sidebands. The resolution bandwidth was set from 1% to 5% of the occupied bandwidth and the video bandwidth set to at least 3 times the resolution bandwidth. A peak detector was used.

7.3.2 Measurement Results

Performed by: Ryan McGann

Table 7.3.2-1: 20dB / 99% Bandwidth

Frequency [MHz]	20dB Bandwidth [kHz]	99% Bandwidth [kHz]
902.8	694.197	562.482
914.8	702.166	561.482
926.8	688.197	562.482

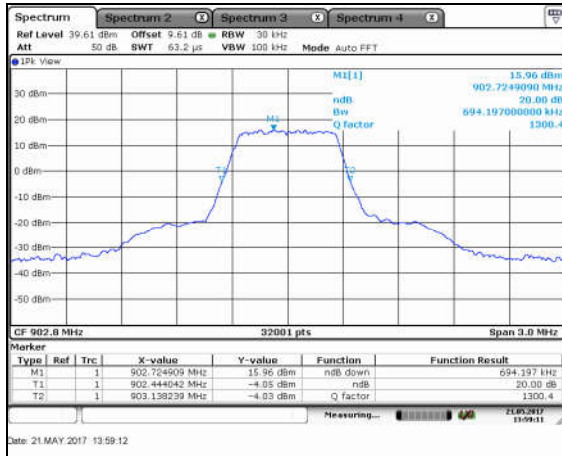

Figure 7.3.2-1: 20dB Bandwidth – LCH

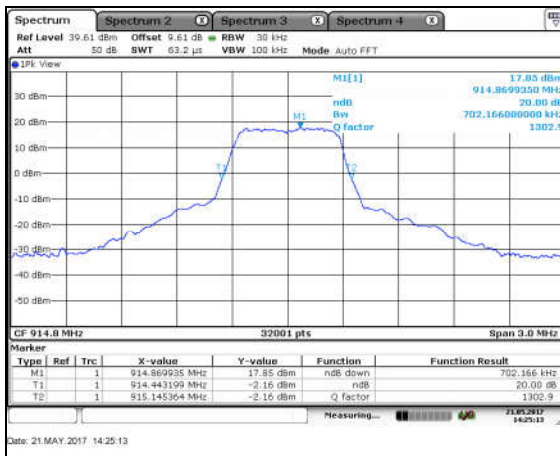

Figure 7.3.2-2: 20dB Bandwidth – MCH

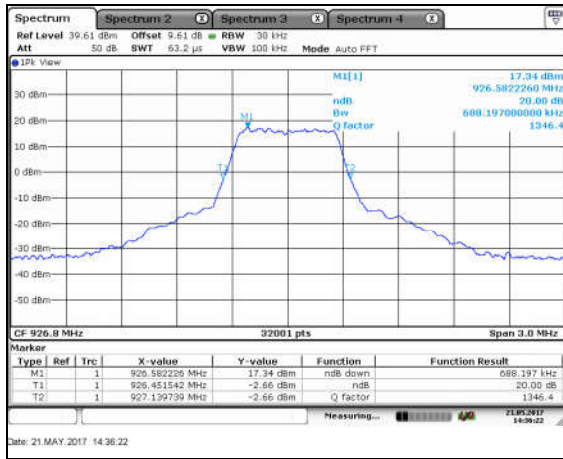

Figure 7.3.2-3: 20dB Bandwidth – HCH

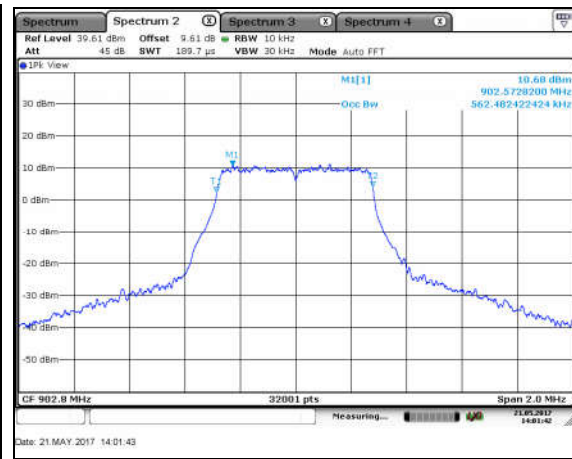

Figure 7.3.2-4: 99% Occupied Bandwidth – LCH

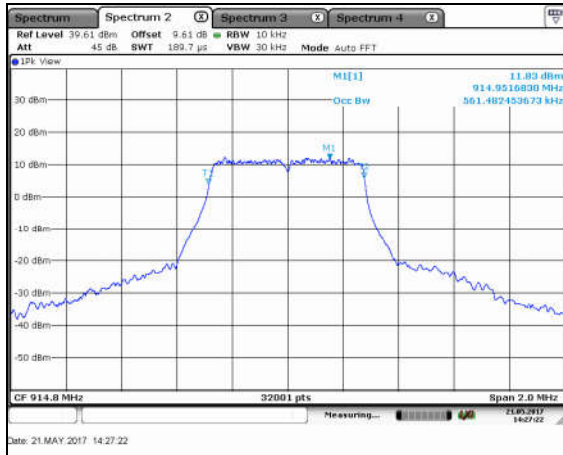

Figure 7.3.2-5: 99% Occupied Bandwidth – MCH

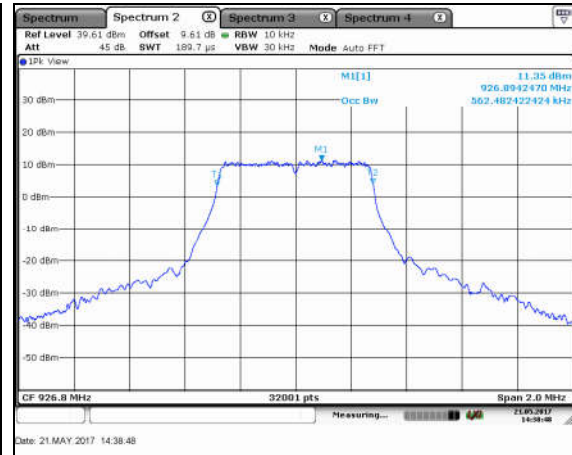

Figure 7.3.2-6: 99% Occupied Bandwidth – HCH

**7.4 Fundamental Emission Output Power – FCC: Section 15.247(b)(3); ISED Canada: RSS-247 5.4(d)****7.4.1 Measurement Procedure**

The maximum conducted output power was measured in accordance with FCC KDB 558074 D01 DTS Meas Guidance utilizing the PKPM1 procedure. The RF output of the equipment under test was directly connected to the input of the power meter applying suitable attenuation.

**7.4.2 Measurement Results**

Performed by: Ryan McGann

**Table 7.4.2-1: Maximum Conducted Output Power**

Frequency [MHz]	Level [dBm]
902.8	29.52
914.8	29.91
926.8	29.82

## 7.5 Channel Usage Requirements

### 7.5.1 Carrier Frequency Separation – FCC: Section 15.247(a)(1); ISED Canada: RSS-247 5.1(b)

#### 7.5.1.1 Measurement Procedure

The RF output port of the EUT was directly connected to the input of the spectrum analyzer using suitable attenuation. The span of the spectrum analyzer was set wide enough to capture two adjacent peaks. The RBW was set to approximately 30 % of the channel spacing and adjusted as necessary to best identify the center of each channel. The VBW was set > RBW.

#### 7.5.1.2 Measurement Results

Performed by: Ryan McGann

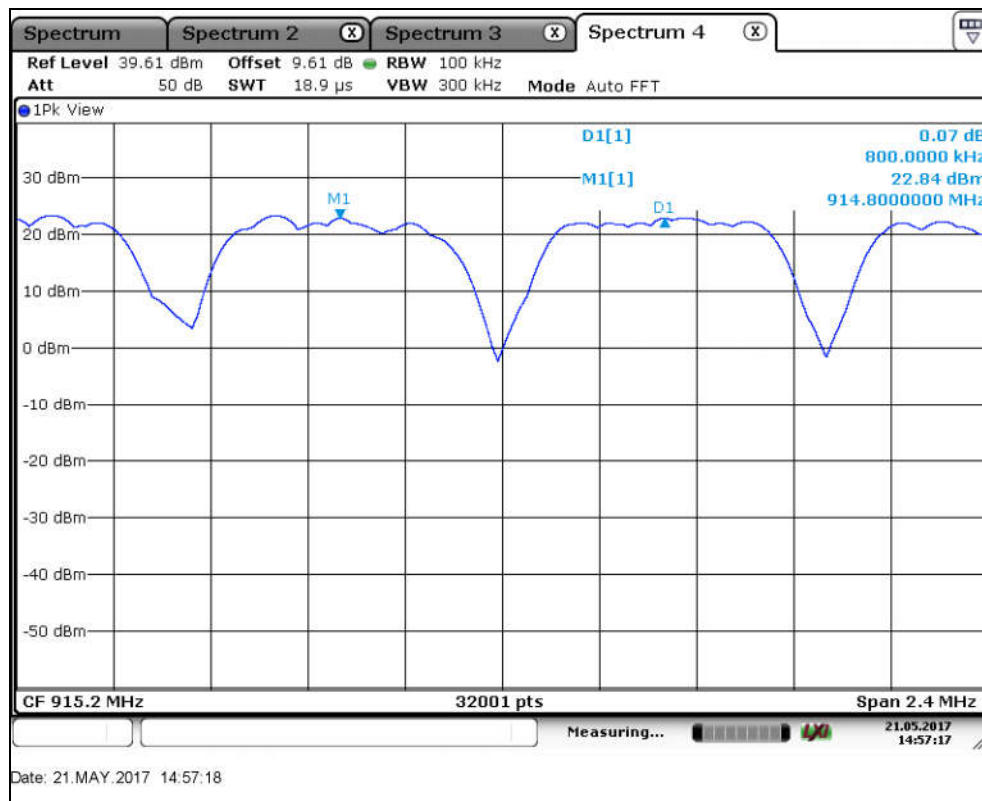

Figure 7.5.1.2-1: Frequency Separation



**7.5.2 Channel Dwell Time – FCC: Section 15.247(f); ISED Canada: RSS-247 5.3****7.5.2.1 Measurement Procedure**

The EUT was not capable of producing a worst-case channel dwell time. A detailed analysis of the channel dwell time is available in the Theory of Operations accompanying this report.

7.6 Emission Levels

7.6.1 Emissions into Non-Restricted Frequency Bands – FCC: Section 15.247(d); ISD Canada: RSS-247 5.5

7.6.1.1 Measurement Procedure

The unwanted emissions into non-restricted bands were measured conducted in accordance with FCC KDB 558074 D01 DTS Meas Guidance. The RF output of the equipment under test was directly connected to the input of the spectrum analyzer applying suitable attenuation. The Resolution Bandwidth (RBW) of the spectrum analyzer was set to 100 kHz. The Video Bandwidth (VBW) was set to ≥ 300 kHz. Span was set to 1.5 times the DTS bandwidth centered on each channel evaluated. The trace was set to max hold with a peak detector active. The resulting spectrum analyzer peak level was used to determine the reference level with respect to the 20 dBc limit. The spectrum span was then adjusted for the measurement of spurious emissions from 30 MHz to 10 GHz, 10 times the highest fundamental frequency.

Band-edge compliance was determined using the conducted marker-delta method in which the radio frequency power that is produced by the EUT is at least 20 dB below that in the 100 kHz bandwidth within the band that contains the highest level of desired power.

7.6.1.2 Measurement Results

Performed by: Ryan McGann

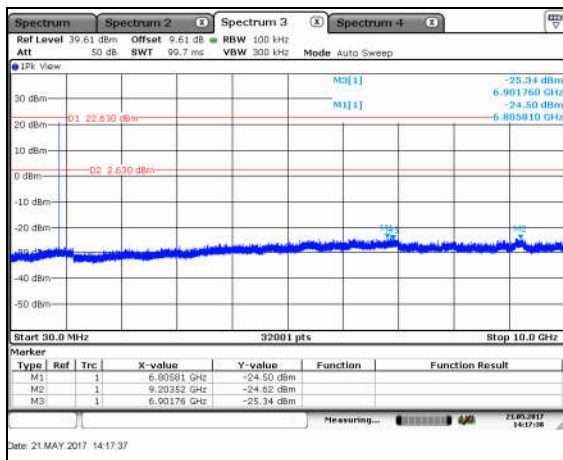

Figure 7.6.1.2-1: RF Conducted Emissions – LCH

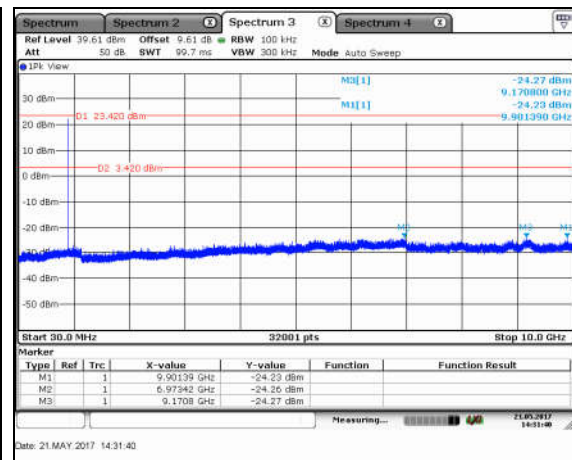

Figure 7.6.1.2-2: RF Conducted Emissions – MCH

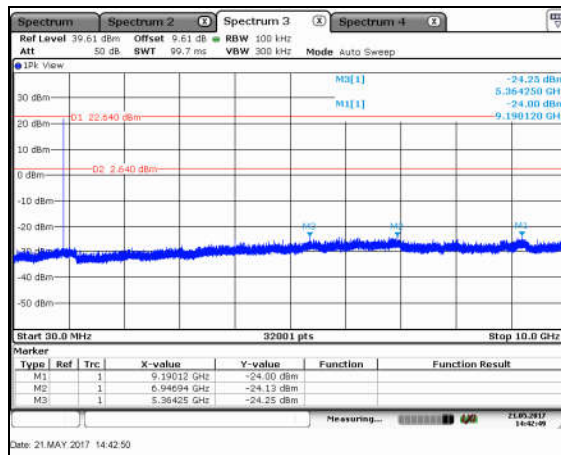

Figure 7.6.1.2-3: RF Conducted Emissions – HCH

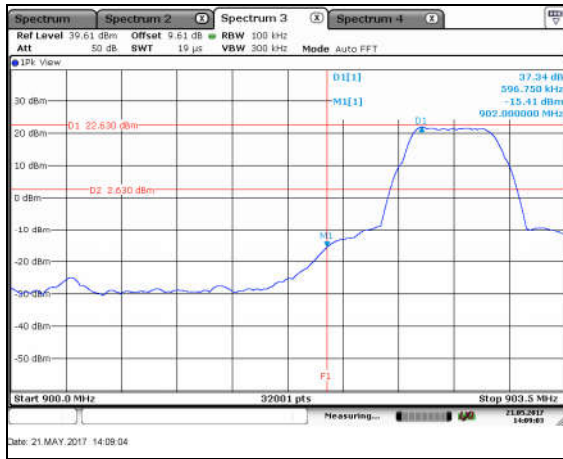

Figure 7.6.1.2-4: Lower Band-edge

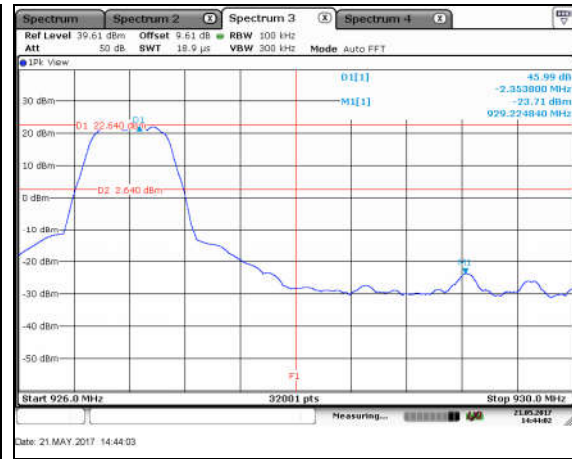

Figure 7.6.1.2-5: Upper Band-edge

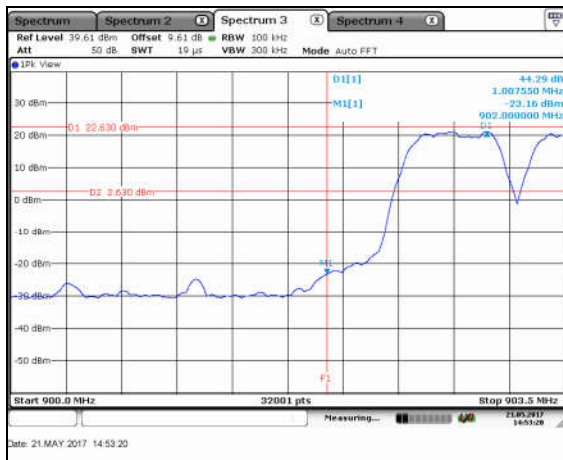

Figure 7.6.1.2-6: Lower Band-edge – Hopping

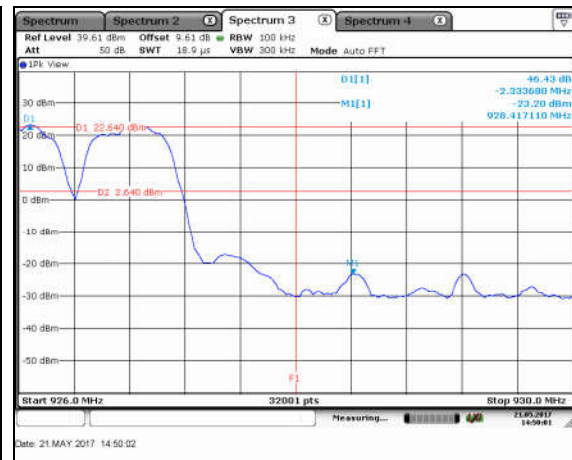

Figure 7.6.1.2-7: Upper Band-edge – Hopping

## 7.6.2 Emissions into Restricted Frequency Bands – FCC: Sections 15.205, 15.209; ISED Canada: RSS-Gen 8.9 / 8.10

### 7.6.2.1 Measurement Procedure

The unwanted emissions into restricted bands were measured radiated over the frequency range of 30 MHz to 10 GHz, 10 times the highest fundamental frequency.

The EUT was rotated through 360° and the receive antenna height was varied from 1 meter to 4 meters so that the maximum radiated emissions level would be detected. For frequencies below 1000 MHz, quasi-peak measurements were made using a resolution bandwidth RBW of 120 kHz and a video bandwidth VBW of 300 kHz. For frequencies above 1000 MHz, peak and average measurements were made with RBW and VBW of 1 MHz and 3 MHz respectively.

Each emission found to be in a restricted band as defined by section 15.205, including any emission at the operational band-edge, was compared to the radiated emission limits as defined in section 15.209.

### 7.6.2.2 Measurement Results

Performed by: Wayne Orwig

**Table 7.6.2.2-1: Radiated Spurious Emissions Tabulated Data**

Frequency (MHz)	Level (dBuV)		Antenna Polarity (H/V)	Correction Factors (dB)	Corrected Level (dBuV/m)		Limit (dBuV/m)		Margin (dB)	
	pk	Qpk/Avg			pk	Qpk/Avg	pk	Qpk/Avg	pk	Qpk/Avg
<b>Low Channel</b>										
2708.4	51.51	42.72	H	-3.90	47.61	38.82	74.0	54.0	26.4	15.2
2708.4	52.06	43.88	V	-3.90	48.16	39.98	74.0	54.0	25.8	14.0
<b>Mid Channel</b>										
2744.4	53.01	46.71	H	-3.80	49.21	42.91	74.0	54.0	24.8	11.1
2744.4	52.48	45.43	V	-3.80	48.68	41.63	74.0	54.0	25.3	12.4
<b>High Channel</b>										
2780.4	55.08	47.73	H	-3.70	51.38	44.03	74.0	54.0	22.6	10.0
2780.4	53.37	47.40	V	-3.70	49.67	43.70	74.0	54.0	24.3	10.3

### 7.6.2.3 Sample Calculation:

$$R_c = R_u + CF_T$$

Where:

- CF<sub>T</sub> = Total Correction Factor (AF+CA+AG)-DC (Average Measurements Only)
- R<sub>u</sub> = Uncorrected Reading
- R<sub>c</sub> = Corrected Level
- AF = Antenna Factor
- CA = Cable Attenuation
- AG = Amplifier Gain
- DC = Duty Cycle Correction Factor

#### Example Calculation: Peak

Corrected Level: 51.51 - 3.90 = 47.61dBuV/m  
 Margin: 74dBuV/m – 47.61dBuV/m = 26.4dB

#### Example Calculation: Average

Corrected Level: 42.72 - 3.90 - 0 = 38.82dBuV  
 Margin: 54dBuV – 38.82dBuV = 15.2dB

**7.7 Maximum Power Spectral Density – FCC: Section 15.247(e) ISED Canada: RSS-247 5.3(b)**

**7.7.1 Measurement Procedure**

The power spectral density was measured in accordance with the FCC KDB 558074 D01 DTS Meas Guidance utilizing the PKPSD method. The RF output of the equipment under test was directly connected to the input of the spectrum analyzer applying suitable attenuation. The Resolution Bandwidth (RBW) of the spectrum analyzer was set to 3 kHz. The Video Bandwidth (VBW) was set to 10 kHz. Span was set to 1.5 times the DTS Bandwidth. The trace was set to Max Hold with a peak detector active.

**7.7.2 Measurement Results**

Performed by: Ryan McGann

**Table 7.7.2-1: Power Spectral Density**

Frequency [MHz]	PSD Level [dBm]
902.8	6.15
914.8	7.81
926.8	7.15

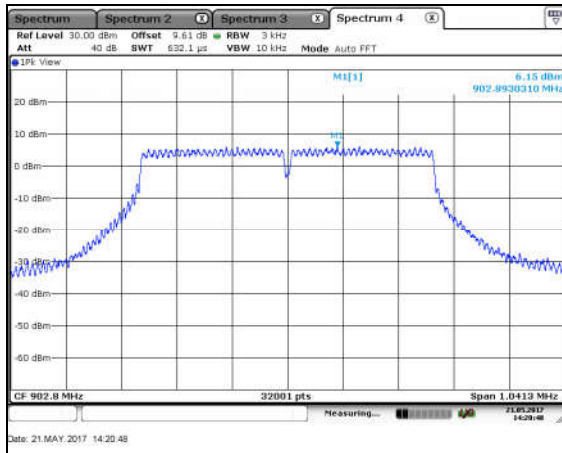

**Figure 7.7.2-1: Power Spectral Density – LCH**

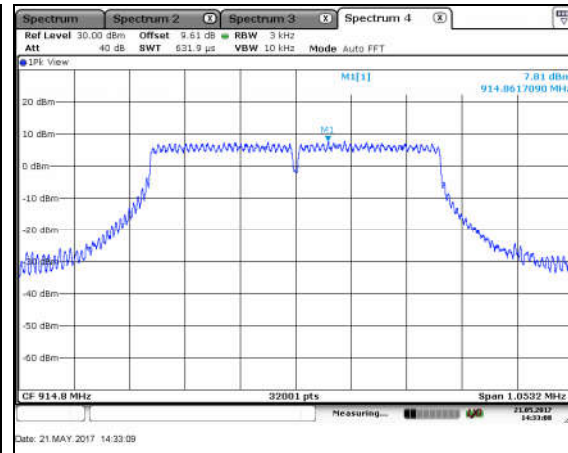

**Figure 7.7.2-2: Power Spectral Density – MCH**

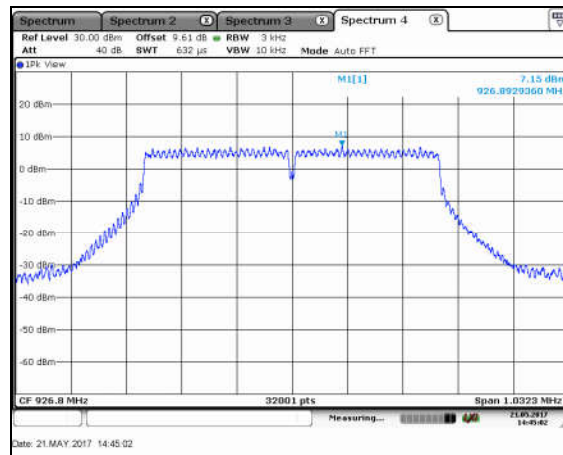

**Figure 7.7.2-3: Power Spectral Density – HCH**

## 8 ESTIMATION OF MEASUREMENT UNCERTAINTY

The expanded laboratory measurement uncertainty figures ( $U_{\text{Lab}}$ ) provided below correspond to an expansion factor (coverage factor)  $k = 1.96$  which provide confidence levels of 95%.

Parameter	$U_{\text{lab}}$
Occupied Channel Bandwidth	$\pm 0.009 \%$
RF Conducted Output Power	$\pm 0.349 \text{ dB}$
Power Spectral Density	$\pm 0.372 \text{ dB}$
Antenna Port Conducted Emissions	$\pm 1.264 \text{ dB}$
Radiated Emissions $\leq 1 \text{ GHz}$	$\pm 5.814 \text{ dB}$
Radiated Emissions $> 1 \text{ GHz}$	$\pm 4.318 \text{ dB}$
Temperature	$\pm 0.860 \text{ }^\circ\text{C}$
Radio Frequency	$\pm 2.832 \times 10^{-8}$
AC Power Line Conducted Emissions	$\pm 3.360 \text{ dB}$

## 9 CONCLUSION

In the opinion of TÜV SÜD America, Inc. the OW1, manufactured by Itron, Inc. meets the requirements of FCC Part 15 subpart C and ISED Canada's Radio Standards Specification RSS-247 for the tests documented in this test report.

# END REPORT