



Certification Test Report

**FCC ID: SK9CAT1
IC: 864G-CAT1**

**FCC Rule Part: 15.247
ISED Canada Radio Standards Specification: RSS-247**

Report Number: AT72151409-1C1

**Manufacturer: Itron, Inc.
Model: CAT1**

**Test Begin Date: July 10, 2019
Test End Date: August 7, 2019**

Report Issue Date: September 30, 2019



FOR THE SCOPE OF ACCREDITATION UNDER Certificate Number: 2955.09

This report must not be used by the client to claim product certification, approval, or endorsement by A2LA, NIST, or any agency of the Federal Government.

Prepared By:

**Jeremy Pickens
Senior Wireless Engineer
TÜV SÜD America Inc.**

Reviewed by:

**Ryan McGann
Senior Engineer
TÜV SÜD America Inc.**

This test report shall not be reproduced except in full. This report may be reproduced in part with prior written consent of TÜV SÜD America Inc. The results contained in this report are representative of the sample(s) submitted for evaluation.

This report contains 31 pages



TABLE OF CONTENTS

1	GENERAL	3
1.1	PURPOSE	3
1.2	PRODUCT DESCRIPTION	3
1.3	TEST METHODOLOGY AND CONSIDERATIONS.....	4
2	TEST FACILITIES	5
2.1	LOCATION.....	5
2.2	LABORATORY ACCREDITATIONS/RECOGNITIONS/CERTIFICATIONS	5
2.3	RADIATED EMISSIONS TEST SITE DESCRIPTION	6
2.3.1	<i>Semi-Anechoic Chamber Test Site</i>	6
2.4	CONDUCTED EMISSIONS TEST SITE DESCRIPTION.....	7
2.4.1	<i>Conducted Emissions Test Site</i>	7
3	APPLICABLE STANDARD REFERENCES	8
4	LIST OF TEST EQUIPMENT	8
5	SUPPORT EQUIPMENT	9
6	EQUIPMENT UNDER TEST SETUP BLOCK DIAGRAM	9
7	SUMMARY OF TESTS	10
7.1	ANTENNA REQUIREMENT – FCC 15.203.....	10
7.2	POWER LINE CONDUCTED EMISSIONS – FCC 15.207, ISED CANADA: RSS-GEN 8.8	10
7.2.1	<i>Measurement Procedure</i>	10
7.2.2	<i>Measurement Results</i>	10
7.3	6dB / 99% BANDWIDTH – FCC 15.247(A)(2), ISED CANADA: RSS-247 5.2(A) / RSS-GEN 6.7 12	
7.3.1	<i>Measurement Procedure</i>	12
7.3.2	<i>Measurement Results</i>	12
7.4	FUNDAMENTAL EMISSION OUTPUT POWER – FCC 15.247(B)(3), ISED CANADA: RSS-247 5.4(D) 15	
7.4.1	<i>Measurement Procedure</i>	15
7.4.2	<i>Measurement Results</i>	15
7.5	EMISSION LEVELS	16
7.5.1	<i>Emissions into Non-restricted Frequency Bands – FCC 15.247(d); ISED Canada: RSS-247 5.5</i>	16
7.5.2	<i>Emissions into Restricted Frequency Bands – FCC: 15.205, 15.209; ISED Canada: RSS-Gen 8.9 / 8.10</i>	20
7.6	MAXIMUM POWER SPECTRAL DENSITY IN THE FUNDAMENTAL EMISSION – FCC 15.247(E) ISED CANADA: RSS-247 5.2(B)	23
7.6.1	<i>Measurement Procedure</i>	23
7.6.2	<i>Measurement Results</i>	23
7.7	DUTY CYCLE	25
7.7.1	<i>Measurement Procedure</i>	25
7.7.2	<i>Measurement Results</i>	25
8	ESTIMATION OF MEASUREMENT UNCERTAINTY	26
9	CONCLUSION	26
	APPENDIX A: PLOTS	27

1 GENERAL

1.1 Purpose

The purpose of this report is to demonstrate compliance with Part 15 Subpart C of the FCC's Code of Federal Regulations and Innovation, Science, and Economic Development Canada's Radio Standards Specification RSS-247 Certification for modular approval.

1.2 Product Description

The Itron CAT1 is an electricity metering module which includes a 910 MHz to 921.8 MHz transceiver as well as an 802.11bgn WLAN transceiver. The module operates on AC power which is supplied by a host device.

This test report documents the compliance of the WLAN transceiver mode of operation.

Technical Information:

Detail	Description
Frequency Range	2412 – 2462 MHz
Number of Channels	802.11b/g/n (HT 20): 11 802.11n (HT 40): 7
Modulation Format	802.11b: DSSS (DBPSK / DQPSK / CCK) 802.11g/n (HT 20/40): OFDM (BPSK / QPSK / 16QAM / 64QAM)
Data Rates	802.11b: 1 – 11 Mbps 802.11g: 6 – 54 Mbps 802.11n (HT 20): 6.5 – 72 Mbps 802.11n (HT 40): 13.5 – 150 Mbps
Number of Inputs/Outputs	1T1R
Operating Voltage	120Vac, 60Hz
Antenna Type / Gain	PCB Trace / 4.57dBi Max

Manufacturer Information:

Itron, Inc.
313 N Hwy 11
West Union, SC 29696

Test Sample Serial Number: Not labeled

Test Sample Condition: The test samples were provided in good working order with no visible defects.

1.3 Test Methodology and Considerations

All modes of operation, including all data rates, were evaluated and the data presented in this report represents the worst case where applicable. The worst-case data rate for 802.11b mode was 1Mbps. The worst-case data rate for 802.11g mode was 6Mbps. The worst-case data rate for 802.11n (HT 20) mode was MCS0. The worst-case data rate for 802.11n (HT 40) mode was MCS0.

For radiated emissions, the EUT was evaluated in three orthogonal orientations. The worst-case orientation was Y-position. See test setup photos for more information.

For AC power line conducted emissions the EUT was directly connected to the AC mains using the wiring that would normally be connected to the meter.

For RF Conducted measurements, the EUT was connected to the test equipment with an MMX to SMA adapter. The EUT was programmed to generate a continuously modulated signal on each channel evaluated.

Radiated inter-modulation testing was performed for all combinations of simultaneous transmission and found to be compliant.

Power setting during test – 802.11b:	12
Power setting during test – 802.11g:	20
Power setting during test – 802.11n (HT 20):	20
Power setting during test – 802.11n (HT 40):	20

2 TEST FACILITIES**2.1 Location**

The radiated and conducted emissions test sites are located at the following addresses:

TÜV SÜD America, Inc.
5945 Cabot Pkwy, Suite 100
Alpharetta, GA 30005
Phone: (678) 341-5900

2.2 Laboratory Accreditations/Recognitions/Certifications

TÜV SÜD America, Inc. is accredited to ISO/IEC 17025 by the American Association for Laboratory Accreditation/A2LA accreditation program and has been issued certificate number 2955.09 in recognition of this accreditation.

Unless otherwise specified, all tests methods described within this report are covered under the ISO/IEC 17025 scopes of accreditation.

The Semi-Anechoic Chamber Test Sites and Conducted Emissions Sites have been fully described, submitted to, and accepted by the FCC, ISED Canada and the Japanese Voluntary Control Council for Interference by information technology equipment.

FCC Designation Accreditation Number:	US1233
ISED Canada Lab Code:	23932
VCCI Member Number:	1831
• VCCI Registration Number	A-0295

2.3 Radiated Emissions Test Site Description

2.3.1 Semi-Anechoic Chamber Test Site

The Semi-Anechoic Chamber Test Site consists of a 20'W x 30'L x 20'H shielded enclosure. The chamber is lined with ETS-Lindgren Ferrite Absorber, model number FT-1500. The ferrite tile 600 mm x 600 mm (2.62 in x 23.62 in) panels and are mounted directly on the inner walls of the chamber shield.

The specular regions of the chamber are lined with additional ETS-Lindgren PS-600 hybrid absorber to extend its frequency range up to 18GHz and beyond.

The turntable is a 2m ETS-Lindgren Model 2170 and installed off the center axis is located 5'6" from the back wall of the chamber. The chamber is grounded via 1 - 8' copper ground rod, installed at the center of the back wall, it is bound to the shield using #8 solid copper wire.

The antenna mast is an EMCO 1060 and is remotely controlled from the control room for both antenna height and polarization.

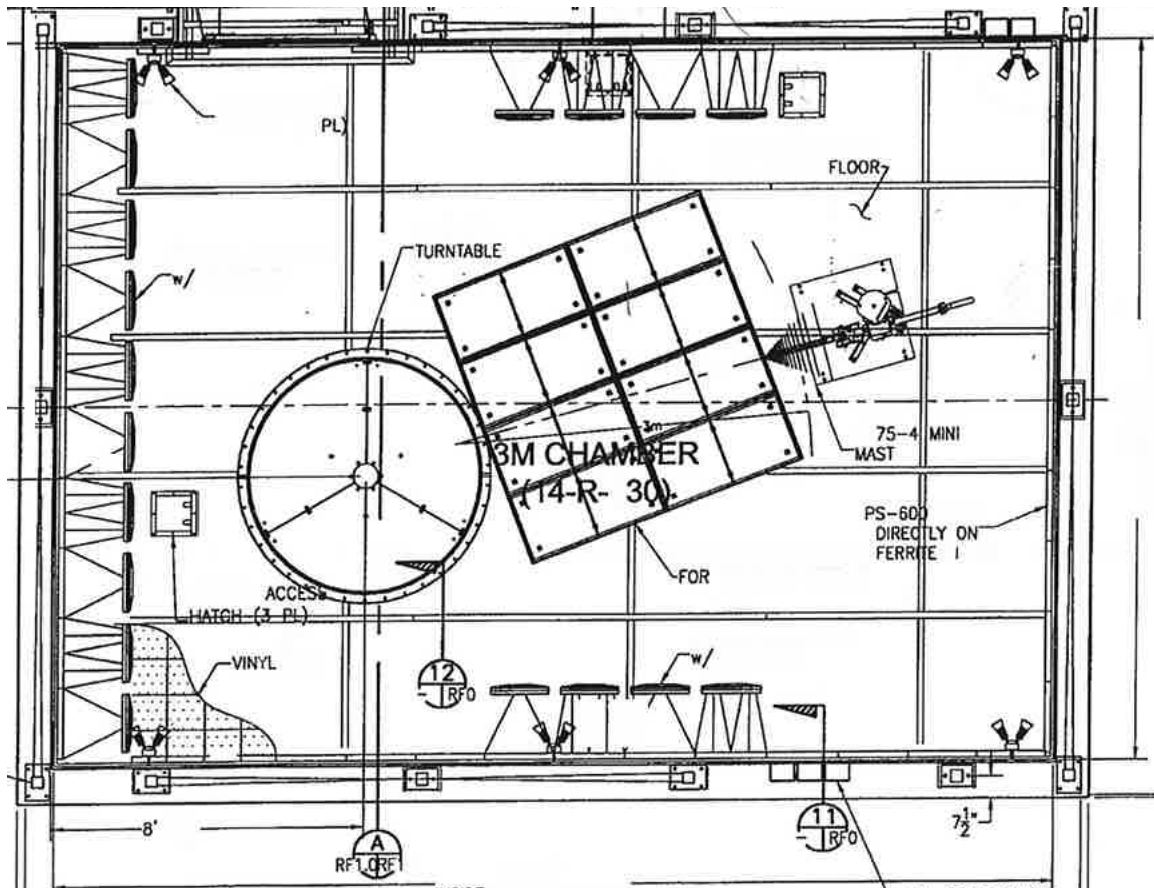

Figure 2.3.1-1: Semi-Anechoic Chamber Test Site

2.4 Conducted Emissions Test Site Description

2.4.1 Conducted Emissions Test Site

The AC mains conducted EMI site is located in the main EMC lab. It consists of a 12' x 10' horizontal coupling plane (HCP) as well as a 12'x8' vertical coupling plane (VCP). The HCP is constructed of 4' x 10' sheets of particle board sandwiched by galvanized steel sheets. These panels are bonded using 11AWG 1/8" x 2" by 10' galvanized sheet steel secured to the panels via by screws. The VCP is constructed of three 4'x8' sheets of 11AWG solid aluminum.

The HCP and VCP are electrically bonded together using 1"x1" angled aluminum secured with screws.

The site is of sufficient size to test table top and floor standing equipment in accordance with section 6.1.4 of ANSI C63.10.

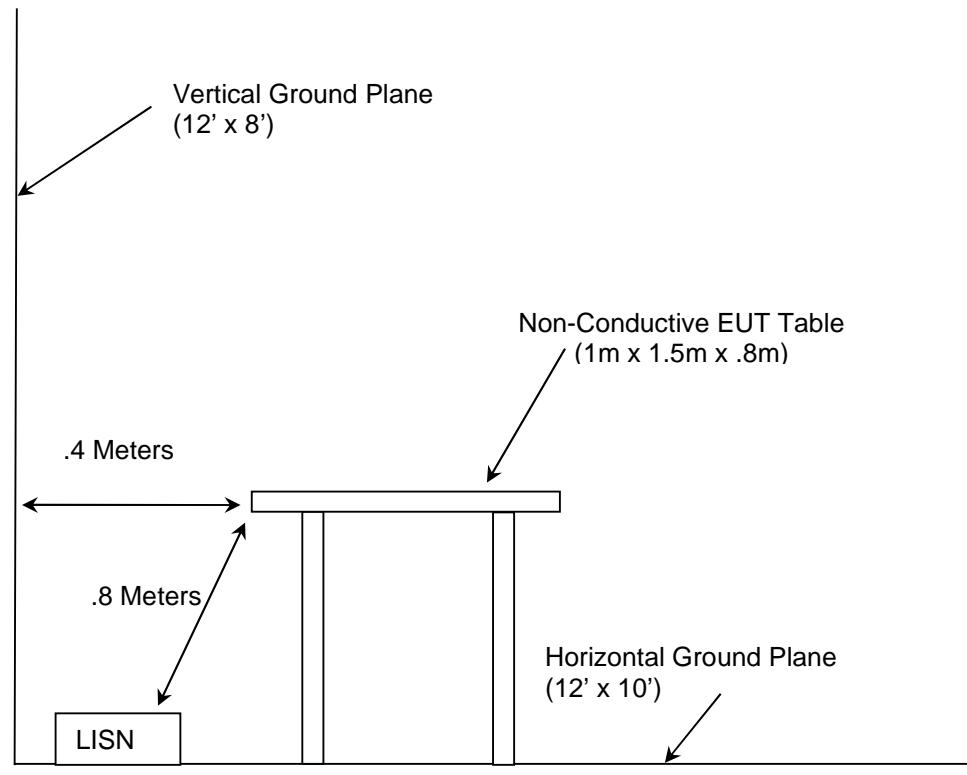

Figure 2.4.1-1: AC Mains Conducted EMI Site

3 APPLICABLE STANDARD REFERENCES

The following standards were used:

- ❖ ANSI C63.10-2013: American National Standard of Procedures for Compliance Testing of Unlicensed Wireless Devices.
- ❖ US Code of Federal Regulations (CFR): Title 47, Part 2, Subpart J: Equipment Authorization Procedures, 2019
- ❖ US Code of Federal Regulations (CFR): Title 47, Part 15, Subpart C: Radio Frequency Devices, Intentional Radiators, 2019
- ❖ FCC KDB 558074 D01 DTS Meas Guidance v05r02 - Guidance for Performing Compliance Measurements on Digital Transmission Systems (DTS) Operating Under §15.247, April 2, 2019
- ❖ ISED Canada Radio Standards Specification: RSS-247 – Digital Transmission Systems (DTSs), Frequency Hopping Systems (FHSs) and Licence-Exempt Local Area Network (LE-LAN) Devices, Issue 2, February 2017.
- ❖ ISED Canada Radio Standards Specification: RSS-GEN – General Requirements for Compliance of Radio Apparatus, Issue 5, April 2018 + Amendment 1, March 2019

4 LIST OF TEST EQUIPMENT

The calibration interval of test equipment is annually or the manufacturer's recommendations. Where the calibration interval deviates from the annual cycle based on the instrument manufacturer's recommendations, it shall be stated below.

Table 4-1: Test Equipment

Asset ID	Manufacturer	Model	Equipment Type	Serial Number	Last Calibration Date	Calibration Due Date
22	Hewlett Packard	8449B	High Frequency Pre-Amp	3008A00526	07/11/2018	07/11/2020
213	TEC	PA 102	Amplifier	44927	07/22/2019	07/22/2020
324	ACS	Belden	Conducted EMI Cable	8214	03/19/2019	03/19/2020
329	A.H.Systems	SAS-571	Horn Antenna	721	08/03/2017	08/03/2019
335	Suhner	SF-102A	Cable (40GHZ)	882/2A	07/08/2019	07/08/2020
345	Suhner Sucoflex	102A	Cable 42(GHZ)	1077/2A	07/09/2019	07/09/2020
432	Microwave Circuits	H3G020G4	Highpass Filter	264066	05/31/2019	05/31/2020
622	Rohde & Schwarz	FSV40 (v3.40)	FSV Signal Analyzer 10Hz to 40GHz	101338	07/30/2018	07/30/2020
628	EMCO	6502	Active Loop Antenna 10kHz-30MHz	9407-2877	02/11/2019	11/02/2021
651	Rohde & Schwarz	TS-PR26	18GHz to 26.5GHz Pre-Amplifier	100023	07/10/2019	07/10/2020
652	Rohde & Schwarz	3160-09	High Frequency Antenna 18GHz to 26.5GHz	060922-21894	NCR	NCR
813	PMM	9010	EMI Receiver; RF Input 50ohm; 10Hz-50MHz; 10Hz-30MHz	697WW30606	02/25/2019	02/25/2020
819	Rohde & Schwarz	ESR26	EMI Test Receiver	101345	11/06/2018	11/06/2019
836	ETS Lindgren	SAC Cable Set	SAC Cable Set includes 620, 837, 838	N/A	05/01/2019	05/01/2020
853	Teseq	CBL 6112D; 6804.17.A	Bilog Antenna; Attenuator	51616; 20181110A	10/15/2018	10/15/2019
871	(-)	RF Cable	RF Cable(CE Cable)	871	03/18/2019	03/18/2020
3010	Rohde & Schwarz	ENV216	Two-Line V-Network	3010	07/10/2019	07/10/2020

NCR = No Calibration Required

NOTE: All test equipment was used only during active calibration cycles as reported above.

5 SUPPORT EQUIPMENT

Table 5-1: Support Equipment

Item	Equipment Type	Manufacturer	Model/Part Number	Serial Number
1	Interface Board	Not labeled	Not labeled	N/A
2	AC/DC Adapter	Phihong	PSM08A-052	N/A

Table 5-2: Cable Description

Cable	Cable Type	Length	Shield	Termination
A	DC Power	1.75m	No	Interface Board to AC/DC Adapter
B	AC Power Cable	1.8m	No	EUT to AC Mains

Note: AC power cable only present during radiated measurements and AC port conducted emissions.

6 EQUIPMENT UNDER TEST SETUP BLOCK DIAGRAM

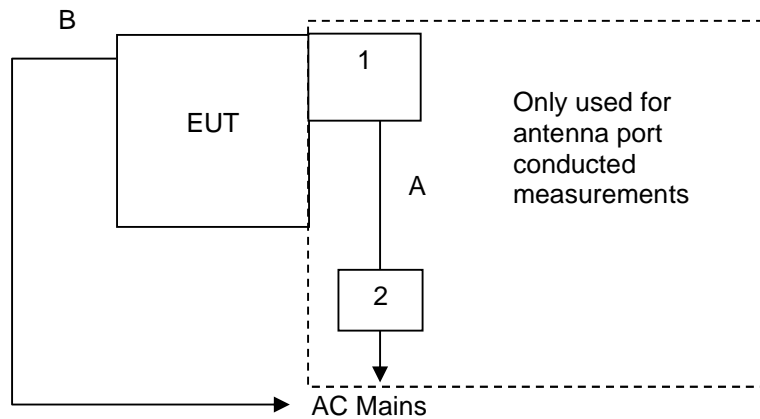

Figure 6-1: Test Setup Block Diagram

7 SUMMARY OF TESTS

Along with the tabular data shown below, plots were taken of all signals deemed important enough to document.

7.1 Antenna Requirement – FCC 15.203

The EUT utilizes a PCB trace antenna. The antenna is integral to the device and cannot be removed or replaced by the end user. The gain of the antenna is 4.57dBi max.

7.2 Power Line Conducted Emissions – FCC 15.207, ISED Canada: RSS-Gen 8.8

7.2.1 Measurement Procedure

Conducted emissions were performed from 150kHz to 30MHz with the spectrum analyzer's resolution bandwidth set to 9kHz and the video bandwidth set to 30kHz. The calculation for the conducted emissions is as follows:

Corrected Reading = Analyzer Reading + LISN Loss + Cable Loss

Margin = Corrected Reading - Applicable Limit

7.2.2 Measurement Results

Performed by: Eugene Sello

Table 7.2.2-1: Conducted EMI Results

Frequency (MHz)	Corrected Reading		Limit		Margin		Correction (dB)
	Quasi-Peak	Average	Quasi-Peak	Average	Quasi-Peak	Average	
	(dB μ V)	(dB μ V)	(dB μ V)	(dB μ V)	(dB)	(dB)	
0.15	32.84	20.51	66	56	-33.16	-35.49	9.61
0.162	33.02	22.13	65.36	55.36	-32.34	-33.23	9.58
0.182	34.38	22.13	64.39	54.39	-30.01	-32.26	9.58
0.194	37.46	26.81	63.86	53.86	-26.4	-27.05	9.59
0.214	36.06	26.35	63.05	53.05	-26.99	-26.7	9.61
0.266	34.06	23.46	61.24	51.24	-27.18	-27.78	9.62
0.502	25.39	13.91	56	46	-30.61	-32.09	9.66
0.546	25.76	21.55	56	46	-30.24	-24.45	9.66
0.694	31.3	24.73	56	46	-24.7	-21.27	9.71
1.074	28.56	19.97	56	46	-27.44	-26.03	9.78

Table 7.2.2-2: Conducted EMI Results

Frequency (MHz)	Corrected Reading		Limit		Margin		Correction (dB)
	Quasi-Peak	Average	Quasi-Peak	Average	Quasi-Peak	Average	
	(dB μ V)	(dB μ V)	(dB μ V)	(dB μ V)	(dB)	(dB)	
0.15	31.04	20.5	66	56	-34.96	-35.5	9.62
0.162	30.2	21.85	65.36	55.36	-35.16	-33.51	9.63
0.19	36.11	21.06	64.04	54.04	-27.93	-32.98	9.63
0.202	39.36	25.08	63.53	53.53	-24.17	-28.45	9.62
0.274	33.36	24.73	61	51	-27.64	-26.27	9.62
0.506	25.39	14.76	56	46	-30.61	-31.24	9.67
0.514	25.38	13.84	56	46	-30.62	-32.16	9.67
0.53	25.35	16.36	56	46	-30.65	-29.64	9.67
0.574	25.27	13.22	56	46	-30.73	-32.78	9.69
2.25	27.44	25.69	56	46	-28.56	-20.31	9.87

7.3 6dB / 99% Bandwidth – FCC 15.247(a)(2), ISED Canada: RSS-247 5.2(a) / RSS-GEN 6.7

7.3.1 Measurement Procedure

The 6dB bandwidth was measured in accordance with the FCC KDB 558074 D01 Section 8.2 which references Subclause 11.8 of ANSI C63.10. The Resolution Bandwidth (RBW) of the spectrum analyzer was set to 100 kHz. The Video Bandwidth (VBW) was set to ≥ 3 times the RBW. The trace was set to max hold with a peak detector active. The marker-delta function of the spectrum analyzer was utilized to determine the 6 dB bandwidth of the emission.

The occupied bandwidth measurement function of the spectrum analyzer was used to measure the 99% bandwidth. The span of the analyzer was set to capture all products of the modulation process, including the emission sidebands. The resolution bandwidth was set from 1% to 5% of the occupied bandwidth and the video bandwidth set to at least 3 times the resolution bandwidth. A peak detector was used.

7.3.2 Measurement Results

Performed by: Jeremy Pickens

Table 7.3.2-1: 6dB / 99% Bandwidth

Modulation	Frequency (MHz)	6dB Bandwidth (MHz)	99% Bandwidth (MHz)
802.11b	2412	10.10	14.60
	2437	10.15	14.70
	2462	10.15	14.60
802.11g	2412	15.20	16.40
	2437	15.20	19.10
	2462	15.40	16.40
802.11n(HT20)	2412	15.20	17.60
	2437	15.15	19.10
	2462	15.15	17.60
802.11n(HT40)	2422	33.85	33.75
	2437	33.90	36.75
	2452	33.90	36.00

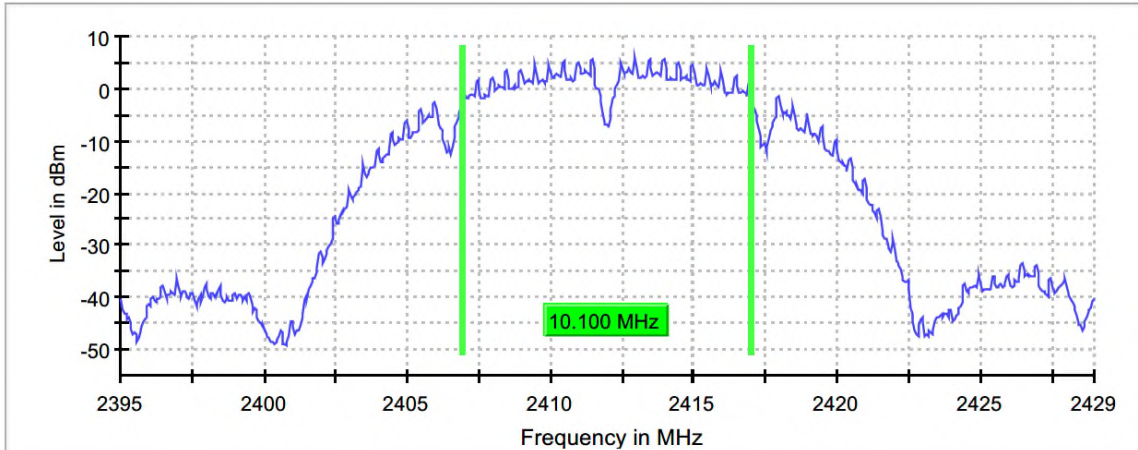

Figure 7.3.2-1: Sample Plot - 6dB BW

Table 7.3.2-2: Sample Measurement Settings (6dB BW)

Setting	Instrument Value	Target Value
Start Frequency	2.39500 GHz	2.39500 GHz
Stop Frequency	2.42900 GHz	2.42900 GHz
Span	34.000 MHz	34.000 MHz
RBW	100.000 kHz	~ 100.000 kHz
VBW	300.000 kHz	>= 300.000 kHz
SweepPoints	680	~ 680
Sweptime	37.891 μ s	AUTO
Reference Level	10.000 dBm	10.000 dBm
Attenuation	30.000 dB	AUTO
Detector	MaxPeak	MaxPeak
SweepCount	100	100
Filter	3 dB	3 dB
Trace Mode	Max Hold	Max Hold
Sweeptype	FFT	AUTO
Preamp	off	off
Stablemode	Trace	Trace
Stablevalue	0.50 dB	0.50 dB
Run	15 / max. 150	max. 150
Stable	5 / 5	5
Max Stable Difference	0.41 dB	0.50 dB

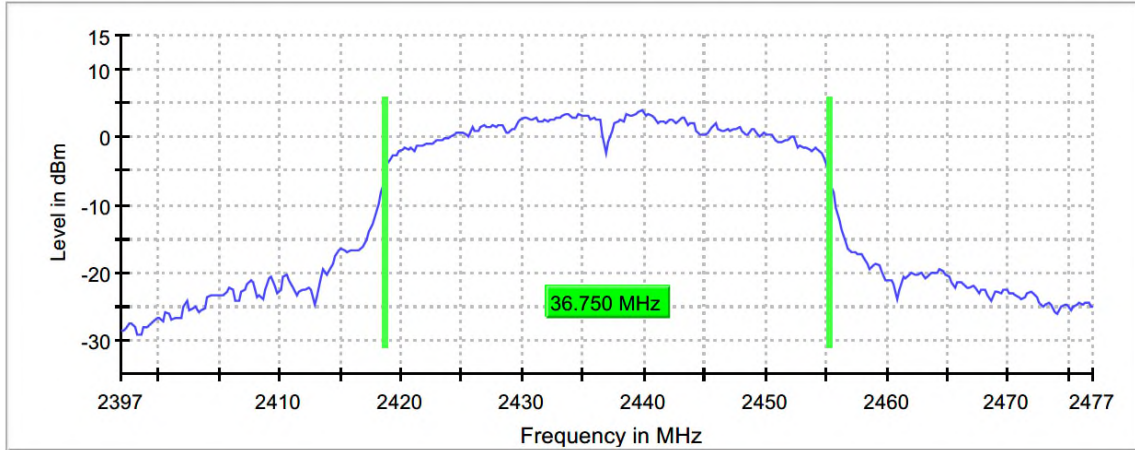

Figure 7.3.2-2: Sample Plot - 99% OBW

Table 7.3.2-3: Sample Measurement Settings (OBW)

Setting	Instrument Value	Target Value
Start Frequency	2.39700 GHz	2.39700 GHz
Stop Frequency	2.47700 GHz	2.47700 GHz
Span	80.000 MHz	80.000 MHz
RBW	500.000 kHz	>=400.000 kHz
VBW	2.000 MHz	>= 1.500 MHz
SweepPoints	320	~ 320
Sweeptime	18.906 μ s	AUTO
Reference Level	10.000 dBm	10.000 dBm
Attenuation	30.000 dB	AUTO
Detector	MaxPeak	MaxPeak
SweepCount	100	100
Filter	3 dB	3 dB
Trace Mode	Max Hold	Max Hold
Sweeptype	FFT	AUTO
Preamp	off	off
Stablemode	Trace	Trace
Stablevalue	0.30 dB	0.30 dB
Run	65 / max. 150	max. 150
Stable	3 / 3	3
Max Stable Difference	0.13 dB	0.30 dB

7.4 Fundamental Emission Output Power – FCC 15.247(b)(3), ISED Canada: RSS-247 5.4(d)**7.4.1 Measurement Procedure**

The maximum conducted output power was measured in accordance with FCC KDB 558074 D01 DTS Meas Guidance utilizing the AVGPM-G method. The RF output of the equipment under test was directly connected to the input of the power sensor applying suitable attenuation. Worst-case power across all data rates is reported.

7.4.2 Measurement Results

Performed by: Jeremy Pickens

Table 7.4.2-1: Conducted Output Power

Modulation	Frequency (MHz)	RMS Power (dBm)
802.11b	2412	10.3
	2437	10.4
	2462	10.6
802.11g	2412	12.2
	2437	14.4
	2462	12.1
802.11n(HT20)	2412	12.1
	2437	13.8
	2462	12.3
802.11n(HT40)	2422	8.3
	2437	12.3
	2452	7.4

7.5 Emission Levels

7.5.1 Emissions into Non-restricted Frequency Bands – FCC 15.247(d); ISED Canada: RSS-247 5.5

7.5.1.1 Measurement Procedure

The unwanted emissions into non-restricted bands were measured conducted in accordance with FCC KDB 558074 D01 Section 8.5. The RF output of the equipment under test was directly connected to the input of the spectrum analyzer applying suitable attenuation. The Resolution Bandwidth (RBW) of the spectrum analyzer was set to 100 kHz. The Video Bandwidth (VBW) was set to ≥ 300 kHz. The resulting spectrum analyzer peak level was used to determine the reference level with respect to the 30 dBc limit at the band edges. The spectrum span was then adjusted for the measurement of spurious emissions from 30MHz to 25GHz, 10 times the highest fundamental frequency. The worst-case for each modulation was investigated at the lower and upper band edges. For the 30MHz to 25GHz measurements, only the worst-case with respect to power was investigated: 802.11b, 1Mbps.

7.5.1.2 Measurement Results

Performed by: Jeremy Pickens

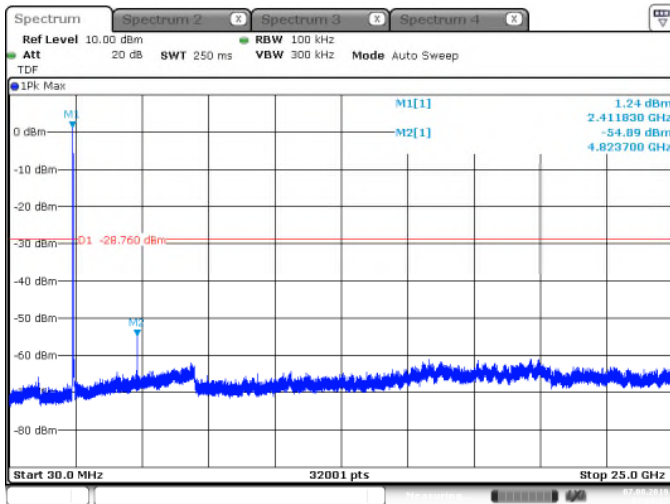

Date: 7.AUG.2019 07:17:17

Figure 7.5.1.2-1: 802.11b – LCH – 30MHz–25GHz

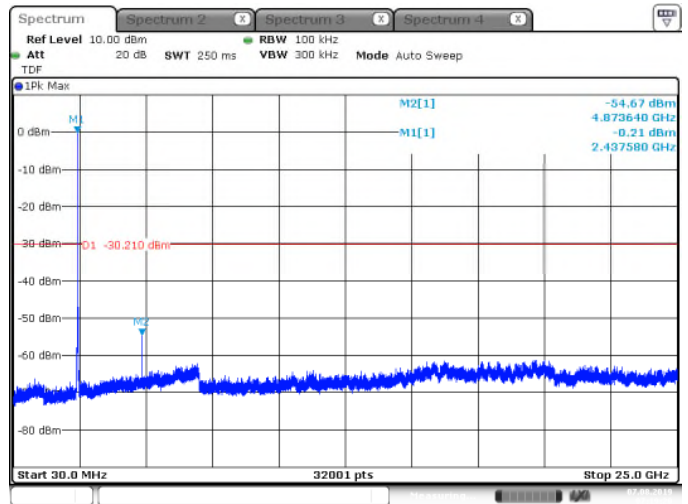

Date: 7.AUG.2019 07:19:20

Figure 7.5.1.2-2: 802.11b – MCH – 30MHz–25GHz

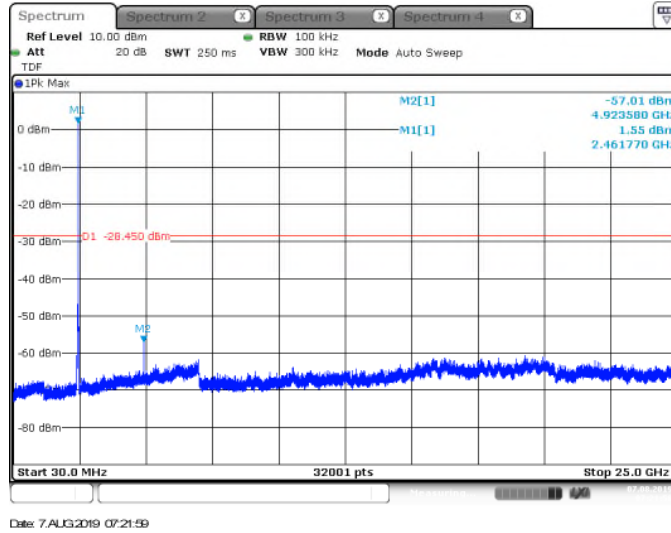

Figure 7.5.1.2-3: 802.11b – HCH – 30MHz–25GHz

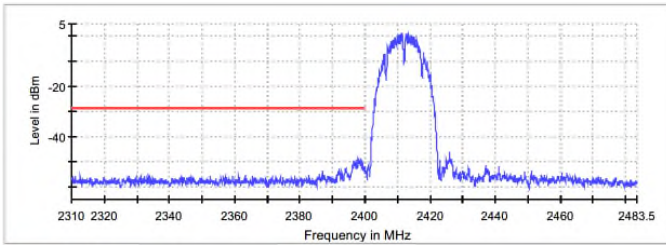

Figure 7.5.1.2-4: 802.11b – Lower Band-edge

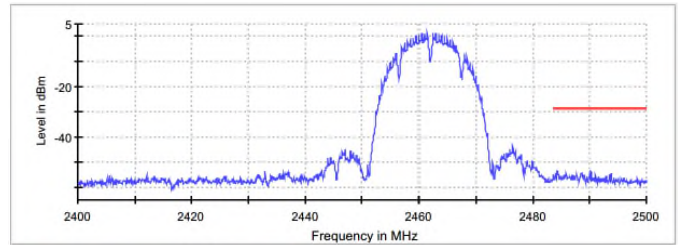

Figure 7.5.1.2-5: 802.11b – Upper Band-edge

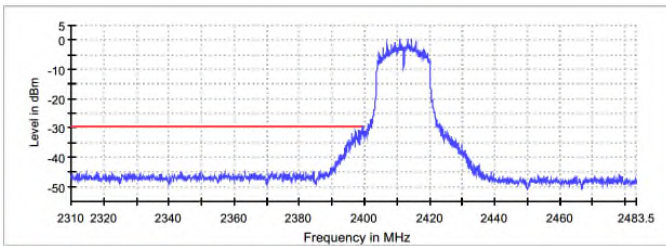

Figure 7.5.1.2-6: 802.11g – Lower Band-edge

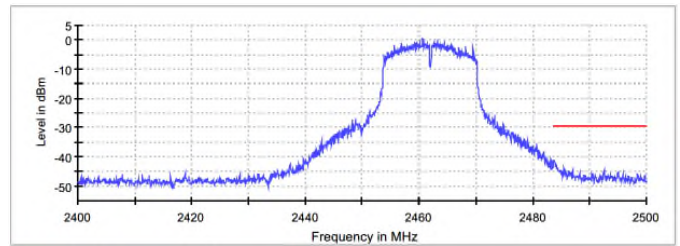

Figure 7.5.1.2-7: 802.11g – Upper Band-edge

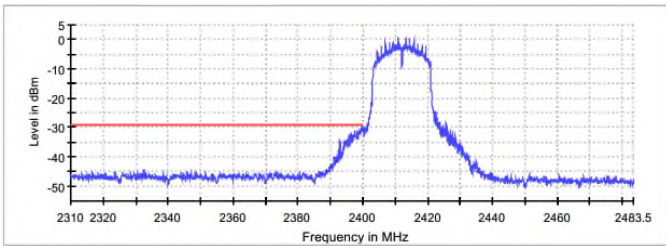

Figure 7.5.1.2-8: 802.11n20 – Lower Band-edge

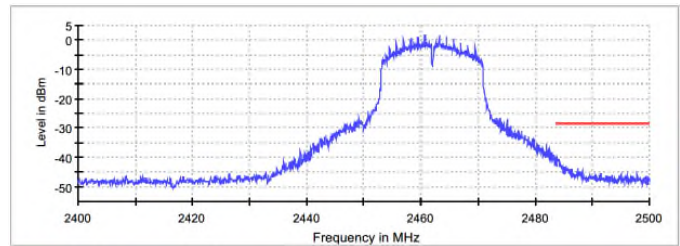

Figure 7.5.1.2-9: 802.11n20 – Upper Band-edge

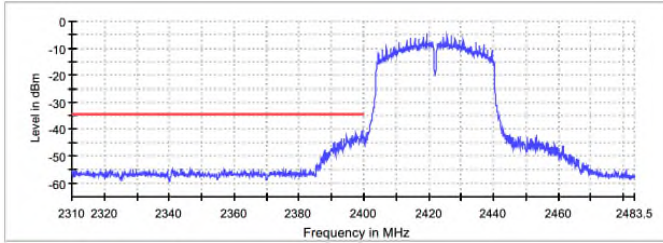

Figure 7.5.1.2-10: 802.11n40 – Lower Band-edge

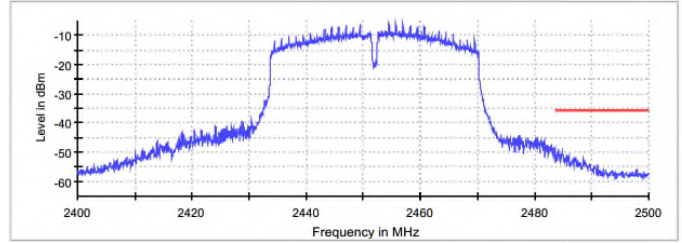

Figure 7.5.1.2-11: 802.11n40 – Upper Band-edge

Table 7.5.1.2-1: 802.11b – Lower Band-edge

Frequency (MHz)	Level (dBm)	Margin (dB)	Limit (dBm)	Result
2398.475000	-48.8	19.9	-28.8	PASS
2397.975000	-48.9	20.1	-28.8	PASS
2398.425000	-48.9	20.1	-28.8	PASS
2397.925000	-49.2	20.4	-28.8	PASS
2398.975000	-49.3	20.4	-28.8	PASS
2397.475000	-49.5	20.6	-28.8	PASS
2397.425000	-49.7	20.8	-28.8	PASS
2396.475000	-49.8	21.0	-28.8	PASS
2398.925000	-49.9	21.0	-28.8	PASS
2399.025000	-49.9	21.1	-28.8	PASS
2396.425000	-50.0	21.2	-28.8	PASS
2398.025000	-50.1	21.2	-28.8	PASS
2398.075000	-50.2	21.3	-28.8	PASS
2398.125000	-50.2	21.3	-28.8	PASS
2398.325000	-50.2	21.4	-28.8	PASS

Table 7.5.1.2-2: 802.11b – Upper Band-edge

Frequency (MHz)	Level (dBm)	Margin (dB)	Limit (dBm)	Result
2484.275000	-53.5	24.9	-28.6	PASS
2490.225000	-53.7	25.1	-28.6	PASS
2484.325000	-53.7	25.2	-28.6	PASS
2490.275000	-54.0	25.4	-28.6	PASS
2484.375000	-54.5	25.9	-28.6	PASS
2485.925000	-54.5	25.9	-28.6	PASS
2488.425000	-54.5	25.9	-28.6	PASS
2488.475000	-54.6	26.0	-28.6	PASS
2484.025000	-54.6	26.1	-28.6	PASS
2493.825000	-54.7	26.1	-28.6	PASS
2488.525000	-54.7	26.1	-28.6	PASS
2488.575000	-54.7	26.1	-28.6	PASS
2490.175000	-54.7	26.1	-28.6	PASS
2488.625000	-54.7	26.1	-28.6	PASS
2485.875000	-54.7	26.1	-28.6	PASS

Table 7.5.1.2-3: 802.11g – Lower Band-edge

Frequency (MHz)	Level (dBm)	Margin (dB)	Limit (dBm)	Result
2399.475000	-29.6	0.2	-29.4	PASS
2399.425000	-29.7	0.2	-29.4	PASS
2398.225000	-30.5	1.1	-29.4	PASS
2398.175000	-30.6	1.2	-29.4	PASS
2398.475000	-30.6	1.2	-29.4	PASS
2398.525000	-30.6	1.2	-29.4	PASS
2397.275000	-30.9	1.5	-29.4	PASS
2399.225000	-31.0	1.6	-29.4	PASS
2399.725000	-31.1	1.7	-29.4	PASS
2399.975000	-31.1	1.7	-29.4	PASS
2399.175000	-31.2	1.8	-29.4	PASS
2399.125000	-31.2	1.8	-29.4	PASS
2397.225000	-31.3	1.9	-29.4	PASS
2399.075000	-31.3	1.9	-29.4	PASS
2399.675000	-31.4	2.0	-29.4	PASS

Table 7.5.1.2-4: 802.11g – Upper Band-edge

Frequency (MHz)	Level (dBm)	Margin (dB)	Limit (dBm)	Result
2483.575000	-41.1	11.5	-29.6	PASS
2483.525000	-41.2	11.6	-29.6	PASS
2483.775000	-41.3	11.7	-29.6	PASS
2483.825000	-41.4	11.8	-29.6	PASS
2483.725000	-41.4	11.8	-29.6	PASS
2483.625000	-42.0	12.4	-29.6	PASS
2483.875000	-42.0	12.4	-29.6	PASS
2483.925000	-42.3	12.6	-29.6	PASS
2483.675000	-42.4	12.8	-29.6	PASS
2483.975000	-42.4	12.8	-29.6	PASS
2484.225000	-42.7	13.1	-29.6	PASS
2484.175000	-43.0	13.4	-29.6	PASS
2484.025000	-43.1	13.5	-29.6	PASS
2484.075000	-43.3	13.6	-29.6	PASS
2484.125000	-43.4	13.8	-29.6	PASS

Table 7.5.1.2-5: 802.11n20 – Lower Band-edge

Frequency (MHz)	Level (dBm)	Margin (dB)	Limit (dBm)	Result
2399.775000	-29.8	0.7	-29.1	PASS
2399.725000	-29.9	0.7	-29.1	PASS
2399.175000	-30.5	1.4	-29.1	PASS
2398.825000	-30.7	1.5	-29.1	PASS
2399.225000	-30.7	1.6	-29.1	PASS
2399.125000	-30.8	1.6	-29.1	PASS
2398.875000	-30.8	1.7	-29.1	PASS
2397.575000	-30.8	1.7	-29.1	PASS
2399.825000	-30.9	1.8	-29.1	PASS
2399.475000	-30.9	1.8	-29.1	PASS
2399.075000	-31.1	1.9	-29.1	PASS
2399.025000	-31.1	2.0	-29.1	PASS
2399.975000	-31.1	2.0	-29.1	PASS
2398.225000	-31.2	2.0	-29.1	PASS
2399.425000	-31.2	2.1	-29.1	PASS

Table 7.5.1.2-6: 802.11n20 – Upper Band-edge

Frequency (MHz)	Level (dBm)	Margin (dB)	Limit (dBm)	Result
2483.875000	-40.1	11.9	-28.2	PASS
2483.525000	-40.1	11.9	-28.2	PASS
2483.825000	-40.2	12.0	-28.2	PASS
2484.125000	-40.6	12.4	-28.2	PASS
2483.575000	-40.6	12.4	-28.2	PASS
2483.775000	-40.8	12.6	-28.2	PASS
2484.175000	-40.8	12.6	-28.2	PASS
2484.075000	-40.9	12.7	-28.2	PASS
2483.925000	-41.0	12.8	-28.2	PASS
2483.975000	-41.0	12.8	-28.2	PASS
2484.025000	-41.3	13.1	-28.2	PASS
2484.225000	-41.8	13.7	-28.2	PASS
2483.625000	-42.1	13.9	-28.2	PASS
2484.475000	-42.3	14.1	-28.2	PASS
2484.425000	-42.8	14.6	-28.2	PASS

Table 7.5.1.2-7: 802.11n40 – Lower Band-edge

Frequency (MHz)	Level (dBm)	Margin (dB)	Limit (dBm)	Result
2399.475000	-40.7	6.2	-34.5	PASS
2399.425000	-41.1	6.6	-34.5	PASS
2397.625000	-41.3	6.7	-34.5	PASS
2397.575000	-41.4	6.9	-34.5	PASS
2399.725000	-41.5	7.0	-34.5	PASS
2399.675000	-41.6	7.1	-34.5	PASS
2399.525000	-41.7	7.2	-34.5	PASS
2399.775000	-42.1	7.6	-34.5	PASS
2399.125000	-42.1	7.6	-34.5	PASS
2396.375000	-42.4	7.9	-34.5	PASS
2394.675000	-42.5	7.9	-34.5	PASS
2394.725000	-42.5	8.0	-34.5	PASS
2396.325000	-42.5	8.0	-34.5	PASS
2398.125000	-42.5	8.0	-34.5	PASS
2399.175000	-42.5	8.0	-34.5	PASS

Table 7.5.1.2-8: 802.11n40 – Upper Band-edge

Frequency (MHz)	Level (dBm)	Margin (dB)	Limit (dBm)	Result
2484.175000	-48.9	13.2	-35.7	PASS
2484.225000	-49.1	13.4	-35.7	PASS
2484.125000	-49.4	13.7	-35.7	PASS
2484.775000	-50.1	14.4	-35.7	PASS
2484.725000	-50.2	14.5	-35.7	PASS
2484.075000	-50.3	14.6	-35.7	PASS
2483.825000	-50.7	15.0	-35.7	PASS
2484.575000	-50.7	15.0	-35.7	PASS
2483.525000	-50.7	15.0	-35.7	PASS
2484.275000	-50.8	15.1	-35.7	PASS
2484.825000	-50.8	15.1	-35.7	PASS
2484.475000	-50.9	15.2	-35.7	PASS
2483.575000	-50.9	15.2	-35.7	PASS
2484.525000	-50.9	15.2	-35.7	PASS
2484.425000	-51.0	15.3	-35.7	PASS

7.5.2 Emissions into Restricted Frequency Bands – FCC: 15.205, 15.209; ISED Canada: RSS-Gen 8.9 / 8.10

7.5.2.1 Measurement Procedure

The unwanted emissions into restricted bands were measured radiated over the frequency range of 9kHz to 25GHz, 10 times the highest fundamental frequency.

The EUT was rotated through 360° and the receive antenna height was varied from 1 meter to 4 meters so that the maximum radiated emissions level would be detected. For frequencies below 1000 MHz, quasi-peak measurements were made using a resolution bandwidth RBW of 120 kHz and a video bandwidth VBW of 300 kHz. For frequencies above 1000 MHz, peak and average measurements were made with RBW and VBW of 1 MHz and 3 MHz respectively.

Each emission found to be in a restricted band as defined by section 15.205, including any emission at the operational band-edge, was compared to the radiated emission limits as defined in section 15.209.

7.5.2.2 Measurement Results

Performed by: Jeremy Pickens

Radiated spurious emissions found in the band of 30MHz to 25GHz are reported in the Tables 7.5.2.2-1 to 7.5.2.2-4 below.

Table 7.5.2.2-1: Radiated Spurious Emissions Tabulated Data – 802.11b

Frequency (MHz)	Level (dBuV)		Antenna Polarity (H/V)	Correction Factors (dB)	Corrected Level (dBuV/m)		Limit (dBuV/m)		Margin (dB)	
	pk	Qpk/Avg			pk	Qpk/Avg	pk	Qpk/Avg	pk	Qpk/Avg
2412 MHz										
2390	50.20	40.00	H	0.84	51.04	40.84	74.0	54.0	23.0	13.2
2390	48.20	37.20	V	0.84	49.04	38.04	74.0	54.0	25.0	16.0
4824	48.6	44.2	H	9.40	58.00	53.60	74.0	54.0	16.0	0.4
4824	48.6	43.3	V	9.40	58.00	52.70	74.0	54.0	16.0	1.3
2437 MHz										
4874	47.5	42.6	H	9.48	56.98	52.08	74.0	54.0	17.0	1.9
4874	46.6	40.7	V	9.48	56.08	50.18	74.0	54.0	17.9	3.8
2462 MHz										
2483.5	51.30	45.00	H	1.32	52.62	46.32	74.0	54.0	21.4	7.7
2483.5	52.30	44.60	V	1.32	53.62	45.92	74.0	54.0	20.4	8.1
4924	47.9	43.6	H	9.55	57.45	53.15	74.0	54.0	16.5	0.8
4924	46.5	41.2	V	9.55	56.05	50.75	74.0	54.0	17.9	3.2

Table 7.5.2.2-2: Radiated Spurious Emissions Tabulated Data – 802.11g

Frequency (MHz)	Level (dBuV)		Antenna Polarity (H/V)	Correction Factors (dB)	Corrected Level (dBuV/m)		Limit (dBuV/m)		Margin (dB)	
	pk	Qpk/Avg			pk	Qpk/Avg	pk	Qpk/Avg	pk	Qpk/Avg
2412 MHz										
2390	65.60	42.70	H	0.84	66.44	43.54	74.0	54.0	7.6	10.5
2390	66.50	44.10	V	0.84	67.34	44.94	74.0	54.0	6.7	9.1
4824	52.7	38.2	H	9.40	62.10	47.60	74.0	54.0	11.9	6.4
4824	54.2	39.5	V	9.40	63.60	48.90	74.0	54.0	10.4	5.1
2437 MHz										
4874	49.5	35.8	H	9.48	58.98	45.28	74.0	54.0	15.0	8.7
4874	48.3	34.3	V	9.48	57.78	43.78	74.0	54.0	16.2	10.2
2462 MHz										
2483.5	66.8	44.5	H	1.32	68.12	45.82	74.0	54.0	5.9	8.2
2483.5	67.4	45.1	V	1.32	68.72	46.42	74.0	54.0	5.3	7.6
4924	47.4	32.8	H	9.55	56.95	42.35	74.0	54.0	17.0	11.6
4924	50.3	35.7	V	9.55	59.85	45.25	74.0	54.0	14.1	8.7

Table 7.5.2.2-3: Radiated Spurious Emissions Tabulated Data – 802.11n (HT 20)

Frequency (MHz)	Level (dBuV)		Antenna Polarity (H/V)	Correction Factors (dB)	Corrected Level (dBuV/m)		Limit (dBuV/m)		Margin (dB)	
	pk	Qpk/Avg			pk	Qpk/Avg	pk	Qpk/Avg	pk	Qpk/Avg
2412 MHz										
2390	68.90	47.20	H	0.84	69.74	48.04	74.0	54.0	4.3	6.0
2390	65.70	44.00	V	0.84	66.54	44.84	74.0	54.0	7.5	9.2
4824	52.2	36.9	H	9.40	61.60	46.30	74.0	54.0	12.4	7.7
4824	51.5	36.3	V	9.40	60.90	45.70	74.0	54.0	13.1	8.3
2437 MHz										
4874	49.7	35.7	H	9.48	59.18	45.18	74.0	54.0	14.8	8.8
4874	50.9	36	V	9.48	60.38	45.48	74.0	54.0	13.6	8.5
2462 MHz										
2483.5	69.90	47.10	H	1.32	71.22	48.42	74.0	54.0	2.8	5.6
2483.5	69.5	46.7	V	1.32	70.82	48.02	74.0	54.0	3.2	6.0
4924	49.70	34.70	H	9.55	59.25	44.25	74.0	54.0	14.7	9.7
4924	47.5	33.1	V	9.55	57.05	42.65	74.0	54.0	16.9	11.3

Table 7.5.2.2-4: Radiated Spurious Emissions Tabulated Data – 802.11n (HT 40)

Frequency (MHz)	Level (dBuV)		Antenna Polarity (H/V)	Correction Factors (dB)	Corrected Level (dBuV/m)		Limit (dBuV/m)		Margin (dB)	
	pk	Qpk/Avg			pk	Qpk/Avg	pk	Qpk/Avg	pk	Qpk/Avg
2412 MHz										
2390	62.60	39.40	H	0.84	63.44	40.24	74.0	54.0	10.6	13.8
2390	58.20	35.80	V	0.84	59.04	36.64	74.0	54.0	15.0	17.4
2437 MHz										
No spurious emissions detected above the equipment noise floor.										
2462 MHz										
2483.5	64.30	41.50	H	1.32	65.62	42.82	74.0	54.0	8.4	11.2
2483.5	63.3	40.4	V	1.32	64.62	41.72	74.0	54.0	9.4	12.3

7.5.2.3 Sample Calculation:

$$R_c = R_u + CF_T$$

Where:

CF_T = Total Correction Factor (AF+CA+AG)-DC (Average Measurements Only)

R_u = Uncorrected Reading

R_c = Corrected Level

AF = Antenna Factor

CA = Cable Attenuation

AG = Amplifier Gain

DC = Duty Cycle Correction Factor

Example Calculation: Peak – 802.11b

Corrected Level: $48.6 + 9.4 = 58.0\text{dBuV/m}$

Margin: $74\text{dBuV/m} - 58.0\text{dBuV/m} = 16\text{dB}$

Example Calculation: Average – 802.11b

Corrected Level: $44.2 + 9.4 - 0 = 53.6\text{dBuV}$

Margin: $54\text{dBuV} - 53.6\text{dBuV} = 0.4\text{dB}$

7.6 Maximum Power Spectral Density in the Fundamental Emission – FCC 15.247(e) ISED Canada: RSS-247 5.2(b)

7.6.1 Measurement Procedure

The power spectral density was measured in accordance with the FCC KDB 558074 D01 DTS Meas Guidance utilizing the AVGPSD-3 method. The RF output of the equipment under test was directly connected to the input of the spectrum analyzer applying suitable attenuation. The Resolution Bandwidth (RBW) of the spectrum analyzer was set to 100 kHz. The Video Bandwidth (VBW) was set to 300 kHz. Span was set to 1.5 times the channel bandwidth. The trace was set to single sweep with the RMS detector active.

7.6.2 Measurement Results

Performed by: Jeremy Pickens

Table 7.6.2-1: Power Spectral Density

Modulation	Frequency (MHz)	PSD (dBm)
802.11b	2412	-1.963
	2437	-1.456
	2462	-1.899
802.11g	2412	-3.048
	2437	0.123
	2462	-2.301
802.11n(HT20)	2412	-2.171
	2437	0.018
	2462	-1.809
802.11n(HT40)	2422	-9.072
	2437	-4.754
	2452	-9.675

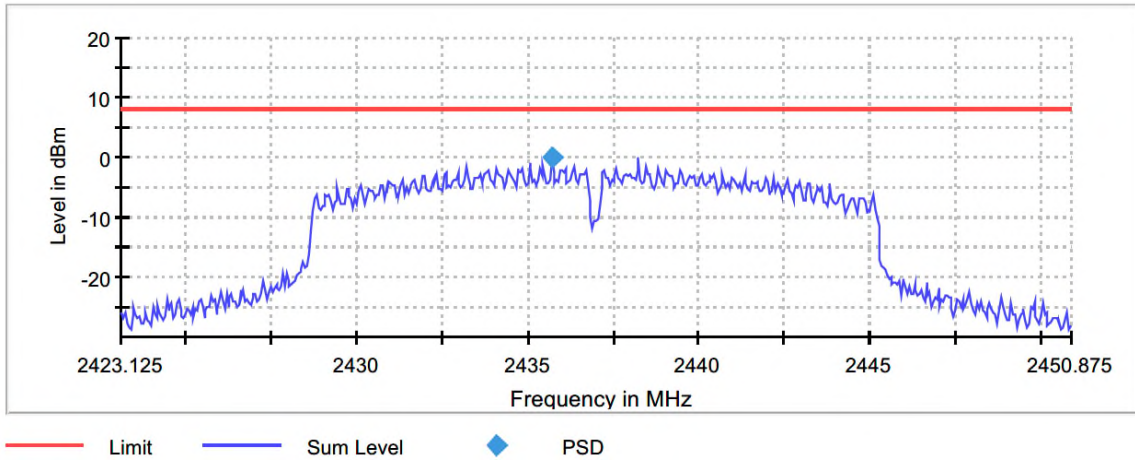

Figure 7.6.2-1: Sample PSD Plot

Table 7.6.2-2: Sample Measurement Settings (PSD)

Setting	Instrument Value	Target Value
Start Frequency	2.42313 GHz	2.42313 GHz
Stop Frequency	2.45088 GHz	2.45088 GHz
Span	27.750 MHz	27.750 MHz
RBW	100.000 kHz	<= 100.000 kHz
VBW	300.000 kHz	>= 300.000 kHz
SweepPoints	555	~ 555
Sweptime	11.100 ms	11.100 ms
Reference Level	10.000 dBm	10.000 dBm
Attenuation	30.000 dB	AUTO
Detector	RMS	RMS
SweepCount	1	1
Filter	3 dB	3 dB
Trace Mode	Max Hold	Max Hold
Sweeptype	Sweep	Sweep
Preamp	off	off
Stablemode	Trace	Trace
Stablevalue	0.50 dB	0.50 dB
Run	70 / max. 150	max. 150
Stable	3 / 3	3
Max Stable Difference	0.00 dB	0.50 dB

7.7 Duty Cycle

7.7.1 Measurement Procedure

The duty cycle was using a fast power sensor and meter in conjunction with the WMS32 software. The software recorded the on and off times over a sample period and reported the duty cycle.

7.7.2 Measurement Results

Performed by: Jeremy Pickens

The results for all the modes of operation are provided below.

Table 7.7.2-1 Duty Cycle Correction Factor

Mode	Data Rate	Duty Cycle (%)	Correction Factor (dB)
802.11b	1	99.3	0
802.11g	6	96.1	0.2
802.11n (HT 20)	MCS0	96.0	0.2
802.11n (HT 40)	MCS0	92.1	0.4

Note: The correction factor was calculated as $10 \cdot \log(1/DC)$

8 ESTIMATION OF MEASUREMENT UNCERTAINTY

The expanded laboratory measurement uncertainty figures (U_{Lab}) provided below correspond to an expansion factor (coverage factor) $k = 1.96$ which provide confidence levels of 95%.

Table 8-1: Estimation of Measurement Uncertainty

Parameter	U_{lab}
Occupied Channel Bandwidth	$\pm 0.009 \%$
RF Conducted Output Power	$\pm 0.349 \text{ dB}$
Power Spectral Density	$\pm 0.372 \text{ dB}$
Antenna Port Conducted Emissions	$\pm 1.264 \text{ dB}$
Radiated Emissions $\leq 1 \text{ GHz}$	$\pm 5.814 \text{ dB}$
Radiated Emissions $> 1 \text{ GHz}$	$\pm 4.318 \text{ dB}$
Temperature	$\pm 0.860 \text{ }^\circ\text{C}$
Radio Frequency	$\pm 2.832 \times 10^{-8}$
AC Power Line Conducted Emissions	$\pm 3.360 \text{ dB}$

9 CONCLUSION

In the opinion of TUV SUD the CAT1, manufactured by Itron, Inc. meets the requirements of FCC Part 15 subpart C and ISED Canada's Radio Standards Specification RSS-247 for the tests documented herein.

Appendix A: Plots

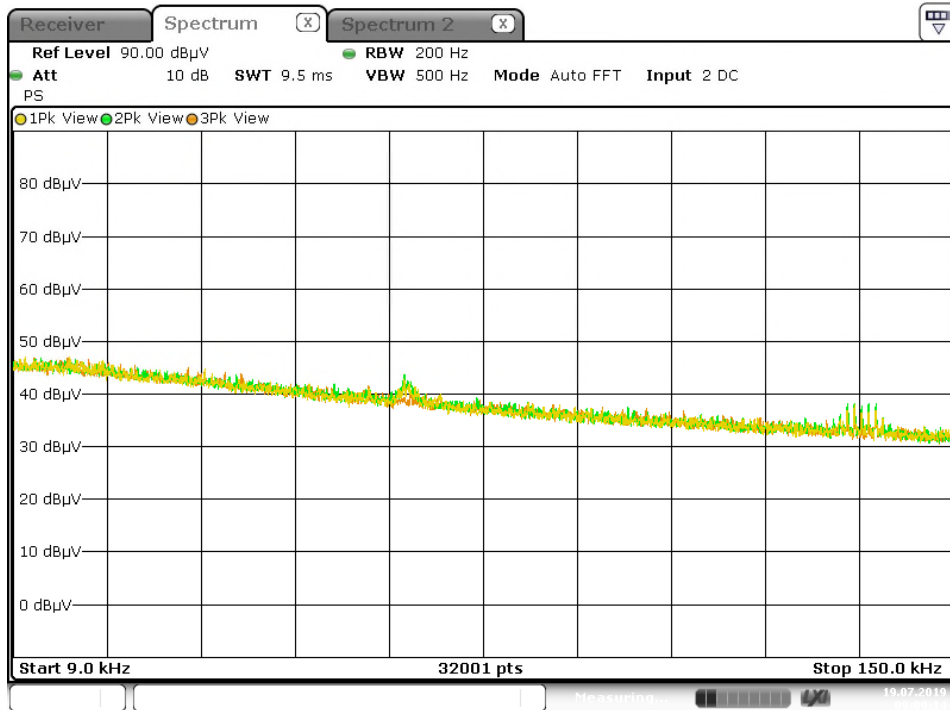

Date: 19.JUL.2019 09:09:14

Figure A-1: 9kHz-150kHz

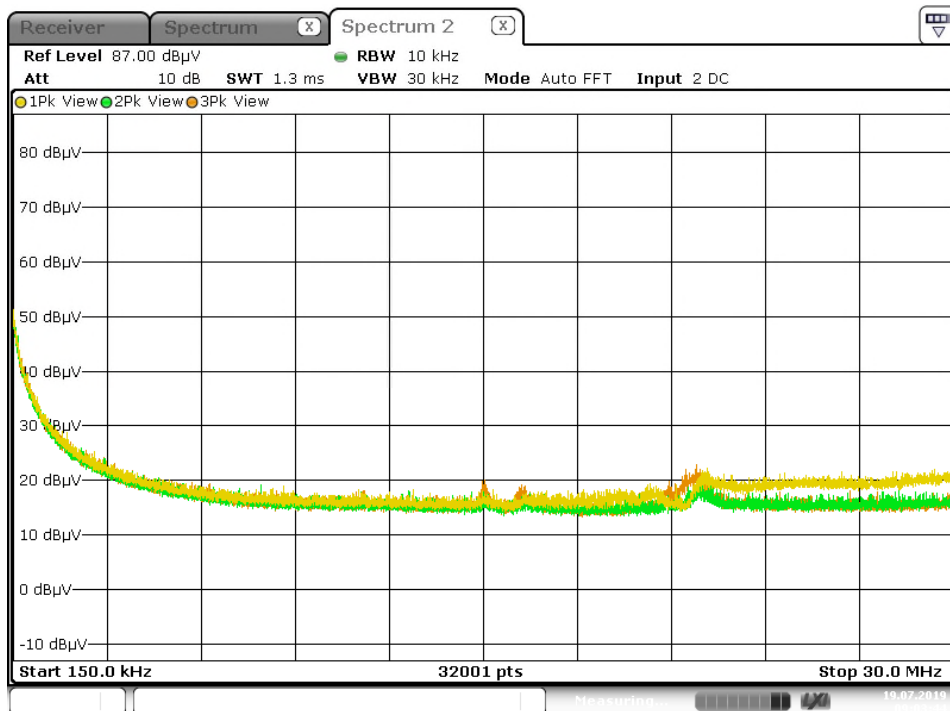

Date: 19.JUL.2019 09:03:43

Note: Emissions above the noise floor are ambient not associated with the DUT.

Figure A-2: 150kHz-30MHz

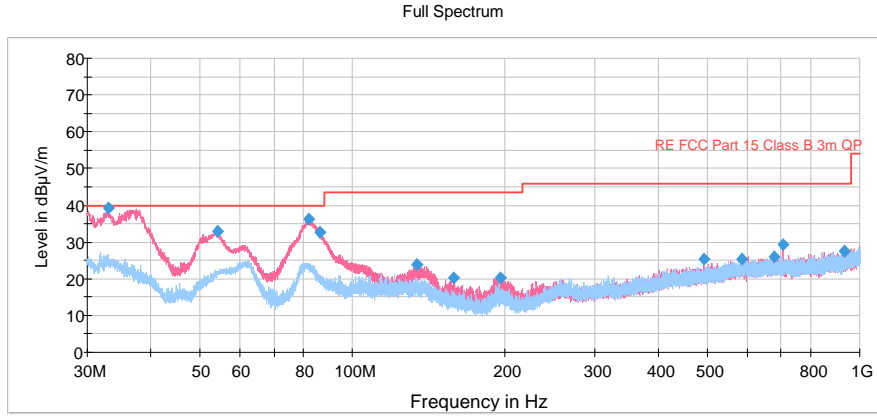

Note: Emissions above the noise floor are from the digital sections of the DUT and not associated with the radio.
Figure A-3: 30MHz-1GHz

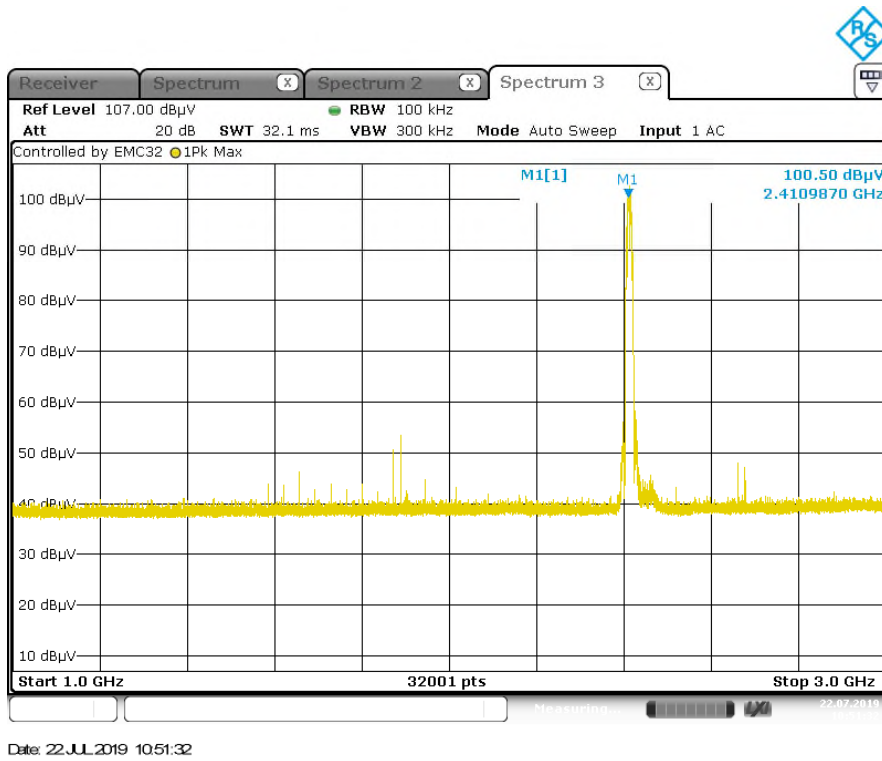

Note: Emissions above the noise floor are from the digital sections of the DUT and not associated with the radio.
Figure A-4: 1GHz-3GHz

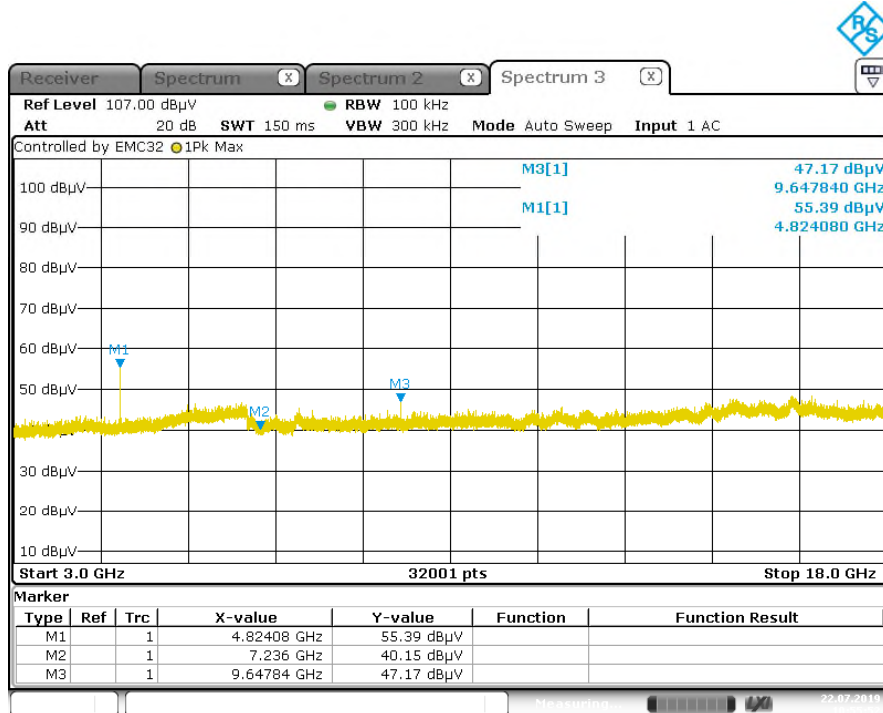

Figure A-5: 3GHz-18GHz

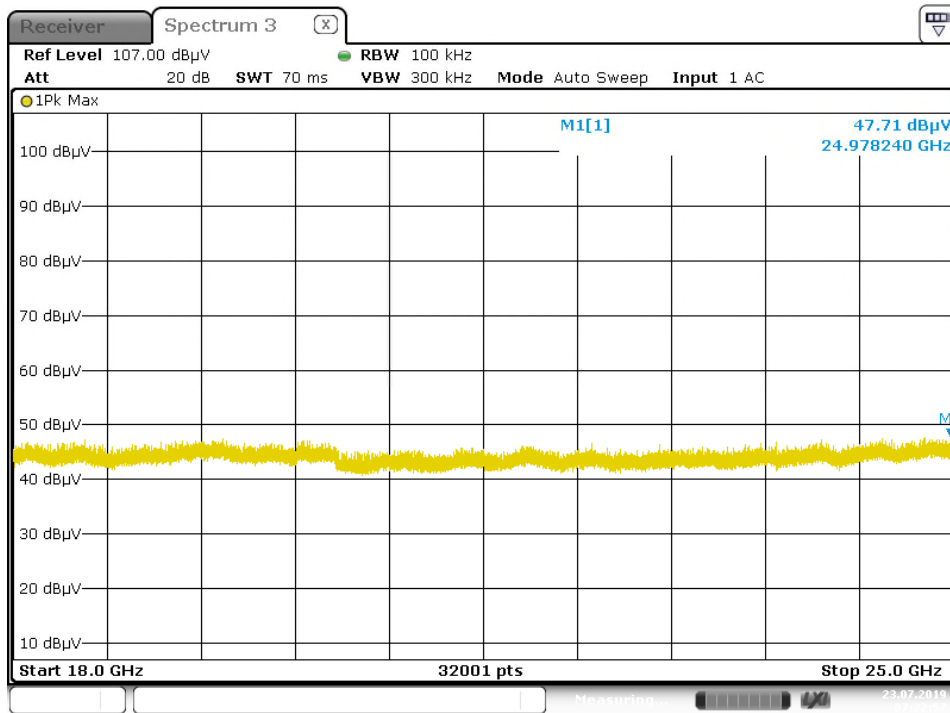

Figure A-6: 18GHz-25GHz

END REPORT