

## **Certification Test Report**

**FCC ID: SK9C1A-3B**  
**IC: 864G-C1A3B**

**FCC Rule Part: 15.247**  
**IC Radio Standards Specification: RSS-247**

**ACS Report Number: 15-0533.W06.1B**

**Manufacturer: Itron Electricity Metering, Inc.**  
**Model: C1A3B**

**Test Begin Date: February 22, 2016**  
**Test End Date: February 28, 2016**

**Report Issue Date: April 13, 2016**



FOR THE SCOPE OF ACCREDITATION UNDER Certificate Number AT-2021

This report must not be used by the client to claim product certification, approval, or endorsement by ANAB, NIST, or any agency of the Federal Government.

**Reviewed by:**

A handwritten signature in black ink, appearing to read "Kirby Munroe".

**Kirby Munroe**  
**Director, Wireless Certifications**  
**ACS, Inc.**

This test report shall not be reproduced except in full. This report may be reproduced in part with prior written consent of ACS, Inc. The results contained in this report are representative of the sample(s) submitted for evaluation.

**This report contains 22 pages**

# TABLE OF CONTENTS

<b>1</b>	<b>GENERAL</b> .....	<b>3</b>
1.1	PURPOSE.....	3
1.2	PRODUCT DESCRIPTION .....	3
1.3	TEST METHODOLOGY AND CONSIDERATIONS .....	3
<b>2</b>	<b>TEST FACILITIES</b> .....	<b>4</b>
2.1	LOCATION .....	4
2.2	LABORATORY ACCREDITATIONS/RECOGNITIONS/CERTIFICATIONS .....	4
2.3	RADIATED EMISSIONS TEST SITE DESCRIPTION .....	5
2.3.1	<i>Semi-Anechoic Chamber Test Site</i> .....	5
2.3.2	<i>Open Area Tests Site (OATS)</i> .....	6
2.4	CONDUCTED EMISSIONS TEST SITE DESCRIPTION .....	7
<b>3</b>	<b>APPLICABLE STANDARD REFERENCES</b> .....	<b>7</b>
<b>4</b>	<b>LIST OF TEST EQUIPMENT</b> .....	<b>8</b>
<b>5</b>	<b>SUPPORT EQUIPMENT</b> .....	<b>9</b>
<b>6</b>	<b>EQUIPMENT UNDER TEST SETUP BLOCK DIAGRAM</b> .....	<b>9</b>
<b>7</b>	<b>SUMMARY OF TESTS</b> .....	<b>10</b>
7.1	ANTENNA REQUIREMENT – FCC: SECTION 15.203 .....	10
7.2	POWER LINE CONDUCTED EMISSIONS – FCC 15.207, IC: RSS-GEN 8.8 .....	10
7.2.1	<i>Measurement Procedure</i> .....	10
7.2.2	<i>Measurement Results</i> .....	10
7.3	PEAK OUTPUT POWER - FCC 15.247(B)(2) IC: RSS-247 5.4(1) .....	12
7.3.1	<i>Measurement Procedure (Conducted Method)</i> .....	12
7.3.2	<i>Measurement Results</i> .....	12
7.4	CHANNEL USAGE REQUIREMENTS .....	13
7.4.1	<i>Carrier Frequency Separation – FCC 15.247(a)(1) IC: RSS-247 5.1(2)</i> .....	13
7.4.1.1	<i>Measurement Procedure</i> .....	13
7.4.1.2	<i>Measurement Results</i> .....	13
7.4.2	<i>Number of Hopping Channels – FCC 15.247(a)(1)(i) IC: RSS-247 5.1(3)</i> .....	14
7.4.2.1	<i>Measurement Procedure</i> .....	14
7.4.2.2	<i>Measurement Results</i> .....	14
7.4.3	<i>Channel Dwell Time – FCC 15.247(a)(1)(i) IC: RSS-247 5.1(3)</i> .....	15
7.4.3.1	<i>Measurement Procedure</i> .....	15
7.4.4	<i>20dB / 99% Bandwidth - FCC 15.247(a)(1)(i) IC: RSS-247 5.1(3)</i> .....	16
7.4.4.1	<i>Measurement Procedure</i> .....	16
7.4.4.2	<i>Measurement Results</i> .....	16
7.5	BAND-EDGE COMPLIANCE AND SPURIOUS EMISSIONS .....	18
7.5.1	<i>Band-Edge Compliance of RF Conducted Emissions - FCC 15.247(d); IC RSS-247 5.5</i> .....	18
7.5.1.1	<i>Measurement Procedure</i> .....	18
7.5.1.2	<i>Measurement Results</i> .....	18
7.5.2	<i>RF Conducted Spurious Emissions - FCC 15.247(d); IC RSS-247 5.5</i> .....	19
7.5.2.1	<i>Measurement Procedure</i> .....	19
7.5.2.2	<i>Measurement Results</i> .....	19
7.5.3	<i>Radiated Spurious Emissions - FCC 15.205, 15.209; RSS-Gen 8.9/8.10</i> .....	20
7.5.3.1	<i>Measurement Procedure</i> .....	20
7.5.3.2	<i>Duty Cycle Correction</i> .....	20
7.5.3.3	<i>Measurement Results</i> .....	20
7.5.3.4	<i>Sample Calculation:</i> .....	21
<b>8</b>	<b>CONCLUSION</b> .....	<b>22</b>

## 1 GENERAL

### 1.1 Purpose

The purpose of this report is to demonstrate compliance with Part 15 Subpart C of the FCC's Code of Federal Regulations and Industry Canada's Radio Standards Specification RSS-247 Certification for modular approval.

### 1.2 Product description

The C1A3B is an electricity metering module which includes a 909.6 MHz to 921.8 MHz transmitter. The module operates on AC as well as DC voltage which is supplied by a host device.

The C1A3B is designed to be integrated into the Itron CENTRON electric utility meter forms.

Technical Information:

Detail	Description
Frequency Range	909.6 – 921.8 MHz
Number of Channels	50
Modulation Format	OOK
Operating Voltage	24Vdc / 120Vac/60Hz (Host)
Antenna Type / Gain	¼ Wave Embedded Slot Antenna / 1.5 dBi gain

Manufacturer Information:  
Itron Electricity Metering, Inc.  
313 North Highway 11  
West Union, SC 29696

EUT Serial Numbers: Radiated - 9180000316, 9180000317, 9180000318; RF Conducted - 9810000396, 9810000406, 9810000377, 9810000373

Test Sample Condition: The test samples were provided in good working order with no visible defects.

### 1.3 Test Methodology and Considerations

All modes of operation, including all available data rates, were evaluated. The data presented in this report represents the worst case where applicable.

The EUT was evaluated in three orthogonal orientations. The worst case orientation was Z-position.

For power line conducted emissions, the EUT was powered by a representative wall wart power supply.

Software power setting during test: 50

## 2 TEST FACILITIES

### 2.1 Location

The radiated and conducted emissions test sites are located at the following address:

Advanced Compliance Solutions  
5015 B.U. Bowman Drive  
Buford, GA 30518  
Phone: (770) 831-8048  
Fax: (770) 831-8598

### 2.2 Laboratory Accreditations/Recognitions/Certifications

ACS is accredited to ISO/IEC 17025 by the ANSI-ASQ National Accreditation Board/ANAB accreditation program, and has been issued certificate number AT-2021 in recognition of this accreditation. Unless otherwise specified, all tests methods described within this report are covered under the ISO/IEC 17025 scope of accreditation.

The Semi-Anechoic Chamber Test Site, Open Area Test Site (OATS) and Conducted Emissions Site have been fully described, submitted to, and accepted by the FCC, Industry Canada and the Japanese Voluntary Control Council for Interference by information technology equipment.

FCC Registration Number: 391271  
Industry Canada Lab Code: IC 4175A  
VCCI Member Number: 1831

- VCCI OATS Registration Number R-1526
- VCCI Conducted Emissions Site Registration Number: C-1608

## 2.3 Radiated Emissions Test Site Description

### 2.3.1 Semi-Anechoic Chamber Test Site

The Semi-Anechoic Chamber Test Site consists of a 20' x 30' x 18' shielded enclosure. The chamber is lined with Toyo Ferrite Grid Absorber, model number FFG-1000. The ferrite tile grid is 101 x 101 x 19mm thick and weighs approximately 550 grams. These tiles are mounted on steel panels and installed directly on the inner walls of the chamber.

The turntable is 150cm in diameter and is located 160cm from the back wall of the chamber. The chamber is grounded via 1 – 8' copper ground rod, installed at the center of the back wall, it is bound to the ground plane using 3/4" stainless steel braided cable.

The turntable is all steel, flush mounted table installed in an all steel frame. The table is remotely operated from inside the control room located 25' from the range. The turntable is electrically bonded to the surrounding ground plane via steel fingers installed on the edge of the turn table. The steel fingers make constant contact with the ground plane during operation.

Behind the turntable is a 3' x 6' x 4' deep shielded pit used for support equipment if necessary. The pit is equipped with 1 – 4" PVC chases from the turntable to the pit that allow for cabling to the EUT if necessary. The underside of the turntable can be accessed from the pit so cables can be supplied to the EUT from the pit.

A diagram of the Semi-Anechoic Chamber Test Site is shown in Figure 2.3-1 below:

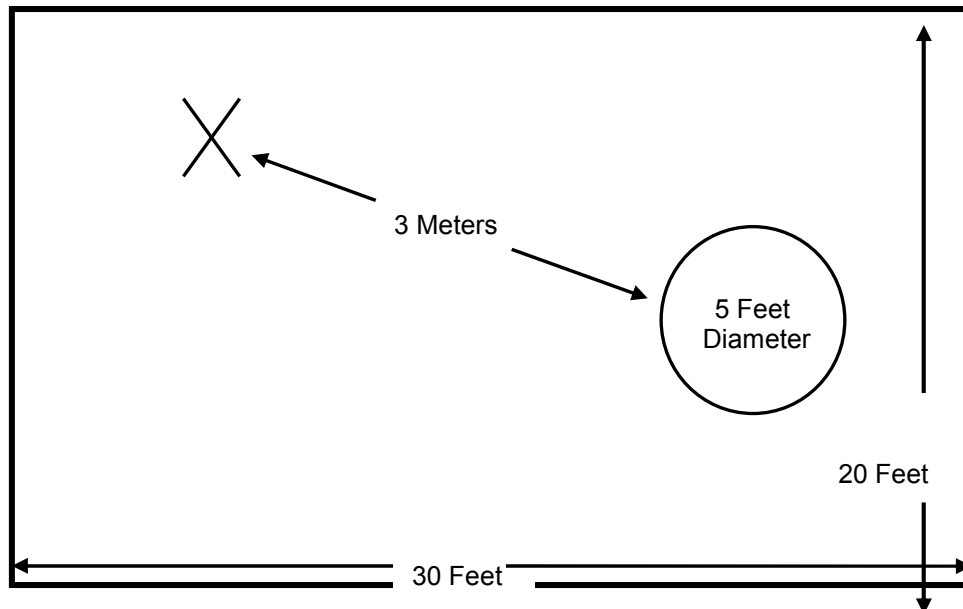

Figure 2.3-1: Semi-Anechoic Chamber Test Site

### 2.3.2 Open Area Tests Site (OATS)

The open area test site consists of a 40' x 66' concrete pad covered with a perforated electro-plated galvanized sheet metal. The perforations in the sheet metal are 1/8" holes that are staggered every 3/16". The individual sheets are placed to overlap each other by 1/4" and are riveted together to provide a continuous seam. Rivets are spaced every 3" in a 3 x 20 meter perimeter around the antenna mast and EUT area. Rivets in the remaining area are spaced as necessary to properly secure the ground plane and maintain the electrical continuity.

The entire ground plane extends 12' beyond the turntable edge and 16' beyond the antenna mast when set to a 10 meter measurement distance. The ground plane is grounded via 4 – 8' copper ground rods, each installed at a corner of the ground plane and bound to the ground plane using 3/4" stainless steel braided cable.

The turntable is an all aluminum 10' flush mounted table installed in an all aluminum frame. The table is remotely operated from inside the control room located 40' from the range. The turntable is electrically bonded to the surrounding ground plane via steel fingers installed on the edge of the turn table. The steel fingers make constant contact with the ground plane during operation.

Adjacent to the turntable is a 7' x 7' square and 4' deep concrete pit used for support equipment if necessary. The pit is equipped with 5 – 4" PVC chases from the pit to the control room that allow for cabling to the EUT if necessary. The underside of the turntable can be accessed from the pit so cables can be supplied to the EUT from the pit. The pit is covered with 2 sheets of 1/4" diamond style re-enforced steel sheets. The sheets are painted to match the perforated steel ground plane; however the underside edges have been masked off to maintain the electrical continuity of the ground plane. All reflecting objects are located outside of the ellipse defined in ANSI C63.4.

A diagram of the Open Area Test Site is shown in Figure 2.3-2 below:

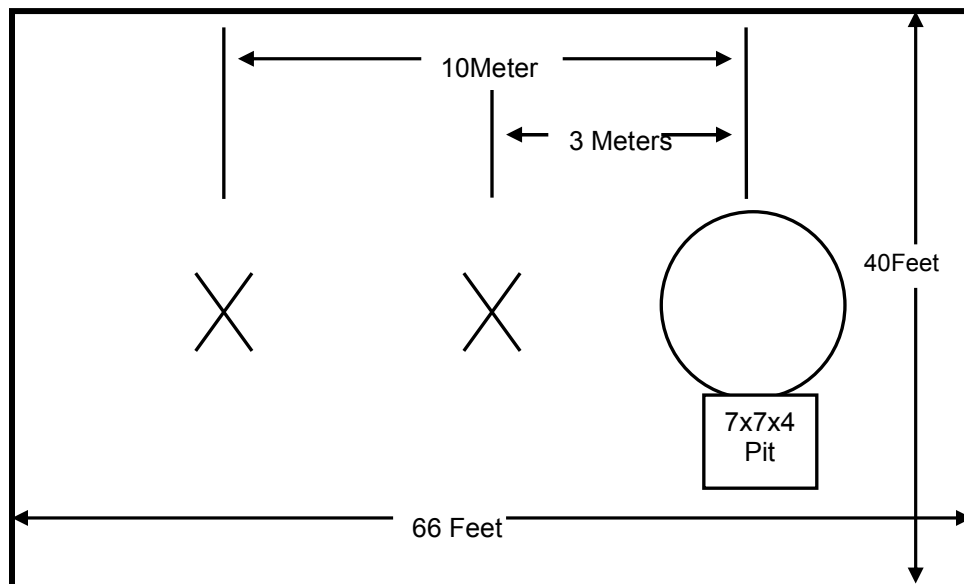

Figure 2.3-2: Open Area Test Site

## 2.4 Conducted Emissions Test Site Description

The AC mains conducted EMI site is located in the main EMC lab. It consists of an 8' x 8' solid aluminum horizontal ground reference plane (GRP) bonded every 3" to an 8' X 8' vertical ground plane.

The site is of sufficient size to test table top and floor standing equipment in accordance with section 6.1.4 of ANSI C63.4.

A diagram of the room is shown below in figure 2.4-1:

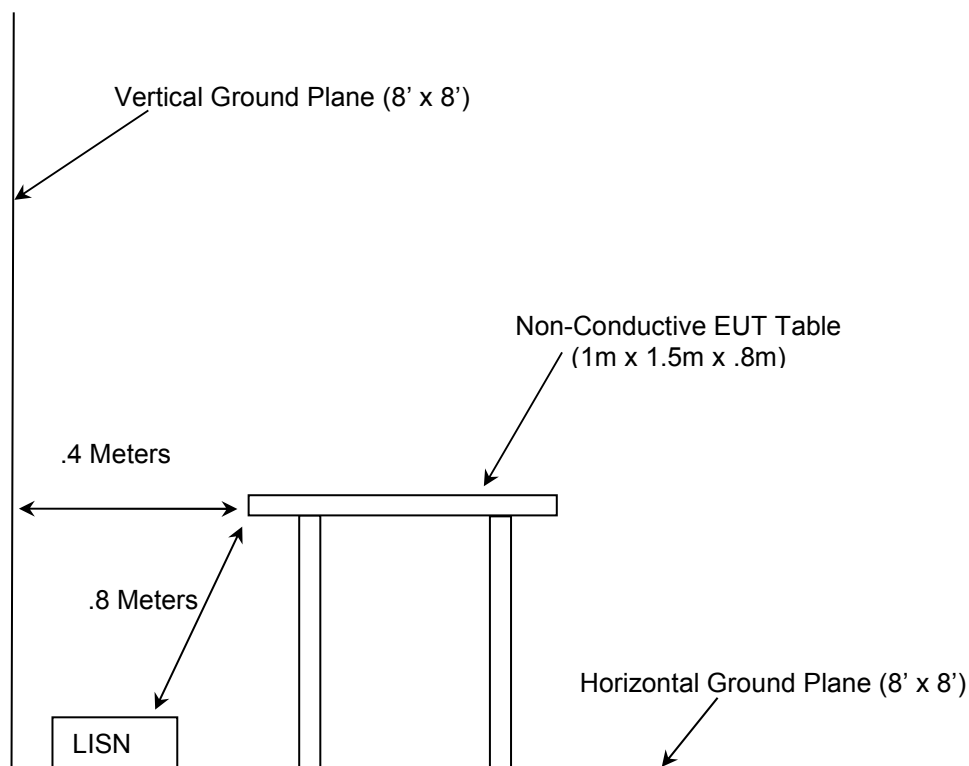

Figure 2.4-1: AC Mains Conducted EMI Site

## 3 APPLICABLE STANDARD REFERENCES

The following standards were used:

- ❖ ANSI C63.10-2013: American National Standard of Procedures for Compliance Testing of Unlicensed Wireless Devices
- ❖ US Code of Federal Regulations (CFR): Title 47, Part 2, Subpart J: Equipment Authorization Procedures, 2016
- ❖ US Code of Federal Regulations (CFR): Title 47, Part 15, Subpart C: Radio Frequency Devices, Intentional Radiators, 2016
- ❖ Industry Canada Radio Standards Specification: RSS-247 – Digital Transmission Systems (DTSS), Frequency Hopping Systems (FHSs) and License-Exempt Local Area Network (LE-LAN) Devices, Issue 1, May 2015
- ❖ Industry Canada Radio Standards Specification: RSS-GEN – General Requirements and Information for the Certification of Radiocommunication Equipment, Issue 4, Nov 2014.

#### 4 LIST OF TEST EQUIPMENT

The calibration interval of test equipment is annually or the manufacturer's recommendations. Where the calibration interval deviates from the annual cycle based on the instrument manufacturer's recommendations, it shall be stated below.

**Table 4-1: Test Equipment**

AssetID	Manufacturer	Model #	Equipment Type	Serial #	Last Calibration Date	Calibration Due Date
1	Rohde & Schwarz	ESMI - Display	Spectrum Analyzers	833771/007	7/14/2015	7/14/2016
2	Rohde & Schwarz	ESMI-Receiver	Spectrum Analyzers	839587/003	7/14/2015	7/14/2016
30	Spectrum Technologies	DRH-0118	Antennas	970102	4/30/2015	4/30/2017
40	EMCO	3104	Antennas	3211	2/10/2015	2/10/2017
73	Agilent	8447D	Amplifiers	2727A05624	7/15/2015	7/15/2016
167	ACS	Chamber EMI Cable Set	Cable Set	167	10/20/2015	10/20/2016
267	Agilent	N1911A	Meters	MY45100129	8/24/2015	8/24/2017
268	Agilent	N1921A	Sensors	MY45240184	8/13/2015	8/13/2017
292	Florida RF Cables	SMR-290AW- 480.0-SMR	Cables	None	3/3/2015	3/3/2016
324	ACS	Belden	Cables	8214	5/5/2015	5/5/2016
337	Microwave Circuits	H1G513G1	Filters	282706	5/20/2015	5/20/2016
338	Hewlett Packard	8449B	Amplifiers	3008A01111	8/21/2015	8/21/2017
340	Aeroflex/Weinschel	AS-20	Attenuators	7136	7/13/2015	7/13/2016
412	Electro Metrics	LPA-25	Antennas	1241	7/24/2014	7/24/2016
422	Florida RF	SMS-200AW-72.0- SMR	Cables	805	10/30/2015	10/30/2016
616	Florida RF Cables	SMRE-200W-12.0- SMRE	Cables	N/A	9/3/2015	9/3/2016
622	Rohde & Schwarz	FSV40	Analyzers	101338	7/15/2015	7/15/2016
3010	Rohde & Schwarz	ENV216	LISN	3010	7/10/2015	7/10/2016
RE112	Rohde & Schwarz	ESIB26	Receiver	836119/012	7/16/2015	7/16/2016



**5 SUPPORT EQUIPMENT**

**Table 5-1: Support Equipment**

Item	Equipment Type	Manufacturer	Model Number	Serial Number
1	Wall Wart Power Supply	V INFINITY	3A-161WU24	N/A

**6 EQUIPMENT UNDER TEST SETUP BLOCK DIAGRAM**

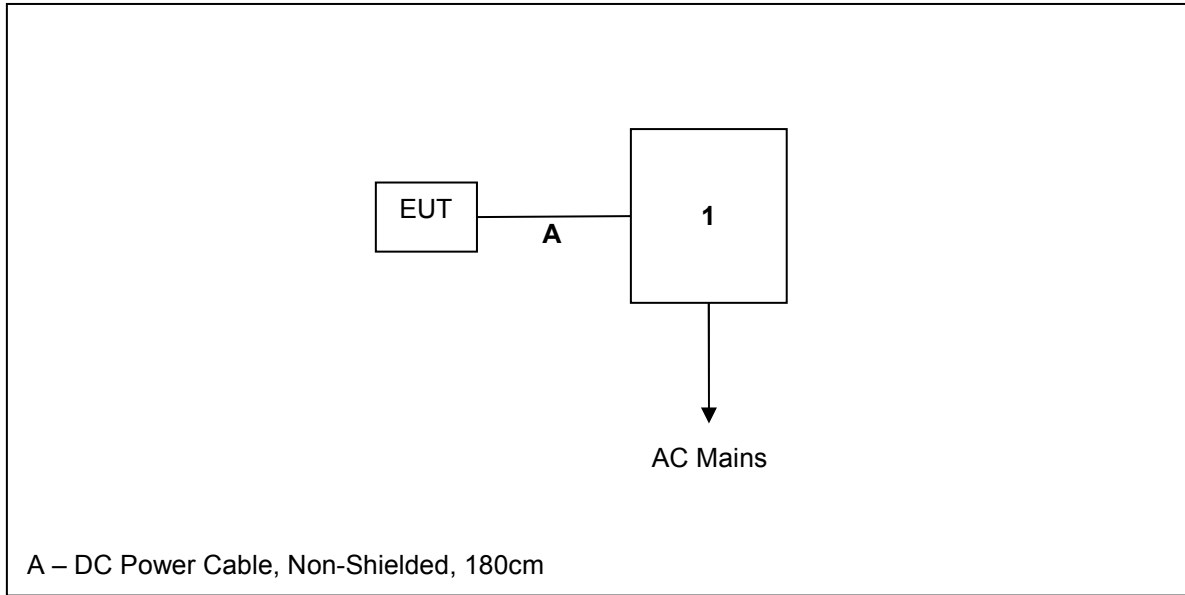

**Figure 6-1: Test Setup Block Diagram**

## 7 SUMMARY OF TESTS

Along with the tabular data shown below, plots were taken of all signals deemed important enough to document.

### 7.1 Antenna Requirement – FCC: Section 15.203

The EUT utilizes a ¼ Wave Embedded Slot Antenna with a gain of 1.5dBi therefore satisfying the requirements of Section 15.203.

### 7.2 Power Line Conducted Emissions – FCC 15.207, IC: RSS-Gen 8.8

#### 7.2.1 Measurement Procedure

ANSI C63.4 sections 6 and 7 were the guiding documents for this evaluation. Conducted emissions were performed from 150kHz to 30MHz with the spectrum analyzer's resolution bandwidth set to 9kHz and the video bandwidth set to 30kHz. The calculation for the conducted emissions is as follows:

**Corrected Reading = Analyzer Reading + LISN Loss + Cable Loss**

**Margin = Applicable Limit - Corrected Reading**

#### 7.2.2 Measurement Results

**Table 7.2.2-1: Conducted EMI Results – Line 1**

Frequency (MHz)	Corrected Reading		Limit (dBuV)	Margin (dB)	Line	Correction (dB)
	Quasi-Peak (dBuV)	Average (dBuV)				
0.359419	---	24.56	48.55	23.99	L1	9.7
0.359419	30.59	---	58.58	27.99	L1	9.7
2.428357	---	15.83	46.00	30.17	L1	9.7
2.428357	22.13	---	56.00	33.87	L1	9.7
2.528557	---	18.42	46.00	27.58	L1	9.7
2.528557	24.14	---	56.00	31.86	L1	9.7
27.954747	---	17.89	50.00	32.11	L1	10.2
27.954747	25.59	---	60.00	34.41	L1	10.2
28.119539	---	17.81	50.00	32.19	L1	10.2
28.119539	25.66	---	60.00	34.34	L1	10.2
29.245591	---	16.93	50.00	33.07	L1	10.2
29.245591	24.86	---	60.00	35.14	L1	10.2

Table 7.2.2-2: Conducted EMI Results – Line 2

Frequency (MHz)	Corrected Reading		Limit (dBuV)	Margin (dB)	Line	Correction (dB)
	Quasi-Peak (dBuV)	Average (dBuV)				
0.229058	---	10.58	52.26	41.68	N	9.6
0.229058	18.78	---	62.30	43.52	N	9.6
2.612926	---	14.31	46.00	31.69	N	9.7
2.612926	20.90	---	56.00	35.10	N	9.7
2.631363	---	17.26	46.00	28.74	N	9.7
2.631363	23.36	---	56.00	32.64	N	9.7
2.730762	---	18.21	46.00	27.79	N	9.7
2.730762	24.11	---	56.00	31.89	N	9.7
28.035448	---	19.25	50.00	30.75	N	10.4
28.035448	26.43	---	60.00	33.57	N	10.4
28.499900	---	19.05	50.00	30.95	N	10.3
28.499900	26.26	---	60.00	33.74	N	10.3

**7.3 Peak Output Power - FCC 15.247(b)(2) IC: RSS-247 5.4(1)****7.3.1 Measurement Procedure (Conducted Method)**

The RF output port of the EUT was directly connected to the input of a power meter. The device employs at least 50 channels therefore the power is limited to 1 Watt.

**7.3.2 Measurement Results****Table 7.3.2-1: RF Output Power**

<b>Frequency [MHz]</b>	<b>Level [dBm]</b>
909.6	21.42
916.2	20.92
921.8	21.33

## 7.4 Channel Usage Requirements

### 7.4.1 Carrier Frequency Separation – FCC 15.247(a)(1) IC: RSS-247 5.1(2)

#### 7.4.1.1 Measurement Procedure

The RF output port of the EUT was directly connected to the input of the spectrum analyzer with suitable attenuation. The span of the spectrum analyzer was set wide enough to capture two adjacent peaks and the RBW started at approximately 30% of the channel spacing and adjusted as necessary to best identify the center of each individual channel. The VBW was set to  $\geq$  RBW.

#### 7.4.1.2 Measurement Results

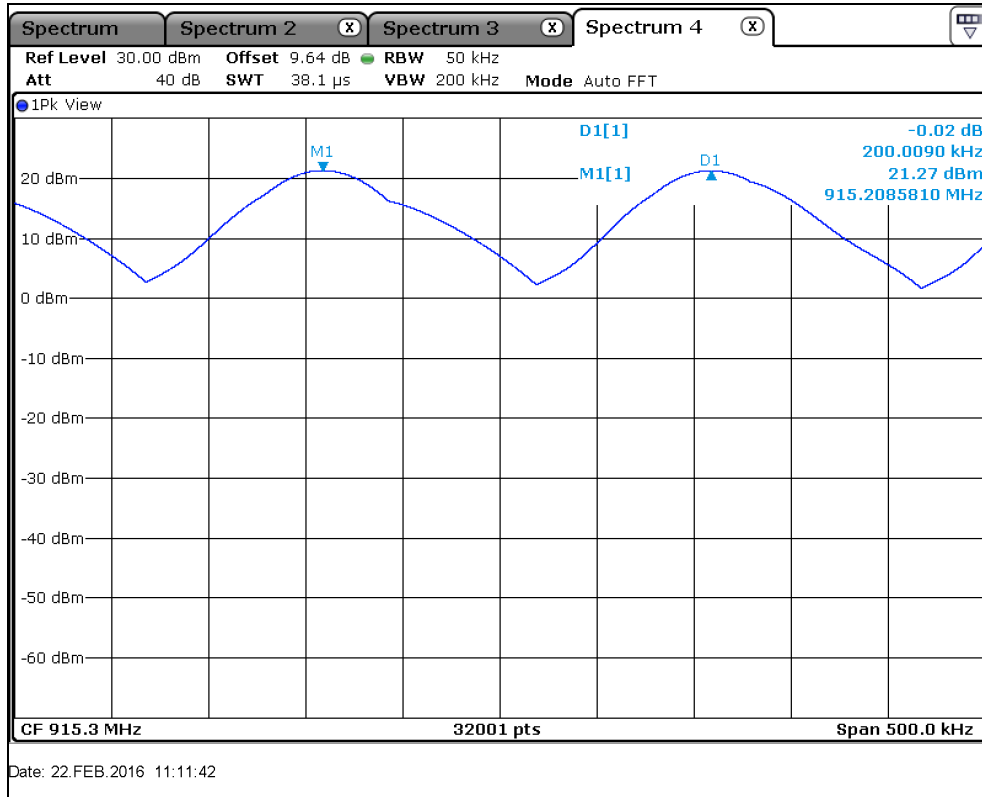

Figure 7.4.1.2-1: Channel Separation

7.4.2 Number of Hopping Channels – FCC 15.247(a)(1)(i) IC: RSS-247 5.1(3)

7.4.2.1 Measurement Procedure

The RF output port of the EUT was directly connected to the input of the spectrum analyzer with suitable attenuation. The span of the spectrum analyzer was set wide enough to capture the frequency band of operation. The RBW was set to less than 30% of the channel spacing or the 20dB bandwidth, whichever is smaller. The VBW was set to  $\geq$  RBW.

7.4.2.2 Measurement Results

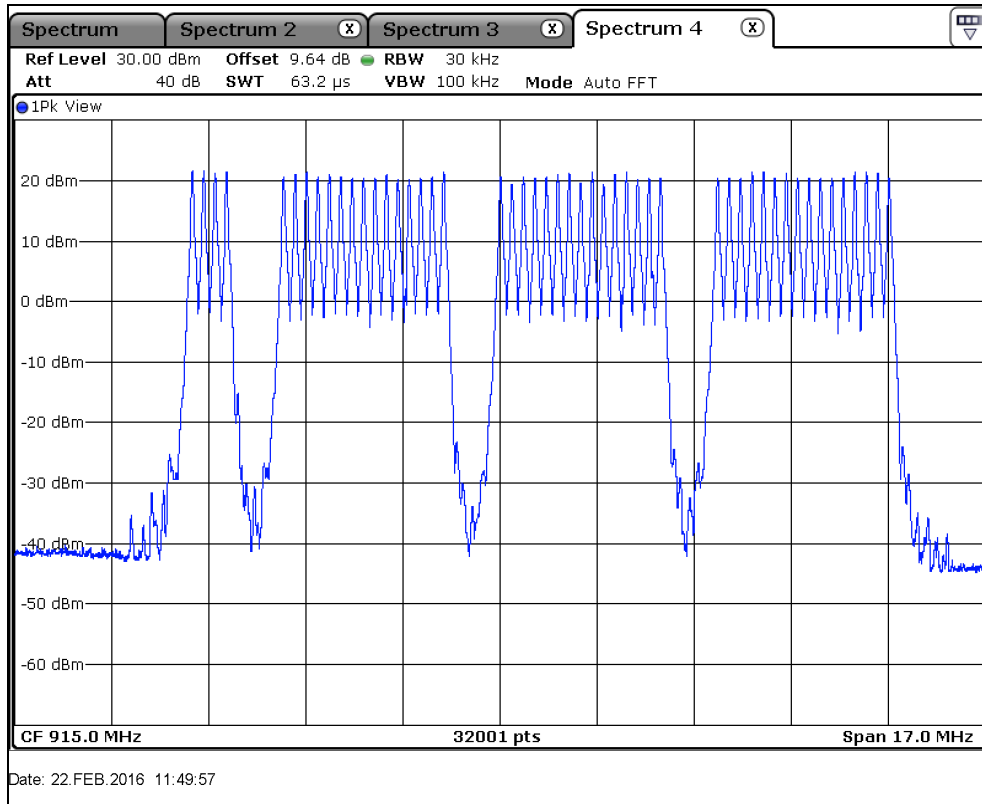

Figure 7.4.2.2-1: Hopping Channels

### 7.4.3 Channel Dwell Time – FCC 15.247(a)(1)(i) IC: RSS-247 5.1(3)

#### 7.4.3.1 Measurement Procedure

The EUT test mode does not generate a worst case channel dwell time therefore a detailed engineering analysis is provided in the theory of operation.

As described in the theory of operation, the maximum channel transmitter dwell time is 45ms per channel hop with the minimum period of 30seconds between hops on the same channel. Therefore the maximum time of occupancy on any one channel within a 20s period is <400ms for all modes of operation.

7.4.4 20dB / 99% Bandwidth - FCC 15.247(a)(1)(i) IC: RSS-247 5.1(3)

7.4.4.1 Measurement Procedure

The RF output port of the EUT was directly connected to the input of the spectrum analyzer with suitable attenuation. The span of the spectrum analyzer display was set between two times and five times the occupied bandwidth (OBW) of the emission. The RBW of the spectrum analyzer was set to approximately 1 % to 5 % of the OBW. The trace was set to max hold with a peak detector active. The Delta and ndB down functions of the analyzer were utilized to determine the 20 dB bandwidth of the emission.

The occupied bandwidth measurement function of the spectrum analyzer was used to measure the 99% bandwidth. The span of the analyzer was set to capture all products of the modulation process, including the emission sidebands. The resolution bandwidth was set to 1% to 5% of the occupied bandwidth. The video bandwidth was set to 3 times the resolution bandwidth. A peak detector was used.

7.4.4.2 Measurement Results

Table 7.4.4.2-1: 20dB / 99% Bandwidth

Frequency [MHz]	20dB Bandwidth [kHz]	99% Bandwidth [kHz]
909.6	101.8	137.0
916.2	119.1	150.4
921.8	149.0	162.5

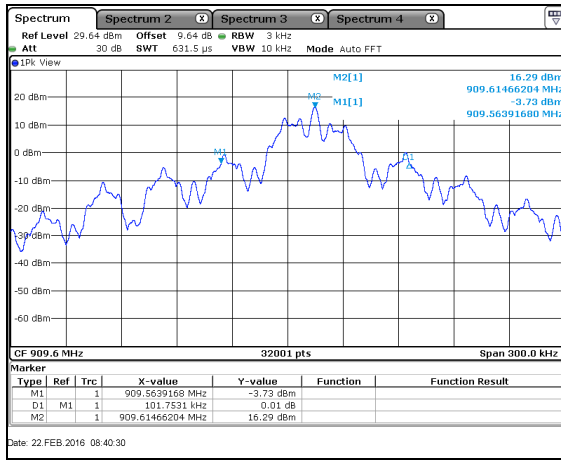

Figure 7.4.4.2-1: 20dB BW Low Channel

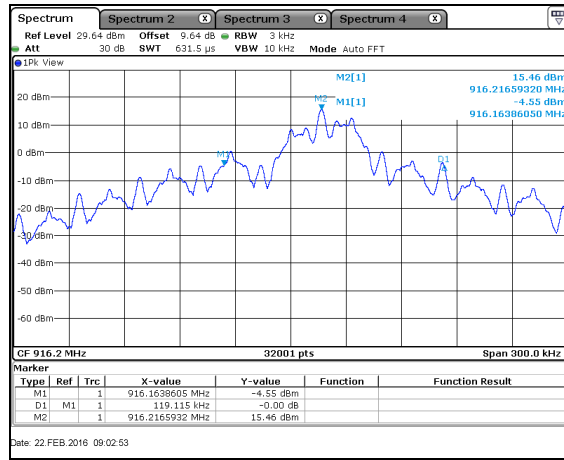

Figure 7.4.4.2-2: 20dB BW Low Channel



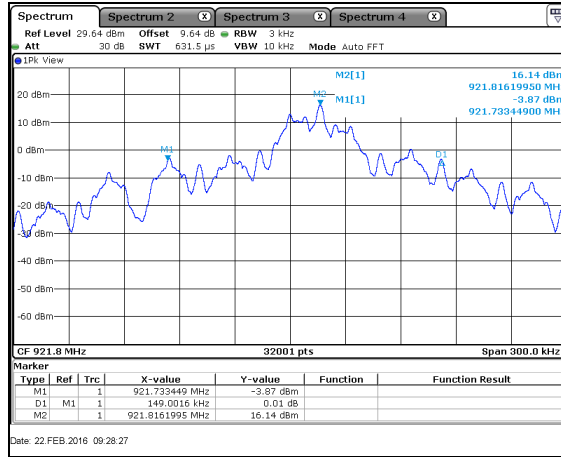

Figure 7.4.4.2-3: 20dB BW Low Channel

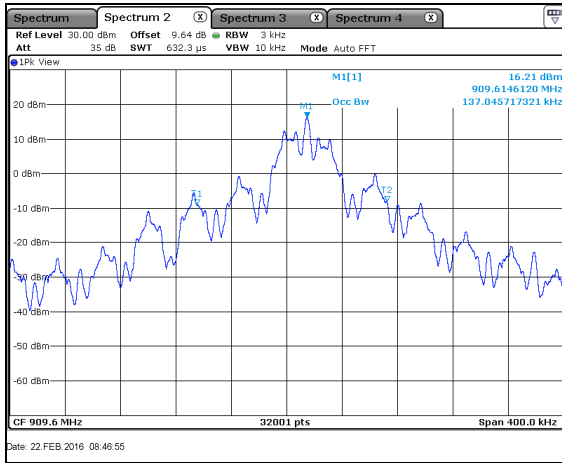

Figure 7.4.4.2-4: 99% BW Low Channel

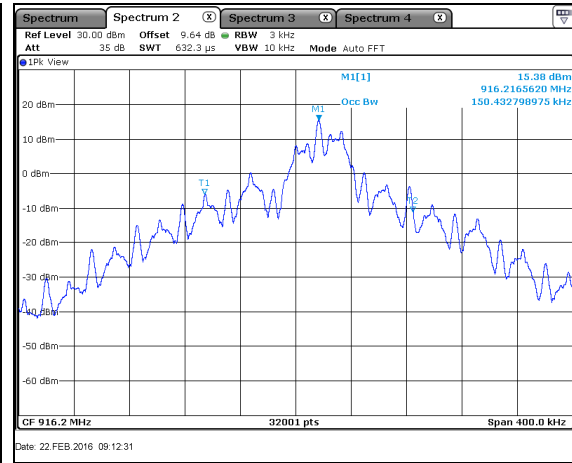

Figure 7.4.4.2-5: 99% BW Low Channel

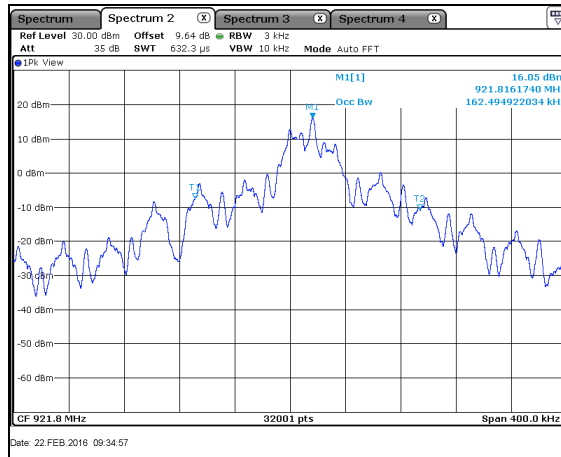

Figure 7.4.4.2-6: 99% BW Low Channel

## 7.5 Band-Edge Compliance and Spurious Emissions

### 7.5.1 Band-Edge Compliance of RF Conducted Emissions - FCC 15.247(d); IC RSS-247 5.5

#### 7.5.1.1 Measurement Procedure

The RF output port of the EUT was directly connected to the input of the spectrum analyzer with suitable attenuation. The EUT was investigated at the lowest and highest channel available to determine band-edge compliance. For each measurement the spectrum analyzer's RBW was set to 100kHz and the VBW was set to 300kHz.

#### 7.5.1.2 Measurement Results

##### NON-HOPPING MODE:

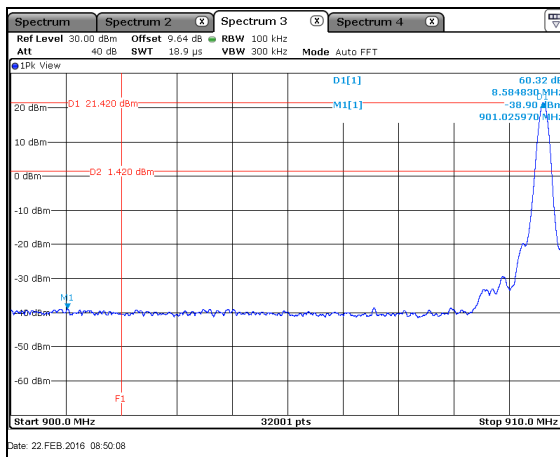

Figure 7.5.1.2-1: Lower Band-edge

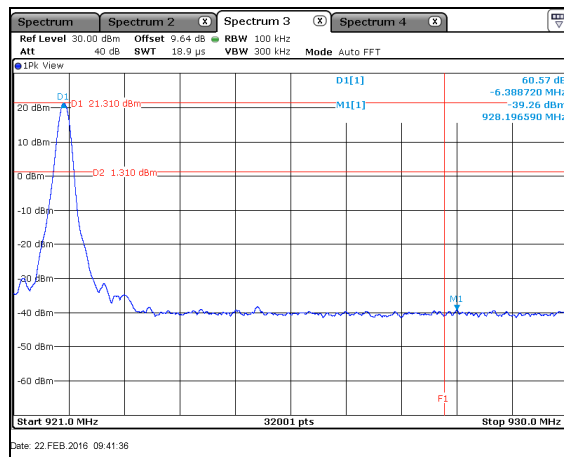

Figure 7.5.1.2-2: Upper Band-edge

##### HOPPING MODE:

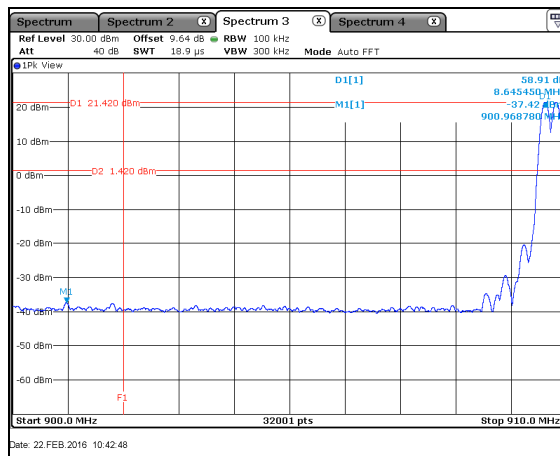

Figure 7.5.1.2-3: Lower Band-edge

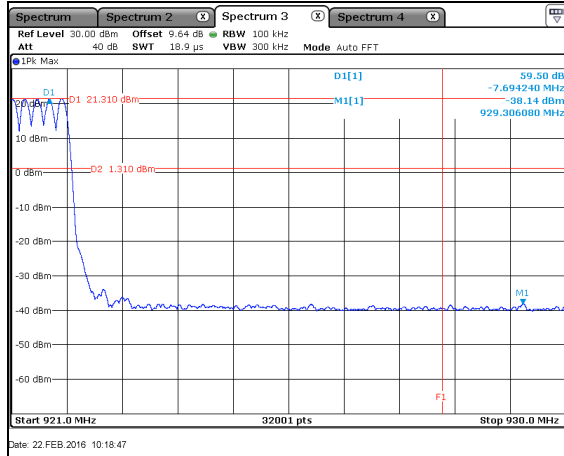

Figure 7.5.1.2-4: Upper Band-edge

7.5.2 RF Conducted Spurious Emissions - FCC 15.247(d); IC RSS-247 5.5

7.5.2.1 Measurement Procedure

The RF output port of the EUT was directly connected to the input of the spectrum analyzer. The EUT was investigated for conducted spurious emissions from 30MHz to 10GHz, 10 times the highest fundamental frequency. Measurements were made at the low, center and high channels of the EUT. For each measurement, the spectrum analyzer's RBW was set to 100kHz. A peak detector function was used with the trace set to max hold.

7.5.2.2 Measurement Results

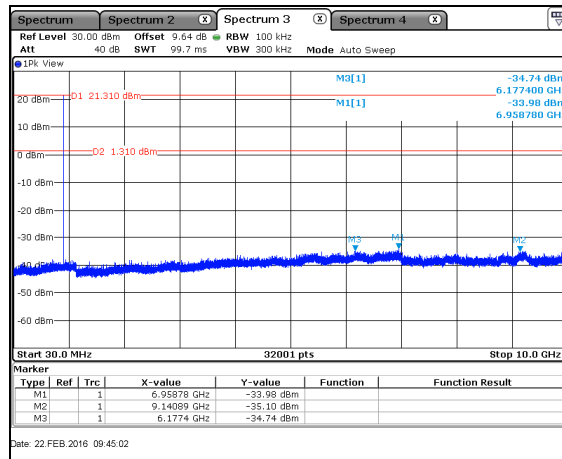
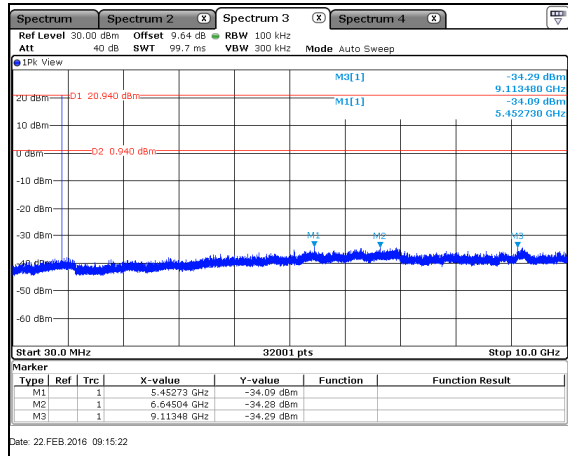
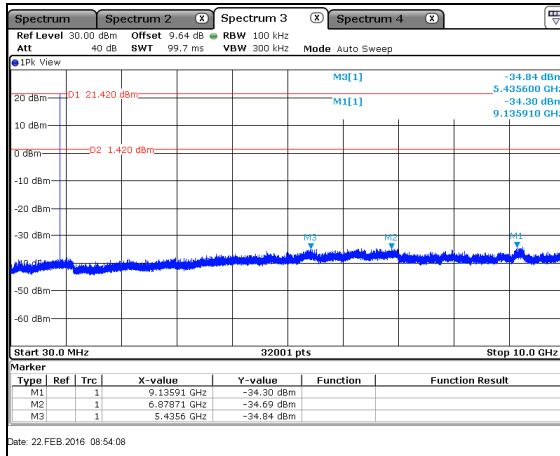

**7.5.3 Radiated Spurious Emissions - FCC 15.205, 15.209; RSS-Gen 8.9/8.10**

**7.5.3.1 Measurement Procedure**

Radiated emissions tests were made over the frequency range of 30MHz to 10GHz, 10 times the highest fundamental frequency.

The EUT was rotated through 360° and the receive antenna height was varied from 1m to 4m so that the maximum radiated emissions level would be detected. For frequencies below 1000MHz, quasi-peak measurements were made using a resolution bandwidth RBW of 120 kHz and a video bandwidth VBW of 300 kHz. For frequencies above 1000MHz, peak and average measurements were made with RBW and VBW of 1 MHz and 3MHz respectively.

Each emission found to be in a restricted band was compared to the applicable radiated emission limits.

**7.5.3.2 Duty Cycle Correction**

For average radiated measurements, using a 45% duty cycle, the measured level was reduced by a factor 6.94dB. The duty cycle correction factor is determined using the formula:  $20\log(45/100) = -6.94\text{dB}$ . A detailed analysis of the duty cycle timing is provided in the Theory of Operation accompanying the application for certification.

**7.5.3.3 Measurement Results**

**Table 7.5.3.3-1: Radiated Spurious Emissions Tabulated Data**

Frequency (MHz)	Level (dBuV)		Antenna Polarity (H/V)	Correction Factors (dB)	Corrected Level (dBuV/m)		Limit (dBuV/m)		Margin (dB)	
	pk	Qpk/Avg			pk	Qpk/Avg	pk	Qpk/Avg	pk	Qpk/Avg
<b>Low Channel</b>										
2728.8	46.71	46.71	H	-3.60	43.11	36.17	74.0	54.0	30.9	17.8
2728.8	46.45	46.45	V	-3.60	42.85	35.91	74.0	54.0	31.2	18.1
5457.6	48.41	48.41	H	3.82	52.23	45.29	74.0	54.0	21.8	8.7
5457.6	47.91	47.91	V	3.82	51.73	44.79	74.0	54.0	22.3	9.2
<b>Middle Channel</b>										
2748.6	44.20	44.20	H	-3.55	40.65	33.71	74.0	54.0	33.4	20.3
2748.6	44.25	44.25	V	-3.55	40.70	33.76	74.0	54.0	33.3	20.2
<b>High Channel</b>										
2765.4	45.12	45.12	H	-3.51	41.61	34.67	74.0	54.0	32.4	19.3
2765.4	44.81	44.81	V	-3.51	41.30	34.36	74.0	54.0	32.7	19.6

**7.5.3.4 Sample Calculation:**

$$R_c = R_u + CF_T$$

Where:

$CF_T$  = Total Correction Factor (AF+CA+AG)-DC (Average Measurements Only)

$R_u$  = Uncorrected Reading

$R_c$  = Corrected Level

AF = Antenna Factor

CA = Cable Attenuation

AG = Amplifier Gain

DC = Duty Cycle Correction Factor

**Example Calculation: Peak**

Corrected Level:  $46.71 - 3.60 = 43.11\text{dBuV/m}$

Margin:  $74\text{dBuV/m} - 43.11\text{dBuV/m} = 30.9\text{dB}$

**Example Calculation: Average**

Corrected Level:  $46.71 - 3.60 - 6.94 = 36.17\text{dBuV}$

Margin:  $54\text{dBuV} - 36.17\text{dBuV} = 17.8\text{dB}$

## **8 CONCLUSION**

In the opinion of ACS, Inc. the C1A3B, manufactured by Itron Electricity Metering, Inc. meets the requirements of FCC Part 15 subpart C and Industry Canada's Radio Standards Specification RSS-247.

**END REPORT**