

EMC Test Report

*Application for Grant of Equipment Authorization
Class II Permissive Change/Reassessment*

*Industry Canada RSS-Gen Issue 3 / RSS 210 Issue 8
FCC Part 15, Subpart E*

Model: XI-N450

IC CERTIFICATION #: 5428A-XIN450
FCC ID: SK6XI-N450

APPLICANT: Xirrus, Inc.
2101 Corporate Center Dr.
Newbury Park, CA 91320

TEST SITE(S): Elliott Laboratories
41039 Boyce Road.
Fremont, CA. 94538-2435

IC SITE REGISTRATION #: 2845B-4, 2845B-7

REPORT DATE: January 10, 2012

FINAL TEST DATES: October 20, 21, 23 and 28, 2011

TOTAL NUMBER OF PAGES: 42

PROGRAM MGR /
TECHNICAL REVIEWER:

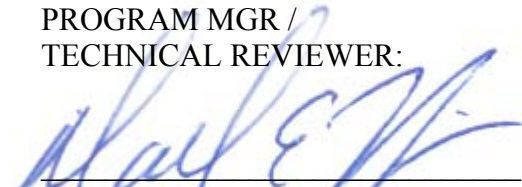

Mark E Hill
Staff Engineer

QUALITY ASSURANCE DELEGATE /
FINAL REPORT PREPARER:

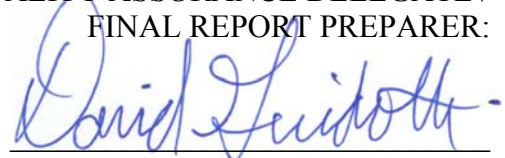

David Guidotti
Senior Technical Writer



Testing Cert #2016.01

Elliott Laboratories is accredited by the A2LA, certificate number 2016.01, to perform the test(s) listed in this report, except where noted otherwise. This report and the information contained herein represent the results of testing test articles identified and selected by the client performed to specifications and/or procedures selected by the client. National Technical Systems (NTS) makes no representations, expressed or implied, that such testing is adequate (or inadequate) to demonstrate efficiency, performance, reliability, or any other characteristic of the articles being tested, or similar products. This report should not be relied upon as an endorsement or certification by NTS of the equipment tested, nor does it represent any statement whatsoever as to its merchantability or fitness of the test article, or similar products, for a particular purpose. This report shall not be reproduced except in full

REVISION HISTORY

Rev#	Date	Comments	Modified By
-	1-10-2012	First release	

TABLE OF CONTENTS

REVISION HISTORY	2
TABLE OF CONTENTS	3
SCOPE.....	4
OBJECTIVE	4
STATEMENT OF COMPLIANCE.....	5
DEVIATIONS FROM THE STANDARDS.....	5
TEST RESULTS SUMMARY	6
UNII / LELAN DEVICES	6
GENERAL REQUIREMENTS APPLICABLE TO ALL BANDS.....	8
MEASUREMENT UNCERTAINTIES.....	9
EQUIPMENT UNDER TEST (EUT) DETAILS.....	10
GENERAL.....	10
ANTENNA SYSTEM	10
ENCLOSURE.....	10
MODIFICATIONS.....	10
SUPPORT EQUIPMENT	11
EUT INTERFACE PORTS	11
EUT OPERATION	11
TEST SITE.....	13
GENERAL INFORMATION.....	13
CONDUCTED EMISSIONS CONSIDERATIONS	13
RADIATED EMISSIONS CONSIDERATIONS	13
MEASUREMENT INSTRUMENTATION	14
RECEIVER SYSTEM	14
INSTRUMENT CONTROL COMPUTER	14
LINE IMPEDANCE STABILIZATION NETWORK (LISN).....	14
FILTERS/ATTENUATORS	15
ANTENNAS.....	15
ANTENNA MAST AND EQUIPMENT TURNTABLE	15
INSTRUMENT CALIBRATION.....	15
TEST PROCEDURES	16
EUT AND CABLE PLACEMENT	16
CONDUCTED EMISSIONS.....	16
RADIATED EMISSIONS.....	16
RADIATED EMISSIONS.....	17
CONDUCTED EMISSIONS FROM ANTENNA PORT	19
BANDWIDTH MEASUREMENTS	19
SPECIFICATION LIMITS AND SAMPLE CALCULATIONS	20
CONDUCTED EMISSIONS SPECIFICATION LIMITS: FCC 15.207; FCC 15.107(A), RSS GEN	20
GENERAL TRANSMITTER RADIATED EMISSIONS SPECIFICATION LIMITS	21
RECEIVER RADIATED SPURIOUS EMISSIONS SPECIFICATION LIMITS	21
FCC 15.407 (A) OUTPUT POWER LIMITS	21
OUTPUT POWER LIMITS –LELAN DEVICES.....	22
SPURIOUS EMISSIONS LIMITS –UNII AND LELAN DEVICES	22
SAMPLE CALCULATIONS - CONDUCTED EMISSIONS	23
SAMPLE CALCULATIONS - RADIATED EMISSIONS.....	23
SAMPLE CALCULATIONS - FIELD STRENGTH TO EIRP CONVERSION.....	24
APPENDIX A TEST EQUIPMENT CALIBRATION DATA	25
APPENDIX B TEST DATA	26
END OF REPORT	42

SCOPE

An electromagnetic emissions test has been performed on the Xirrus, Inc. model XI-N450, pursuant to the following rules:

Industry Canada RSS-Gen Issue 3
RSS 210 Issue 8 "Low-power Licence-exempt Radiocommunication Devices (All Frequency Bands): Category I Equipment"
FCC Part 15, Subpart E requirements for UNII Devices (using FCC DA 02-2138, August 30, 2002)

Conducted and radiated emissions data has been collected, reduced, and analyzed within this report in accordance with measurement guidelines set forth in the following reference standards and as outlined in Elliott Laboratories test procedures:

ANSI C63.4:2003
FCC UNII test procedure 2002-08 DA-02-2138, August 2002

The intentional radiator above has been tested in a simulated typical installation to demonstrate compliance with the relevant Industry Canada performance and procedural standards.

Final system data was gathered in a mode that tended to maximize emissions by varying orientation of EUT, orientation of power and I/O cabling, antenna search height, and antenna polarization.

Every practical effort was made to perform an impartial test using appropriate test equipment of known calibration. All pertinent factors have been applied to reach the determination of compliance.

OBJECTIVE

The primary objective of the manufacturer is compliance with the regulations outlined in the previous section.

Prior to marketing in the USA, all unlicensed transmitters and transceivers require certification. Receive-only devices operating between 30 MHz and 960 MHz are subject to either certification or a manufacturer's declaration of conformity, with all other receive-only devices exempt from the technical requirements.

Prior to marketing in Canada, Class I transmitters, receivers and transceivers require certification. Class II devices are required to meet the appropriate technical requirements but are exempt from certification requirements.

Certification is a procedure where the manufacturer submits test data and technical information to a certification body and receives a certificate or grant of equipment authorization upon successful completion of the certification body's review of the submitted documents. Once the equipment authorization has been obtained, the label indicating compliance must be attached to all identical units, which are subsequently manufactured.

Maintenance of compliance is the responsibility of the manufacturer. Any modification of the product which may result in increased emissions should be checked to ensure compliance has been maintained (i.e., printed circuit board layout changes, different line filter, different power supply, harnessing or I/O cable changes, etc.).

STATEMENT OF COMPLIANCE

The tested sample of Xirrus, Inc. model XI-N450 complied with the requirements of the following regulations:

SS 210 Issue 8 “Low-power Licence-exempt Radiocommunication Devices (All Frequency Bands): Category I Equipment”
FCC Part 15, Subpart E requirements for UNII Devices

Maintenance of compliance is the responsibility of the manufacturer. Any modifications to the product should be assessed to determine their potential impact on the compliance status of the device with respect to the standards detailed in this test report.

The test results recorded herein are based on a single type test of Xirrus, Inc. model XI-N450 and therefore apply only to the tested sample. The sample was selected and prepared by Steve Smith of Xirrus, Inc..

DEVIATIONS FROM THE STANDARDS

No deviations were made from the published requirements listed in the scope of this report.

TEST RESULTS SUMMARY**UNII / LELAN DEVICES****Operation in the 5.15 – 5.25 GHz Band**

FCC Rule Part	RSS Rule Part	Description	Measured Value / Comments	Limit / Requirement	Result
15.407(e)		Indoor operation only	Refer to user's manual	N/A	Complies
15.407(a)(2)		26dB Bandwidth	Testing not performed, no changes from the original filing. Output power of test sample confirmed to be with 0.5dB of the original filing.		
15.407(a)(1)	A9.2(1)	Output Power			
15.407(a)(1)	-	Power Spectral Density			
-	A9.5(2)				

Operation in the 5.25 – 5.35 GHz Band

FCC Rule Part	RSS Rule Part	Description	Measured Value / Comments	Limit / Requirement	Result (margin)
15.407(a)(2)		26dB Bandwidth	Testing not performed, no changes from the original filing. Output power of test sample confirmed to be with 0.5dB of the original filing.		
15.407(a)(2)	A9.2(2)	Output Power			
15.407(a)(2)	-	Power Spectral Density			
-	A9.2(2) / A9.5(2)	Power Spectral Density			

Operation in the 5.47 – 5.725 GHz Band

FCC Rule Part	RSS Rule Part	Description	Measured Value / Comments	Limit / Requirement	Result (margin)
15.407(a)(2)		26dB Bandwidth	Testing not performed, no changes from the original filing. Output power of test sample confirmed to be with 0.5dB of the original filing.		
15.407(a)(2)	A9.2(2)	Output Power			
15.407(a)(2)		Power Spectral Density			
	A9.2(2) / A9.5(2)	Power Spectral Density			
KDB 443999	A9	Non-operation in 5600 – 5650 MHz sub band	Device cannot operate in the 5600 – 5650 MHz band –refer to Operational Description		Complies

Requirements for all U-NII/LELAN bands

FCC Rule Part	RSS Rule Part	Description	Measured Value / Comments	Limit / Requirement	Result
15.407	A9.5a	Modulation	Unchanged from original filing.		
15.407(b)(5) / 15.209	A9.3	Spurious Emissions below 1GHz	No emissions detected	Refer to page 22	Complies
15.407(b)(5) / 15.209	A9.3	Spurious Emissions above 1GHz	53.7dB μ V/m @ 5460.0MHz (-0.3dB)		Complies
15.407(a)(6)	-	Peak Excursion Ratio	Testing not performed.	Power is equal to original filing.	
	A9.5 (3)	Channel Selection	Spurious emissions tested at outermost channels in each band	Device was tested on the top, bottom and center channels in each band	N/A
15			Measurements on three channels in each band		Complies
15.407 (c)	A9.5(4)	Operation in the absence of information to transmit	Unchanged from original filing.		
15.407 (g)	A9.5 (5)	Frequency Stability	Unchanged from original filing.		
15.407 (h1)	A9.4	Transmit Power Control	Unchanged from original filing.		
15.407 (h2)	A9.4	Dynamic frequency Selection (device with radar detection)	Refer to separate test report, reference R85404	Threshold -62dBm (-64dBm if eirp > 200mW) Channel Availability Check > 60s Channel closing transmission time < 260ms Channel move time < 10s Non occupancy period > 30minutes	Complies
	A9.9g	User Manual information	Unchanged from original filing.		

GENERAL REQUIREMENTS APPLICABLE TO ALL BANDS

FCC Rule Part	RSS Rule part	Description	Measured Value / Comments	Limit / Requirement	Result (margin)
15.203	-	RF Connector	Unchanged from original filing.		
15.207	RSS GEN Table 2	AC Conducted Emissions	50.6dB μ V @ 0.212MHz (-12.5dB)	Refer to page 20	Complies
15.109	RSS GEN 7.2.3 Table 1	Receiver spurious emissions	53.2dB μ V/m @ 3800.0MHz (-0.8dB)	Refer to page 21	Complies
15.247 (b) (5) 15.407 (f)	RSS 102	RF Exposure Requirements	Unchanged from original filing.		
-	RSP 100 RSS GEN 7.1.5	User Manual	Unchanged from original filing.		
-	RSP 100 RSS GEN 7.1.5	User Manual	Unchanged from original filing.		
-	RSP 100 RSS GEN 4.4.1	99% Bandwidth	Unchanged from original filing.		

MEASUREMENT UNCERTAINTIES

ISO/IEC 17025 requires that an estimate of the measurement uncertainties associated with the emissions test results be included in the report. The measurement uncertainties given below are based on a 95% confidence level and were calculated in accordance with UKAS document LAB 34.

Measurement Type	Measurement Unit	Frequency Range	Expanded Uncertainty
RF power, conducted (power meter)	dBm	25 to 7000 MHz	± 0.52 dB
RF power, conducted (Spectrum analyzer)	dBm	25 to 7000 MHz	± 0.7 dB
Conducted emission of transmitter	dBm	25 to 26500 MHz	± 0.7 dB
Conducted emission of receiver	dBm	25 to 26500 MHz	± 0.7 dB
Radiated emission (substitution method)	dBm	25 to 26500 MHz	± 2.5 dB
Radiated emission (field strength)	dB μ V/m	25 to 1000 MHz	± 3.6 dB
		1000 to 40000 MHz	± 6.0 dB
Conducted Emissions (AC Power)	dB μ V	0.15 to 30 MHz	± 2.4 dB

EQUIPMENT UNDER TEST (EUT) DETAILS**GENERAL**

The Xirrus, Inc. model XI-N450 is an 802.11abgn 3x3 module intended to be installed in Xirrus Wireless Access Points. The module supports 802.11bgn 3x3 in the 2400-2483.5MHz, 5725-5850MHz, 5150-5250MHz, 5250-5350MHz and 5470-5725MHz bands. It additionally supports 802.11a SISO mode in the 5150-5250MHz, 5250-5350MHz and 5470-5725MHz bands at a higher per chain power. SISO modes in the other bands operate at the same output power per chain as the equivalent MIMO mode. It can operate in both 20- and 40-MHz channels in 802.11n mode.

The samples were received on October 17, 2011 and tested on October 20, 21, 23 and 28, 2011. For testing purposes 8 samples of the XI-N300 2x2 module, and 8 samples of a 3x3 version of the module (model number XI-N450) were installed into a Xirrus XR6000 host system capable of containing a maximum of 16 modules.

Normally, the XR6000 would be ceiling mounted during operation. The host system was tested as table-top equipment. The host system is powered via Power-Over-Ethernet (PoE). Compliance of the modules with the AC conducted emissions limits was evaluated by measuring the emissions at the AC input to a typical PoE injector used to power the host system.

The EUT consisted of the following component(s):

Company	Model	Description	Serial Number	FCC ID
Xirrus Inc.	XI-N450	802.11abgn 3x3 module	11000000239	SK6XI-N450

ANTENNA SYSTEM

The antenna system is integrated into the module with two antennas per module (one for each transmit-receive chain). The nominal antenna gains are 1dBi in the 2.4GHz band and 4dBi in the 5GHz bands.

ENCLOSURE

The EUT has no enclosure. It is designed to be installed within the enclosure of a host computer.

MODIFICATIONS

No modifications were made to the EUT during the time the product was at Elliott.

SUPPORT EQUIPMENT

The following equipment was used as support equipment for testing:

Company	Model	Description	Serial Number	FCC ID
Xirrus	XR6000	Access Point	-	-

The following equipment was used as remote support equipment for emissions testing:

Company	Model	Description	Serial Number	FCC ID
HP	Compaq 6910P	PC Laptop	n/a	DoC
Xirrus	XP2-MSI-95M	Dual Port POE Injector	P12400043B1	N/A

EUT INTERFACE PORTS

The I/O cabling configuration during emissions testing was as follows:

Port		Description	Cable(s)	
From	To		Shielded/Unshielded	Length(m)
POE1, POE2	Remote POE Injector	CAT5 (x2)	Unshielded	10
Gig3, Gig4	Not Connected	-	-	-
Console	Not Connected	-	-	-
Laptop Ethernet	PoE Injector	Cat 5	Unshielded	1

EUT OPERATION

The modules were installed into a host system for spurious emissions tests.

To evaluate the radiated spurious emissions related to the transmitter the module was evaluated in all operating modes (802.11b, 802.11g, 802.11a, 802.11n in both 20- and 40-MHz channels) using ART software utility to place the module(s) under test in continuous transmit modes. Both transmit chains were active for the DTS tests, NII tests were repeated in 802.11a mode with a single chain active.

For measurements at the restricted band edges one module was operating on the channel closest to the band edge. The worse case operating mode from the original filing was tested for each band. For other spurious emissions measurements multiple radios were operating simultaneously such that all operating modes were active simultaneously on the high, center or low channel in each band. As the host system can also house a 3x3 version of the module, during radiated spurious emissions tests there were up to sixteen radios active simultaneously on the same channel for these spurious measurements. When installed into host systems the host system firmware will not allow multiple radios to operate on the same or overlapping channels, so if signals were above the limit with multiple radios active, and those signals were related to harmonics of the transmitted signal, then the measurements were repeated with only one set of radios or one mode active because these harmonic emissions would only be present from one radio at any specific time.

During radiated emissions tests for receiver spurious emissions 10 radios (5 of each module type) were in receive mode with all chains active on the following channels: 2437 MHz, 5200 MHz, 5300 MHz, 5580 MHz, and 5785 MHz. This ensured that at least one module was on the center channel in each operating band as required by RSS 210 and RSS GEN.

Measurements on the host system for the frequency range 30 – 1000 MHz demonstrated that all significant emissions were from the host system. Digital device emissions from the host system above 1GHz (occurring at 2.5GHz, 5.0GHz and 7.5GHz) were excluded from the scope of this test report and will be evaluated as a part of the host system digital device tests.

AC conducted emissions measurements were made on the AC input to the Power-Over-Ethernet (PoE) injector used to power the host system. For these measurements all sixteen radios were in a transmit/receive mode with all chains active on the following channels: 2437 MHz, 5200 MHz, 5280 MHz, 5580 MHz, 5785 MHz, 2412 MHz, 2462 MHz, 5180 MHz, 5320 MHz, 5500 MHz, 5700 MHz, 5785 MHz, 2462 MHz, 5240MHz, 5260 MHz, 5540 MHz.

TEST SITE**GENERAL INFORMATION**

Final test measurements were taken at the test sites listed below. Pursuant to section 2.948 of the FCC's Rules and section 3.3 of RSP-100, construction, calibration, and equipment data has been filed with the Commission and with industry Canada.

Site	Registration Numbers		Location
	FCC	Canada	
Chamber 3	769238	2845B-3	41039 Boyce Road Fremont, CA 94538-2435
Chamber 4	211948	2845B-4	
Chamber 5	211948	2845B-5	
Chamber 7	A2LA accreditation	2845B-7	

ANSI C63.4:2003 recommends that ambient noise at the test site be at least 6 dB below the allowable limits. Ambient levels are below this requirement. The test site(s) contain separate areas for radiated and conducted emissions testing. Considerable engineering effort has been expended to ensure that the facilities conform to all pertinent requirements of ANSI C63.4:2003.

CONDUCTED EMISSIONS CONSIDERATIONS

Conducted emissions testing is performed in conformance with ANSI C63.4:2003. Measurements are made with the EUT connected to the public power network through a nominal, standardized RF impedance, which is provided by a line impedance stabilization network, known as a LISN. A LISN is inserted in series with each current-carrying conductor in the EUT power cord.

RADIATED EMISSIONS CONSIDERATIONS

The FCC has determined that radiation measurements made in a shielded enclosure are not suitable for determining levels of radiated emissions. Radiated measurements are performed in an open field environment or in a semi-anechoic chamber. The test sites are maintained free of conductive objects within the CISPR defined elliptical area incorporated in ANSI C63.4:2003 guidelines and meet the Normalized Site Attenuation (NSA) requirements of ANSI C63.4:2003.

MEASUREMENT INSTRUMENTATION

RECEIVER SYSTEM

An EMI receiver as specified in CISPR 16-1-1 is used for emissions measurements. The receivers used can measure over the frequency range of 9 kHz up to 2000 MHz. These receivers allow both ease of measurement and high accuracy to be achieved. The receivers have Peak, Average, and CISPR (Quasi-peak) detectors built into their design so no external adapters are necessary. The receiver automatically sets the required bandwidth for the CISPR detector used during measurements. If the repetition frequency of the signal being measured is below 20Hz, peak measurements are made in lieu of Quasi-Peak measurements.

For measurements above the frequency range of the receivers, a spectrum analyzer is utilized because it provides visibility of the entire spectrum along with the precision and versatility required to support engineering analysis. Average measurements above 1000MHz are performed on the spectrum analyzer using the linear-average method with a resolution bandwidth of 1 MHz and a video bandwidth of 10 Hz, unless the signal is pulsed in which case the average (or video) bandwidth of the measuring instrument is reduced to onset of pulse desensitization and then increased.

INSTRUMENT CONTROL COMPUTER

The receivers utilize either a Rohde & Schwarz EZM Spectrum Monitor/Controller or contain an internal Spectrum Monitor/Controller to view and convert the receiver measurements to the field strength at an antenna or voltage developed at the LISN measurement port, which is then compared directly with the appropriate specification limit. This provides faster, more accurate readings by performing the conversions described under Sample Calculations within the Test Procedures section of this report. Results are printed in a graphic and/or tabular format, as appropriate. A personal computer is used to record all measurements made with the receivers.

The Spectrum Monitor provides a visual display of the signal being measured. In addition, the controller or a personal computer run automated data collection programs which control the receivers. This provides added accuracy since all site correction factors, such as cable loss and antenna factors are added automatically.

LINE IMPEDANCE STABILIZATION NETWORK (LISN)

Line conducted measurements utilize a fifty microhenry Line Impedance Stabilization Network as the monitoring point. The LISN used also contains a 250 uH CISPR adapter. This network provides for calibrated radio frequency noise measurements by the design of the internal low pass and high pass filters on the EUT and measurement ports, respectively.

FILTERS/ATTENUATORS

External filters and precision attenuators are often connected between the receiving antenna or LISN and the receiver. This eliminates saturation effects and non-linear operation due to high amplitude transient events.

ANTENNAS

A loop antenna is used below 30 MHz. For the measurement range 30 MHz to 1000 MHz either a combination of a biconical antenna and a log periodic or a bi-log antenna is used. Above 1000 MHz, horn antennas are used. The antenna calibration factors to convert the received voltage to an electric field strength are included with appropriate cable loss and amplifier gain factors to determine an overall site factor, which is then programmed into the test receivers or incorporated into the test software.

ANTENNA MAST AND EQUIPMENT TURNTABLE

The antennas used to measure the radiated electric field strength are mounted on a non-conductive antenna mast equipped with a motor-drive to vary the antenna height. Measurements below 30 MHz are made with the loop antenna at a fixed height of 1m above the ground plane.

ANSI C63.4:2003 specifies that the test height above ground for table mounted devices shall be 80 centimeters. Floor mounted equipment shall be placed on the ground plane if the device is normally used on a conductive floor or separated from the ground plane by insulating material from 3 to 12 mm if the device is normally used on a non-conductive floor. During radiated measurements, the EUT is positioned on a motorized turntable in conformance with this requirement.

INSTRUMENT CALIBRATION

All test equipment is regularly checked to ensure that performance is maintained in accordance with the manufacturer's specifications. All antennas are calibrated at regular intervals with respect to tuned half-wave dipoles. An exhibit of this report contains the list of test equipment used and calibration information.

TEST PROCEDURES

EUT AND CABLE PLACEMENT

The regulations require that interconnecting cables be connected to the available ports of the unit and that the placement of the unit and the attached cables simulate the worst case orientation that can be expected from a typical installation, so far as practicable. To this end, the position of the unit and associated cabling is varied within the guidelines of ANSI C63.4:2003, and the worst-case orientation is used for final measurements.

CONDUCTED EMISSIONS

Conducted emissions are measured at the plug end of the power cord supplied with the EUT. Excess power cord length is wrapped in a bundle between 30 and 40 centimeters in length near the center of the cord. Preliminary measurements are made to determine the highest amplitude emission relative to the specification limit for all the modes of operation. Placement of system components and varying of cable positions are performed in each mode. A final peak mode scan is then performed in the position and mode for which the highest emission was noted on all current carrying conductors of the power cord.

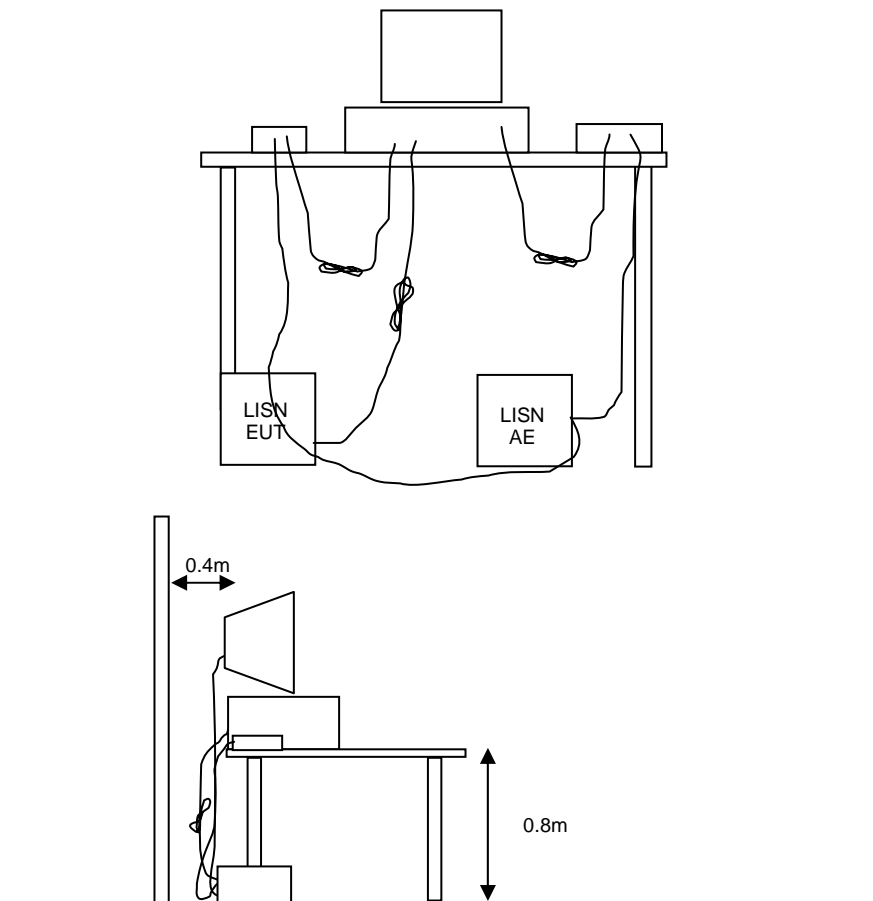

Figure 1 Typical Conducted Emissions Test Configuration

RADIATED EMISSIONS

A preliminary scan of the radiated emissions is performed in which all significant EUT frequencies are identified with the system in a nominal configuration. At least two scans are performed, one scan for each antenna polarization (horizontal and vertical; loop parallel and perpendicular to the EUT). During the preliminary scans, the EUT is rotated through 360°, the antenna height is varied (for measurements above 30 MHz) and cable positions are varied to determine the highest emission relative to the limit. Preliminary scans may be performed in a fully anechoic chamber for the purposes of identifying the frequencies of the highest emissions from the EUT.

A speaker is provided in the receiver to aid in discriminating between EUT and ambient emissions. Other methods used during the preliminary scan for EUT emissions involve scanning with near field magnetic loops, monitoring I/O cables with RF current clamps, and cycling power to the EUT.

Final maximization is a phase in which the highest amplitude emissions identified in the spectral search are viewed while the EUT azimuth angle is varied from 0 to 360 degrees relative to the receiving antenna. The azimuth, which results in the highest emission is then maintained while varying the antenna height from one to four meters (for measurements above 30 MHz, measurements below 30 MHz are made with the loop antenna at a fixed height of 1m). The result is the identification of the highest amplitude for each of the highest peaks. Each recorded level is corrected in the receiver using appropriate factors for cables, connectors, antennas, and preamplifier gain.

When testing above 18 GHz, the receive antenna is located at 1 meter from the EUT and the antenna height is restricted to a maximum of 2.5 meters.

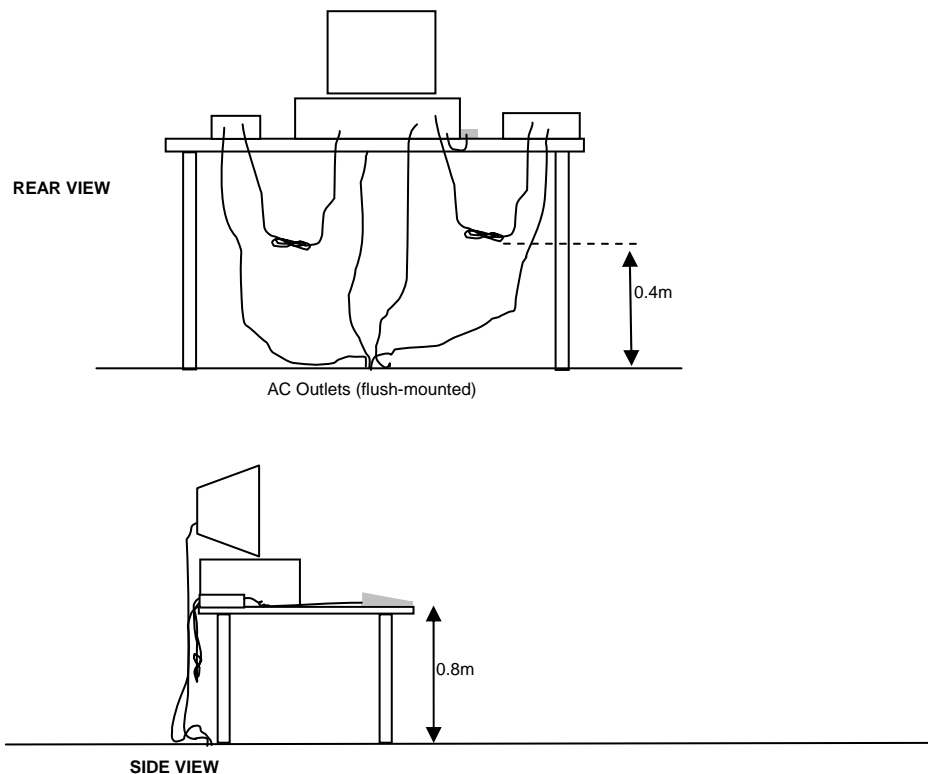

Typical Test Configuration for Radiated Field Strength Measurements

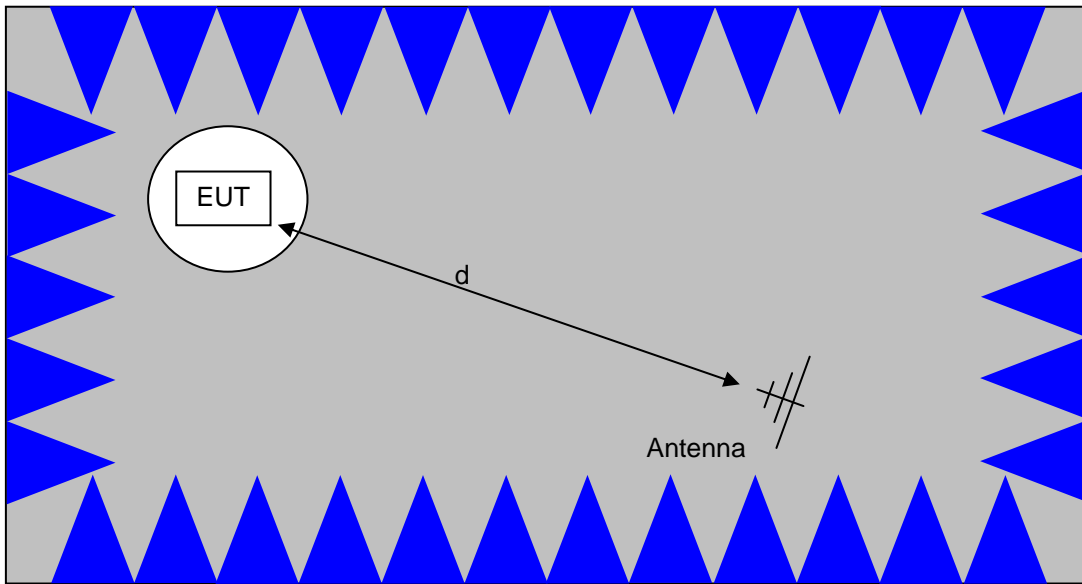

The anechoic materials on the walls and ceiling ensure compliance with the normalized site attenuation requirements of CISPR 16 / CISPR 22 / ANSI C63.4 for an alternate test site at the measurement distances used.

Floor-standing equipment is placed on the floor with insulating supports between the unit and the ground plane.

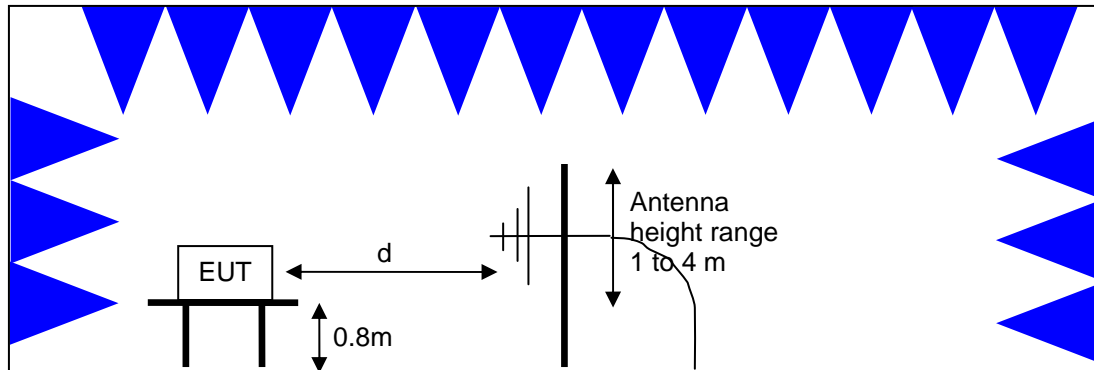

Test Configuration for Radiated Field Strength Measurements
Semi-Anechoic Chamber, Plan and Side Views

CONDUCTED EMISSIONS FROM ANTENNA PORT

Direct measurements of power, bandwidth and power spectral density are performed, where possible, with the antenna port of the EUT connected to either the power meter or spectrum analyzer via a suitable attenuator and/or filter. These are used to ensure that the front end of the measurement instrument is not overloaded by the fundamental transmission.

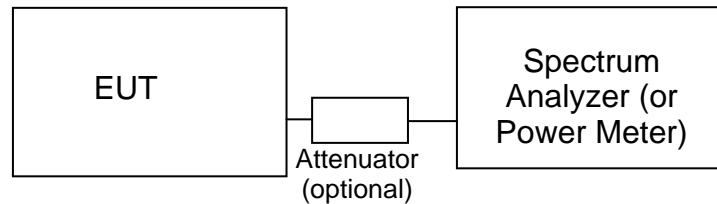
**Test Configuration for Antenna Port Measurements**

Measurement bandwidths (video and resolution) are set in accordance with the relevant standards and Elliott's test procedures for the type of radio being tested. When power measurements are made using a resolution bandwidth less than the signal bandwidth the power is calculated by summing the power across the signal bandwidth using either the analyzer channel power function or by capturing the trace data and calculating the power using software. In both cases the summed power is corrected to account for the equivalent noise bandwidth (ENBW) of the resolution bandwidth used.

If power averaging is used (typically for certain digital modulation techniques), the EUT is configured to transmit continuously. Power averaging is performed using either the built-in function of the analyzer or, if the analyzer does not feature power averaging, using external software. In both cases the average power is calculated over a number of sweeps (typically 100). When the EUT cannot be configured to continuously transmit then either the analyzer is configured to perform a gated sweep to ensure that the power is averaged over periods that the device is transmitting or power averaging is disabled and a max-hold feature is used.

If a power meter is used to make output power measurements the sensor head type (peak or average) is stated in the test data table.

BANDWIDTH MEASUREMENTS

The 6dB, 20dB and/or 26dB signal bandwidth is measured in using the bandwidths recommended by ANSI C63.4. When required, the 99% bandwidth is measured using the methods detailed in RSS GEN.

SPECIFICATION LIMITS AND SAMPLE CALCULATIONS

The limits for conducted emissions are given in units of microvolts, and the limits for radiated emissions are given in units of microvolts per meter at a specified test distance. Data is measured in the logarithmic form of decibels relative to one microvolt, or dB microvolts (dBuV). For radiated emissions, the measured data is converted to the field strength at the antenna in dB microvolts per meter (dBuV/m). The results are then converted to the linear forms of uV and uV/m for comparison to published specifications.

For reference, converting the specification limits from linear to decibel form is accomplished by taking the base ten logarithm, then multiplying by 20. These limits in both linear and logarithmic form are as follows:

CONDUCTED EMISSIONS SPECIFICATION LIMITS: FCC 15.207; FCC 15.107(a), RSS GEN

The table below shows the limits for the emissions on the AC power line from an intentional radiator and a receiver.

Frequency (MHz)	Average Limit (dBuV)	Quasi Peak Limit (dBuV)
0.150 to 0.500	Linear decrease on logarithmic frequency axis between 56.0 and 46.0	Linear decrease on logarithmic frequency axis between 66.0 and 56.0
0.500 to 5.000	46.0	56.0
5.000 to 30.000	50.0	60.0

GENERAL TRANSMITTER RADIATED EMISSIONS SPECIFICATION LIMITS

The table below shows the limits for the spurious emissions from transmitters that fall in restricted bands¹ (with the exception of transmitters operating under FCC Part 15 Subpart D and RSS 210 Annex 9), the limits for all emissions from a low power device operating under the general rules of RSS 310 (tables 3 and 4), RSS 210 (table 2) and FCC Part 15 Subpart C section 15.209.

Frequency Range (MHz)	Limit (uV/m)	Limit (dBuV/m @ 3m)
0.009-0.490	2400/F _{KHz} @ 300m	67.6-20*log ₁₀ (F _{KHz}) @ 300m
0.490-1.705	24000/F _{KHz} @ 30m	87.6-20*log ₁₀ (F _{KHz}) @ 30m
1.705 to 30	30 @ 30m	29.5 @ 30m
30 to 88	100 @ 3m	40 @ 3m
88 to 216	150 @ 3m	43.5 @ 3m
216 to 960	200 @ 3m	46.0 @ 3m
Above 960	500 @ 3m	54.0 @ 3m

RECEIVER RADIATED SPURIOUS EMISSIONS SPECIFICATION LIMITS

The table below shows the limits for the spurious emissions from receivers as detailed in FCC Part 15.109, RSS 210 Table 2, RSS GEN Table 1 and RSS 310 Table 3. Note that receivers operating outside of the frequency range 30 MHz – 960 MHz are exempt from the requirements of 15.109.

Frequency Range (MHz)	Limit (uV/m @ 3m)	Limit (dBuV/m @ 3m)
30 to 88	100	40
88 to 216	150	43.5
216 to 960	200	46.0
Above 960	500	54.0

FCC 15.407 (a) OUTPUT POWER LIMITS

The table below shows the limits for output power and output power density. Where the signal bandwidth is less than 20 MHz the maximum output power is reduced to the power spectral density limit plus 10 times the log of the bandwidth (in MHz).

Operating Frequency (MHz)	Output Power	Power Spectral Density
5150 – 5250	50mW (17 dBm)	4 dBm/MHz

¹ The restricted bands are detailed in FCC 15.203, RSS 210 Table 1 and RSS 310 Table 2

5250 – 5350	250 mW (24 dBm)	11 dBm/MHz
5725 – 5825	1 Watts (30 dBm)	17 dBm/MHz

For system using antennas with gains exceeding 6dBi, the output power and power spectral density limits are reduced by 1dB for every dB the antenna gain exceeds 6dBi. Fixed point-to-point applications using the 5725 – 5825 MHz band may use antennas with gains of up to 23dBi without this limitation. If the gain exceeds 23dBi then the output power limit of 1 Watt is reduced by 1dB for every dB the gain exceeds 23dBi.

The peak excursion envelope is limited to 13dB.

OUTPUT POWER LIMITS –LELAN DEVICES

The table below shows the limits for output power and output power density defined by RSS 210. Where the signal bandwidth is less than 20 MHz the maximum output power is reduced to the power spectral density limit plus 10 times the log of the bandwidth (in MHz).

Operating Frequency (MHz)	Output Power	Power Spectral Density
5150 – 5250	200mW (23 dBm) eirp	10 dBm/MHz eirp
5250 – 5350	250 mW (24 dBm) ² 1W (30dBm) eirp	11 dBm/MHz
5470 – 5725	250 mW (24 dBm) ³ 1W (30dBm) eirp	11 dBm/MHz
5725 – 5825	1 Watts (30 dBm) 4W eirp	17 dBm/MHz

In addition, the power spectral density limit shall be reduced by 1dB for every dB the highest power spectral density exceeds the “average” power spectral density) by more than 3dB. The “average” power spectral density is determined by dividing the output power by $10\log(\text{EBW})$ where EBW is the 99% power bandwidth.

Fixed point-to-point applications using the 5725 – 5825 MHz band may use antennas with gains of up to 23dBi without this limitation. If the gain exceeds 23dBi then the output power limit of 1 Watt is reduced by 1dB for every dB the gain exceeds 23dBi.

SPURIOUS EMISSIONS LIMITS –UNII and LELAN DEVICES

The spurious emissions limits for signals below 1GHz are the FCC/RSS-GEN general limits. For emissions above 1GHz, signals in restricted bands are subject to the FCC/RSS GEN general limits. All other signals have a limit of -27dBm/MHz , which is a field strength of 68.3dBuV/m/MHz at a distance of 3m. This is an average limit so the peak value of the emission may not exceed -7dBm/MHz (88.3dBuV/m/MHz at a distance of 3m). For devices operating in the 5725-5850Mhz bands under the LELAN/UNII rules, the limit within 10Mhz of the allocated band is increased to -17dBm/MHz .

² If EIRP exceeds 500mW the device must employ TPC

³ If EIRP exceeds 500mW the device must employ TPC

SAMPLE CALCULATIONS - CONDUCTED EMISSIONS

Receiver readings are compared directly to the conducted emissions specification limit (decibel form) as follows:

$$R_r - S = M$$

where:

R_r = Receiver Reading in dBuV

S = Specification Limit in dBuV

M = Margin to Specification in +/- dB

SAMPLE CALCULATIONS - RADIATED EMISSIONS

Receiver readings are compared directly to the specification limit (decibel form). The receiver internally corrects for cable loss, preamplifier gain, and antenna factor. The calculations are in the reverse direction of the actual signal flow, thus cable loss is added and the amplifier gain is subtracted. The Antenna Factor converts the voltage at the antenna coaxial connector to the field strength at the antenna elements.

A distance factor, when used for electric field measurements above 30MHz, is calculated by using the following formula:

$$F_d = 20 * \text{LOG}_{10} (D_m/D_s)$$

where:

F_d = Distance Factor in dB

D_m = Measurement Distance in meters

D_s = Specification Distance in meters

For electric field measurements below 30MHz the extrapolation factor is either determined by making measurements at multiple distances or a theoretical value is calculated using the formula:

$$F_d = 40 * \text{LOG}_{10} (D_m/D_s)$$

Measurement Distance is the distance at which the measurements were taken and Specification Distance is the distance at which the specification limits are based. The antenna factor converts the voltage at the antenna coaxial connector to the field strength at the antenna elements.

The margin of a given emission peak relative to the limit is calculated as follows:

$$R_c = R_r + F_d$$

and

$$M = R_c - L_s$$

where:

R_r = Receiver Reading in dBuV/m

F_d = Distance Factor in dB

R_c = Corrected Reading in dBuV/m

L_s = Specification Limit in dBuV/m

M = Margin in dB Relative to Spec

SAMPLE CALCULATIONS - FIELD STRENGTH TO EIRP CONVERSION

Where the radiated electric field strength is expressed in terms of the equivalent isotropic radiated power (eirp), or where a field strength measurement of output power is made in lieu of a direct measurement, the following formula is used to convert between eirp and field strength at a distance of d (meters) from the equipment under test:

$$E = \frac{1000000 \sqrt{30 P}}{d} \quad \text{microvolts per meter}$$

where P is the eirp (Watts)

For a measurement at 3m the conversion from a logarithmic value for field strength (dBuV/m) to an eirp power (dBm) is -95.3dB.

Appendix A Test Equipment Calibration Data**Radio (Spurious Emissions), 20-Oct-11**

<u>Manufacturer</u>	<u>Description</u>	<u>Model</u>	<u>Asset #</u>	<u>Cal Due</u>
EMCO	Antenna, Horn, 1-18GHz	3115	868	6/8/2012
Hewlett Packard	Microwave Preamplifier, 1-26.5GHz	8449B	2199	2/23/2012
Hewlett Packard	SpecAn 9 kHz - 40 GHz, (SA40) Purple	8564E (84125C)	2415	7/28/2012

Radiated Emissions, 1000 - 18,000 MHz (BE), 21-Oct-11

<u>Manufacturer</u>	<u>Description</u>	<u>Model</u>	<u>Asset #</u>	<u>Cal Due</u>
Hewlett Packard	Microwave Preamplifier, 1-26.5GHz	8449B	263	12/8/2011
Hewlett Packard	SpecAn 30 Hz -40 GHz, SV (SA40) Red	8564E (84125C)	1148	8/15/2012
EMCO	Antenna, Horn, 1-18 GHz (SA40-Blu)	3115	1386	9/21/2012

Radiated Emissions, 30 - 10,000 MHz, 23-Oct-11

<u>Manufacturer</u>	<u>Description</u>	<u>Model</u>	<u>Asset #</u>	<u>Cal Due</u>
Hewlett Packard	Microwave Preamplifier, 1-26.5GHz	8449B	263	12/8/2011
Hewlett Packard	EMC Spectrum Analyzer, 9 kHz - 6.5 GHz	8595EM	787	7/29/2012
EMCO	Antenna, Horn, 1-18GHz	3115	868	6/8/2012
Hewlett Packard	SpecAn 30 Hz -40 GHz, SV (SA40) Red	8564E (84125C)	1148	8/15/2012
Rohde & Schwarz	Test Receiver, 9 kHz-2750 MHz	ESCS 30	1337	11/24/2011
Sunol Sciences	Biconilog, 30-3000 MHz	JB3	1548	6/24/2012

Conducted Emissions - AC Power Ports, 23-Oct-11

<u>Manufacturer</u>	<u>Description</u>	<u>Model</u>	<u>Asset #</u>	<u>Cal Due</u>
Hewlett Packard	EMC Spectrum Analyzer, 9 kHz - 6.5 GHz	8595EM	787	7/29/2012
EMCO	LISN, 10 kHz-100 MHz, 25A	3825/2	1292	3/1/2012
Rohde & Schwarz	Test Receiver, 9 kHz-2750 MHz	ESCS 30	1337	11/24/2011
Rohde & Schwarz	Pulse Limiter	ESH3 Z2	1401	4/21/2012

Radiated Emissions Free Space, 1,000 - 6,500 MHz, 28-Oct-11

<u>Manufacturer</u>	<u>Description</u>	<u>Model</u>	<u>Asset #</u>	<u>Cal Due</u>
Hewlett Packard	Microwave Preamplifier, 1-26.5GHz	8449B	263	12/8/2011
EMCO	Antenna, Horn, 1-18 GHz	3115	786	12/11/2011
Hewlett Packard	SpecAn 30 Hz -40 GHz, SV (SA40) Red	8564E (84125C)	1148	8/15/2012

Appendix B Test Data

T85088 Pages 27 - 41



EMC Test Data

Client:	Xirrus, Inc.	Job Number:	J84865
Model:	XR6000 3x3	T-Log Number:	T85088
		Account Manager:	Susan Pelzl
Contact:	Steve Smith		-
Emissions Standard(s):	FCC 15.247, 15.E, 15.B, EN 55022	Class:	A
Immunity Standard(s):	-	Environment:	-

EMC Test Data

For The

Xirrus, Inc.

Model

XR6000 3x3

Date of Last Test: 11/16/2011

Client:	Xirrus, Inc.	Job Number:	J84865
Model:	XR6000 3x3	T-Log Number:	T85088
Contact:	Steve Smith	Account Manager:	Susan Pelzl
Standard:	FCC 15.247, 15.E, 15.B, EN 55022	Class:	N/A

RSS 210 and FCC 15.407 (UNII) Radiated Spurious Emissions

Test Specific Details

Objective: The objective of this test session is to perform final qualification testing of the EUT with respect to the specification listed above.

General Test Configuration

For radiated emissions testing the measurement antenna was located 3 meters from the EUT.

Ambient Conditions:

Temperature: 20.3 °C
Rel. Humidity: 34 %

Summary of Results

Run #	Mode	Channel	Power Setting	Test Performed	Limit	Result / Margin
1	HT20 Chain 012	5150-5250 #36 (low)	-	Restricted Band Edge at 5150 MHz	15.209	51.4dBµV/m @ 5149.9MHz (-2.6dB)
		5150-5250 #40	-	Restricted Band Edge at 5150 MHz		51.7dBµV/m @ 5150.0MHz (-2.3dB)
2	HT20 Chain 012	5250-5350 #64 (High)	-	Restricted Band Edge at 5350 MHz	15.209	49.5dBµV/m @ 5350.0MHz (-4.5dB)
		5150-5250 #60	-	Restricted Band Edge at 5350 MHz		53.4dBµV/m @ 5360.0MHz (-0.6dB)
3	HT20 Chain 012	5470-5725 Low	-	Restricted Band Edge at 5460 MHz	15.209	53.7dBµV/m @ 5460.0MHz (-0.3dB)

Testing was performed on the worse case mode from the original filing.
Power was set to be within 0.5dB of the original filing power.

Modifications Made During Testing

No modifications were made to the EUT during testing

Deviations From The Standard

No deviations were made from the requirements of the standard.

Client: Xirrus, Inc.	Job Number: J84865
Model: XR6000 3x3	T-Log Number: T85088
Contact: Steve Smith	Account Manager: Susan Pelzl
Standard: FCC 15.247, 15.E, 15.B, EN 55022	Class: N/A

Run #1, Radiated Spurious Emissions at Band Edges. Operation in the 5150-5250 MHz Band

Run #1a: Low Channel, 5180 MHz
 Date of Test: 10/21/2011
 Test Engineer: John Caizzi & Jack Liu
 Test Location: FT7

5150 MHz Band Edge Signal Radiated Field Strength

Frequency	Level	Pol	FCC 15.209		Detector	Azimuth	Height	Comments	Chains
MHz	dB μ V/m	v/h	Limit	Margin	Pk/QP/Avg	degrees	meters		
5149.900	51.4	V	54.0	-2.6	AVG	4	1.00		
5149.500	67.7	V	74.0	-6.3	PK	4	1.00		

Note 1 Powers listed above from TP settings in command line. After, UNII pwr was measured with ART2 at setting 13.5: 14.4/14.3/14.5 dBm (chains 012).

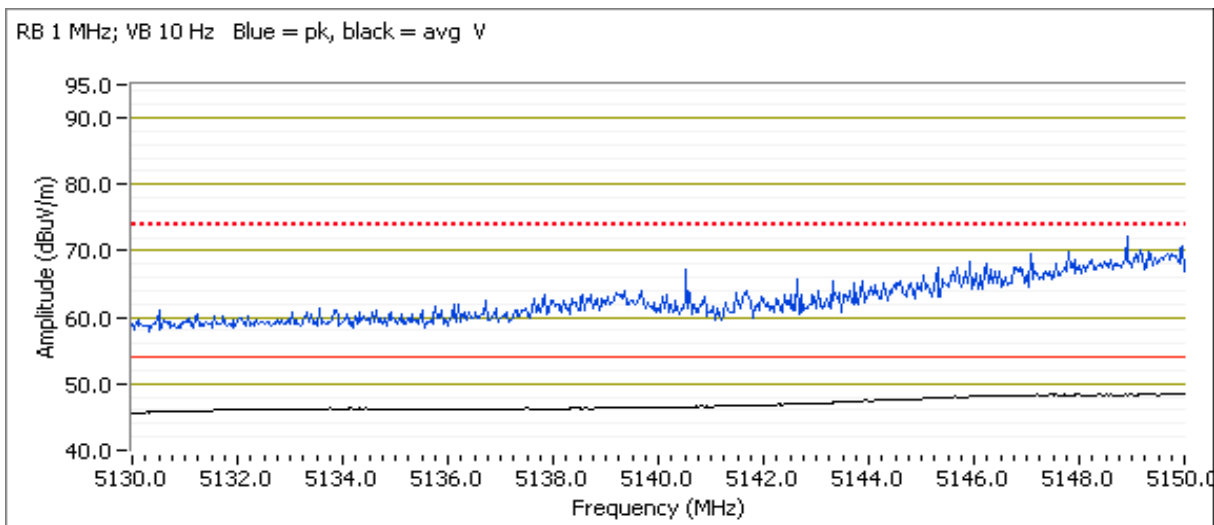

Client: Xirrus, Inc.	Job Number: J84865
Model: XR6000 3x3	T-Log Number: T85088
Contact: Steve Smith	Account Manager: Susan Pelzl
Standard: FCC 15.247, 15.E, 15.B, EN 55022	Class: N/A

Run #1b: Channel 40, 5200 MHz

Date of Test: 10/21/2011
 Test Engineer: John Caizzi & Jack Liu
 Test Location: FT7

5150 MHz Band Edge Signal Radiated Field Strength

Frequency	Level	Pol	FCC 15.209		Detector	Azimuth	Height	Comments	Chains
MHz	dB μ V/m	v/h	Limit	Margin	PK/QP/Avg	degrees	meters		
5149.970	51.7	V	54.0	-2.3	AVG	0	1.0		
5148.330	67.3	V	74.0	-6.7	PK	0	1.0		

Note 1

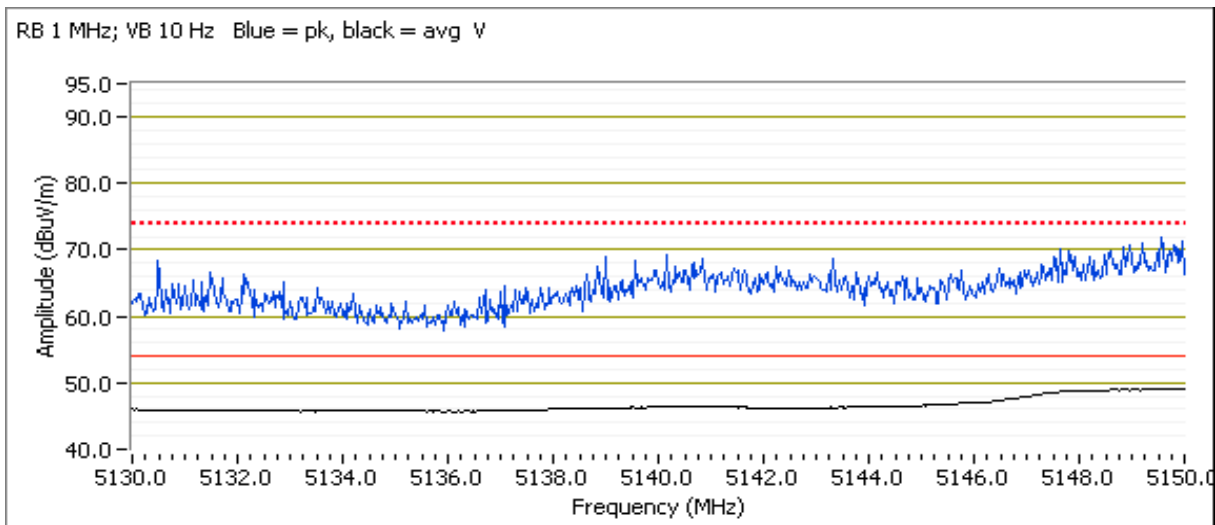

Client:	Xirrus, Inc.	Job Number:	J84865
Model:	XR6000 3x3	T-Log Number:	T85088
Contact:	Steve Smith	Account Manager:	Susan Pelzl
Standard:	FCC 15.247, 15.E, 15.B, EN 55022	Class:	N/A

Run #2, Radiated Spurious Emissions at Band Edges. Operation in the 5250-5350 MHz Band
Run #2a High Channel

Date of Test: 10/21/2011
 Test Engineer: John Caizzi & Jack Liu
 Test Location: FT7

5350 MHz Band Edge Signal Radiated Field Strength

Frequency	Level	Pol	FCC 15.209		Detector	Azimuth	Height	Comments	Chains
MHz	dB μ V/m	v/h	Limit	Margin	Pk/QP/Avg	degrees	meters		
5350.000	49.5	V	54.0	-4.5	AVG	319	1.0		
5350.100	64.6	V	74.0	-9.4	PK	319	1.0		

Note 1 -

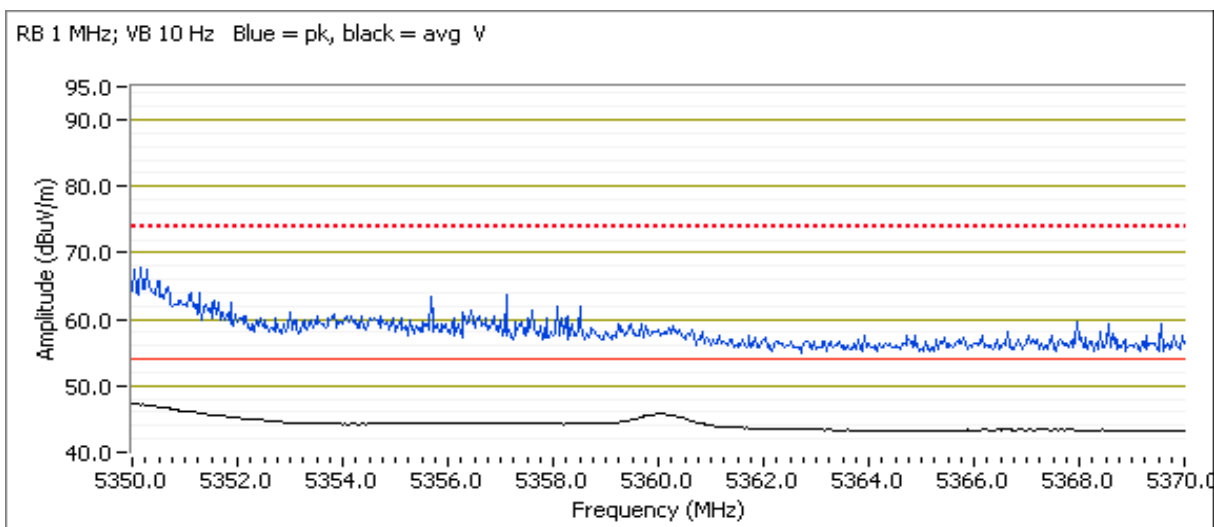

Client: Xirrus, Inc.	Job Number: J84865
Model: XR6000 3x3	T-Log Number: T85088
Contact: Steve Smith	Account Manager: Susan Pelzl
Standard: FCC 15.247, 15.E, 15.B, EN 55022	Class: N/A

Run #2a Channel 60, 5300 MHz

Date of Test: 10/21/2011
 Test Engineer: John Caizzi & Jack Liu
 Test Location: FT7

5350 MHz Band Edge Signal Radiated Field Strength

Frequency	Level	Pol	FCC 15.209		Detector	Azimuth	Height	Comments	Chains
MHz	dB μ V/m	v/h	Limit	Margin	Pk/QP/Avg	degrees	meters		
5359.970	53.4	V	54.0	-0.6	AVG	333	1.1		
5350.870	65.2	V	74.0	-8.8	PK	333	1.1		

Note 1

-

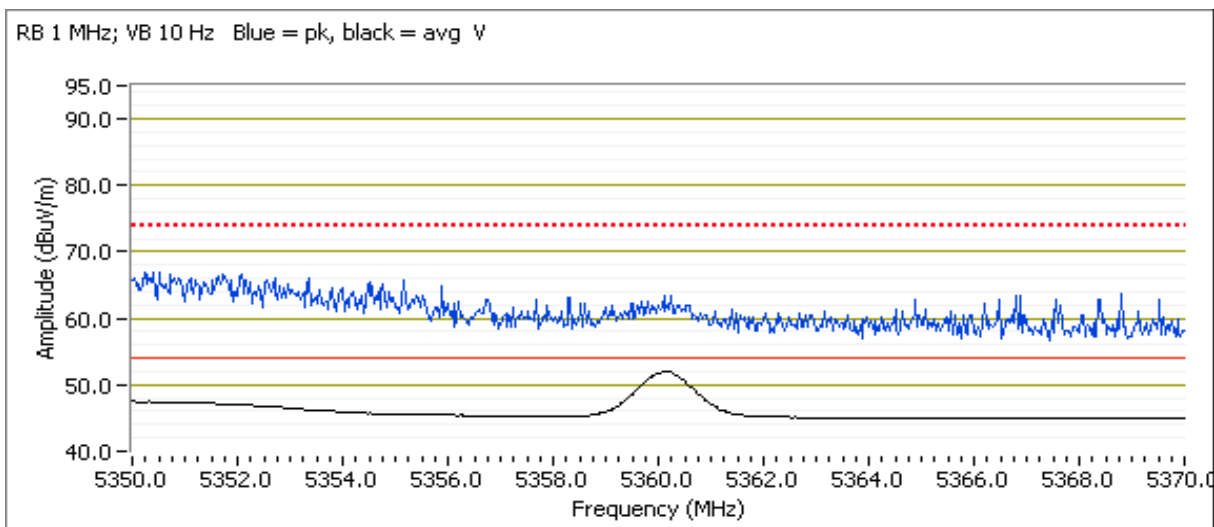

Client: Xirrus, Inc.	Job Number: J84865
Model: XR6000 3x3	T-Log Number: T85088
Contact: Steve Smith	Account Manager: Susan Pelzl
Standard: FCC 15.247, 15.E, 15.B, EN 55022	Class: N/A

Run #3, Radiated Spurious Emissions at Band Edges. Operation in the 5470-5725 MHz Band
Run #3a: Low Channel

Date of Test: 10/21/2011
 Test Engineer: John Caizzi & Jack Liu
 Test Location: FT7

5350-5460 MHz Restricted Band Edge Signal Radiated Field Strength

Frequency	Level	Pol	FCC 15.209		Detector	Azimuth	Height	Comments	Chains
MHz	dB μ V/m	v/h	Limit	Margin	Pk/QP/Avg	degrees	meters		
5459.970	53.7	V	54.0	-0.3	AVG	0	1.0		
5447.830	68.8	V	74.0	-5.2	PK	0	1.0		

Note 1 Powers listed above from TP settings in command line. After, UNII pwr was measured with ART2 at setting 16.5: 17.52/17.50/17.14 dBm (chains 012).

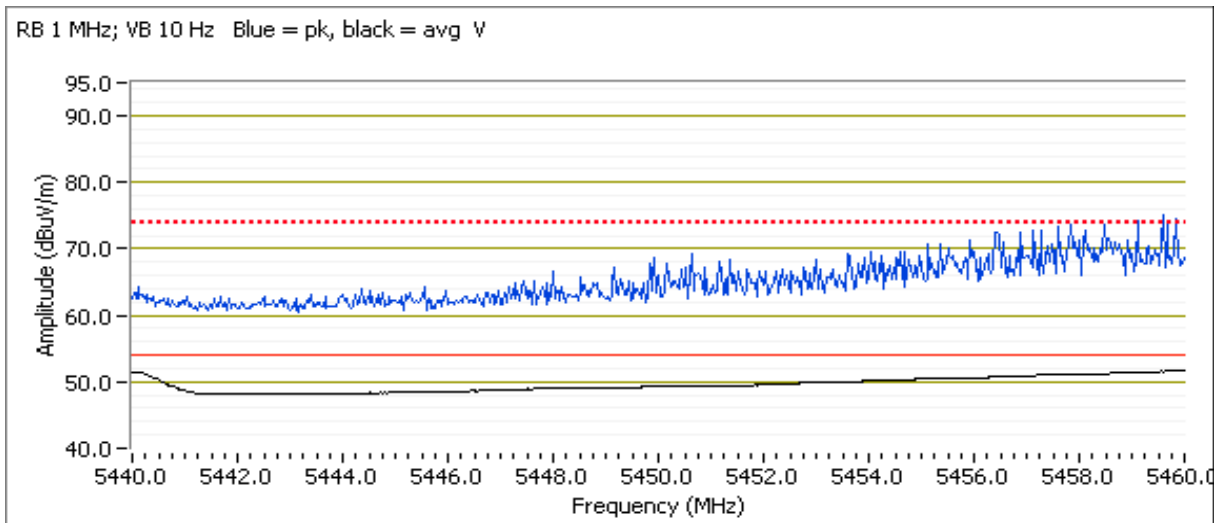

Client:	Xirrus, Inc.	Job Number:	J84865
Model:	XR6000 3x3	T-Log Number:	T85088
		Account Manager:	Susan Pelzl
Contact:	Steve Smith		
Standard:	FCC 15.247, 15.E, 15.B, EN 55022	Class:	N/A

RSS 210 and FCC 15.407 (UNII) Radiated Spurious Emissions

Test Specific Details

Objective: The objective of this test session is to perform final qualification testing of the EUT with respect to the specification listed above.

General Test Configuration

For radiated emissions testing the measurement antenna was located 3 meters from the EUT.

Ambient Conditions:

Temperature: 20-25 °C

Rel. Humidity: 30-40 %

Modifications Made During Testing

No modifications were made to the EUT during testing

Deviations From The Standard

No deviations were made from the requirements of the standard.

Client: Xirrus, Inc.	Job Number: J84865
Model: XR6000 3x3	T-Log Number: T85088
	Account Manager: Susan Pelzl
Contact: Steve Smith	
Standard: FCC 15.247, 15.E, 15.B, EN 55022	Class: N/A

Summary of Results

Spurious Radiated Emissions: 2x2 and 3x3 Modules for 802.11a; HT20; and HT40 modes

Run #	Mode	Channel	Power Setting	Measured Power	Test Performed	Limit	Result / Margin
1	802.11a Chain 012	5150-5250 Low, Middle, High	-		Radiated Emissions, 1 - 40 GHz	FCC 15.209 / 15 E	53.1dB μ V/m @ 5440.1MHz (-0.9dB)
	802.11n20 Chain 012		-				
	802.11n40 Chain 012		-				
2	802.11a Chain 012	5250-5350 Low, Middle, High	-		Radiated Emissions, 1 - 40 GHz	FCC 15.209 / 15 E	52.9dB μ V/m @ 5440.0MHz (-1.1dB)
	802.11n20 Chain 012		-				
	802.11n40 Chain 012		-				
3	802.11a Chain 012	5470-5725 Low, Middle, High	-		Radiated Emissions, 1 - 40 GHz	FCC 15.209 / 15 E	46.7dB μ V/m @ 2500.0MHz (-7.3dB)
	802.11n20 Chain 012		-				
	802.11n40 Chain 012		-				

Client:	Xirrus, Inc.	Job Number:	J84865
Model:	XR6000 3x3	T-Log Number:	T85088
Contact:	Steve Smith	Account Manager:	Susan Pelzl
Standard:	FCC 15.247, 15.E, 15.B, EN 55022	Class:	N/A

System Configuration:
Operating within 5150-5250 MHz

Radio #	Frequency	Module	Mode	Radio #	Frequency	Module	Mode
1	5180	2x2	802.11a	9	5240	2x2	802.11a
0	5180	3x3	802.11a	8	5240	3x3	802.11a
3	5180	2x2	802.11HT20	11	5240	2x2	802.11HT20
2	5180	3x3	802.11HT20	10	5240	3x3	802.11HT20
5	5190	2x2	802.11HT40	13	5230	2x2	802.11HT40
4	5190	3x3	802.11HT40	12	5230	3x3	802.11HT40
7	5200	2x2	802.11a	15	5200	2x2	802.11HT20
6	5200	3x3	802.11a	14	5200	3x3	802.11HT20

System Configuration:
Operating within 5250-5350 MHz

Radio #	Frequency	Module	Mode	Radio #	Frequency	Module	Mode
1	5260	2x2	802.11a	9	5320	2x2	802.11a
0	5260	3x3	802.11a	8	5320	3x3	802.11a
3	5260	2x2	802.11HT20	11	5320	2x2	802.11HT20
2	5260	3x3	802.11HT20	10	5320	3x3	802.11HT20
5	5270	2x2	802.11HT40	13	5310	2x2	802.11HT40
4	5270	3x3	802.11HT40	12	5310	3x3	802.11HT40
7	5300	2x2	802.11a	15	5300	2x2	802.11HT20
6	5300	3x3	802.11a	14	5300	3x3	802.11HT20

System Configuration:
Operating within 5470-5725 MHz

Radio #	Frequency	Module	Mode	Radio #	Frequency	Module	Mode
1	5500	2x2	802.11a	9	5700	2x2	802.11a
0	5500	3x3	802.11a	8	5700	3x3	802.11a
3	5500	2x2	802.11HT20	11	5700	2x2	802.11HT20
2	5500	3x3	802.11HT20	10	5700	3x3	802.11HT20
5	5510	2x2	802.11HT40	13	5670	2x2	802.11HT40
4	5510	3x3	802.11HT40	12	5670	3x3	802.11HT40
7	5580	2x2	802.11a	15	5580	2x2	802.11HT20
6	5580	3x3	802.11a	14	5580	3x3	802.11HT20

Notes - Multiple radios operating at the same time as shown above. In all cases, power set to the maximum worst case single channel power, transmitting on all chains.

Client: Xirrus, Inc.	Job Number: J84865
Model: XR6000 3x3	T-Log Number: T85088
Contact: Steve Smith	Account Manager: Susan Pelzl
Standard: FCC 15.247, 15.E, 15.B, EN 55022	Class: N/A

Run #1, Radiated Spurious Emissions, 30 - 40,000 MHz. Operation in the 5150-5250 MHz Band
 Date of Test: 10/17/2011 Test Location: FT Chamber #7
 Test Engineer: M. Birgani

**Run #1a: Low, Middle, and High Channel
 Other Spurious Emissions**

Frequency MHz	Level dB μ V/m	Pol v/h	15.209 / 15E		Detector Pk/QP/Avg	Azimuth degrees	Height meters	Comments
			Limit	Margin				
5440.050	53.1	V	54.0	-0.9	AVG	0	1.0	RB 1 MHz;VB 10 Hz;Pk
2500.000	46.5	V	54.0	-7.5	AVG	312	1.0	RB 1 MHz;VB 10 Hz;Pk
1500.010	42.3	V	54.0	-11.7	AVG	312	1.0	RB 1 MHz;VB 10 Hz;Pk
5000.060	60.4	V	74.0	-13.6	PK	157	1.0	RB 1 MHz;VB 3 MHz;Pk
5440.160	60.3	V	74.0	-13.7	PK	0	1.0	RB 1 MHz;VB 3 MHz;Pk
6906.630	60.6	V	75.0	-14.4	PK	353	1.0	RB 1 MHz;VB 3 MHz;Pk
2499.960	48.8	V	74.0	-25.2	PK	312	1.0	RB 1 MHz;VB 3 MHz;Pk
1500.100	46.4	V	74.0	-27.6	PK	312	1.0	RB 1 MHz;VB 3 MHz;Pk
4999.960	56.3	V	54.0	2.3	AVG	157	1.0	RB 1 MHz;VB 10 Hz;Pk, note 4

- Note 1: For emissions in restricted bands, the limit of 15.209 was used which requires average and peak measurements.
- Note 2: For emissions outside of the restricted bands the limit is -27dBm/MHz eirp (68.3dB μ V/m). The measurement method required is the same measurement method used to determine the in-band power spectral density or a peak measurement (RB=1MHz, VB>1MHz). Pavg indicates that the power averaging method of measurement was used for the measurement of emissions outside of the restricted bands. PK indicates that a peak measurement was made.
- Note 3: No significant emissions were observed for 18-40GHz
- Note 4: Emission from the digital circuitry of the host system. Refer to FCC 15.B test results.

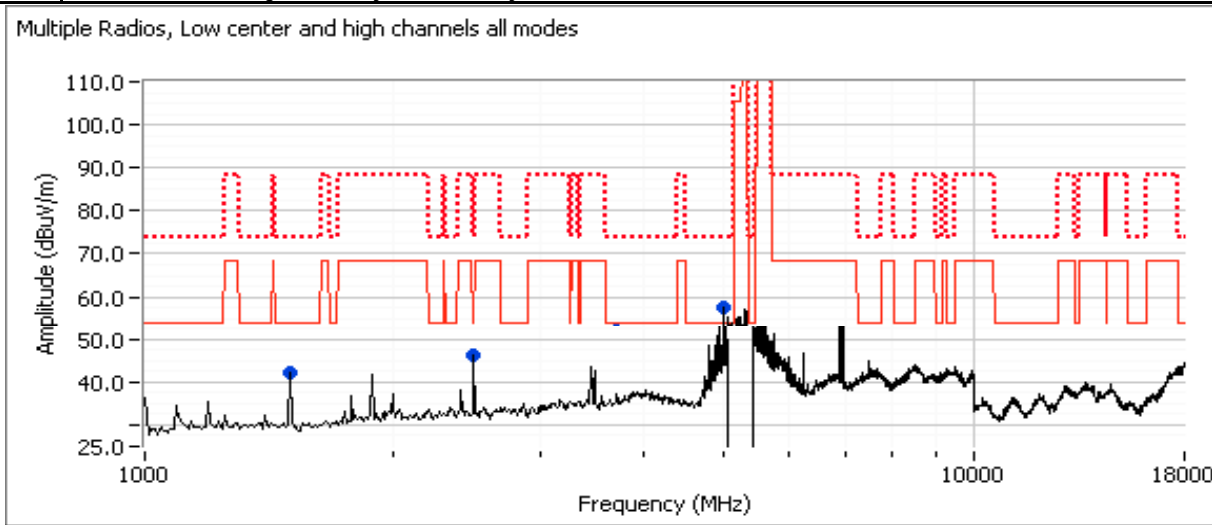

Client: Xirrus, Inc.	Job Number: J84865
Model: XR6000 3x3	T-Log Number: T85088
Contact: Steve Smith	Account Manager: Susan Pelzl
Standard: FCC 15.247, 15.E, 15.B, EN 55022	Class: N/A

Run #2, Radiated Spurious Emissions, 30 - 40,000 MHz. Operation in the 5250-5350 MHz Band
 Date of Test: 10/17/2011 Test Location: FT Chamber #7
 Test Engineer: M. Birgani

**Run #2a: Low, Middle, and High Channel
 Other Spurious Emissions**

Frequency MHz	Level dB μ V/m	Pol v/h	15.209 / 15E		Detector Pk/QP/Avg	Azimuth degrees	Height meters	Comments
			Limit	Margin				
5439.970	52.9	V	54.0	-1.1	AVG	309	1.1	RB 1 MHz;VB 10 Hz;Pk
2500.000	46.5	V	54.0	-7.5	AVG	312	1.0	RB 1 MHz;VB 10 Hz;Pk
1500.010	42.3	V	54.0	-11.7	AVG	312	1.0	RB 1 MHz;VB 10 Hz;Pk
5439.940	61.2	V	74.0	-12.8	PK	309	1.1	RB 1 MHz;VB 3 MHz;Pk
4999.940	60.0	V	74.0	-14.0	PK	28	1.0	RB 1 MHz;VB 3 MHz;Pk
7013.280	54.5	V	70.0	-15.5	PK	354	1.0	RB 1 MHz;VB 3 MHz;Pk
2499.960	48.8	V	74.0	-25.2	PK	312	1.0	RB 1 MHz;VB 3 MHz;Pk
1500.100	46.4	V	74.0	-27.6	PK	312	1.0	RB 1 MHz;VB 3 MHz;Pk
7013.330	48.3	V	100.0	-51.7	AVG	354	1.0	RB 1 MHz;VB 10 Hz;Pk
4999.990	55.7	V	54.0	1.7	AVG	28	1.0	RB 1 MHz;VB 10 Hz;Pk, Note 4

- Note 1: For emissions in restricted bands, the limit of 15.209 was used which requires average and peak measurements.
- Note 2: For emissions outside of the restricted bands the limit is -27dBm/MHz eirp (68.3dBuV/m). The measurement method required is the same measurement method used to determine the in-band power spectral density or a peak measurement (RB=1MHz, VB>1MHz). Pavg indicates that the power averaging method of measurement was used for the measurement of emissions outside of the restricted bands. PK indicates that a peak measurement was made.
- Note 3: No significant emissions were observed for 18-40GHz
- Note 4: Emission from the digital circuitry of the host system. Refer to FCC 15.B test results.

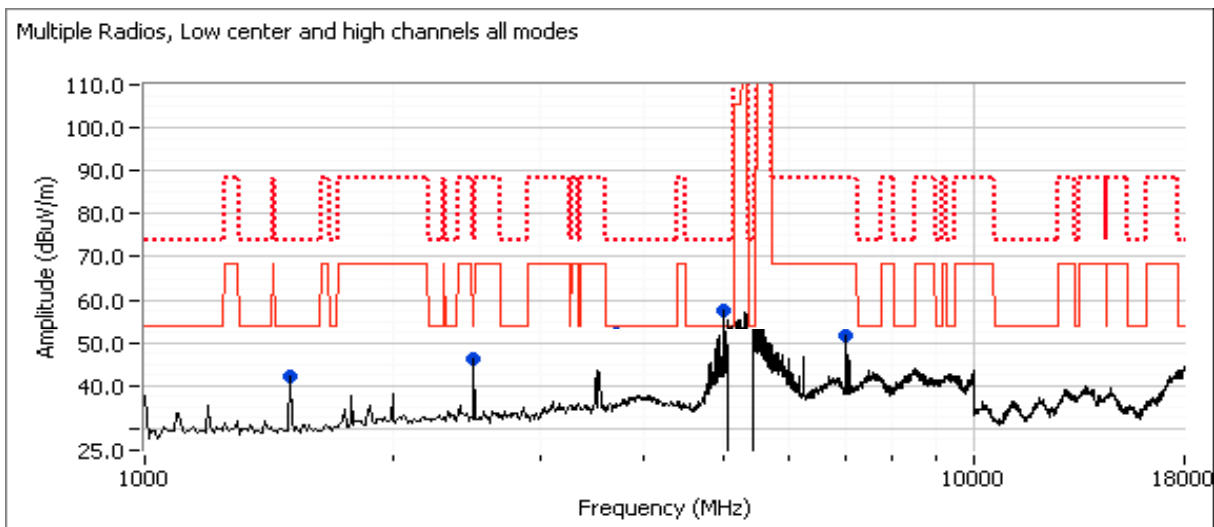

Client: Xirrus, Inc.	Job Number: J84865
Model: XR6000 3x3	T-Log Number: T85088
Contact: Steve Smith	Account Manager: Susan Pelzl
Standard: FCC 15.247, 15.E, 15.B, EN 55022	Class: N/A

Run #3, Radiated Spurious Emissions, 30 - 40,000 MHz. Operation in the 5470-5725 MHz Band
 Date of Test: 10/17/2011 Test Location: FT Chamber #7
 Test Engineer: M. Birgani

**Run #3a: Low, Middle, and High Channel
 Other Spurious Emissions**

Frequency MHz	Level dB μ V/m	Pol v/h	15.209 / 15E		Detector Pk/QP/Avg	Azimuth degrees	Height meters	Comments	Chain
			Limit	Margin					
2499.990	46.7	V	54.0	-7.3	AVG	312	1.0	RB 1 MHz;VB 10 Hz;Pk	
1500.000	42.7	V	54.0	-11.3	AVG	310	1.0	RB 1 MHz;VB 10 Hz;Pk	
5000.130	60.6	V	74.0	-13.4	PK	29	1.1	RB 1 MHz;VB 3 MHz;Pk	
3719.980	39.7	H	54.0	-14.3	AVG	312	1.0	RB 1 MHz;VB 10 Hz;Pk	
3719.930	51.4	H	74.0	-22.6	PK	312	1.0	RB 1 MHz;VB 3 MHz;Pk	
2499.980	49.1	V	74.0	-24.9	PK	312	1.0	RB 1 MHz;VB 3 MHz;Pk	
1499.930	47.5	V	74.0	-26.5	PK	310	1.0	RB 1 MHz;VB 3 MHz;Pk	
5000.000	56.8	V	54.0	2.8	AVG	29	1.1	RB 1 MHz;VB 10 Hz;Pk, note 4	

- Note 1: For emissions in restricted bands, the limit of 15.209 was used which requires average and peak measurements.
- Note 2: For emissions outside of the restricted bands the limit is -27dBm/MHz eirp (68.3dBuV/m). The measurement method required is the same measurement method used to determine the in-band power spectral density or a peak measurement (RB=1MHz, VB>1MHz). Pavg indicates that the power averaging method of measurement was used for the measurement of emissions outside of the restricted bands. PK indicates that a peak measurement was made.
- Note 3: No significant emissions were observed for 18-40GHz
- Note 4: Emission from the digital circuitry of the host system. Refer to FCC 15.B test results.

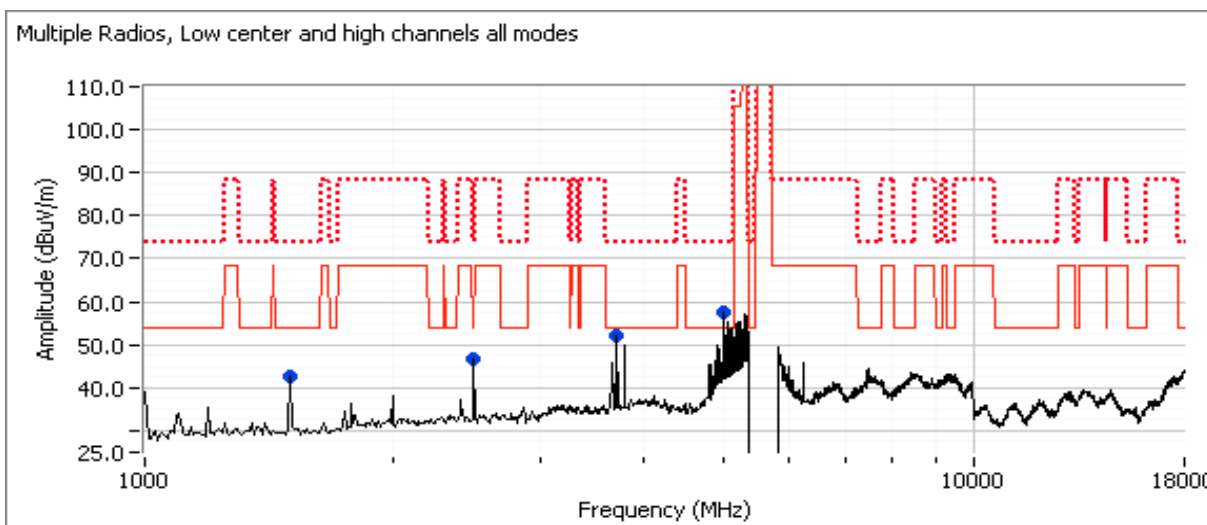

Client:	Xirrus, Inc.	Job Number:	J84865
Model:	XR6000 3x3	T-Log Number:	T85088
Contact:	Steve Smith	Account Manager:	Susan Pelzl
Standard:	FCC 15.247, 15.E, 15.B, EN 55022	Class:	A

Radiated Emissions

(Elliott Laboratories Fremont Facility, Semi-Anechoic Chamber)

Test Specific Details

Objective: The objective of this test session is to perform final qualification testing of the EUT with respect to the specification listed above.

Date of Test: 10/20/2011 0:00
 Test Engineer: Jack Liu
 Test Location: FT Chamber #4

Config. Used: 1
 Config Change: None
 EUT Voltage: POE

General Test Configuration

The EUT and all local support equipment were located on the turntable for radiated spurious emissions testing. All remote support equipment was located approximately 30 meters from the EUT .

For radiated emissions testing the measurement antenna was located 3 meters from the EUT.

Ambient Conditions:

Temperature: 20-25 °C
 Rel. Humidity: 30-40 %

Summary of Results

Run #	Mode	Channel	Power Setting	Measured Power	Test Performed	Limit	Result / Margin
1	Rx	ALL	-	-	Radiated Emissions, 1 - 18GHz	RSS-GEN	53.2dBµV/m @ 3800.0MHz (-0.8dB)

Test performed with one of each module type (2x2 or 3x3) tuned to the center frequency of each operating band.

System Configuration:

Radio #	Module	Channel/Freq			
1	2x2	2437	6	3x3	5300
0	3x3	2437	9	2x2	5580
5	2x2	5200	8	3x3	5580
4	3x3	5200	3	2x2	5785
7	2x2	5300	2	3x3	5785

Modifications Made During Testing

No modifications were made to the EUT during testing

Deviations From The Standard

No deviations were made from the requirements of the standard.

Client:	Xirrus, Inc.	Job Number:	J84865
Model:	XR6000 3x3	T-Log Number:	T85088
Contact:	Steve Smith	Account Manager:	Susan Pelzl
Standard:	FCC 15.247, 15.E, 15.B, EN 55022	Class:	A

Run #1, Radiated Spurious Emissions, 1000 - 18,000 MHz.

Date of Test: 10/20/2011
 Test Engineer: Jack Liu
 Test Location: FT4

Frequency MHz	Level dB μ V/m	Pol v/h	RSS-GEN		Detector Pk/QP/Avg	Azimuth degrees	Height meters	Comments
			Limit	Margin				
3799.980	53.2	H	54.0	-0.8	AVG	273	1.1	RB 1 MHz;VB 10 Hz;Pk
3726.650	51.5	H	54.0	-2.5	AVG	153	1.0	RB 1 MHz;VB 10 Hz;Pk
3863.380	47.5	V	54.0	-6.5	AVG	335	1.5	RB 1 MHz;VB 10 Hz;Pk
3459.990	47.0	H	54.0	-7.0	AVG	81	1.0	RB 1 MHz;VB 10 Hz;Pk
7499.950	45.9	V	54.0	-8.1	AVG	106	1.5	RB 1 MHz;VB 10 Hz;Pk
7726.700	40.5	V	54.0	-13.5	AVG	58	1.3	RB 1 MHz;VB 10 Hz;Pk
3800.010	55.6	H	74.0	-18.4	PK	273	1.1	RB 1 MHz;VB 3 MHz;Pk
3726.680	53.8	H	74.0	-20.2	PK	153	1.0	RB 1 MHz;VB 3 MHz;Pk
7499.660	51.4	V	74.0	-22.6	PK	106	1.5	RB 1 MHz;VB 3 MHz;Pk
3863.420	51.1	V	74.0	-22.9	PK	335	1.5	RB 1 MHz;VB 3 MHz;Pk
3460.040	50.4	H	74.0	-23.6	PK	81	1.0	RB 1 MHz;VB 3 MHz;Pk
7726.980	49.0	V	74.0	-25.0	PK	58	1.3	RB 1 MHz;VB 3 MHz;Pk

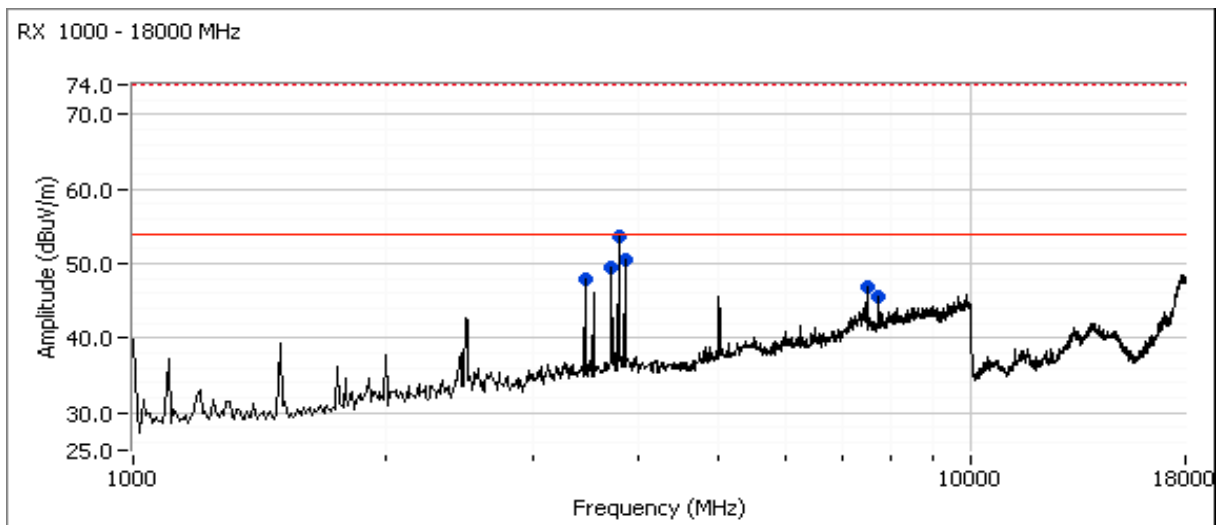

End of Report

This page is intentionally blank and marks the last page of this test report.