

Test of Xirrus Inc. XI-AC1300, XI-AC867 (non-DFS
Bands)

To: FCC 47 CFR Part 15.407 & IC RSS-210

Test Report Serial No.: XIRR04-U6 Rev A



This report has measurement results for two separate RF modules XI-AC1300 and XI-AC867. The results have been compiled into a single report for referencing purposes, see Section 2.2 Scope of Test Program;

3x3 FCC ID: SK6-XI-AC1300

2x2 FCC ID: SK6-XI-AC867

TEST REPORT

FROM



Test of Xirrus Inc. XI-AC1300, XI-AC867 (non-DFS Bands)

to

To FCC 47 CFR Part 15.407 & IC RSS-210

Test Report Serial No.: XIRR04-U6 Rev A

Note: this report contains data with regard to the 5,150 to 5,250 MHz band for Xirrus Inc., XI-AC1300 and XI-AC867 Wireless modules. 2.4 and 5.8 GHz test data are reported in MiCOM Labs test report XIRR04-U3

This report supersedes None

Applicant: Xirrus Inc.
2101 Corporate Center Drive
Thousand Oaks
California 91320, USA

Product Function: Wireless Access Point

Copy No: pdf Issue Date: 29th April 2014

This Test Report is Issued Under the Authority of;

MiCOM Labs, Inc.
575 Boulder Court
Pleasanton, CA 94566 USA
Phone: +1 (925) 462-0304
Fax: +1 (925) 462-0306
www.micomlabs.com



TESTING CERT #2381.01

MiCOM Labs is an ISO 17025 Accredited Testing Laboratory



Title: Xirrus Inc. XI-AC1300, XI-AC867 (non-DFS Bands)
To: FCC 47 CFR Part 15.407 & IC RSS-210
Serial #: XIRR04-U6 Rev A
Issue Date: 29th April 2014
Page: 3 of 199

This page has been left intentionally blank

This test report may be reproduced in full only. The document may only be updated by MiCOM Labs personnel. Any changes will be noted in the Document History section of the report.



TABLE OF CONTENTS

ACCREDITATION, LISTINGS & RECOGNITION	6
TESTING ACCREDITATION	6
RECOGNITION	7
PRODUCT CERTIFICATION	8
1. TEST RESULT CERTIFICATE	10
2. REFERENCES AND MEASUREMENT UNCERTAINTY	11
2.1. Normative References.....	11
2.2. Test and Uncertainty Procedures.....	12
3. PRODUCT DETAILS AND TEST CONFIGURATIONS	13
3.1. Technical Details.....	13
3.2. Scope of Test Program	14
3.3. Equipment Model(s) and Serial Number(s).....	20
3.4. Antenna Details.....	20
3.5. Cabling and I/O Ports.....	20
3.6. Test Configurations	21
3.7. Equipment Modifications	22
3.8. Deviations from the Test Standard.....	22
3.9. Subcontracted Testing or Third Party Data	22
4. TESTING EQUIPMENT CONFIGURATION(S)	23
4.1. Conducted RF Emission Test Set-up.....	23
4.2. Radiated Spurious Emission Test Set-up > 1 GHz	24
4.3. Digital Emissions Test Set-up (0.03 – 1 GHz).....	25
4.4. ac Wireline Emission Test Set-up	26
5. TEST SUMMARY	27
6. TEST RESULTS	29
6.1. Device Characteristics.....	29
6.1.1. <i>Conducted Testing</i>	29
6.1.2. <i>Radiated Emission Testing</i>	60
6.1.3. <i>AC Wireline Conducted Emissions (150 kHz – 30 MHz)</i>	76
7. PHOTOGRAPHS	79
7.1. Conducted Test Setup	79
7.2. Test Setup - Digital Emissions below 1 GHz.....	80
7.3. Radiated Emissions Test Setup >1 GHz.....	81
8. TEST EQUIPMENT DETAILS	82

This test report may be reproduced in full only. The document may only be updated by MiCOM Labs personnel. Any changes will be noted in the Document History section of the report.



Title: Xirrus Inc. XI-AC1300, XI-AC867 (non-DFS Bands)
To: FCC 47 CFR Part 15.407 & IC RSS-210
Serial #: XIRR04-U6 Rev A
Issue Date: 29th April 2014
Page: 5 of 199

APPENDIX	83
A. SUPPORTING INFORMATION.....	83
A.1. 3x3 CONDUCTED TEST PLOTS.....	83
A.1.1. 26 dB & 99% Bandwidth	84
A.1.2. Peak Power Spectral Density	111
A.1.3. Peak Excursion Ratio.....	147
A.2. 2x2 CONDUCTED TEST PLOTS.....	150
A.2.1. 26 dB & 99% Bandwidth	151
A.2.2. Peak Power Spectral Density	169
A.2.3. Peak Excursion Ratio.....	196

This test report may be reproduced in full only. The document may only be updated by MiCOM Labs personnel. Any changes will be noted in the Document History section of the report.



Title: Xirrus Inc. XI-AC1300, XI-AC867 (non-DFS Bands)
To: FCC 47 CFR Part 15.407 & IC RSS-210
Serial #: XIRR04-U6 Rev A
Issue Date: 29th April 2014
Page: 6 of 199

ACCREDITATION, LISTINGS & RECOGNITION

TESTING ACCREDITATION

MiCOM Labs, Inc. is an accredited Electrical testing laboratory per the international standard EN ISO/IEC 17025. The company is accredited by the American Association for Laboratory Accreditation (A2LA) www.a2la.org test laboratory number 2381.01. MiCOM Labs test schedule is available at the following URL; <http://www.a2la.org/scopepdf/2381-01.pdf>



This test report may be reproduced in full only. The document may only be updated by MiCOM Labs personnel. Any changes will be noted in the Document History section of the report.



RECOGNITION

MiCOM Labs, Inc has widely recognized Electrical testing capabilities. Our international recognition includes Conformity Assessment Body designation by APEC MRA** countries. Our test reports are widely accepted for global type approvals.

Country	Recognition Body	Status	Phase	Identification No.
USA	Federal Communications Commission (FCC)	TCB	-	US0159 Listing #: 102167
Canada	Industry Canada (IC)	FCB	APEC MRA 2	US0159 Listing #: 4143A-2
Japan	MIC (Ministry of Internal Affairs and Communication)	CAB	APEC MRA 2	RCB 210
	VCCI	--	--	A-0012
Europe	European Commission	NB	EU MRA	NB 2280
Australia	Australian Communications and Media Authority (ACMA)	CAB	APEC MRA 1	US0159
Hong Kong	Office of the Telecommunication Authority (OFTA)	CAB	APEC MRA 1	
Korea	Ministry of Information and Communication Radio Research Laboratory (RRL)	CAB	APEC MRA 1	
Singapore	Infocomm Development Authority (IDA)	CAB	APEC MRA 1	
Taiwan	National Communications Commission (NCC) Bureau of Standards, Metrology and Inspection (BSMI)	CAB	APEC MRA 1	
Vietnam	Ministry of Communication (MIC)	CAB	APEC MRA 1	

**APEC MRA – Asia Pacific Economic Community Mutual Recognition Agreement.

Is a recognition agreement under which test lab is accredited to regulatory standards of the APEC member countries.

Phase I - recognition for product testing

Phase II – recognition for both product testing and certification

N/A – Not Applicable

**EU MRA – European Union Mutual Recognition Agreement.

Is a recognition agreement under which test lab is accredited to regulatory standards of the EU member countries.

**NB – Notified Body

This test report may be reproduced in full only. The document may only be updated by MiCOM Labs personnel. Any changes will be noted in the Document History section of the report.



Title: Xirrus Inc. XI-AC1300, XI-AC867 (non-DFS Bands)
To: FCC 47 CFR Part 15.407 & IC RSS-210
Serial #: XIRR04-U6 Rev A
Issue Date: 29th April 2014
Page: 8 of 199

PRODUCT CERTIFICATION

MiCOM Labs, Inc. is an accredited Product Certification Body per the international standard EN ISO/IEC 17065. The company is accredited by the American Association for Laboratory Accreditation (A2LA) www.a2la.org test laboratory number 2381.02. MiCOM Labs test schedule is available at the following URL; <http://www.a2la.org/scopepdf/2381-02.pdf>



American Association for Laboratory Accreditation

Accredited Product Certification Body

A2LA has accredited

MICOM LABS

Pleasanton, CA

for technical competence as a

Product Certification Body

This product certification body is accredited in accordance with the recognized International Standard ISO/IEC 17065:2012 - Requirements for bodies certifying products, processes and services. This accreditation demonstrates technical competence for a defined scope and the operation of a quality management system.

Presented this 28th day of February 2014.



Peter Abney

President & CEO
For the Accreditation Council
Certificate Number 2381.02
Valid to November 30, 2015

For the product certification schemes to which this accreditation applies, please refer to the organization's Product Certification Scope of Accreditation

United States of America – Telecommunication Certification Body (TCB)

TCB Identifier – US0159

Industry Canada – Certification Body

CAB Identifier – US0159

Europe – Notified Body

Notified Body Identifier - 2280

Japan – Recognized Certification Body (RCB)

RCB Identifier - 210

This test report may be reproduced in full only. The document may only be updated by MiCOM Labs personnel. Any changes will be noted in the Document History section of the report.



Title: Xirrus Inc. XI-AC1300, XI-AC867 (non-DFS Bands)
To: FCC 47 CFR Part 15.407 & IC RSS-210
Serial #: XIRR04-U6 Rev A
Issue Date: 29th April 2014
Page: 9 of 199

DOCUMENT HISTORY

Document History		
Revision	Date	Comments
Draft		
Rev A	29 th April 2014	Initial release

This test report may be reproduced in full only. The document may only be updated by MiCOM Labs personnel. Any changes will be noted in the Document History section of the report.



Title: Xirrus Inc. XI-AC1300, XI-AC867 (non-DFS Bands)
To: FCC 47 CFR Part 15.407 & IC RSS-210
Serial #: XIRR04-U6 Rev A
Issue Date: 29th April 2014
Page: 10 of 199

1. TEST RESULT CERTIFICATE

Applicant:	Xirrus Inc. 2101 Corporate Center Drive Thousand Oaks California 91320, USA	Tested By:	MiCOM Labs, Inc. 575 Boulder Court Pleasanton California, 94566, USA
EUT:	802.11a/b/g/n Product Description	Tel:	+1 925 462 0304
Model:	XI-AC1300, XI-AC867	Fax:	+1 925 462 0306
S/N:	145		
Test Date(s):	24th Oct '13 - 24th April 2014	Website:	www.micomlabs.com

STANDARD(S)	TEST RESULTS
FCC 47 CFR Part 15.407 & IC RSS-210 (Limited to non-DFS Bands)	EQUIPMENT COMPLIES

MiCOM Labs, Inc. tested the equipment mentioned in accordance with the requirements set forth in the above standards. Test results indicate that the equipment tested is capable of demonstrating compliance with the requirements as documented within this report.

Notes:

1. This document reports conditions under which testing was conducted and the results of testing performed.
2. Details of test methods used have been recorded and kept on file by the laboratory.
3. Test results apply only to the item(s) tested.

Approved & Released for MiCOM Labs, Inc. by:



Graeme Grieve
Quality Manager MiCOM Labs,



Gordon Hurst
President & CEO MiCOM Labs, Inc.



This test report may be reproduced in full only. The document may only be updated by MiCOM Labs personnel. Any changes will be noted in the Document History section of the report.



Title: Xirrus Inc. XI-AC1300, XI-AC867 (non-DFS Bands)
To: FCC 47 CFR Part 15.407 & IC RSS-210
Serial #: XIRR04-U6 Rev A
Issue Date: 29th April 2014
Page: 11 of 199

2. REFERENCES AND MEASUREMENT UNCERTAINTY

2.1. Normative References

Ref.	Publication	Year	Title
(i)	FCC 47 CFR Part 15.407	2012	Code of Federal Regulations
(ii)	FCC 06-96	June 2006	Memorandum Opinion and Order
(iii)	FCC OET KDB 662911	4 th April 2011	Emissions Testing of Transmitters with Multiple Outputs in the Same Band
(iv)	Industry Canada RSS-210	2010	Low Power License-Exempt Radiocommunication Devices (All Frequency Bands): Category 1 Equipment
(v)	Industry Canada RSS-Gen	2010	General Requirements and Information for the Certification of Radiocommunication Equipment
(vi)	ANSI C63.4	2009	American National Standards for Methods of Measurement of Radio-Noise Emissions from Low-Voltage Electrical and Electronic Equipment in the Range of 9 kHz to 40 GHz
(vii)	CISPR 22/ EN 55022	2008 2006+A1:2007	Limits and Methods of Measurements of Radio Disturbance Characteristics of Information Technology Equipment
(viii)	M 3003	Edition 1 Dec. 1997	Expression of Uncertainty and Confidence in Measurements
(ix)	LAB34	Edition 1 Aug 2002	The expression of uncertainty in EMC Testing
(x)	ETSI TR 100 028	2001	Parts 1 and 2 Electromagnetic compatibility and Radio Spectrum Matters (ERM); Uncertainties in the measurement of mobile radio equipment characteristics
(xi)	A2LA	July 2012	Reference to A2LA Accreditation Status – A2LA Advertising Policy
(xii)	FCC Public Notice – DA 02-2138	2002	Guidelines for Assessing Unlicensed National Information Infrastructure (U-NII) Devices

This test report may be reproduced in full only. The document may only be updated by MiCOM Labs personnel. Any changes will be noted in the Document History section of the report.



Title: Xirrus Inc. XI-AC1300, XI-AC867 (non-DFS Bands)
To: FCC 47 CFR Part 15.407 & IC RSS-210
Serial #: XIRR04-U6 Rev A
Issue Date: 29th April 2014
Page: 12 of 199

2.2. Test and Uncertainty Procedures

Conducted and radiated emission measurements were conducted in accordance with American National Standards Institute ANSI C63.4, listed in the Normative References section of this report.

Measurement uncertainty figures are calculated in accordance with ETSI TR 100 028 Parts 1 and 2.

Measurement uncertainties stated are based on a standard uncertainty multiplied by a coverage factor $k = 2$, providing a level of confidence of approximately 95 % in accordance with UKAS document M 3003 listed in the Normative References section of this report.

This test report may be reproduced in full only. The document may only be updated by MiCOM Labs personnel. Any changes will be noted in the Document History section of the report.



Title: Xirrus Inc. XI-AC1300, XI-AC867 (non-DFS Bands)
To: FCC 47 CFR Part 15.407 & IC RSS-210
Serial #: XIRR04-U6 Rev A
Issue Date: 29th April 2014
Page: 13 of 199

3. PRODUCT DETAILS AND TEST CONFIGURATIONS

3.1. Technical Details

Details	Description
Purpose:	Test of the Xirrus Inc. XI-AC1300, XI-AC867 (non-DFS Bands) in the frequency range 5,150 to 5,250 MHz to FCC Part 15.407 and Industry Canada RSS-210 regulations.
Applicant:	Xirrus Inc. 2101 Corporate Center Drive Thousand Oaks, California 91320, USA
Manufacturer:	As applicant
Laboratory performing the tests:	MiCOM Labs, Inc. 575 Boulder Court Pleasanton, California 94566 USA
Test report reference number:	XIRR04-U6 Rev A
Date EUT received:	24 th October 2014
Standard(s) applied:	FCC 47 CFR Part 15.407 & IC RSS-210
Dates of test (from - to):	24th Oct '13 - 24th April 2014
No of Units Tested:	Two
Type of Equipment:	Wireless LAN Access Point, 3x3 Spatial Multiplexing MIMO configuration
Applicants Trade Name:	Wireless Access Point
Model(s):	XI-AC1300
Location for use:	Indoor / Outdoor use
Declared Frequency Range(s):	5,150 – 5,250 MHz
Hardware Rev	Rev 2
Software Rev	6.7
Type of Modulation:	Per 802.11 – OFDM
Declared Nominal Output Power: (Average Power)	802.11a: +17 dBm 802.11n: +17 dBm 802.11ac: +17 dBm
EUT Modes of Operation:	Legacy 802.11a/n/ac
Transmit/Receive Operation:	Time Division Duplex
System Beam Forming:	XI-AC1300 has no capability for beam forming
Rated Input Voltage and Current:	POE 56 Vdc
Operating Temperature Range:	Declared range 0° to +55°C
ITU Emission Designator:	5150 – 5250 MHz 802.11a 16M9D1D 5150 – 5250 MHz 802.11n – HT-20 17M9D1D 5150 – 5250 MHz 802.11n – HT-40 36M4D1D 5150 – 5250 MHz 802.11n ac-20 36M4D1D 5150 – 5250 MHz 802.ac-80 76M3D1D
Equipment Dimensions:	114 mm (L) x 75 mm (W) x 55 mm (H)
Weight:	42 grams
Primary function of equipment:	Wireless Access Point for transmitting data and voice.

This test report may be reproduced in full only. The document may only be updated by MiCOM Labs personnel. Any changes will be noted in the Document History section of the report.



Title: Xirrus Inc. XI-AC1300, XI-AC867 (non-DFS Bands)
To: FCC 47 CFR Part 15.407 & IC RSS-210
Serial #: XIRR04-U6 Rev A
Issue Date: 29th April 2014
Page: 14 of 199

3.2. Scope of Test Program

Xirrus Inc. RF Module

The scope of the test program was to test the Xirrus Inc. Wireless LAN module, 3x3, and 2x2 Spatial Multiplexing MIMO configurations in the frequency range 5,150 to 5,250 MHz for compliance against FCC 47 CFR Part 15.407 and Industry Canada RSS-210 specifications.

The client requested that both the XI-AC1300 and XI-AC867 be treated as an SDR (Software Defined Radio)

2x2 Module: XI-AC867
3x3 Module: XI-AC1300

Module Differences

Client stated that the module differences between the 3x3 and 2x2 is that the 2x2 has the third antenna trace terminated with no access. As a result the test strategy determined full testing performed on the 3x3 module and limited testing on the 2x2. The output power on the 2x2 module was limited to approximately the same power that was observed on Ports a and b on the 3x3 module. This implies the maximum EIRP is less for the 2x2.

Multiple Antenna Configuration

The XI-1300 can have multiple wireless modules incorporated into a single host device. The client declared that at any given time only a single transmitter can be active at any given time. The device does operate 2.4 GHz and 5 GHz frequency bands simultaneously therefore colocation testing is considered.

FCC OET KDB Implementation

This test program implements the following FCC KDB – 662911 4/4/2011;
Emissions Testing of Transmitters with Multiple Outputs in the Same Band

The KDB document provides guidance for measurements of conducted output emissions of devices that employ a single transmitter with multiple outputs in the same band, with the outputs occupying the same or overlapping frequency ranges. It applies to EMC compliance measurements on devices that transmit on multiple antennas simultaneously in the same or overlapping frequency ranges through a coordinated process. Examples include, but are not limited to, devices employing beam forming or multiple-input and multiple-output (MIMO.) This guidance applies to both licensed and unlicensed devices wherever the FCC rules call for conducted output measurements. Guidance is provided for in-band, out-of-band and spurious emission measurements.

This guidance does not apply to the multiple transmitters included in a composite device, such as a device that combines an 802.11 modem with a cell phone in one enclosure with each driving its own antenna.

This test report may be reproduced in full only. The document may only be updated by MiCOM Labs personnel. Any changes will be noted in the Document History section of the report.



Title: Xirrus Inc. XI-AC1300, XI-AC867 (non-DFS Bands)
To: FCC 47 CFR Part 15.407 & IC RSS-210
Serial #: XIRR04-U6 Rev A
Issue Date: 29th April 2014
Page: 15 of 199

This test report may be reproduced in full only. The document may only be updated by MiCOM Labs personnel. Any changes will be noted in the Document History section of the report.

XIRR04 Wireless LAN Module

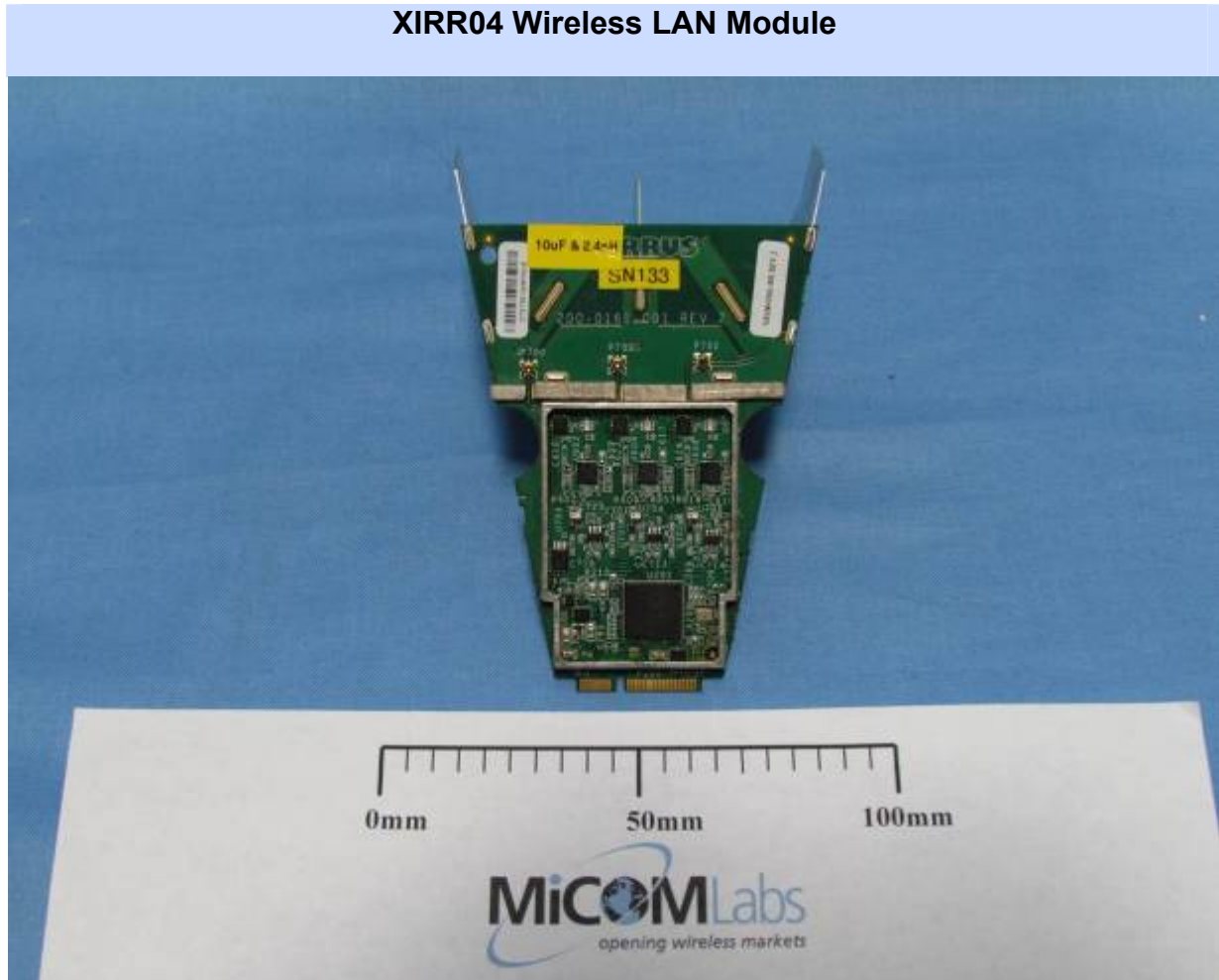

This test report may be reproduced in full only. The document may only be updated by MiCOM Labs personnel. Any changes will be noted in the Document History section of the report.

XIRR04 Wireless LAN Module

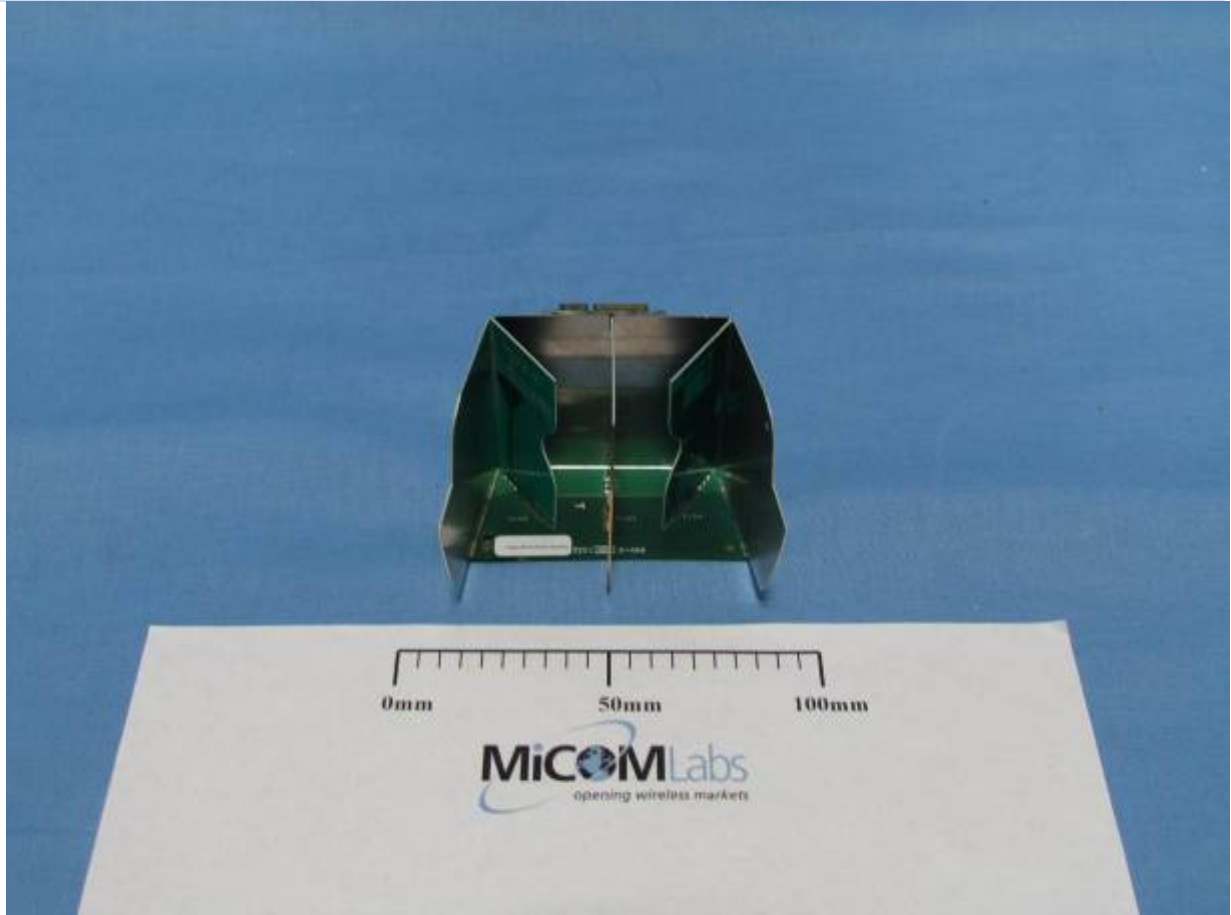

This test report may be reproduced in full only. The document may only be updated by MiCOM Labs personnel. Any changes will be noted in the Document History section of the report.

XIRR04 Wireless LAN Module

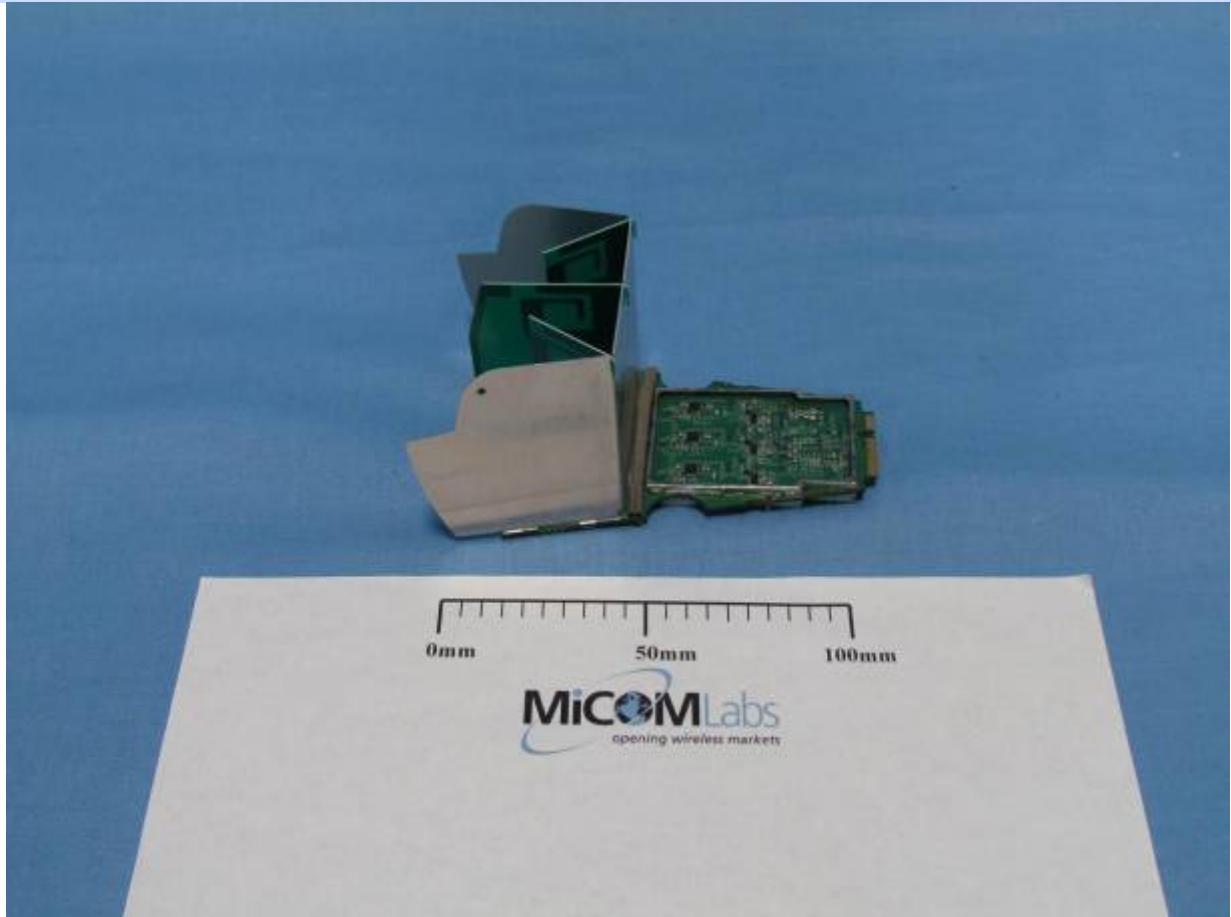

This test report may be reproduced in full only. The document may only be updated by MiCOM Labs personnel. Any changes will be noted in the Document History section of the report.



Title: Xirrus Inc. XI-AC1300, XI-AC867 (non-DFS Bands)
To: FCC 47 CFR Part 15.407 & IC RSS-210
Serial #: XIRR04-U6 Rev A
Issue Date: 29th April 2014
Page: 20 of 199

3.3. Equipment Model(s) and Serial Number(s)

Equipment Type	Equipment Description (Including Brand Name)	Mfr	Model No.	Serial No.
EUT	3x3 802.11a/b/g/n/ac WLAN	Xirrus	XI-AC1300	145
EUT	2x2 802.11a/b/g/n/ac WLAN	Xirrus	XI-AC867	145
Support	Single Port Injector (POE) Input: 100-240 Vac ~ 2.0A Output: 1). 56Vdc, 0.67A Output: 2). 56Vdc, 0.67A	Xirrus	XP1-MSI-75	None
Support	Laptop PC	IBM	Thinkpad	None

Note: Serial number is from the host device which was used to test both modules

3.4. Antenna Details

Model	Type	Gain (dBi)	Freq. Band (MHz)	Note
Integral	Omni Directional	3.0	2400 - 2500	
Integral	Omni Directional	5.0	5150 - 5850	

3.5. Cabling and I/O Ports

Number and type of I/O ports

Port Type	Port Description	Qty	Screened (Yes/ No)	Length
U.FI	RF port	3*	NO	Not Applicable

* 2 U.FI RF ports on the 2x2 XI-AC867

This test report may be reproduced in full only. The document may only be updated by MiCOM Labs personnel. Any changes will be noted in the Document History section of the report.



3.6. Test Configurations

Testing was performed to determine the highest power level versus bit rate. The variant with the highest power was used to exercise the product.

Matrix of test configurations

Operational Mode(s) (802.11)	Variant	Data Rates with Highest Power	Frequencies (MHz)
a,n	Legacy	6 MBit/s	5180/5,200/5,240
	HT-20	6.5 MBit/s (MCS 0)	
	HT-40	13.5 MBit/s (MCS 0)	5,190, 5,230
ac	ac-80	29.3 MBit/s (MCS 0)	5,210

Antenna Test Configurations for Radiated Emissions and Band-Edge

The following measurements were performed on all antenna configurations identified in Section 3.4 Antenna Details.

Spurious Emission and Band-Edge Test Strategy Bands 5,150 – 5250

11a	11n HT-20	11n HT-40	11ac-80
BE 5180	BE 5180	BE 5190	BE 5210
SE 5180			
SE 5200			
SE 5240			

KEY:-

SE – Spurious Emissions

BE – Band-Edge



Title: Xirrus Inc. XI-AC1300, XI-AC867 (non-DFS Bands)
To: FCC 47 CFR Part 15.407 & IC RSS-210
Serial #: XIRR04-U6 Rev A
Issue Date: 29th April 2014
Page: 22 of 199

3.7. Equipment Modifications

The following modifications were required to bring the equipment into compliance:

1. NONE

3.8. Deviations from the Test Standard

The following deviations from the test standard were required in order to complete the test program:

2. NONE

3.9. Subcontracted Testing or Third Party Data

1. NONE

This test report may be reproduced in full only. The document may only be updated by MiCOM Labs personnel. Any changes will be noted in the Document History section of the report.

4. TESTING EQUIPMENT CONFIGURATION(S)

4.1. Conducted RF Emission Test Set-up

The following tests were performed using the conducted test set-up shown in the diagram below.

1. Section 6.1.1.1. 26 dB and 99% Bandwidth
2. Section 6.1.1.2. Maximum Conducted Output Power
3. Section 6.1.1.3. Peak Power Spectral Density
4. Section 6.1.1.4. Peak Excursion Ratio

Conducted Test Set-Up Pictorial Representation

3 - Port Test Configuration

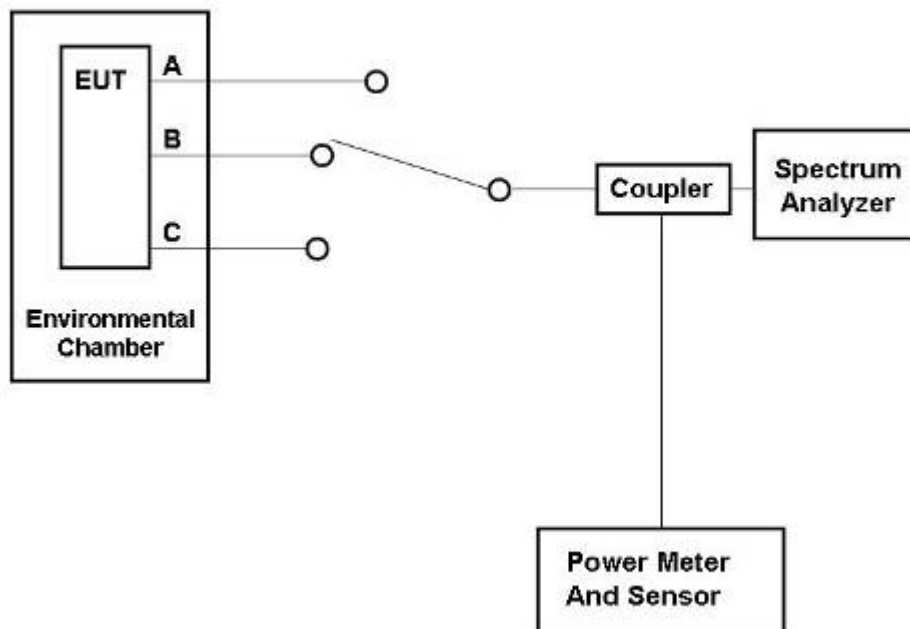

This test report may be reproduced in full only. The document may only be updated by MiCOM Labs personnel. Any changes will be noted in the Document History section of the report.

4.2. Radiated Spurious Emission Test Set-up > 1 GHz

The following tests were performed using the conducted test set-up shown in the diagram below.

1. Section 6.1.2.1. Integral Antenna

Radiated Emission Measurement Setup – Above 1 GHz

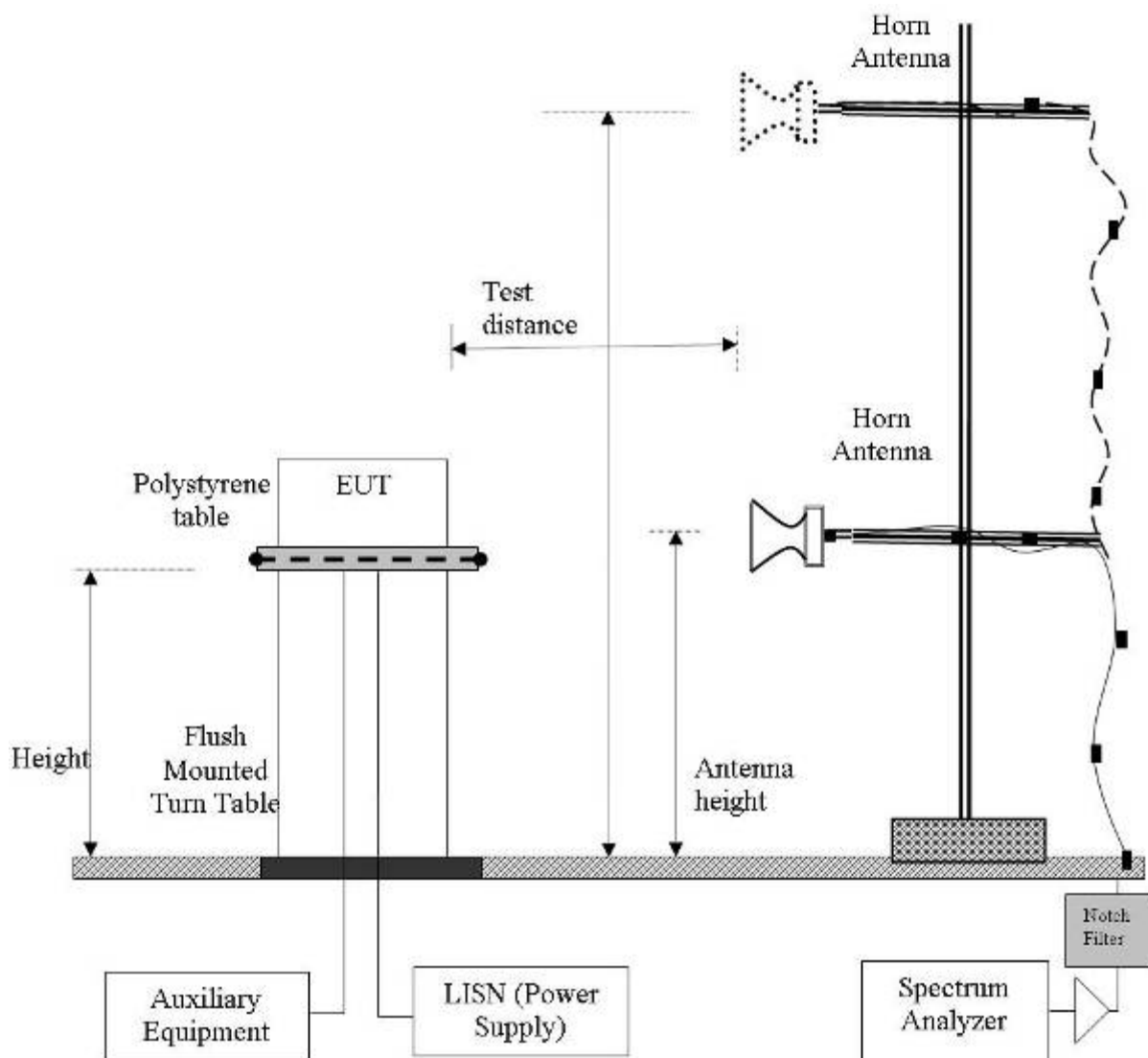

This test report may be reproduced in full only. The document may only be updated by MiCOM Labs personnel. Any changes will be noted in the Document History section of the report.

4.3. Digital Emissions Test Set-up (0.03 – 1 GHz)

The following tests were performed using the conducted test set-up shown in the diagram below.

1. Section 6.1.2.4. Digital Emissions

Digital Emission Measurement Setup – Below 1 GHz

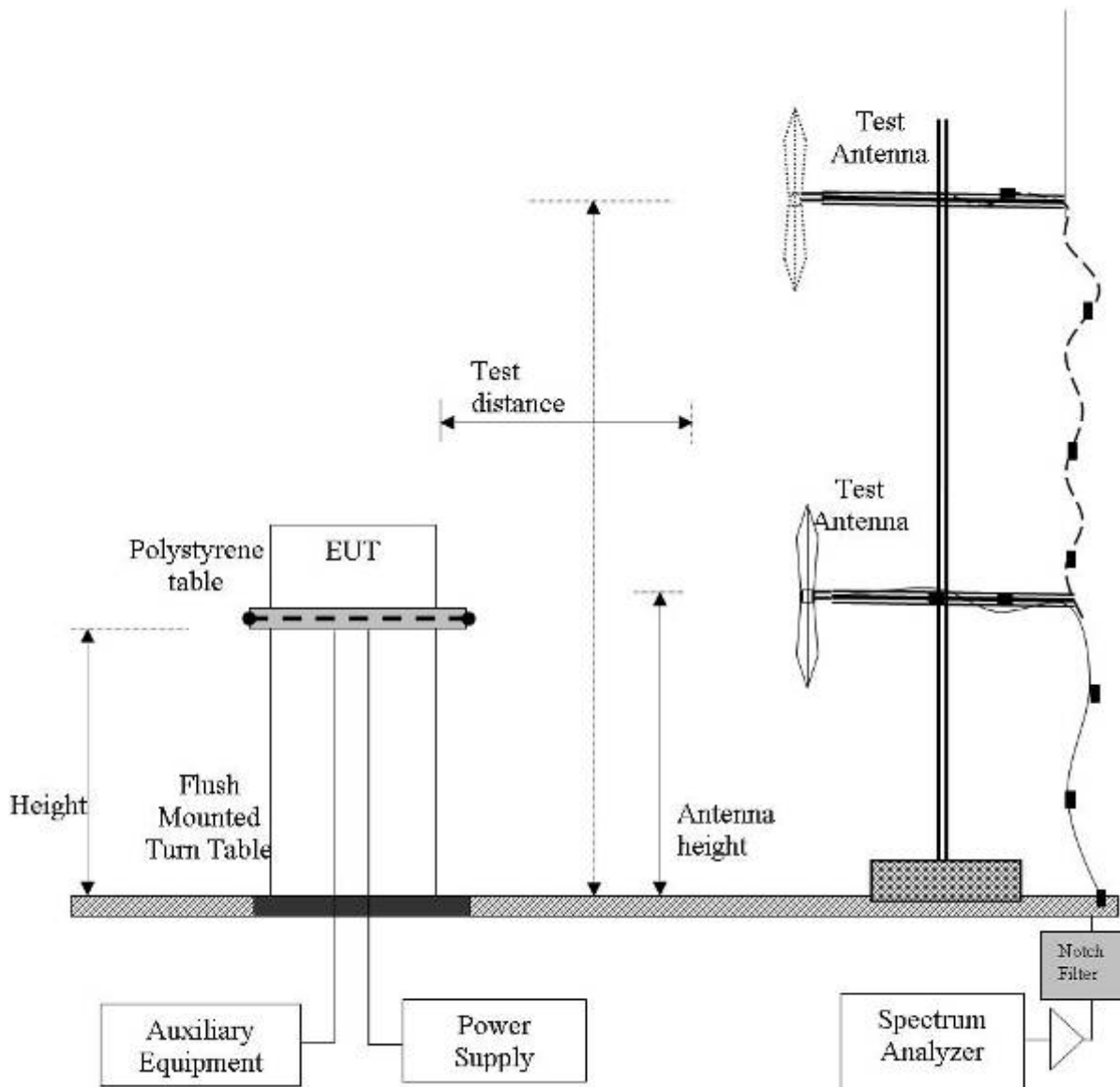

This test report may be reproduced in full only. The document may only be updated by MiCOM Labs personnel. Any changes will be noted in the Document History section of the report.

4.4. ac Wireline Emission Test Set-up

The following tests were performed using the conducted test set-up shown in the diagram below.

1. Section 6.1.3 ac Wireline Conducted Emissions

Conducted Test Set-Up Pictorial Representation

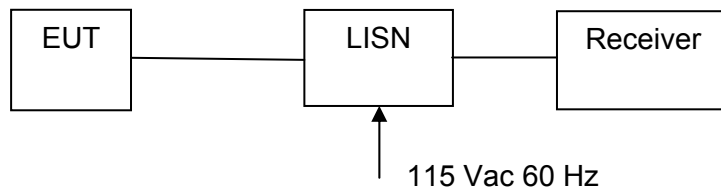

Measurement set up for ac Wireline Conducted Emissions Test



5. TEST SUMMARY

List of Measurements

The following table represents the list of measurements required under the **FCC CFR47 Part 15.407** and **Industry Canada RSS-210** and **Industry Canada RSS-Gen**.

Section(s)	Test Items	Description	Condition	Result	Test Report Section
15.407(a) A9.2(2) 4.4	26dB and 99% Emission BW	Emission bandwidth measurement	Conducted	Complies	6.1.1.1 A.1.1
15.407(a) A9.2(2) 4.6	Maximum Conducted Output Power	Power Measurement	Conducted	Complies	6.1.1.2
15.407(a) A9.2(2)	Peak Power Spectral Density	PPSD	Conducted	Complies	6.1.1.3 A.1.2
15.407(a)(6)	Peak Excursion Ratio	<13dB in any 1MHz bandwidth	Conducted	Complies	6.1.1.4 A.1.3
15.407(g) 15.31 2.1 4.5	Frequency Stability	Limits: contained within band of operation at all times.	Applicant declaration	Complies	6.1.1.5
15.407(f) 5.5	Radio Frequency Radiation Exposure	Exposure to radio frequency energy levels, Maximum Permissible Exposure (MPE)	Conducted	See included MPE exhibit	--

This test report may be reproduced in full only. The document may only be updated by MiCOM Labs personnel. Any changes will be noted in the Document History section of the report.



List of Measurements (continued)

The following table represents the list of measurements required under the **FCC CFR47 Part 15.407** and **Industry Canada RSS-210** and **Industry Canada RSS-Gen**.

Section(s)	Test Items	Description	Condition	Result	Test Report Section
15.407(b)(2) 15.205(a) 15.209(a) 2.2 2.6 A9.3(2) 4.7	Radiated Emissions		Radiated		6.1.2
	Transmitter Radiated Spurious Emissions	Emissions above 1 GHz		Complies	6.1.2.1 6.1.2.2 6.1.2.3
	Radiated Band Edge	Band edge results		Complies	6.1.2.1 6.1.2.2 6.1.2.3
15.407(b)(6) 15.205(a) 15.209(a) 2.2	Radiated Emissions	Emissions <1 GHz (30M-1 GHz)		Complies	6.1.2.4
15.407(b)(6) 15.207 7.2.2	AC Wireline Conducted Emissions 150 kHz–30 MHz	Conducted Emissions	Conducted	N/A EUT is module and dc powered	6.1.3

Note 1: Test results reported in this document relate only to the items tested

Note 2: The required tests demonstrated compliance as per client declaration of test configuration, monitoring methodology and associated pass/fail criteria

Note 3: Section 3.7 Equipment Modifications highlights the equipment modifications that were required to bring the product into compliance with the above test matrix



Title: Xirrus Inc. XI-AC1300, XI-AC867 (non-DFS Bands)
To: FCC 47 CFR Part 15.407 & IC RSS-210
Serial #: XIRR04-U6 Rev A
Issue Date: 29th April 2014
Page: 29 of 199

6. TEST RESULTS

6.1. Device Characteristics

6.1.1. Conducted Testing

6.1.1.1. 26 dB and 99 % Bandwidth

Conducted Test Conditions for 26 dB and 99% Bandwidth			
Standard:	FCC CFR 47:15.407	Ambient Temp. (°C):	24.0 - 27.5
Test Heading:	26 dB and 99 % Bandwidth	Rel. Humidity (%):	32 - 45
Standard Section(s):	15.407 (a)	Pressure (mBars):	999 - 1001
Reference Document(s):	KDB 789033 - D01 DTS General UNII Test Procedures v01		

Test Procedure for 26 dB and 99% Bandwidth Measurement

The bandwidth at 26 dB and 99 % is measured with a spectrum analyzer connected to the antenna terminal, while EUT is operating in transmission mode at the appropriate center frequency. KDB 789033 Section 5.1 Emission Bandwidth was used in order to prove compliance. The Resolution Bandwidth was set to approximately 1% of the emission bandwidth.

This test report may be reproduced in full only. The document may only be updated by MiCOM Labs personnel. Any changes will be noted in the Document History section of the report.



Title: Xirrus Inc. XI-AC1300, XI-AC867 (non-DFS Bands)
To: FCC 47 CFR Part 15.407 & IC RSS-210
Serial #: XIRR04-U6 Rev A
Issue Date: 29th April 2014
Page: 30 of 199

XI-AC1300 3x3 Operation

Equipment Configuration for 26 dB & 99% Occupied Bandwidth

Variant:	802.11a	Duty Cycle (%):	98
Data Rate:	6 MBit/s	Antenna Gain (dBi):	Not Applicable
Modulation:	OFDM	Beam Forming Gain (Y):	Not Applicable
TPC:	Not Applicable	Tested By:	CC
Engineering Test Notes:			

Test Measurement Results

Test Frequency	Measured 26 dB Bandwidth (MHz)				26 dB Bandwidth (MHz)			
	Port(s)				Highest	Lowest		
MHz	a	b	c	d				
5180.0	24.148	25.150	24.248	--	25.150	24.148		
5200.0	23.848	25.251	24.349	--	25.251	23.848		
5240.0	24.850	25.251	24.649	--	25.251	24.649		

Test Frequency	Measured 99% Bandwidth (MHz)				99% Bandwidth (MHz)			
	Port(s)				Highest	Lowest		
MHz	a	b	c	d				
5180.0	16.934	17.034	16.834	--	17.034	16.834		
5200.0	16.934	17.134	16.834	--	17.134	16.834		
5240.0	16.934	16.934	17.134	--	17.134	16.934		

Traceability to Industry Recognized Test Methodologies	
Work Instruction:	WI-03 MEASURING RF SPECTRUM MASK
Measurement Uncertainty:	±2.81 dB

Note: click the links in the above matrix to view the graphical image (plot).

This test report may be reproduced in full only. The document may only be updated by MiCOM Labs personnel. Any changes will be noted in the Document History section of the report.



Title: Xirrus Inc. XI-AC1300, XI-AC867 (non-DFS Bands)
To: FCC 47 CFR Part 15.407 & IC RSS-210
Serial #: XIRR04-U6 Rev A
Issue Date: 29th April 2014
Page: 31 of 199

Equipment Configuration for 26 dB & 99% Occupied Bandwidth

Variant:	802.11n HT-20	Duty Cycle (%):	98
Data Rate:	6.5 MBit/s	Antenna Gain (dBi):	Not Applicable
Modulation:	OFDM	Beam Forming Gain (Y):	Not Applicable
TPC:	Not Applicable	Tested By:	CC
Engineering Test Notes:			

Test Measurement Results

Test Frequency	Measured 26 dB Bandwidth (MHz)				26 dB Bandwidth (MHz)			
	Port(s)				Highest	Lowest		
MHz	a	b	c	d				
5180.0	25.251	25.651	25.551	--	25.651	25.251		
5200.0	25.251	25.351	25.050	--	25.351	25.050		
5240.0	25.551	25.551	25.651	--	25.651	25.551		

Test Frequency	Measured 99% Bandwidth (MHz)				99% Bandwidth (MHz)			
	Port(s)				Highest	Lowest		
MHz	a	b	c	d				
5180.0	17.836	18.036	18.236	--	18.236	17.836		
5200.0	17.936	18.136	17.936	--	18.136	17.936		
5240.0	17.936	18.036	18.136	--	18.136	17.936		

Traceability to Industry Recognized Test Methodologies

Work Instruction:	WI-03 MEASURING RF SPECTRUM MASK
Measurement Uncertainty:	±2.81 dB

Note: click the links in the above matrix to view the graphical image (plot).

This test report may be reproduced in full only. The document may only be updated by MiCOM Labs personnel. Any changes will be noted in the Document History section of the report.



Title: Xirrus Inc. XI-AC1300, XI-AC867 (non-DFS Bands)
To: FCC 47 CFR Part 15.407 & IC RSS-210
Serial #: XIRR04-U6 Rev A
Issue Date: 29th April 2014
Page: 32 of 199

Equipment Configuration for 26 dB & 99% Occupied Bandwidth

Variant:	802.11n HT-40	Duty Cycle (%):	99
Data Rate:	13.5 MBit/s	Antenna Gain (dBi):	Not Applicable
Modulation:	OFDM	Beam Forming Gain (Y):	Not Applicable
TPC:	Not Applicable	Tested By:	CC
Engineering Test Notes:			

Test Measurement Results

Test Frequency	Measured 26 dB Bandwidth (MHz)				26 dB Bandwidth (MHz)			
	Port(s)				Highest	Lowest		
MHz	a	b	c	d				
5190.0	43.487	42.485	44.289	--	44.289	42.485		
5230.0	45.090	44.088	41.683	--	45.090	41.683		

Test Frequency	Measured 99% Bandwidth (MHz)				99% Bandwidth (MHz)			
	Port(s)				Highest	Lowest		
MHz	a	b	c	d				
5190.0	36.273	36.072	36.473	--	36.473	36.072		
5230.0	36.473	36.473	36.273	--	36.473	36.273		

Traceability to Industry Recognized Test Methodologies

Work Instruction:	WI-03 MEASURING RF SPECTRUM MASK
Measurement Uncertainty:	±2.81 dB

Note: click the links in the above matrix to view the graphical image (plot).

This test report may be reproduced in full only. The document may only be updated by MiCOM Labs personnel. Any changes will be noted in the Document History section of the report.



Title: Xirrus Inc. XI-AC1300, XI-AC867 (non-DFS Bands)
To: FCC 47 CFR Part 15.407 & IC RSS-210
Serial #: XIRR04-U6 Rev A
Issue Date: 29th April 2014
Page: 33 of 199

Equipment Configuration for 26 dB & 99% Occupied Bandwidth

Variant:	802.11ac-80	Duty Cycle (%):	99
Data Rate:	29.3 MBit/s	Antenna Gain (dBi):	Not Applicable
Modulation:	OFDM	Beam Forming Gain (Y):	Not Applicable
TPC:	Not Applicable	Tested By:	CC
Engineering Test Notes:			

Test Measurement Results

Test Frequency	Measured 26 dB Bandwidth (MHz)				26 dB Bandwidth (MHz)			
	Port(s)				Highest	Lowest		
MHz	a	b	c	d				
5210.0	86.974	88.577	84.168	--	88.577	84.168		

Test Frequency	Measured 99% Bandwidth (MHz)				99% Bandwidth (MHz)			
	Port(s)				Highest	Lowest		
MHz	a	b	c	d				
5210.0	75.752	75.752	76.553	--	76.553	75.752		

Traceability to Industry Recognized Test Methodologies	
Work Instruction:	WI-03 MEASURING RF SPECTRUM MASK
Measurement Uncertainty:	±2.81 dB

Note: click the links in the above matrix to view the graphical image (plot).

This test report may be reproduced in full only. The document may only be updated by MiCOM Labs personnel. Any changes will be noted in the Document History section of the report.



Title: Xirrus Inc. XI-AC1300, XI-AC867 (non-DFS Bands)
To: FCC 47 CFR Part 15.407 & IC RSS-210
Serial #: XIRR04-U6 Rev A
Issue Date: 29th April 2014
Page: 34 of 199

XI-AC867 2x2 Operation

Equipment Configuration for 26 dB & 99% Occupied Bandwidth

Variant:	802.11a	Duty Cycle (%):	98
Data Rate:	6 mbits	Antenna Gain (dBi):	Not Applicable
Modulation:	OFDM	Beam Forming Gain (Y):	Not Applicable
TPC:	Not Applicable	Tested By:	AH
Engineering Test Notes:			

Test Measurement Results

Test Frequency	Measured 26 dB Bandwidth (MHz)				26 dB Bandwidth (MHz)			
	Port(s)				Highest	Lowest		
MHz	a	b	c	d				
5180.0	22.545	22.946	--	--	22.946	22.545		
5200.0	22.745	22.946	--	--	22.946	22.745		
5240.0	24.148	22.244	--	--	24.148	22.244		

Test Frequency	Measured 99% Bandwidth (MHz)				99% Bandwidth (MHz)			
	Port(s)				Highest	Lowest		
MHz	a	b	c	d				
5180.0	16.733	16.733	--	--	16.733	16.733		
5200.0	16.633	16.633	--	--	16.633	16.633		
5240.0	16.633	16.733	--	--	16.733	16.633		

Traceability to Industry Recognized Test Methodologies	
Work Instruction:	WI-03 MEASURING RF SPECTRUM MASK
Measurement Uncertainty:	±2.81 dB

Note: click the links in the above matrix to view the graphical image (plot).

This test report may be reproduced in full only. The document may only be updated by MiCOM Labs personnel. Any changes will be noted in the Document History section of the report.



Title: Xirrus Inc. XI-AC1300, XI-AC867 (non-DFS Bands)
To: FCC 47 CFR Part 15.407 & IC RSS-210
Serial #: XIRR04-U6 Rev A
Issue Date: 29th April 2014
Page: 35 of 199

Equipment Configuration for 26 dB & 99% Occupied Bandwidth

Variant:	802.11ac-80	Duty Cycle (%):	98
Data Rate:	29.3 mbits	Antenna Gain (dBi):	Not Applicable
Modulation:	OFDM	Beam Forming Gain (Y):	Not Applicable
TPC:	Not Applicable	Tested By:	AH
Engineering Test Notes:			

Test Measurement Results

Test Frequency	Measured 26 dB Bandwidth (MHz)				26 dB Bandwidth (MHz)			
	Port(s)				Highest	Lowest		
MHz	a	b	c	d				
5210.0	87.776	87.375	--	--	87.776	87.375		

Test Frequency	Measured 99% Bandwidth (MHz)				99% Bandwidth (MHz)			
	Port(s)				Highest	Lowest		
MHz	a	b	c	d				
5210.0	75.752	75.752	--	--	75.752	75.752		

Traceability to Industry Recognized Test Methodologies	
Work Instruction:	WI-03 MEASURING RF SPECTRUM MASK
Measurement Uncertainty:	

Note: click the links in the above matrix to view the graphical image (plot).

This test report may be reproduced in full only. The document may only be updated by MiCOM Labs personnel. Any changes will be noted in the Document History section of the report.



Title: Xirrus Inc. XI-AC1300, XI-AC867 (non-DFS Bands)
To: FCC 47 CFR Part 15.407 & IC RSS-210
Serial #: XIRR04-U6 Rev A
Issue Date: 29th April 2014
Page: 36 of 199

Equipment Configuration for 26 dB & 99% Occupied Bandwidth

Variant:	802.11n HT-20	Duty Cycle (%):	98
Data Rate:	6.5 mbits	Antenna Gain (dBi):	Not Applicable
Modulation:	OFDM	Beam Forming Gain (Y):	Not Applicable
TPC:	Not Applicable	Tested By:	AH
Engineering Test Notes:			

Test Measurement Results

Test Frequency	Measured 26 dB Bandwidth (MHz)				26 dB Bandwidth (MHz)			
	Port(s)				Highest	Lowest		
MHz	a	b	c	d				
5180.0	22.846	22.345	--	--	22.846	22.345		
5200.0	22.445	22.545	--	--	22.545	22.445		
5240.0	23.347	23.747	--	--	23.747	23.347		

Test Frequency	Measured 99% Bandwidth (MHz)				99% Bandwidth (MHz)			
	Port(s)				Highest	Lowest		
MHz	a	b	c	d				
5180.0	17.735	17.735	--	--	17.735	17.735		
5200.0	17.735	17.735	--	--	17.735	17.735		
5240.0	17.836	17.936	--	--	17.936	17.836		

Traceability to Industry Recognized Test Methodologies	
Work Instruction:	WI-03 MEASURING RF SPECTRUM MASK
Measurement Uncertainty:	±2.81 dB

Note: click the links in the above matrix to view the graphical image (plot).

This test report may be reproduced in full only. The document may only be updated by MiCOM Labs personnel. Any changes will be noted in the Document History section of the report.



Title: Xirrus Inc. XI-AC1300, XI-AC867 (non-DFS Bands)
To: FCC 47 CFR Part 15.407 & IC RSS-210
Serial #: XIRR04-U6 Rev A
Issue Date: 29th April 2014
Page: 37 of 199

Equipment Configuration for 26 dB & 99% Occupied Bandwidth

Variant:	802.11n HT-40	Duty Cycle (%):	98
Data Rate:	13.5 mbits	Antenna Gain (dBi):	Not Applicable
Modulation:	OFDM	Beam Forming Gain (Y):	Not Applicable
TPC:	Not Applicable	Tested By:	AH
Engineering Test Notes:			

Test Measurement Results

Test Frequency	Measured 26 dB Bandwidth (MHz)				26 dB Bandwidth (MHz)			
	Port(s)				Highest	Lowest		
MHz	a	b	c	d				
5190.0	43.487	45.691	--	--	45.691	43.487		
5230.0	44.088	45.090	--	--	45.090	44.088		

Test Frequency	Measured 99% Bandwidth (MHz)				99% Bandwidth (MHz)			
	Port(s)				Highest	Lowest		
MHz	a	b	c	d				
5190.0	36.473	36.473	--	--	36.473	36.473		
5230.0	36.473	36.473	--	--	36.473	36.473		

Traceability to Industry Recognized Test Methodologies

Work Instruction:	WI-03 MEASURING RF SPECTRUM MASK
Measurement Uncertainty:	±2.81 dB

Note: click the links in the above matrix to view the graphical image (plot).

This test report may be reproduced in full only. The document may only be updated by MiCOM Labs personnel. Any changes will be noted in the Document History section of the report.



Title: Xirrus Inc. XI-AC1300, XI-AC867 (non-DFS Bands)
To: FCC 47 CFR Part 15.407 & IC RSS-210
Serial #: XIRR04-U6 Rev A
Issue Date: 29th April 2014
Page: 38 of 199

Measurement Results for 26 dB and 99 % Operational Bandwidth(s)

Specification

Limits

FCC, Part 15 §15.407 (a)(1), (a)(2) and Industry Canada RSS-210 § A9.2(2)

(a)(1) For the band 5.15-5.25 GHz the maximum conducted output power over the frequency band of operation shall not exceed the lesser of 50 mW or $+4 \text{ dBm} + 10 \log B$, where B is the 26 dB emission bandwidth in megahertz. In addition, the peak power spectral density shall not exceed +4 dBm in any 1 megahertz band.

(a)(2) For the 5.25-5.35 GHz band the maximum conducted output power over the frequency band of operation shall not exceed the lesser of 250 mW or $+11 \text{ dBm} + 10 \log B$, where B is the 26 dB emission bandwidth in megahertz. In addition, the peak power spectral density shall not exceed +11 dBm in any 1 megahertz band.

Industry Canada RSS-Gen 4.4

When an occupied bandwidth value is not specified in the applicable RSS, the transmitted signal bandwidth to be reported is to be its 99% emission bandwidth, as calculated or measured.

Traceability

Test Equipment Used

0158, 0287, 0252, 0313, 0314, 0070, 0116, 0117

This test report may be reproduced in full only. The document may only be updated by MiCOM Labs personnel. Any changes will be noted in the Document History section of the report.



Title: Xirrus Inc. XI-AC1300, XI-AC867 (non-DFS Bands)
To: FCC 47 CFR Part 15.407 & IC RSS-210
Serial #: XIRR04-U6 Rev A
Issue Date: 29th April 2014
Page: 39 of 199

6.1.1.2. Maximum Conducted Output Power

Conducted Test Conditions for Maximum Conducted Output Power			
Standard:	FCC CFR 47:15.407	Ambient Temp. (°C):	24.0 - 27.5
Test Heading:	Maximum Conducted Output Power	Rel. Humidity (%):	32 - 45
Standard Section(s):	15.407 (a)	Pressure (mBars):	999 - 1001
Reference Document(s):	KDB 789033 - D01 DTS General UNII Test Procedures v01		
Test Procedure for Maximum Conducted Output Power Measurement			
<p><u>Method PM (Measurement using an RF average power meter)</u>. Section C) 4) of KDB 789033 defines a methodology using an average wideband power meter. Measurements were made while the EUT was operating in a continuous transmission mode (100% duty cycle) at the appropriate center frequency. All cable losses and offsets were taken into consideration in the measured result. All operational modes and frequency bands were measured independently and the resultant \square calculated. For multiple outputs, the measurements were made simultaneously on each output port and summed in a linear fashion. This technique was used in order to prove compliance.</p>			

This test report may be reproduced in full only. The document may only be updated by MiCOM Labs personnel. Any changes will be noted in the Document History section of the report.



Title: Xirrus Inc. XI-AC1300, XI-AC867 (non-DFS Bands)
To: FCC 47 CFR Part 15.407 & IC RSS-210
Serial #: XIRR04-U6 Rev A
Issue Date: 29th April 2014
Page: 40 of 199

Antenna Beam and Non-Beam Forming Power Levels

15. 407 (a)(1), (a) (2) Operation with directional antenna gains greater than 6 dBi.

If transmitting antennas of directional gain greater than 6 dBi are used, the conducted output power from the intentional radiator shall be reduced by the amount in dB that the directional gain of the antenna exceeds 6 dBi. Further FCC KDB 662911 D01 Multiple Transmitter Output v01 requires that the gain of antennas transmitting the same data (legacy 802.11a mode) must be increased by $10 * \log(N)$ when N is the number of antenna elements.

This test report may be reproduced in full only. The document may only be updated by MiCOM Labs personnel. Any changes will be noted in the Document History section of the report.



Maximum Transmit (Conducted) Power, FCC Limits and Industry Canada Limits

Bands 5150 – 5250 MHz

FCC Limits

Conducted Power Limit lesser of: 50 mW or 4 dBm + 10 log (B) dBm. B is the 26 dB emission bandwidth in MHz.

Mode	Frequency Range (MHz)	Minimum 26 dB Bandwidth (MHz)	4 + 10 Log (B) (dBm)	Limit (dBm)
a	5150 – 5250	23.848	+17.77	+17.00
HT-20		25.050	+17.99	+17.00
HT-40		41.683	+20.20	+17.00
ac-80		84.168	+23.25	

Industry Canada Limits

EIRP Limit 5150 – 5250 MHz: Lesser of 200 mW (+23 dBm) or 10 + 10 Log (B) dBm. B is the 99% emission bandwidth in MHz.

Mode	Frequency Range (MHz)	Minimum 99 % Bandwidth (MHz)	10 + 10 Log (B) (dBm)	EIRP Limit (dBm)
a	5150 – 5250	16.834	+22.26	+22.26
HT-20		17.836	+22.51	+22.51
HT-40		36.072	+25.57	+23.00
ac-80		75.752	+28.79	+23.00

The maximum antenna gain for the XI-AC1300 is 5 dBi. The XI-AC1300 has no beam-forming capability.



Title: Xirrus Inc. XI-AC1300, XI-AC867 (non-DFS Bands)
To: FCC 47 CFR Part 15.407 & IC RSS-210
Serial #: XIRR04-U6 Rev A
Issue Date: 29th April 2014
Page: 42 of 199

Measurement Results for Maximum Conducted Output Power

XI-AC1300 3x3 Operation

Equipment Configuration for Peak Transmit Power			
Variant:	3x3 802.11a	Duty Cycle (%):	98
Data Rate:	6 MBit/s	Antenna Gain (dBi):	5.00
Modulation:	OFDM	Beam Forming Gain (Y):	N/A
TPC:	Not Applicable	Tested By:	GMH
Engineering Test Notes: Test set up: 6" SMA pigtails soldered onto the pcb.			

Test Measurement Results									
Test Frequency	Measured Conducted Output Power (dBm)				Calculated Total Power	Minimum 26 dB Bandwidth	Limit	Margin	EUT Power Setting
	Port(s)								
MHz	a	b	c	d	Σ Port(s) dBm	MHz	dBm	dBm	
5180.0	9.91	8.17	10.21	--	14.29	24.148	17.00	-2.71	8.00
5200.0	9.69	8.64	10.10	--	14.29	23.848	17.00	-2.71	8.00
5240.0	9.64	10.29	10.19	--	14.82	24.649	17.00	-2.18	8.00

Traceability to Industry Recognized Test Methodologies	
Work Instruction:	WI-03 MEASURING RF SPECTRUM MASK
Measurement Uncertainty:	±2.81 dB

Equipment Configuration for Peak Transmit Power			
Variant:	3x3 802.11n HT-20	Duty Cycle (%):	98
Data Rate:	6.5 MBit/s	Antenna Gain (dBi):	5.00
Modulation:	OFDM	Beam Forming Gain (Y):	Not Applicable
TPC:	Not Applicable	Tested By:	GMH
Engineering Test Notes:			

Test Measurement Results									
Test Frequency	Measured Conducted Output Power (dBm)				Calculated Total Power	Minimum 26 dB Bandwidth	Limit	Margin	EUT Power Setting
	Port(s)								
MHz	a	b	c	d	Σ Port(s) dBm	MHz	dBm	dBm	
5180.0	9.69	8.00	9.65	--	13.95	25.251	17.00	-3.05	8.00
5200.0	9.45	8.40	9.87	--	14.05	25.050	17.00	-2.95	8.00
5240.0	8.48	8.96	9.06	--	13.61	25.551	17.00	-3.39	8.00

Traceability to Industry Recognized Test Methodologies	
Work Instruction:	WI-03 MEASURING RF SPECTRUM MASK
Measurement Uncertainty:	±2.81 dB

This test report may be reproduced in full only. The document may only be updated by MiCOM Labs personnel. Any changes will be noted in the Document History section of the report.



Title: Xirrus Inc. XI-AC1300, XI-AC867 (non-DFS Bands)
To: FCC 47 CFR Part 15.407 & IC RSS-210
Serial #: XIRR04-U6 Rev A
Issue Date: 29th April 2014
Page: 43 of 199

Equipment Configuration for Peak Transmit Power

Variant:	3x3 802.11n HT-40	Duty Cycle (%):	99
Data Rate:	13.5 MBit/s	Antenna Gain (dBi):	4.00
Modulation:	OFDM	Beam Forming Gain (Y):	N/A
TPC:	Not Applicable	Tested By:	CC
Engineering Test Notes:			

Test Measurement Results

Test Frequency	Measured Conducted Output Power (dBm)				Calculated Total Power	Minimum 26 dB Bandwidth	Limit	Margin	EUT Power Setting
	Port(s)								
MHz	a	b	c	d	Σ Port(s) dBm	MHz	dBm	dBm	
5190.0	11.35	13.38	7.05	--	16.08	42.485	17.00	-0.92	12.00
5230.0	11.02	13.54	9.21	--	16.40	41.683	17.00	-0.60	12.00

Traceability to Industry Recognized Test Methodologies

Work Instruction:	WI-03 MEASURING RF SPECTRUM MASK
Measurement Uncertainty:	±2.81 dB

Equipment Configuration for Peak Transmit Power

Variant:	3x3 802.11ac-80	Duty Cycle (%):	99
Data Rate:	29.3 MBit/s	Antenna Gain (dBi):	4.00
Modulation:	OFDM	Beam Forming Gain (Y):	Not Applicable
TPC:	Not Applicable	Tested By:	CC
Engineering Test Notes:			

Test Measurement Results

Test Frequency	Measured Conducted Output Power (dBm)				Calculated Total Power	Minimum 26 dB Bandwidth	Limit	Margin	EUT Power Setting
	Port(s)								
MHz	a	b	c	d	Σ Port(s) dBm	MHz	dBm	dBm	
5210.0	12.17	14.02	8.58	--	16.90	84.168	17.00	-0.1	14.00

Traceability to Industry Recognized Test Methodologies

Work Instruction:	WI-03 MEASURING RF SPECTRUM MASK
Measurement Uncertainty:	±2.81 dB

This test report may be reproduced in full only. The document may only be updated by MiCOM Labs personnel. Any changes will be noted in the Document History section of the report.



Title: Xirrus Inc. XI-AC1300, XI-AC867 (non-DFS Bands)
To: FCC 47 CFR Part 15.407 & IC RSS-210
Serial #: XIRR04-U6 Rev A
Issue Date: 29th April 2014
Page: 44 of 199

XI-AC867 2x2 Operation

Equipment Configuration for Peak Transmit Power			
Variant:	2x2 802.11a	Duty Cycle (%):	98
Data Rate:	6 mbits	Antenna Gain (dBi):	5.00
Modulation:	OFDM	Beam Forming Gain (Y):	N/A
TPC:	Not Applicable	Tested By:	AH
Engineering Test Notes:			

Test Measurement Results										
Test Frequency	Measured Conducted Output Power (dBm)				Calculated Total Power	Minimum 26 dB Bandwidth	Limit	Margin	EUT Power Setting	
	Port(s)									
MHz	a	b	c	d	Σ Port(s) dBm	MHz	dBm	dBm		
5180.0	9.00	9.18	--	--	12.10	22.545	17.00	-4.90	9.00	
5200.0	8.87	9.13	--	--	12.01	22.745	17.00	-4.99	9.00	
5240.0	8.74	10.06	--	--	12.46	22.244	17.00	-4.54	9.00	

Traceability to Industry Recognized Test Methodologies	
Work Instruction:	WI-03 MEASURING RF SPECTRUM MASK
Measurement Uncertainty:	±2.81 dB

Variant:	2x2 802.11ac-80	Duty Cycle (%):	98
Data Rate:	29.3 mbits	Antenna Gain (dBi):	5.00
Modulation:	OFDM	Beam Forming Gain (Y):	N/A
TPC:	Not Applicable	Tested By:	AH
Engineering Test Notes:			

Test Measurement Results										
Test Frequency	Measured Conducted Output Power (dBm)				Calculated Total Power	Minimum 26 dB Bandwidth	Limit	Margin	EUT Power Setting	
	Port(s)									
MHz	a	b	c	d	Σ Port(s) dBm	MHz	dBm	dBm		
5210.0	13.19	13.66	--	--	16.44	87.375	17.00	-0.56	14.00	

Traceability to Industry Recognized Test Methodologies	
Work Instruction:	WI-03 MEASURING RF SPECTRUM MASK
Measurement Uncertainty:	

This test report may be reproduced in full only. The document may only be updated by MiCOM Labs personnel. Any changes will be noted in the Document History section of the report.



Title: Xirrus Inc. XI-AC1300, XI-AC867 (non-DFS Bands)
To: FCC 47 CFR Part 15.407 & IC RSS-210
Serial #: XIRR04-U6 Rev A
Issue Date: 29th April 2014
Page: 45 of 199

Equipment Configuration for Peak Transmit Power

Variant:	2x2 802.11n HT-20	Duty Cycle (%):	98
Data Rate:	6.5 mbits	Antenna Gain (dBi):	5.00
Modulation:	OFDM	Beam Forming Gain (Y):	N/A
TPC:	Not Applicable	Tested By:	AH
Engineering Test Notes:			

Test Measurement Results

Test Frequency	Measured Conducted Output Power (dBm)				Calculated Total Power	Minimum 26 dB Bandwidth	Limit	Margin	EUT Power Setting
	Port(s)								
MHz	a	b	c	d	Σ Port(s) dBm	MHz	dBm	dBm	
5180.0	7.85	7.54	--	--	10.71	22.345	17.00	-6.29	8.00
5200.0	7.84	7.97	--	--	10.91	22.445	17.00	-6.09	8.00
5240.0	7.58	8.35	--	--	10.99	23.347	17.00	-6.01	8.00

Traceability to Industry Recognized Test Methodologies

Work Instruction:	WI-03 MEASURING RF SPECTRUM MASK
Measurement Uncertainty:	±2.81 dB

Equipment Configuration for Peak Transmit Power

Variant:	2x2 802.11n HT-40	Duty Cycle (%):	98
Data Rate:	13.5 mbits	Antenna Gain (dBi):	5.00
Modulation:	OFDM	Beam Forming Gain (Y):	N/A
TPC:	Not Applicable	Tested By:	AH
Engineering Test Notes:			

Test Measurement Results

Test Frequency	Measured Conducted Output Power (dBm)				Calculated Total Power	Minimum 26 dB Bandwidth	Limit	Margin	EUT Power Setting
	Port(s)								
MHz	a	b	c	d	Σ Port(s) dBm	MHz	dBm	dBm	
5190.0	11.32	11.35	--	--	14.34	43.487	17.00	-2.66	12.00
5230.0	11.11	12.15	--	--	14.67	44.088	17.00	-2.33	12.00

Traceability to Industry Recognized Test Methodologies

Work Instruction:	WI-03 MEASURING RF SPECTRUM MASK
Measurement Uncertainty:	±2.81 dB

This test report may be reproduced in full only. The document may only be updated by MiCOM Labs personnel. Any changes will be noted in the Document History section of the report.



Specification Limits

FCC, Part 15 §15.407 (a)(1), (a)(2) and Industry Canada RSS-210 § A9.2(2)

(a)(1) For the band 5.15-5.25 GHz the maximum conducted output power over the frequency band of operation shall not exceed the lesser of 50 mW or $+4 \text{ dBm} + 10 \log B$, where B is the 26 dB emission bandwidth in megahertz. In addition, the peak power spectral density shall not exceed +4 dBm in any 1 megahertz band.

(a)(2) For the 5.25-5.35 and 5470-5725 MHz GHz band the maximum conducted output power over the frequency band of operation shall not exceed the lesser of 250 mW or $+11 \text{ dBm} + 10 \log B$, where B is the 26 dB emission bandwidth in megahertz. In addition, the peak power spectral density shall not exceed +11 dBm in any 1 megahertz band.

Industry Canada RSS-210 §A9.2(2)

For the band 5150-5250 MHz, the maximum equivalent isotropically radiated power (e.i.r.p.) shall not exceed 200 mW or $10 + 10 \log_{10} B$, dBm, whichever power is less. B is the 99% emission bandwidth in MHz. The e.i.r.p. spectral density shall not exceed 10 dBm in any 1.0 MHz band.

For the band 5250-5350 MHz and 5470-5725 MHz, the maximum conducted output power shall not exceed 250 mW or $11 + 10 \log_{10} B$, dBm, whichever power is less. The power spectral density shall not exceed 11 dBm in any 1.0 MHz band. The maximum e.i.r.p. shall not exceed 1.0 W or $17 + 10 \log_{10} B$, dBm, whichever power is less. B is the 99% emission bandwidth in MHz.

Industry Canada RSS-Gen 4.4

When an occupied bandwidth value is not specified in the applicable RSS, the transmitted signal bandwidth to be reported is to be its 99% emission bandwidth, as calculated or measured.

Traceability

Test Equipment Used

0158, 0287, 0252, 0313, 0314, 0070, 0116, 0117



Title: Xirrus Inc. XI-AC1300, XI-AC867 (non-DFS Bands)
To: FCC 47 CFR Part 15.407 & IC RSS-210
Serial #: XIRR04-U6 Rev A
Issue Date: 29th April 2014
Page: 47 of 199

6.1.1.3. Peak Power Spectral Density

Conducted Test Conditions for Power Spectral Density			
Standard:	FCC CFR 47:15.407	Ambient Temp. (°C):	24.0 - 27.5
Test Heading:	Power Spectral Density	Rel. Humidity (%):	32 - 45
Standard Section(s):	15.247 (a)	Pressure (mBars):	999 - 1001
Reference Document(s):	KDB 789033 - D01 DTS General UNII Test Procedures v01		

Test Procedure for Power Spectral Density

The In-Band power spectral density was measured using the measure and sum approach per FCC KDB 662911 (D01 Multiple Transmitter Output v01.)

Measure and sum the spectra across the outputs. With this technique, spectra are measured at each output of the device at the required resolution bandwidth. The individual spectra are then summed mathematically in linear power units. Unlike in-band power measurements, in which the sum involves a single measured value (output power) from each output, measurements for compliance with PSD limits involve summing entire spectra across corresponding frequency bins on the various outputs. Consistency is maintained for any device with N transmitter outputs to be certain the individual outputs are all aligned with the same span and same number of points. In this instance, the linear power spectrum value within the first spectral bin of output 0 is summed with that in the first spectral bin of output 1, and the first spectral bin of output 2, and so on up to the Nth output to obtain the true value for the first frequency bin of the summed spectrum. The summed spectrum value for each frequency bin is computed in this fashion. These summed spectral values were calculated on a computer, and the results read back into the spectrum analyzer as a data file to produce a representative plot of total spectral power density.

Calculated Power = $A + 10 \log (1/x)$ dBm

$A = \text{Total Power Spectral Density } [10 \text{ Log}_{10} (10^{a/10} + 10^{b/10} + 10^{c/10} + 10^{d/10})]$

x = Duty Cycle

This test report may be reproduced in full only. The document may only be updated by MiCOM Labs personnel. Any changes will be noted in the Document History section of the report.



Title: Xirrus Inc. XI-AC1300, XI-AC867 (non-DFS Bands)
To: FCC 47 CFR Part 15.407 & IC RSS-210
Serial #: XIRR04-U6 Rev A
Issue Date: 29th April 2014
Page: 48 of 199

XI-AC1300 3x3 Operation

Equipment Configuration for Peak Power Spectral Density			
Variant:	802.11a	Duty Cycle (%):	98.0
Data Rate:	6 MBit/s	Antenna Gain (dBi):	5.00
Modulation:	OFDM	Beam Forming Gain (Y):	Not Applicable
TPC:	Not Applicable	Tested By:	GMH
Engineering Test Notes:			

Test Measurement Results							
Test Frequency	Measured Power Spectral Density				Amplitude Summation	Limit	Margin
	Port(s) (dBm/MHz)						
MHz	a	b	c	d	dBm/MHz	dBm/MHz	dB
5180.0	-0.709	-2.962	-0.123	--	3.098	4.0	-0.9
5200.0	-1.696	-2.810	-0.831	--	2.469	4.0	-1.5
5240.0	-1.329	-0.846	-0.637	--	3.324	4.0	-0.7

Traceability to Industry Recognized Test Methodologies	
Work Instruction:	WI-03 MEASURING RF SPECTRUM MASK
Measurement Uncertainty:	±2.81 dB

Note: click the links in the above matrix to view the graphical image (plot).

Equipment Configuration for Peak Power Spectral Density			
Variant:	802.11n HT-20	Duty Cycle (%):	98.0
Data Rate:	6.5 MBit/s	Antenna Gain (dBi):	5.00
Modulation:	OFDM	Beam Forming Gain (Y):	Not Applicable
TPC:	Not Applicable	Tested By:	GMH
Engineering Test Notes:			

Test Measurement Results							
Test Frequency	Measured Power Spectral Density				Amplitude Summation	Limit	Margin
	Port(s) (dBm/MHz)						
MHz	a	b	c	d	dBm/MHz	dBm/MHz	dB
5180.0	-1.865	-3.073	-1.879	--	1.444	4.0	-2.6
5200.0	-2.526	-2.887	-1.530	--	1.741	4.0	-2.3
5240.0	-2.349	-2.530	-0.945	--	1.710	4.0	-2.3

Traceability to Industry Recognized Test Methodologies	
Work Instruction:	WI-03 MEASURING RF SPECTRUM MASK
Measurement Uncertainty:	±2.81 dB

Note: click the links in the above matrix to view the graphical image (plot).

This test report may be reproduced in full only. The document may only be updated by MiCOM Labs personnel. Any changes will be noted in the Document History section of the report.



Title: Xirrus Inc. XI-AC1300, XI-AC867 (non-DFS Bands)
To: FCC 47 CFR Part 15.407 & IC RSS-210
Serial #: XIRR04-U6 Rev A
Issue Date: 29th April 2014
Page: 49 of 199

Equipment Configuration for Peak Power Spectral Density

Variant:	802.11n HT-40	Duty Cycle (%):	99.0
Data Rate:	13.5 MBit/s	Antenna Gain (dBi):	5.00
Modulation:	OFDM	Beam Forming Gain (Y):	Not Applicable
TPC:	Not Applicable	Tested By:	CC
Engineering Test Notes:			

Test Measurement Results

Test Frequency	Measured Power Spectral Density				Amplitude Summation	Limit	Margin
	Port(s) (dBm/MHz)						
MHz	a	b	c	d	dBm/MHz	dBm/MHz	dB
5190.0	-1.747	0.278	-4.829	--	2.776	4.0	-1.2
5230.0	-2.175	0.190	-2.837	--	2.716	4.0	-1.3

Traceability to Industry Recognized Test Methodologies

Work Instruction:	WI-03 MEASURING RF SPECTRUM MASK
Measurement Uncertainty:	±2.81 dB

Note: click the links in the above matrix to view the graphical image (plot).

Equipment Configuration for Peak Power Spectral Density

Variant:	802.11ac-80	Duty Cycle (%):	99.0
Data Rate:	29.3 MBit/s	Antenna Gain (dBi):	5.00
Modulation:	OFDM	Beam Forming Gain (Y):	Not Applicable
TPC:	Not Applicable	Tested By:	CC
Engineering Test Notes:			

Test Measurement Results

Test Frequency	Measured Power Spectral Density				Amplitude Summation	Limit	Margin
	Port(s) (dBm/MHz)						
MHz	a	b	c	d	dBm/MHz	dBm/MHz	dB
5210.0	-2.857	-1.038	-5.086	--	1.587	4.0	-2.4

Traceability to Industry Recognized Test Methodologies

Work Instruction:	WI-03 MEASURING RF SPECTRUM MASK
Measurement Uncertainty:	±2.81 dB

Note: click the links in the above matrix to view the graphical image (plot).

This test report may be reproduced in full only. The document may only be updated by MiCOM Labs personnel. Any changes will be noted in the Document History section of the report.



Title: Xirrus Inc. XI-AC1300, XI-AC867 (non-DFS Bands)
To: FCC 47 CFR Part 15.407 & IC RSS-210
Serial #: XIRR04-U6 Rev A
Issue Date: 29th April 2014
Page: 50 of 199

XI-AC867 2x2 Operation

Equipment Configuration for Peak Power Spectral Density			
Variant:	2x2 802.11a	Duty Cycle (%):	98.0
Data Rate:	6 mbits	Antenna Gain (dBi):	5.00
Modulation:	OFDM	Beam Forming Gain (Y):	Not Applicable
TPC:	Not Applicable	Tested By:	AH
Engineering Test Notes:			

Test Measurement Results							
Test Frequency	Measured Power Spectral Density				Amplitude Summation	Limit	Margin
	Port(s) (dBm/MHz)						
MHz	a	b	c	d	dBm/MHz	dBm/MHz	dB
5180.0	-1.983	-1.486	--	--	1.191	4.0	-2.8
5200.0	-2.057	-1.416	--	--	1.150	4.0	-2.9
5240.0	-2.129	-0.766	--	--	1.388	4.0	-2.6

Traceability to Industry Recognized Test Methodologies	
Work Instruction:	WI-03 MEASURING RF SPECTRUM MASK
Measurement Uncertainty:	±2.81 dB

Note: click the links in the above matrix to view the graphical image (plot).

Equipment Configuration for Peak Power Spectral Density			
Variant:	2x2 802.11ac-80	Duty Cycle (%):	98.0
Data Rate:	29.3 mbits	Antenna Gain (dBi):	5.00
Modulation:	OFDM	Beam Forming Gain (Y):	Not Applicable
TPC:	Not Applicable	Tested By:	AH
Engineering Test Notes:			

Test Measurement Results							
Test Frequency	Measured Power Spectral Density				Amplitude Summation	Limit	Margin
	Port(s) (dBm/MHz)						
MHz	a	b	c	d	dBm/MHz	dBm/MHz	dB
5210.0	-4.414	-3.407	--	--	-0.999	4.0	-5.0

Traceability to Industry Recognized Test Methodologies	
Work Instruction:	WI-03 MEASURING RF SPECTRUM MASK
Measurement Uncertainty:	

Note: click the links in the above matrix to view the graphical image (plot).

This test report may be reproduced in full only. The document may only be updated by MiCOM Labs personnel. Any changes will be noted in the Document History section of the report.



Title: Xirrus Inc. XI-AC1300, XI-AC867 (non-DFS Bands)
To: FCC 47 CFR Part 15.407 & IC RSS-210
Serial #: XIRR04-U6 Rev A
Issue Date: 29th April 2014
Page: 51 of 199

Equipment Configuration for Peak Power Spectral Density

Variant:	2x2 802.11n HT-20	Duty Cycle (%):	98.0
Data Rate:	13.5 mbits	Antenna Gain (dBi):	5.00
Modulation:	OFDM	Beam Forming Gain (Y):	Not Applicable
TPC:	Not Applicable	Tested By:	AH
Engineering Test Notes:			

Test Measurement Results

Test Frequency	Measured Power Spectral Density				Amplitude Summation	Limit	Margin
	Port(s) (dBm/MHz)						
MHz	a	b	c	d	dBm/MHz	dBm/MHz	dB
5180.0	-3.371	-3.289	--	--	-0.412	4.0	-4.4
5200.0	-3.594	-3.331	--	--	-0.566	4.0	-4.6
5240.0	-3.376	-2.477	--	--	-0.001	4.0	-4.0

Traceability to Industry Recognized Test Methodologies

Work Instruction:	WI-03 MEASURING RF SPECTRUM MASK
Measurement Uncertainty:	±2.81 dB

Note: click the links in the above matrix to view the graphical image (plot).

Equipment Configuration for Peak Power Spectral Density

Variant:	2x2 802.11n HT-40	Duty Cycle (%):	98.0
Data Rate:	13.5 mbits	Antenna Gain (dBi):	5.00
Modulation:	OFDM	Beam Forming Gain (Y):	Not Applicable
TPC:	Not Applicable	Tested By:	AH
Engineering Test Notes:			

Test Measurement Results

Test Frequency	Measured Power Spectral Density				Amplitude Summation	Limit	Margin
	Port(s) (dBm/MHz)						
MHz	a	b	c	d	dBm/MHz	dBm/MHz	dB
5190.0	-3.067	-2.797	--	--	-0.009	4.0	-4.0
5230.0	-3.261	-1.905	--	--	0.336	4.0	-3.7

Traceability to Industry Recognized Test Methodologies

Work Instruction:	WI-03 MEASURING RF SPECTRUM MASK
Measurement Uncertainty:	±2.81 dB

Note: click the links in the above matrix to view the graphical image (plot).

This test report may be reproduced in full only. The document may only be updated by MiCOM Labs personnel. Any changes will be noted in the Document History section of the report.



Title: Xirrus Inc. XI-AC1300, XI-AC867 (non-DFS Bands)
To: FCC 47 CFR Part 15.407 & IC RSS-210
Serial #: XIRR04-U6 Rev A
Issue Date: 29th April 2014
Page: 52 of 199

Specification

FCC, Part 15 §15.407 (a)(1), (a)(2)

5150 – 5250 MHz

(a)(1) The peak power spectral density shall not exceed +4 dBm in any 1 megahertz band.

5250 – 5350 MHz & 5470 – 5725 MHz

(a)(2) The peak power spectral density shall not exceed +11 dBm in any 1 megahertz band.

Industry Canada RSS-210 § A9.2(1), A9.2(2)

5150 – 5250 MHz

§ **A9.2(1)** The eirp spectral density shall not exceed +10 dBm in any 1 MHz band

5250 – 5350 MHz & 5470 – 5725 MHz

§ **A9.2(2)** The power spectral density shall not exceed +11 dBm in any 1 MHz band

Traceability

Test Equipment Used

0158, 0287, 0252, 0313, 0314, 0070, 0116, 0117

This test report may be reproduced in full only. The document may only be updated by MiCOM Labs personnel. Any changes will be noted in the Document History section of the report.



Title: Xirrus Inc. XI-AC1300, XI-AC867 (non-DFS Bands)
To: FCC 47 CFR Part 15.407 & IC RSS-210
Serial #: XIRR04-U6 Rev A
Issue Date: 29th April 2014
Page: 53 of 199

6.1.1.4. Peak Excursion Ratio

Conducted Test Conditions for Peak Excursion Ratio			
Standard:	FCC CFR 47:15.407	Ambient Temp. (°C):	24.0 - 27.5
Test Heading:	Peak Excursion Ratio	Rel. Humidity (%):	32 - 45
Standard Section(s):	15.407 (a)(6)	Pressure (mBars):	999 - 1001
Reference Document(s):	KDB 789033 - D01 DTS General UNII Test Procedures v01		

Test Procedure for Peak Excursion Ratio

Compliance with the peak excursion requirement is demonstrated by confirming the ratio of the maximum of the peak-hold spectrum to the maximum of the average spectrum during continuous transmission. Section F) of KDB 789033 was used in order to prove compliance. This is a conducted measurement using a spectrum analyzer using dual traces. Peak Excursion Ratio is the difference in amplitude (dB) between both traces; The following identifies two spectrum traces on the same plot. Trace 1 is the max hold Peak detector, and Trace 2 is the recalled trace data from Peak Power Spectral Density measurements. Each frequency and operational mode is recalled in order to prove compliance.

This test report may be reproduced in full only. The document may only be updated by MiCOM Labs personnel. Any changes will be noted in the Document History section of the report.



Title: Xirrus Inc. XI-AC1300, XI-AC867 (non-DFS Bands)
To: FCC 47 CFR Part 15.407 & IC RSS-210
Serial #: XIRR04-U6 Rev A
Issue Date: 29th April 2014
Page: 54 of 199

XI-AC1300 3x3 Operation

Equipment Configuration for Peak Excursion Ratio

Variant:	802.11a	Duty Cycle (%):	98
Data Rate:	6 MBit/s	Antenna Gain (dBi):	Not Applicable
Modulation:	OFDM	Beam Forming Gain (Y):	Not Applicable
TPC:	Not Applicable	Tested By:	CC
Engineering Test Notes:			

Test Measurement Results								
Test Frequency	Measured Peak Excursion (dB)				Ratio (dB)		Limit	Lowest Margin
	Port(s)				Highest	Lowest		
MHz	a	b	c	d	Highest	Lowest	dB	MHz
5180.0	9.96	--	--	--	9.96	9.96	13.0	-3.04

Traceability to Industry Recognized Test Methodologies	
Work Instruction:	WI-03 MEASURING RF SPECTRUM MASK
Measurement Uncertainty:	±2.81 dB

Note: click the links in the above matrix to view the graphical image (plot).

Equipment Configuration for Peak Excursion Ratio

Variant:	802.11n HT-20	Duty Cycle (%):	98
Data Rate:	6.5 MBit/s	Antenna Gain (dBi):	Not Applicable
Modulation:	OFDM	Beam Forming Gain (Y):	Not Applicable
TPC:	Not Applicable	Tested By:	GMH
Engineering Test Notes:			

Test Measurement Results								
Test Frequency	Measured Peak Excursion (dB)				Ratio (dB)		Limit	Lowest Margin
	Port(s)				Highest	Lowest		
MHz	a	b	c	d	Highest	Lowest	dB	MHz
5180.0	10.83	--	--	--	10.83	10.83	13.0	-2.17

Traceability to Industry Recognized Test Methodologies	
Work Instruction:	WI-03 MEASURING RF SPECTRUM MASK
Measurement Uncertainty:	±2.81 dB

Note: click the links in the above matrix to view the graphical image (plot).

This test report may be reproduced in full only. The document may only be updated by MiCOM Labs personnel. Any changes will be noted in the Document History section of the report.



Title: Xirrus Inc. XI-AC1300, XI-AC867 (non-DFS Bands)
To: FCC 47 CFR Part 15.407 & IC RSS-210
Serial #: XIRR04-U6 Rev A
Issue Date: 29th April 2014
Page: 55 of 199

Equipment Configuration for Peak Excursion Ratio

Variant:	802.11n HT-40	Duty Cycle (%):	99
Data Rate:	13.5 MBit/s	Antenna Gain (dBi):	Not Applicable
Modulation:	OFDM	Beam Forming Gain (Y):	Not Applicable
TPC:	Not Applicable	Tested By:	CC
Engineering Test Notes:			

Test Measurement Results

Test Frequency	Measured Peak Excursion (dB)				Ratio (dB)		Limit	Lowest Margin
	Port(s)				Highest	Lowest		
MHz	a	b	c	d	Highest	Lowest	dB	MHz
5190.0	8.81	--	--	--	8.81	8.81	13.0	-4.19

Traceability to Industry Recognized Test Methodologies

Work Instruction:	WI-03 MEASURING RF SPECTRUM MASK
Measurement Uncertainty:	±2.81 dB

Note: click the links in the above matrix to view the graphical image (plot).

This test report may be reproduced in full only. The document may only be updated by MiCOM Labs personnel. Any changes will be noted in the Document History section of the report.



Title: Xirrus Inc. XI-AC1300, XI-AC867 (non-DFS Bands)
To: FCC 47 CFR Part 15.407 & IC RSS-210
Serial #: XIRR04-U6 Rev A
Issue Date: 29th April 2014
Page: 56 of 199

XI-AC867 2x2 Operation

Equipment Configuration for Peak Excursion Ratio

Variant:	2x2 802.11a	Duty Cycle (%):	98
Data Rate:	6 mbits	Antenna Gain (dBi):	Not Applicable
Modulation:	OFDM	Beam Forming Gain (Y):	Not Applicable
TPC:	Not Applicable	Tested By:	AH
Engineering Test Notes:			

Test Measurement Results								
Test Frequency	Measured Peak Excursion (dB)				Ratio (dB)		Limit	Lowest Margin
	Port(s)				Highest	Lowest		
MHz	a	b	c	d	Highest	Lowest	dB	MHz
5180.0	9.93	--	--	--	9.93	9.93	13.0	-3.07

Traceability to Industry Recognized Test Methodologies	
Work Instruction:	WI-03 MEASURING RF SPECTRUM MASK
Measurement Uncertainty:	±2.81 dB

Note: click the links in the above matrix to view the graphical image (plot).

Equipment Configuration for Peak Excursion Ratio

Variant:	2x2 802.11n HT-20	Duty Cycle (%):	98
Data Rate:	6.5 mbits	Antenna Gain (dBi):	Not Applicable
Modulation:	OFDM	Beam Forming Gain (Y):	Not Applicable
TPC:	Not Applicable	Tested By:	AH
Engineering Test Notes:			

Test Measurement Results								
Test Frequency	Measured Peak Excursion (dB)				Ratio (dB)		Limit	Lowest Margin
	Port(s)				Highest	Lowest		
MHz	a	b	c	d	Highest	Lowest	dB	MHz
5180.0	9.43	--	--	--	9.43	9.43	13.0	-3.57

Traceability to Industry Recognized Test Methodologies	
Work Instruction:	WI-03 MEASURING RF SPECTRUM MASK
Measurement Uncertainty:	±2.81 dB

Note: click the links in the above matrix to view the graphical image (plot).

This test report may be reproduced in full only. The document may only be updated by MiCOM Labs personnel. Any changes will be noted in the Document History section of the report.



Title: Xirrus Inc. XI-AC1300, XI-AC867 (non-DFS Bands)
To: FCC 47 CFR Part 15.407 & IC RSS-210
Serial #: XIRR04-U6 Rev A
Issue Date: 29th April 2014
Page: 57 of 199

Equipment Configuration for Peak Excursion Ratio

Variant:	2x2 802.11n HT-40	Duty Cycle (%):	98
Data Rate:	13.5 mbits	Antenna Gain (dBi):	Not Applicable
Modulation:	OFDM	Beam Forming Gain (Y):	Not Applicable
TPC:	Not Applicable	Tested By:	AH
Engineering Test Notes:			

Test Measurement Results								
---------------------------------	--	--	--	--	--	--	--	--

Test Frequency	Measured Peak Excursion (dB)				Ratio (dB)		Limit	Lowest Margin
	Port(s)				Highest	Lowest		
MHz	a	b	c	d	Highest	Lowest	dB	MHz
5190.0	9.94	--	--	--	9.94	9.94	13.0	-3.06

Traceability to Industry Recognized Test Methodologies	
---------------------------------------------------------------	--

Work Instruction:	WI-03 MEASURING RF SPECTRUM MASK
Measurement Uncertainty:	±2.81 dB

Note: click the links in the above matrix to view the graphical image (plot).

This test report may be reproduced in full only. The document may only be updated by MiCOM Labs personnel. Any changes will be noted in the Document History section of the report.



Title: Xirrus Inc. XI-AC1300, XI-AC867 (non-DFS Bands)
To: FCC 47 CFR Part 15.407 & IC RSS-210
Serial #: XIRR04-U6 Rev A
Issue Date: 29th April 2014
Page: 58 of 199

Specification

Limits

§15.407 (a)(6) The ratio of the peak excursion of the modulation envelope (measured using a peak hold function) to the peak transmit power (measured as specified in this paragraph) shall not exceed 13dB across any 1MHz bandwidth or the emission bandwidth whichever is less

Traceability

Test Equipment Used

0158, 0287, 0252, 0313, 0314, 0070, 0116, 0117

This test report may be reproduced in full only. The document may only be updated by MiCOM Labs personnel. Any changes will be noted in the Document History section of the report.



Title: Xirrus Inc. XI-AC1300, XI-AC867 (non-DFS Bands)
To: FCC 47 CFR Part 15.407 & IC RSS-210
Serial #: XIRR04-U6 Rev A
Issue Date: 29th April 2014
Page: 59 of 199

6.1.1.5. Frequency Stability

FCC, Part 15 Subpart C §15.407(g)
Industry Canada RSS-210 §2.1

Test Procedure

The manufacturer of the equipment is responsible for ensuring that the frequency stability is such that emissions are always maintained within the band of operation under all conditions.

Manufacturer Declaration

The frequency stability of the reference oscillator sets the frequency stability of the RF transceiver signals. Therefore all of the RF signals should have ± 20 ppm stability.

This stability accounts for room temp tolerance of the crystal oscillator circuit, frequency variation across temperature, and crystal ageing.

± 20 ppm at 5.250 GHz translates to a maximum frequency shift of ± 105 KHz. As the edge of the channels is at least one MHz from either of the band edges, ± 105 KHz is more than sufficient to guarantee that the intentional emission will remain in the band over the entire operating range of the EUT.

Specification

Limits

§15.407 (g) Manufacturers of U-NII devices are responsible for ensuring frequency stability such that an emission is maintained within the band of operation under all conditions of normal operation as specified in the user's manual.

This test report may be reproduced in full only. The document may only be updated by MiCOM Labs personnel. Any changes will be noted in the Document History section of the report.



6.1.2. Radiated Emission Testing

FCC, Part 15 Subpart C §15.407(b)(2), §15.205(a)/15.209(a)
Industry Canada RSS-210 §A9.3(2); §2.2; §2.6; RSS-Gen §4.7

Test Procedure

Testing was performed in a 3-meter anechoic chamber. Preliminary radiated emissions were measured on every azimuth and with the receiving antenna in both horizontal and vertical polarizations. Preliminary emissions were recorded with in Spectrum Analyzer mode, using a maximum peak detector while in peak hold mode. Depending on the frequency band spanned a notch filter and/or waveguide filter was used to remove the fundamental frequency.

Emissions nearest the limits were chosen for maximization and formal measurement using a CISPR compliant receiver. Emissions above 1000 MHz are measured utilizing a CISPR compliant average detector with a tuned receiver, using a bandwidth of 1 MHz. Emissions from 30 MHz – 1000 MHz are measured utilizing a CISPR compliant quasi-peak detector with a tuned receiver, using a bandwidth of 120 kHz. Only the highest emissions relative to the limit are listed.

Field Strength Calculation

The field strength is calculated by adding the Antenna Factor and Cable Loss, and subtracting Amplifier Gain from the measured reading. All factors are included in the reported data.

$$FS = R + AF + CORR - FO$$

FS = Field Strength
R = Measured Spectrum analyzer Input Amplitude
AF = Antenna Factor

$$CORR = \text{Correction Factor} = CL - AG + NFL$$

CL = Cable Loss
AG = Amplifier Gain
FO = Distance Falloff Factor
NFL = Notch Filter Loss or Waveguide Loss

Field Strength Calculation Example:

Given receiver input reading of 51.5 dB μ V; Antenna Factor of 8.5 dB; Cable Loss of 1.3 dB; Falloff Factor of 0 dB, an Amplifier Gain of 26 dB and Notch Filter Loss of 1 dB. The Field Strength of the measured emission is:

$$FS = 51.5 + 8.5 + 1.3 - 26.0 + 1 = 36.3 \text{ dB}\mu\text{V/m}$$

Conversion between dB μ V/m (or dB μ V) and μ V/m (or μ V) are done as:

$$\text{Level (dB}\mu\text{V/m)} = 20 * \text{Log (level (\mu\text{V/m}))}$$

$$\begin{aligned} 40 \text{ dB}\mu\text{V/m} &= 100 \mu\text{V/m} \\ 48 \text{ dB}\mu\text{V/m} &= 250 \mu\text{V/m} \end{aligned}$$

This test report may be reproduced in full only. The document may only be updated by MiCOM Labs personnel. Any changes will be noted in the Document History section of the report.



Title: Xirrus Inc. XI-AC1300, XI-AC867 (non-DFS Bands)
To: FCC 47 CFR Part 15.407 & IC RSS-210
Serial #: XIRR04-U6 Rev A
Issue Date: 29th April 2014
Page: 61 of 199

The following formula is used to convert the equipment isotropic radiated power (eirp) to field strength (dB μ V/m);

$$E = 1000000 \times \sqrt{30P} / 3 \mu\text{V/m}$$

where P is the EIRP in Watts

Therefore: -27 dBm/MHz = 68.23 dB μ V/m

Note: The data in this Section identifies that the EUT is in compliance with the -27dBm/MHz EIRP limit (68.23 dB μ V/m) for out of band emissions. All out of band emissions are less than 68.23 dB μ V/m.

This test report may be reproduced in full only. The document may only be updated by MiCOM Labs personnel. Any changes will be noted in the Document History section of the report.



Title: Xirrus Inc. XI-AC1300, XI-AC867 (non-DFS Bands)
To: FCC 47 CFR Part 15.407 & IC RSS-210
Serial #: XIRR04-U6 Rev A
Issue Date: 29th April 2014
Page: 62 of 199

Specification

Radiated Spurious Emissions

15.407 (b)(2). All emissions outside of the 5,150-5,350MHz band shall not exceed an EIRP of -27dBm/MHz.

FCC §15.205 (a) Except as shown in paragraph (d) of 15.205 (a), only spurious emissions are permitted in any of the frequency bands listed.

FCC §15.205 (a) Except as shown in paragraphs (d) and (e) of this section, the field strength of emissions appearing within these frequency bands shall not exceed the limits shown in Section §15.209. At frequencies equal to or less than 1000 MHz, compliance with the limits in Section 15.209 shall be demonstrated using measurement instrumentation employing a CISPR quasi-peak detector. Above 1000 MHz, compliance with the emission limits in Section 15.209 shall be demonstrated based on the average value of the measured emissions. The provisions in Section 15.35 apply to these measurements.

FCC §15.209 (a) Except as provided elsewhere in this subpart, the emissions from an intentional radiator shall not exceed the field strength levels specified in the following table.

RSS-210 §A9.3(2) For transmitters operating in the 5250-5350 MHz band, all emissions outside the 5150-5350 MHz band shall not exceed -27 dBm/MHz e.i.r.p. Devices operating in the 5250-5350 MHz band that generate emissions in the 5150-5250 MHz band shall not exceed out of band emission limit of 27 dBm/MHz e.i.r.p. in the 5150-5250 MHz band in order to operate indoor/outdoor, or alternatively shall comply with the spectral power density for operation within the 5150-5250 MHz band and shall be labeled "for indoor use only".

RSS-Gen §4.7 The search for unwanted emissions shall be from the lowest frequency internally generated or used in the device (local oscillator, intermediate of carrier frequency), or from 30 MHz, whichever is the lowest frequency, to the 5th harmonic of the highest frequency generated without exceeding 40 GHz.

RSS-Gen §6 Receiver Spurious Emission Standard

If a radiated measurement is made, all spurious emissions shall comply with the limits of the following Table. The resolution bandwidth of the spectrum analyzer shall be 100 kHz for spurious emission measurements below 1.0 GHz and 1.0 MHz for measurements above 1.0 GHz

This test report may be reproduced in full only. The document may only be updated by MiCOM Labs personnel. Any changes will be noted in the Document History section of the report.



Title: Xirrus Inc. XI-AC1300, XI-AC867 (non-DFS Bands)
To: FCC 47 CFR Part 15.407 & IC RSS-210
Serial #: XIRR04-U6 Rev A
Issue Date: 29th April 2014
Page: 63 of 199

Table 1: FCC 15.209 Spurious Emissions Limits

Frequency (MHz)	Field Strength ($\mu\text{V/m}$)	Field Strength ($\text{dB}\mu\text{V/m}$)	Measurement Distance (meters)
30-88	100	40.0	3
88-216	150	43.5	3
216-960	200	46.0	3
Above 960	500	54.0	3

Traceability:

Test Equipment Used
0088, 0158, 0134, 0304, 0311, 0315, 0310, 0312

This test report may be reproduced in full only. The document may only be updated by MiCOM Labs personnel. Any changes will be noted in the Document History section of the report.



6.1.2.1. Radiated Emissions Integral Antenna

Test Freq.	5180 MHz	Engineer	SB
Variant	802.11a; 6 Mbs	Temp (°C)	22.5
Freq. Range	1000 MHz - 18000 MHz	Rel. Hum.(%)	25
Power Setting	target	Press. (mBars)	1007
Antenna	integral	Duty Cycle (%)	100
Test Notes 1			
Test Notes 2			

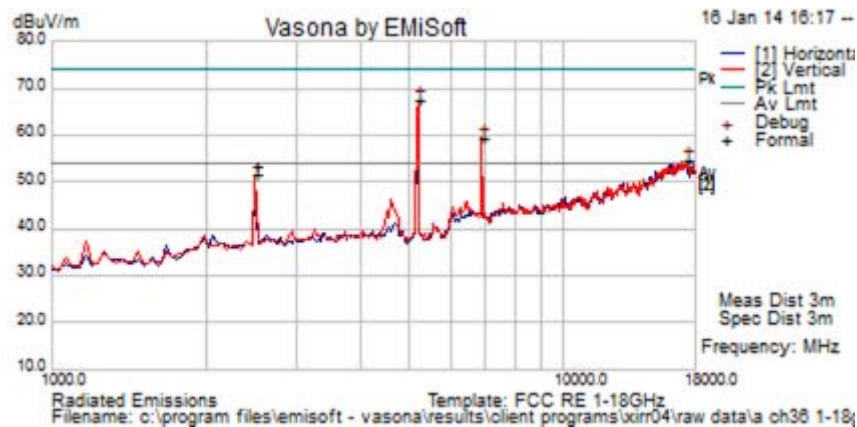

Formally measured emission peaks

Frequency MHz	Raw dBuV	Cable Loss	AF dB	Level dBuV/m	Measurement Type	Pol	Hgt cm	Azt Deg	Limit dBuV/m	Margin dB	Pass /Fail	Comments
2500.019	60.8	4.0	-11.5	53.4	Peak Max	V	99	195	74.0	-20.6	Pass	RB
17352.705	43.1	12.4	1.4	56.9	Peak Max	V	99	100	74	-17.1	Pass	Noise Floor
2500.019	59.2	4.0	-11.5	51.8	Average Max	V	99	195	54.0	-2.2	Pass	RB
17352.705	29.9	12.4	1.4	43.6	Average Max	V	99	100	54	-10.4	Pass	Noise Floor
5190.381	71.5	5.9	-9.9	67.5	Peak [Scan]	V						FUND
6893.788	59.1	7.0	-6.5	59.5	Peak [Scan]	V						NRB

Legend: TX = Transmitter Emissions; DIG = Digital Emissions; FUND = Fundamental; WB = Wideband Emission
 NRB = Non-Restricted Band. Limit = 68.23 dBuV/m; RB = Restricted Band. Limits per 15.205

This test report may be reproduced in full only. The document may only be updated by MiCOM Labs personnel. Any changes will be noted in the Document History section of the report.



Title: Xirrus Inc. XI-AC1300, XI-AC867 (non-DFS Bands)
To: FCC 47 CFR Part 15.407 & IC RSS-210
Serial #: XIRR04-U6 Rev A
Issue Date: 29th April 2014
Page: 65 of 199

Test Freq.	5200 MHz	Engineer	SB
Variant	802.11a; 6 Mbs	Temp (°C)	22.5
Freq. Range	1000 MHz - 18000 MHz	Rel. Hum.(%)	25
Power Setting	target	Press. (mBars)	1007
Antenna	integral	Duty Cycle (%)	100
Test Notes 1			
Test Notes 2			

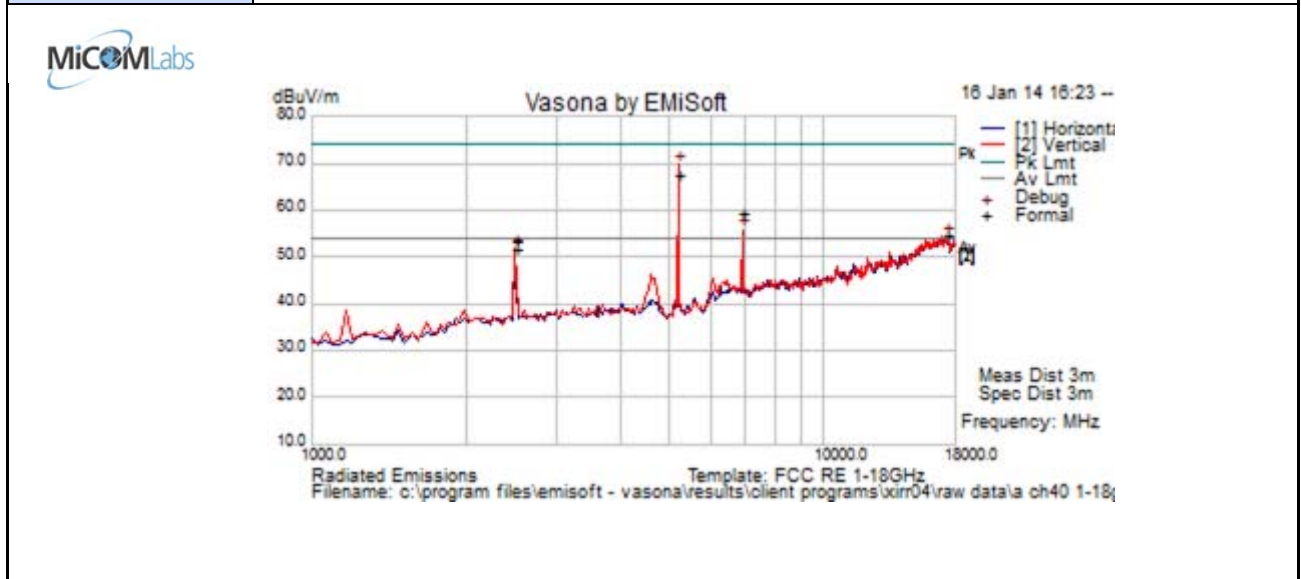

Formally measured emission peaks

Frequency MHz	Raw dBuV	Cable Loss	AF dB	Level dBuV/m	Measurement Type	Pol	Hgt cm	Azt Deg	Limit dBuV/m	Margin dB	Pass /Fail	Comments
5190.381	73.9	5.9	-9.9	69.9	Peak [Scan]	V						FUND
6927.85571	55.4	7.0	-6.5	55.9	Peak [Scan]	V						NRB
2498.998	60.8	4.0	-11.5	53.4	Peak Max	V	99	195	74.0	-20.6	Pass	RB
17420.842	43.1	12.4	1.4	56.9	Peak Max	V	99	100	74	-17.1	Pass	Noise Floor
2498.998	59.2	4.0	-11.5	51.8	Average Max	V	99	195	54.0	-2.2	Pass	RB
17420.842	29.9	12.4	1.4	43.6	Average Max	V	99	100	54	-10.4	Pass	Noise Floor

Legend: TX = Transmitter Emissions; DIG = Digital Emissions; FUND = Fundamental; WB = Wideband Emission
 NRB = Non-Restricted Band. Limit = 68.23 dBuV/m; RB = Restricted Band. Limits per 15.205

This test report may be reproduced in full only. The document may only be updated by MiCOM Labs personnel. Any changes will be noted in the Document History section of the report.



Title: Xirrus Inc. XI-AC1300, XI-AC867 (non-DFS Bands)
To: FCC 47 CFR Part 15.407 & IC RSS-210
Serial #: XIRR04-U6 Rev A
Issue Date: 29th April 2014
Page: 66 of 199

Test Freq.	5240 MHz	Engineer	SB
Variant	802.11a; 6 Mbs	Temp (°C)	22.5
Freq. Range	1000 MHz - 18000 MHz	Rel. Hum.(%)	25
Power Setting	target	Press. (mBars)	1007
Antenna	integral	Duty Cycle (%)	100
Test Notes 1			
Test Notes 2			

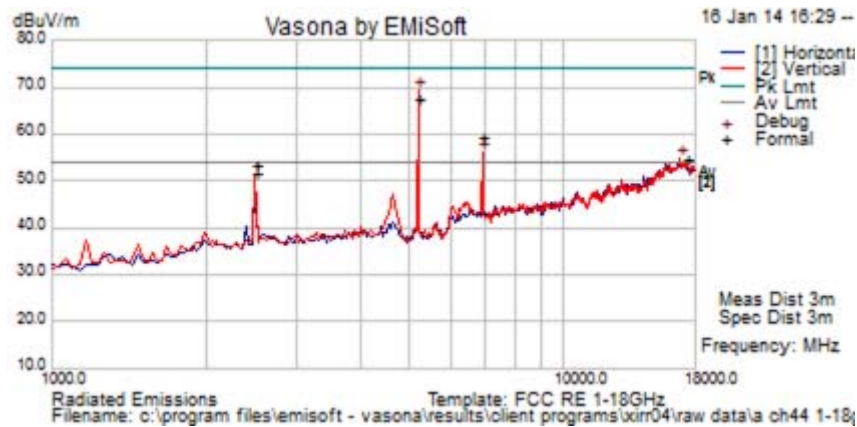

Formally measured emission peaks

Frequency MHz	Raw dBuV	Cable Loss	AF dB	Level dBuV/m	Measurement Type	Pol	Hgt cm	Azt Deg	Limit dBuV/m	Margin dB	Pass /Fail	Comments
5190.381	73.4	5.9	-9.9	69.4	Peak [Scan]	V						FUND
6927.85571	55.6	7.0	-6.5	56.1	Peak [Scan]	V						NRB
2498.998	60.8	4.0	-11.5	53.4	Peak Max	V	99	195	74.0	-20.6	Pass	RB
16807.615	43.1	12.4	1.4	56.9	Peak Max	V	99	100	74	-17.1	Pass	Noise Floor
2498.998	59.2	4.0	-11.5	51.8	Average Max	V	99	195	54.0	-2.2	Pass	RB
16807.615	29.9	12.4	1.4	43.6	Average Max	V	99	100	54	-10.4	Pass	Noise Floor

Legend: TX = Transmitter Emissions; DIG = Digital Emissions; FUND = Fundamental; WB = Wideband Emission
 NRB = Non-Restricted Band. Limit = 68.23 dBuV/m; RB = Restricted Band. Limits per 15.205

This test report may be reproduced in full only. The document may only be updated by MiCOM Labs personnel. Any changes will be noted in the Document History section of the report.



5.15 – 5.25 GHz Frequency Band

Peak Limit 74.0 dBµV, Peak Limit 54.0 dBµV

Integral Antenna

Operational Mode	5150 MHz		
	Peak	Average	Power Setting
a	61.45	48.19	Target
n HT-20	62.20	49.01	Target
n HT-40	61.06	47.19	Target
ac-40	59.78	47.34	Target
ac-80	64.64	51.04	Target

This test report may be reproduced in full only. The document may only be updated by MiCOM Labs personnel. Any changes will be noted in the Document History section of the report.



6.1.2.2. Digital Emissions (30M-1 GHz)

FCC, Part 15 Subpart C §15.205/ §15.209
Industry Canada RSS-210 §2.2

Test Procedure

Testing 30M-1 GHz was performed in a 3-meter anechoic chamber using a CISPR compliant receiver. Preliminary radiated emissions were measured on every azimuth and with the receiving antenna in both horizontal and vertical polarizations. To further maximize emissions the receive antenna was varied between 1 and 4 meters. The emissions are recorded with receiver in peak hold mode. Emissions closest to the limits are measured in the quasi-peak mode with the tuned receiver using a bandwidth of 120 kHz. Only the highest emissions relative to the limit are listed. The anechoic chamber test set-up is identified in Section 6 Test Set-Up Photographs.

The EUT had two methods of powering on ac/dc converter and Power over Ethernet (POE). Both modes were tested for emissions below 1GHz.

Field Strength Calculation

The field strength is calculated by adding the Antenna Factor and Cable Loss, and subtracting Amplifier Gain from the measured reading. In this test facility, the Antenna Factor, Cable Loss, and Amplifier Gains are loaded into the Rohde & Schwarz Receiver and the corrected field strength can be read directly on the receiver.

$$FS = R + AF + CORR$$

where:

FS = Field Strength
R = Measured Receiver Input Amplitude
AF = Antenna Factor
CORR = Correction Factor = CL – AG + NFL
CL = Cable Loss
AG = Amplifier Gain

For example:

Given a Receiver input reading of 51.5dB μ V; Antenna Factor of 8.5dB; Cable Loss of 1.3dB; Falloff Factor of 0dB, an Amplifier Gain of 26dB and Notch Filter Loss of 1dB. The Field Strength of the measured emission is:

$$FS = 51.5 + 8.5 + 1.3 - 26.0 + 1 = 36.3\text{dB}\mu\text{V/m}$$

Conversion between dB μ V/m (or dB μ V) and μ V/m (or μ V) are done as:

$$\text{Level (dB}\mu\text{V/m)} = 20 * \text{Log (level (\mu\text{V/m}))}$$

$$40 \text{ dB}\mu\text{V/m} = 100\mu\text{V/m}$$

$$48 \text{ dB}\mu\text{V/m} = 250\mu\text{V/m}$$

This test report may be reproduced in full only. The document may only be updated by MiCOM Labs personnel. Any changes will be noted in the Document History section of the report.



Title: Xirrus Inc. XI-AC1300, XI-AC867 (non-DFS Bands)
To: FCC 47 CFR Part 15.407 & IC RSS-210
Serial #: XIRR04-U6 Rev A
Issue Date: 29th April 2014
Page: 74 of 199

Test Freq.	2437 MHz	Engineer	SB
Variant	Digital Emissions	Temp (°C)	22.5
Freq. Range	30 MHz - 1000 MHz	Rel. Hum.(%)	25
Power Setting	Target	Press. (mBars)	1007
Antenna	Integral		
Test Notes 1			
Test Notes 2			

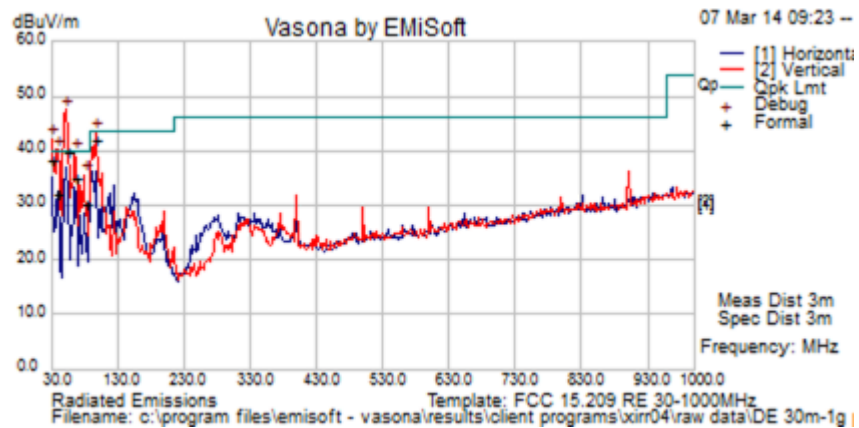

Formally measured emission peaks

Frequency MHz	Raw dBuV	Cable Loss	AF dB	Level dBuV/m	Measurement Type	Pol	Hgt cm	Azt Deg	Limit dBuV/m	Margin dB	Pass /Fail	Comments
54.139	60.1	3.7	-24.0	39.8	Quasi Max	V	103	212	40	-0.2	Pass	
30.000	44.4	3.5	-9.7	38.1	Quasi Max	V	109	35	40	-1.9	Pass	
37.776	44.3	3.6	-15.9	32.0	Quasi Max	V	123	83	40	-8.0	Pass	
97.252	60.0	4.1	-22.1	42.0	Quasi Max	V	98	27	43.5	-1.5	Pass	
66.608	54.5	3.8	-23.4	34.9	Quasi Max	V	115	303	40	-5.1	Pass	
80.025	49.7	3.9	-23.5	30.1	Quasi Max	V	143	77	40	-9.9	Pass	

Legend: DIG = Digital Device Emission; TX = Transmitter Emission; FUND = Fundamental Frequency
 NRB = Non-Restricted Band, Limit is 20 dB below Fundamental; RB = Restricted Band

This test report may be reproduced in full only. The document may only be updated by MiCOM Labs personnel. Any changes will be noted in the Document History section of the report.



Specification

Limits

§15.205 (a) Except as shown in paragraph (d) of 15.205 (a), only spurious emissions are permitted in any of the frequency bands listed.

§15.205 (a) Except as shown in paragraphs (d) and (e) of this section, the field strength of emissions appearing within these frequency bands shall not exceed the limits shown in Section §15.209. At frequencies equal to or less than 1000 MHz, compliance with the limits in Section 15.209 shall be demonstrated using measurement instrumentation employing a CISPR quasi-peak detector. Above 1000 MHz, compliance with the emission limits in Section 15.209 shall be demonstrated based on the average value of the measured emissions. The provisions in Section 15.35 apply to these measurements.

§15.209 (a) Except as provided elsewhere in this subpart, the emissions from an intentional radiator shall not exceed the field strength levels specified in the following table.

§15.209 (a) and RSS-Gen §2.2 Limit Matrix

Frequency(MHz)	Field Strength ($\mu\text{V/m}$)	Field Strength ($\text{dB}\mu\text{V/m}$)	Measurement Distance (meters)
30-88	100	40.0	3
88-216	150	43.5	3
216-960	200	46.0	3
Above 960	500	54.0	3

Laboratory Measurement Uncertainty for Radiated Emissions

Measurement uncertainty	+5.6/ -4.5 dB
-------------------------	---------------

Traceability

Method	Test Equipment Used
Measurements were made per work instruction WI-03 'Measurement of Radiated Emissions'	0088, 0158, 0134, 0304, 0311, 0315, 0310, 0312

This test report may be reproduced in full only. The document may only be updated by MiCOM Labs personnel. Any changes will be noted in the Document History section of the report.



Title: Xirrus Inc. XI-AC1300, XI-AC867 (non-DFS Bands)
To: FCC 47 CFR Part 15.407 & IC RSS-210
Serial #: XIRR04-U6 Rev A
Issue Date: 29th April 2014
Page: 76 of 199

6.1.3. AC Wireline Conducted Emissions (150 kHz – 30 MHz)

FCC, Part 15 Subpart C §15.207
Industry Canada RSS-Gen §7.2.2

Test Procedure

The EUT is configured in accordance with ANSI C63.4. The conducted emissions are measured in a shielded room with a spectrum analyzer in peak hold in the first instance. Emissions closest to the limit are measured in the quasi-peak mode (QP) with the tuned receiver using a bandwidth of 9 kHz. The emissions are maximized further by cable manipulation. The highest emissions relative to the limit are listed.

Measurement Results for AC Wireline Conducted Emissions (150 kHz – 30 MHz)

Ambient conditions.

Temperature: 17 to 23 °C Relative humidity: 31 to 57 % Pressure: 999 to 1012 mbar

This test report may be reproduced in full only. The document may only be updated by MiCOM Labs personnel. Any changes will be noted in the Document History section of the report.



Title: Xirrus Inc. XI-AC1300, XI-AC867 (non-DFS Bands)
To: FCC 47 CFR Part 15.407 & IC RSS-210
Serial #: XIRR04-U6 Rev A
Issue Date: 29th April 2014
Page: 77 of 199

Test Freq.	N/A	Engineer	JMH
Variant	AC Line Emissions	Temp (°C)	23
Freq. Range	0.150 MHz - 30 MHz	Rel. Hum.(%)	35
Power Setting	NA	Press. (mBars)	1008
Antenna	N/A		
Test Notes 1	EUT CHASSIS Model#XR-2426, SN#XR213470F09C9, PowerDsine Model 3501G POE		
Test Notes 2	230 Vac, 50 Hz		

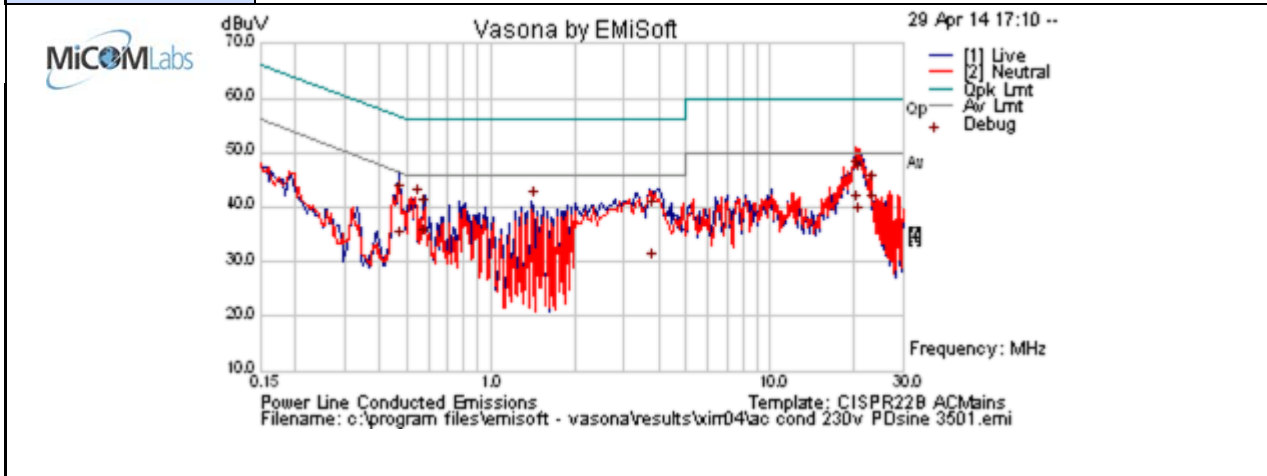

Formally measured emission peaks

Frequency MHz	Raw dBuV	Cable Loss	Factors dB	Level dBuV	Measurement Type	Line	Limit dBuV	Margin dB	Pass /Fail	Comments
0.469	24.0	9.9	0.1	34.0	Average	Live	46.5	-12.5	Pass	
0.469	32.5	9.9	0.1	42.5	Quasi Peak	Live	56.5	-14.0	Pass	
0.574	24.4	9.9	0.1	34.4	Average	Live	46.0	-11.6	Pass	
0.574	29.7	9.9	0.1	39.7	Quasi Peak	Live	56.0	-16.3	Pass	
3.743	29.3	10.1	0.2	39.6	Quasi Peak	Live	56.0	-16.4	Pass	
3.743	19.8	10.1	0.2	30.1	Average	Live	46.0	-16.0	Pass	
20.258	35.7	10.5	0.7	46.9	Quasi Peak	Neutral	60.0	-13.1	Pass	
20.258	29.1	10.5	0.7	40.4	Average	Neutral	50.0	-9.6	Pass	
20.648	27.1	10.5	0.8	38.4	Average	Live	50.0	-11.6	Pass	
20.648	35.0	10.5	0.8	46.3	Quasi Peak	Live	60.0	-13.8	Pass	
23.130	29.0	10.6	0.9	40.4	Average	Neutral	50.0	-9.6	Pass	
23.130	32.8	10.6	0.9	44.3	Quasi Peak	Neutral	60.0	-15.7	Pass	
0.539	31.7	9.9	0.1	41.7	Peak [Scan]	Neutral	46.0	-4.3	Pass	
1.411	31.1	10.0	0.1	41.1	Peak [Scan]	Live	46.0	-4.9	Pass	

Legend:	DIG = Digital Device Emission; TX = Transmitter Emission; FUND = Fundamental Frequency
	NRB = Non-Restricted Band, Limit is 20 dB below Fundamental; RB = Restricted Band

This test report may be reproduced in full only. The document may only be updated by MiCOM Labs personnel. Any changes will be noted in the Document History section of the report.



Specification

Limit

§15.207 (a) Except as shown in paragraphs (b) and (c) of this section, for an intentional radiator that is designed to be connected to the public utility (AC) power line, the radio frequency voltage that is conducted back onto the AC power line on any frequency or frequencies within the band 150 kHz to 30 MHz shall not exceed the limits in the following table, as measured using a 50 $\mu\Omega$ line impedance stabilization network (LISN), see §15.207 (a) matrix below. Compliance with the provisions of this paragraph shall be based on the measurement of the radio frequency voltage between each power line and ground at the power terminal.

RSS-Gen §7.2.2

The radio frequency voltage that is conducted back into the AC power lines in the frequency range of 0.15 MHz to 30 MHz shall not exceed the limits shown in the table below. The tighter limit applies at the frequency range boundaries.

§15.207 (a) and RSS-Gen §7.2.2 Limit Matrix

The lower limit applies at the boundary between frequency ranges

Frequency of Emission (MHz)	Conducted Limit (dB μ V)	
	Quasi-peak	Average
0.15-0.5	66 to 56*	56 to 46*
0.5-5	56	46
5-30	60	50

* Decreases with the logarithm of the frequency

Laboratory Measurement Uncertainty for Conducted Emissions

Measurement uncertainty	± 2.64 dB
-------------------------	---------------

Traceability

Method	Test Equipment Used
Measurements were made per work instruction WI-EMC-01 'Measurement of Conducted Emissions'	0158, 0184, 0287, 0190, 0293, 0307

7. PHOTOGRAPHS

7.1. Conducted Test Setup

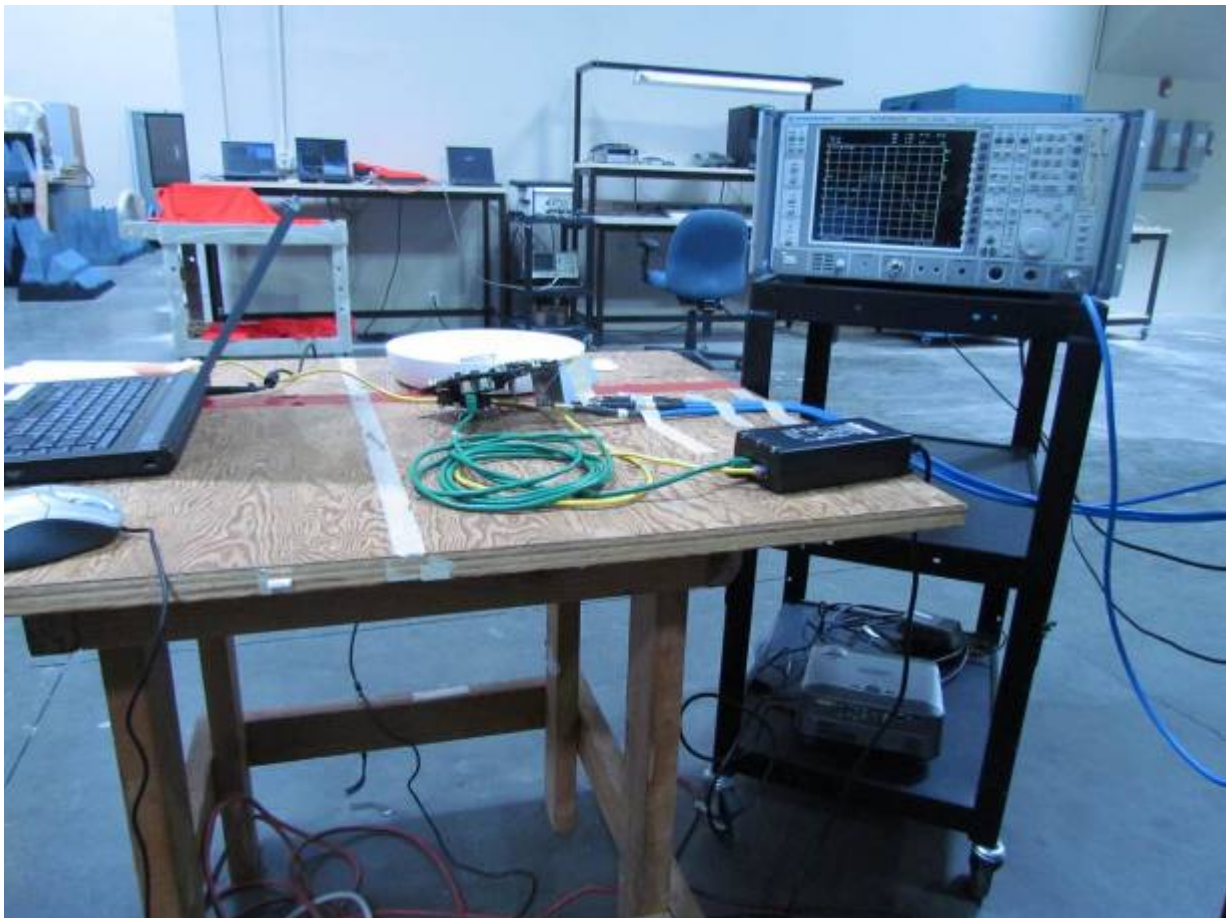

This test report may be reproduced in full only. The document may only be updated by MiCOM Labs personnel. Any changes will be noted in the Document History section of the report.

7.2. Test Setup - Digital Emissions below 1 GHz

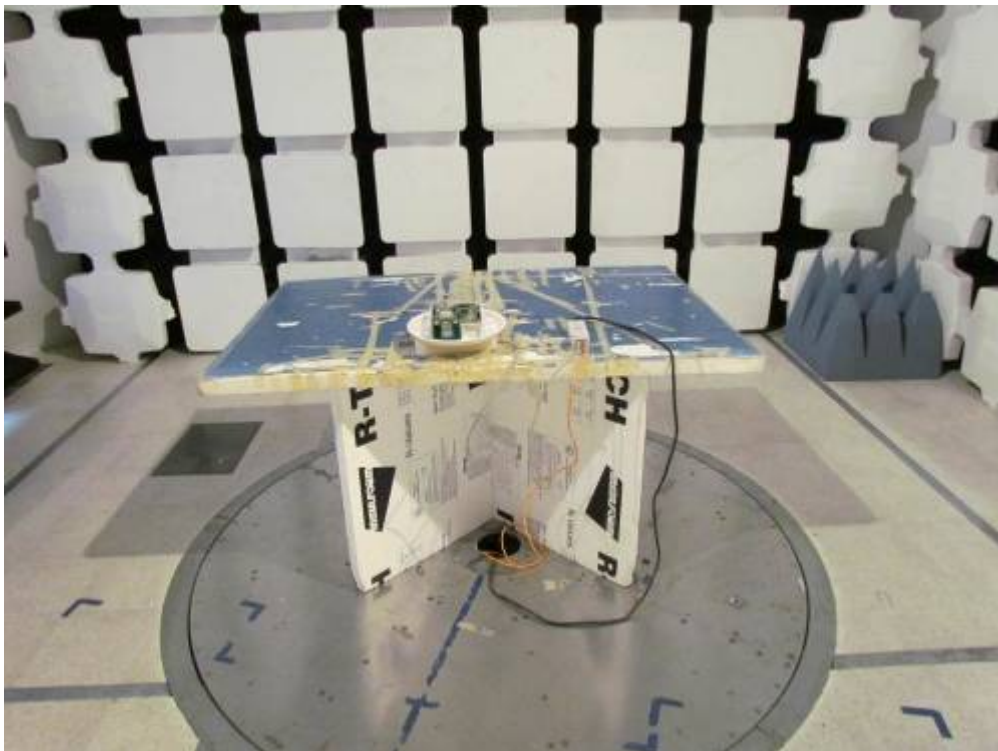

This test report may be reproduced in full only. The document may only be updated by MiCOM Labs personnel. Any changes will be noted in the Document History section of the report.

7.3. Radiated Emissions Test Setup >1 GHz

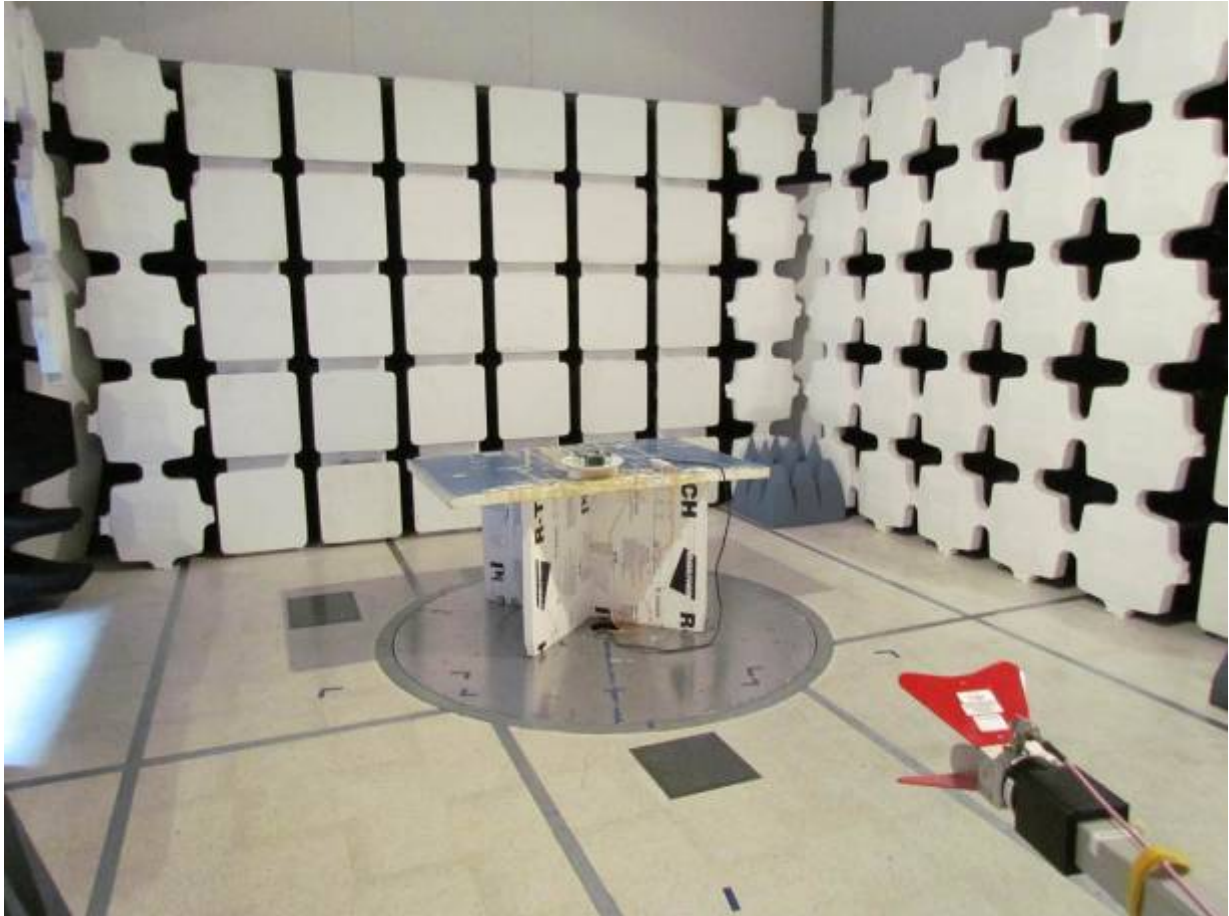

This test report may be reproduced in full only. The document may only be updated by MiCOM Labs personnel. Any changes will be noted in the Document History section of the report.



Title: Xirrus Inc. XI-AC1300, XI-AC867 (non-DFS Bands)
To: FCC 47 CFR Part 15.407 & IC RSS-210
Serial #: XIRR04-U6 Rev A
Issue Date: 29th April 2014
Page: 82 of 199

8. TEST EQUIPMENT DETAILS

Asset #	Instrument	Manufacturer	Part #	Serial #	Calibration Due Date
0117	Power Sensor	Hewlett Packard	8487D	3318A00371	18 th Oct 14
0223	Power Meter	Hewlett Packard	EPM-442A	US37480256	18 th Oct 14
0376	Power Sensor	Agilent	U2000A	MY51440005	28 th Oct 14
0390	Power Sensor	Agilent	U2002A	MY50000103	17 th Oct 14
0158	Barometer /Thermometer	Control Co.	4196	E2846	6 th Dec 14
0193	EMI Receiver	Rhode & Schwartz	ESI 7	838496/007	2 nd Dec 14
0287	EMI Receiver	Rhode & Schwartz	ESIB40	100201	31 st Jul 14
0378	EMI Receiver	Rhode & Schwartz	ESIB40	100107/040	17 th Jul 14
0338	30 - 3000 MHz Antenna	Sunol	JB3	A052907	14 th Aug 14
0399	1-18 GHz Horn Antenna	EMCO	3117	00154575	10 th Oct 14
0252	SMA Cable	Megaphase	Sucoflex 104	None	N/A
0310	2m SMA Cable	Micro-Coax	UFA210A-0-0787-3G03G0	209089-001	N/A
0312	3m SMA Cable	Micro-Coax	UFA210A-1-1181-3G0300	209092-001	N/A
0314	30dB N-Type Attenuator	ARRA	N9444-30	1623	N/A
0359	DFS Test System	Aeroflex	PXI-1042	300001/004	21 st Oct 14
0299	DFS Test Software	Aeroflex	PXI Module	Version 7.1.0	N/A
0502	EMC Test Software	EMISoft	Vasona	5.0051	N/A
0503	RF Conducted Test Software	National Instruments	Labview	Version 8.2	N/A
0398	RF Conducted Test Software	MiCOM Labs ATS	--	Version 1.8	N/A
0380	RF Switch	MiCOM Labs	MIC001	MIC001	20 th March 14

This test report may be reproduced in full only. The document may only be updated by MiCOM Labs personnel. Any changes will be noted in the Document History section of the report.



Title: Xirrus Inc. XI-AC1300, XI-AC867 (non-DFS Bands)
To: FCC 47 CFR Part 15.407 & IC RSS-210
Serial #: XIRR04-U6 Rev A
Issue Date: 29th April 2014
Page: 83 of 199

APPENDIX

A. SUPPORTING INFORMATION

A.1. 3x3 CONDUCTED TEST PLOTS

This test report may be reproduced in full only. The document may only be updated by MiCOM Labs personnel. Any changes will be noted in the Document History section of the report.



A.1.1. 26 dB & 99% Bandwidth



26 dB & 99% BANDWIDTH

Variant: 802.11a, Channel: 5180.00 MHz, Chain a, Temp: Ambient, Voltage: 56 Vdc

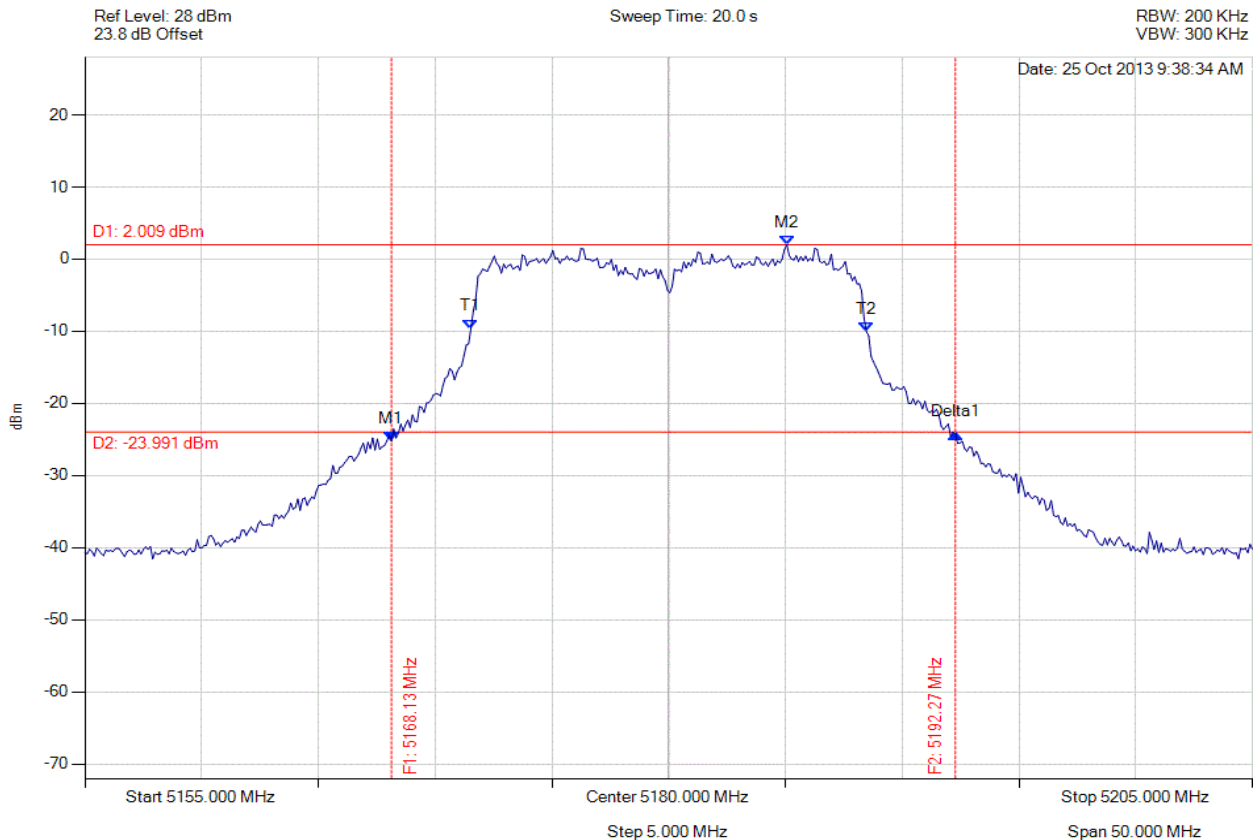

Analyser Setup	Marker : Frequency : Amplitude	Test Results
Detector = MAX PEAK Sweep Count = 0 RF Atten (dB) = 20 Trace Mode = VIEW	M1 : 5168.126 MHz : -25.252 dBm M2 : 5185.060 MHz : 2.009 dBm Delta1 : 24.148 MHz : 1.062 dB T1 : 5171.533 MHz : -9.628 dBm T2 : 5188.467 MHz : -9.999 dBm OBW : 16.934 MHz	Measured 26 dB Bandwidth: 24.148 MHz Measured 99% Bandwidth: 16.934 MHz

[Back to the Matrix](#)

This test report may be reproduced in full only. The document may only be updated by MiCOM Labs personnel. Any changes will be noted in the Document History section of the report.



Title: Xirrus Inc. XI-AC1300, XI-AC867 (non-DFS Bands)
To: FCC 47 CFR Part 15.407 & IC RSS-210
Serial #: XIRR04-U6 Rev A
Issue Date: 29th April 2014
Page: 85 of 199



26 dB & 99% BANDWIDTH

Variant: 802.11a, Channel: 5180.00 MHz, Chain b, Temp: Ambient, Voltage: 56 Vdc

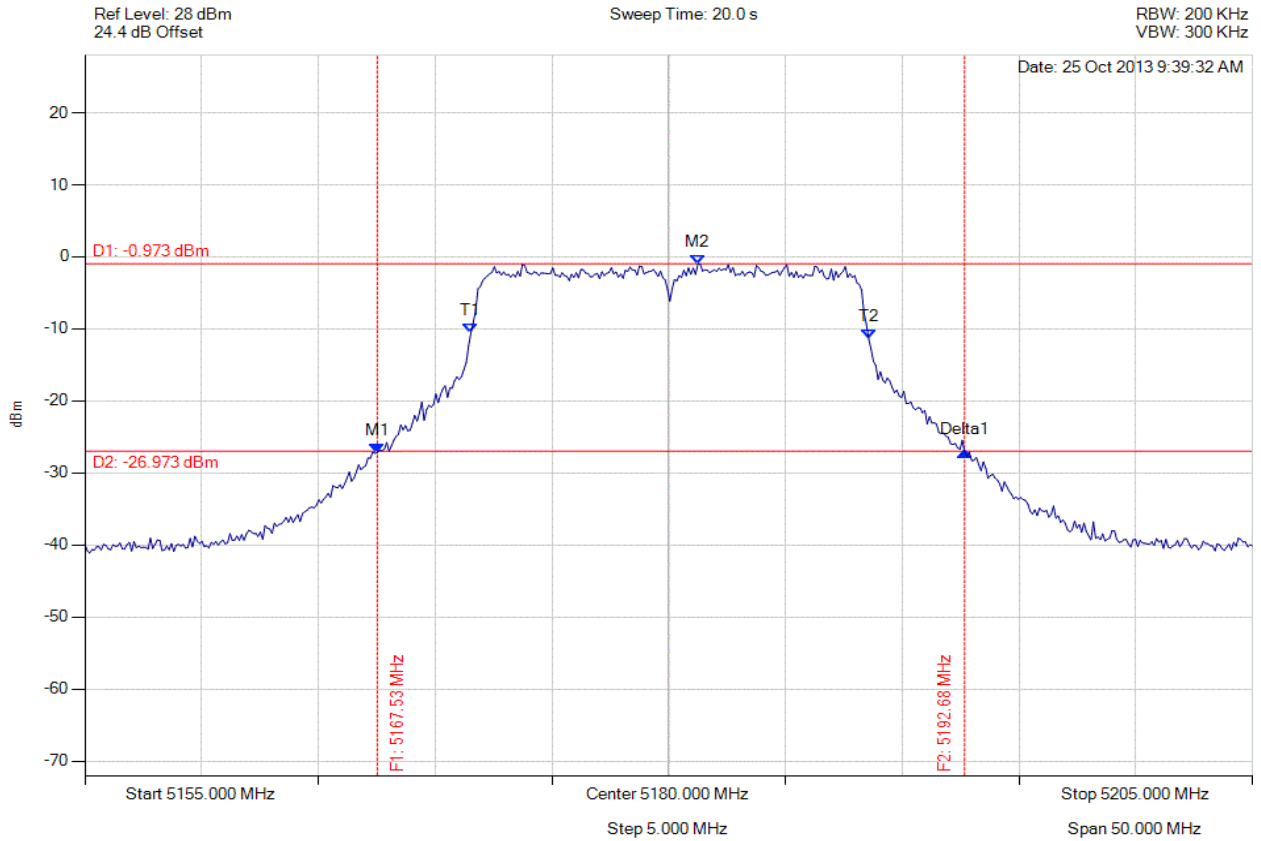

Analyser Setup	Marker : Frequency : Amplitude	Test Results
Detector = MAX PEAK Sweep Count = 0 RF Atten (dB) = 20 Trace Mode = VIEW	M1 : 5167.525 MHz : -27.212 dBm M2 : 5181.253 MHz : -0.973 dBm Delta1 : 25.150 MHz : 0.136 dB T1 : 5171.533 MHz : -10.546 dBm T2 : 5188.567 MHz : -11.414 dBm OBW : 17.034 MHz	Measured 26 dB Bandwidth: 25.150 MHz Measured 99% Bandwidth: 17.034 MHz

[Back to the Matrix](#)

This test report may be reproduced in full only. The document may only be updated by MiCOM Labs personnel. Any changes will be noted in the Document History section of the report.



Title: Xirrus Inc. XI-AC1300, XI-AC867 (non-DFS Bands)
To: FCC 47 CFR Part 15.407 & IC RSS-210
Serial #: XIRR04-U6 Rev A
Issue Date: 29th April 2014
Page: 86 of 199



26 dB & 99% BANDWIDTH

Variant: 802.11a, Channel: 5180.00 MHz, Chain c, Temp: Ambient, Voltage: 56 Vdc

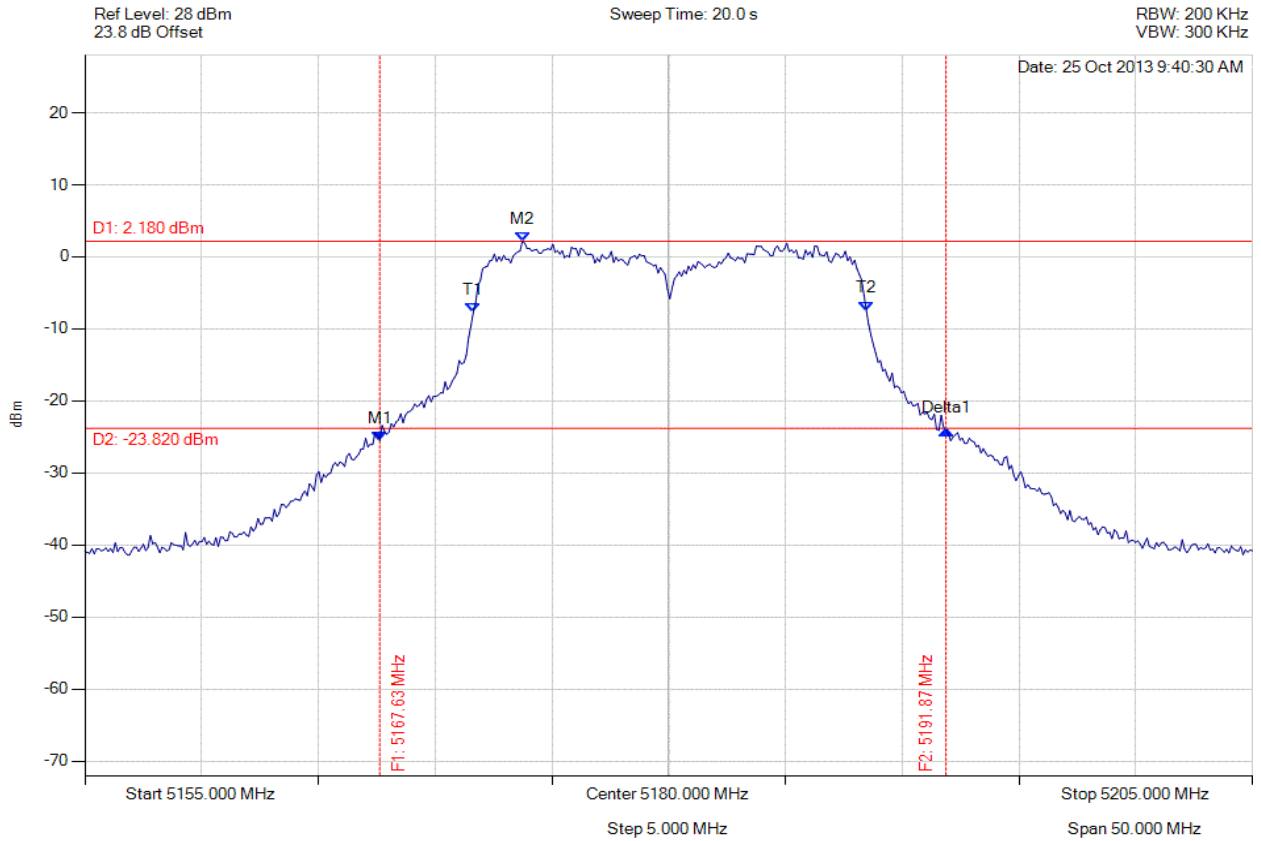

Analyser Setup	Marker : Frequency : Amplitude	Test Results
Detector = MAX PEAK Sweep Count = 0 RF Atten (dB) = 20 Trace Mode = VIEW	M1 : 5167.625 MHz : -25.504 dBm M2 : 5173.737 MHz : 2.180 dBm Delta1 : 24.248 MHz : 1.515 dB T1 : 5171.633 MHz : -7.674 dBm T2 : 5188.467 MHz : -7.460 dBm OBW : 16.834 MHz	Measured 26 dB Bandwidth: 24.248 MHz Measured 99% Bandwidth: 16.834 MHz

[Back to the Matrix](#)

This test report may be reproduced in full only. The document may only be updated by MiCOM Labs personnel. Any changes will be noted in the Document History section of the report.



Title: Xirrus Inc. XI-AC1300, XI-AC867 (non-DFS Bands)
To: FCC 47 CFR Part 15.407 & IC RSS-210
Serial #: XIRR04-U6 Rev A
Issue Date: 29th April 2014
Page: 87 of 199



26 dB & 99% BANDWIDTH

Variant: 802.11a, Channel: 5200.00 MHz, Chain a, Temp: Ambient, Voltage: 56 Vdc

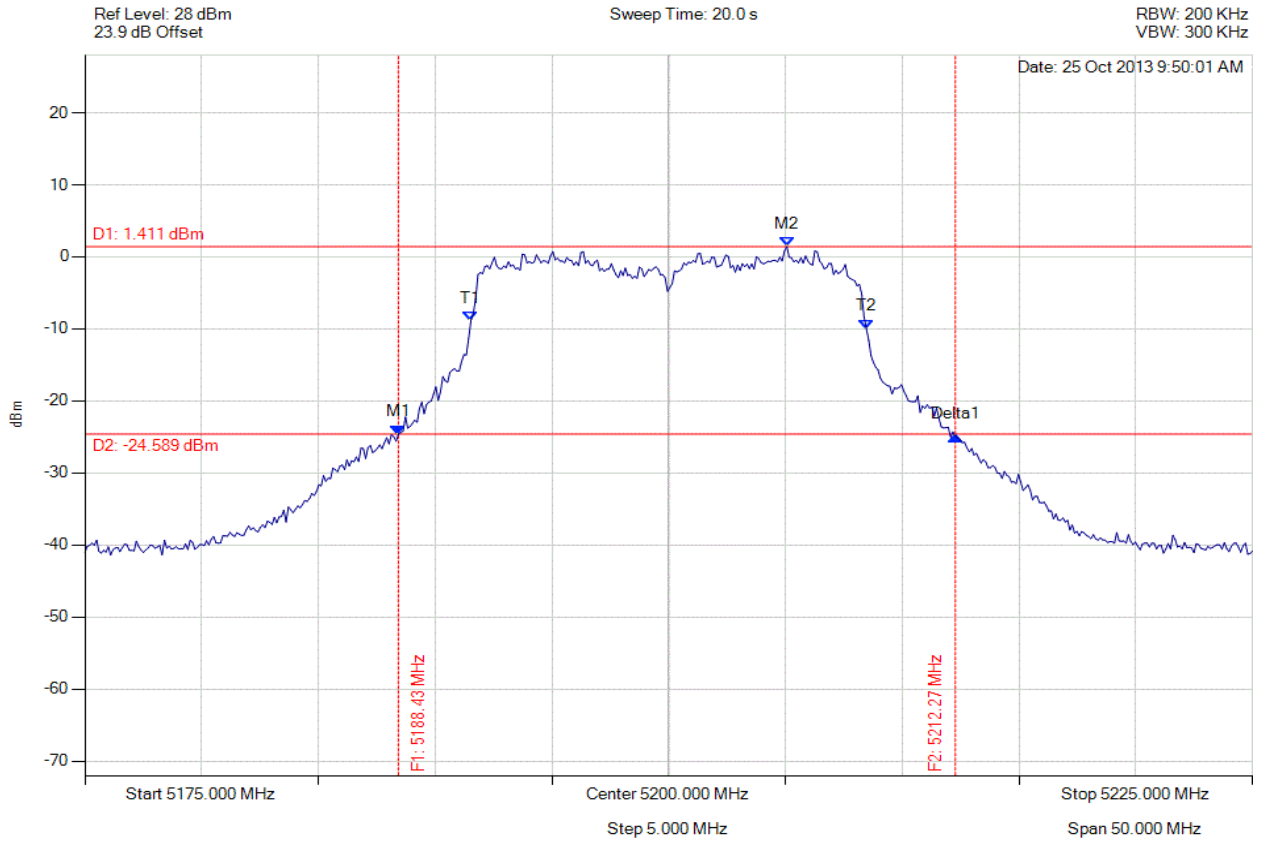

Analyser Setup	Marker : Frequency : Amplitude	Test Results
Detector = MAX PEAK Sweep Count = 0 RF Atten (dB) = 20 Trace Mode = VIEW	M1 : 5188.427 MHz : -24.633 dBm M2 : 5205.060 MHz : 1.411 dBm Delta1 : 23.848 MHz : -0.242 dB T1 : 5191.533 MHz : -8.892 dBm T2 : 5208.467 MHz : -9.968 dBm OBW : 16.934 MHz	Measured 26 dB Bandwidth: 23.848 MHz Measured 99% Bandwidth: 16.934 MHz

[Back to the Matrix](#)

This test report may be reproduced in full only. The document may only be updated by MiCOM Labs personnel. Any changes will be noted in the Document History section of the report.



Title: Xirrus Inc. XI-AC1300, XI-AC867 (non-DFS Bands)
To: FCC 47 CFR Part 15.407 & IC RSS-210
Serial #: XIRR04-U6 Rev A
Issue Date: 29th April 2014
Page: 88 of 199



26 dB & 99% BANDWIDTH

Variant: 802.11a, Channel: 5200.00 MHz, Chain b, Temp: Ambient, Voltage: 56 Vdc

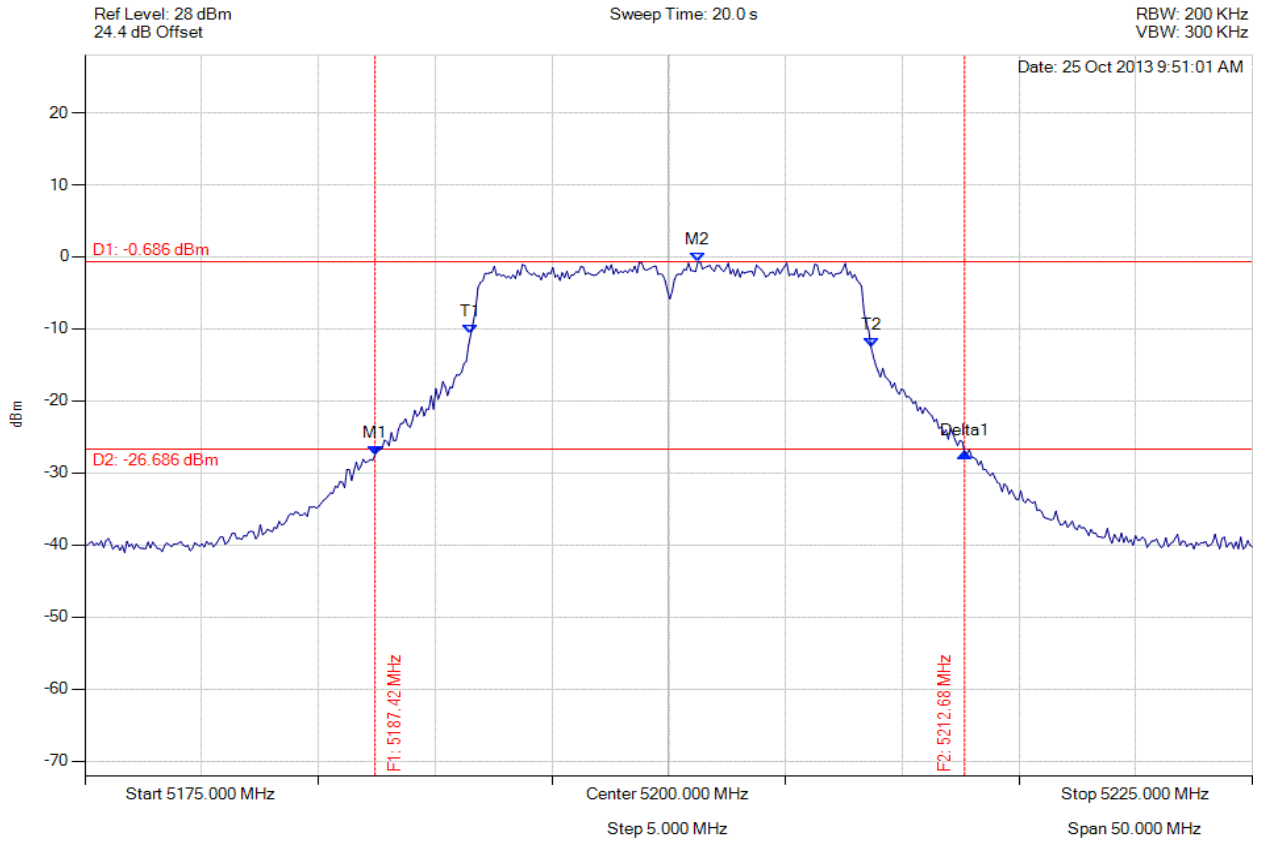

Analyser Setup	Marker : Frequency : Amplitude	Test Results
Detector = MAX PEAK Sweep Count = 0 RF Atten (dB) = 20 Trace Mode = VIEW	M1 : 5187.425 MHz : -27.485 dBm M2 : 5201.253 MHz : -0.686 dBm Delta1 : 25.251 MHz : 0.281 dB T1 : 5191.533 MHz : -10.668 dBm T2 : 5208.667 MHz : -12.541 dBm OBW : 17.134 MHz	Measured 26 dB Bandwidth: 25.251 MHz Measured 99% Bandwidth: 17.134 MHz

[Back to the Matrix](#)

This test report may be reproduced in full only. The document may only be updated by MiCOM Labs personnel. Any changes will be noted in the Document History section of the report.



Title: Xirrus Inc. XI-AC1300, XI-AC867 (non-DFS Bands)
To: FCC 47 CFR Part 15.407 & IC RSS-210
Serial #: XIRR04-U6 Rev A
Issue Date: 29th April 2014
Page: 89 of 199



26 dB & 99% BANDWIDTH

Variant: 802.11a, Channel: 5200.00 MHz, Chain c, Temp: Ambient, Voltage: 56 Vdc

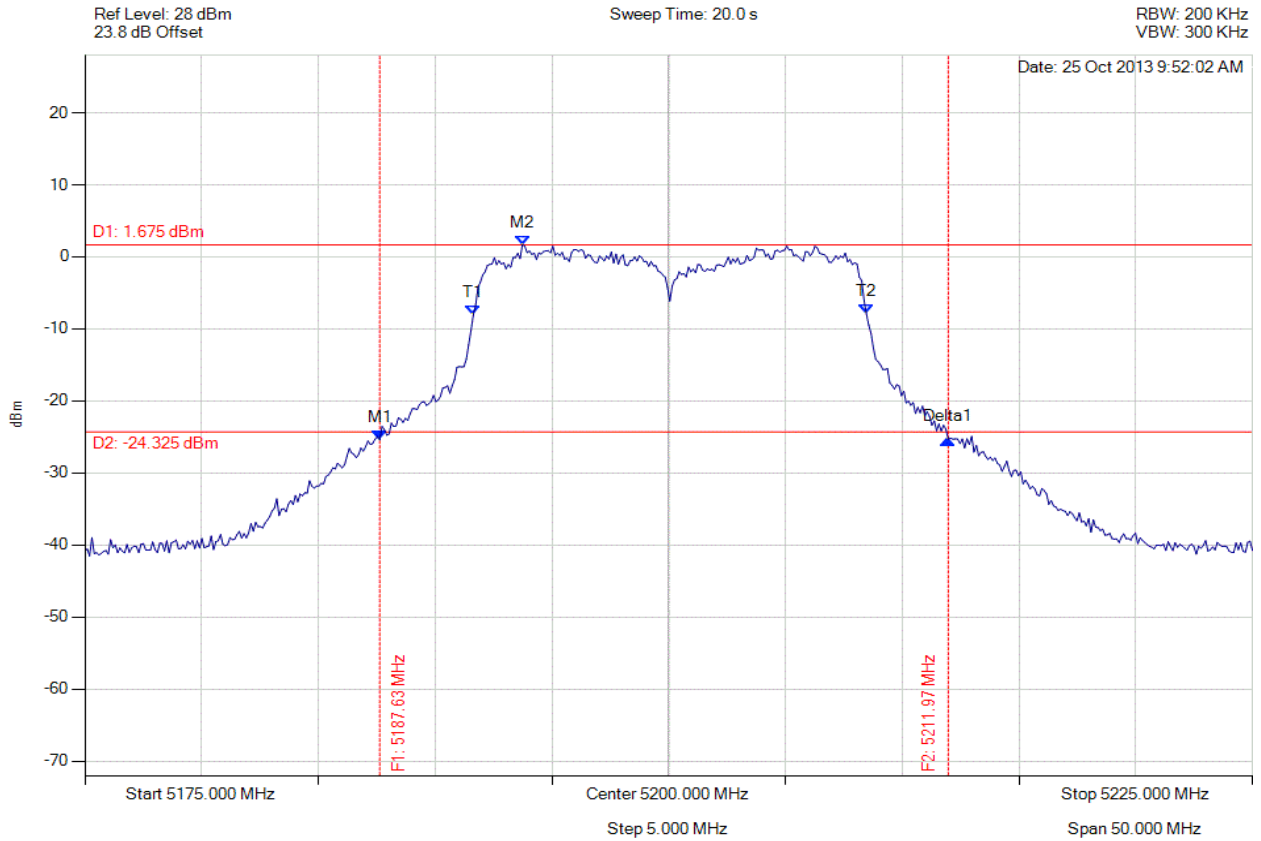

Analyser Setup	Marker : Frequency : Amplitude	Test Results
Detector = MAX PEAK Sweep Count = 0 RF Atten (dB) = 20 Trace Mode = VIEW	M1 : 5187.625 MHz : -25.402 dBm M2 : 5193.737 MHz : 1.675 dBm Delta1 : 24.349 MHz : 0.094 dB T1 : 5191.633 MHz : -8.103 dBm T2 : 5208.467 MHz : -7.900 dBm OBW : 16.834 MHz	Measured 26 dB Bandwidth: 24.349 MHz Measured 99% Bandwidth: 16.834 MHz

[Back to the Matrix](#)

This test report may be reproduced in full only. The document may only be updated by MiCOM Labs personnel. Any changes will be noted in the Document History section of the report.



Title: Xirrus Inc. XI-AC1300, XI-AC867 (non-DFS Bands)
To: FCC 47 CFR Part 15.407 & IC RSS-210
Serial #: XIRR04-U6 Rev A
Issue Date: 29th April 2014
Page: 90 of 199



26 dB & 99% BANDWIDTH

Variant: 802.11a, Channel: 5240.00 MHz, Chain a, Temp: Ambient, Voltage: 56 Vdc

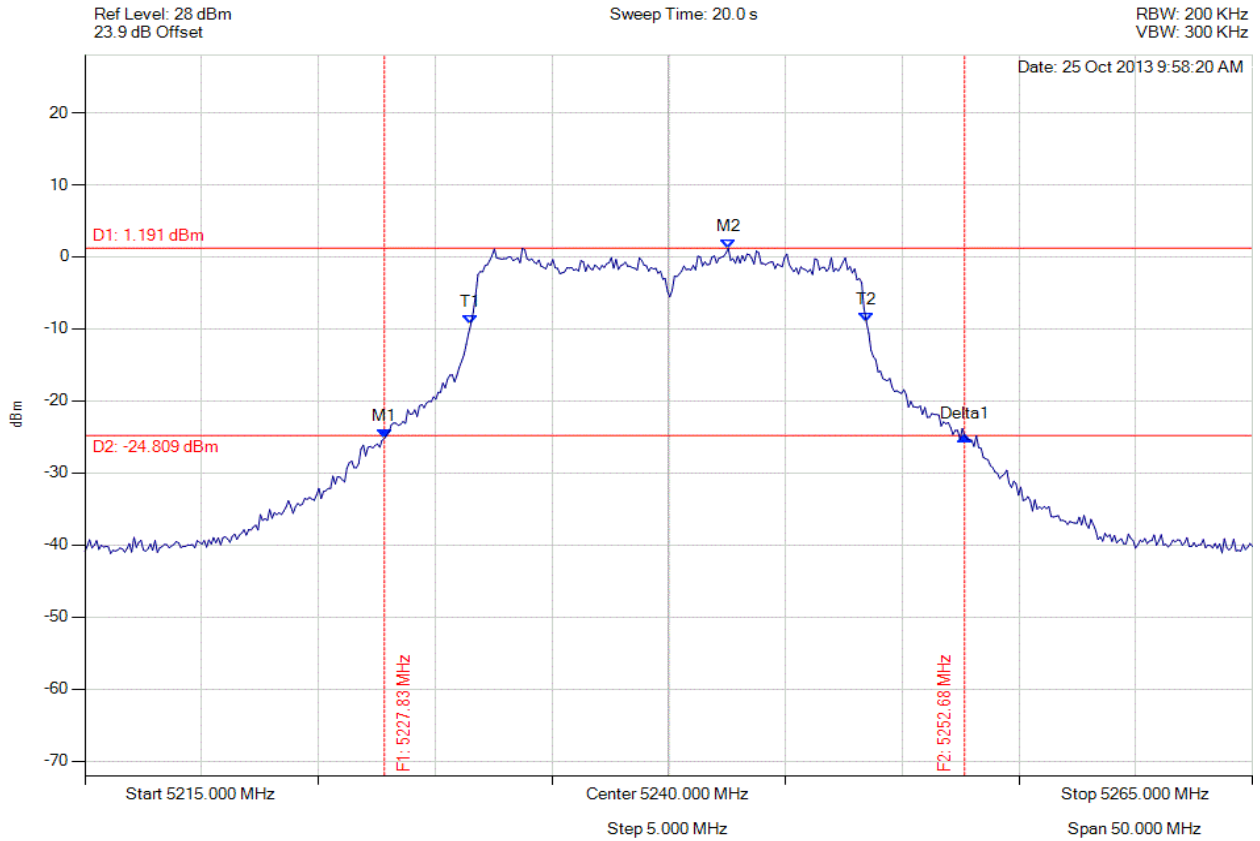

Analyser Setup	Marker : Frequency : Amplitude	Test Results
Detector = MAX PEAK Sweep Count = 0 RF Atten (dB) = 20 Trace Mode = VIEW	M1 : 5227.826 MHz : -25.231 dBm M2 : 5242.555 MHz : 1.191 dBm Delta1 : 24.850 MHz : 0.390 dB T1 : 5231.533 MHz : -9.342 dBm T2 : 5248.467 MHz : -9.010 dBm OBW : 16.934 MHz	Measured 26 dB Bandwidth: 24.850 MHz Measured 99% Bandwidth: 16.934 MHz

[Back to the Matrix](#)

This test report may be reproduced in full only. The document may only be updated by MiCOM Labs personnel. Any changes will be noted in the Document History section of the report.



Title: Xirrus Inc. XI-AC1300, XI-AC867 (non-DFS Bands)
To: FCC 47 CFR Part 15.407 & IC RSS-210
Serial #: XIRR04-U6 Rev A
Issue Date: 29th April 2014
Page: 91 of 199



26 dB & 99% BANDWIDTH

Variant: 802.11a, Channel: 5240.00 MHz, Chain b, Temp: Ambient, Voltage: 56 Vdc

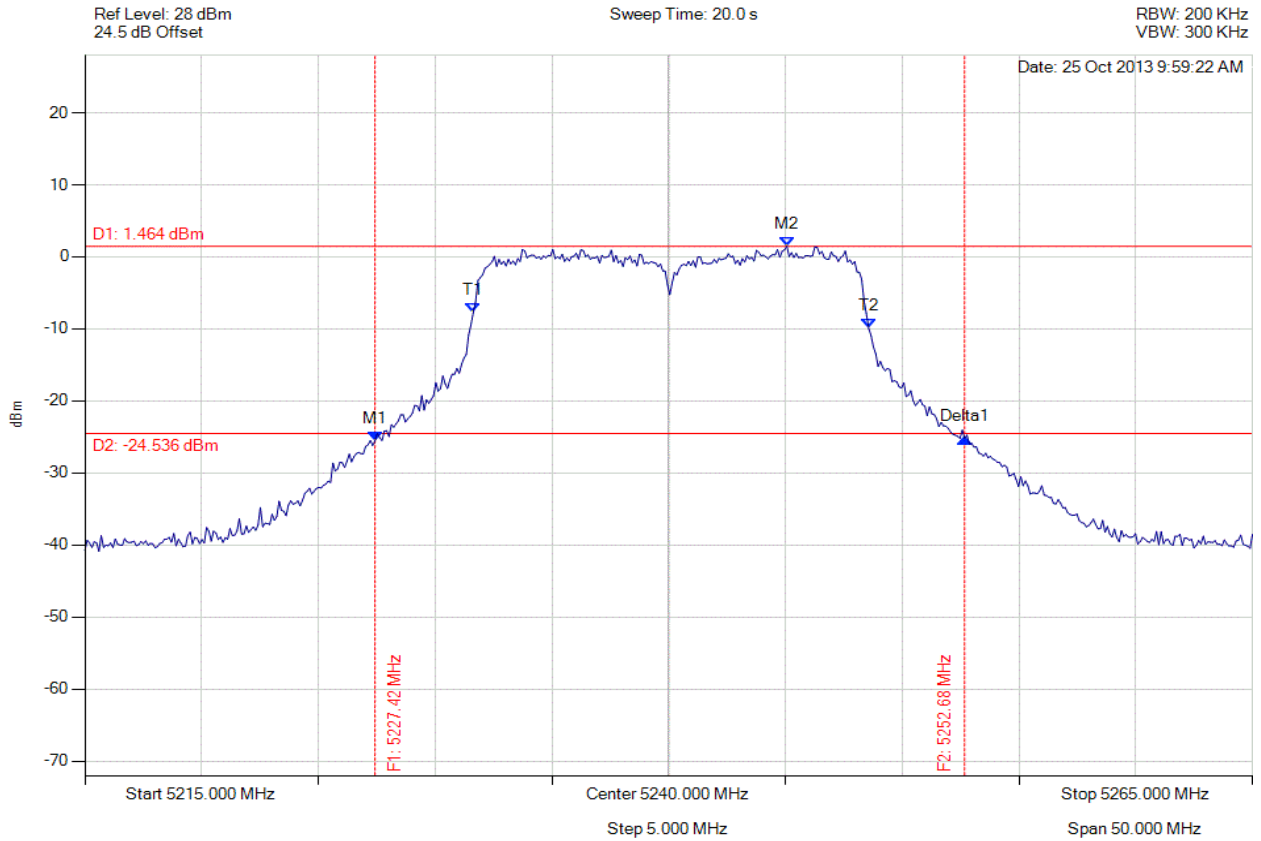

Analyser Setup	Marker : Frequency : Amplitude	Test Results
Detector = MAX PEAK Sweep Count = 0 RF Atten (dB) = 20 Trace Mode = VIEW	M1 : 5227.425 MHz : -25.522 dBm M2 : 5245.060 MHz : 1.464 dBm Delta1 : 25.251 MHz : 0.321 dB T1 : 5231.633 MHz : -7.727 dBm T2 : 5248.567 MHz : -9.944 dBm OBW : 16.934 MHz	Measured 26 dB Bandwidth: 25.251 MHz Measured 99% Bandwidth: 16.934 MHz

[Back to the Matrix](#)

This test report may be reproduced in full only. The document may only be updated by MiCOM Labs personnel. Any changes will be noted in the Document History section of the report.



Title: Xirrus Inc. XI-AC1300, XI-AC867 (non-DFS Bands)
To: FCC 47 CFR Part 15.407 & IC RSS-210
Serial #: XIRR04-U6 Rev A
Issue Date: 29th April 2014
Page: 92 of 199



26 dB & 99% BANDWIDTH

Variant: 802.11a, Channel: 5240.00 MHz, Chain c, Temp: Ambient, Voltage: 56 Vdc

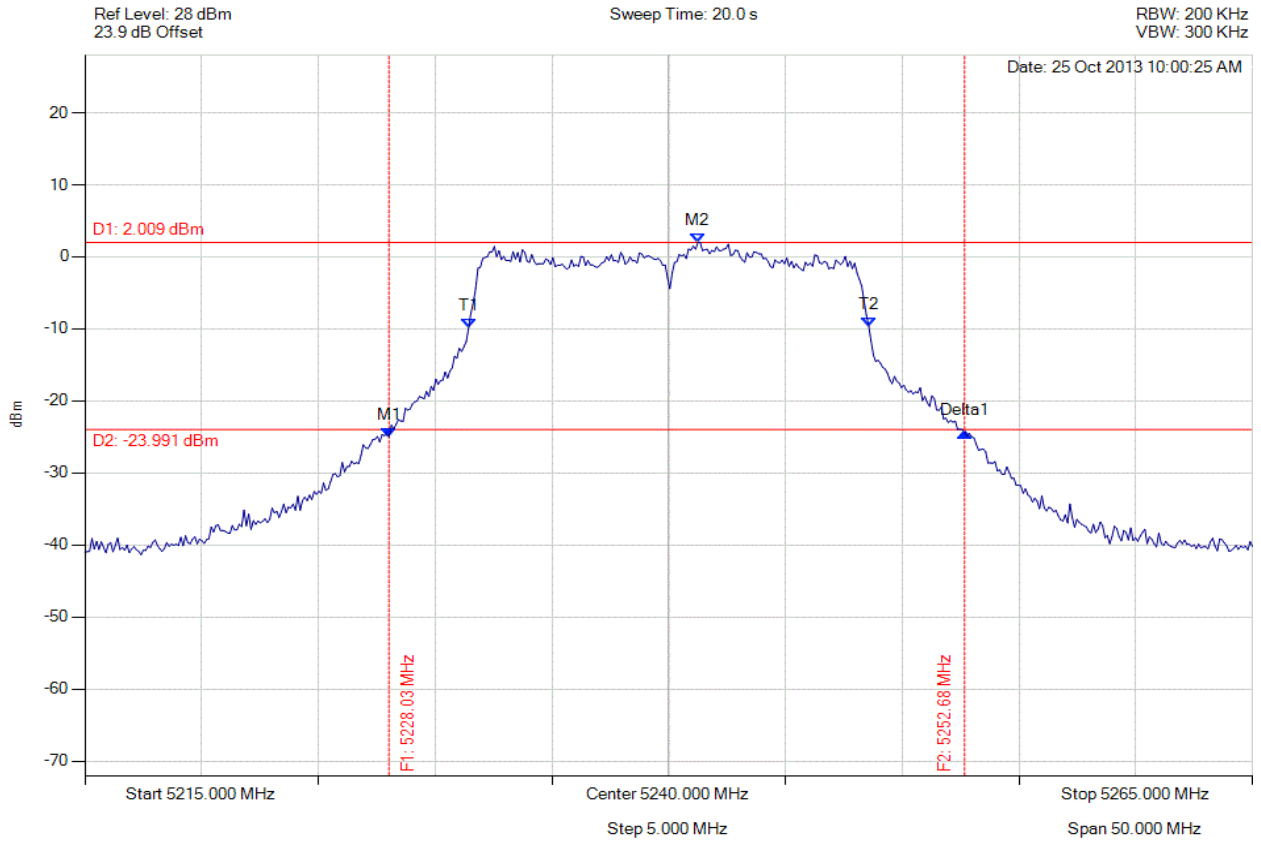

Analyser Setup	Marker : Frequency : Amplitude	Test Results
Detector = MAX PEAK Sweep Count = 0 RF Atten (dB) = 20 Trace Mode = VIEW	M1 : 5228.026 MHz : -24.983 dBm M2 : 5241.253 MHz : 2.009 dBm Delta1 : 24.649 MHz : 0.606 dB T1 : 5231.433 MHz : -9.838 dBm T2 : 5248.567 MHz : -9.645 dBm OBW : 17.134 MHz	Measured 26 dB Bandwidth: 24.649 MHz Measured 99% Bandwidth: 17.134 MHz

[Back to the Matrix](#)

This test report may be reproduced in full only. The document may only be updated by MiCOM Labs personnel. Any changes will be noted in the Document History section of the report.



Title: Xirrus Inc. XI-AC1300, XI-AC867 (non-DFS Bands)
To: FCC 47 CFR Part 15.407 & IC RSS-210
Serial #: XIRR04-U6 Rev A
Issue Date: 29th April 2014
Page: 93 of 199



26 dB & 99% BANDWIDTH

Variant: 802.11n HT-20, Channel: 5180.00 MHz, Chain a, Temp: Ambient, Voltage: 56 Vdc

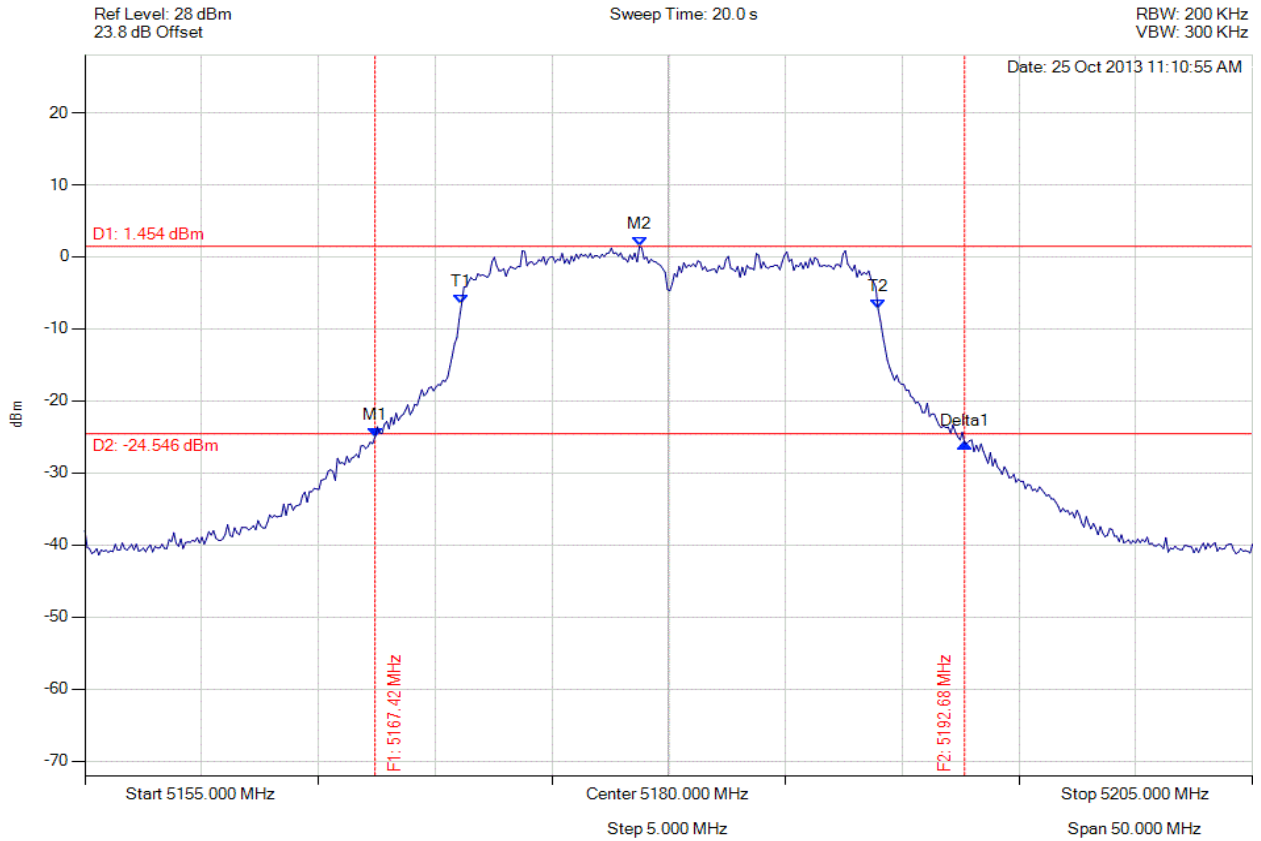

Analyser Setup	Marker : Frequency : Amplitude	Test Results
Detector = MAX PEAK Sweep Count = 0 RF Atten (dB) = 20 Trace Mode = VIEW	M1 : 5167.425 MHz : -24.983 dBm M2 : 5178.747 MHz : 1.454 dBm Delta1 : 25.251 MHz : -0.925 dB T1 : 5171.132 MHz : -6.553 dBm T2 : 5188.968 MHz : -7.273 dBm OBW : 17.836 MHz	Measured 26 dB Bandwidth: 25.251 MHz Measured 99% Bandwidth: 17.836 MHz

[Back to the Matrix](#)

This test report may be reproduced in full only. The document may only be updated by MiCOM Labs personnel. Any changes will be noted in the Document History section of the report.



Title: Xirrus Inc. XI-AC1300, XI-AC867 (non-DFS Bands)
To: FCC 47 CFR Part 15.407 & IC RSS-210
Serial #: XIRR04-U6 Rev A
Issue Date: 29th April 2014
Page: 94 of 199



26 dB & 99% BANDWIDTH

Variant: 802.11n HT-20, Channel: 5180.00 MHz, Chain b, Temp: Ambient, Voltage: 56 Vdc

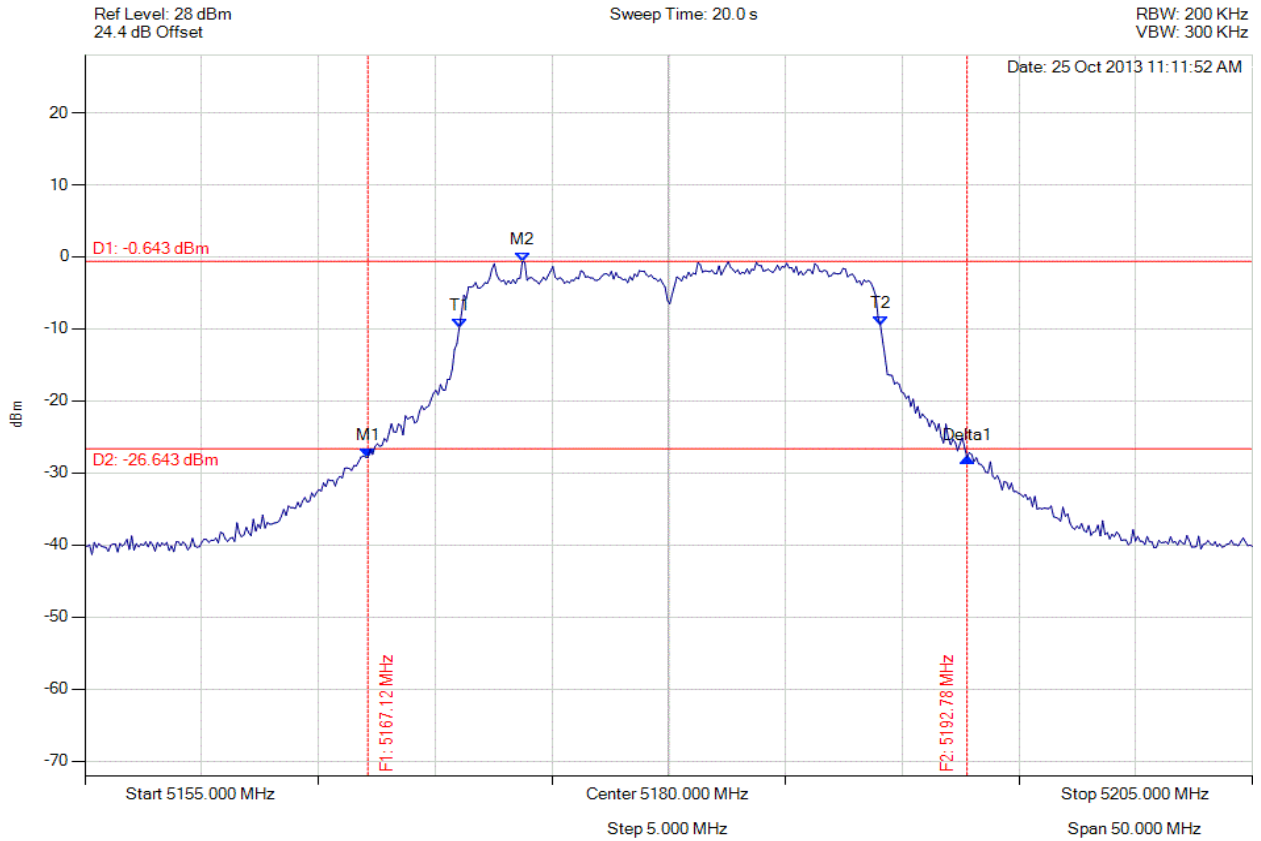

Analyser Setup	Marker : Frequency : Amplitude	Test Results
Detector = MAX PEAK Sweep Count = 0 RF Atten (dB) = 20 Trace Mode = VIEW	M1 : 5167.124 MHz : -27.851 dBm M2 : 5173.737 MHz : -0.643 dBm Delta1 : 25.651 MHz : 0.022 dB T1 : 5171.032 MHz : -9.836 dBm T2 : 5189.068 MHz : -9.535 dBm OBW : 18.036 MHz	Measured 26 dB Bandwidth: 25.651 MHz Measured 99% Bandwidth: 18.036 MHz

[Back to the Matrix](#)

This test report may be reproduced in full only. The document may only be updated by MiCOM Labs personnel. Any changes will be noted in the Document History section of the report.



Title: Xirrus Inc. XI-AC1300, XI-AC867 (non-DFS Bands)
To: FCC 47 CFR Part 15.407 & IC RSS-210
Serial #: XIRR04-U6 Rev A
Issue Date: 29th April 2014
Page: 95 of 199



26 dB & 99% BANDWIDTH

Variant: 802.11n HT-20, Channel: 5180.00 MHz, Chain c, Temp: Ambient, Voltage: 56 Vdc

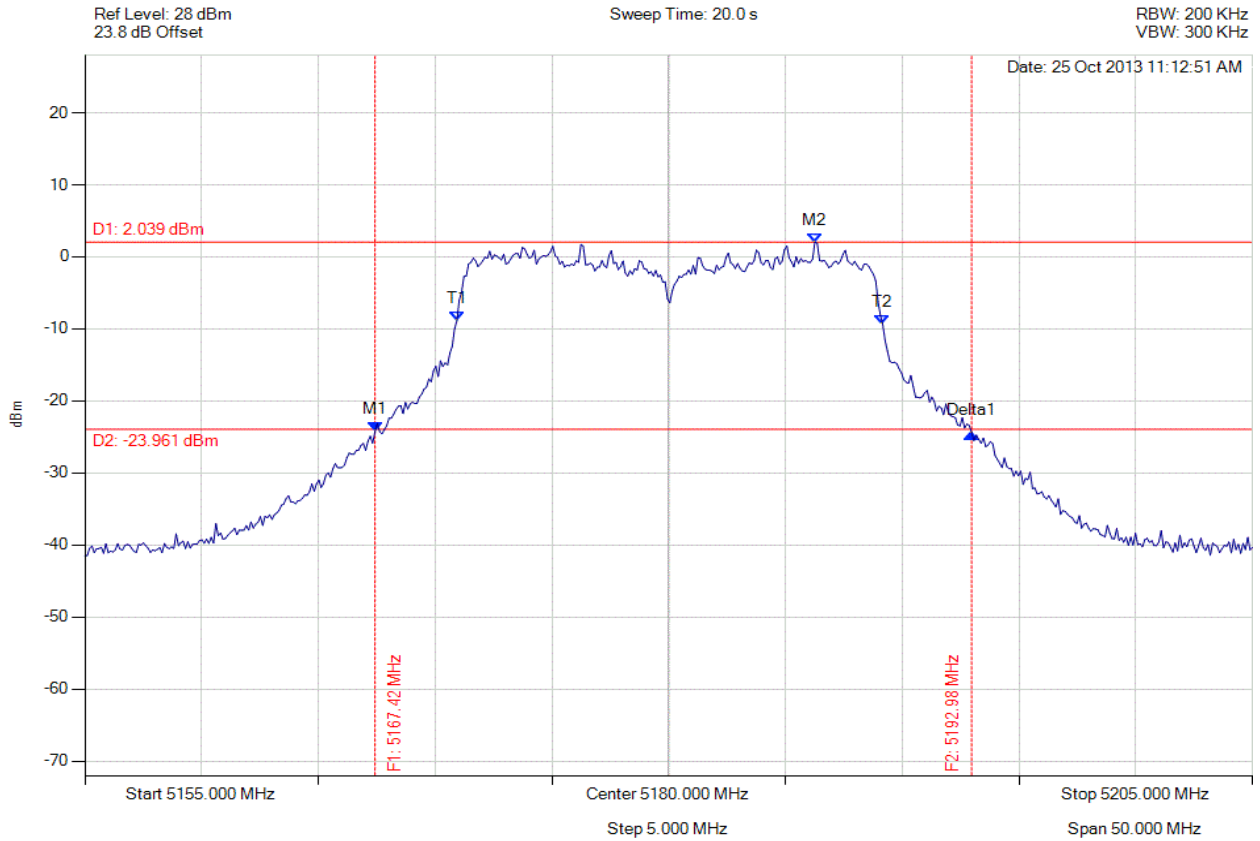

Analyser Setup	Marker : Frequency : Amplitude	Test Results
Detector = MAX PEAK Sweep Count = 0 RF Atten (dB) = 20 Trace Mode = VIEW	M1 : 5167.425 MHz : -24.227 dBm M2 : 5186.263 MHz : 2.039 dBm Delta1 : 25.551 MHz : -0.244 dB T1 : 5170.932 MHz : -8.837 dBm T2 : 5189.168 MHz : -9.437 dBm OBW : 18.236 MHz	Measured 26 dB Bandwidth: 25.551 MHz Measured 99% Bandwidth: 18.236 MHz

[Back to the Matrix](#)

This test report may be reproduced in full only. The document may only be updated by MiCOM Labs personnel. Any changes will be noted in the Document History section of the report.



Title: Xirrus Inc. XI-AC1300, XI-AC867 (non-DFS Bands)
To: FCC 47 CFR Part 15.407 & IC RSS-210
Serial #: XIRR04-U6 Rev A
Issue Date: 29th April 2014
Page: 96 of 199



26 dB & 99% BANDWIDTH

Variant: 802.11n HT-20, Channel: 5200.00 MHz, Chain a, Temp: Ambient, Voltage: 56 Vdc

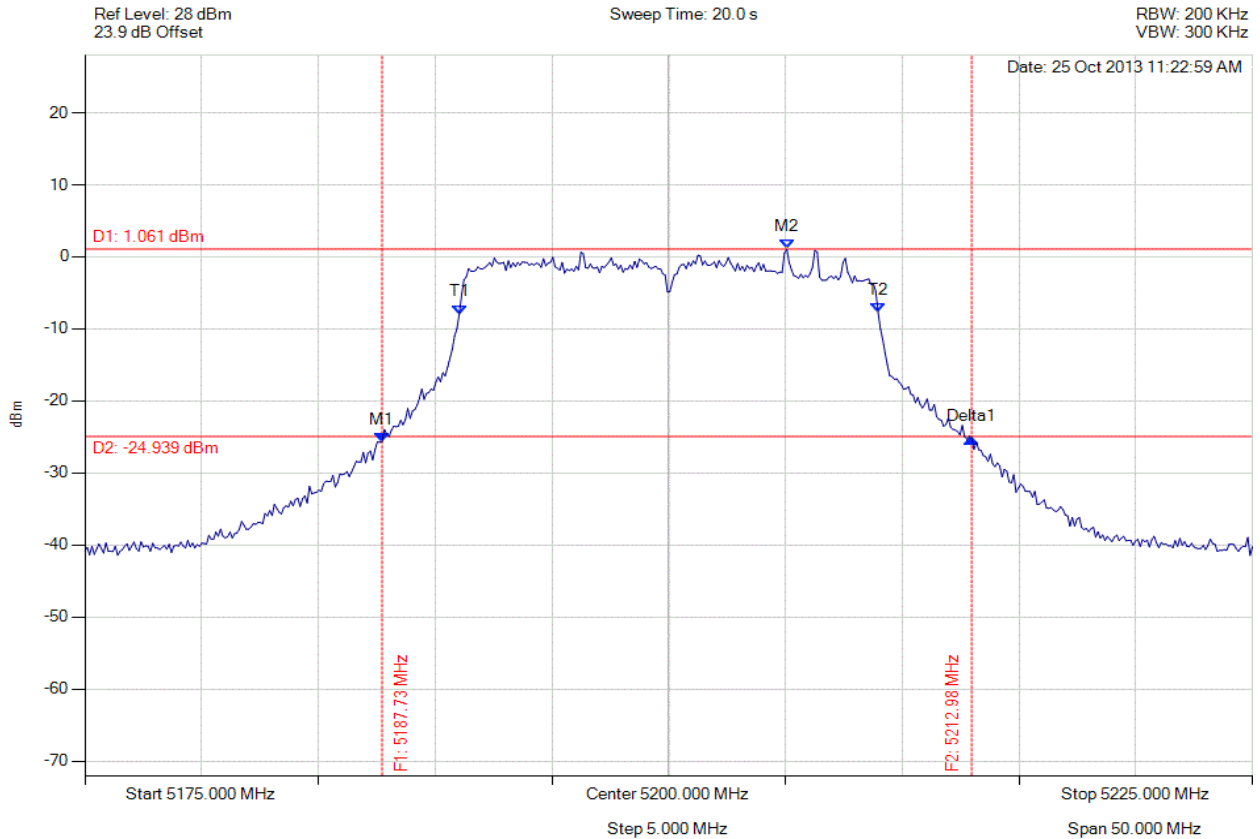

Analyser Setup	Marker : Frequency : Amplitude	Test Results
Detector = MAX PEAK Sweep Count = 0 RF Atten (dB) = 20 Trace Mode = VIEW	M1 : 5187.725 MHz : -25.660 dBm M2 : 5205.060 MHz : 1.061 dBm Delta1 : 25.251 MHz : 0.492 dB T1 : 5191.032 MHz : -7.955 dBm T2 : 5208.968 MHz : -7.741 dBm OBW : 17.936 MHz	Measured 26 dB Bandwidth: 25.251 MHz Measured 99% Bandwidth: 17.936 MHz

[Back to the Matrix](#)

This test report may be reproduced in full only. The document may only be updated by MiCOM Labs personnel. Any changes will be noted in the Document History section of the report.



Title: Xirrus Inc. XI-AC1300, XI-AC867 (non-DFS Bands)
To: FCC 47 CFR Part 15.407 & IC RSS-210
Serial #: XIRR04-U6 Rev A
Issue Date: 29th April 2014
Page: 97 of 199



26 dB & 99% BANDWIDTH

Variant: 802.11n HT-20, Channel: 5200.00 MHz, Chain b, Temp: Ambient, Voltage: 56 Vdc

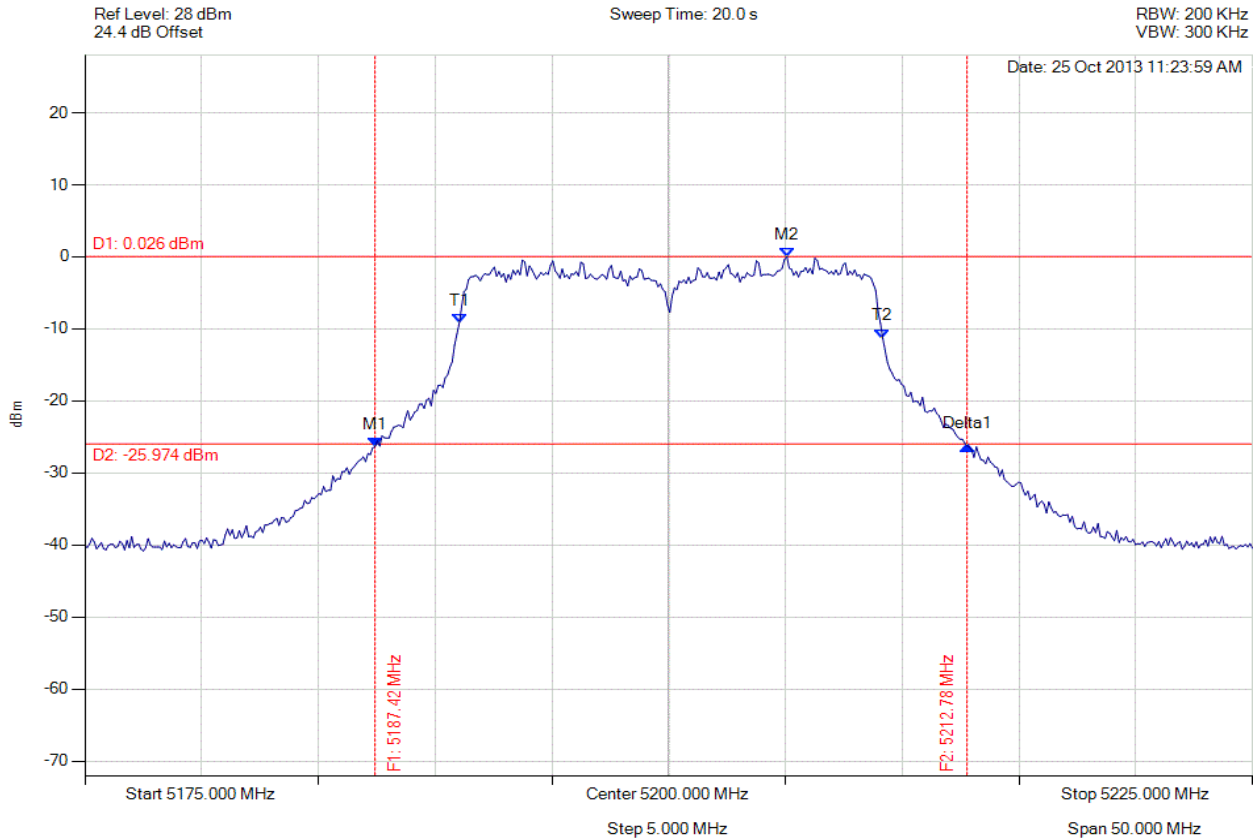

Analyser Setup	Marker : Frequency : Amplitude	Test Results
Detector = MAX PEAK Sweep Count = 0 RF Atten (dB) = 20 Trace Mode = VIEW	M1 : 5187.425 MHz : -26.319 dBm M2 : 5205.060 MHz : 0.026 dBm Delta1 : 25.351 MHz : 0.055 dB T1 : 5191.032 MHz : -9.262 dBm T2 : 5209.168 MHz : -11.292 dBm OBW : 18.136 MHz	Measured 26 dB Bandwidth: 25.351 MHz Measured 99% Bandwidth: 18.136 MHz

[Back to the Matrix](#)

This test report may be reproduced in full only. The document may only be updated by MiCOM Labs personnel. Any changes will be noted in the Document History section of the report.



Title: Xirrus Inc. XI-AC1300, XI-AC867 (non-DFS Bands)
To: FCC 47 CFR Part 15.407 & IC RSS-210
Serial #: XIRR04-U6 Rev A
Issue Date: 29th April 2014
Page: 98 of 199



26 dB & 99% BANDWIDTH

Variant: 802.11n HT-20, Channel: 5200.00 MHz, Chain c, Temp: Ambient, Voltage: 56 Vdc

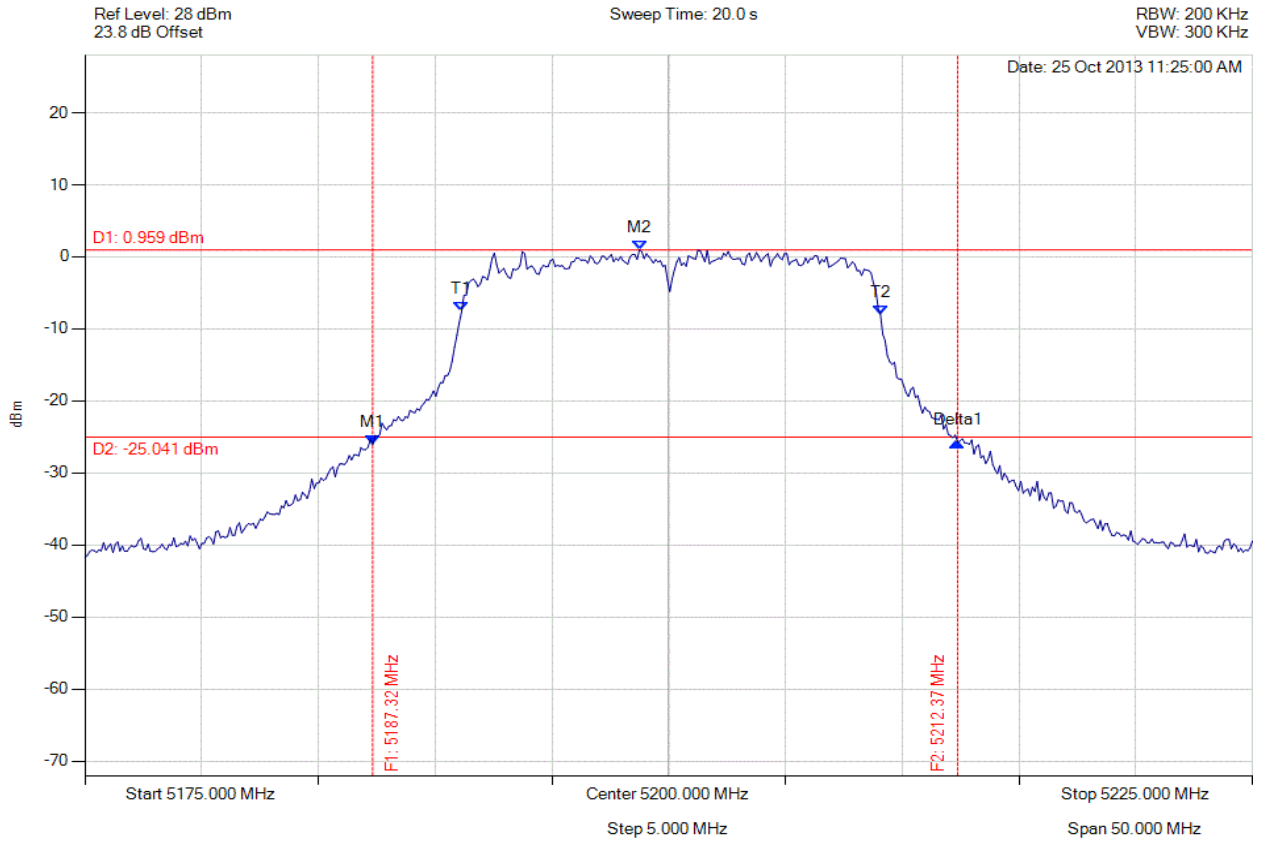

Analyser Setup	Marker : Frequency : Amplitude	Test Results
Detector = MAX PEAK Sweep Count = 0 RF Atten (dB) = 20 Trace Mode = VIEW	M1 : 5187.325 MHz : -26.087 dBm M2 : 5198.747 MHz : 0.959 dBm Delta1 : 25.050 MHz : 0.323 dB T1 : 5191.132 MHz : -7.584 dBm T2 : 5209.068 MHz : -7.985 dBm OBW : 17.936 MHz	Measured 26 dB Bandwidth: 25.050 MHz Measured 99% Bandwidth: 17.936 MHz

[Back to the Matrix](#)

This test report may be reproduced in full only. The document may only be updated by MiCOM Labs personnel. Any changes will be noted in the Document History section of the report.



Title: Xirrus Inc. XI-AC1300, XI-AC867 (non-DFS Bands)
To: FCC 47 CFR Part 15.407 & IC RSS-210
Serial #: XIRR04-U6 Rev A
Issue Date: 29th April 2014
Page: 99 of 199



26 dB & 99% BANDWIDTH

Variants: 802.11n HT-20, Channel: 5240.00 MHz, Chain a, Temp: Ambient, Voltage: 56 Vdc

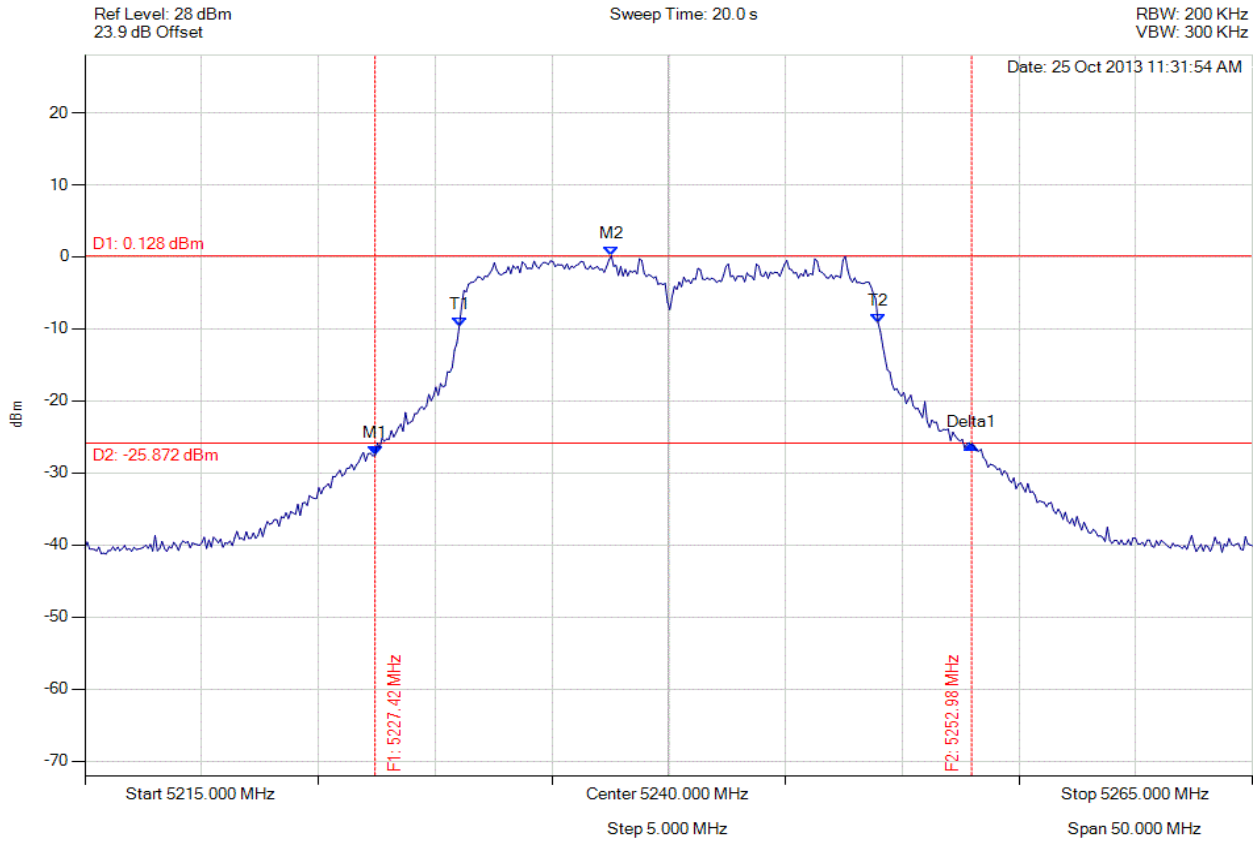

Analyser Setup	Marker : Frequency : Amplitude	Test Results
Detector = MAX PEAK Sweep Count = 0 RF Atten (dB) = 20 Trace Mode = VIEW	M1 : 5227.425 MHz : -27.592 dBm M2 : 5237.545 MHz : 0.128 dBm Delta1 : 25.551 MHz : 1.513 dB T1 : 5231.032 MHz : -9.689 dBm T2 : 5248.968 MHz : -9.189 dBm OBW : 17.936 MHz	Measured 26 dB Bandwidth: 25.551 MHz Measured 99% Bandwidth: 17.936 MHz

[Back to the Matrix](#)

This test report may be reproduced in full only. The document may only be updated by MiCOM Labs personnel. Any changes will be noted in the Document History section of the report.



Title: Xirrus Inc. XI-AC1300, XI-AC867 (non-DFS Bands)
To: FCC 47 CFR Part 15.407 & IC RSS-210
Serial #: XIRR04-U6 Rev A
Issue Date: 29th April 2014
Page: 100 of 199



26 dB & 99% BANDWIDTH

Variants: 802.11n HT-20, Channel: 5240.00 MHz, Chain b, Temp: Ambient, Voltage: 56 Vdc

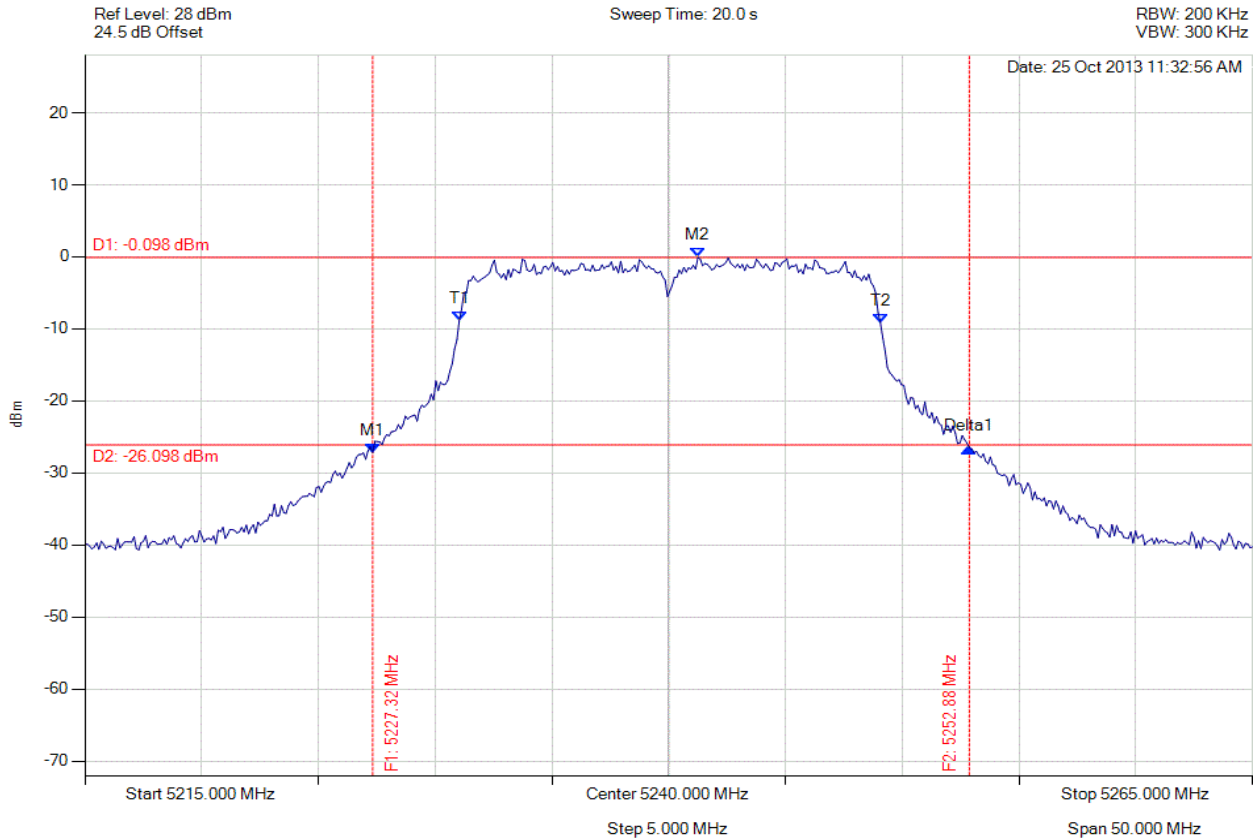

Analyser Setup	Marker : Frequency : Amplitude	Test Results
Detector = MAX PEAK Sweep Count = 0 RF Atten (dB) = 20 Trace Mode = VIEW	M1 : 5227.325 MHz : -27.167 dBm M2 : 5241.253 MHz : -0.098 dBm Delta1 : 25.551 MHz : 0.649 dB T1 : 5231.032 MHz : -8.862 dBm T2 : 5249.068 MHz : -9.193 dBm OBW : 18.036 MHz	Measured 26 dB Bandwidth: 25.551 MHz Measured 99% Bandwidth: 18.036 MHz

[Back to the Matrix](#)

This test report may be reproduced in full only. The document may only be updated by MiCOM Labs personnel. Any changes will be noted in the Document History section of the report.



Title: Xirrus Inc. XI-AC1300, XI-AC867 (non-DFS Bands)
To: FCC 47 CFR Part 15.407 & IC RSS-210
Serial #: XIRR04-U6 Rev A
Issue Date: 29th April 2014
Page: 101 of 199



26 dB & 99% BANDWIDTH

Variant: 802.11n HT-20, Channel: 5240.00 MHz, Chain c, Temp: Ambient, Voltage: 56 Vdc

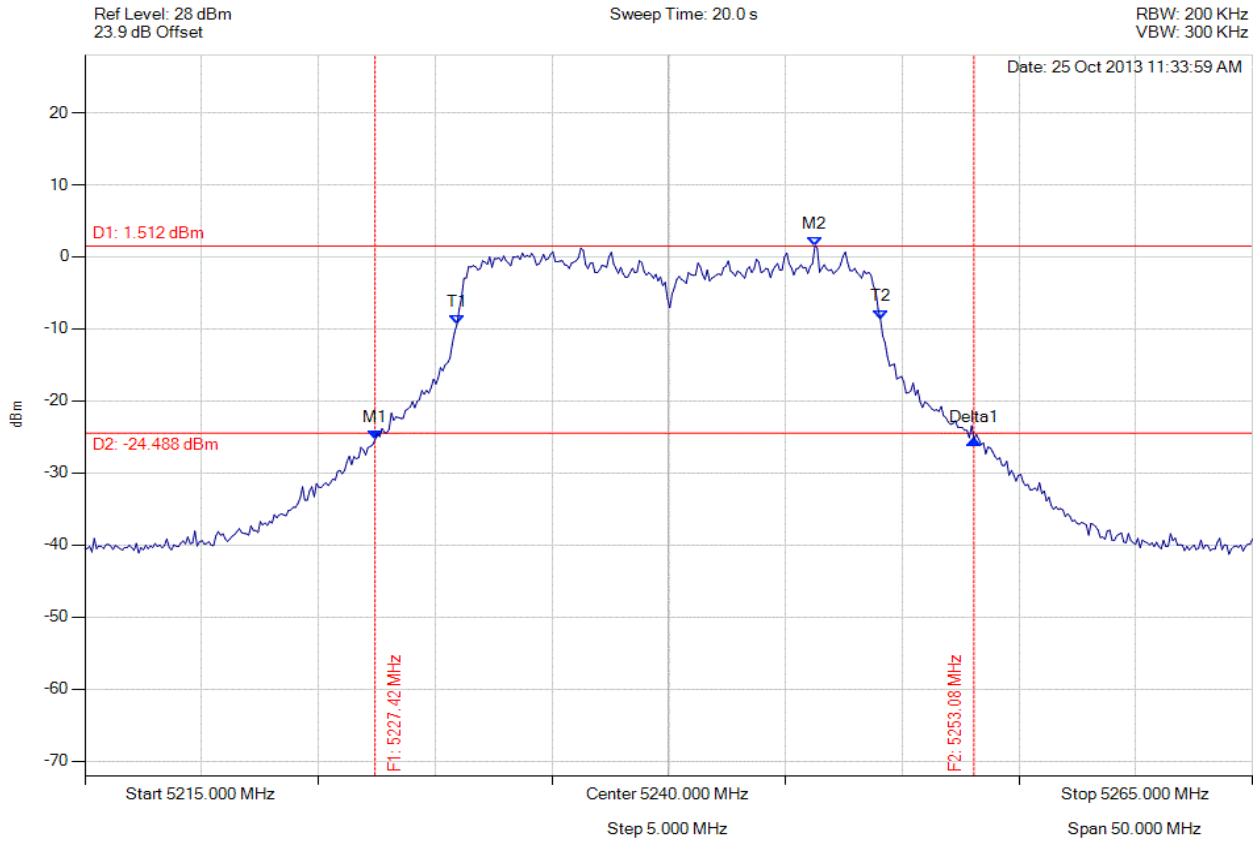

Analyser Setup	Marker : Frequency : Amplitude	Test Results
Detector = MAX PEAK Sweep Count = 0 RF Atten (dB) = 20 Trace Mode = VIEW	M1 : 5227.425 MHz : -25.394 dBm M2 : 5246.263 MHz : 1.512 dBm Delta1 : 25.651 MHz : 0.037 dB T1 : 5230.932 MHz : -9.397 dBm T2 : 5249.068 MHz : -8.634 dBm OBW : 18.136 MHz	Measured 26 dB Bandwidth: 25.651 MHz Measured 99% Bandwidth: 18.136 MHz

[Back to the Matrix](#)

This test report may be reproduced in full only. The document may only be updated by MiCOM Labs personnel. Any changes will be noted in the Document History section of the report.



Title: Xirrus Inc. XI-AC1300, XI-AC867 (non-DFS Bands)
To: FCC 47 CFR Part 15.407 & IC RSS-210
Serial #: XIRR04-U6 Rev A
Issue Date: 29th April 2014
Page: 102 of 199



26 dB & 99% BANDWIDTH

Variant: 802.11n HT-40, Channel: 5190.00 MHz, Chain a, Temp: Ambient, Voltage: 48 Vdc

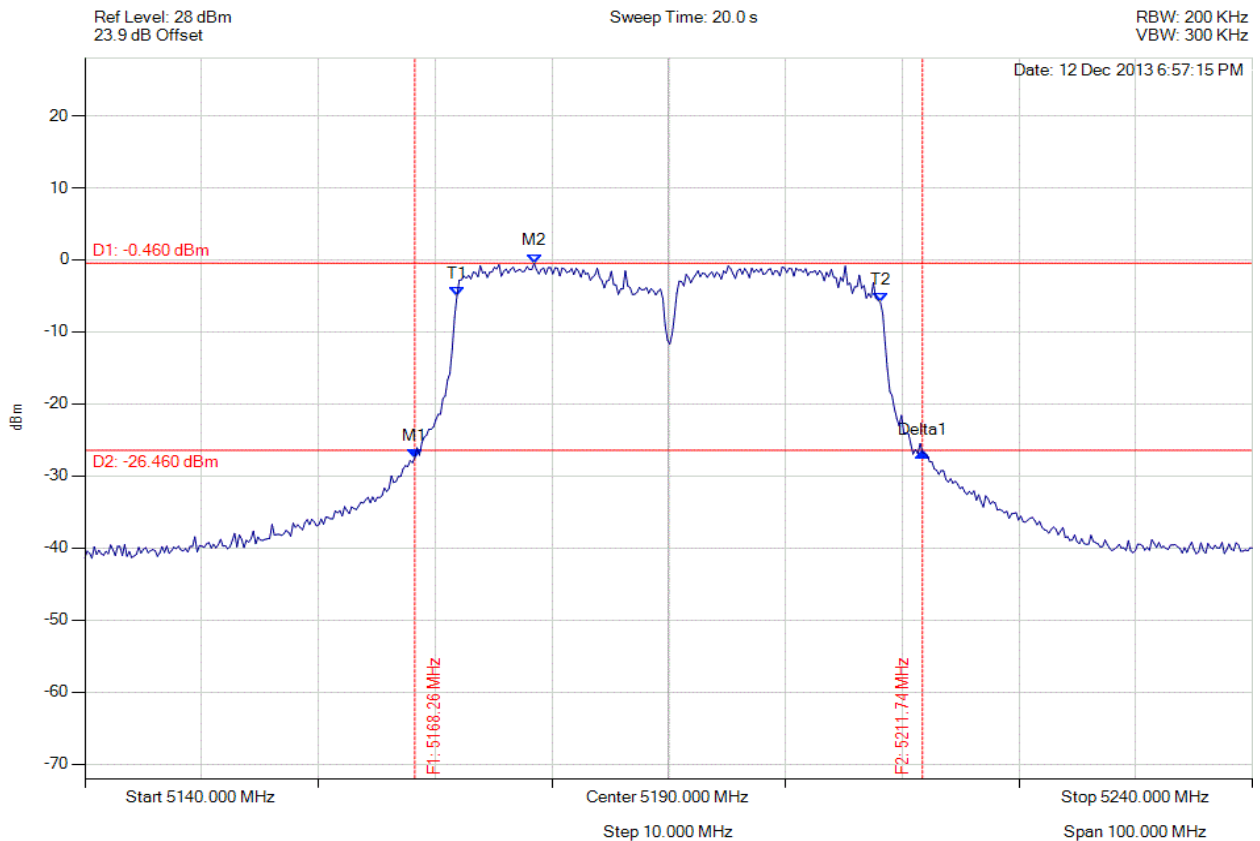

Analyser Setup	Marker : Frequency : Amplitude	Test Results
Detector = MAX PEAK Sweep Count = 0 RF Atten (dB) = 20 Trace Mode = VIEW	M1 : 5168.257 MHz : -27.481 dBm M2 : 5178.477 MHz : -0.460 dBm Delta1 : 43.487 MHz : 0.732 dB T1 : 5171.864 MHz : -5.016 dBm T2 : 5208.136 MHz : -5.917 dBm OBW : 36.273 MHz	Measured 26 dB Bandwidth: 43.487 MHz Measured 99% Bandwidth: 36.273 MHz

[Back to the Matrix](#)

This test report may be reproduced in full only. The document may only be updated by MiCOM Labs personnel. Any changes will be noted in the Document History section of the report.



Title: Xirrus Inc. XI-AC1300, XI-AC867 (non-DFS Bands)
To: FCC 47 CFR Part 15.407 & IC RSS-210
Serial #: XIRR04-U6 Rev A
Issue Date: 29th April 2014
Page: 103 of 199



26 dB & 99% BANDWIDTH

Variant: 802.11n HT-40, Channel: 5190.00 MHz, Chain b, Temp: Ambient, Voltage: 48 Vdc

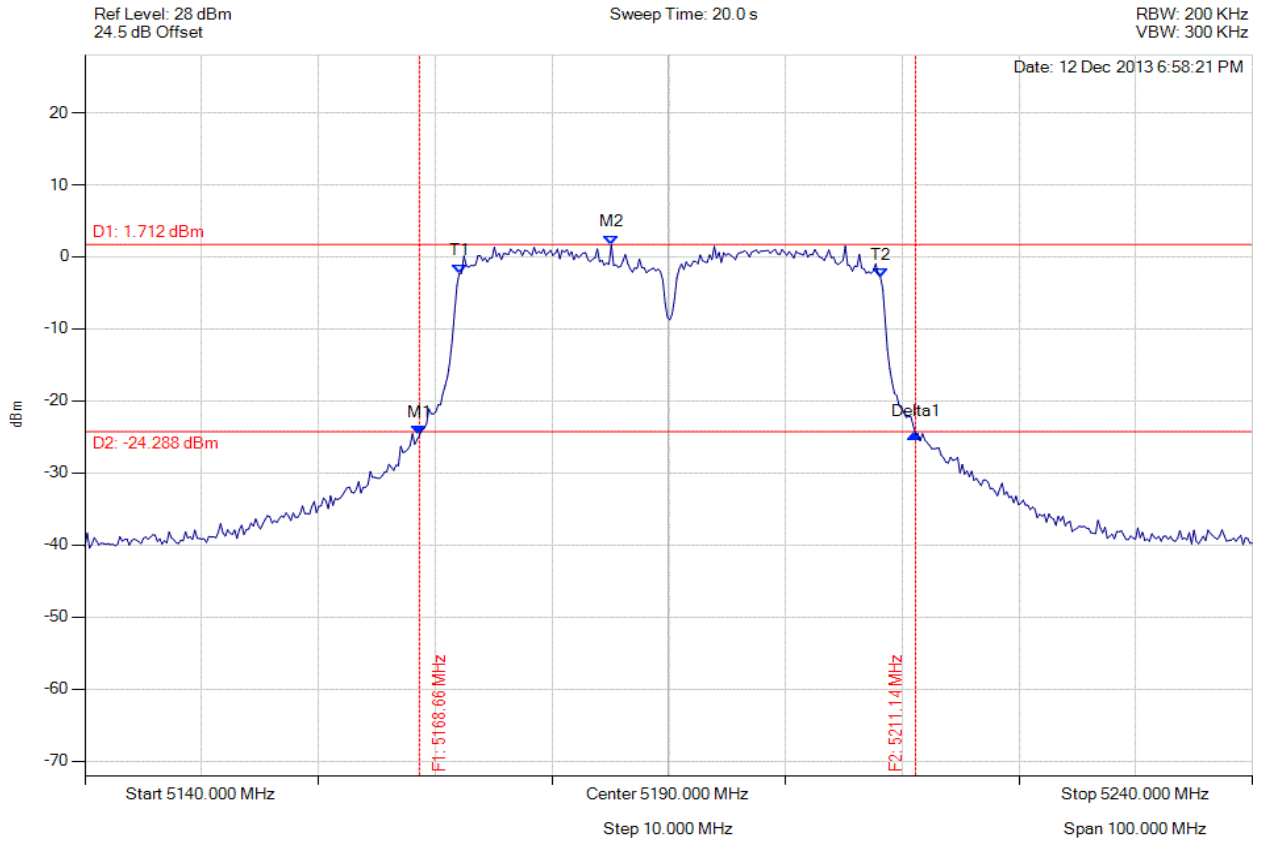

Analyser Setup	Marker : Frequency : Amplitude	Test Results
Detector = MAX PEAK Sweep Count = 0 RF Atten (dB) = 20 Trace Mode = VIEW	M1 : 5168.657 MHz : -24.757 dBm M2 : 5185.090 MHz : 1.712 dBm Delta1 : 42.485 MHz : 0.146 dB T1 : 5172.064 MHz : -2.282 dBm T2 : 5208.136 MHz : -2.819 dBm OBW : 36.072 MHz	Measured 26 dB Bandwidth: 42.485 MHz Measured 99% Bandwidth: 36.072 MHz

[Back to the Matrix](#)

This test report may be reproduced in full only. The document may only be updated by MiCOM Labs personnel. Any changes will be noted in the Document History section of the report.



Title: Xirrus Inc. XI-AC1300, XI-AC867 (non-DFS Bands)
To: FCC 47 CFR Part 15.407 & IC RSS-210
Serial #: XIRR04-U6 Rev A
Issue Date: 29th April 2014
Page: 104 of 199



26 dB & 99% BANDWIDTH

Variant: 802.11n HT-40, Channel: 5190.00 MHz, Chain c, Temp: Ambient, Voltage: 48 Vdc

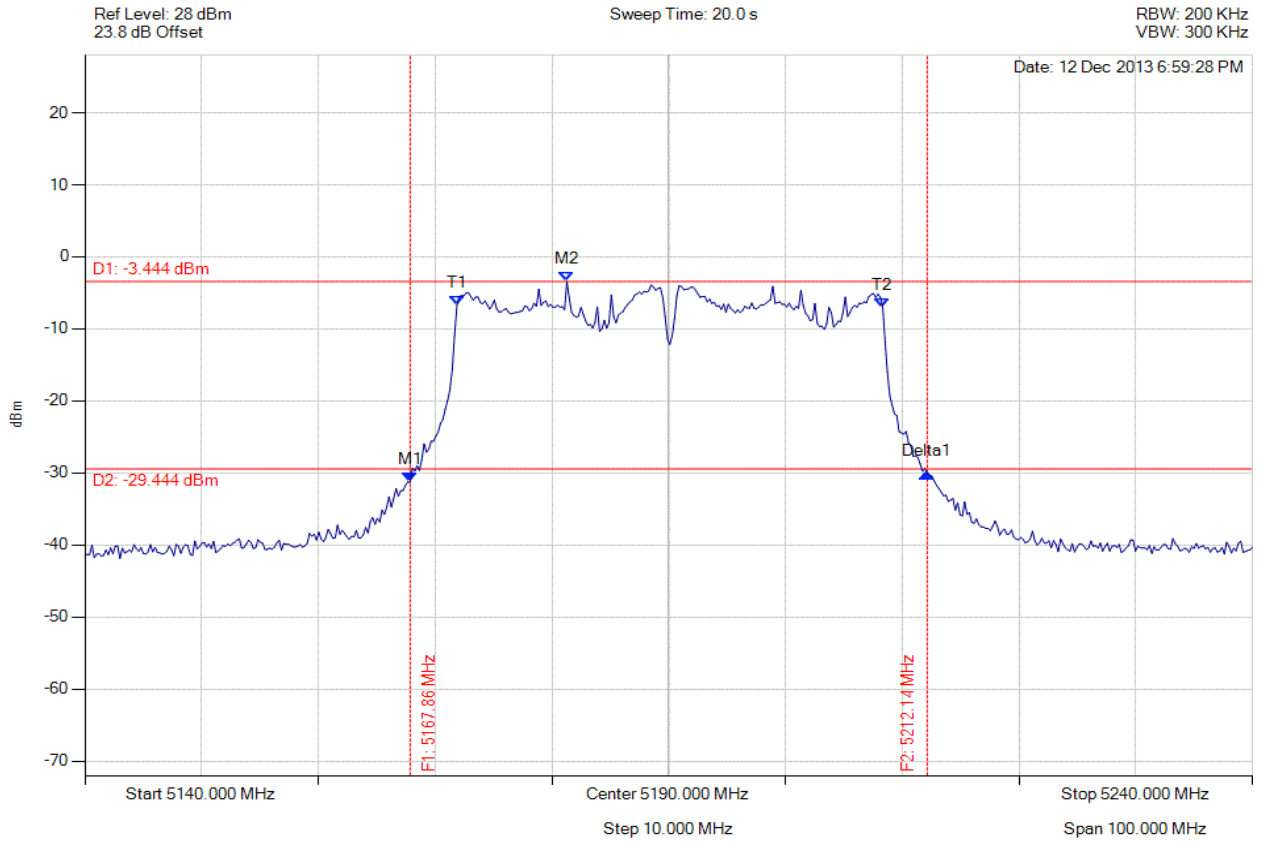

Analyser Setup	Marker : Frequency : Amplitude	Test Results
Detector = MAX PEAK Sweep Count = 0 RF Atten (dB) = 20 Trace Mode = VIEW	M1 : 5167.856 MHz : -31.288 dBm M2 : 5181.283 MHz : -3.444 dBm Delta1 : 44.289 MHz : 1.306 dB T1 : 5171.864 MHz : -6.716 dBm T2 : 5208.337 MHz : -7.080 dBm OBW : 36.473 MHz	Measured 26 dB Bandwidth: 44.289 MHz Measured 99% Bandwidth: 36.473 MHz

[Back to the Matrix](#)

This test report may be reproduced in full only. The document may only be updated by MiCOM Labs personnel. Any changes will be noted in the Document History section of the report.



Title: Xirrus Inc. XI-AC1300, XI-AC867 (non-DFS Bands)
To: FCC 47 CFR Part 15.407 & IC RSS-210
Serial #: XIRR04-U6 Rev A
Issue Date: 29th April 2014
Page: 105 of 199



26 dB & 99% BANDWIDTH

Variant: 802.11n HT-40, Channel: 5230.00 MHz, Chain a, Temp: Ambient, Voltage: 48 Vdc

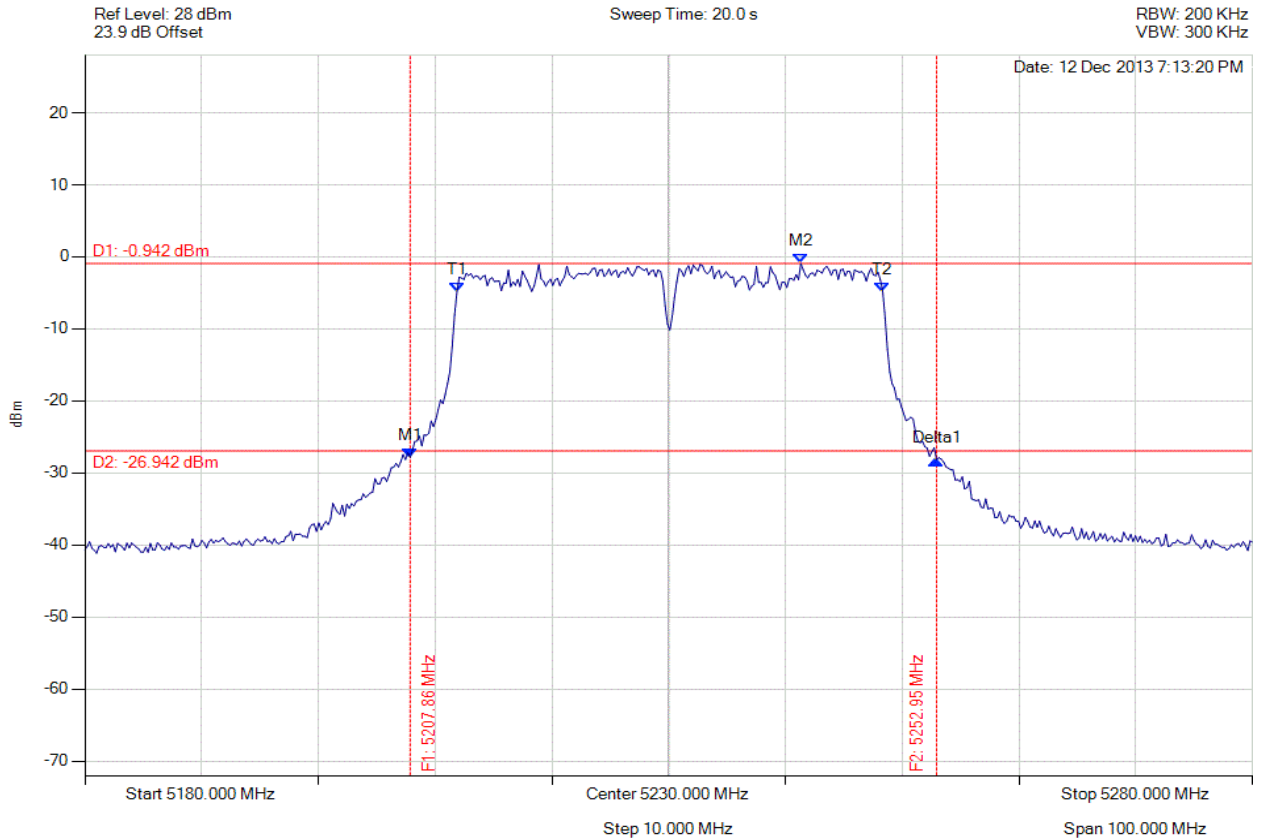

Analyser Setup	Marker : Frequency : Amplitude	Test Results
Detector = MAX PEAK Sweep Count = 0 RF Atten (dB) = 20 Trace Mode = VIEW	M1 : 5207.856 MHz : -27.847 dBm M2 : 5241.323 MHz : -0.942 dBm Delta1 : 45.090 MHz : -0.346 dB T1 : 5211.864 MHz : -4.847 dBm T2 : 5248.337 MHz : -4.890 dBm OBW : 36.473 MHz	Measured 26 dB Bandwidth: 45.090 MHz Measured 99% Bandwidth: 36.473 MHz

[Back to the Matrix](#)

This test report may be reproduced in full only. The document may only be updated by MiCOM Labs personnel. Any changes will be noted in the Document History section of the report.



Title: Xirrus Inc. XI-AC1300, XI-AC867 (non-DFS Bands)
To: FCC 47 CFR Part 15.407 & IC RSS-210
Serial #: XIRR04-U6 Rev A
Issue Date: 29th April 2014
Page: 106 of 199



26 dB & 99% BANDWIDTH

Variant: 802.11n HT-40, Channel: 5230.00 MHz, Chain b, Temp: Ambient, Voltage: 48 Vdc

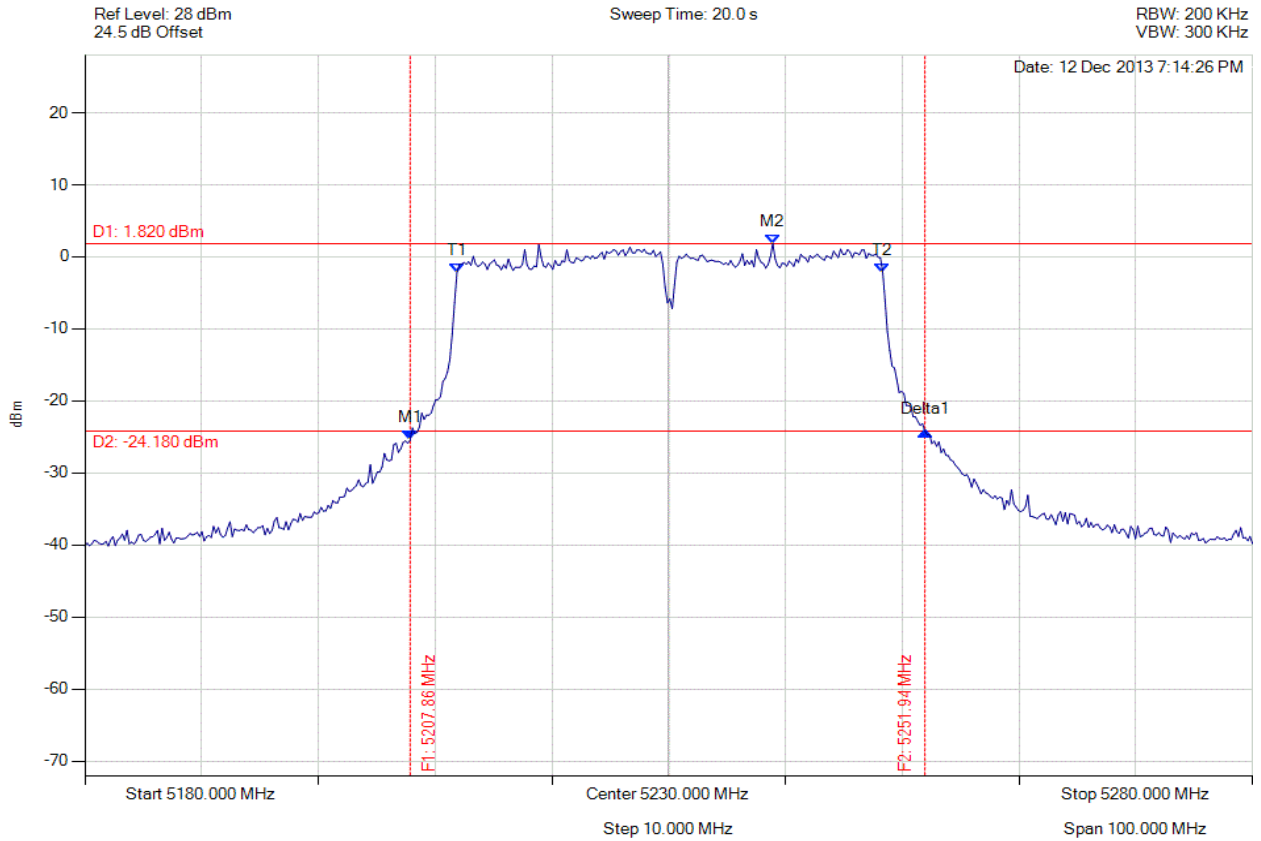

Analyser Setup	Marker : Frequency : Amplitude	Test Results
Detector = MAX PEAK Sweep Count = 0 RF Atten (dB) = 20 Trace Mode = VIEW	M1 : 5207.856 MHz : -25.435 dBm M2 : 5238.918 MHz : 1.820 dBm Delta1 : 44.088 MHz : 1.243 dB T1 : 5211.864 MHz : -2.207 dBm T2 : 5248.337 MHz : -2.213 dBm OBW : 36.473 MHz	Measured 26 dB Bandwidth: 44.088 MHz Measured 99% Bandwidth: 36.473 MHz

[Back to the Matrix](#)

This test report may be reproduced in full only. The document may only be updated by MiCOM Labs personnel. Any changes will be noted in the Document History section of the report.



Title: Xirrus Inc. XI-AC1300, XI-AC867 (non-DFS Bands)
To: FCC 47 CFR Part 15.407 & IC RSS-210
Serial #: XIRR04-U6 Rev A
Issue Date: 29th April 2014
Page: 107 of 199



26 dB & 99% BANDWIDTH

Variant: 802.11n HT-40, Channel: 5230.00 MHz, Chain c, Temp: Ambient, Voltage: 48 Vdc

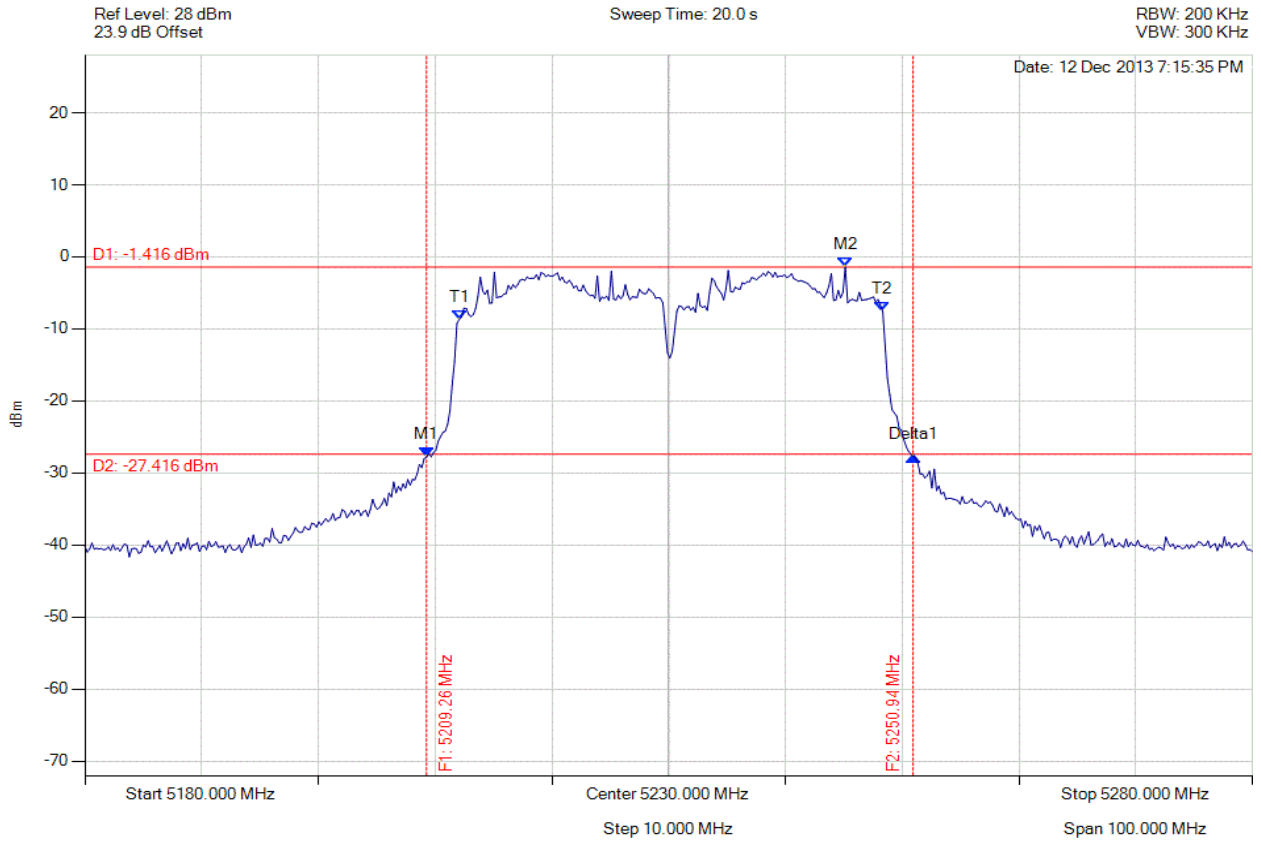

Analyser Setup	Marker : Frequency : Amplitude	Test Results
Detector = MAX PEAK Sweep Count = 0 RF Atten (dB) = 20 Trace Mode = VIEW	M1 : 5209.259 MHz : -27.784 dBm M2 : 5245.130 MHz : -1.416 dBm Delta1 : 41.683 MHz : 0.118 dB T1 : 5212.064 MHz : -8.701 dBm T2 : 5248.337 MHz : -7.611 dBm OBW : 36.273 MHz	Measured 26 dB Bandwidth: 41.683 MHz Measured 99% Bandwidth: 36.273 MHz

[Back to the Matrix](#)

This test report may be reproduced in full only. The document may only be updated by MiCOM Labs personnel. Any changes will be noted in the Document History section of the report.



Title: Xirrus Inc. XI-AC1300, XI-AC867 (non-DFS Bands)
To: FCC 47 CFR Part 15.407 & IC RSS-210
Serial #: XIRR04-U6 Rev A
Issue Date: 29th April 2014
Page: 108 of 199



26 dB & 99% BANDWIDTH

Variant: 802.11ac-80, Channel: 5210.00 MHz, Chain a, Temp: Ambient, Voltage: 48 Vdc

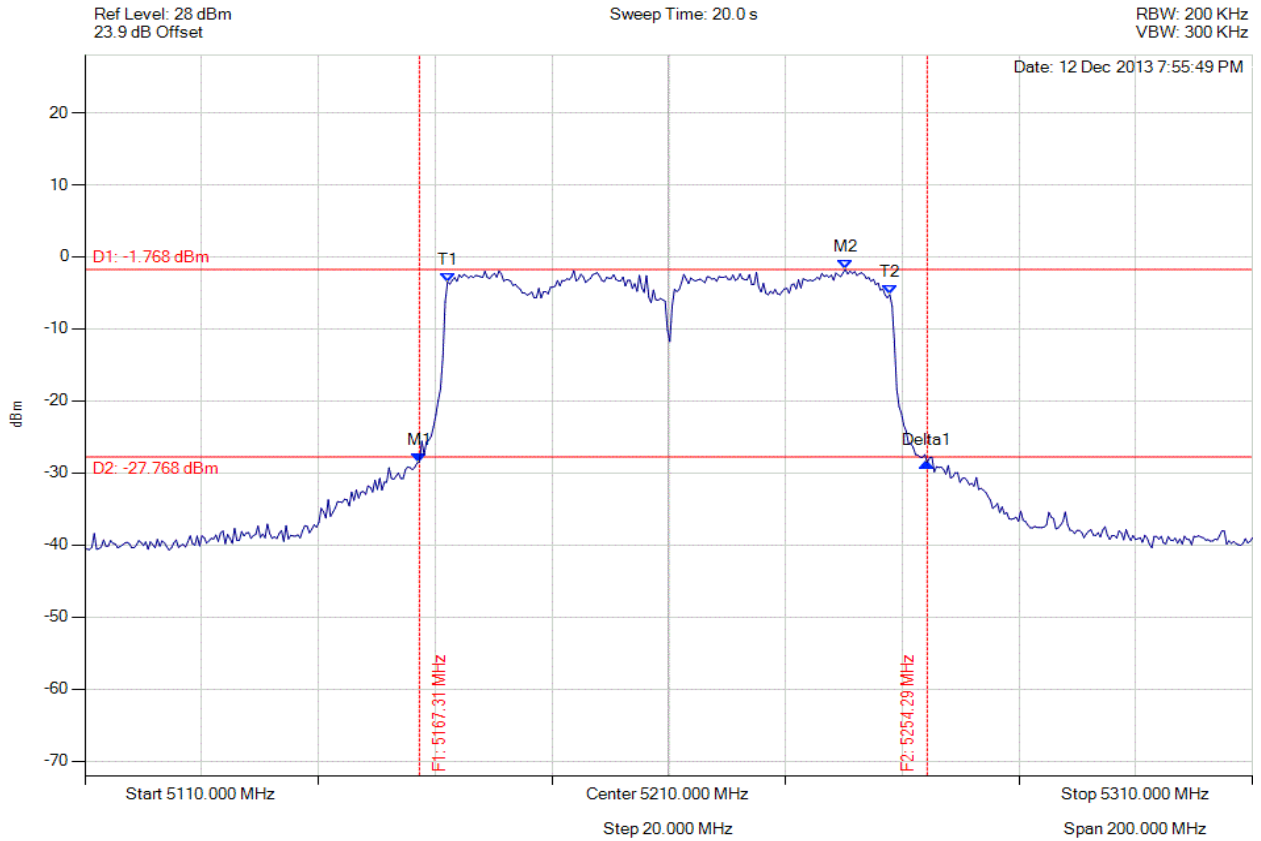

Analyser Setup	Marker : Frequency : Amplitude	Test Results
Detector = MAX PEAK Sweep Count = 0 RF Atten (dB) = 20 Trace Mode = VIEW	M1 : 5167.315 MHz : -28.506 dBm M2 : 5240.261 MHz : -1.768 dBm Delta1 : 86.974 MHz : -0.059 dB T1 : 5172.124 MHz : -3.491 dBm T2 : 5247.876 MHz : -5.238 dBm OBW : 75.752 MHz	Measured 26 dB Bandwidth: 86.974 MHz Measured 99% Bandwidth: 75.752 MHz

[Back to the Matrix](#)

This test report may be reproduced in full only. The document may only be updated by MiCOM Labs personnel. Any changes will be noted in the Document History section of the report.



Title: Xirrus Inc. XI-AC1300, XI-AC867 (non-DFS Bands)
To: FCC 47 CFR Part 15.407 & IC RSS-210
Serial #: XIRR04-U6 Rev A
Issue Date: 29th April 2014
Page: 109 of 199



26 dB & 99% BANDWIDTH

Variant: 802.11ac-80, Channel: 5210.00 MHz, Chain b, Temp: Ambient, Voltage: 48 Vdc

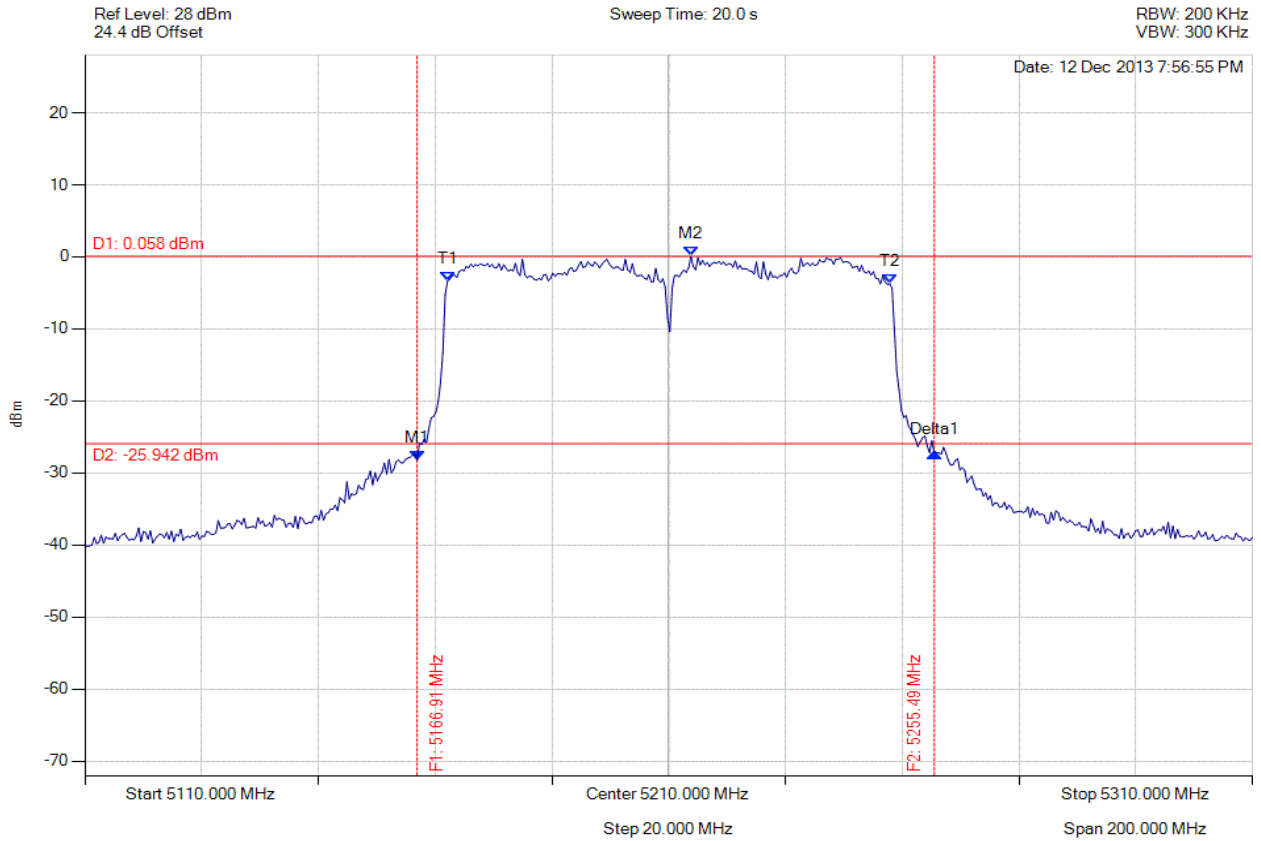

Analyser Setup	Marker : Frequency : Amplitude	Test Results
Detector = MAX PEAK Sweep Count = 0 RF Atten (dB) = 20 Trace Mode = VIEW	M1 : 5166.914 MHz : -28.241 dBm M2 : 5213.808 MHz : 0.058 dBm Delta1 : 88.577 MHz : 1.102 dB T1 : 5172.124 MHz : -3.328 dBm T2 : 5247.876 MHz : -3.728 dBm OBW : 75.752 MHz	Measured 26 dB Bandwidth: 88.577 MHz Measured 99% Bandwidth: 75.752 MHz

[Back to the Matrix](#)

This test report may be reproduced in full only. The document may only be updated by MiCOM Labs personnel. Any changes will be noted in the Document History section of the report.



Title: Xirrus Inc. XI-AC1300, XI-AC867 (non-DFS Bands)
To: FCC 47 CFR Part 15.407 & IC RSS-210
Serial #: XIRR04-U6 Rev A
Issue Date: 29th April 2014
Page: 110 of 199



26 dB & 99% BANDWIDTH

Variant: 802.11ac-80, Channel: 5210.00 MHz, Chain c, Temp: Ambient, Voltage: 48 Vdc

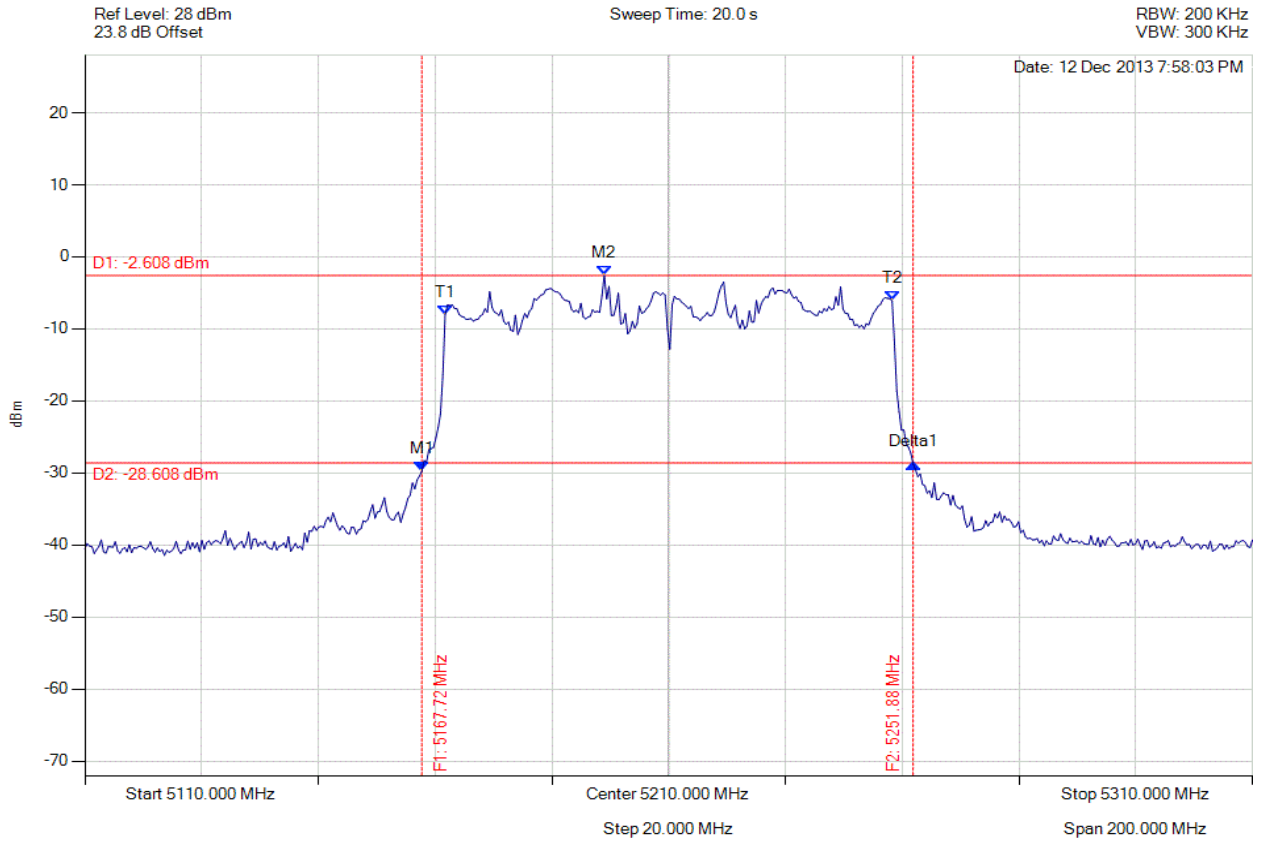

Analyser Setup	Marker : Frequency : Amplitude	Test Results
Detector = MAX PEAK Sweep Count = 0 RF Atten (dB) = 20 Trace Mode = VIEW	M1 : 5167.715 MHz : -29.795 dBm M2 : 5198.978 MHz : -2.608 dBm Delta1 : 84.168 MHz : 1.035 dB T1 : 5171.723 MHz : -7.975 dBm T2 : 5248.277 MHz : -6.106 dBm OBW : 76.553 MHz	Measured 26 dB Bandwidth: 84.168 MHz Measured 99% Bandwidth: 76.553 MHz

[Back to the Matrix](#)

This test report may be reproduced in full only. The document may only be updated by MiCOM Labs personnel. Any changes will be noted in the Document History section of the report.



A.1.2. Peak Power Spectral Density



PEAK POWER SPECTRAL DENSITY

Variant: 802.11a, Channel: 5180.00 MHz, Chain a, Temp: Ambient, Voltage: 56 Vdc

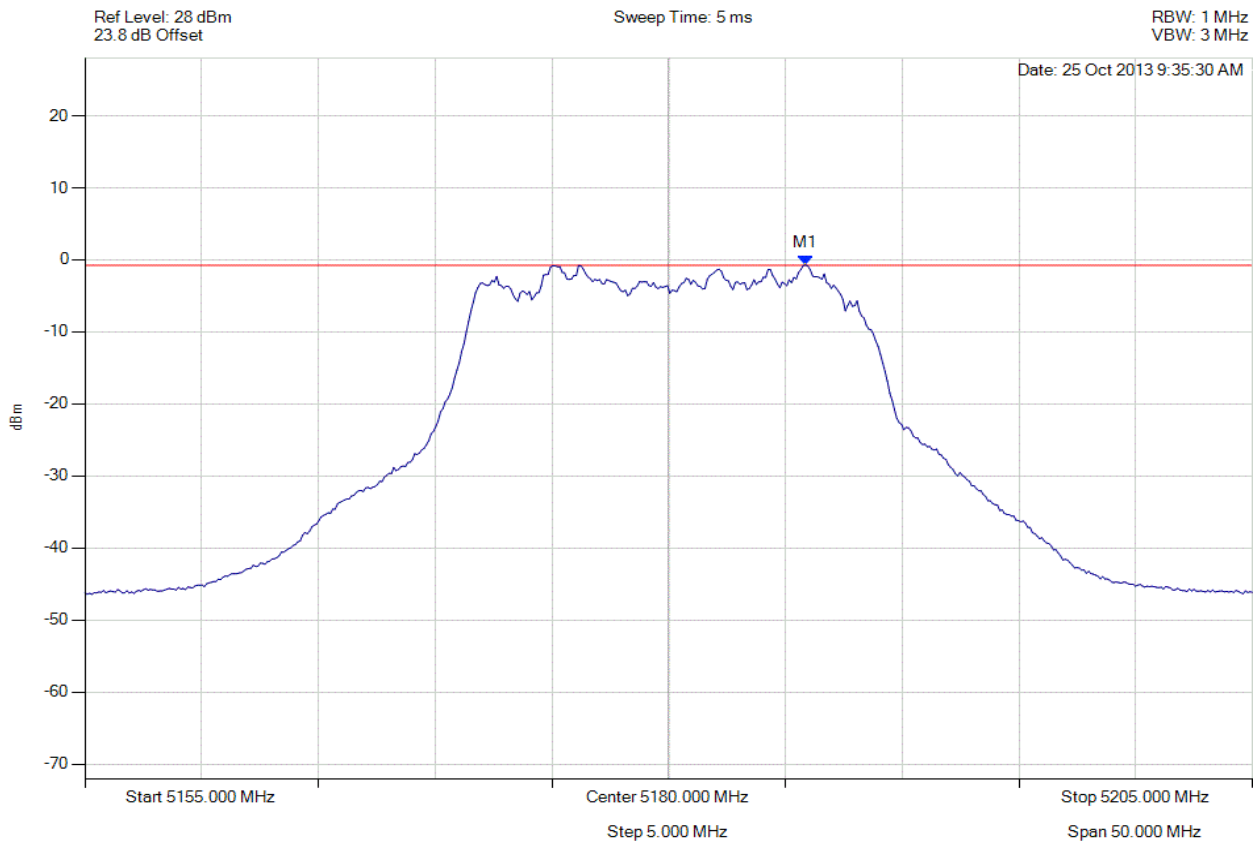

Analyser Setup	Marker : Frequency : Amplitude	Test Results
Detector = RMS Sweep Count = 100 RF Atten (dB) = 20 Trace Mode = VIEW	M1 : 5185.862 MHz : -0.709 dBm	Limit: ≤ -0.771 dBm Margin: -0.06 dB

[Back to the Matrix](#)

This test report may be reproduced in full only. The document may only be updated by MiCOM Labs personnel. Any changes will be noted in the Document History section of the report.



Title: Xirrus Inc. XI-AC1300, XI-AC867 (non-DFS Bands)
To: FCC 47 CFR Part 15.407 & IC RSS-210
Serial #: XIRR04-U6 Rev A
Issue Date: 29th April 2014
Page: 112 of 199



PEAK POWER SPECTRAL DENSITY

Variant: 802.11a, Channel: 5180.00 MHz, Chain b, Temp: Ambient, Voltage: 56 Vdc

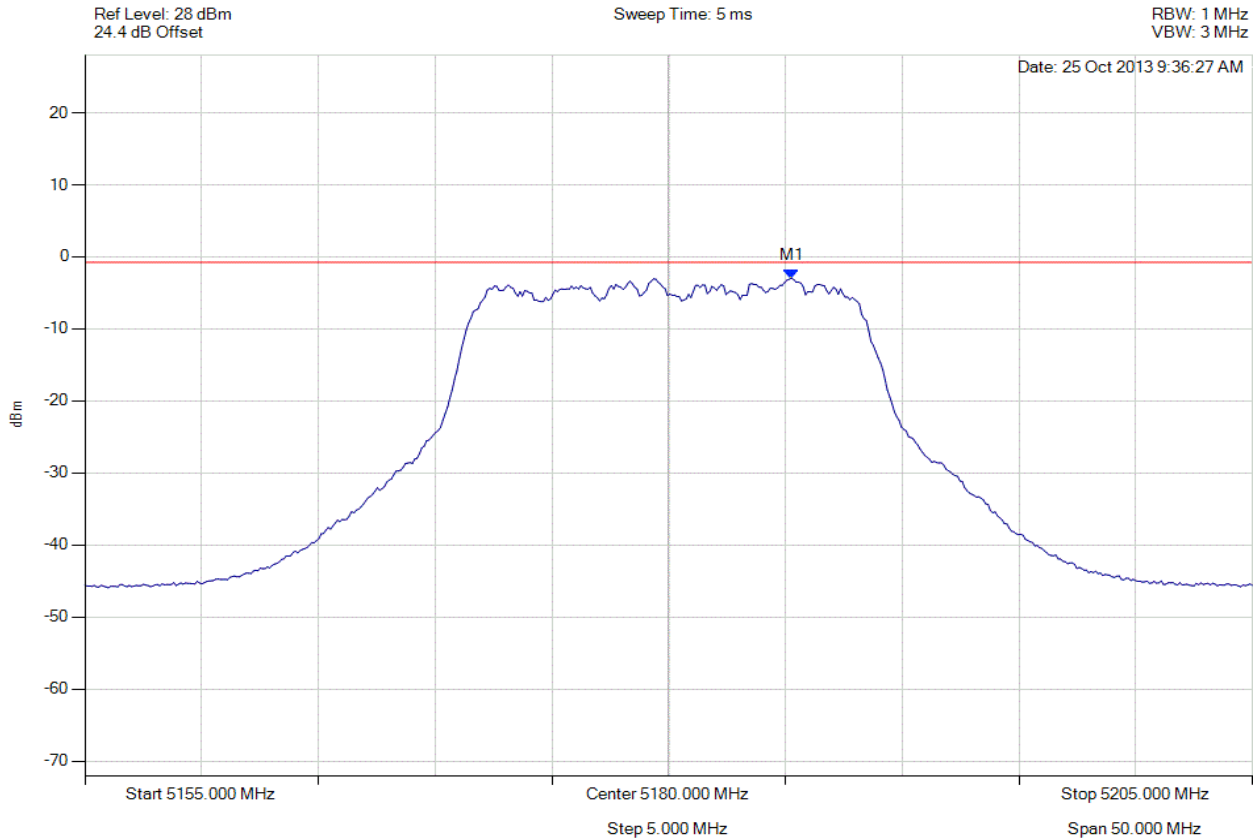

Analyser Setup	Marker : Frequency : Amplitude	Test Results
Detector = RMS Sweep Count = 100 RF Atten (dB) = 20 Trace Mode = VIEW	M1 : 5185.261 MHz : -2.962 dBm	Limit: ≤ -0.771 dBm Margin: 2.19 dB

[Back to the Matrix](#)

This test report may be reproduced in full only. The document may only be updated by MiCOM Labs personnel. Any changes will be noted in the Document History section of the report.



Title: Xirrus Inc. XI-AC1300, XI-AC867 (non-DFS Bands)
To: FCC 47 CFR Part 15.407 & IC RSS-210
Serial #: XIRR04-U6 Rev A
Issue Date: 29th April 2014
Page: 113 of 199



PEAK POWER SPECTRAL DENSITY

Variant: 802.11a, Channel: 5180.00 MHz, Chain c, Temp: Ambient, Voltage: 56 Vdc

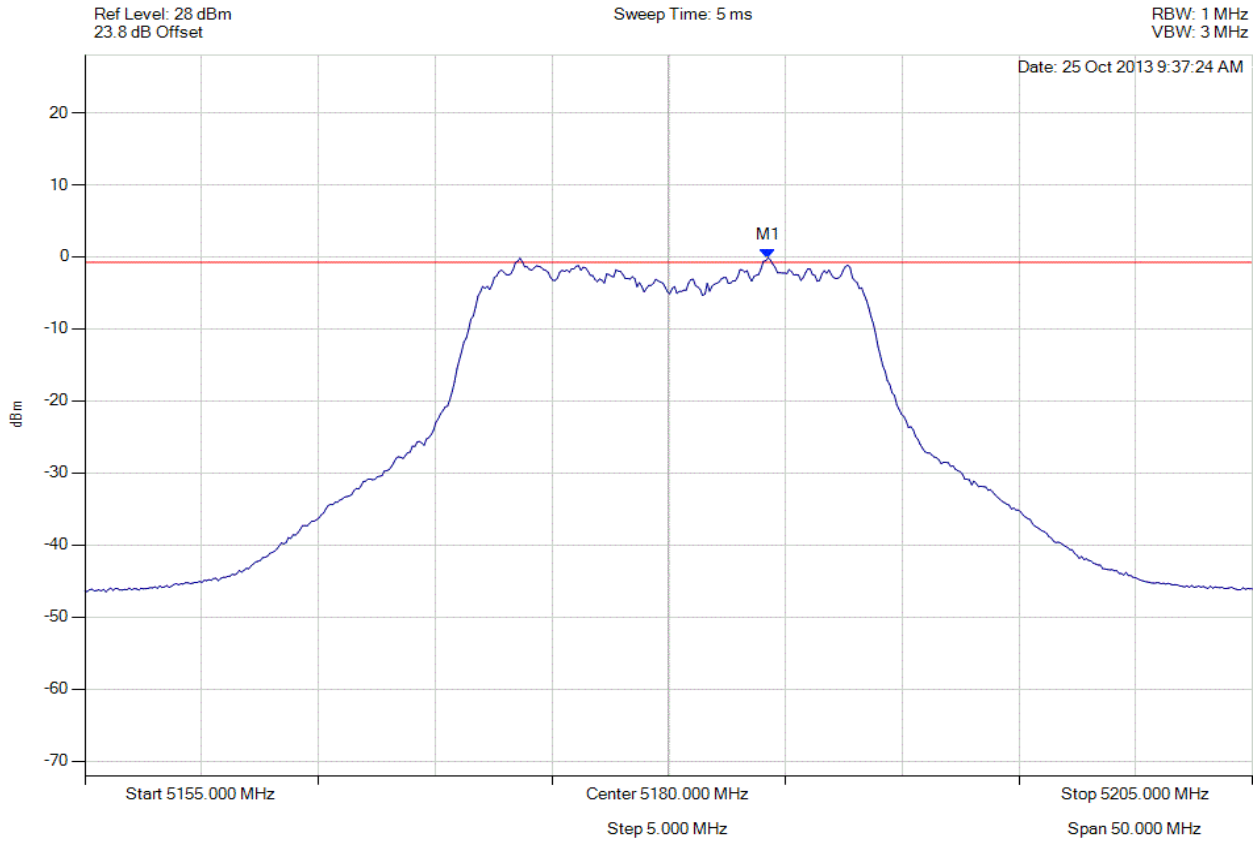

Analyser Setup	Marker : Frequency : Amplitude	Test Results
Detector = RMS Sweep Count = 100 RF Atten (dB) = 20 Trace Mode = VIEW	M1 : 5184.259 MHz : -0.123 dBm	Limit: ≤ -0.771 dBm Margin: -0.65 dB

[Back to the Matrix](#)

This test report may be reproduced in full only. The document may only be updated by MiCOM Labs personnel. Any changes will be noted in the Document History section of the report.



Title: Xirrus Inc. XI-AC1300, XI-AC867 (non-DFS Bands)
To: FCC 47 CFR Part 15.407 & IC RSS-210
Serial #: XIRR04-U6 Rev A
Issue Date: 29th April 2014
Page: 114 of 199



PEAK POWER SPECTRAL DENSITY

Variant: 802.11a, Channel: 5180.00 MHz, SUM, Temp: Ambient, Voltage: 56 Vdc

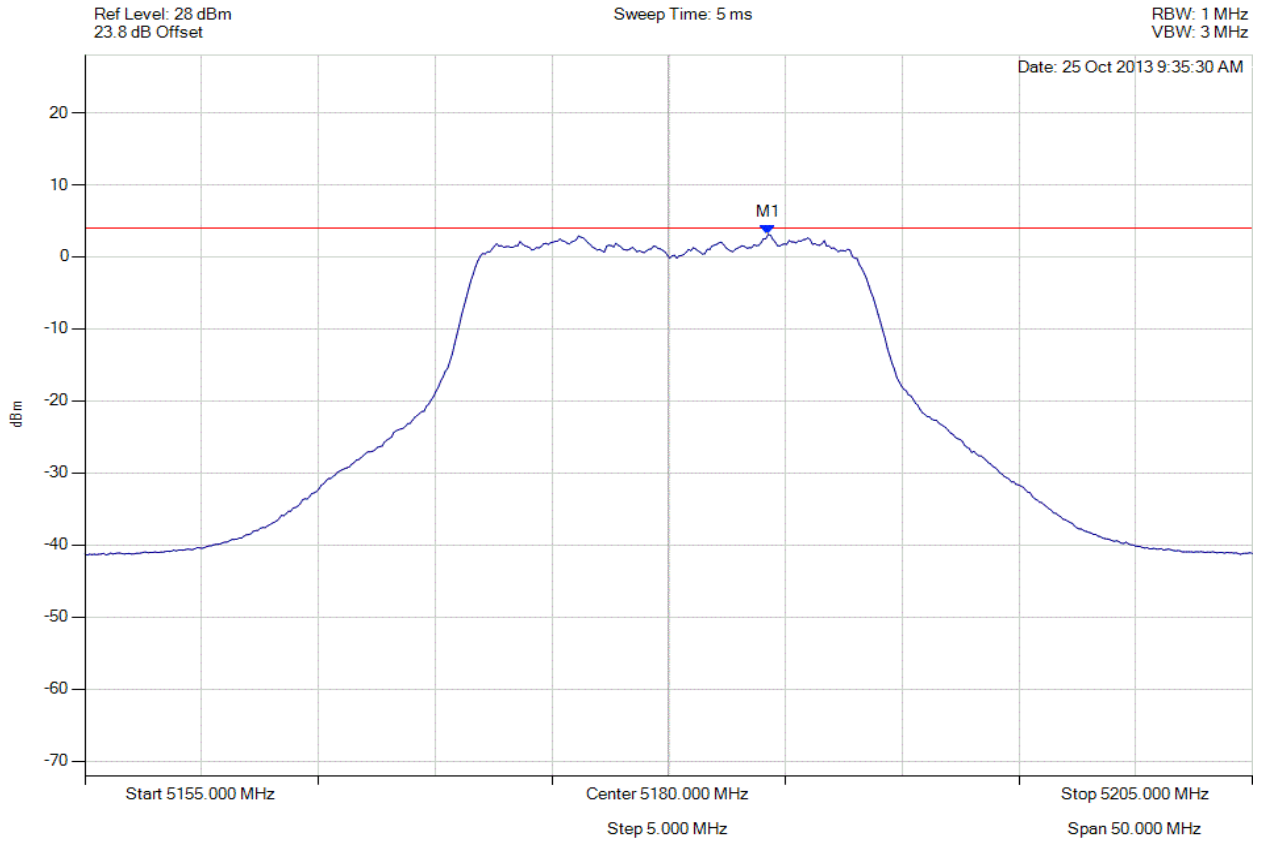

Analyser Setup	Marker : Frequency : Amplitude	Test Results
Detector = RMS Sweep Count = 100 RF Atten (dB) = 20 Trace Mode = VIEW	M1 : 5184.259 MHz : 3.098 dBm	Limit: ≤ 4.0 dBm Margin: -0.9 dB

[Back to the Matrix](#)

This test report may be reproduced in full only. The document may only be updated by MiCOM Labs personnel. Any changes will be noted in the Document History section of the report.



Title: Xirrus Inc. XI-AC1300, XI-AC867 (non-DFS Bands)
To: FCC 47 CFR Part 15.407 & IC RSS-210
Serial #: XIRR04-U6 Rev A
Issue Date: 29th April 2014
Page: 115 of 199



PEAK POWER SPECTRAL DENSITY

Variant: 802.11a, Channel: 5200.00 MHz, Chain a, Temp: Ambient, Voltage: 56 Vdc

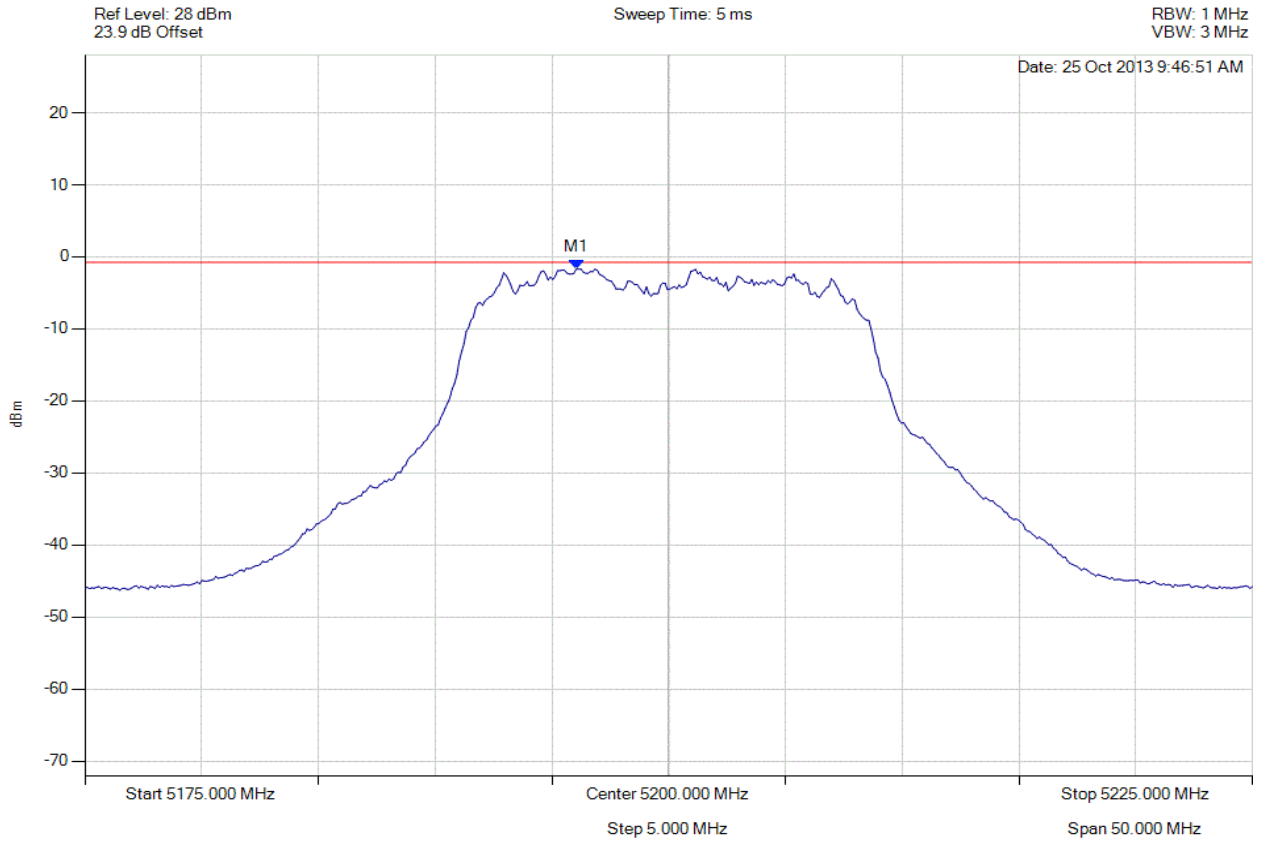

Analyser Setup	Marker : Frequency : Amplitude	Test Results
Detector = RMS Sweep Count = 100 RF Atten (dB) = 20 Trace Mode = VIEW	M1 : 5196.042 MHz : -1.696 dBm	Limit: ≤ -0.771 dBm Margin: 0.92 dB

[Back to the Matrix](#)

This test report may be reproduced in full only. The document may only be updated by MiCOM Labs personnel. Any changes will be noted in the Document History section of the report.



Title: Xirrus Inc. XI-AC1300, XI-AC867 (non-DFS Bands)
To: FCC 47 CFR Part 15.407 & IC RSS-210
Serial #: XIRR04-U6 Rev A
Issue Date: 29th April 2014
Page: 116 of 199



PEAK POWER SPECTRAL DENSITY

Variant: 802.11a, Channel: 5200.00 MHz, Chain b, Temp: Ambient, Voltage: 56 Vdc

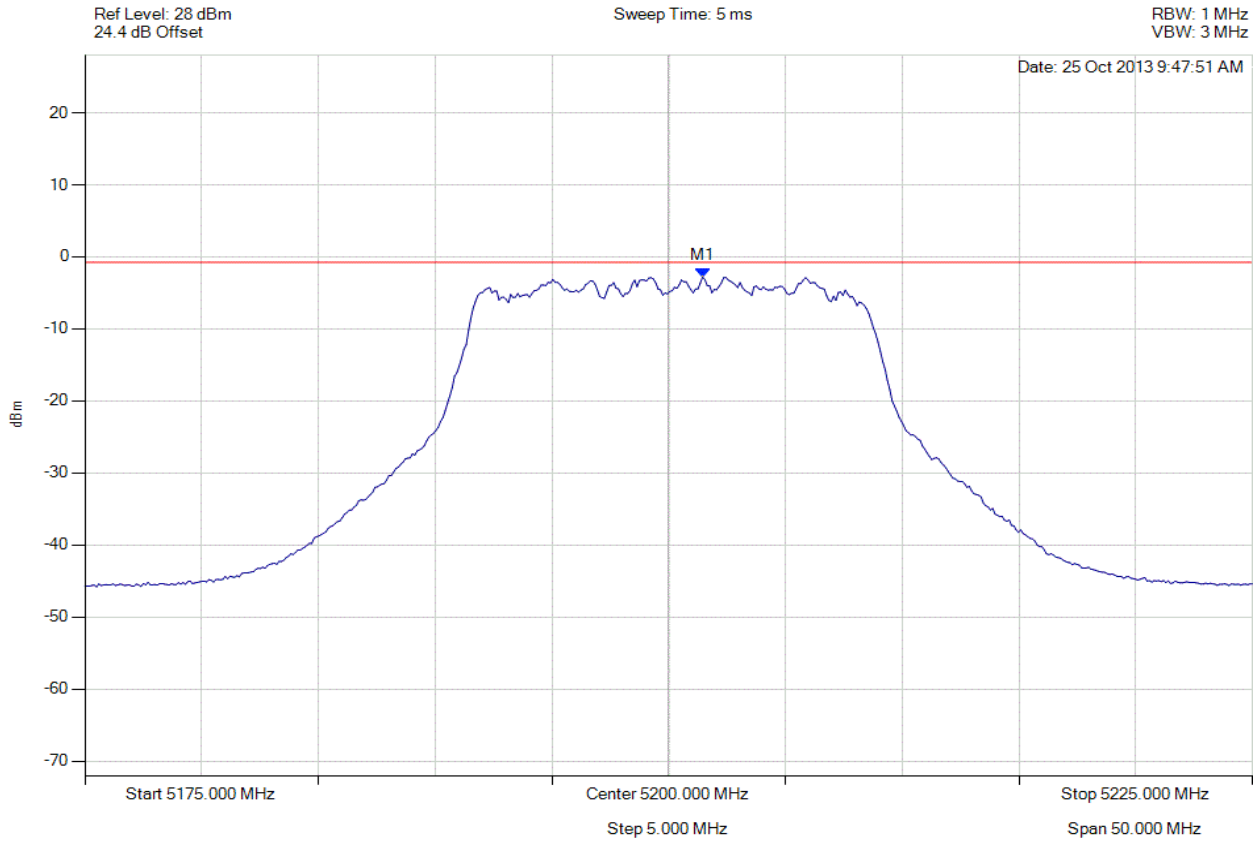

Analyser Setup	Marker : Frequency : Amplitude	Test Results
Detector = RMS Sweep Count = 100 RF Atten (dB) = 20 Trace Mode = VIEW	M1 : 5201.453 MHz : -2.810 dBm	Limit: ≤ -0.771 dBm Margin: 2.04 dB

[Back to the Matrix](#)

This test report may be reproduced in full only. The document may only be updated by MiCOM Labs personnel. Any changes will be noted in the Document History section of the report.



Title: Xirrus Inc. XI-AC1300, XI-AC867 (non-DFS Bands)
To: FCC 47 CFR Part 15.407 & IC RSS-210
Serial #: XIRR04-U6 Rev A
Issue Date: 29th April 2014
Page: 117 of 199



PEAK POWER SPECTRAL DENSITY

Variant: 802.11a, Channel: 5200.00 MHz, Chain c, Temp: Ambient, Voltage: 56 Vdc

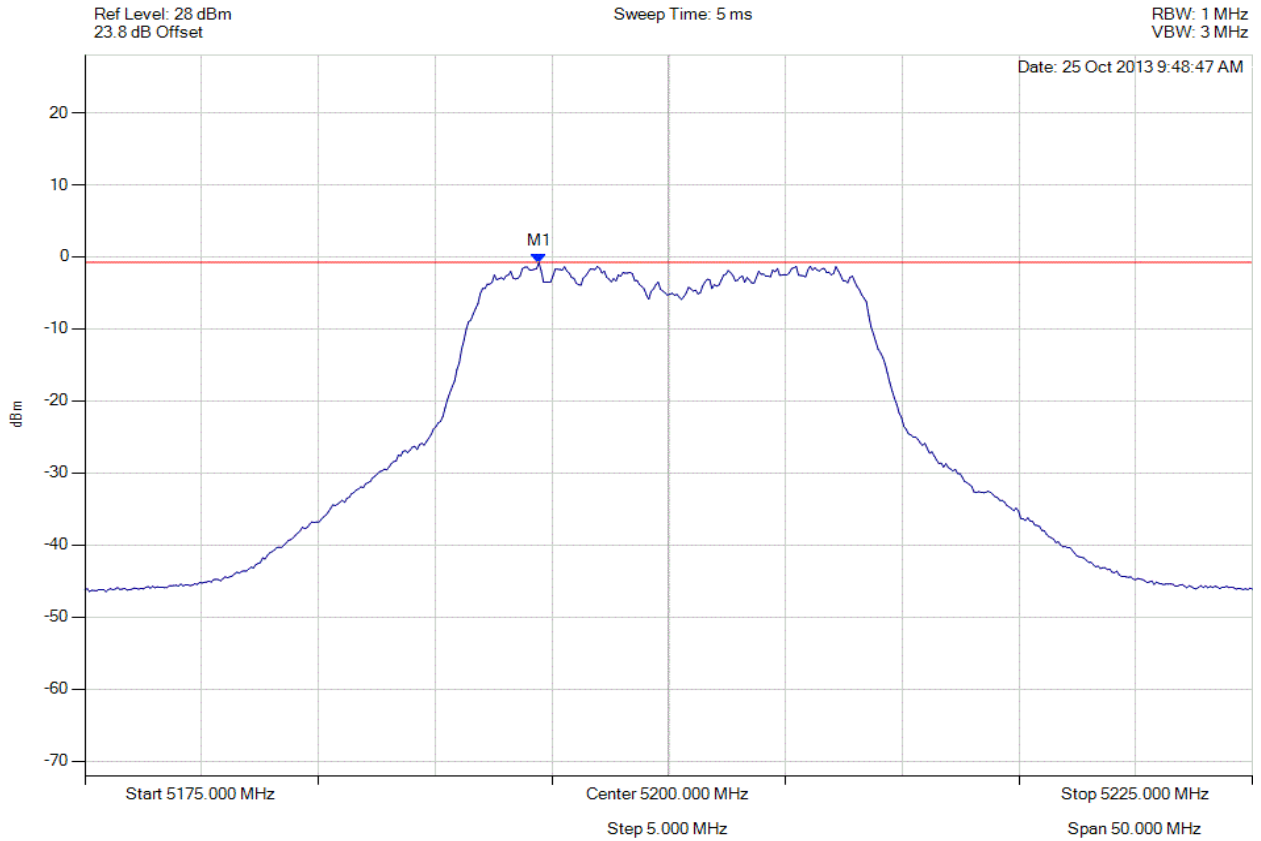

Analyser Setup	Marker : Frequency : Amplitude	Test Results
Detector = RMS Sweep Count = 100 RF Atten (dB) = 20 Trace Mode = VIEW	M1 : 5194.439 MHz : -0.831 dBm	Limit: ≤ -0.771 dBm Margin: 0.06 dB

[Back to the Matrix](#)

This test report may be reproduced in full only. The document may only be updated by MiCOM Labs personnel. Any changes will be noted in the Document History section of the report.



Title: Xirrus Inc. XI-AC1300, XI-AC867 (non-DFS Bands)
To: FCC 47 CFR Part 15.407 & IC RSS-210
Serial #: XIRR04-U6 Rev A
Issue Date: 29th April 2014
Page: 118 of 199



PEAK POWER SPECTRAL DENSITY

Variant: 802.11a, Channel: 5200.00 MHz, SUM, Temp: Ambient, Voltage: 56 Vdc

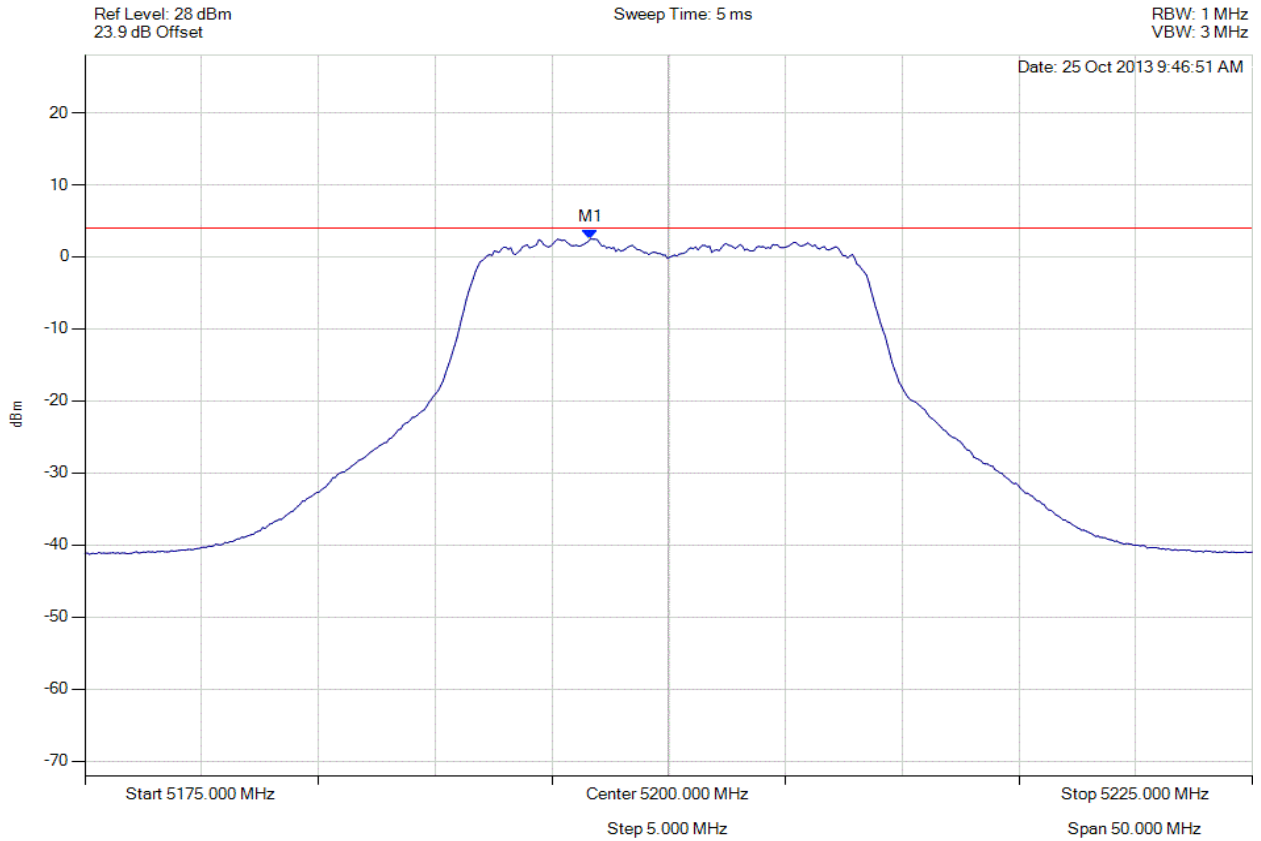

Analyser Setup	Marker : Frequency : Amplitude	Test Results
Detector = RMS Sweep Count = 100 RF Atten (dB) = 20 Trace Mode = VIEW	M1 : 5196.643 MHz : 2.469 dBm	Limit: ≤ 4.0 dBm Margin: -1.5 dB

[Back to the Matrix](#)

This test report may be reproduced in full only. The document may only be updated by MiCOM Labs personnel. Any changes will be noted in the Document History section of the report.



Title: Xirrus Inc. XI-AC1300, XI-AC867 (non-DFS Bands)
To: FCC 47 CFR Part 15.407 & IC RSS-210
Serial #: XIRR04-U6 Rev A
Issue Date: 29th April 2014
Page: 119 of 199



PEAK POWER SPECTRAL DENSITY

Variant: 802.11a, Channel: 5240.00 MHz, Chain a, Temp: Ambient, Voltage: 56 Vdc

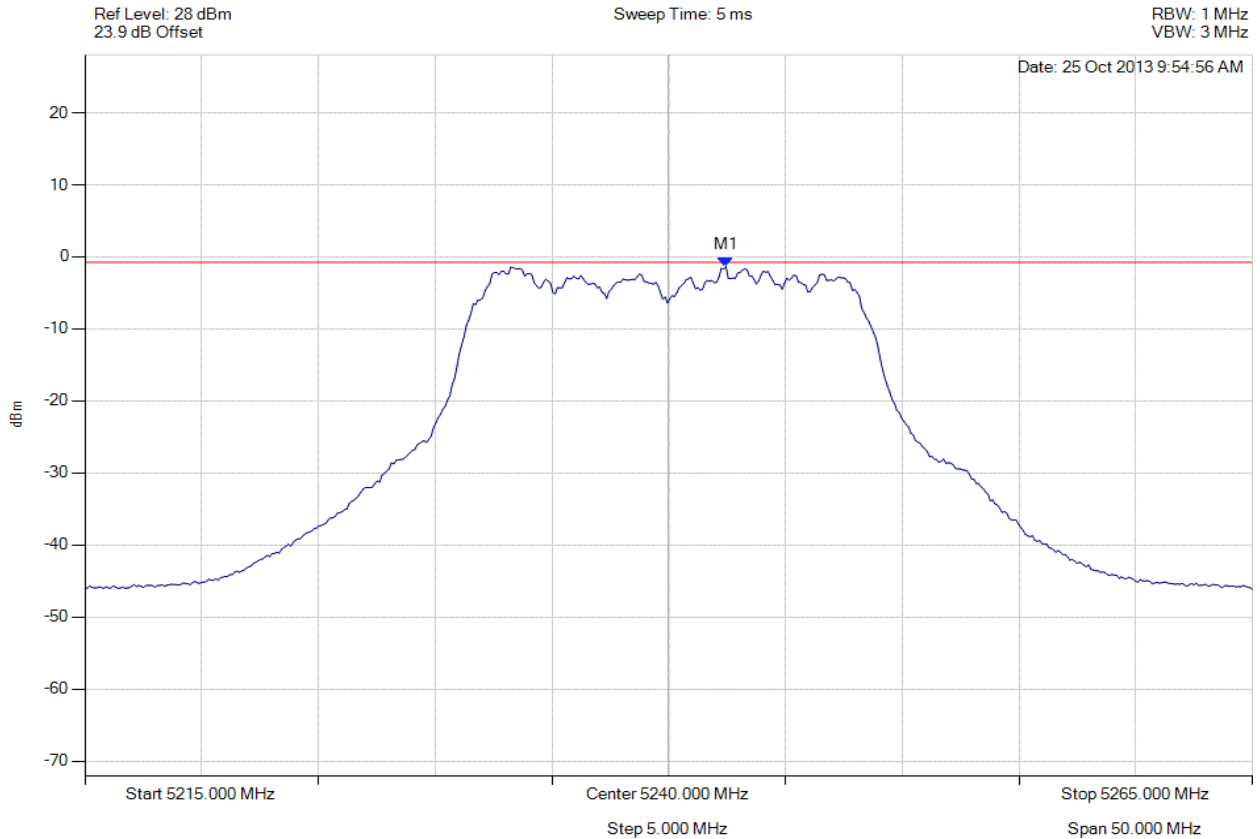

Analyser Setup	Marker : Frequency : Amplitude	Test Results
Detector = RMS Sweep Count = 100 RF Atten (dB) = 20 Trace Mode = VIEW	M1 : 5242.455 MHz : -1.329 dBm	Limit: ≤ -0.771 dBm Margin: 0.56 dB

[Back to the Matrix](#)

This test report may be reproduced in full only. The document may only be updated by MiCOM Labs personnel. Any changes will be noted in the Document History section of the report.



Title: Xirrus Inc. XI-AC1300, XI-AC867 (non-DFS Bands)
To: FCC 47 CFR Part 15.407 & IC RSS-210
Serial #: XIRR04-U6 Rev A
Issue Date: 29th April 2014
Page: 120 of 199



PEAK POWER SPECTRAL DENSITY

Variant: 802.11a, Channel: 5240.00 MHz, Chain b, Temp: Ambient, Voltage: 56 Vdc

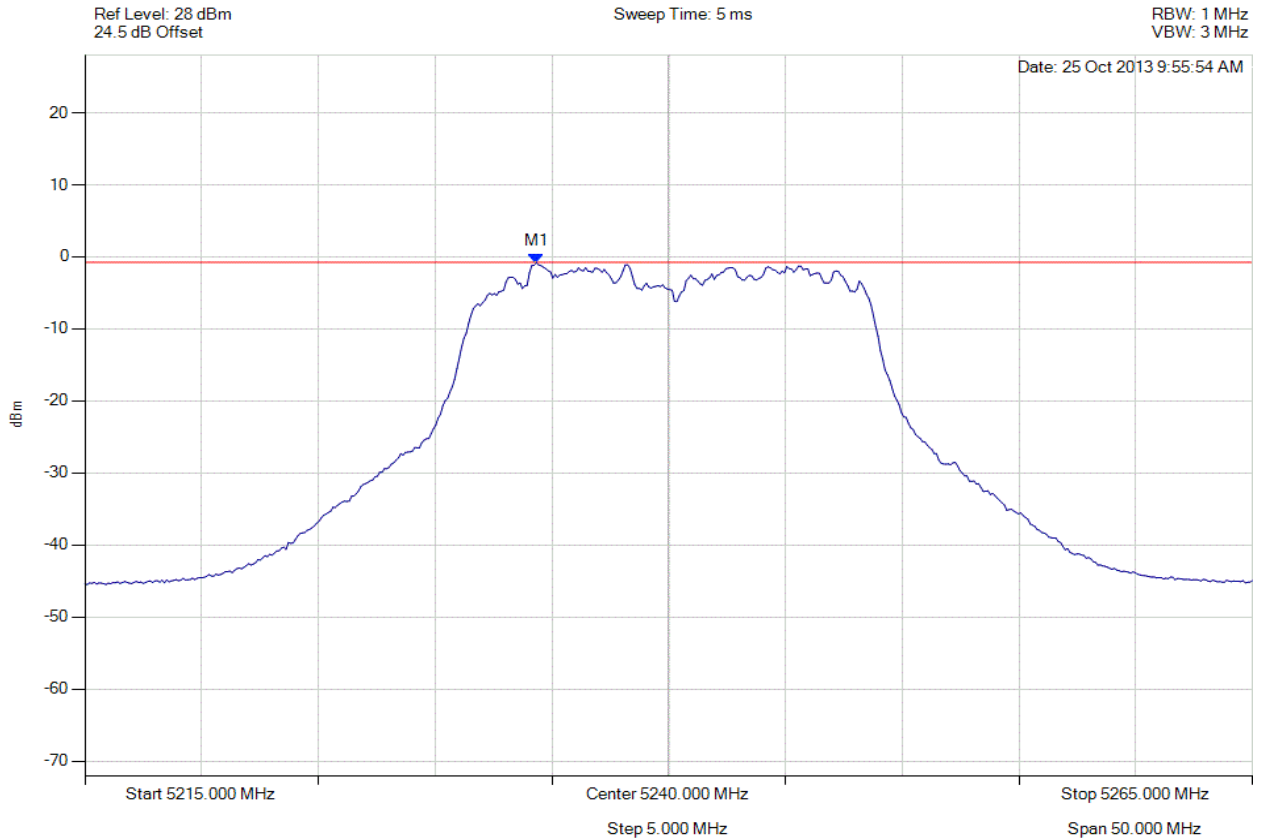

Analyser Setup	Marker : Frequency : Amplitude	Test Results
Detector = RMS Sweep Count = 100 RF Atten (dB) = 20 Trace Mode = VIEW	M1 : 5234.339 MHz : -0.846 dBm	Limit: ≤ -0.771 dBm Margin: 0.07 dB

[Back to the Matrix](#)

This test report may be reproduced in full only. The document may only be updated by MiCOM Labs personnel. Any changes will be noted in the Document History section of the report.



Title: Xirrus Inc. XI-AC1300, XI-AC867 (non-DFS Bands)
To: FCC 47 CFR Part 15.407 & IC RSS-210
Serial #: XIRR04-U6 Rev A
Issue Date: 29th April 2014
Page: 121 of 199



PEAK POWER SPECTRAL DENSITY

Variant: 802.11a, Channel: 5240.00 MHz, Chain c, Temp: Ambient, Voltage: 56 Vdc

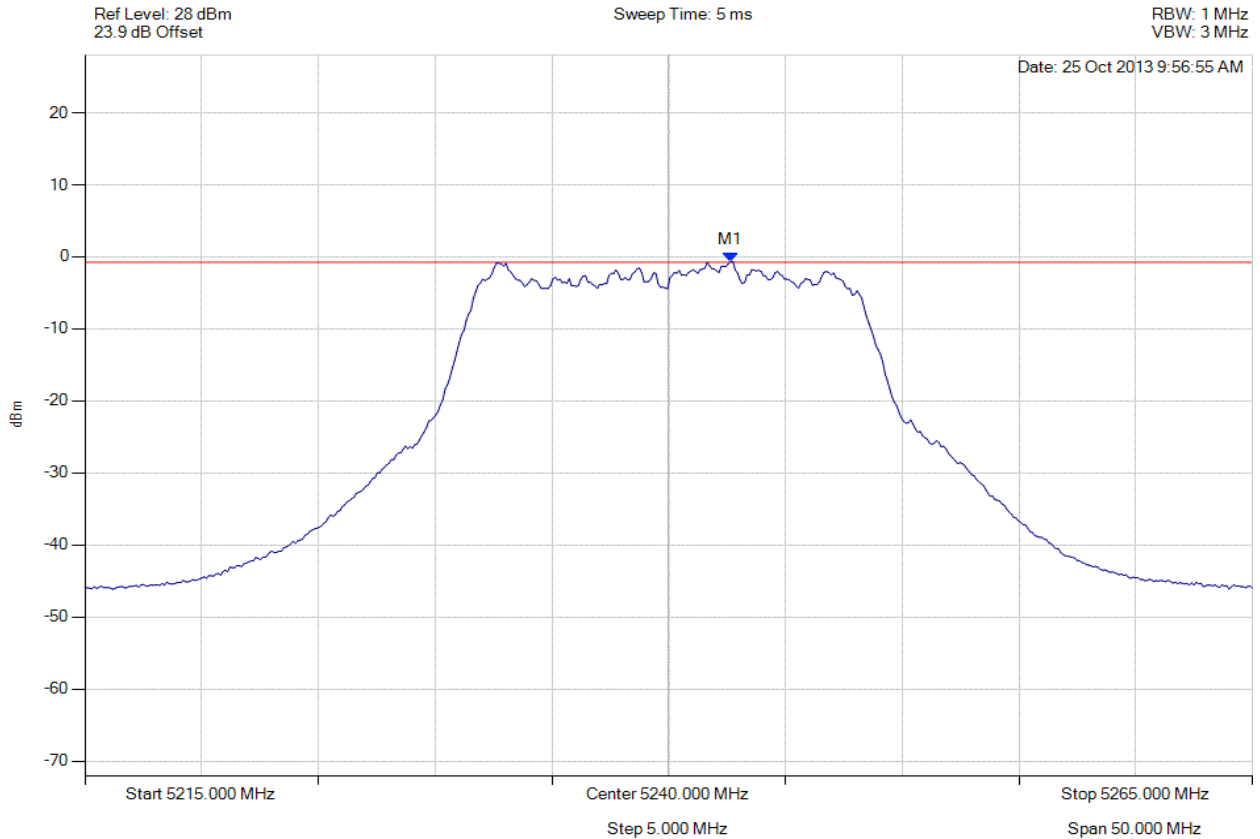

Analyser Setup	Marker : Frequency : Amplitude	Test Results
Detector = RMS Sweep Count = 100 RF Atten (dB) = 20 Trace Mode = VIEW	M1 : 5242.655 MHz : -0.637 dBm	Limit: ≤ -0.771 dBm Margin: -0.13 dB

[Back to the Matrix](#)

This test report may be reproduced in full only. The document may only be updated by MiCOM Labs personnel. Any changes will be noted in the Document History section of the report.



Title: Xirrus Inc. XI-AC1300, XI-AC867 (non-DFS Bands)
To: FCC 47 CFR Part 15.407 & IC RSS-210
Serial #: XIRR04-U6 Rev A
Issue Date: 29th April 2014
Page: 122 of 199



PEAK POWER SPECTRAL DENSITY

Variant: 802.11a, Channel: 5240.00 MHz, SUM, Temp: Ambient, Voltage: 56 Vdc

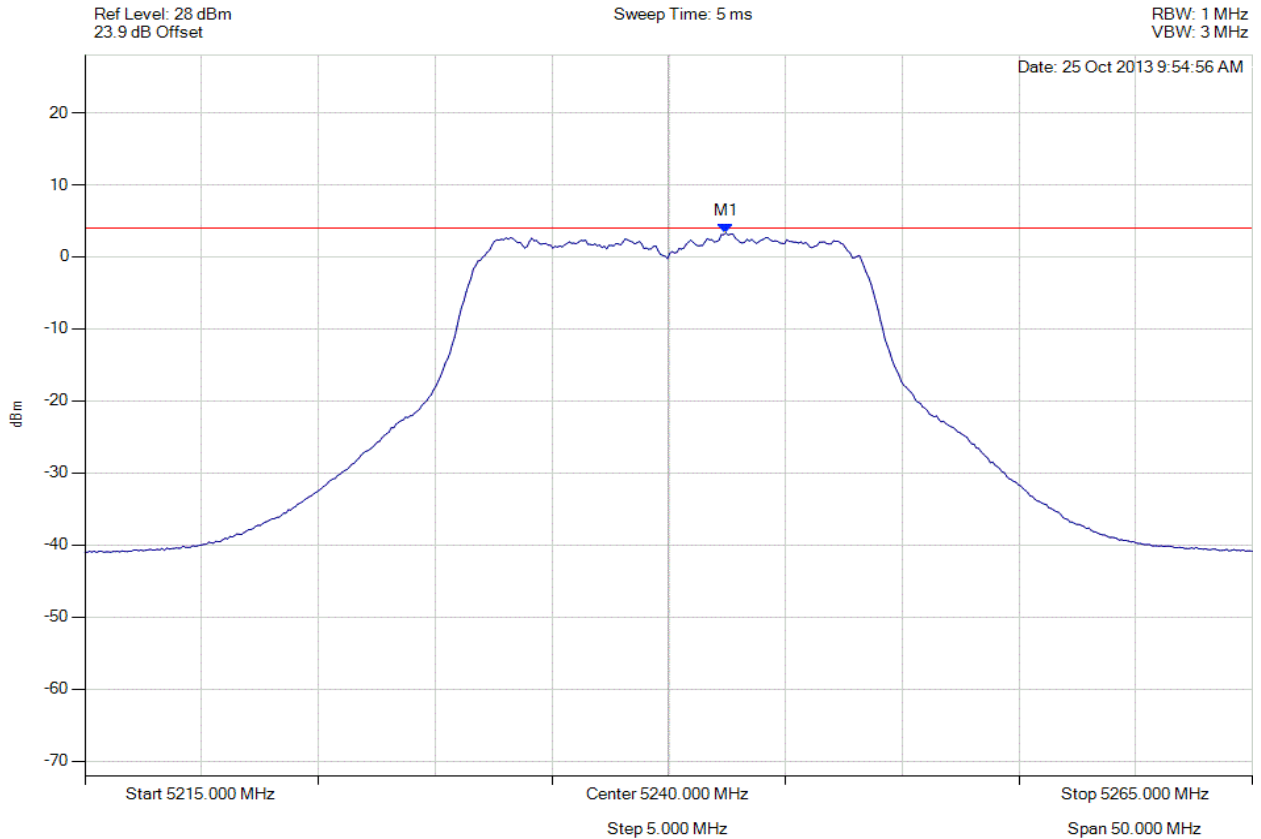

Analyser Setup	Marker : Frequency : Amplitude	Test Results
Detector = RMS Sweep Count = 100 RF Atten (dB) = 20 Trace Mode = VIEW	M1 : 5242.455 MHz : 3.324 dBm	Limit: ≤ 4.0 dBm Margin: -0.7 dB

[Back to the Matrix](#)

This test report may be reproduced in full only. The document may only be updated by MiCOM Labs personnel. Any changes will be noted in the Document History section of the report.



Title: Xirrus Inc. XI-AC1300, XI-AC867 (non-DFS Bands)
To: FCC 47 CFR Part 15.407 & IC RSS-210
Serial #: XIRR04-U6 Rev A
Issue Date: 29th April 2014
Page: 123 of 199



PEAK POWER SPECTRAL DENSITY

Variant: 802.11n HT-20, Channel: 5180.00 MHz, Chain a, Temp: Ambient, Voltage: 56 Vdc

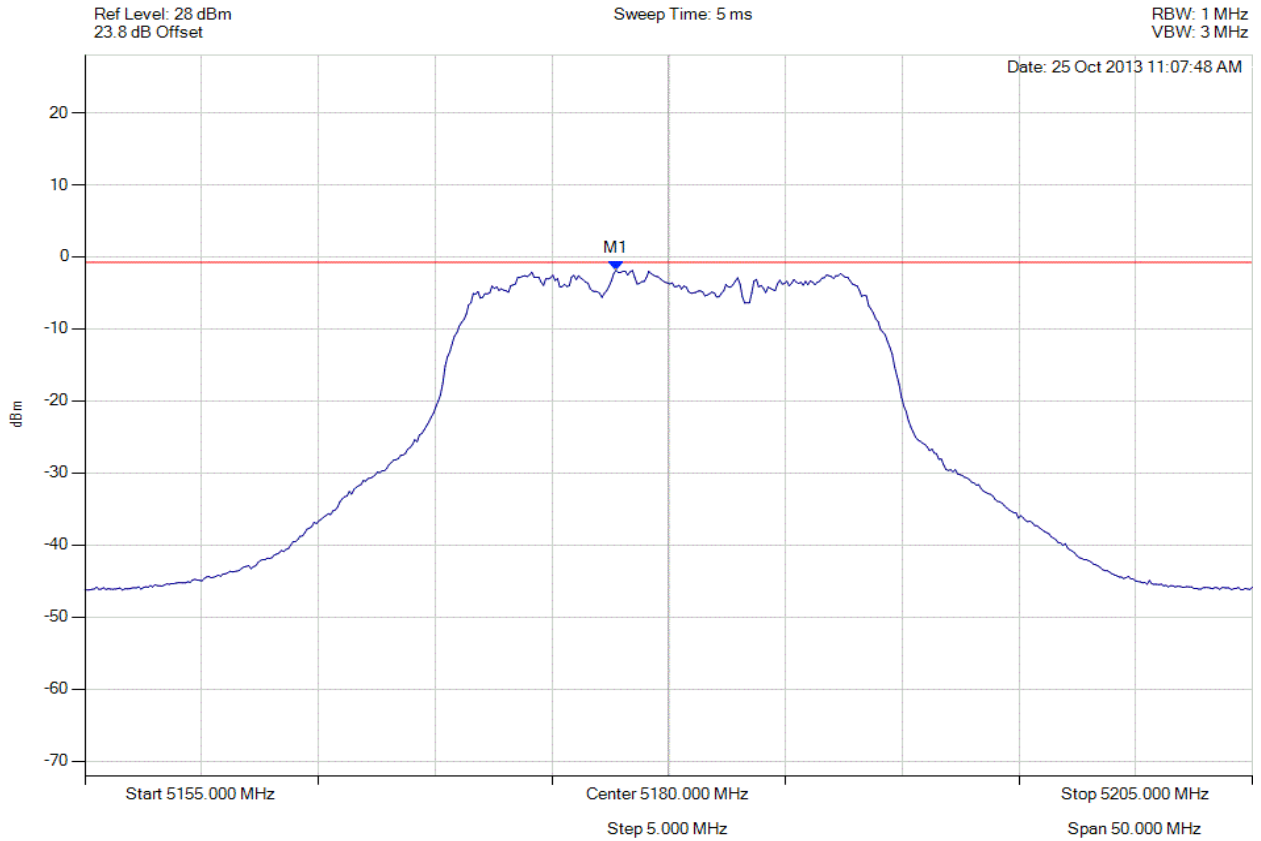

Analyser Setup	Marker : Frequency : Amplitude	Test Results
Detector = RMS Sweep Count = 100 RF Atten (dB) = 20 Trace Mode = VIEW	M1 : 5177.745 MHz : -1.865 dBm	Limit: ≤ -0.771 dBm Margin: 1.09 dB

[Back to the Matrix](#)

This test report may be reproduced in full only. The document may only be updated by MiCOM Labs personnel. Any changes will be noted in the Document History section of the report.



Title: Xirrus Inc. XI-AC1300, XI-AC867 (non-DFS Bands)
To: FCC 47 CFR Part 15.407 & IC RSS-210
Serial #: XIRR04-U6 Rev A
Issue Date: 29th April 2014
Page: 124 of 199



PEAK POWER SPECTRAL DENSITY

Variant: 802.11n HT-20, Channel: 5180.00 MHz, Chain b, Temp: Ambient, Voltage: 56 Vdc

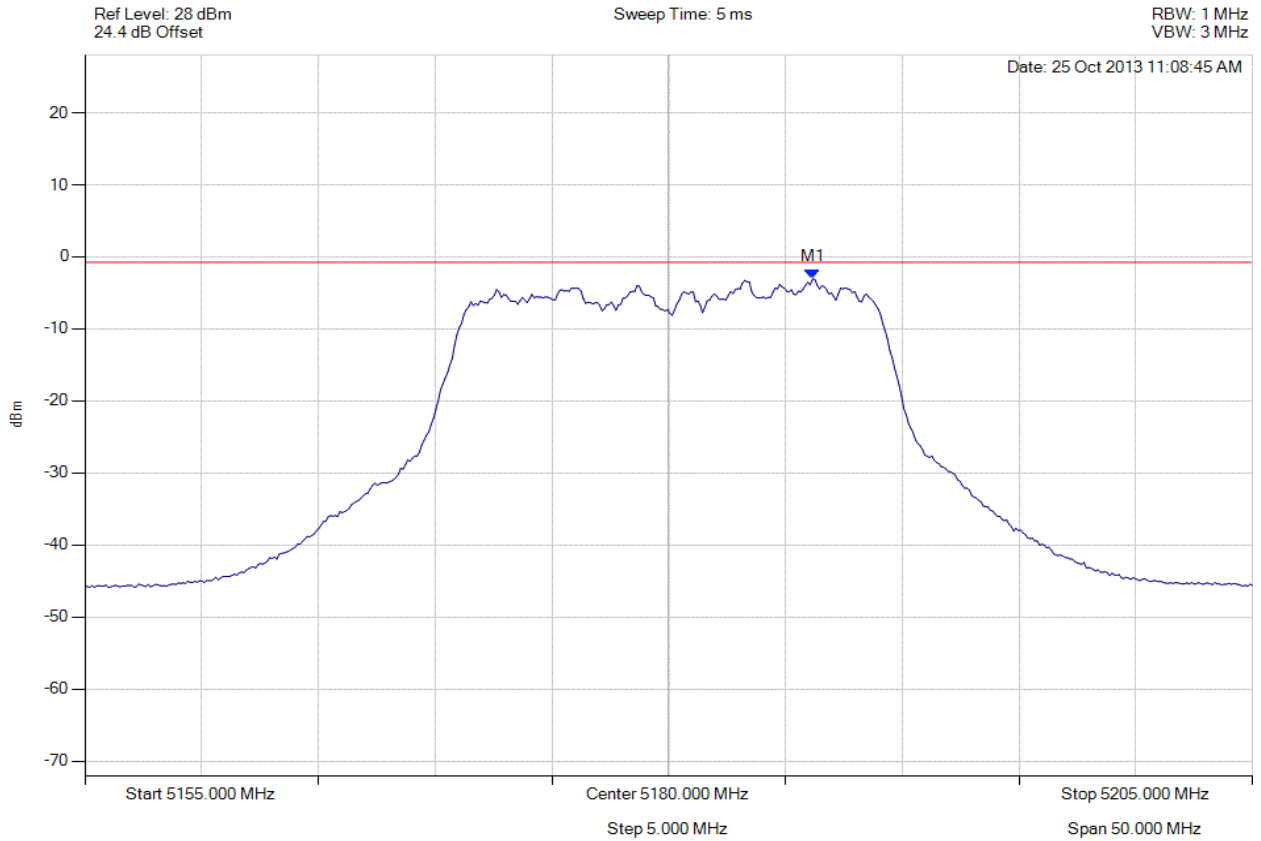

Analyser Setup	Marker : Frequency : Amplitude	Test Results
Detector = RMS Sweep Count = 100 RF Atten (dB) = 20 Trace Mode = VIEW	M1 : 5186.162 MHz : -3.073 dBm	Limit: ≤ -0.771 dBm Margin: 2.30 dB

[Back to the Matrix](#)

This test report may be reproduced in full only. The document may only be updated by MiCOM Labs personnel. Any changes will be noted in the Document History section of the report.



Title: Xirrus Inc. XI-AC1300, XI-AC867 (non-DFS Bands)
To: FCC 47 CFR Part 15.407 & IC RSS-210
Serial #: XIRR04-U6 Rev A
Issue Date: 29th April 2014
Page: 125 of 199



PEAK POWER SPECTRAL DENSITY

Variant: 802.11n HT-20, Channel: 5180.00 MHz, Chain c, Temp: Ambient, Voltage: 56 Vdc

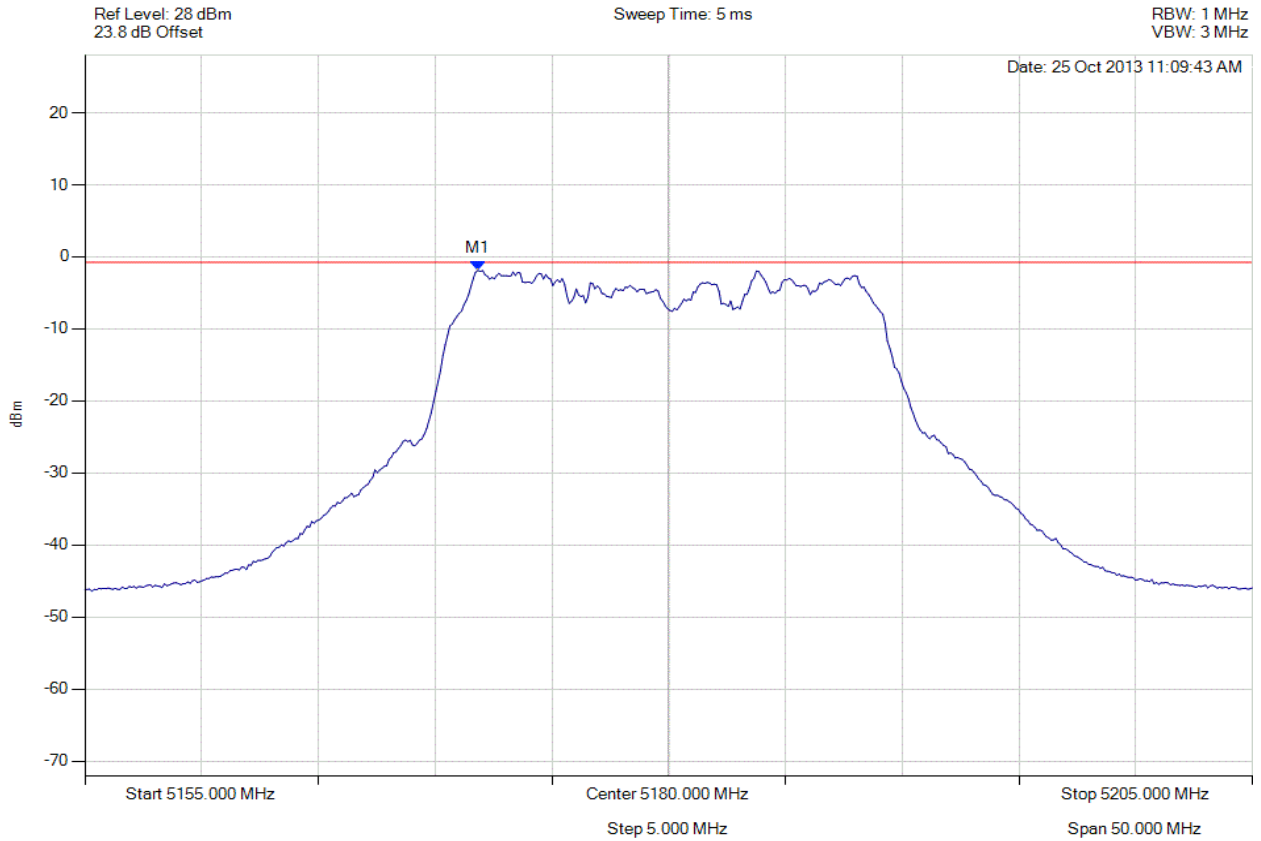

Analyser Setup	Marker : Frequency : Amplitude	Test Results
Detector = RMS Sweep Count = 100 RF Atten (dB) = 20 Trace Mode = VIEW	M1 : 5171.834 MHz : -1.879 dBm	Limit: ≤ -0.771 dBm Margin: 1.11 dB

[Back to the Matrix](#)

This test report may be reproduced in full only. The document may only be updated by MiCOM Labs personnel. Any changes will be noted in the Document History section of the report.



Title: Xirrus Inc. XI-AC1300, XI-AC867 (non-DFS Bands)
To: FCC 47 CFR Part 15.407 & IC RSS-210
Serial #: XIRR04-U6 Rev A
Issue Date: 29th April 2014
Page: 126 of 199



PEAK POWER SPECTRAL DENSITY

Variant: 802.11n HT-20, Channel: 5180.00 MHz, SUM, Temp: Ambient, Voltage: 56 Vdc

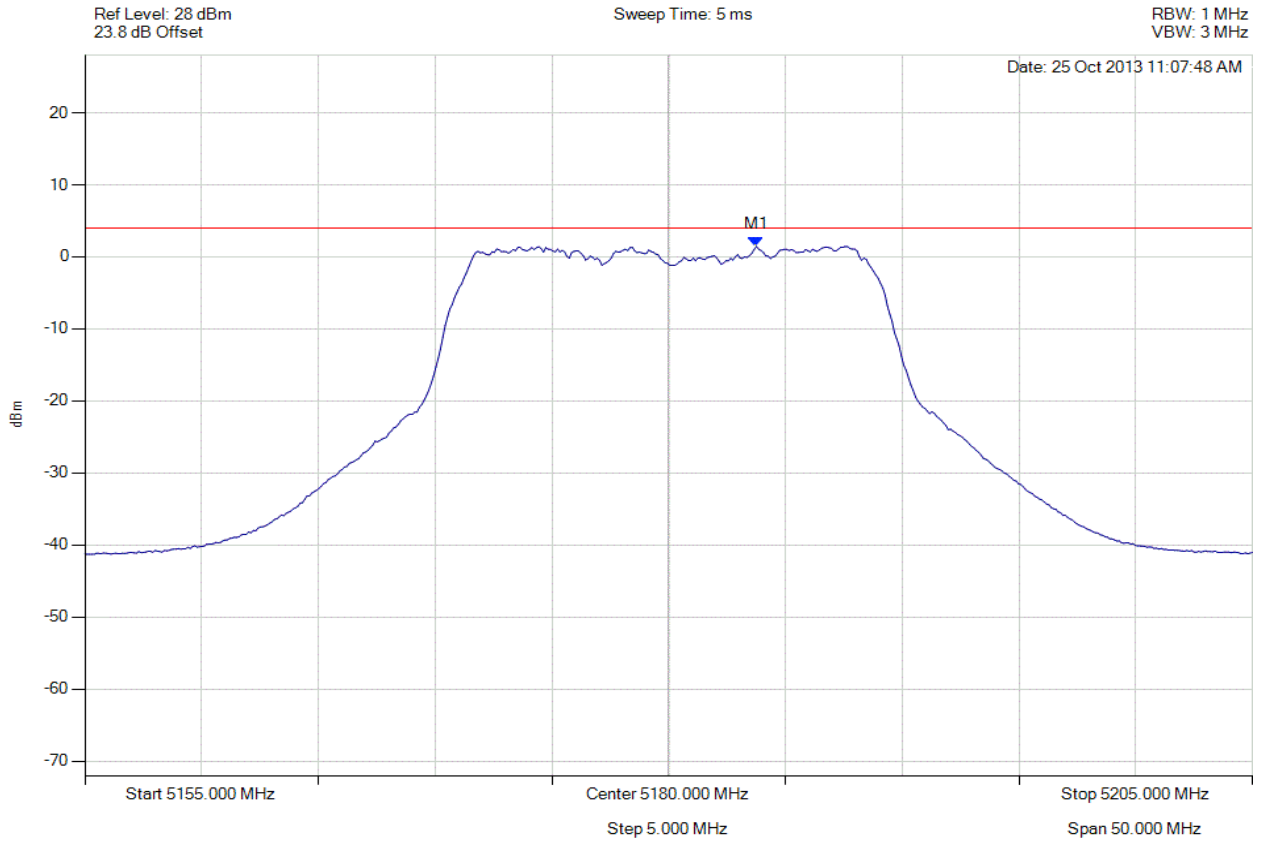

Analyser Setup	Marker : Frequency : Amplitude	Test Results
Detector = RMS Sweep Count = 100 RF Atten (dB) = 20 Trace Mode = VIEW	M1 : 5183.758 MHz : 1.444 dBm	Limit: ≤ 4.0 dBm Margin: -2.6 dB

[Back to the Matrix](#)

This test report may be reproduced in full only. The document may only be updated by MiCOM Labs personnel. Any changes will be noted in the Document History section of the report.



Title: Xirrus Inc. XI-AC1300, XI-AC867 (non-DFS Bands)
To: FCC 47 CFR Part 15.407 & IC RSS-210
Serial #: XIRR04-U6 Rev A
Issue Date: 29th April 2014
Page: 127 of 199



PEAK POWER SPECTRAL DENSITY

Variant: 802.11n HT-20, Channel: 5200.00 MHz, Chain a, Temp: Ambient, Voltage: 56 Vdc

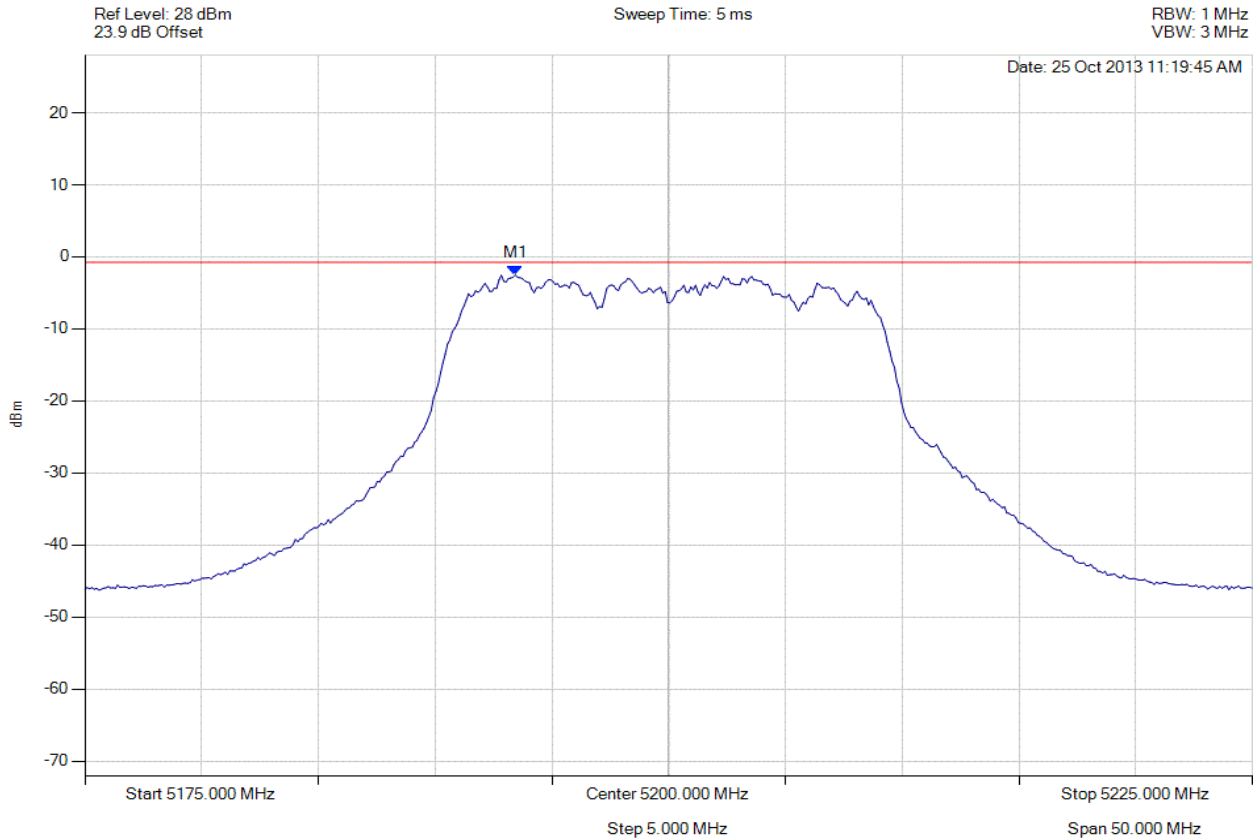

Analyser Setup	Marker : Frequency : Amplitude	Test Results
Detector = RMS Sweep Count = 100 RF Atten (dB) = 20 Trace Mode = VIEW	M1 : 5193.437 MHz : -2.526 dBm	Limit: ≤ -0.771 dBm Margin: 1.75 dB

[Back to the Matrix](#)

This test report may be reproduced in full only. The document may only be updated by MiCOM Labs personnel. Any changes will be noted in the Document History section of the report.



Title: Xirrus Inc. XI-AC1300, XI-AC867 (non-DFS Bands)
To: FCC 47 CFR Part 15.407 & IC RSS-210
Serial #: XIRR04-U6 Rev A
Issue Date: 29th April 2014
Page: 128 of 199



PEAK POWER SPECTRAL DENSITY

Variant: 802.11n HT-20, Channel: 5200.00 MHz, Chain b, Temp: Ambient, Voltage: 56 Vdc

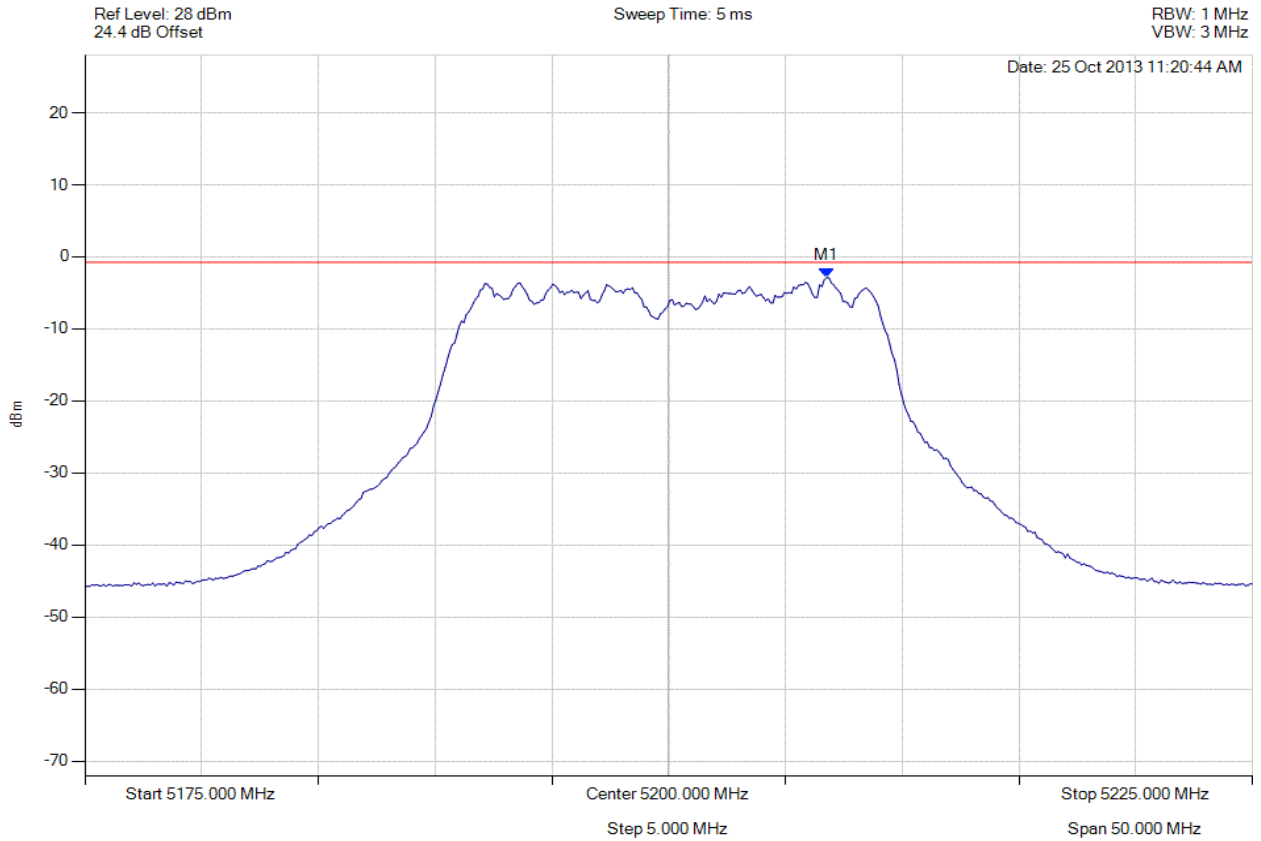

Analyser Setup	Marker : Frequency : Amplitude	Test Results
Detector = RMS Sweep Count = 100 RF Atten (dB) = 20 Trace Mode = VIEW	M1 : 5206.764 MHz : -2.887 dBm	Limit: ≤ -0.771 dBm Margin: 2.12 dB

[Back to the Matrix](#)

This test report may be reproduced in full only. The document may only be updated by MiCOM Labs personnel. Any changes will be noted in the Document History section of the report.



Title: Xirrus Inc. XI-AC1300, XI-AC867 (non-DFS Bands)
To: FCC 47 CFR Part 15.407 & IC RSS-210
Serial #: XIRR04-U6 Rev A
Issue Date: 29th April 2014
Page: 129 of 199



PEAK POWER SPECTRAL DENSITY

Variant: 802.11n HT-20, Channel: 5200.00 MHz, Chain c, Temp: Ambient, Voltage: 56 Vdc

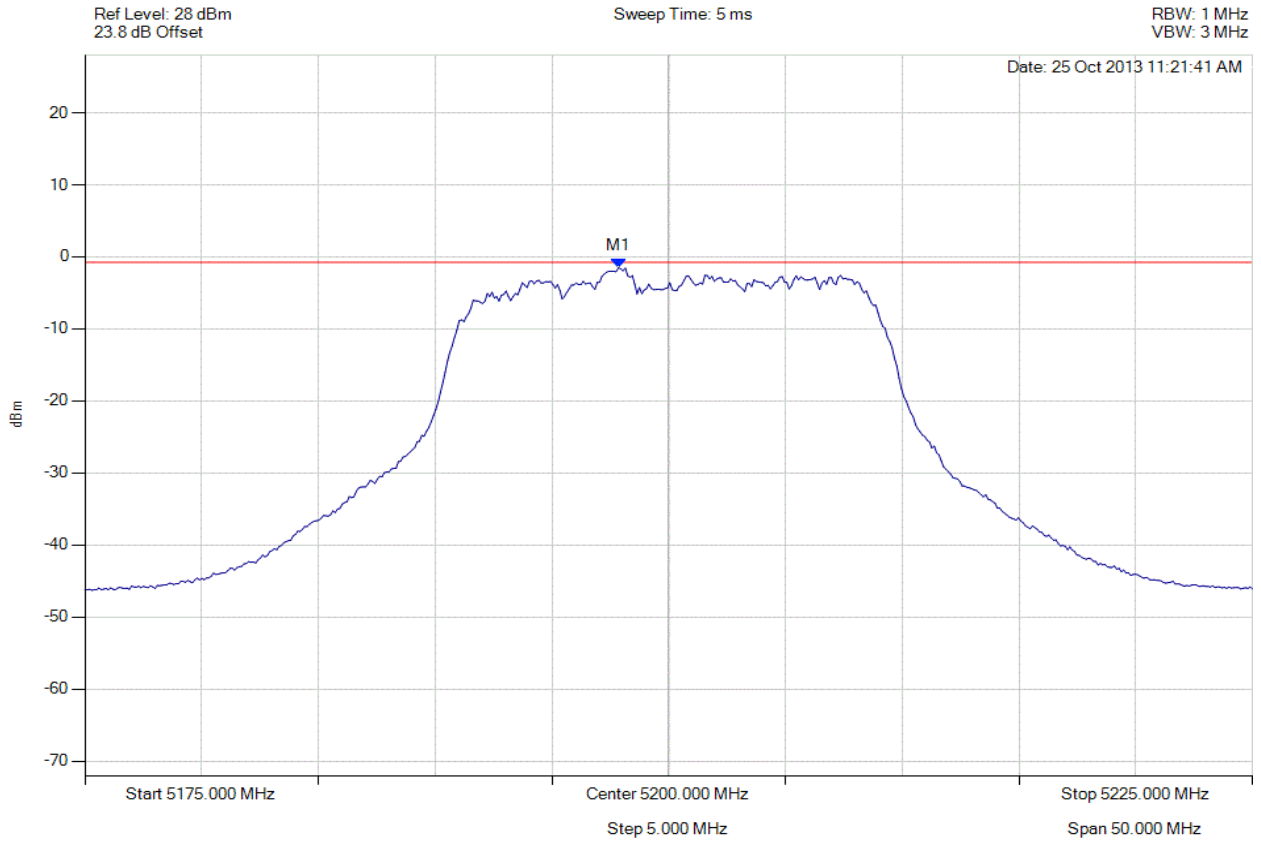

Analyser Setup	Marker : Frequency : Amplitude	Test Results
Detector = RMS Sweep Count = 100 RF Atten (dB) = 20 Trace Mode = VIEW	M1 : 5197.846 MHz : -1.530 dBm	Limit: ≤ -0.771 dBm Margin: 0.76 dB

[Back to the Matrix](#)

This test report may be reproduced in full only. The document may only be updated by MiCOM Labs personnel. Any changes will be noted in the Document History section of the report.



Title: Xirrus Inc. XI-AC1300, XI-AC867 (non-DFS Bands)
To: FCC 47 CFR Part 15.407 & IC RSS-210
Serial #: XIRR04-U6 Rev A
Issue Date: 29th April 2014
Page: 130 of 199



PEAK POWER SPECTRAL DENSITY

Variant: 802.11n HT-20, Channel: 5200.00 MHz, SUM, Temp: Ambient, Voltage: 56 Vdc

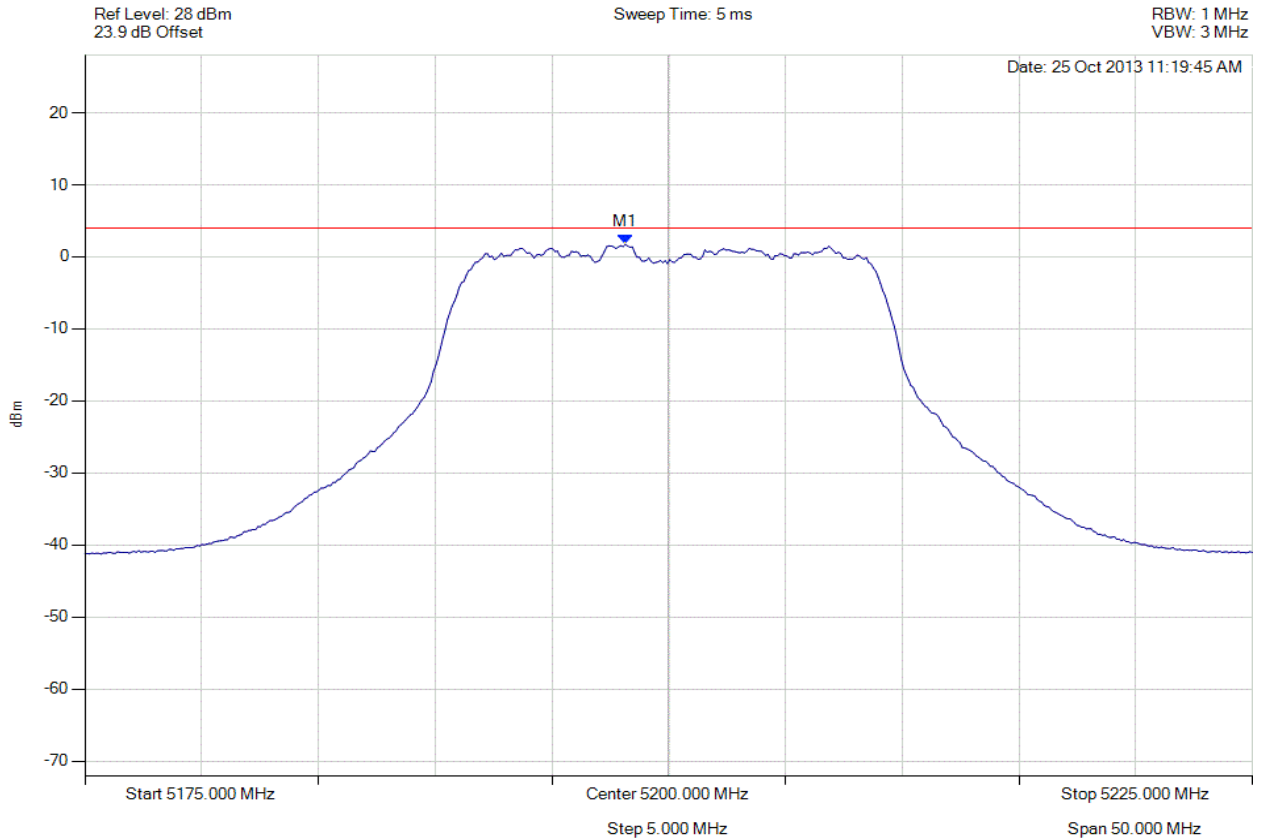

Analyser Setup	Marker : Frequency : Amplitude	Test Results
Detector = RMS Sweep Count = 100 RF Atten (dB) = 20 Trace Mode = VIEW	M1 : 5198.146 MHz : 1.741 dBm	Limit: ≤ 4.0 dBm Margin: -2.3 dB

[Back to the Matrix](#)

This test report may be reproduced in full only. The document may only be updated by MiCOM Labs personnel. Any changes will be noted in the Document History section of the report.



Title: Xirrus Inc. XI-AC1300, XI-AC867 (non-DFS Bands)
To: FCC 47 CFR Part 15.407 & IC RSS-210
Serial #: XIRR04-U6 Rev A
Issue Date: 29th April 2014
Page: 131 of 199



PEAK POWER SPECTRAL DENSITY

Variant: 802.11n HT-20, Channel: 5240.00 MHz, Chain a, Temp: Ambient, Voltage: 56 Vdc

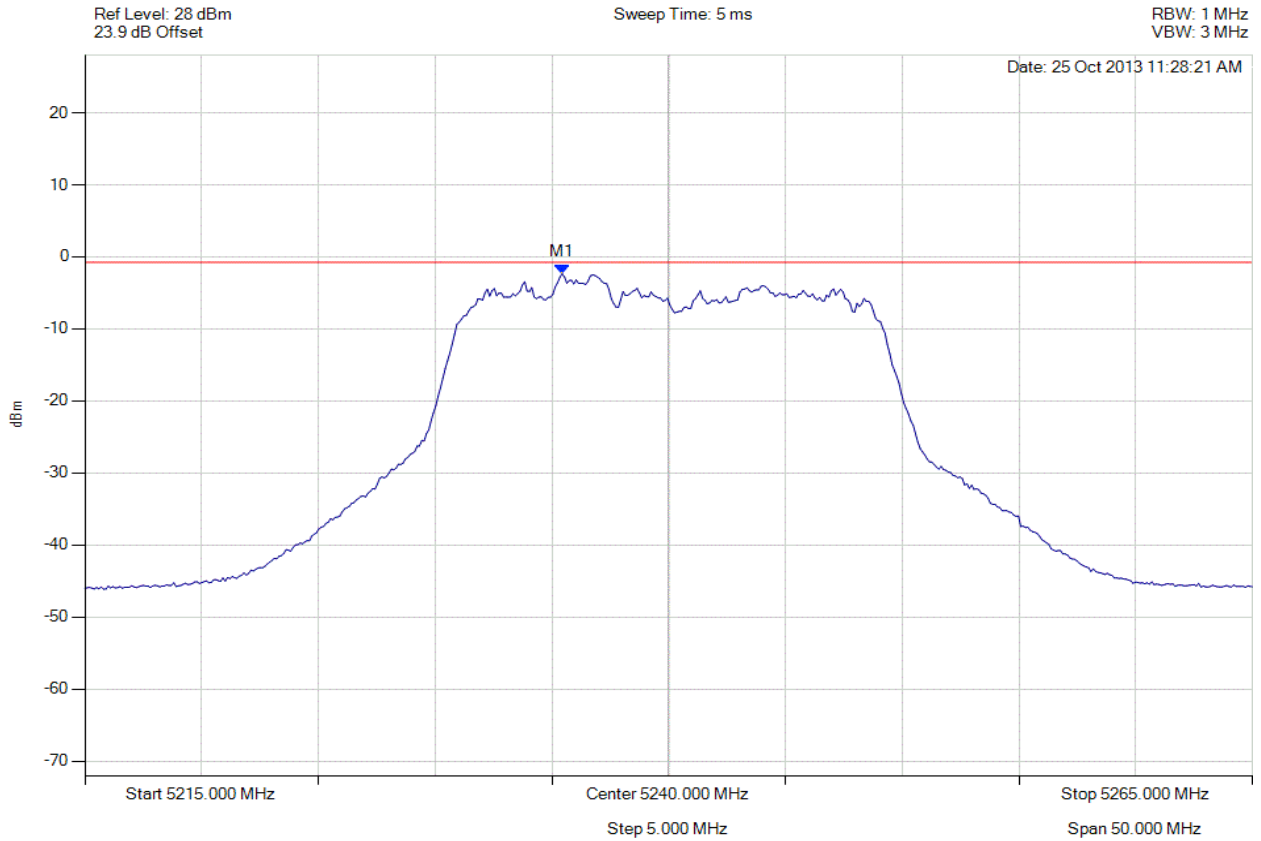

Analyser Setup	Marker : Frequency : Amplitude	Test Results
Detector = RMS Sweep Count = 100 RF Atten (dB) = 20 Trace Mode = VIEW	M1 : 5235.441 MHz : -2.349 dBm	Limit: ≤ -0.771 dBm Margin: 1.58 dB

[Back to the Matrix](#)

This test report may be reproduced in full only. The document may only be updated by MiCOM Labs personnel. Any changes will be noted in the Document History section of the report.



Title: Xirrus Inc. XI-AC1300, XI-AC867 (non-DFS Bands)
To: FCC 47 CFR Part 15.407 & IC RSS-210
Serial #: XIRR04-U6 Rev A
Issue Date: 29th April 2014
Page: 132 of 199



PEAK POWER SPECTRAL DENSITY

Variant: 802.11n HT-20, Channel: 5240.00 MHz, Chain b, Temp: Ambient, Voltage: 56 Vdc

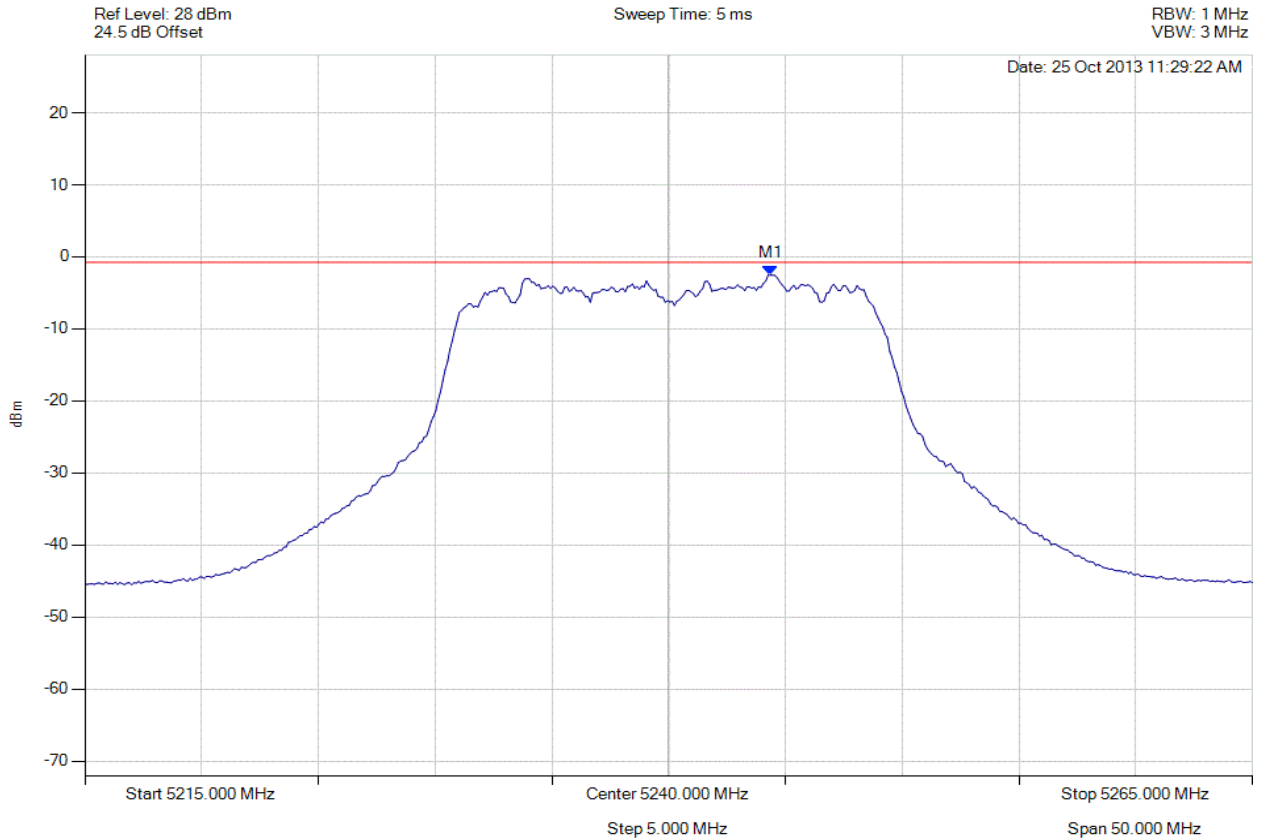

Analyser Setup	Marker : Frequency : Amplitude	Test Results
Detector = RMS Sweep Count = 100 RF Atten (dB) = 20 Trace Mode = VIEW	M1 : 5244.359 MHz : -2.530 dBm	Limit: ≤ -0.771 dBm Margin: 1.76 dB

[Back to the Matrix](#)

This test report may be reproduced in full only. The document may only be updated by MiCOM Labs personnel. Any changes will be noted in the Document History section of the report.



Title: Xirrus Inc. XI-AC1300, XI-AC867 (non-DFS Bands)
To: FCC 47 CFR Part 15.407 & IC RSS-210
Serial #: XIRR04-U6 Rev A
Issue Date: 29th April 2014
Page: 133 of 199



PEAK POWER SPECTRAL DENSITY

Variant: 802.11n HT-20, Channel: 5240.00 MHz, Chain c, Temp: Ambient, Voltage: 56 Vdc

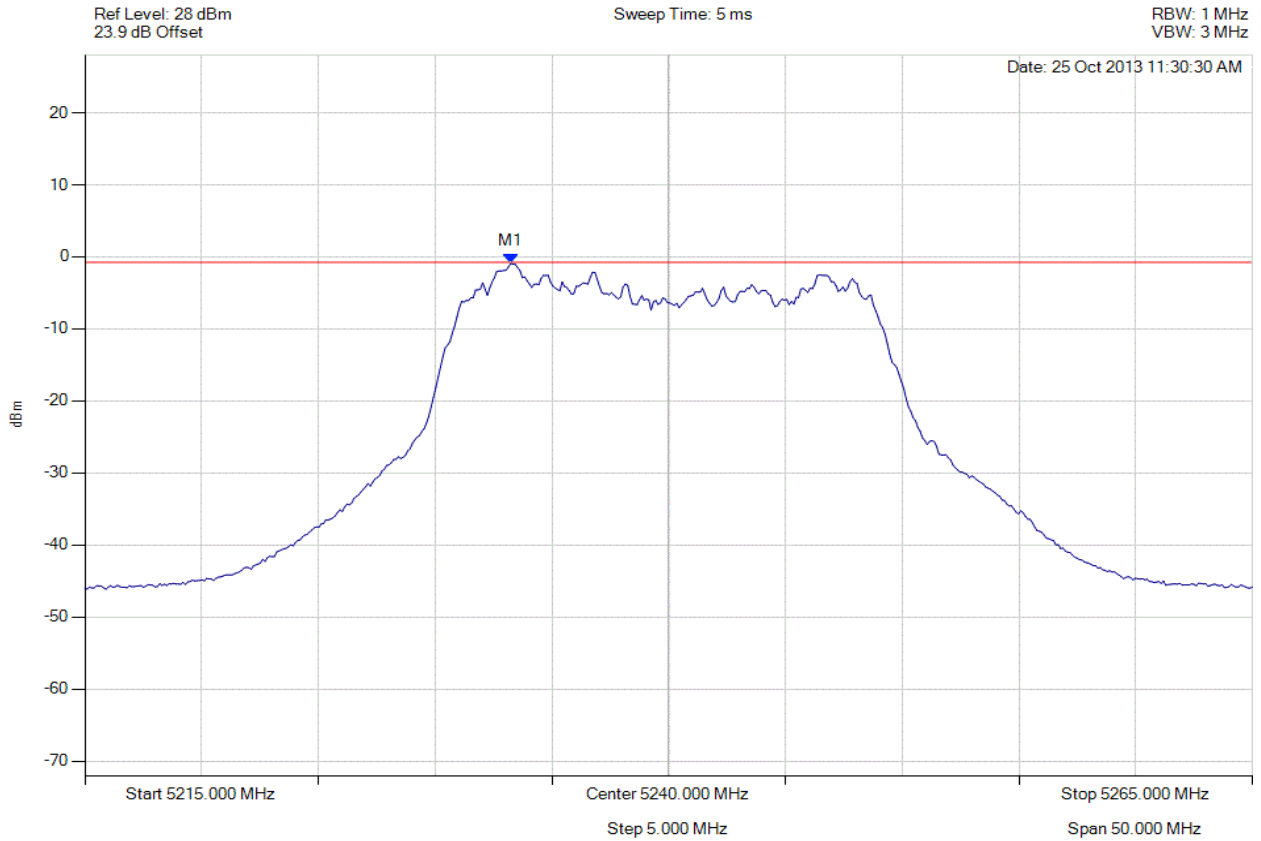

Analyser Setup	Marker : Frequency : Amplitude	Test Results
Detector = RMS Sweep Count = 100 RF Atten (dB) = 20 Trace Mode = VIEW	M1 : 5233.236 MHz : -0.945 dBm	Limit: ≤ -0.771 dBm Margin: 0.17 dB

[Back to the Matrix](#)

This test report may be reproduced in full only. The document may only be updated by MiCOM Labs personnel. Any changes will be noted in the Document History section of the report.



Title: Xirrus Inc. XI-AC1300, XI-AC867 (non-DFS Bands)
To: FCC 47 CFR Part 15.407 & IC RSS-210
Serial #: XIRR04-U6 Rev A
Issue Date: 29th April 2014
Page: 134 of 199



PEAK POWER SPECTRAL DENSITY

Variant: 802.11n HT-20, Channel: 5240.00 MHz, SUM, Temp: Ambient, Voltage: 56 Vdc

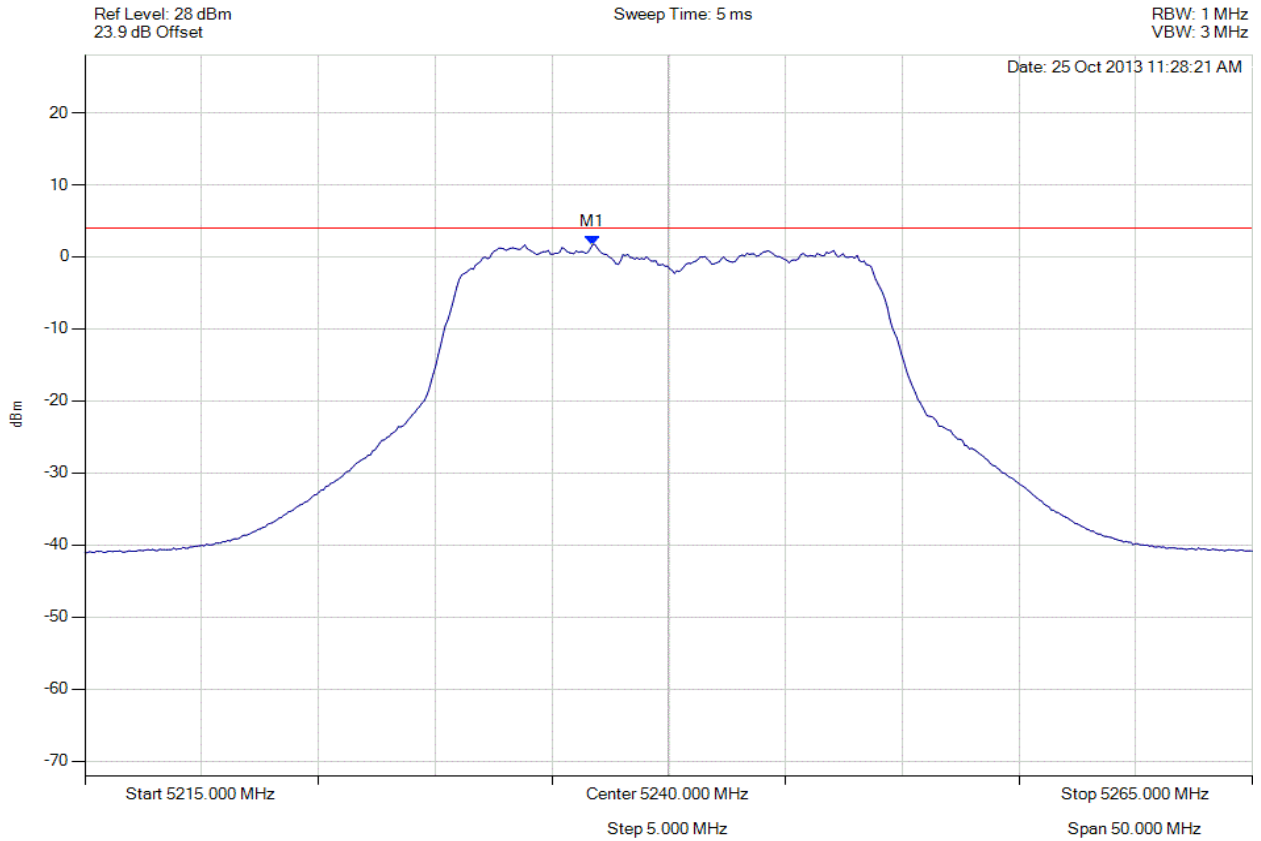

Analyser Setup	Marker : Frequency : Amplitude	Test Results
Detector = RMS Sweep Count = 100 RF Atten (dB) = 20 Trace Mode = VIEW	M1 : 5236.743 MHz : 1.710 dBm	Limit: ≤ 4.0 dBm Margin: -2.3 dB

[Back to the Matrix](#)

This test report may be reproduced in full only. The document may only be updated by MiCOM Labs personnel. Any changes will be noted in the Document History section of the report.



Title: Xirrus Inc. XI-AC1300, XI-AC867 (non-DFS Bands)
To: FCC 47 CFR Part 15.407 & IC RSS-210
Serial #: XIRR04-U6 Rev A
Issue Date: 29th April 2014
Page: 135 of 199



PEAK POWER SPECTRAL DENSITY

Variant: 802.11n HT-40, Channel: 5190.00 MHz, Chain a, Temp: Ambient, Voltage: 48 Vdc

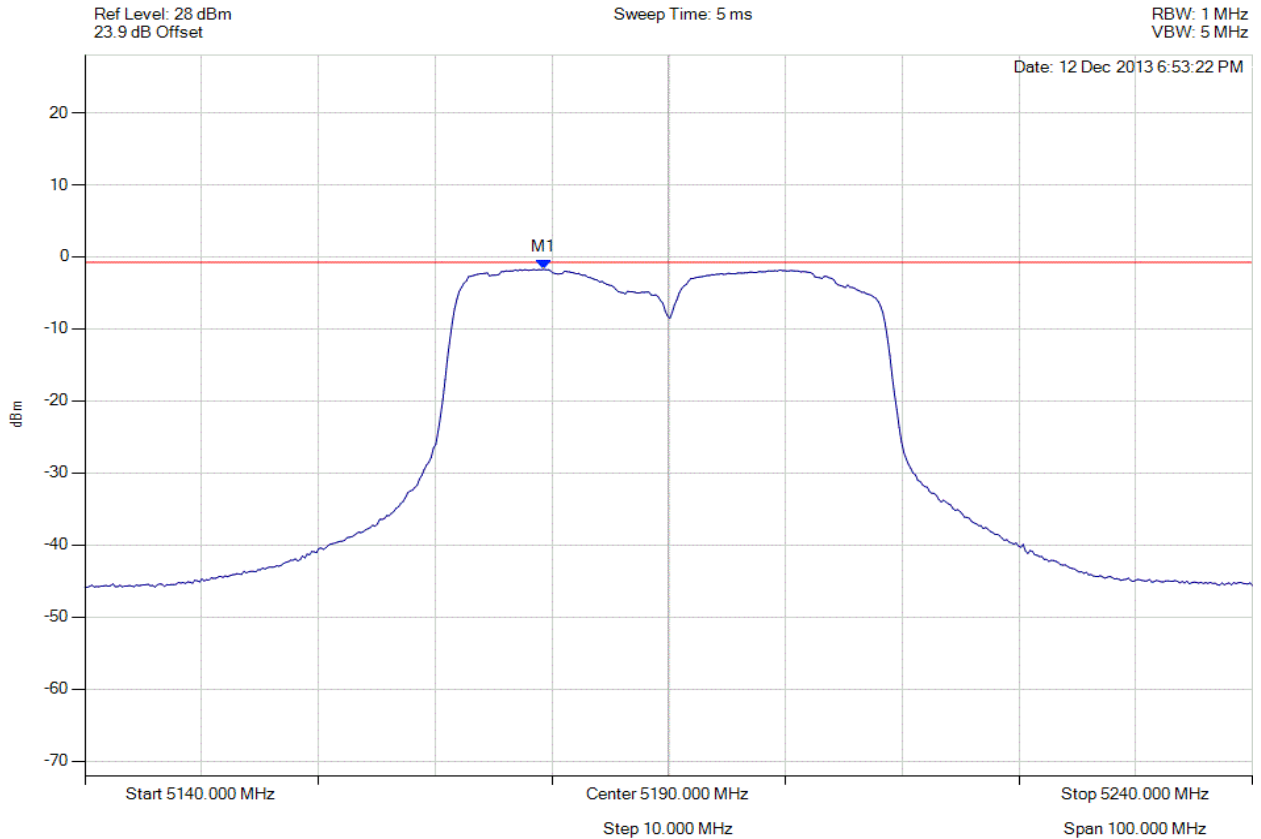

Analyser Setup	Marker : Frequency : Amplitude	Test Results
Detector = RMS Sweep Count = 100 RF Atten (dB) = 20 Trace Mode = VIEW	M1 : 5179.279 MHz : -1.747 dBm	Limit: ≤ -0.771 dBm Margin: 0.98 dB

[Back to the Matrix](#)

This test report may be reproduced in full only. The document may only be updated by MiCOM Labs personnel. Any changes will be noted in the Document History section of the report.



Title: Xirrus Inc. XI-AC1300, XI-AC867 (non-DFS Bands)
To: FCC 47 CFR Part 15.407 & IC RSS-210
Serial #: XIRR04-U6 Rev A
Issue Date: 29th April 2014
Page: 136 of 199



PEAK POWER SPECTRAL DENSITY

Variant: 802.11n HT-40, Channel: 5190.00 MHz, Chain b, Temp: Ambient, Voltage: 48 Vdc

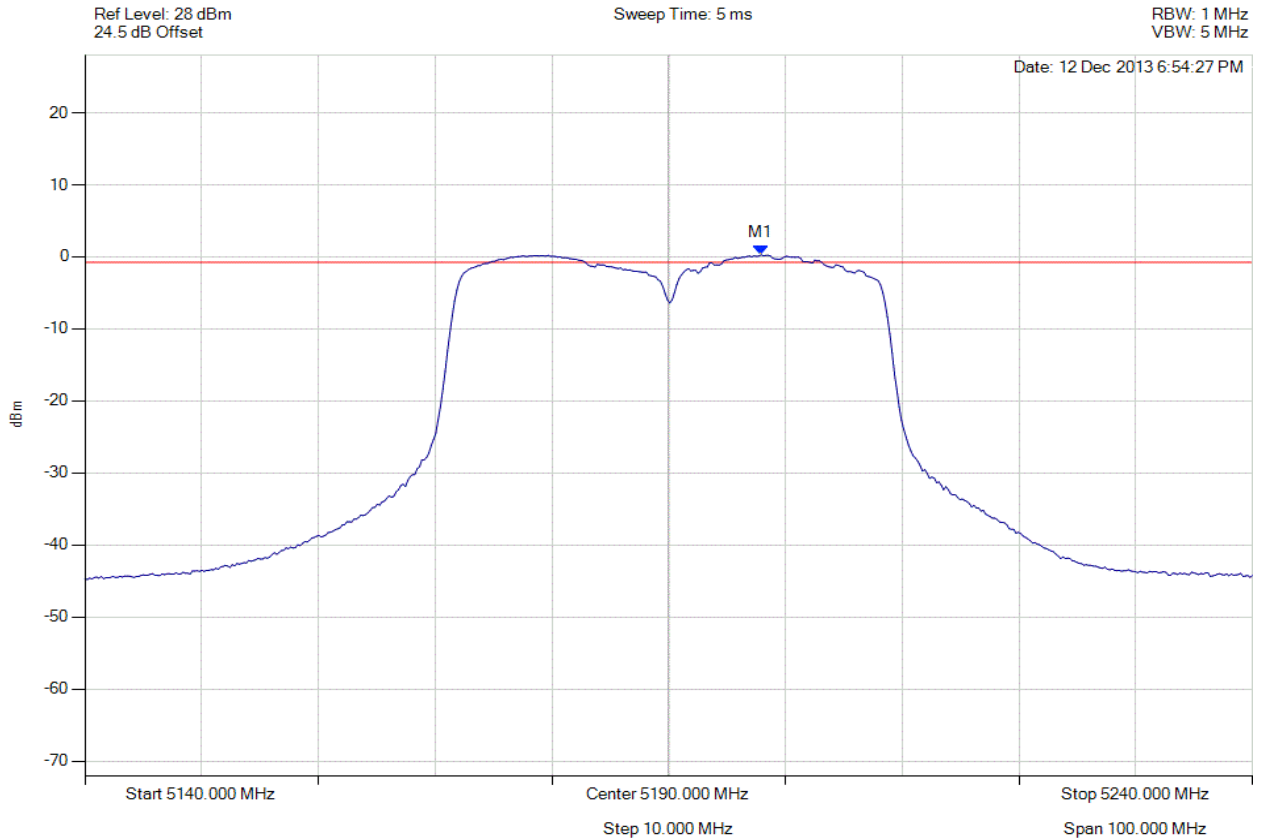

Analyser Setup	Marker : Frequency : Amplitude	Test Results
Detector = RMS Sweep Count = 100 RF Atten (dB) = 20 Trace Mode = VIEW	M1 : 5197.916 MHz : 0.278 dBm	Limit: ≤ -0.771 dBm Margin: 1.05 dB

[Back to the Matrix](#)

This test report may be reproduced in full only. The document may only be updated by MiCOM Labs personnel. Any changes will be noted in the Document History section of the report.



Title: Xirrus Inc. XI-AC1300, XI-AC867 (non-DFS Bands)
To: FCC 47 CFR Part 15.407 & IC RSS-210
Serial #: XIRR04-U6 Rev A
Issue Date: 29th April 2014
Page: 137 of 199



PEAK POWER SPECTRAL DENSITY

Variant: 802.11n HT-40, Channel: 5190.00 MHz, Chain c, Temp: Ambient, Voltage: 48 Vdc

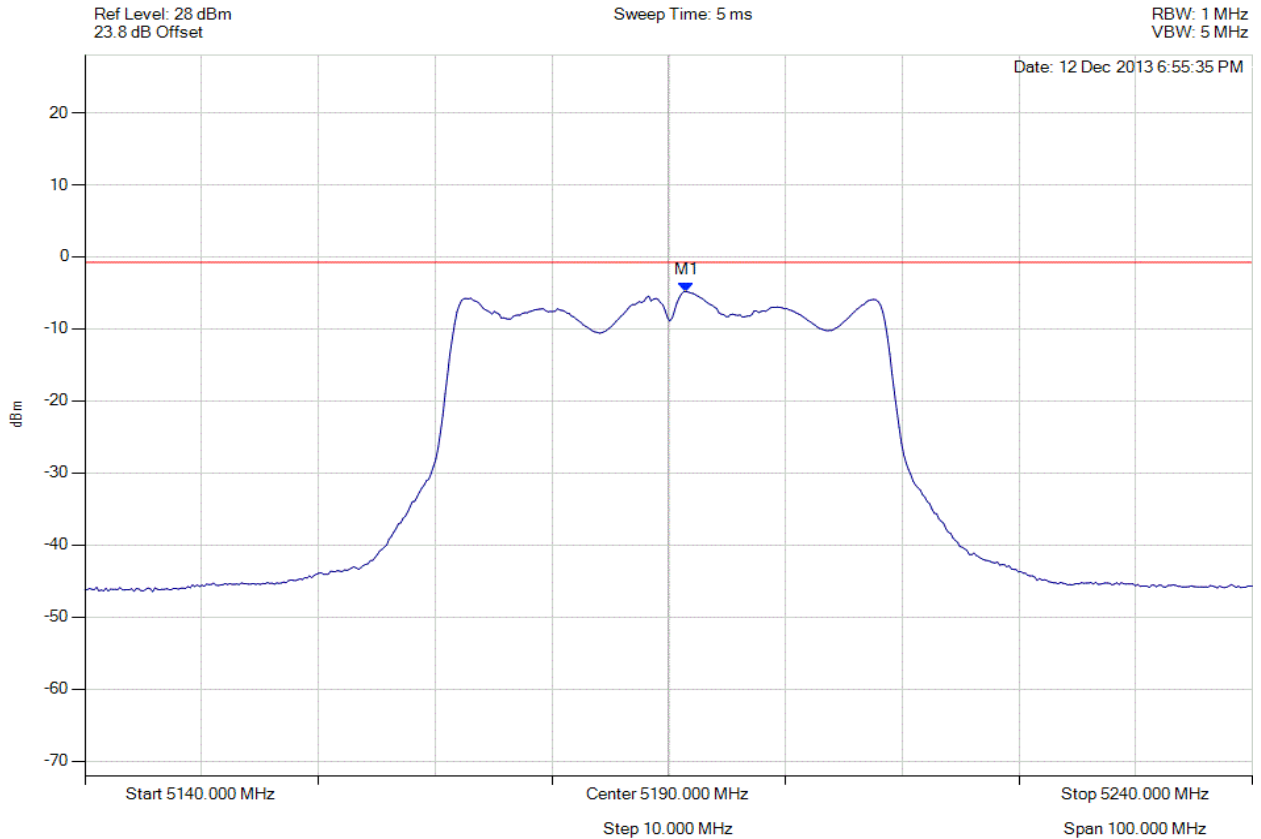

Analyser Setup	Marker : Frequency : Amplitude	Test Results
Detector = RMS Sweep Count = 100 RF Atten (dB) = 20 Trace Mode = VIEW	M1 : 5191.503 MHz : -4.829 dBm	Limit: ≤ -0.771 dBm Margin: 4.06 dB

[Back to the Matrix](#)

This test report may be reproduced in full only. The document may only be updated by MiCOM Labs personnel. Any changes will be noted in the Document History section of the report.



Title: Xirrus Inc. XI-AC1300, XI-AC867 (non-DFS Bands)
To: FCC 47 CFR Part 15.407 & IC RSS-210
Serial #: XIRR04-U6 Rev A
Issue Date: 29th April 2014
Page: 138 of 199



PEAK POWER SPECTRAL DENSITY

Variant: 802.11n HT-40, Channel: 5190.00 MHz, SUM, Temp: Ambient, Voltage: 48 Vdc

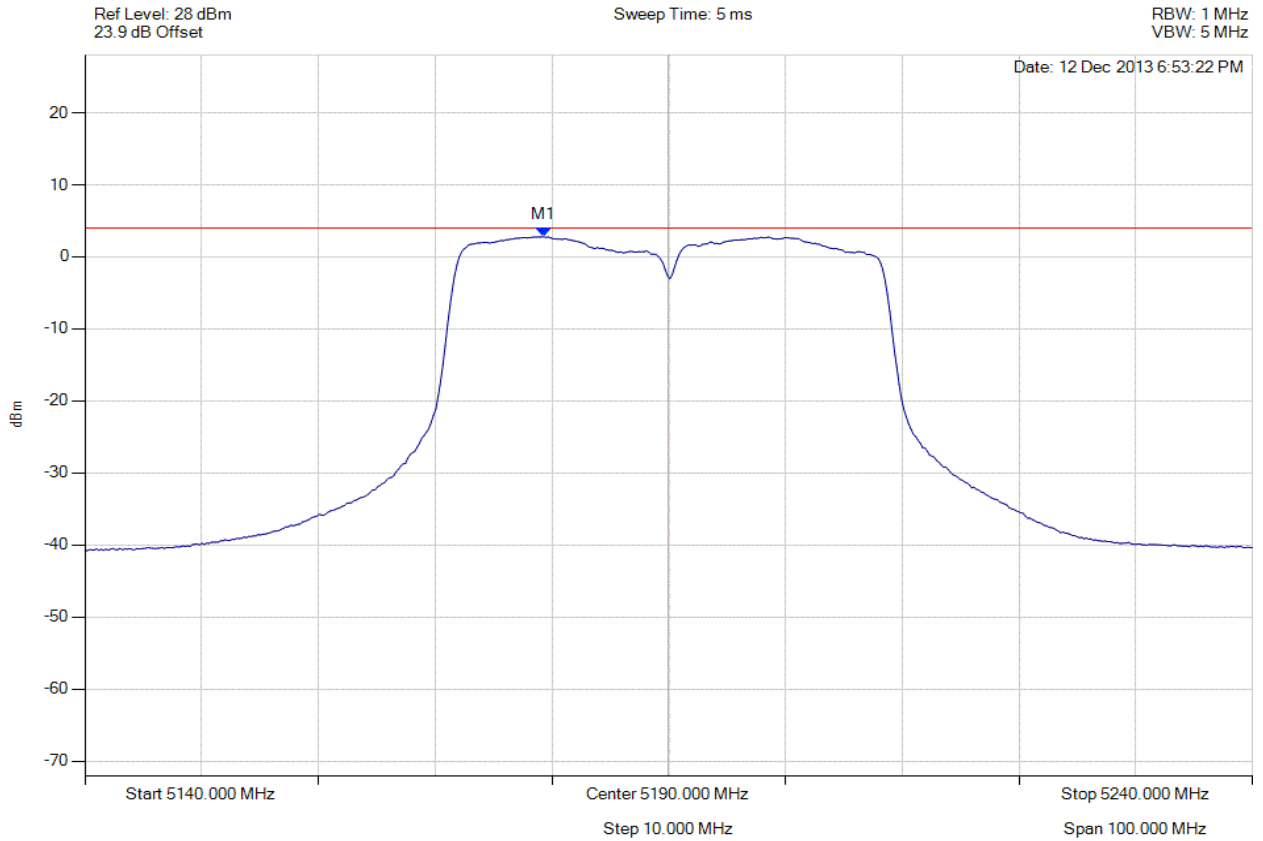

Analyser Setup	Marker : Frequency : Amplitude	Test Results
Detector = RMS Sweep Count = 100 RF Atten (dB) = 20 Trace Mode = VIEW	M1 : 5179.279 MHz : 2.776 dBm	Limit: ≤ 4.0 dBm Margin: -1.2 dB

[Back to the Matrix](#)

This test report may be reproduced in full only. The document may only be updated by MiCOM Labs personnel. Any changes will be noted in the Document History section of the report.



Title: Xirrus Inc. XI-AC1300, XI-AC867 (non-DFS Bands)
To: FCC 47 CFR Part 15.407 & IC RSS-210
Serial #: XIRR04-U6 Rev A
Issue Date: 29th April 2014
Page: 139 of 199



PEAK POWER SPECTRAL DENSITY

Variant: 802.11n HT-40, Channel: 5230.00 MHz, Chain a, Temp: Ambient, Voltage: 48 Vdc

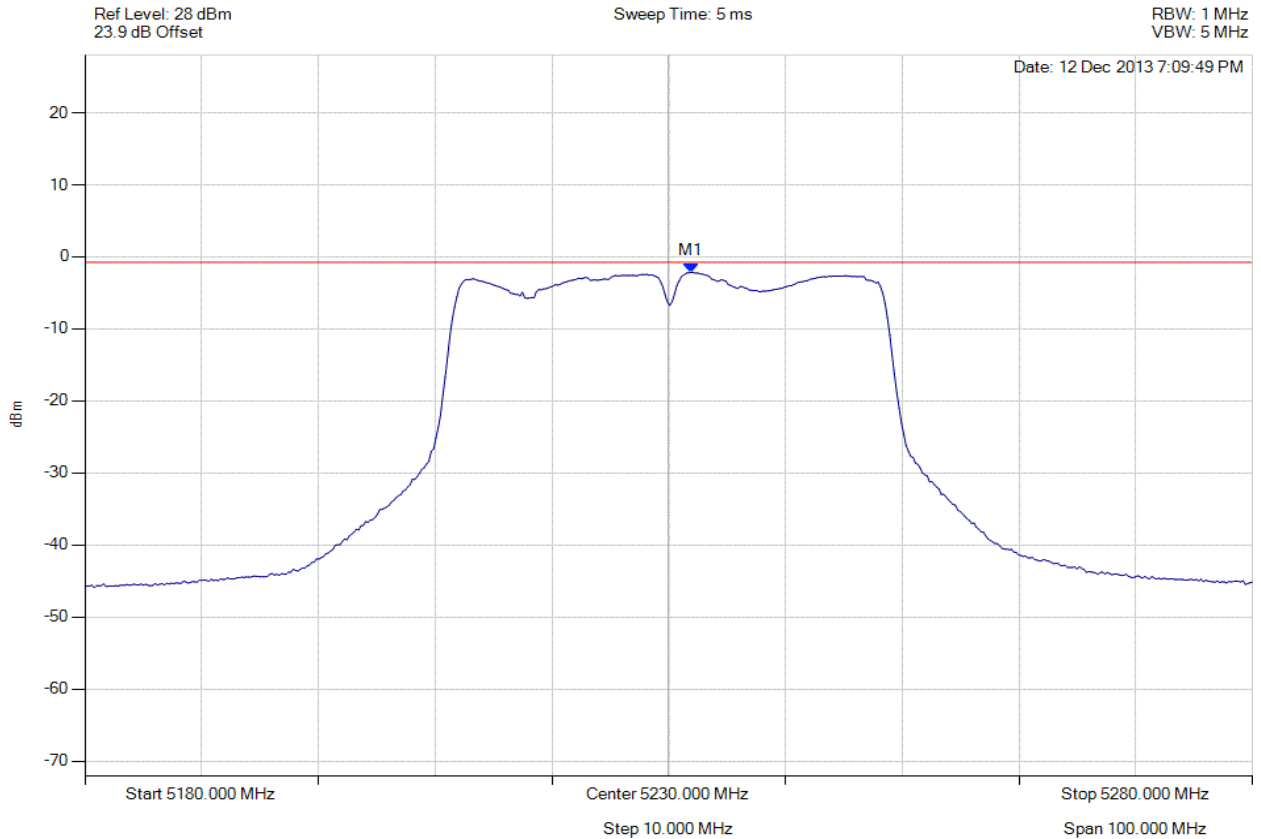

Analyser Setup	Marker : Frequency : Amplitude	Test Results
Detector = RMS Sweep Count = 100 RF Atten (dB) = 20 Trace Mode = VIEW	M1 : 5231.904 MHz : -2.175 dBm	Limit: ≤ -0.771 dBm Margin: 1.40 dB

[Back to the Matrix](#)

This test report may be reproduced in full only. The document may only be updated by MiCOM Labs personnel. Any changes will be noted in the Document History section of the report.



Title: Xirrus Inc. XI-AC1300, XI-AC867 (non-DFS Bands)
To: FCC 47 CFR Part 15.407 & IC RSS-210
Serial #: XIRR04-U6 Rev A
Issue Date: 29th April 2014
Page: 140 of 199



PEAK POWER SPECTRAL DENSITY

Variant: 802.11n HT-40, Channel: 5230.00 MHz, Chain b, Temp: Ambient, Voltage: 48 Vdc

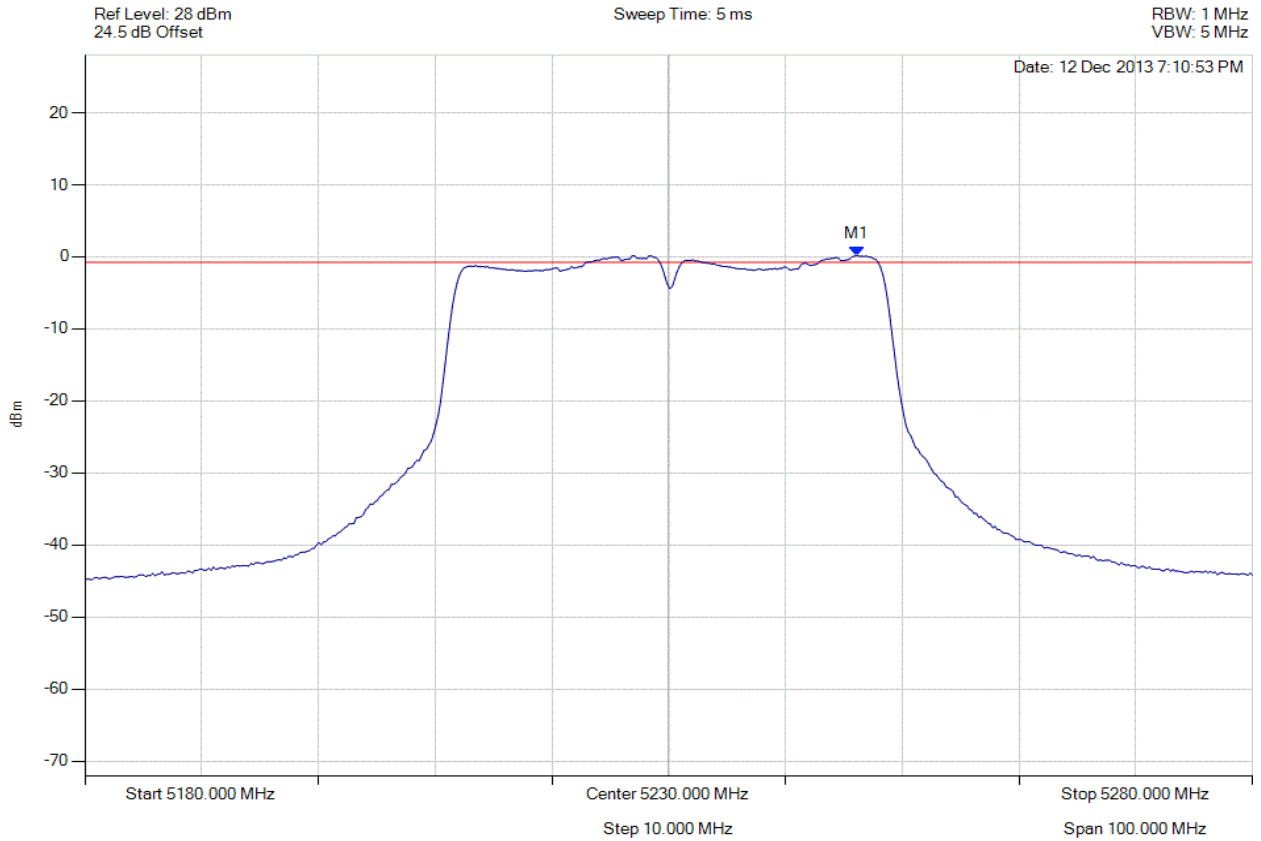

Analyser Setup	Marker : Frequency : Amplitude	Test Results
Detector = RMS Sweep Count = 100 RF Atten (dB) = 20 Trace Mode = VIEW	M1 : 5246.132 MHz : 0.190 dBm	Limit: ≤ -0.771 dBm Margin: 0.96 dB

[Back to the Matrix](#)

This test report may be reproduced in full only. The document may only be updated by MiCOM Labs personnel. Any changes will be noted in the Document History section of the report.



Title: Xirrus Inc. XI-AC1300, XI-AC867 (non-DFS Bands)
To: FCC 47 CFR Part 15.407 & IC RSS-210
Serial #: XIRR04-U6 Rev A
Issue Date: 29th April 2014
Page: 141 of 199



PEAK POWER SPECTRAL DENSITY

Variant: 802.11n HT-40, Channel: 5230.00 MHz, Chain c, Temp: Ambient, Voltage: 48 Vdc

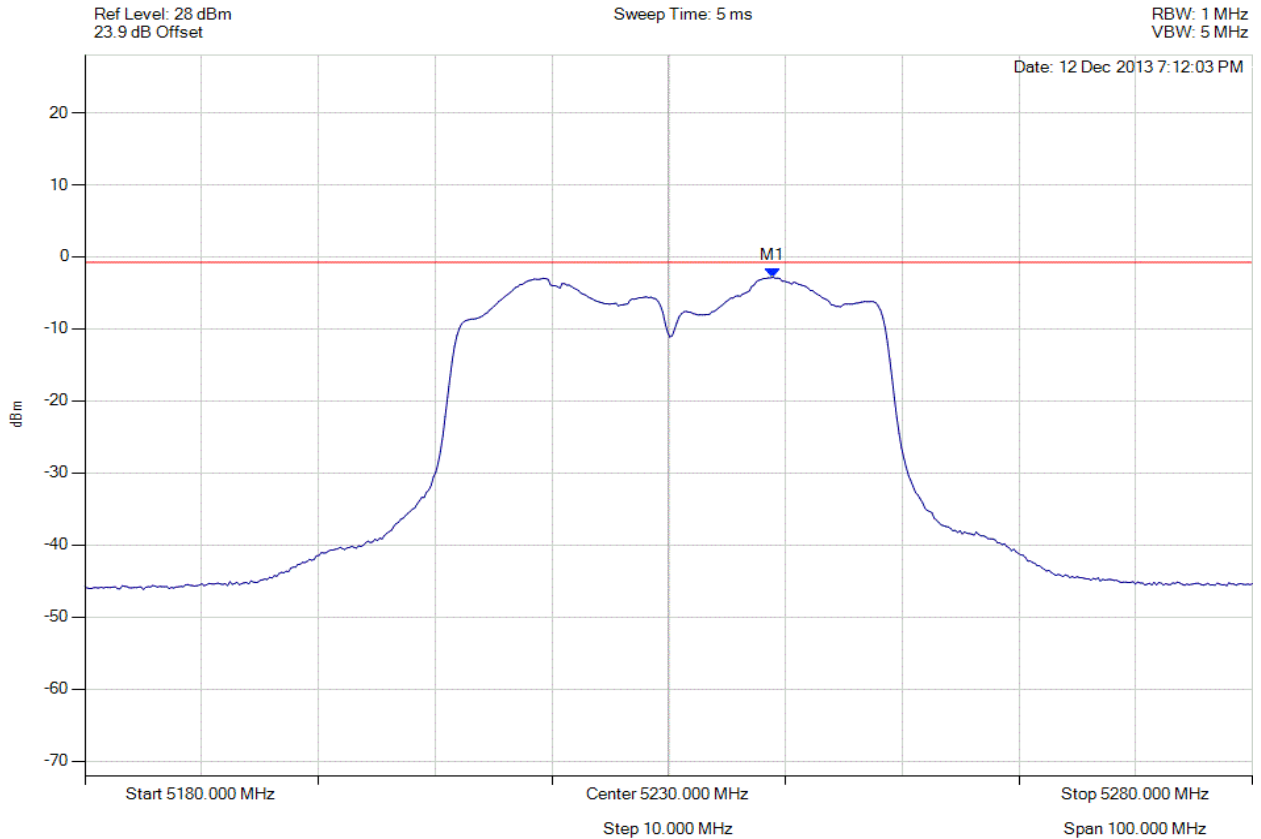

Analyser Setup	Marker : Frequency : Amplitude	Test Results
Detector = RMS Sweep Count = 100 RF Atten (dB) = 20 Trace Mode = VIEW	M1 : 5238.918 MHz : -2.837 dBm	Limit: ≤ -0.771 dBm Margin: 2.07 dB

[Back to the Matrix](#)

This test report may be reproduced in full only. The document may only be updated by MiCOM Labs personnel. Any changes will be noted in the Document History section of the report.



Title: Xirrus Inc. XI-AC1300, XI-AC867 (non-DFS Bands)
To: FCC 47 CFR Part 15.407 & IC RSS-210
Serial #: XIRR04-U6 Rev A
Issue Date: 29th April 2014
Page: 142 of 199



PEAK POWER SPECTRAL DENSITY

Variant: 802.11n HT-40, Channel: 5230.00 MHz, SUM, Temp: Ambient, Voltage: 48 Vdc

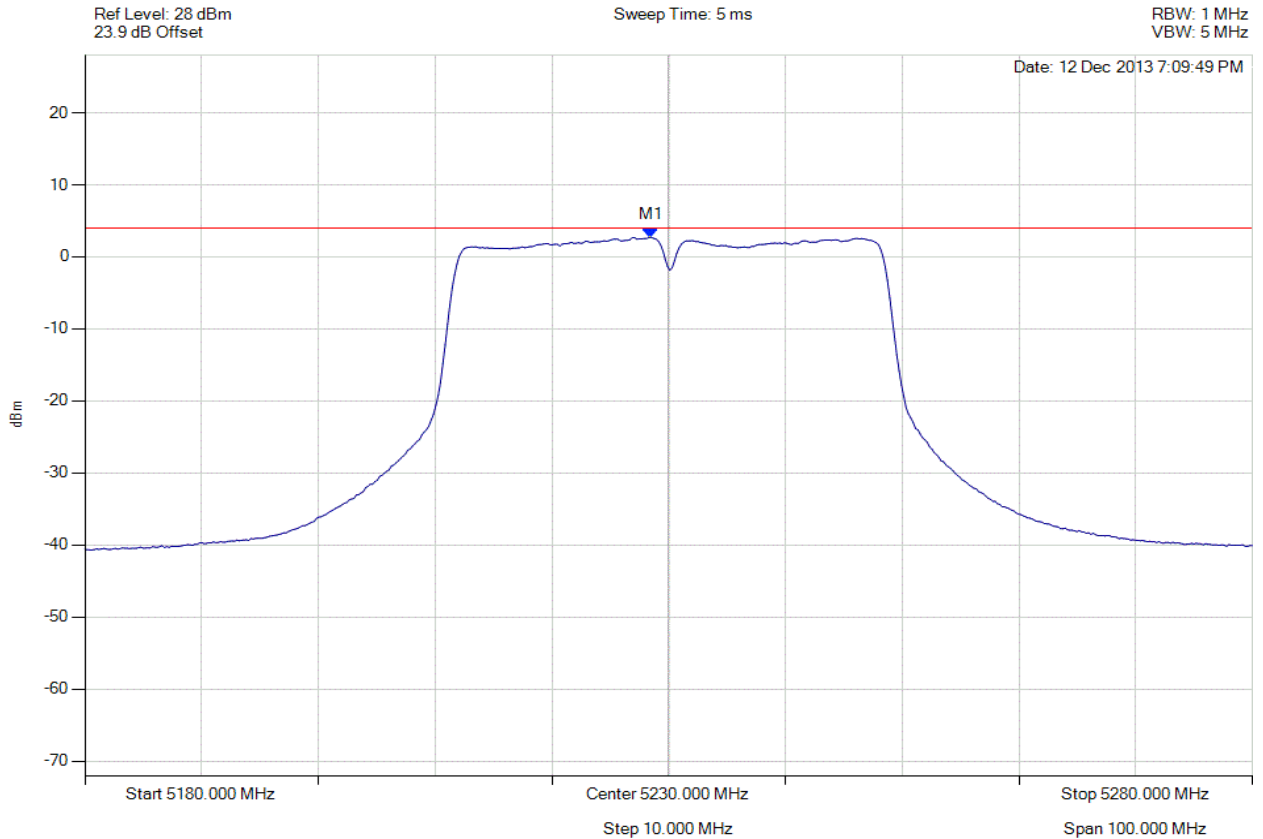

Analyser Setup	Marker : Frequency : Amplitude	Test Results
Detector = RMS Sweep Count = 100 RF Atten (dB) = 20 Trace Mode = VIEW	M1 : 5228.497 MHz : 2.716 dBm	Limit: ≤ 4.0 dBm Margin: -1.3 dB

[Back to the Matrix](#)

This test report may be reproduced in full only. The document may only be updated by MiCOM Labs personnel. Any changes will be noted in the Document History section of the report.



Title: Xirrus Inc. XI-AC1300, XI-AC867 (non-DFS Bands)
To: FCC 47 CFR Part 15.407 & IC RSS-210
Serial #: XIRR04-U6 Rev A
Issue Date: 29th April 2014
Page: 143 of 199



PEAK POWER SPECTRAL DENSITY

Variant: 802.11ac-80, Channel: 5210.00 MHz, Chain a, Temp: Ambient, Voltage: 48 Vdc

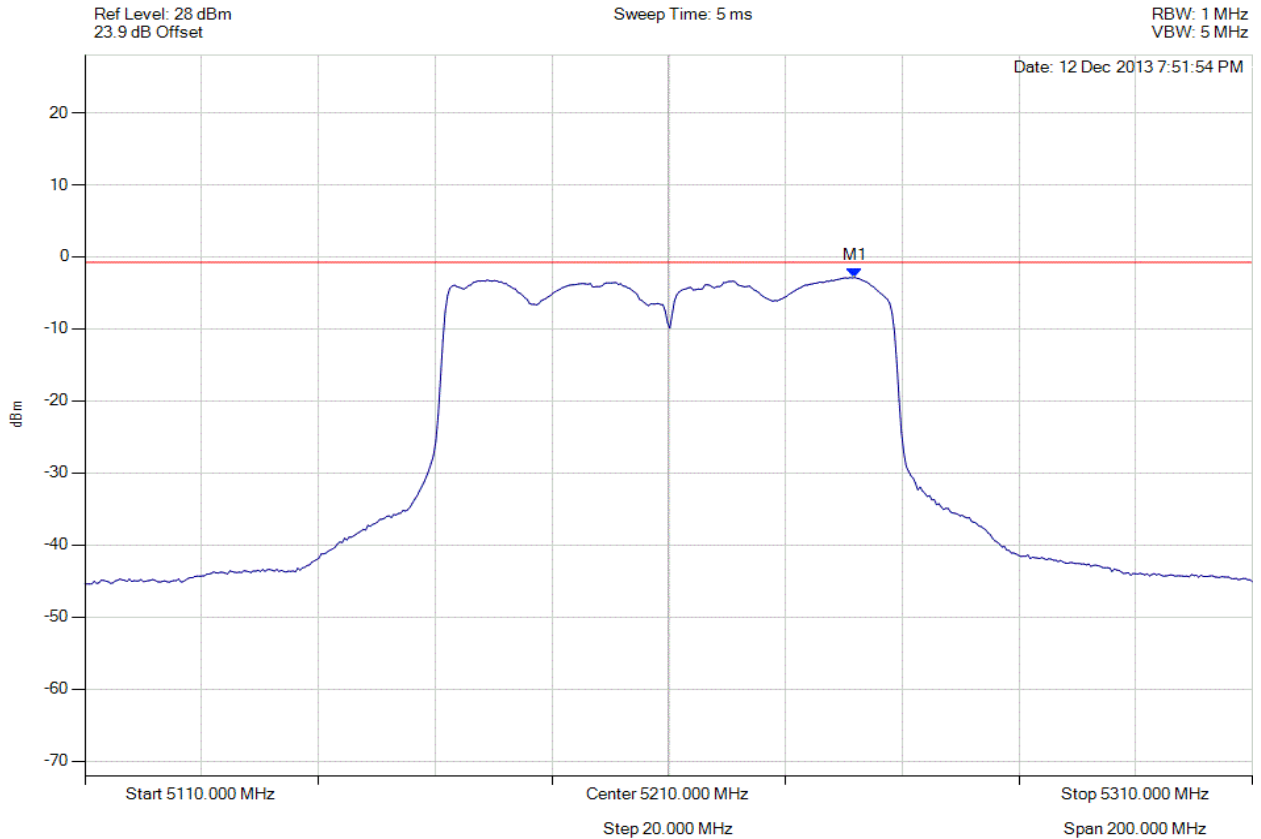

Analyser Setup	Marker : Frequency : Amplitude	Test Results
Detector = RMS Sweep Count = 100 RF Atten (dB) = 20 Trace Mode = VIEW	M1 : 5241.864 MHz : -2.857 dBm	Limit: ≤ -0.771 dBm Margin: 2.09 dB

[Back to the Matrix](#)

This test report may be reproduced in full only. The document may only be updated by MiCOM Labs personnel. Any changes will be noted in the Document History section of the report.



Title: Xirrus Inc. XI-AC1300, XI-AC867 (non-DFS Bands)
To: FCC 47 CFR Part 15.407 & IC RSS-210
Serial #: XIRR04-U6 Rev A
Issue Date: 29th April 2014
Page: 144 of 199



PEAK POWER SPECTRAL DENSITY

Variant: 802.11ac-80, Channel: 5210.00 MHz, Chain b, Temp: Ambient, Voltage: 48 Vdc

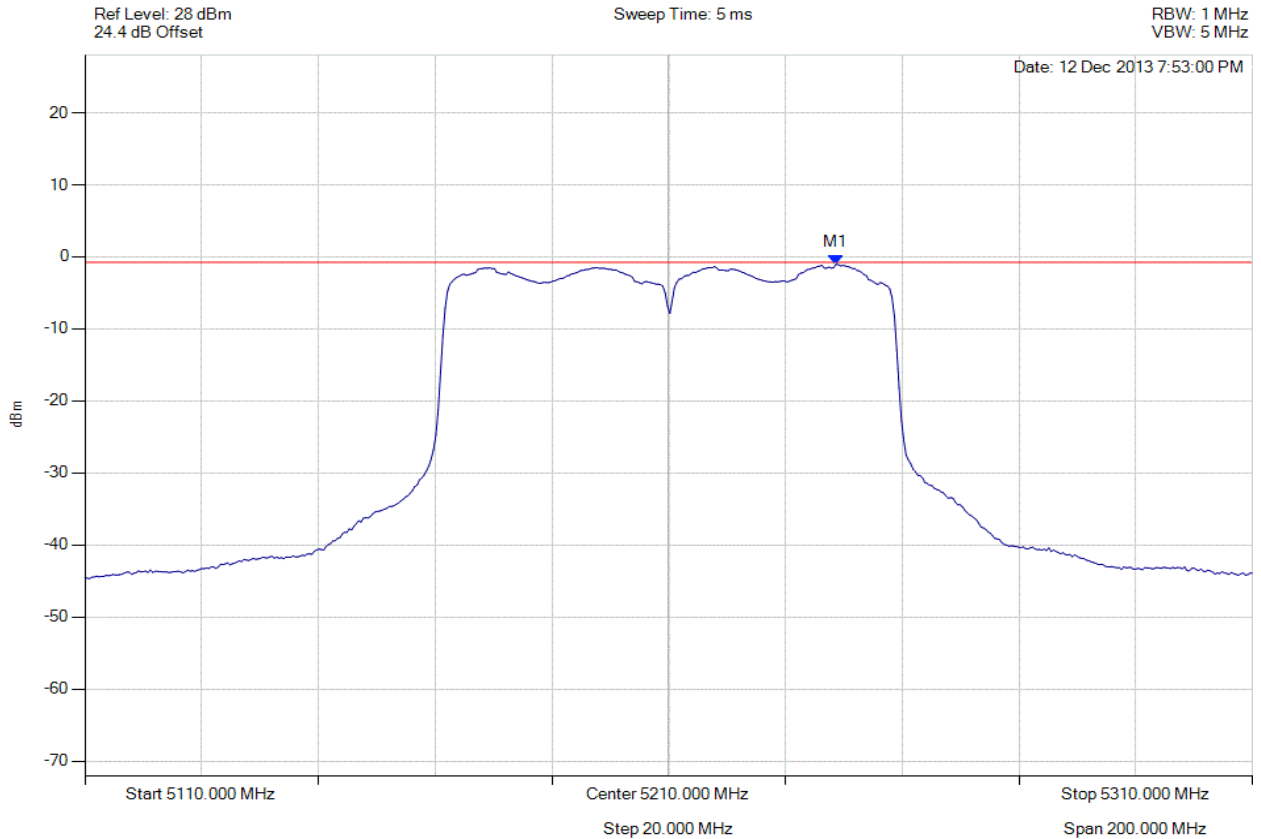

Analyser Setup	Marker : Frequency : Amplitude	Test Results
Detector = RMS Sweep Count = 100 RF Atten (dB) = 20 Trace Mode = VIEW	M1 : 5238.657 MHz : -1.038 dBm	Limit: ≤ -0.771 dBm Margin: 0.27 dB

[Back to the Matrix](#)

This test report may be reproduced in full only. The document may only be updated by MiCOM Labs personnel. Any changes will be noted in the Document History section of the report.



Title: Xirrus Inc. XI-AC1300, XI-AC867 (non-DFS Bands)
To: FCC 47 CFR Part 15.407 & IC RSS-210
Serial #: XIRR04-U6 Rev A
Issue Date: 29th April 2014
Page: 145 of 199



PEAK POWER SPECTRAL DENSITY

Variant: 802.11ac-80, Channel: 5210.00 MHz, Chain c, Temp: Ambient, Voltage: 48 Vdc

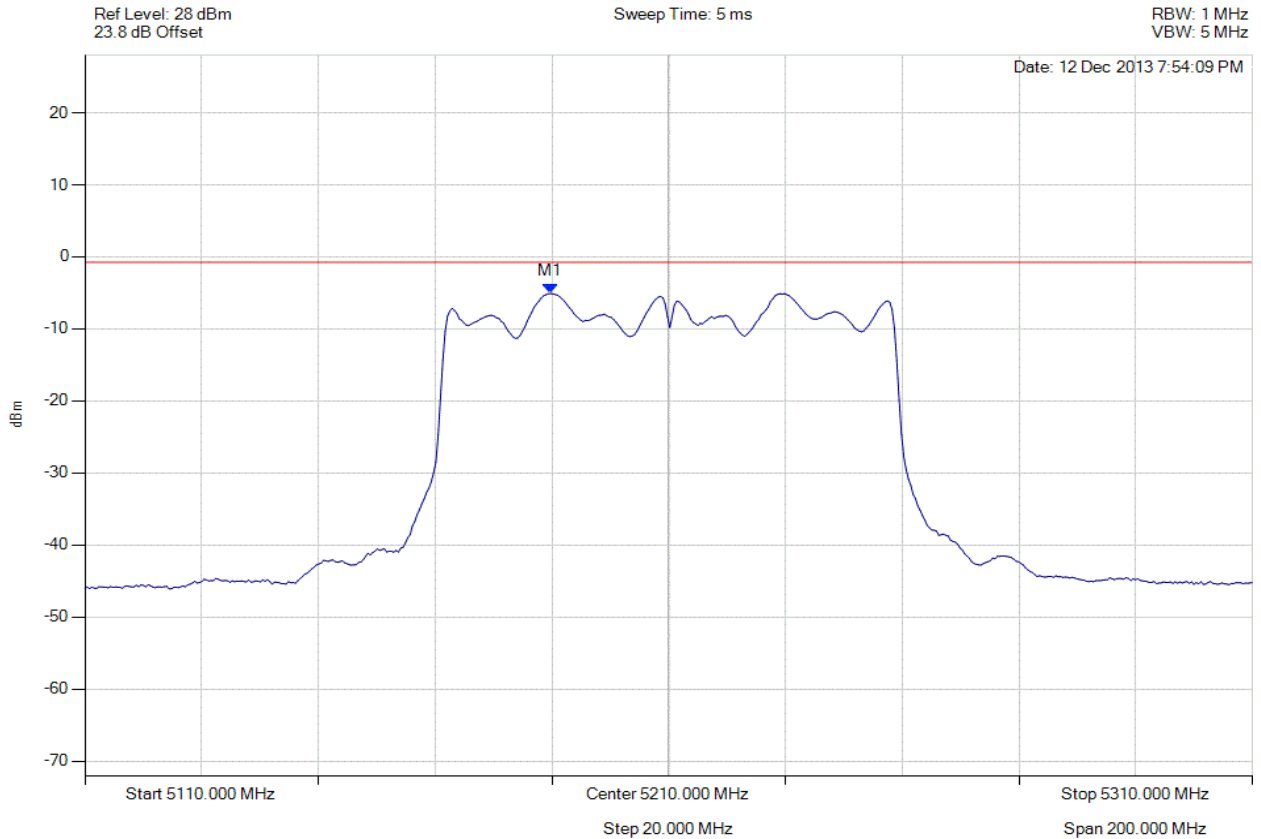

Analyser Setup	Marker : Frequency : Amplitude	Test Results
Detector = RMS Sweep Count = 100 RF Atten (dB) = 20 Trace Mode = VIEW	M1 : 5189.760 MHz : -5.086 dBm	Limit: ≤ -0.771 dBm Margin: 4.32 dB

[Back to the Matrix](#)

This test report may be reproduced in full only. The document may only be updated by MiCOM Labs personnel. Any changes will be noted in the Document History section of the report.



Title: Xirrus Inc. XI-AC1300, XI-AC867 (non-DFS Bands)
To: FCC 47 CFR Part 15.407 & IC RSS-210
Serial #: XIRR04-U6 Rev A
Issue Date: 29th April 2014
Page: 146 of 199



PEAK POWER SPECTRAL DENSITY

Variant: 802.11ac-80, Channel: 5210.00 MHz, SUM, Temp: Ambient, Voltage: 48 Vdc

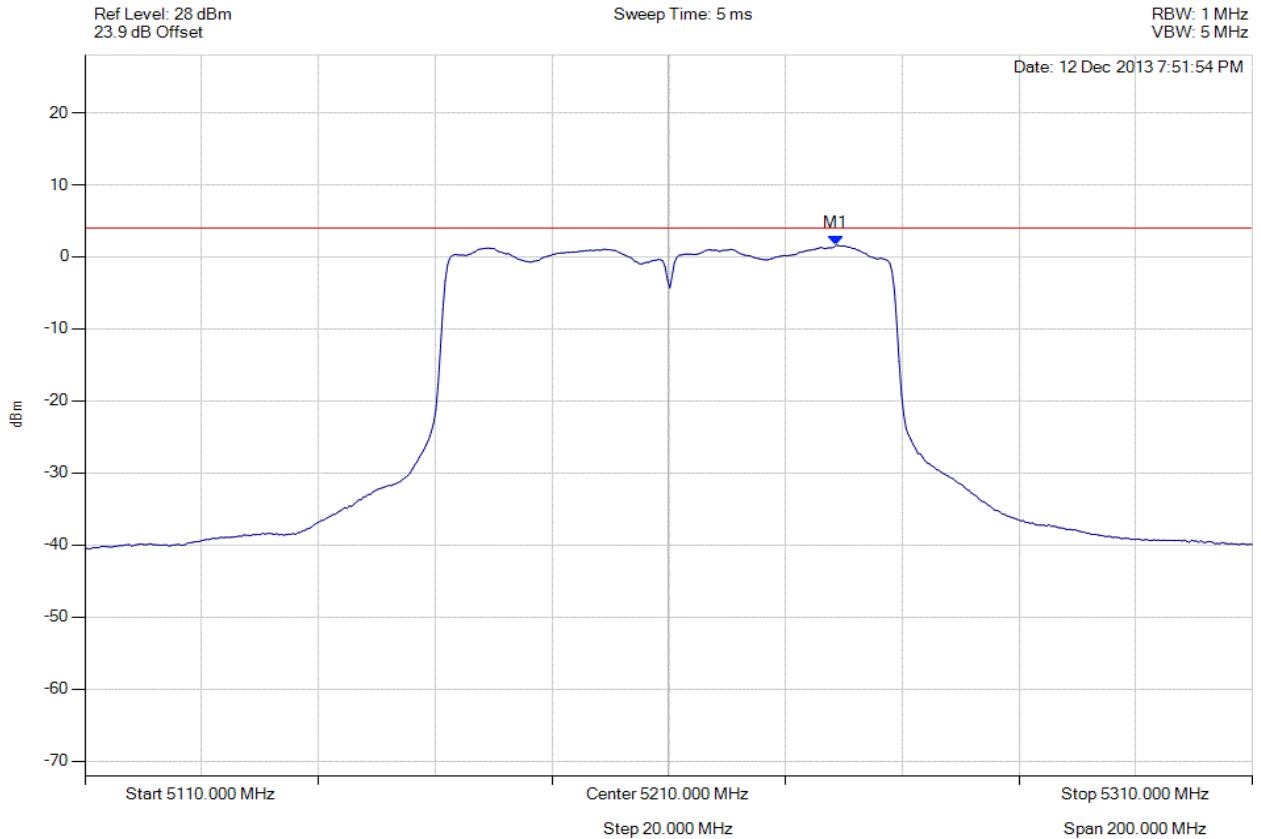

Analyser Setup	Marker : Frequency : Amplitude	Test Results
Detector = RMS Sweep Count = 100 RF Atten (dB) = 20 Trace Mode = VIEW	M1 : 5238.657 MHz : 1.587 dBm	Limit: ≤ 4.0 dBm Margin: -2.4 dB

[Back to the Matrix](#)

This test report may be reproduced in full only. The document may only be updated by MiCOM Labs personnel. Any changes will be noted in the Document History section of the report.



A.1.3. Peak Excursion Ratio



PEAK EXCURSION RATIO

Variant: 802.11a, Channel: 5180.00 MHz, Chain a, Temp: Ambient, Voltage: 56 Vdc

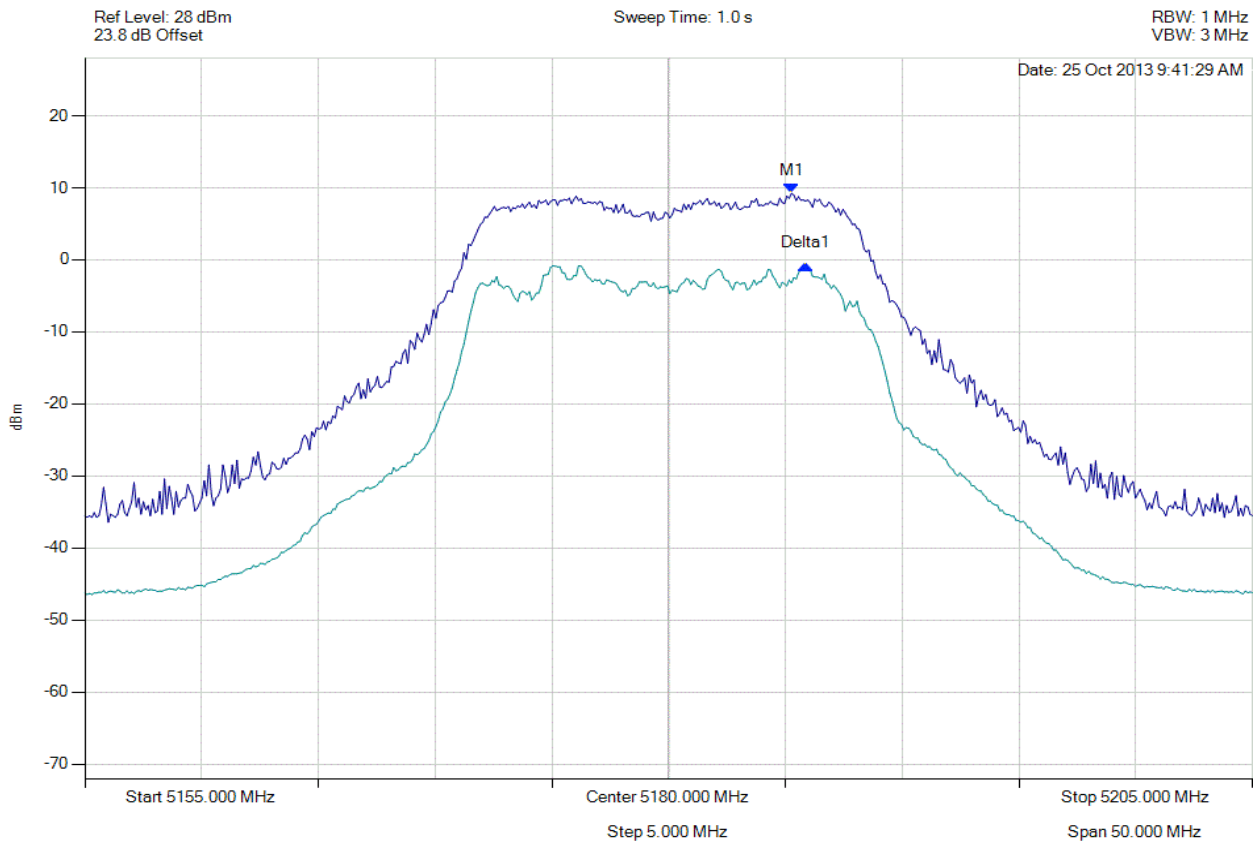

Analyser Setup	Marker : Frequency : Amplitude	Test Results
Sweep Count = 0 RF Atten (dB) = 20 TRACE 1: Detector = MAX PEAK Trace Mode = VIEW TRACE 2: Detector = RMS Trace Mode = VIEW	M1 : 5185.261 MHz : 9.229 dBm Delta1 : 601 KHz : -9.963 dB	Measured Excursion Ratio: 9.96 dB Limit: 13.0 dB Margin: -3.04 dB

[Back to the Matrix](#)

This test report may be reproduced in full only. The document may only be updated by MiCOM Labs personnel. Any changes will be noted in the Document History section of the report.



Title: Xirrus Inc. XI-AC1300, XI-AC867 (non-DFS Bands)
To: FCC 47 CFR Part 15.407 & IC RSS-210
Serial #: XIRR04-U6 Rev A
Issue Date: 29th April 2014
Page: 148 of 199



PEAK EXCURSION RATIO

Variant: 802.11n HT-20, Channel: 5180.00 MHz, Chain a, Temp: Ambient, Voltage: 56 Vdc

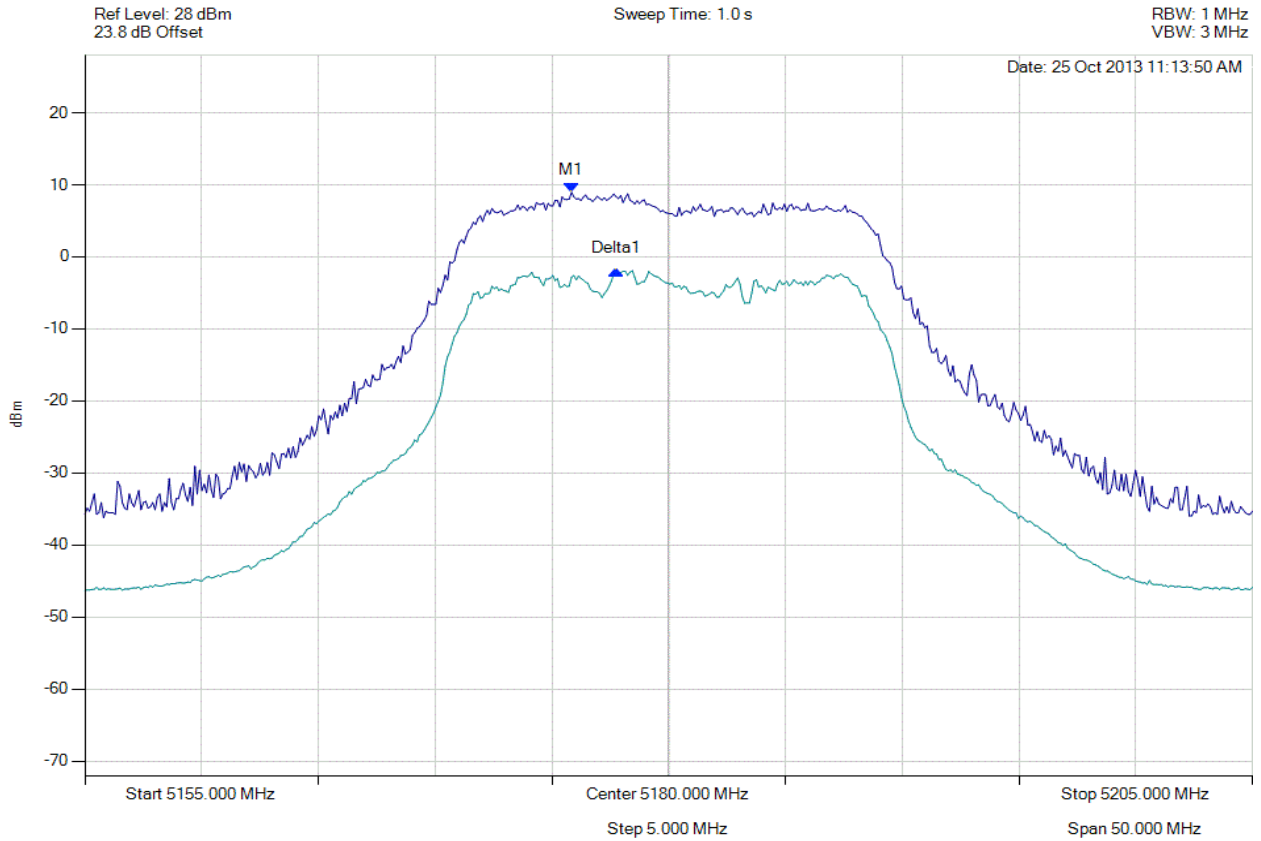

Analyser Setup	Marker : Frequency : Amplitude	Test Results
Sweep Count = 0 RF Atten (dB) = 20 TRACE 1: Detector = MAX PEAK Trace Mode = VIEW TRACE 2: Detector = RMS Trace Mode = VIEW	M1 : 5175.842 MHz : 8.942 dBm Delta1 : 1.904 MHz : -10.832 dB	Measured Excursion Ratio: 10.83 dB Limit: 13.0 dB Margin: -2.17 dB

[Back to the Matrix](#)

This test report may be reproduced in full only. The document may only be updated by MiCOM Labs personnel. Any changes will be noted in the Document History section of the report.



Title: Xirrus Inc. XI-AC1300, XI-AC867 (non-DFS Bands)
To: FCC 47 CFR Part 15.407 & IC RSS-210
Serial #: XIRR04-U6 Rev A
Issue Date: 29th April 2014
Page: 149 of 199



PEAK EXCURSION RATIO

Variant: 802.11n HT-40, Channel: 5190.00 MHz, Chain a, Temp: Ambient, Voltage: 48 Vdc

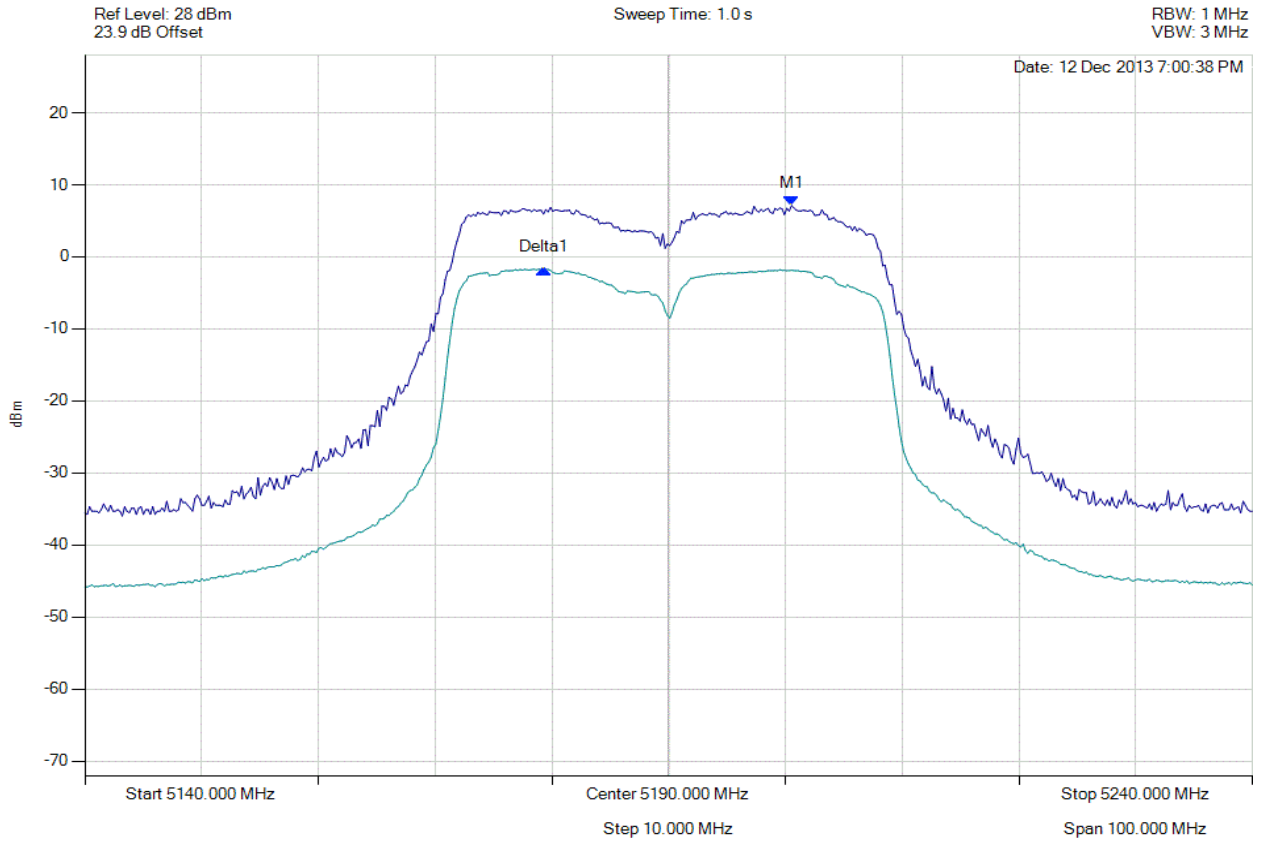

Analyser Setup	Marker : Frequency : Amplitude	Test Results
Sweep Count = 0 RF Atten (dB) = 20 TRACE 1: Detector = MAX PEAK Trace Mode = VIEW TRACE 2: Detector = RMS Trace Mode = VIEW	M1 : 5200.521 MHz : 7.103 dBm Delta1 : -21242485 Hz : -8.809 dB	Measured Excursion Ratio: 8.81 dB Limit: 13.0 dB Margin: -4.19 dB

[Back to the Matrix](#)

This test report may be reproduced in full only. The document may only be updated by MiCOM Labs personnel. Any changes will be noted in the Document History section of the report.



Title: Xirrus Inc. XI-AC1300, XI-AC867 (non-DFS Bands)
To: FCC 47 CFR Part 15.407 & IC RSS-210
Serial #: XIRR04-U6 Rev A
Issue Date: 29th April 2014
Page: 150 of 199

A.2. 2x2 CONDUCTED TEST PLOTS

This test report may be reproduced in full only. The document may only be updated by MiCOM Labs personnel. Any changes will be noted in the Document History section of the report.



A.2.1. 26 dB & 99% Bandwidth



26 dB & 99% BANDWIDTH

Variant: 802.11a, Channel: 5180.00 MHz, Chain a, Temp: Ambient, Voltage: 55 Vdc

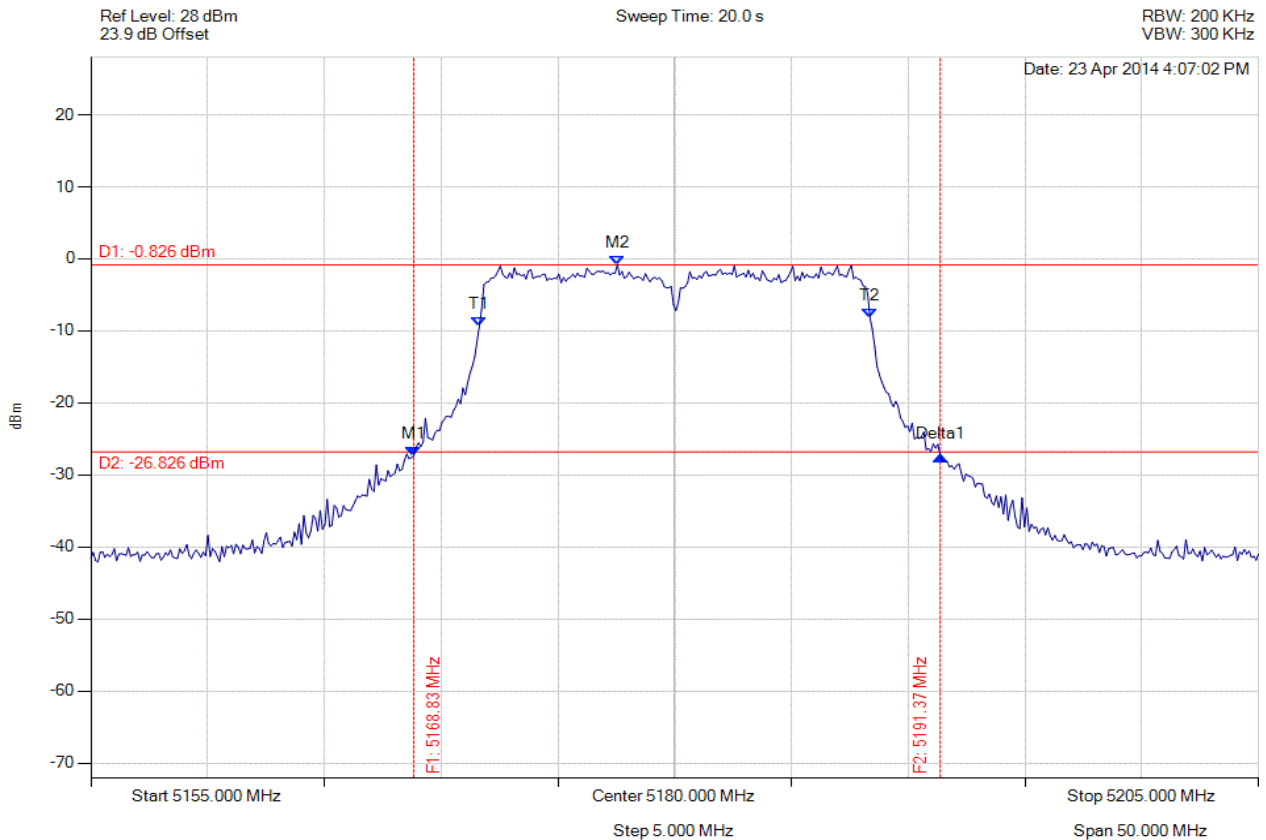

Analyser Setup	Marker : Frequency : Amplitude	Test Results
Detector = MAX PEAK Sweep Count = 0 RF Atten (dB) = 20 Trace Mode = VIEW	M1 : 5168.828 MHz : -27.328 dBm M2 : 5177.545 MHz : -0.826 dBm Delta1 : 22.545 MHz : -0.069 dB T1 : 5171.633 MHz : -9.390 dBm T2 : 5188.367 MHz : -8.227 dBm OBW : 16.733 MHz	Measured 26 dB Bandwidth: 22.545 MHz Measured 99% Bandwidth: 16.733 MHz

[Back to the Matrix](#)

This test report may be reproduced in full only. The document may only be updated by MiCOM Labs personnel. Any changes will be noted in the Document History section of the report.



Title: Xirrus Inc. XI-AC1300, XI-AC867 (non-DFS Bands)
To: FCC 47 CFR Part 15.407 & IC RSS-210
Serial #: XIRR04-U6 Rev A
Issue Date: 29th April 2014
Page: 152 of 199



26 dB & 99% BANDWIDTH

Variant: 802.11a, Channel: 5180.00 MHz, Chain b, Temp: Ambient, Voltage: 55 Vdc

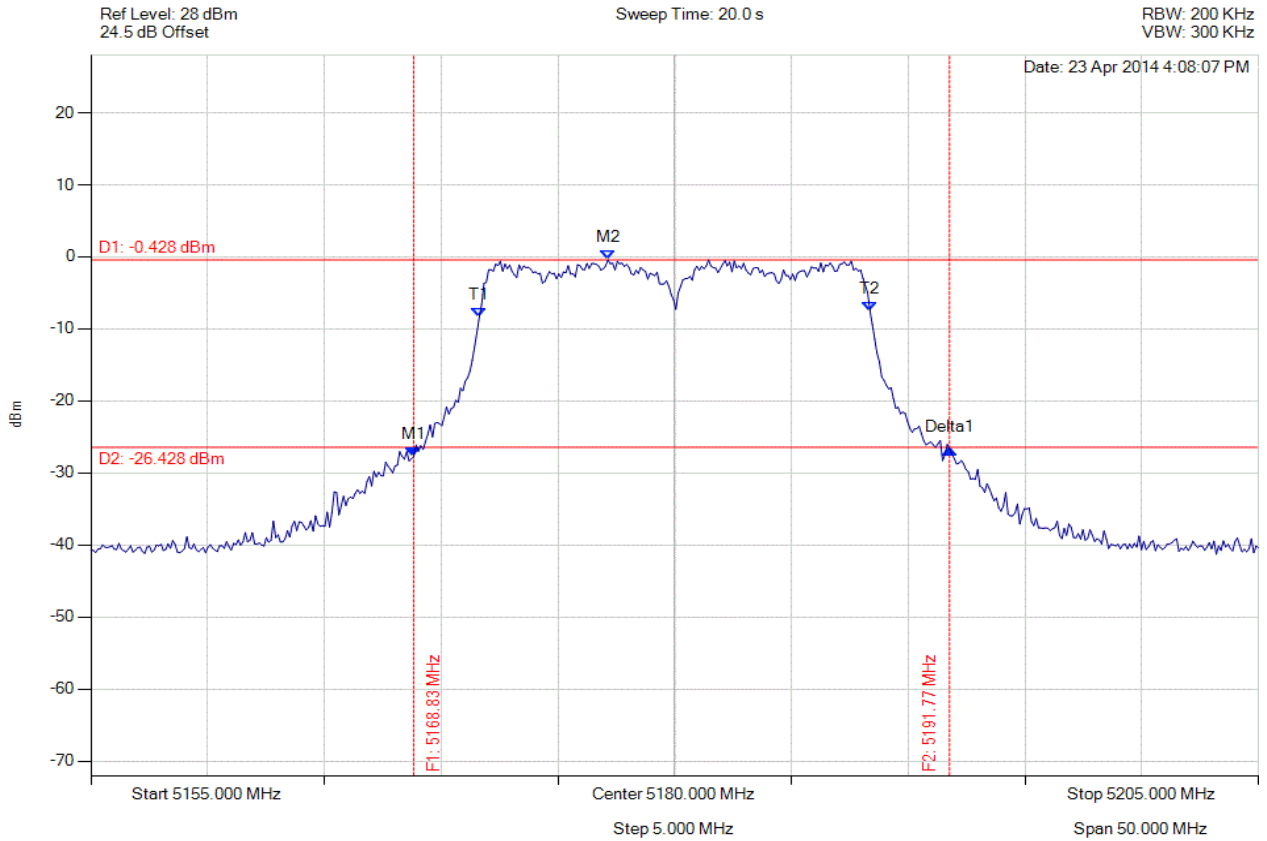

Analyser Setup	Marker : Frequency : Amplitude	Test Results
Detector = MAX PEAK Sweep Count = 0 RF Atten (dB) = 20 Trace Mode = VIEW	M1 : 5168.828 MHz : -27.723 dBm M2 : 5177.144 MHz : -0.428 dBm Delta1 : 22.946 MHz : 1.056 dB T1 : 5171.633 MHz : -8.353 dBm T2 : 5188.367 MHz : -7.570 dBm OBW : 16.733 MHz	Measured 26 dB Bandwidth: 22.946 MHz Measured 99% Bandwidth: 16.733 MHz

[Back to the Matrix](#)

This test report may be reproduced in full only. The document may only be updated by MiCOM Labs personnel. Any changes will be noted in the Document History section of the report.



Title: Xirrus Inc. XI-AC1300, XI-AC867 (non-DFS Bands)
To: FCC 47 CFR Part 15.407 & IC RSS-210
Serial #: XIRR04-U6 Rev A
Issue Date: 29th April 2014
Page: 153 of 199



26 dB & 99% BANDWIDTH

Variant: 802.11a, Channel: 5200.00 MHz, Chain a, Temp: Ambient, Voltage: 55 Vdc

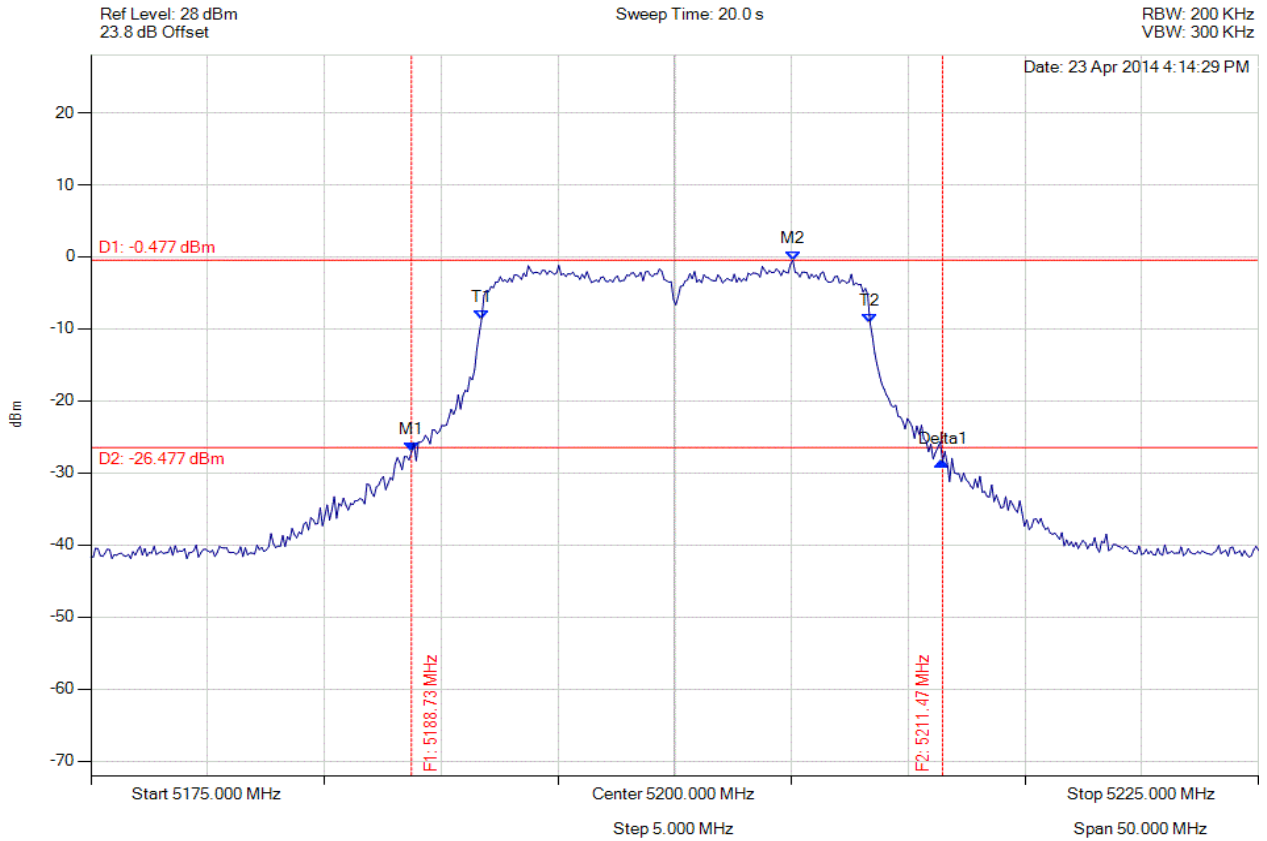

Analyser Setup	Marker : Frequency : Amplitude	Test Results
Detector = MAX PEAK Sweep Count = 0 RF Atten (dB) = 20 Trace Mode = VIEW	M1 : 5188.727 MHz : -27.072 dBm M2 : 5205.060 MHz : -0.477 dBm Delta1 : 22.745 MHz : -1.324 dB T1 : 5191.733 MHz : -8.642 dBm T2 : 5208.367 MHz : -9.148 dBm OBW : 16.633 MHz	Measured 26 dB Bandwidth: 22.745 MHz Measured 99% Bandwidth: 16.633 MHz

[Back to the Matrix](#)

This test report may be reproduced in full only. The document may only be updated by MiCOM Labs personnel. Any changes will be noted in the Document History section of the report.



Title: Xirrus Inc. XI-AC1300, XI-AC867 (non-DFS Bands)
To: FCC 47 CFR Part 15.407 & IC RSS-210
Serial #: XIRR04-U6 Rev A
Issue Date: 29th April 2014
Page: 154 of 199



26 dB & 99% BANDWIDTH

Variant: 802.11a, Channel: 5200.00 MHz, Chain b, Temp: Ambient, Voltage: 55 Vdc

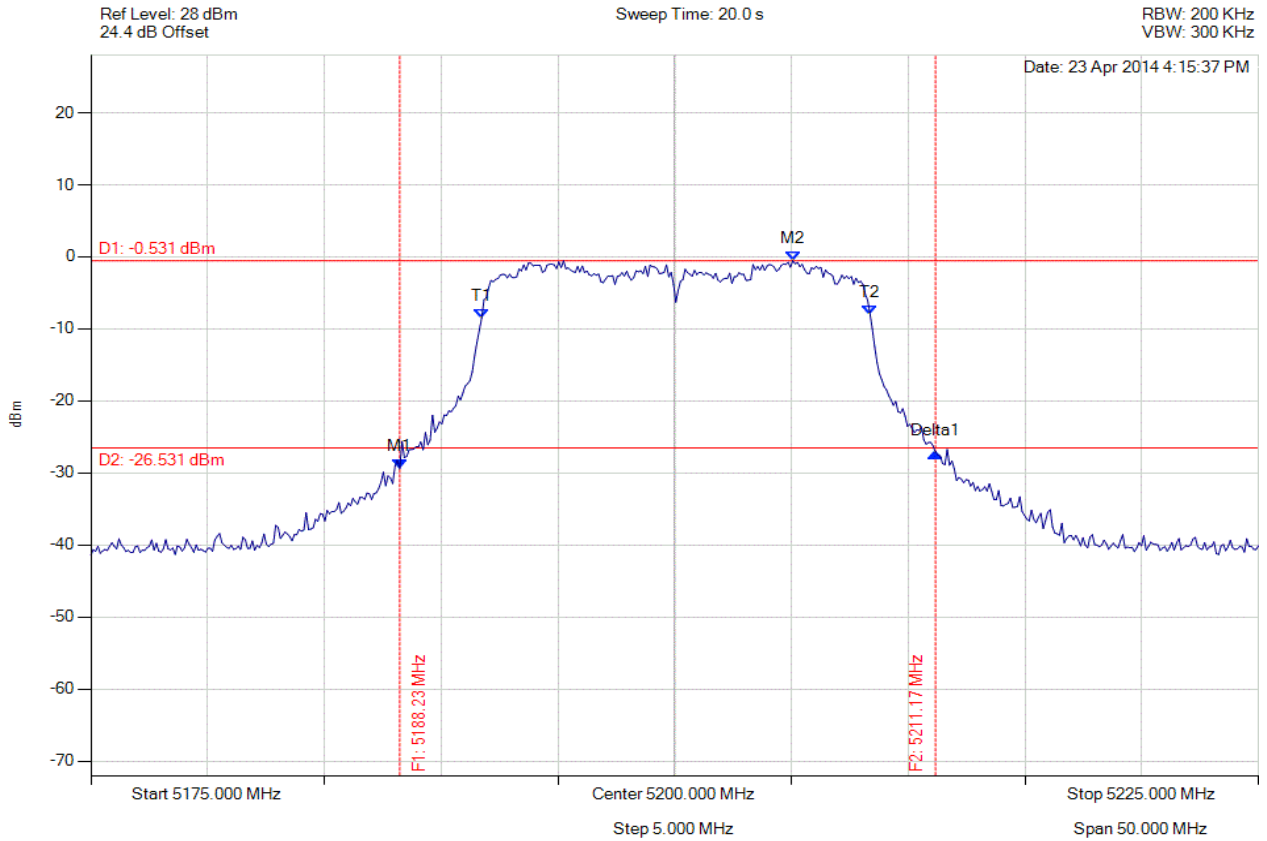

Analyser Setup	Marker : Frequency : Amplitude	Test Results
Detector = MAX PEAK Sweep Count = 0 RF Atten (dB) = 20 Trace Mode = VIEW	M1 : 5188.226 MHz : -29.437 dBm M2 : 5205.060 MHz : -0.531 dBm Delta1 : 22.946 MHz : 2.276 dB T1 : 5191.733 MHz : -8.540 dBm T2 : 5208.367 MHz : -7.973 dBm OBW : 16.633 MHz	Measured 26 dB Bandwidth: 22.946 MHz Measured 99% Bandwidth: 16.633 MHz

[Back to the Matrix](#)

This test report may be reproduced in full only. The document may only be updated by MiCOM Labs personnel. Any changes will be noted in the Document History section of the report.



Title: Xirrus Inc. XI-AC1300, XI-AC867 (non-DFS Bands)
To: FCC 47 CFR Part 15.407 & IC RSS-210
Serial #: XIRR04-U6 Rev A
Issue Date: 29th April 2014
Page: 155 of 199



26 dB & 99% BANDWIDTH

Variant: 802.11a, Channel: 5240.00 MHz, Chain a, Temp: Ambient, Voltage: 55 Vdc

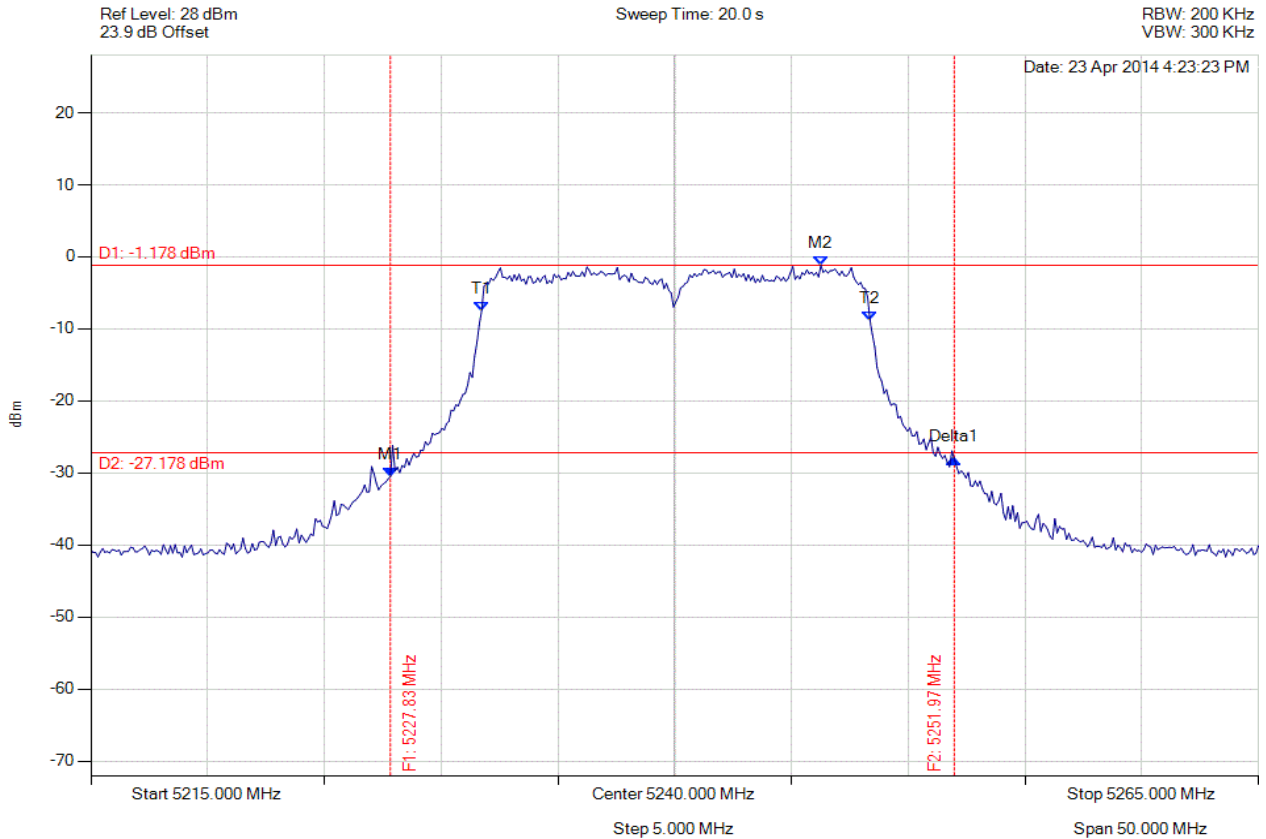

Analyser Setup	Marker : Frequency : Amplitude	Test Results
Detector = MAX PEAK Sweep Count = 0 RF Atten (dB) = 20 Trace Mode = VIEW	M1 : 5227.826 MHz : -30.501 dBm M2 : 5246.263 MHz : -1.178 dBm Delta1 : 24.148 MHz : 2.371 dB T1 : 5231.733 MHz : -7.517 dBm T2 : 5248.367 MHz : -8.902 dBm OBW : 16.633 MHz	Measured 26 dB Bandwidth: 24.148 MHz Measured 99% Bandwidth: 16.633 MHz

[Back to the Matrix](#)

This test report may be reproduced in full only. The document may only be updated by MiCOM Labs personnel. Any changes will be noted in the Document History section of the report.



Title: Xirrus Inc. XI-AC1300, XI-AC867 (non-DFS Bands)
To: FCC 47 CFR Part 15.407 & IC RSS-210
Serial #: XIRR04-U6 Rev A
Issue Date: 29th April 2014
Page: 156 of 199



26 dB & 99% BANDWIDTH

Variant: 802.11a, Channel: 5240.00 MHz, Chain b, Temp: Ambient, Voltage: 55 Vdc

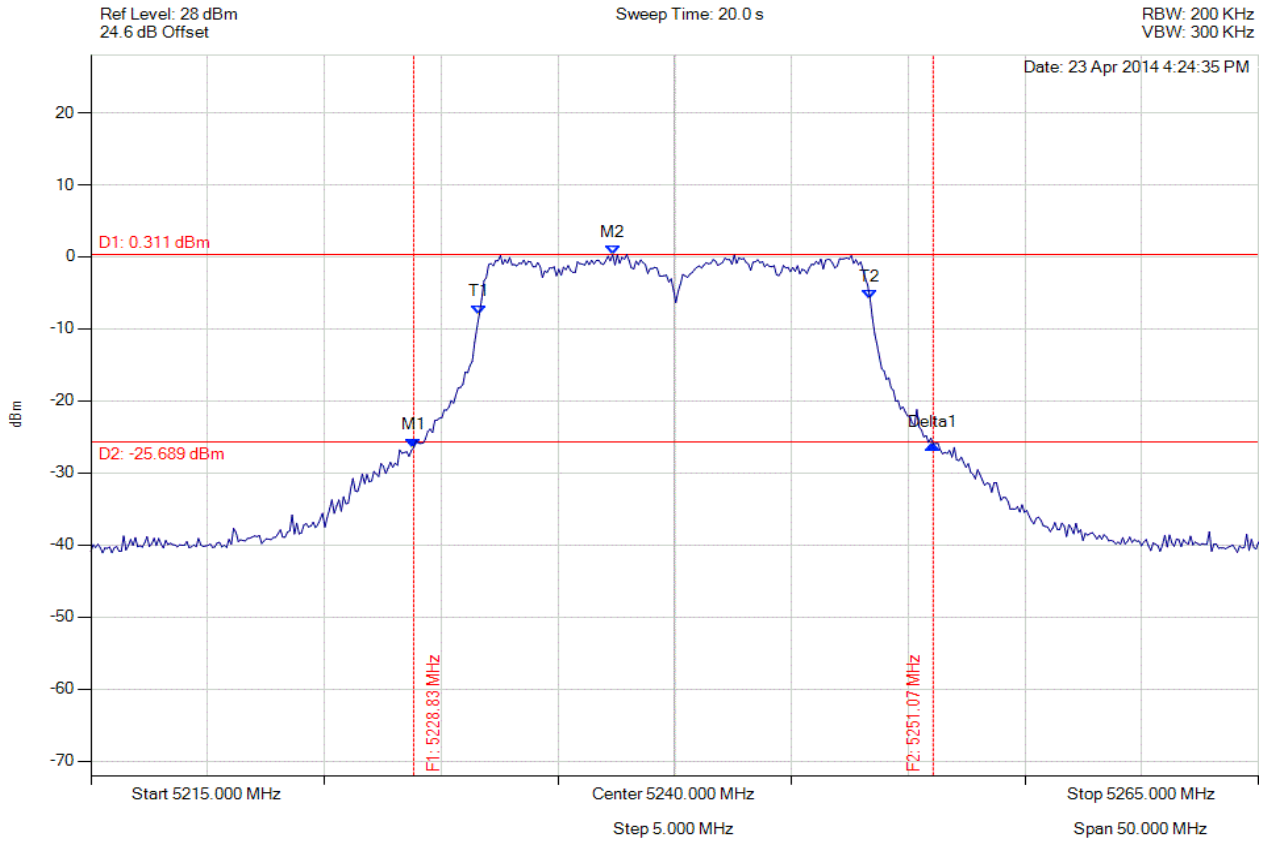

Analyser Setup	Marker : Frequency : Amplitude	Test Results
Detector = MAX PEAK Sweep Count = 0 RF Atten (dB) = 20 Trace Mode = VIEW	M1 : 5228.828 MHz : -26.466 dBm M2 : 5237.345 MHz : 0.311 dBm Delta1 : 22.244 MHz : 0.462 dB T1 : 5231.633 MHz : -7.959 dBm T2 : 5248.367 MHz : -5.835 dBm OBW : 16.733 MHz	Measured 26 dB Bandwidth: 22.244 MHz Measured 99% Bandwidth: 16.733 MHz

[Back to the Matrix](#)

This test report may be reproduced in full only. The document may only be updated by MiCOM Labs personnel. Any changes will be noted in the Document History section of the report.



Title: Xirrus Inc. XI-AC1300, XI-AC867 (non-DFS Bands)
To: FCC 47 CFR Part 15.407 & IC RSS-210
Serial #: XIRR04-U6 Rev A
Issue Date: 29th April 2014
Page: 157 of 199



26 dB & 99% BANDWIDTH

Variant: 802.11ac-80, Channel: 5210.00 MHz, Chain a, Temp: Ambient, Voltage: 55 Vdc

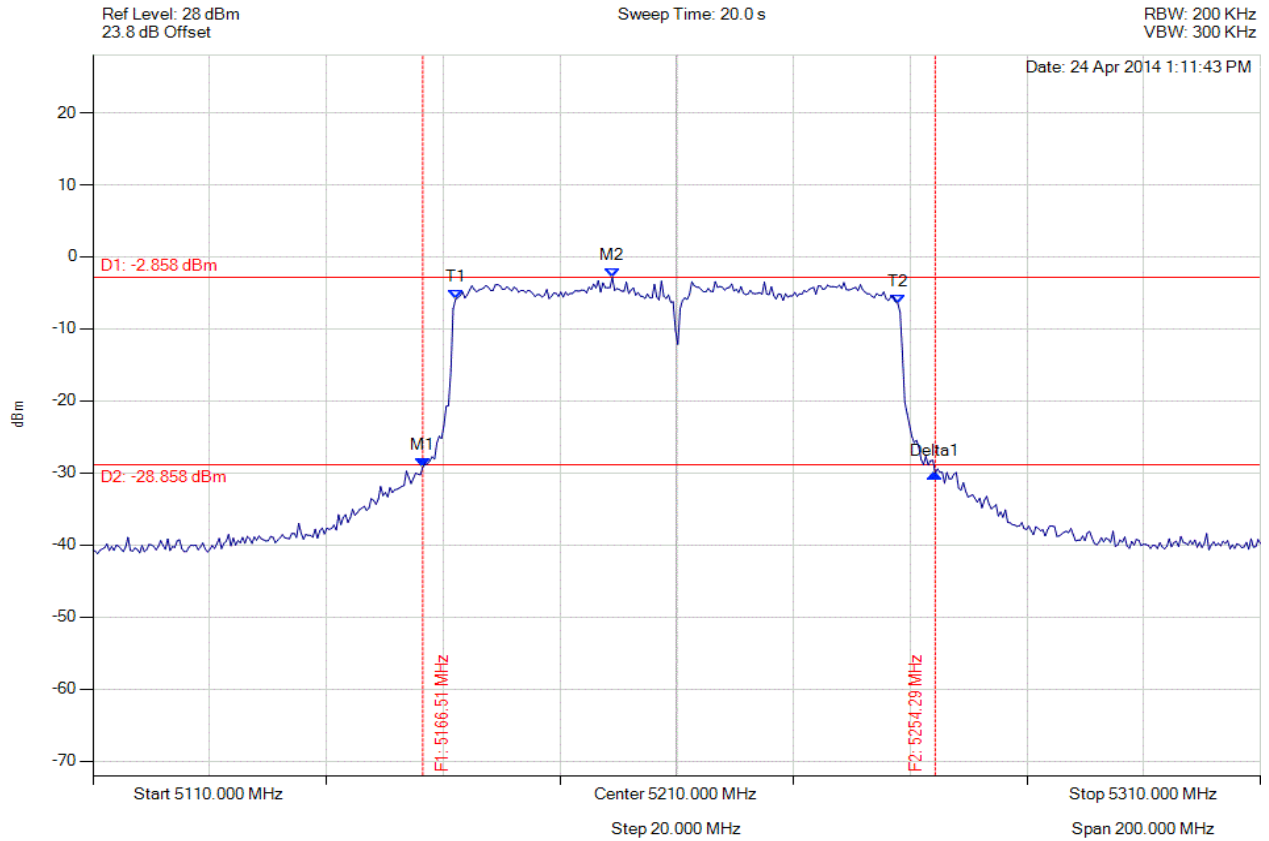

Analyser Setup	Marker : Frequency : Amplitude	Test Results
Detector = MAX PEAK Sweep Count = 0 RF Atten (dB) = 20 Trace Mode = VIEW	M1 : 5166.513 MHz : -29.207 dBm M2 : 5198.978 MHz : -2.858 dBm Delta1 : 87.776 MHz : -0.826 dB T1 : 5172.124 MHz : -5.901 dBm T2 : 5247.876 MHz : -6.478 dBm OBW : 75.752 MHz	Measured 26 dB Bandwidth: 87.776 MHz Measured 99% Bandwidth: 75.752 MHz

[Back to the Matrix](#)

This test report may be reproduced in full only. The document may only be updated by MiCOM Labs personnel. Any changes will be noted in the Document History section of the report.



Title: Xirrus Inc. XI-AC1300, XI-AC867 (non-DFS Bands)
To: FCC 47 CFR Part 15.407 & IC RSS-210
Serial #: XIRR04-U6 Rev A
Issue Date: 29th April 2014
Page: 158 of 199



26 dB & 99% BANDWIDTH

Variant: 802.11ac-80, Channel: 5210.00 MHz, Chain b, Temp: Ambient, Voltage: 55 Vdc

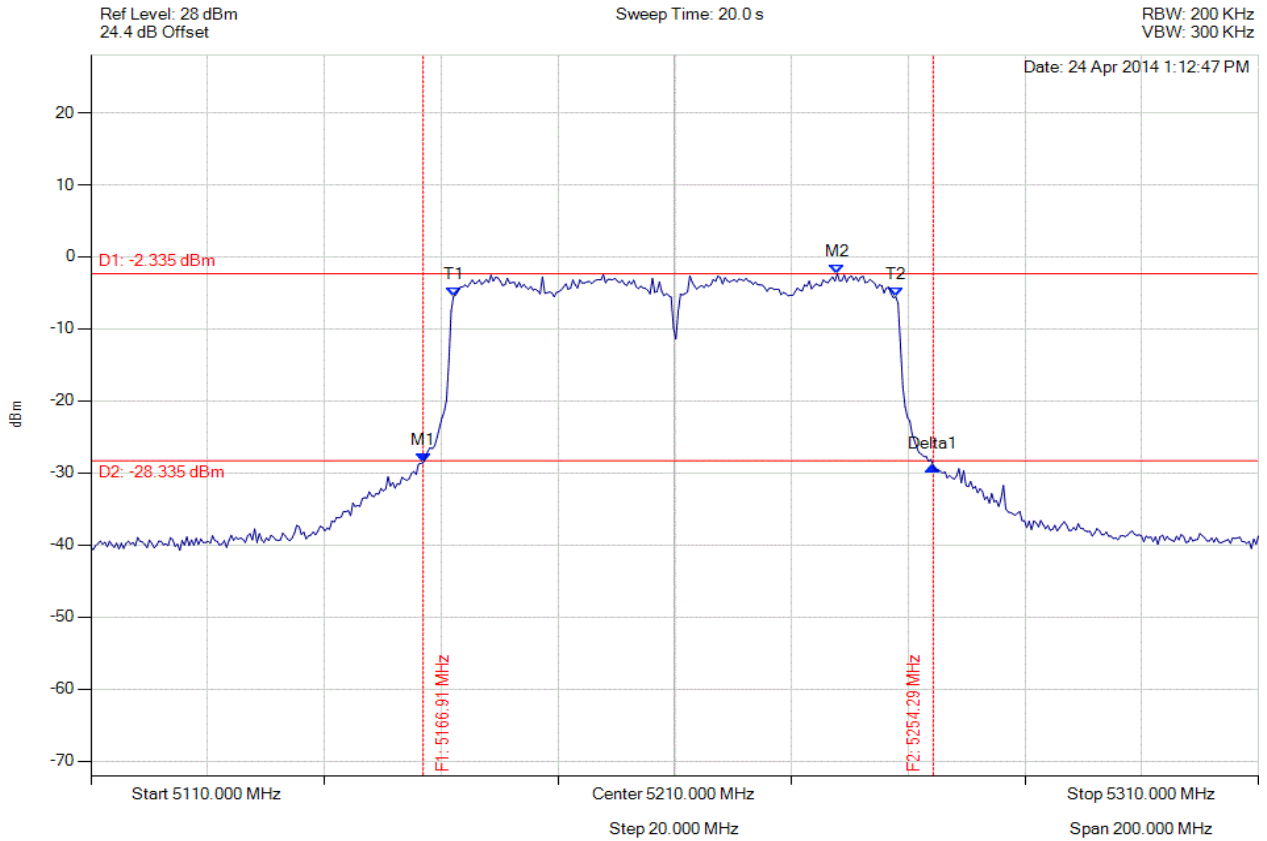

Analyser Setup	Marker : Frequency : Amplitude	Test Results
Detector = MAX PEAK Sweep Count = 0 RF Atten (dB) = 20 Trace Mode = VIEW	M1 : 5166.914 MHz : -28.595 dBm M2 : 5237.856 MHz : -2.335 dBm Delta1 : 87.375 MHz : -0.454 dB T1 : 5172.124 MHz : -5.486 dBm T2 : 5247.876 MHz : -5.543 dBm OBW : 75.752 MHz	Measured 26 dB Bandwidth: 87.375 MHz Measured 99% Bandwidth: 75.752 MHz

[Back to the Matrix](#)

This test report may be reproduced in full only. The document may only be updated by MiCOM Labs personnel. Any changes will be noted in the Document History section of the report.



Title: Xirrus Inc. XI-AC1300, XI-AC867 (non-DFS Bands)
To: FCC 47 CFR Part 15.407 & IC RSS-210
Serial #: XIRR04-U6 Rev A
Issue Date: 29th April 2014
Page: 159 of 199



26 dB & 99% BANDWIDTH

Variant: 802.11n HT-20, Channel: 5180.00 MHz, Chain a, Temp: Ambient, Voltage: 55 Vdc

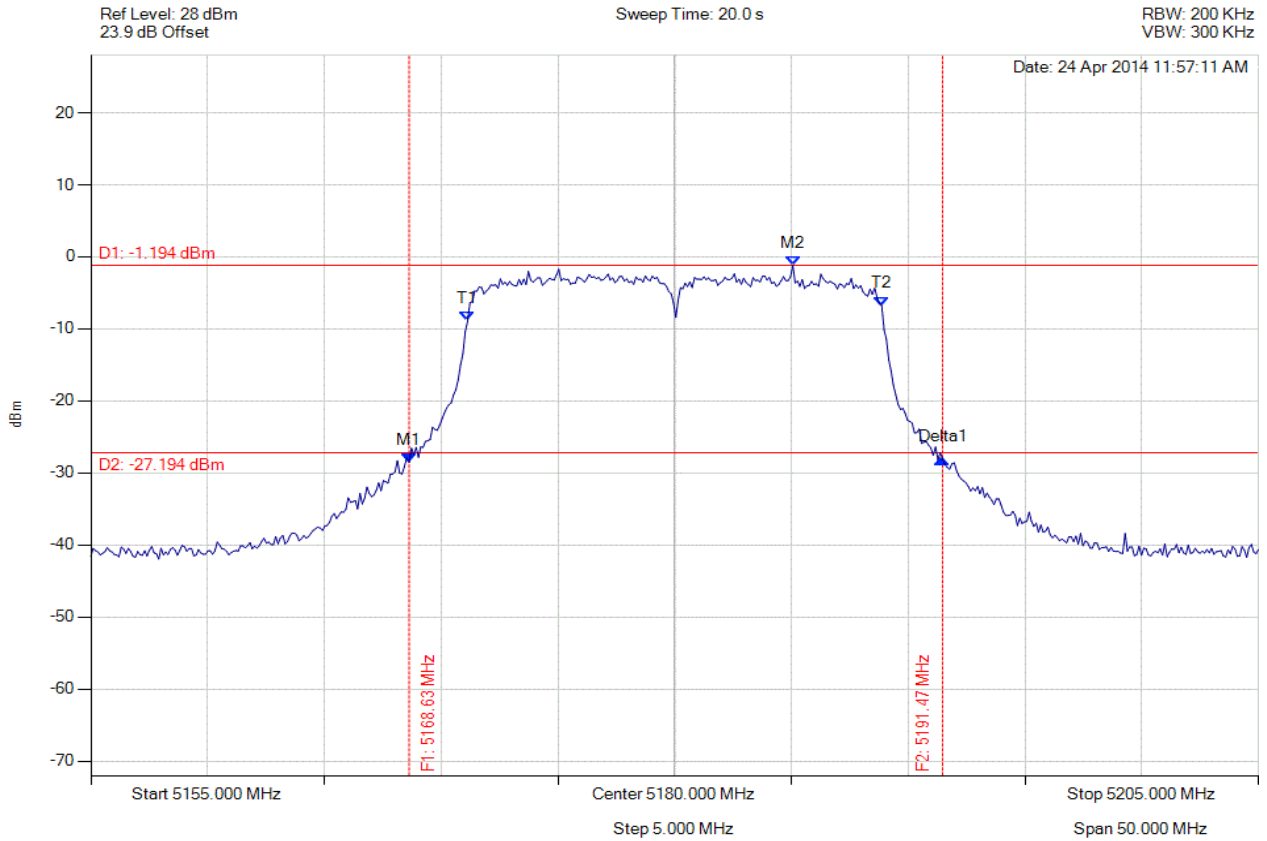

Analyser Setup	Marker : Frequency : Amplitude	Test Results
Detector = MAX PEAK Sweep Count = 0 RF Atten (dB) = 20 Trace Mode = VIEW	M1 : 5168.627 MHz : -28.520 dBm M2 : 5185.060 MHz : -1.194 dBm Delta1 : 22.846 MHz : 0.443 dB T1 : 5171.132 MHz : -8.917 dBm T2 : 5188.868 MHz : -6.791 dBm OBW : 17.735 MHz	Measured 26 dB Bandwidth: 22.846 MHz Measured 99% Bandwidth: 17.735 MHz

[Back to the Matrix](#)

This test report may be reproduced in full only. The document may only be updated by MiCOM Labs personnel. Any changes will be noted in the Document History section of the report.



Title: Xirrus Inc. XI-AC1300, XI-AC867 (non-DFS Bands)
To: FCC 47 CFR Part 15.407 & IC RSS-210
Serial #: XIRR04-U6 Rev A
Issue Date: 29th April 2014
Page: 160 of 199



26 dB & 99% BANDWIDTH

Variant: 802.11n HT-20, Channel: 5180.00 MHz, Chain b, Temp: Ambient, Voltage: 55 Vdc

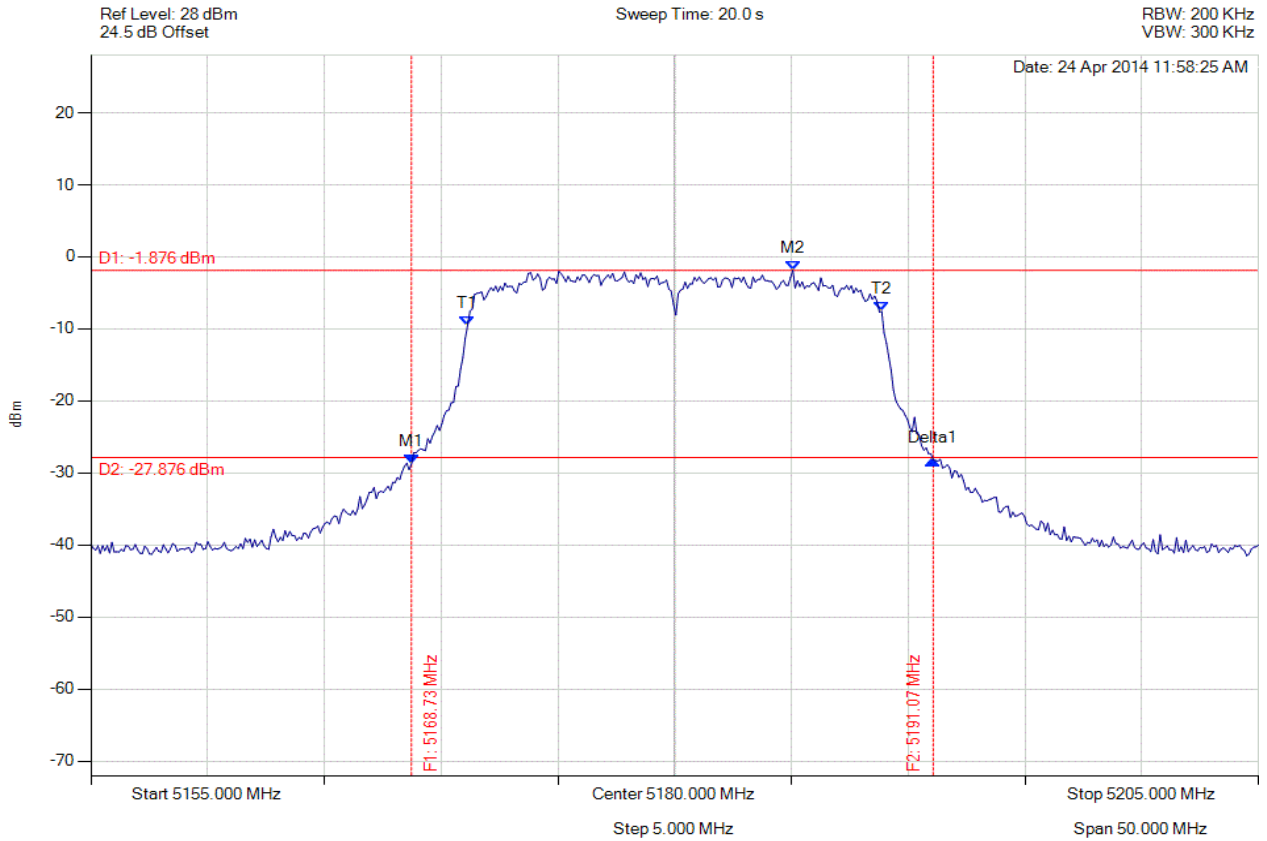

Analyser Setup	Marker : Frequency : Amplitude	Test Results
Detector = MAX PEAK Sweep Count = 0 RF Atten (dB) = 20 Trace Mode = VIEW	M1 : 5168.727 MHz : -28.766 dBm M2 : 5185.060 MHz : -1.876 dBm Delta1 : 22.345 MHz : 0.561 dB T1 : 5171.132 MHz : -9.490 dBm T2 : 5188.868 MHz : -7.578 dBm OBW : 17.735 MHz	Measured 26 dB Bandwidth: 22.345 MHz Measured 99% Bandwidth: 17.735 MHz

[Back to the Matrix](#)

This test report may be reproduced in full only. The document may only be updated by MiCOM Labs personnel. Any changes will be noted in the Document History section of the report.



Title: Xirrus Inc. XI-AC1300, XI-AC867 (non-DFS Bands)
To: FCC 47 CFR Part 15.407 & IC RSS-210
Serial #: XIRR04-U6 Rev A
Issue Date: 29th April 2014
Page: 161 of 199



26 dB & 99% BANDWIDTH

Variant: 802.11n HT-20, Channel: 5200.00 MHz, Chain a, Temp: Ambient, Voltage: 55 Vdc

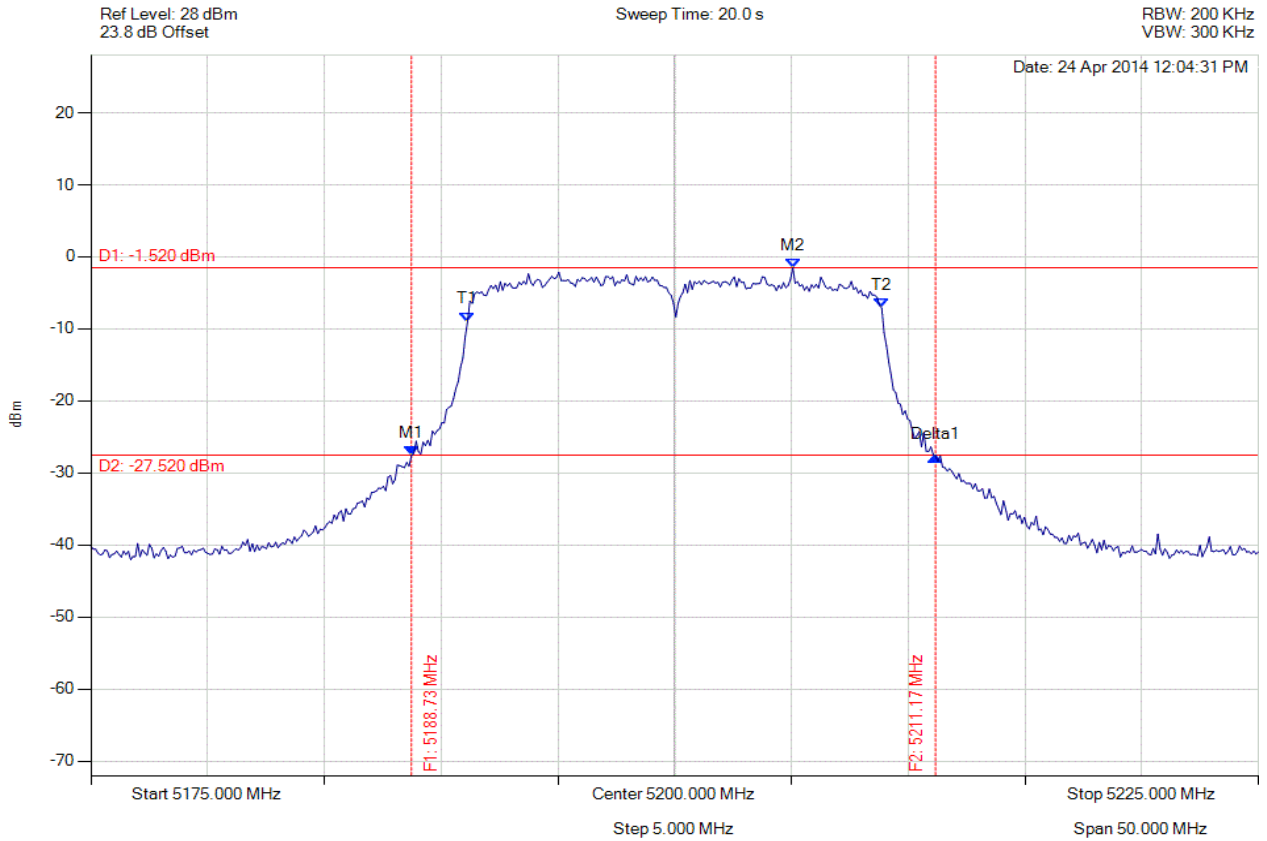

Analyser Setup	Marker : Frequency : Amplitude	Test Results
Detector = MAX PEAK Sweep Count = 0 RF Atten (dB) = 20 Trace Mode = VIEW	M1 : 5188.727 MHz : -27.550 dBm M2 : 5205.060 MHz : -1.520 dBm Delta1 : 22.445 MHz : -0.108 dB T1 : 5191.132 MHz : -8.961 dBm T2 : 5208.868 MHz : -7.113 dBm OBW : 17.735 MHz	Measured 26 dB Bandwidth: 22.445 MHz Measured 99% Bandwidth: 17.735 MHz

[Back to the Matrix](#)

This test report may be reproduced in full only. The document may only be updated by MiCOM Labs personnel. Any changes will be noted in the Document History section of the report.



Title: Xirrus Inc. XI-AC1300, XI-AC867 (non-DFS Bands)
To: FCC 47 CFR Part 15.407 & IC RSS-210
Serial #: XIRR04-U6 Rev A
Issue Date: 29th April 2014
Page: 162 of 199



26 dB & 99% BANDWIDTH

Variant: 802.11n HT-20, Channel: 5200.00 MHz, Chain b, Temp: Ambient, Voltage: 55 Vdc

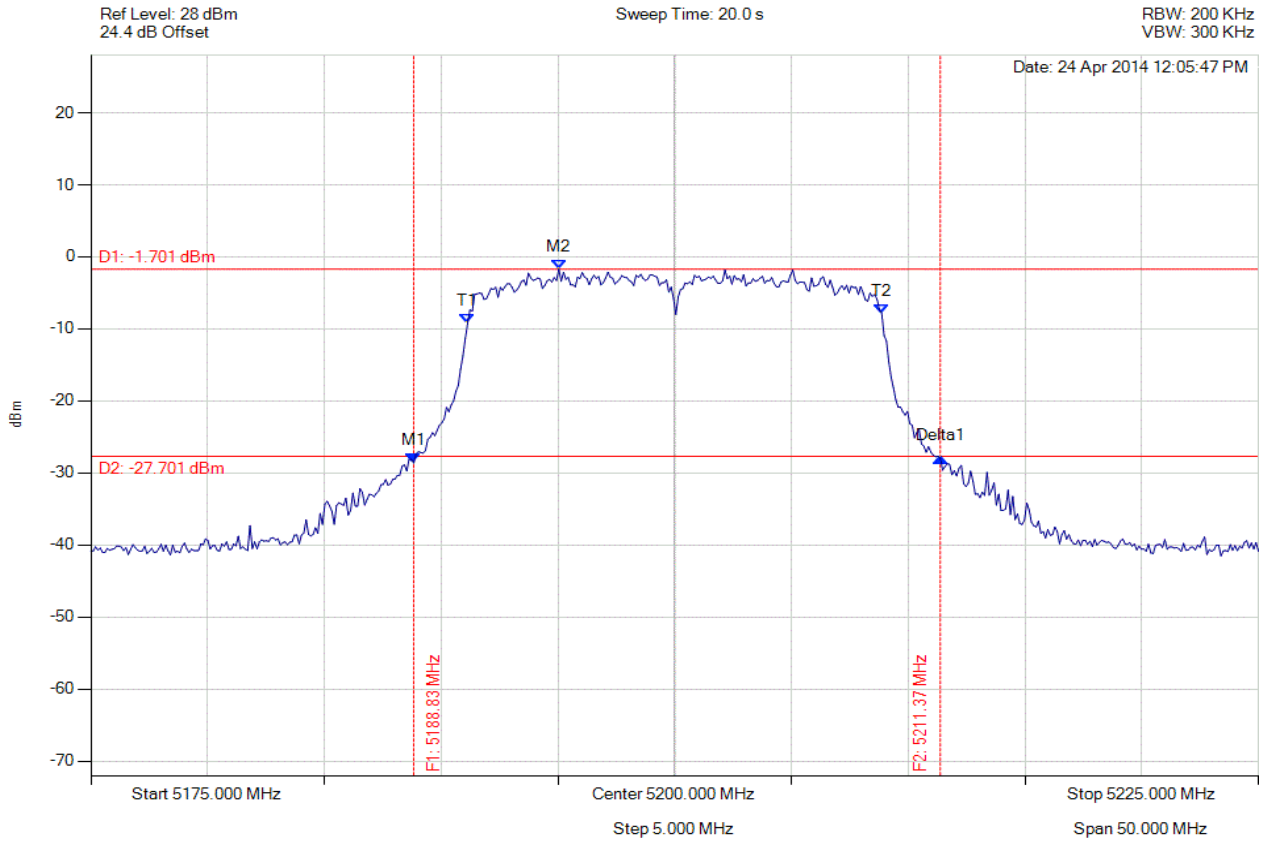

Analyser Setup	Marker : Frequency : Amplitude	Test Results
Detector = MAX PEAK Sweep Count = 0 RF Atten (dB) = 20 Trace Mode = VIEW	M1 : 5188.828 MHz : -28.632 dBm M2 : 5195.040 MHz : -1.701 dBm Delta1 : 22.545 MHz : 0.791 dB T1 : 5191.132 MHz : -9.246 dBm T2 : 5208.868 MHz : -7.839 dBm OBW : 17.735 MHz	Measured 26 dB Bandwidth: 22.545 MHz Measured 99% Bandwidth: 17.735 MHz

[Back to the Matrix](#)

This test report may be reproduced in full only. The document may only be updated by MiCOM Labs personnel. Any changes will be noted in the Document History section of the report.



Title: Xirrus Inc. XI-AC1300, XI-AC867 (non-DFS Bands)
To: FCC 47 CFR Part 15.407 & IC RSS-210
Serial #: XIRR04-U6 Rev A
Issue Date: 29th April 2014
Page: 163 of 199



26 dB & 99% BANDWIDTH

Variant: 802.11n HT-20, Channel: 5240.00 MHz, Chain a, Temp: Ambient, Voltage: 55 Vdc

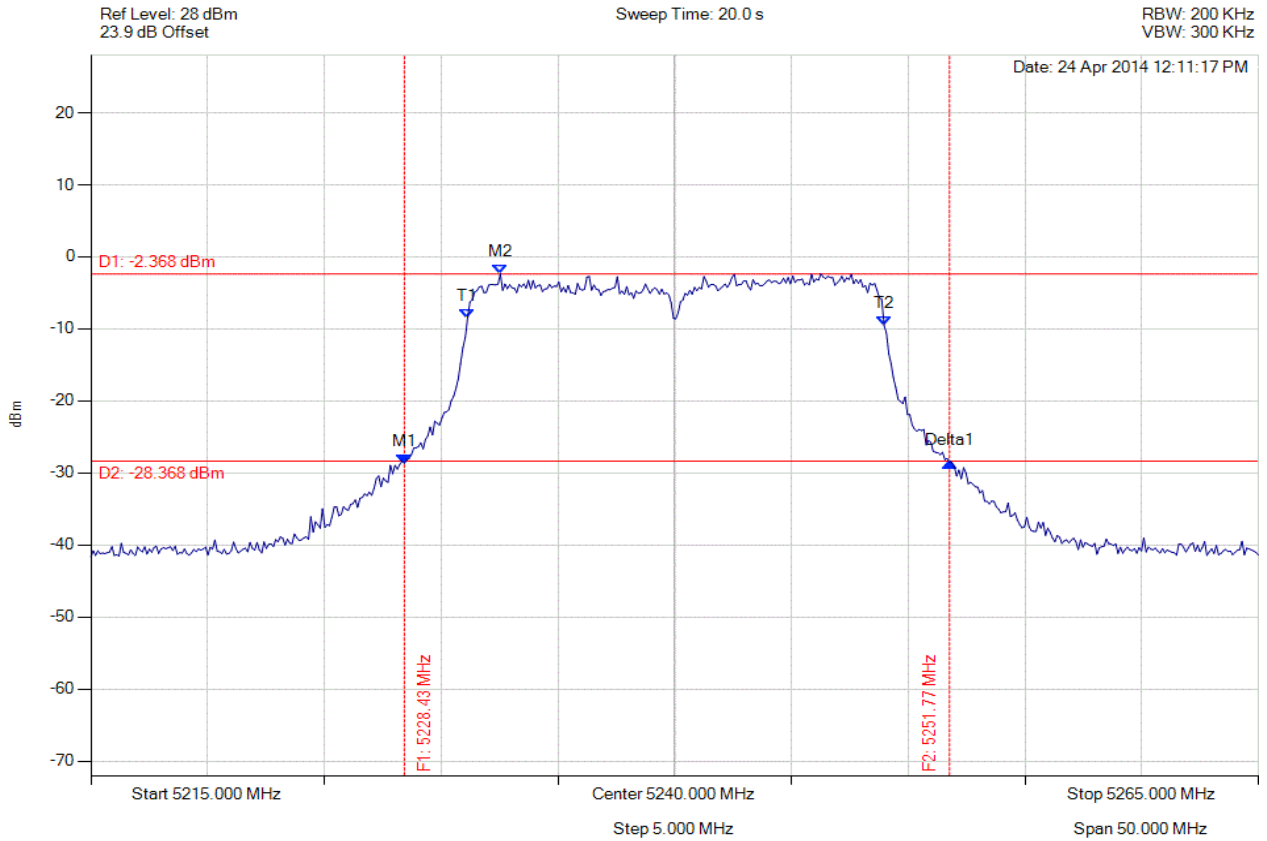

Analyser Setup	Marker : Frequency : Amplitude	Test Results
Detector = MAX PEAK Sweep Count = 0 RF Atten (dB) = 20 Trace Mode = VIEW	M1 : 5228.427 MHz : -28.670 dBm M2 : 5232.535 MHz : -2.368 dBm Delta1 : 23.347 MHz : 0.187 dB T1 : 5231.132 MHz : -8.489 dBm T2 : 5248.968 MHz : -9.539 dBm OBW : 17.836 MHz	Measured 26 dB Bandwidth: 23.347 MHz Measured 99% Bandwidth: 17.836 MHz

[Back to the Matrix](#)

This test report may be reproduced in full only. The document may only be updated by MiCOM Labs personnel. Any changes will be noted in the Document History section of the report.



Title: Xirrus Inc. XI-AC1300, XI-AC867 (non-DFS Bands)
To: FCC 47 CFR Part 15.407 & IC RSS-210
Serial #: XIRR04-U6 Rev A
Issue Date: 29th April 2014
Page: 164 of 199



26 dB & 99% BANDWIDTH

Variant: 802.11n HT-20, Channel: 5240.00 MHz, Chain b, Temp: Ambient, Voltage: 55 Vdc

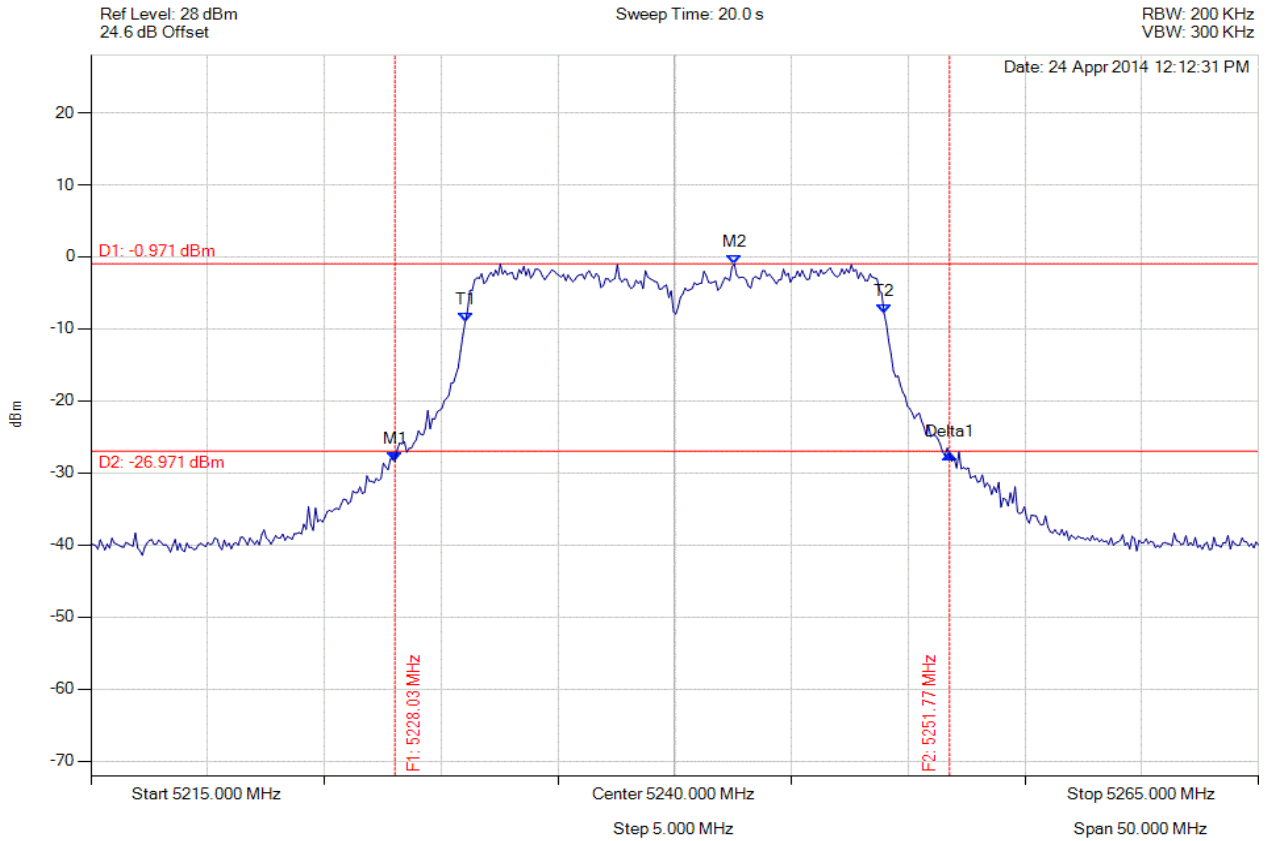

Analyser Setup	Marker : Frequency : Amplitude	Test Results
Detector = MAX PEAK Sweep Count = 0 RF Atten (dB) = 20 Trace Mode = VIEW	M1 : 5228.026 MHz : -28.434 dBm M2 : 5242.555 MHz : -0.971 dBm Delta1 : 23.747 MHz : 1.031 dB T1 : 5231.032 MHz : -9.008 dBm T2 : 5248.968 MHz : -7.879 dBm OBW : 17.936 MHz	Measured 26 dB Bandwidth: 23.747 MHz Measured 99% Bandwidth: 17.936 MHz

[Back to the Matrix](#)

This test report may be reproduced in full only. The document may only be updated by MiCOM Labs personnel. Any changes will be noted in the Document History section of the report.



Title: Xirrus Inc. XI-AC1300, XI-AC867 (non-DFS Bands)
To: FCC 47 CFR Part 15.407 & IC RSS-210
Serial #: XIRR04-U6 Rev A
Issue Date: 29th April 2014
Page: 165 of 199



26 dB & 99% BANDWIDTH

Variant: 802.11n HT-40, Channel: 5190.00 MHz, Chain a, Temp: Ambient, Voltage: 55 Vdc

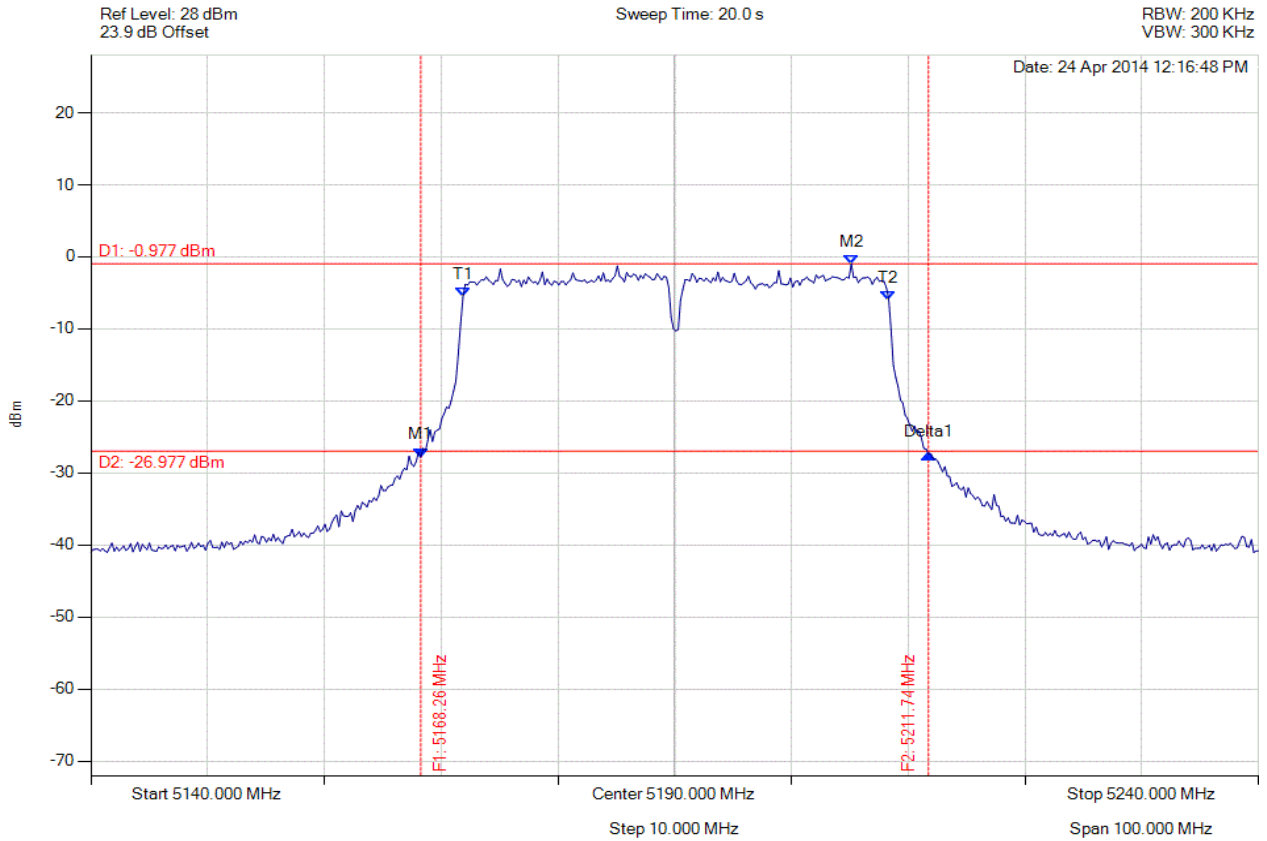

Analyser Setup	Marker : Frequency : Amplitude	Test Results
Detector = MAX PEAK Sweep Count = 0 RF Atten (dB) = 20 Trace Mode = VIEW	M1 : 5168.257 MHz : -27.806 dBm M2 : 5205.130 MHz : -0.977 dBm Delta1 : 43.487 MHz : 0.405 dB T1 : 5171.864 MHz : -5.612 dBm T2 : 5208.337 MHz : -6.004 dBm OBW : 36.473 MHz	Measured 26 dB Bandwidth: 43.487 MHz Measured 99% Bandwidth: 36.473 MHz

[Back to the Matrix](#)

This test report may be reproduced in full only. The document may only be updated by MiCOM Labs personnel. Any changes will be noted in the Document History section of the report.



Title: Xirrus Inc. XI-AC1300, XI-AC867 (non-DFS Bands)
To: FCC 47 CFR Part 15.407 & IC RSS-210
Serial #: XIRR04-U6 Rev A
Issue Date: 29th April 2014
Page: 166 of 199



26 dB & 99% BANDWIDTH

Variat: 802.11n HT-40, Channel: 5190.00 MHz, Chain b, Temp: Ambient, Voltage: 55 Vdc

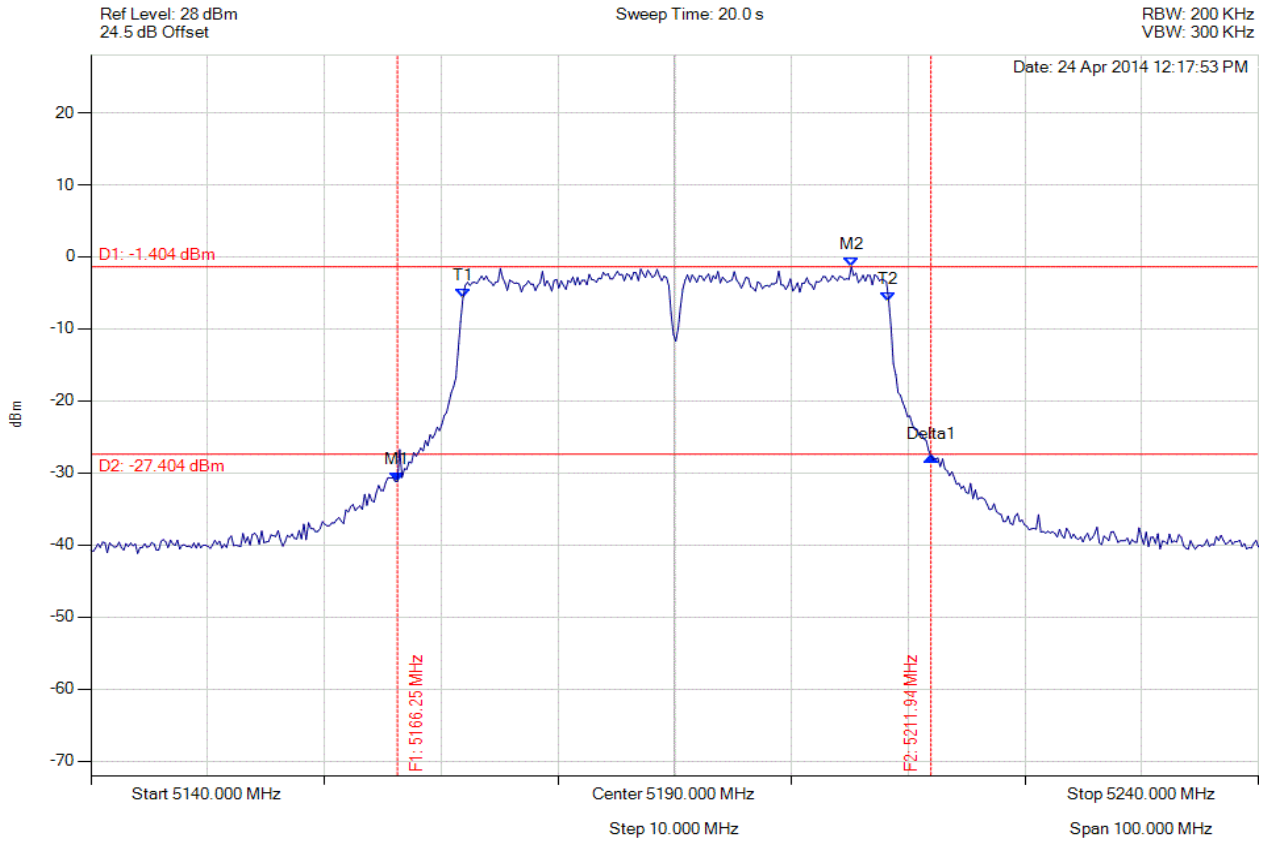

Analyser Setup	Marker : Frequency : Amplitude	Test Results
Detector = MAX PEAK Sweep Count = 0 RF Atten (dB) = 20 Trace Mode = VIEW	M1 : 5166.253 MHz : -31.200 dBm M2 : 5205.130 MHz : -1.404 dBm Delta1 : 45.691 MHz : 3.537 dB T1 : 5171.864 MHz : -5.693 dBm T2 : 5208.337 MHz : -6.202 dBm OBW : 36.473 MHz	Measured 26 dB Bandwidth: 45.691 MHz Measured 99% Bandwidth: 36.473 MHz

[Back to the Matrix](#)

This test report may be reproduced in full only. The document may only be updated by MiCOM Labs personnel. Any changes will be noted in the Document History section of the report.



Title: Xirrus Inc. XI-AC1300, XI-AC867 (non-DFS Bands)
To: FCC 47 CFR Part 15.407 & IC RSS-210
Serial #: XIRR04-U6 Rev A
Issue Date: 29th April 2014
Page: 167 of 199



26 dB & 99% BANDWIDTH

Variant: 802.11n HT-40, Channel: 5230.00 MHz, Chain a, Temp: Ambient, Voltage: 55 Vdc

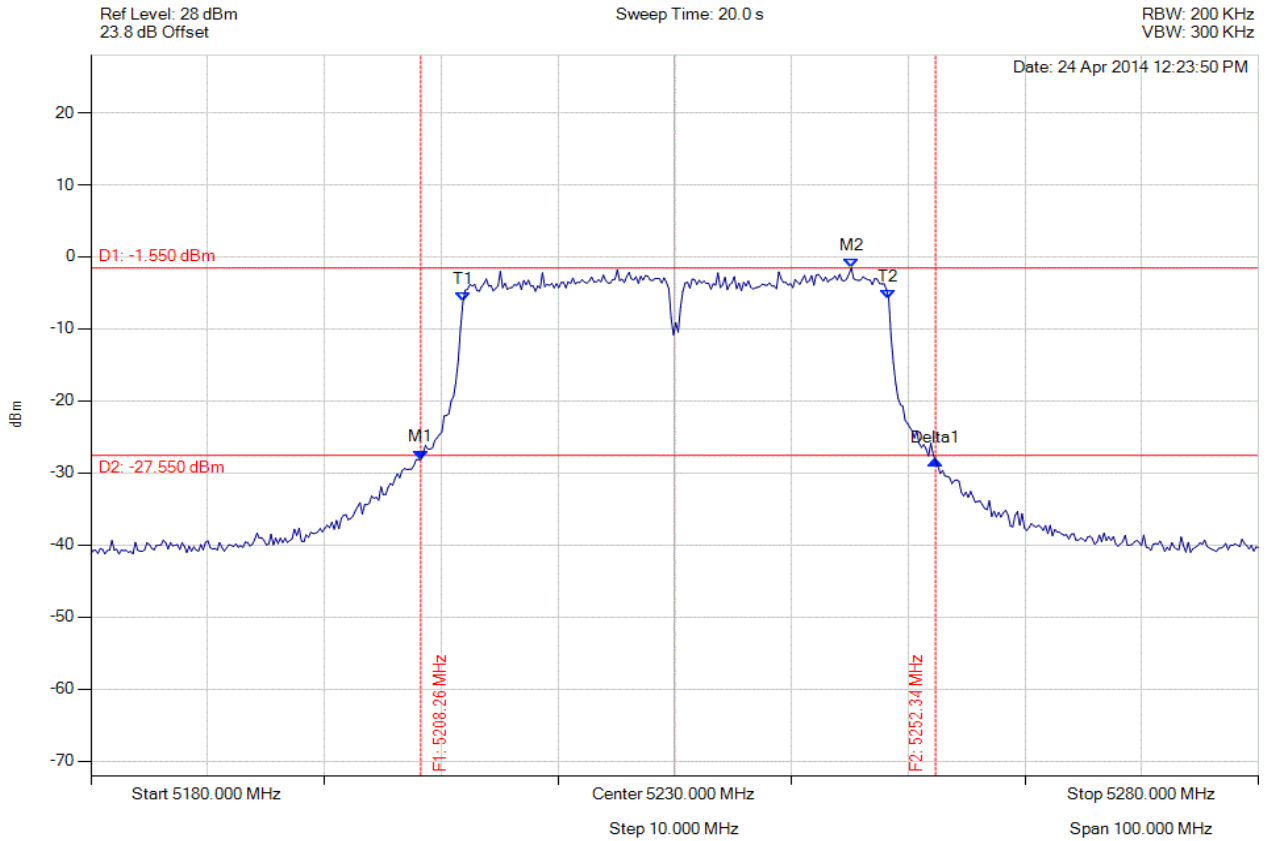

Analyser Setup	Marker : Frequency : Amplitude	Test Results
Detector = MAX PEAK Sweep Count = 0 RF Atten (dB) = 20 Trace Mode = VIEW	M1 : 5208.257 MHz : -28.146 dBm M2 : 5245.130 MHz : -1.550 dBm Delta1 : 44.088 MHz : -0.094 dB T1 : 5211.864 MHz : -6.277 dBm T2 : 5248.337 MHz : -5.947 dBm OBW : 36.473 MHz	Measured 26 dB Bandwidth: 44.088 MHz Measured 99% Bandwidth: 36.473 MHz

[Back to the Matrix](#)

This test report may be reproduced in full only. The document may only be updated by MiCOM Labs personnel. Any changes will be noted in the Document History section of the report.



Title: Xirrus Inc. XI-AC1300, XI-AC867 (non-DFS Bands)
To: FCC 47 CFR Part 15.407 & IC RSS-210
Serial #: XIRR04-U6 Rev A
Issue Date: 29th April 2014
Page: 168 of 199



26 dB & 99% BANDWIDTH

Variant: 802.11n HT-40, Channel: 5230.00 MHz, Chain b, Temp: Ambient, Voltage: 55 Vdc

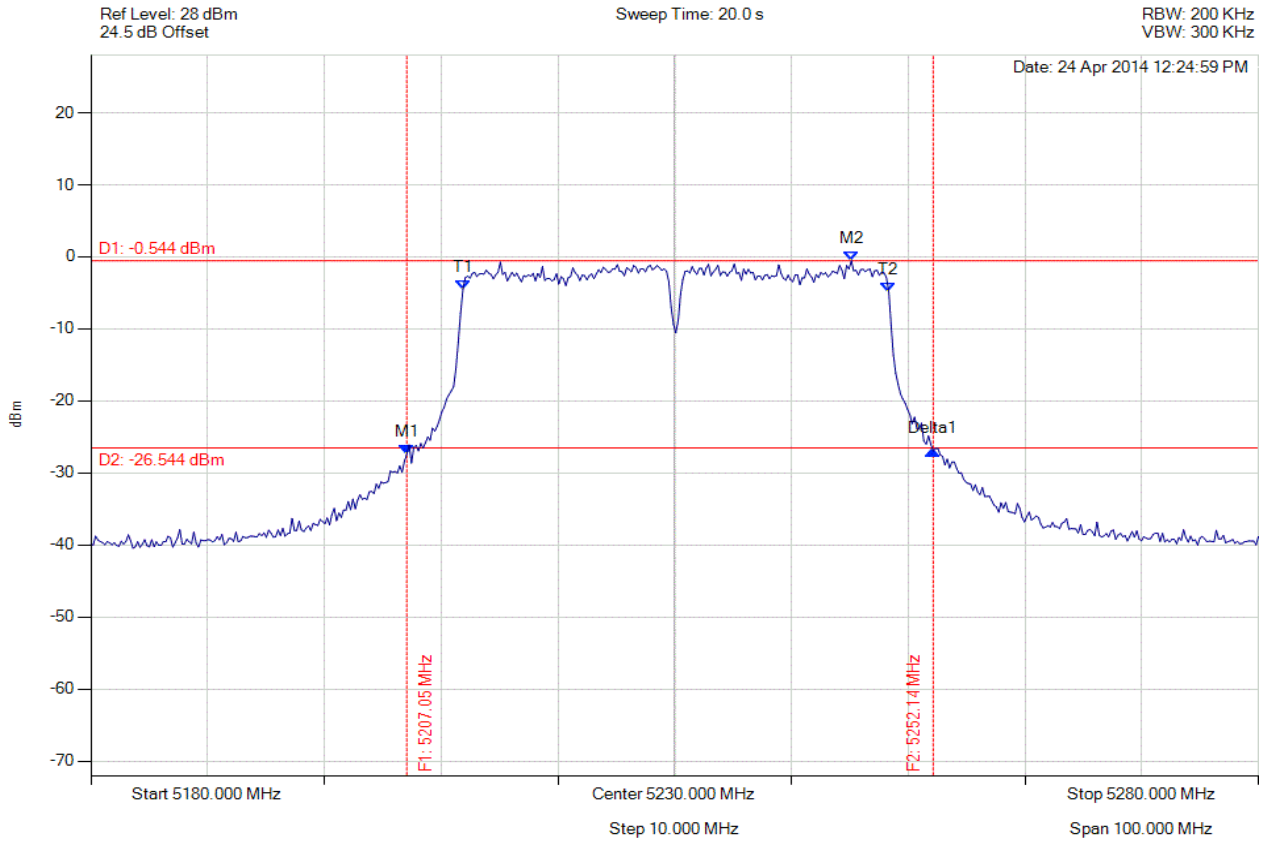

Analyser Setup	Marker : Frequency : Amplitude	Test Results
Detector = MAX PEAK Sweep Count = 0 RF Atten (dB) = 20 Trace Mode = VIEW	M1 : 5207.054 MHz : -27.413 dBm M2 : 5245.130 MHz : -0.544 dBm Delta1 : 45.090 MHz : 0.486 dB T1 : 5211.864 MHz : -4.532 dBm T2 : 5248.337 MHz : -4.851 dBm OBW : 36.473 MHz	Measured 26 dB Bandwidth: 45.090 MHz Measured 99% Bandwidth: 36.473 MHz

[Back to the Matrix](#)

This test report may be reproduced in full only. The document may only be updated by MiCOM Labs personnel. Any changes will be noted in the Document History section of the report.



A.2.2. Peak Power Spectral Density



PEAK POWER SPECTRAL DENSITY

Variant: 802.11a, Channel: 5180.00 MHz, Chain a, Temp: Ambient, Voltage: 55 Vdc

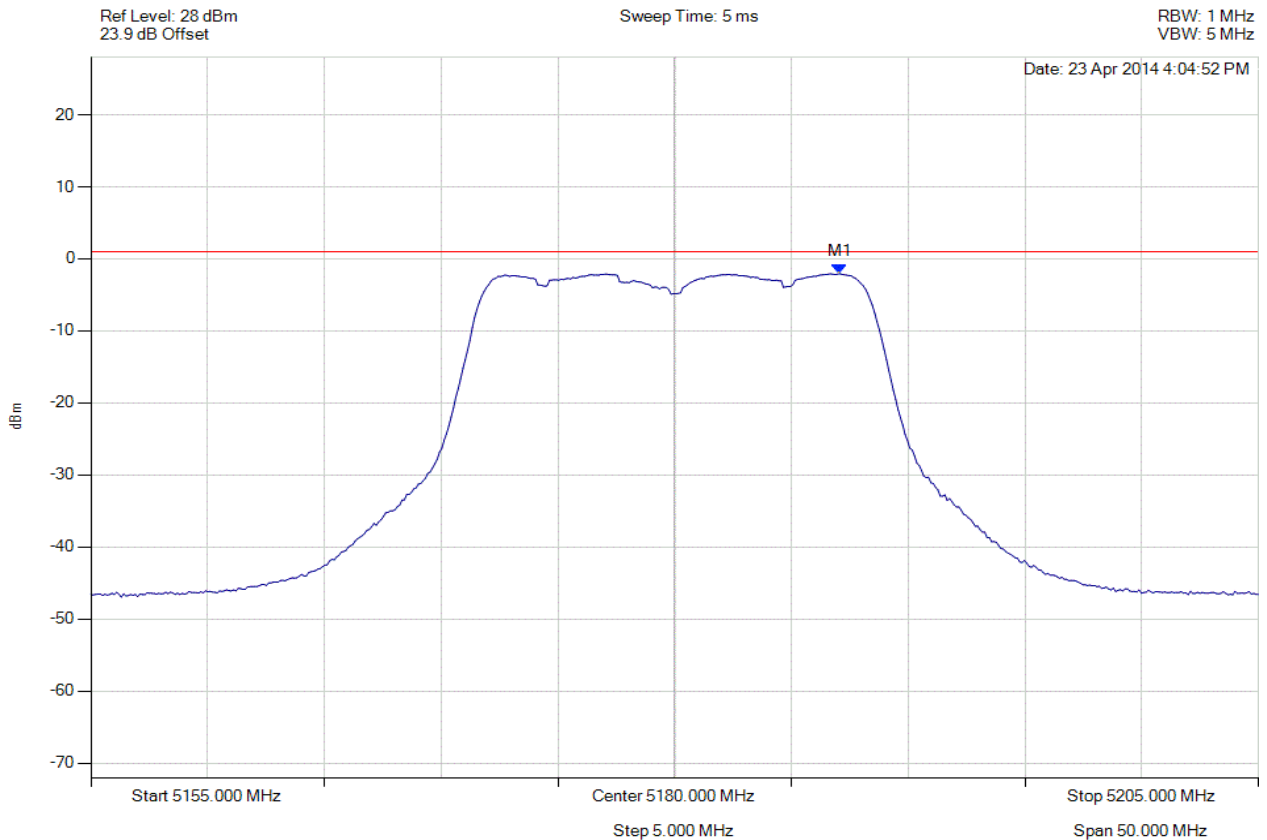

Analyser Setup	Marker : Frequency : Amplitude	Test Results
Detector = RMS Sweep Count = 100 RF Atten (dB) = 20 Trace Mode = VIEW	M1 : 5187.064 MHz : -2.071 dBm	Limit: ≤ 0.990 dBm Margin: 2.97 dB

[Back to the Matrix](#)

This test report may be reproduced in full only. The document may only be updated by MiCOM Labs personnel. Any changes will be noted in the Document History section of the report.



Title: Xirrus Inc. XI-AC1300, XI-AC867 (non-DFS Bands)
To: FCC 47 CFR Part 15.407 & IC RSS-210
Serial #: XIRR04-U6 Rev A
Issue Date: 29th April 2014
Page: 170 of 199



PEAK POWER SPECTRAL DENSITY

Variant: 802.11a, Channel: 5180.00 MHz, Chain b, Temp: Ambient, Voltage: 55 Vdc

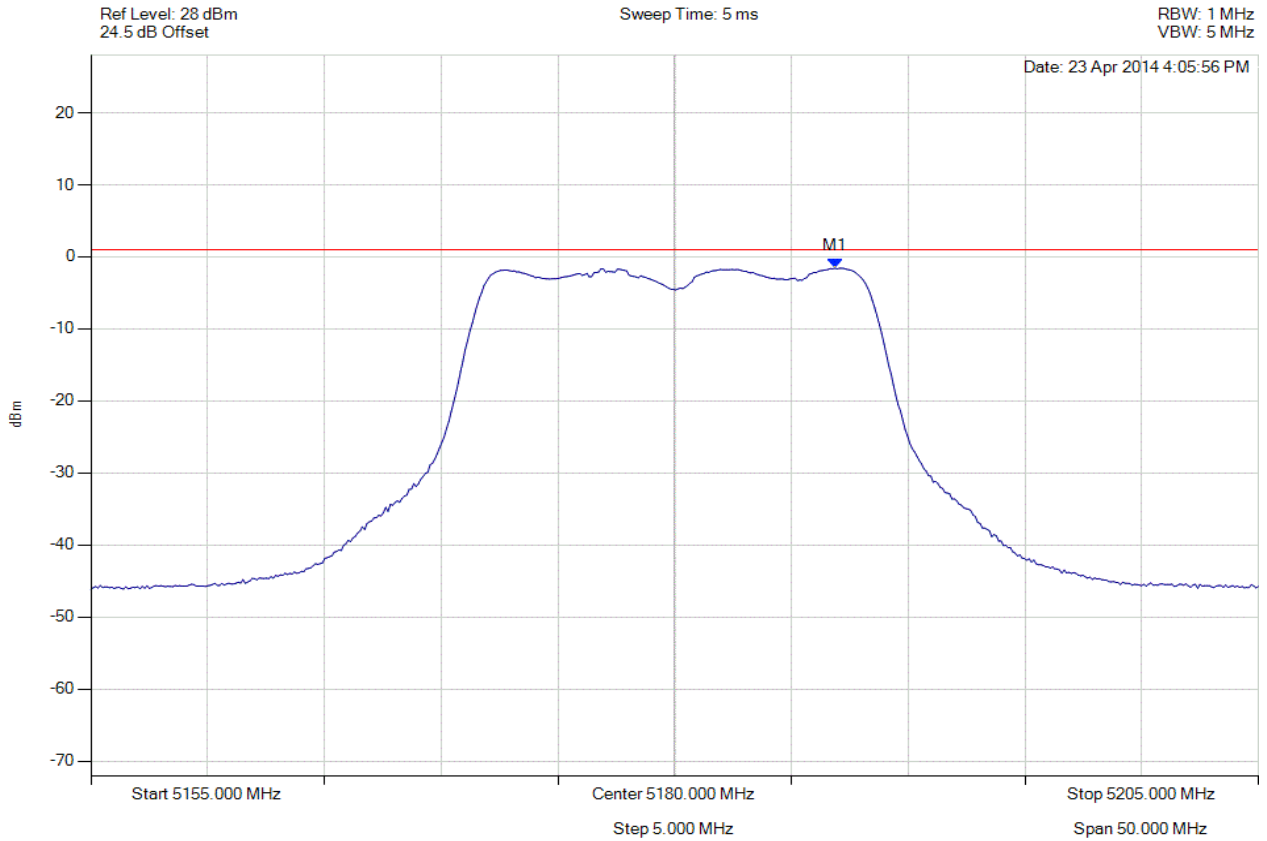

Analyser Setup	Marker : Frequency : Amplitude	Test Results
Detector = RMS Sweep Count = 100 RF Atten (dB) = 20 Trace Mode = VIEW	M1 : 5186.864 MHz : -1.574 dBm	Limit: ≤ 0.990 dBm Margin: 2.48 dB

[Back to the Matrix](#)

This test report may be reproduced in full only. The document may only be updated by MiCOM Labs personnel. Any changes will be noted in the Document History section of the report.



Title: Xirrus Inc. XI-AC1300, XI-AC867 (non-DFS Bands)
To: FCC 47 CFR Part 15.407 & IC RSS-210
Serial #: XIRR04-U6 Rev A
Issue Date: 29th April 2014
Page: 171 of 199



PEAK POWER SPECTRAL DENSITY

Variant: 802.11a, Channel: 5180.00 MHz, SUM, Temp: Ambient, Voltage: 55 Vdc

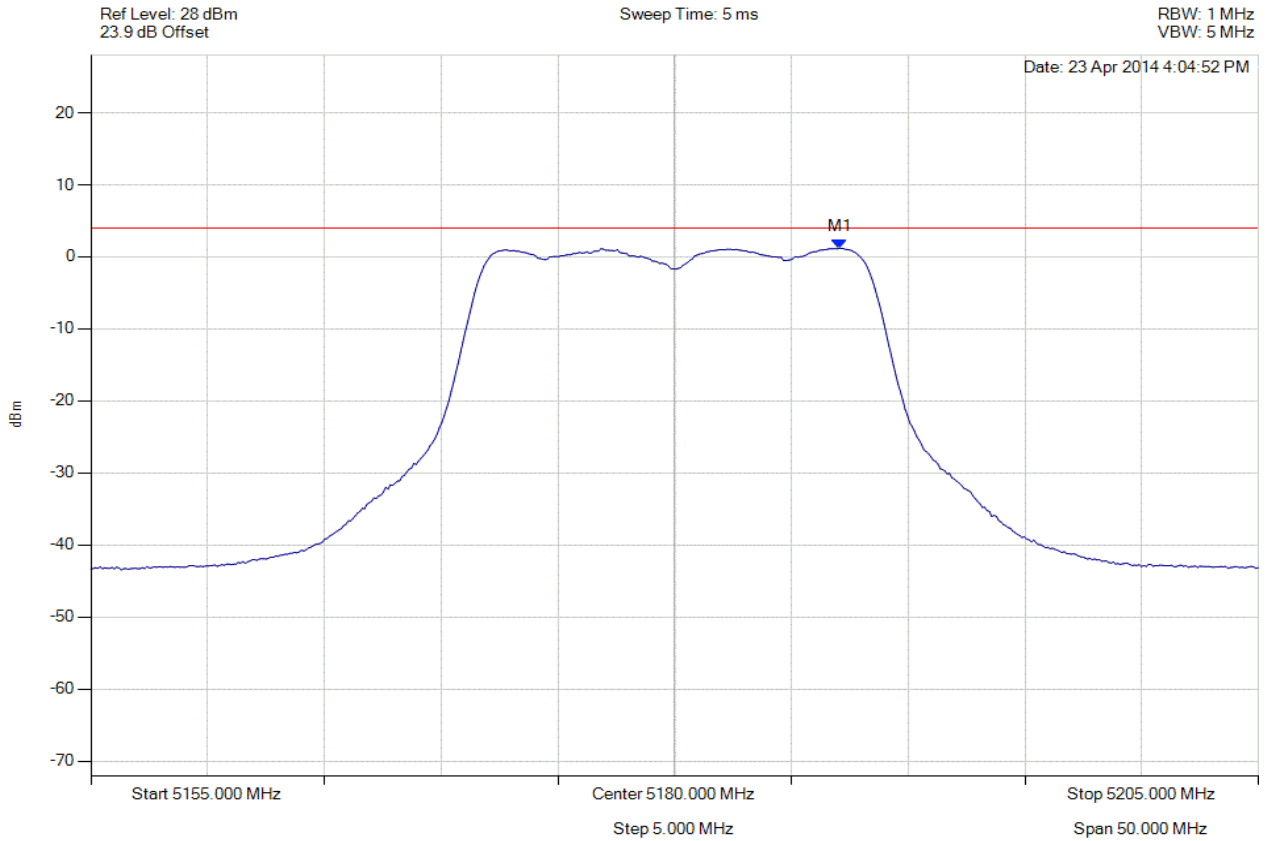

Analyser Setup	Marker : Frequency : Amplitude	Test Results
Detector = RMS Sweep Count = 100 RF Atten (dB) = 20 Trace Mode = VIEW	M1 : 5187.064 MHz : 1.191 dBm	Limit: ≤ 4.0 dBm Margin: -2.8 dB

[Back to the Matrix](#)

This test report may be reproduced in full only. The document may only be updated by MiCOM Labs personnel. Any changes will be noted in the Document History section of the report.



Title: Xirrus Inc. XI-AC1300, XI-AC867 (non-DFS Bands)
To: FCC 47 CFR Part 15.407 & IC RSS-210
Serial #: XIRR04-U6 Rev A
Issue Date: 29th April 2014
Page: 172 of 199



PEAK POWER SPECTRAL DENSITY

Variant: 802.11a, Channel: 5200.00 MHz, Chain a, Temp: Ambient, Voltage: 55 Vdc

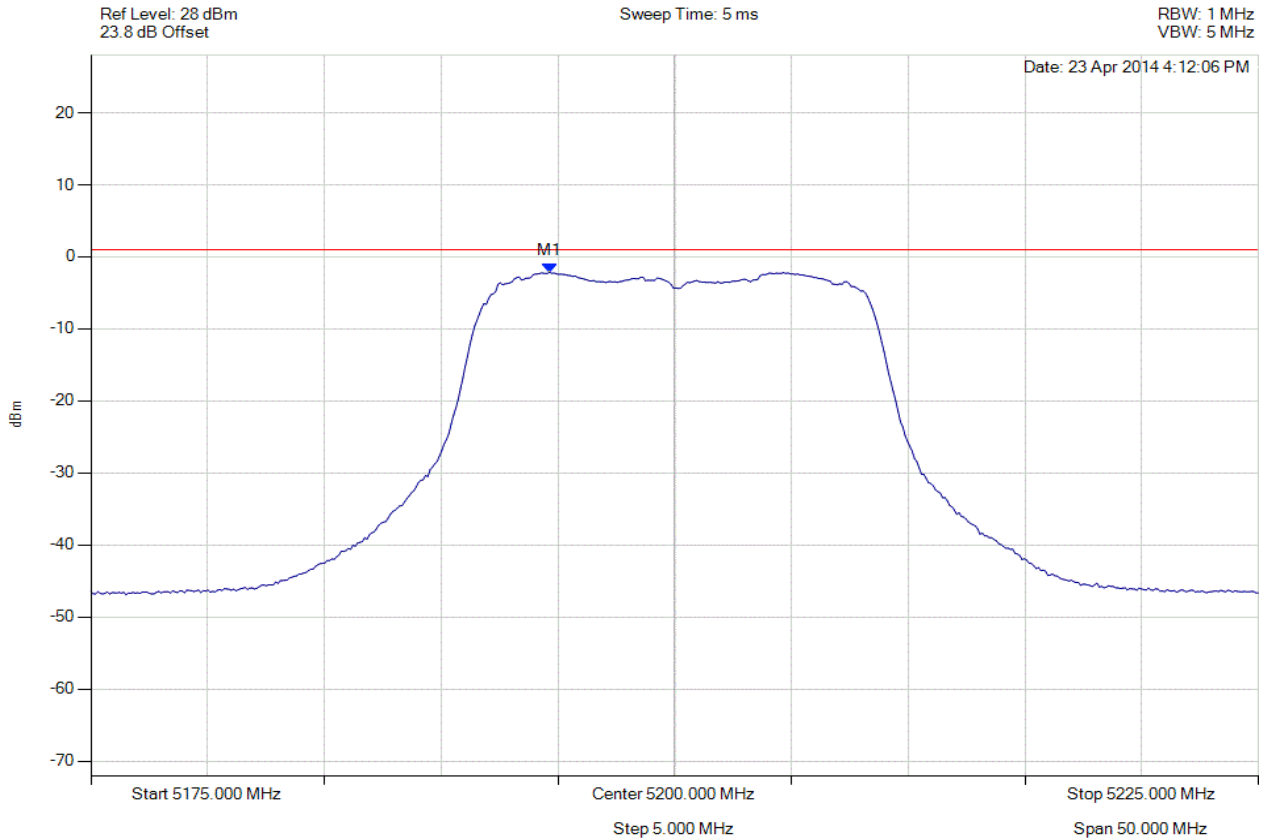

Analyser Setup	Marker : Frequency : Amplitude	Test Results
Detector = RMS Sweep Count = 100 RF Atten (dB) = 20 Trace Mode = VIEW	M1 : 5194.639 MHz : -2.145 dBm	Limit: ≤ 0.990 dBm Margin: 3.05 dB

[Back to the Matrix](#)

This test report may be reproduced in full only. The document may only be updated by MiCOM Labs personnel. Any changes will be noted in the Document History section of the report.



Title: Xirrus Inc. XI-AC1300, XI-AC867 (non-DFS Bands)
To: FCC 47 CFR Part 15.407 & IC RSS-210
Serial #: XIRR04-U6 Rev A
Issue Date: 29th April 2014
Page: 173 of 199



PEAK POWER SPECTRAL DENSITY

Variant: 802.11a, Channel: 5200.00 MHz, Chain b, Temp: Ambient, Voltage: 55 Vdc

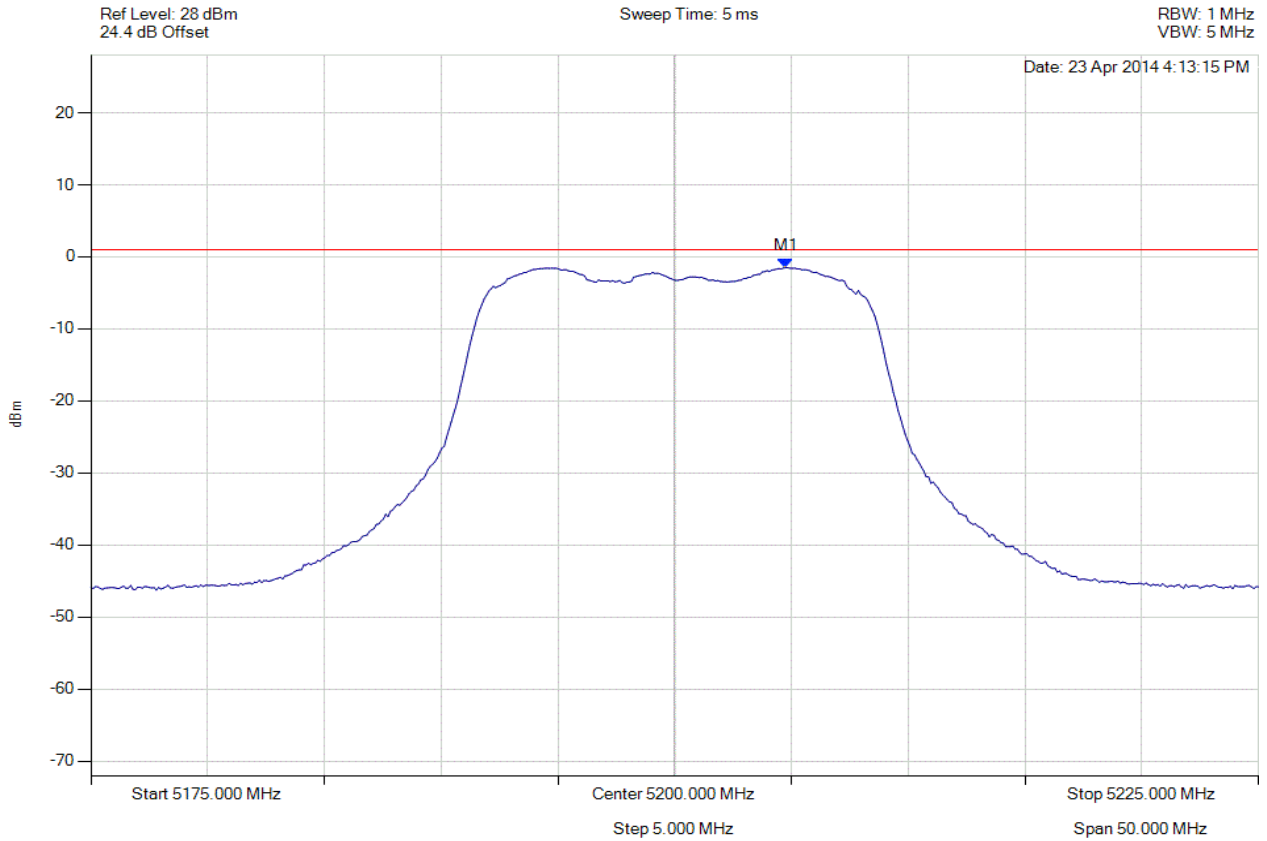

Analyser Setup	Marker : Frequency : Amplitude	Test Results
Detector = RMS Sweep Count = 100 RF Atten (dB) = 20 Trace Mode = VIEW	M1 : 5204.760 MHz : -1.504 dBm	Limit: ≤ 0.990 dBm Margin: 2.41 dB

[Back to the Matrix](#)

This test report may be reproduced in full only. The document may only be updated by MiCOM Labs personnel. Any changes will be noted in the Document History section of the report.



Title: Xirrus Inc. XI-AC1300, XI-AC867 (non-DFS Bands)
To: FCC 47 CFR Part 15.407 & IC RSS-210
Serial #: XIRR04-U6 Rev A
Issue Date: 29th April 2014
Page: 174 of 199



PEAK POWER SPECTRAL DENSITY

Variant: 802.11a, Channel: 5200.00 MHz, SUM, Temp: Ambient, Voltage: 55 Vdc

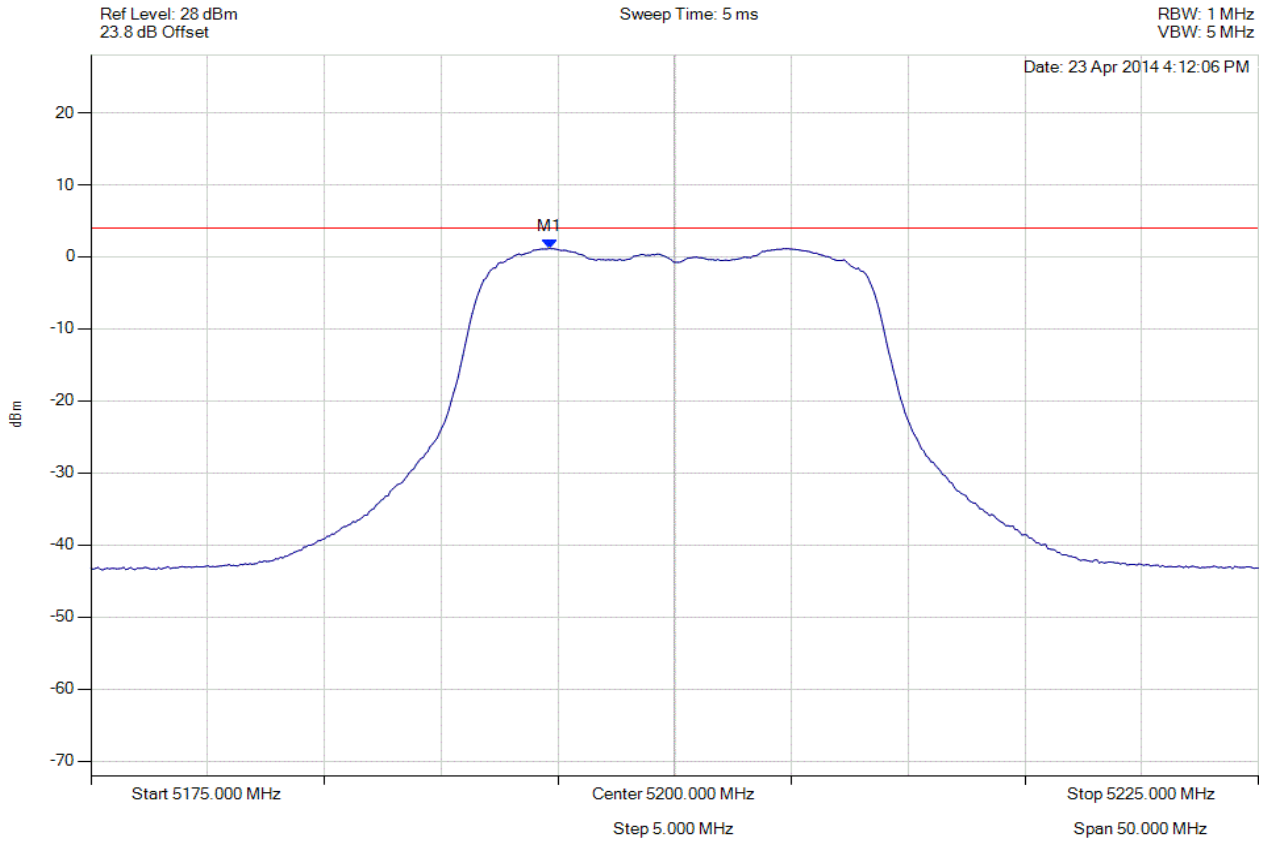

Analyser Setup	Marker : Frequency : Amplitude	Test Results
Detector = RMS Sweep Count = 100 RF Atten (dB) = 20 Trace Mode = VIEW	M1 : 5194.639 MHz : 1.150 dBm	Limit: ≤ 4.0 dBm Margin: -2.9 dB

[Back to the Matrix](#)

This test report may be reproduced in full only. The document may only be updated by MiCOM Labs personnel. Any changes will be noted in the Document History section of the report.



Title: Xirrus Inc. XI-AC1300, XI-AC867 (non-DFS Bands)
To: FCC 47 CFR Part 15.407 & IC RSS-210
Serial #: XIRR04-U6 Rev A
Issue Date: 29th April 2014
Page: 175 of 199



PEAK POWER SPECTRAL DENSITY

Variant: 802.11a, Channel: 5240.00 MHz, Chain a, Temp: Ambient, Voltage: 55 Vdc

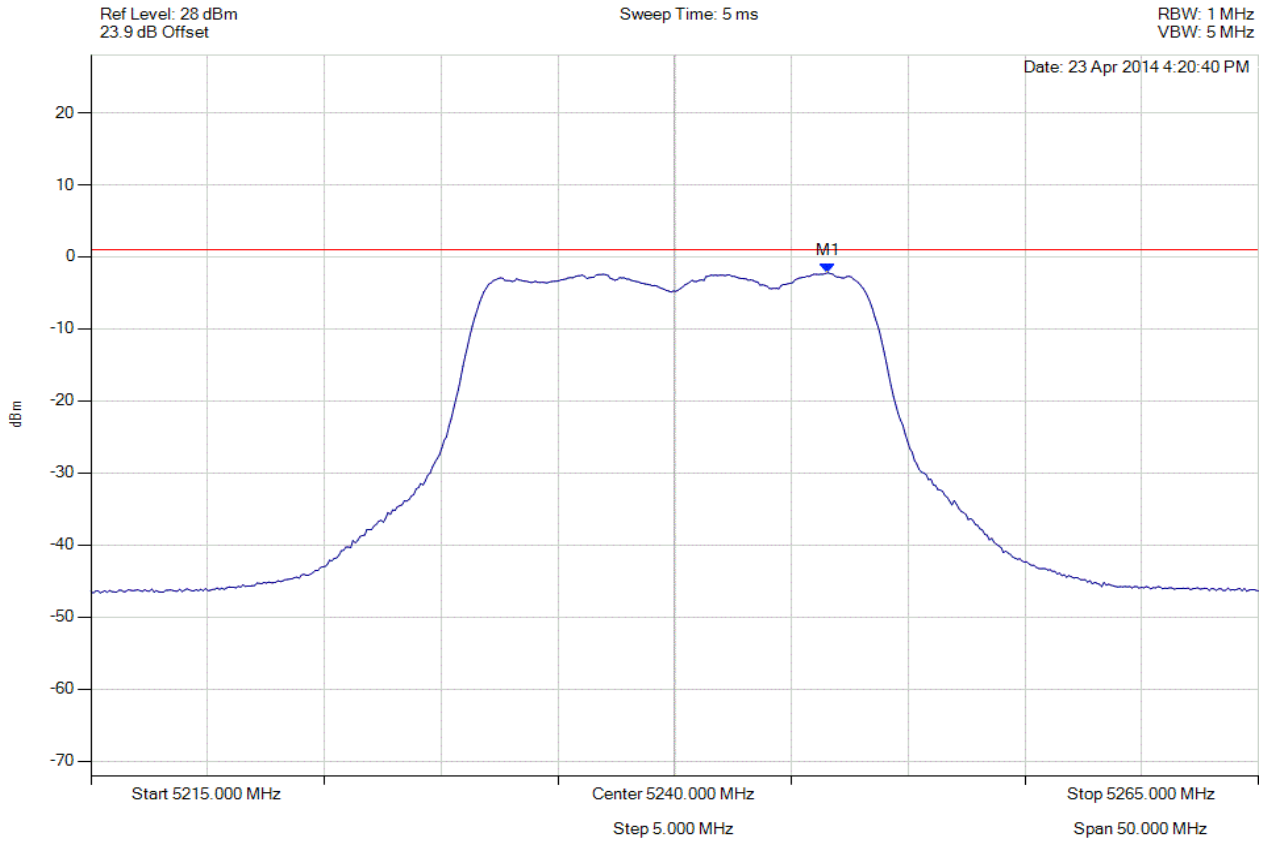

Analyser Setup	Marker : Frequency : Amplitude	Test Results
Detector = RMS Sweep Count = 100 RF Atten (dB) = 20 Trace Mode = VIEW	M1 : 5246.563 MHz : -2.217 dBm	Limit: ≤ 0.990 dBm Margin: 3.12 dB

[Back to the Matrix](#)

This test report may be reproduced in full only. The document may only be updated by MiCOM Labs personnel. Any changes will be noted in the Document History section of the report.



Title: Xirrus Inc. XI-AC1300, XI-AC867 (non-DFS Bands)
To: FCC 47 CFR Part 15.407 & IC RSS-210
Serial #: XIRR04-U6 Rev A
Issue Date: 29th April 2014
Page: 176 of 199



PEAK POWER SPECTRAL DENSITY

Variant: 802.11a, Channel: 5240.00 MHz, Chain b, Temp: Ambient, Voltage: 55 Vdc

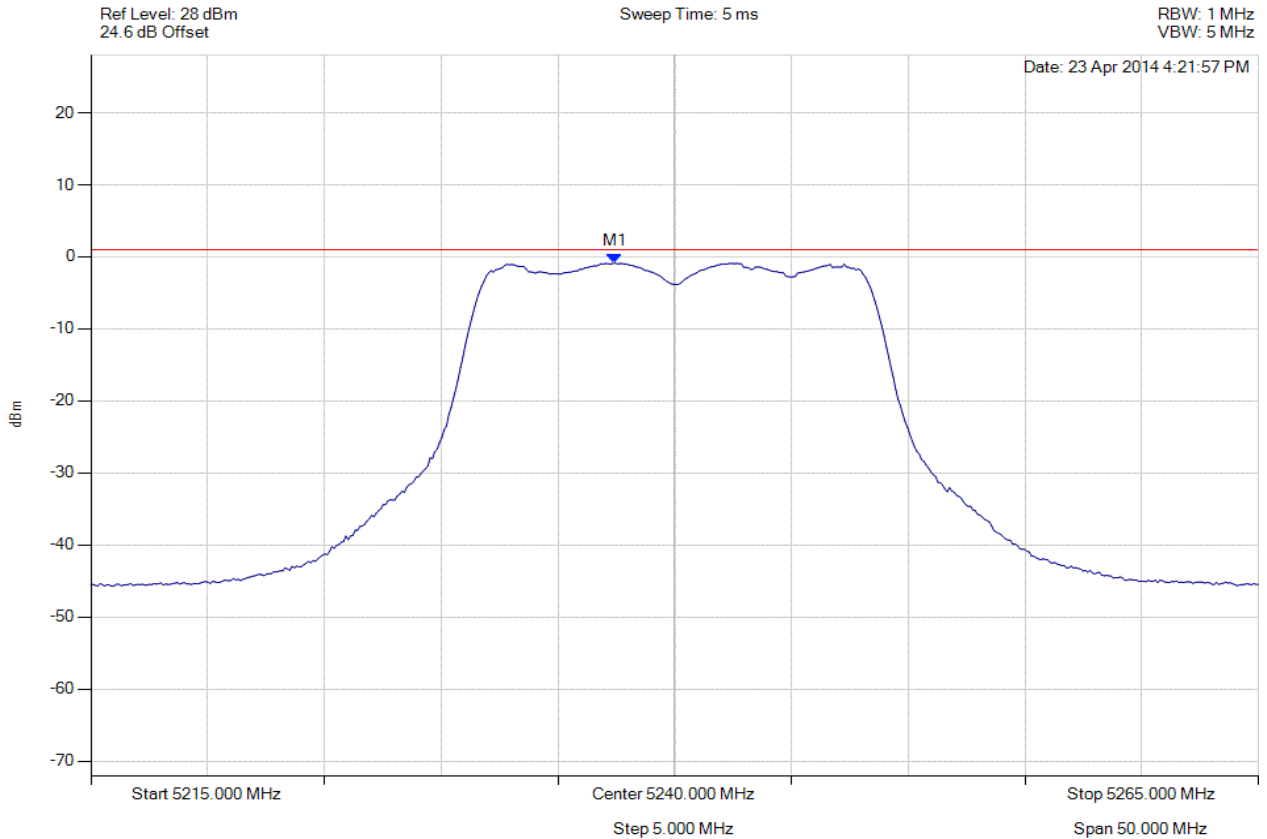

Analyser Setup	Marker : Frequency : Amplitude	Test Results
Detector = RMS Sweep Count = 100 RF Atten (dB) = 20 Trace Mode = VIEW	M1 : 5237.445 MHz : -0.854 dBm	Limit: ≤ 0.990 dBm Margin: 1.76 dB

[Back to the Matrix](#)

This test report may be reproduced in full only. The document may only be updated by MiCOM Labs personnel. Any changes will be noted in the Document History section of the report.



Title: Xirrus Inc. XI-AC1300, XI-AC867 (non-DFS Bands)
To: FCC 47 CFR Part 15.407 & IC RSS-210
Serial #: XIRR04-U6 Rev A
Issue Date: 29th April 2014
Page: 177 of 199



PEAK POWER SPECTRAL DENSITY

Variant: 802.11a, Channel: 5240.00 MHz, SUM, Temp: Ambient, Voltage: 55 Vdc

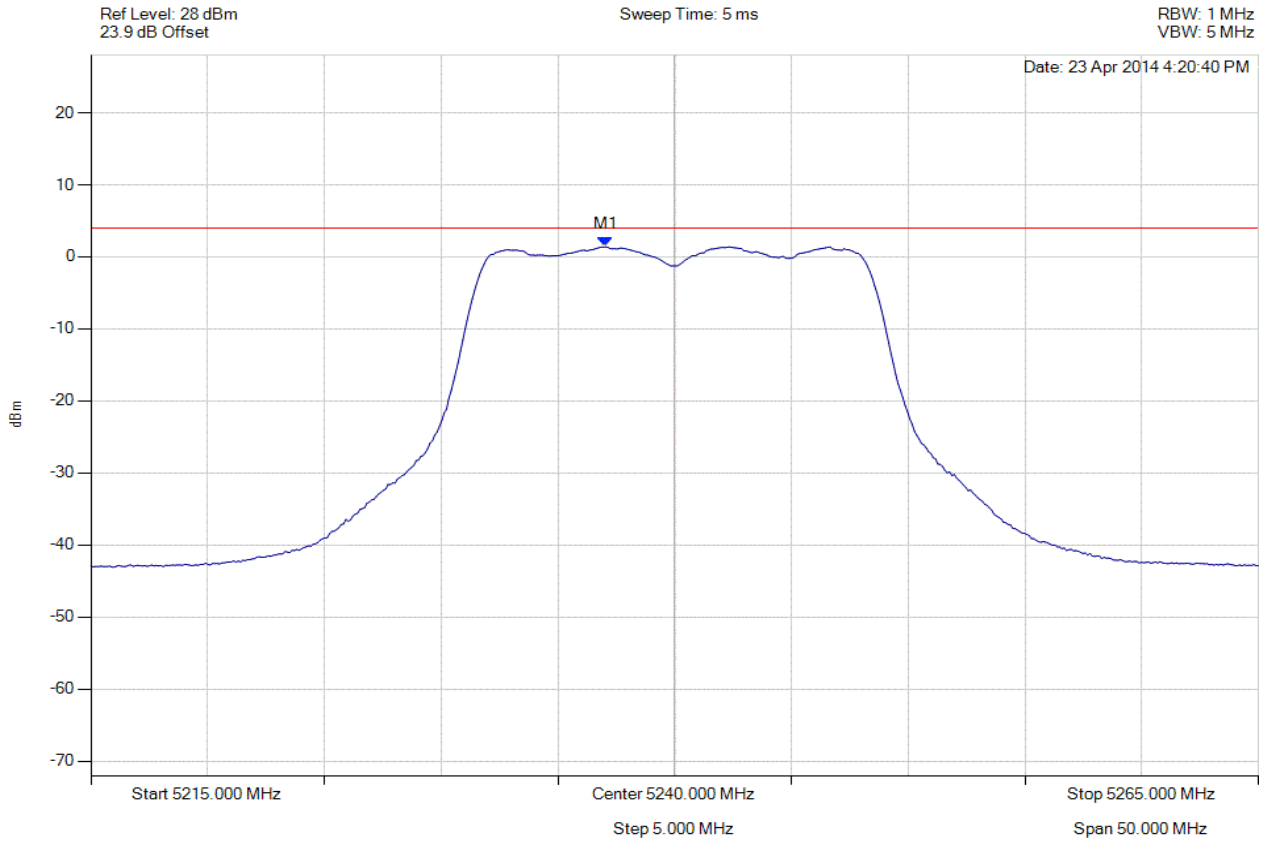

Analyser Setup	Marker : Frequency : Amplitude	Test Results
Detector = RMS Sweep Count = 100 RF Atten (dB) = 20 Trace Mode = VIEW	M1 : 5237.044 MHz : 1.388 dBm	Limit: ≤ 4.0 dBm Margin: -2.6 dB

[Back to the Matrix](#)

This test report may be reproduced in full only. The document may only be updated by MiCOM Labs personnel. Any changes will be noted in the Document History section of the report.



Title: Xirrus Inc. XI-AC1300, XI-AC867 (non-DFS Bands)
To: FCC 47 CFR Part 15.407 & IC RSS-210
Serial #: XIRR04-U6 Rev A
Issue Date: 29th April 2014
Page: 178 of 199



PEAK POWER SPECTRAL DENSITY

Variant: 802.11ac-80, Channel: 5210.00 MHz, Chain a, Temp: Ambient, Voltage: 55 Vdc

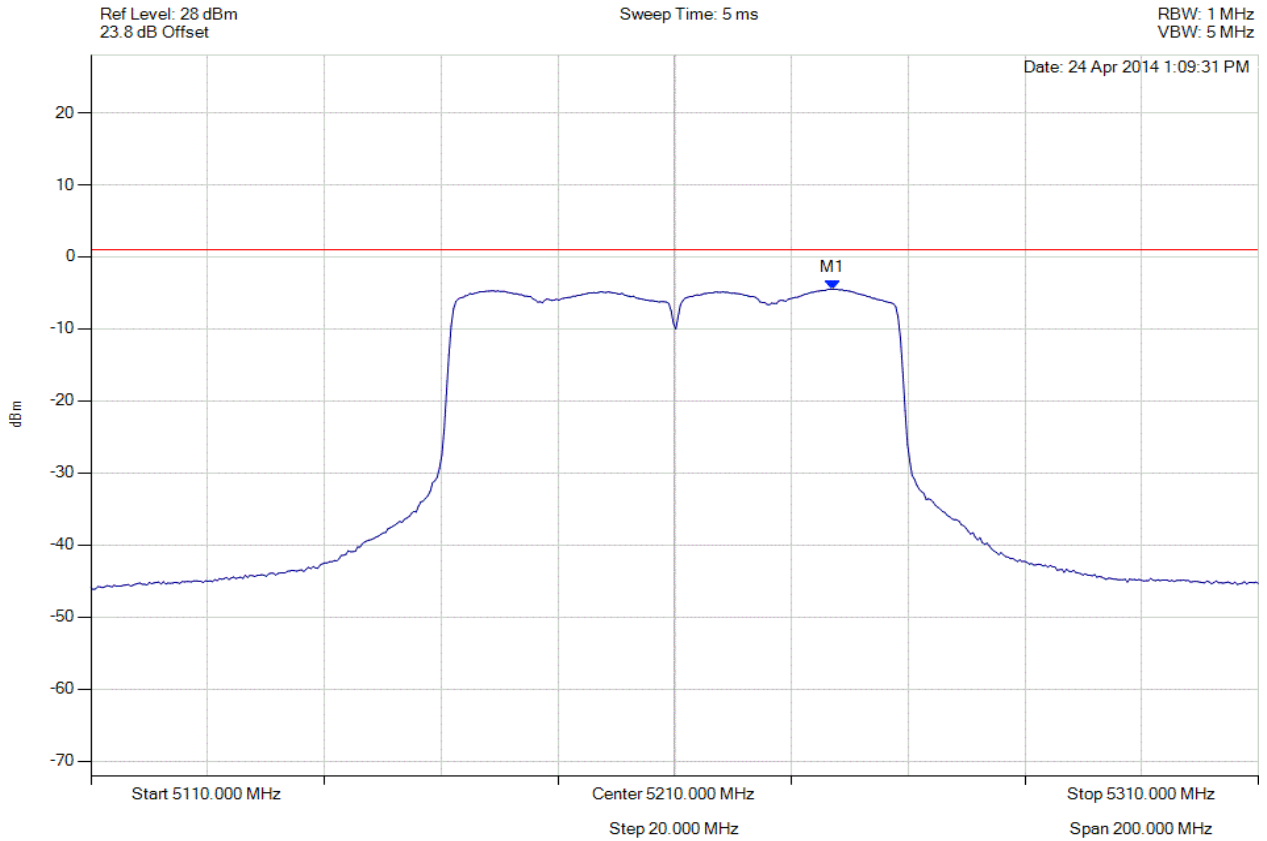

Analyser Setup	Marker : Frequency : Amplitude	Test Results
Detector = RMS Sweep Count = 100 RF Atten (dB) = 20 Trace Mode = VIEW	M1 : 5237.054 MHz : -4.502 dBm	Limit: ≤ 0.990 dBm Margin: 5.40 dB

[Back to the Matrix](#)

This test report may be reproduced in full only. The document may only be updated by MiCOM Labs personnel. Any changes will be noted in the Document History section of the report.



Title: Xirrus Inc. XI-AC1300, XI-AC867 (non-DFS Bands)
To: FCC 47 CFR Part 15.407 & IC RSS-210
Serial #: XIRR04-U6 Rev A
Issue Date: 29th April 2014
Page: 179 of 199



PEAK POWER SPECTRAL DENSITY

Variant: 802.11ac-80, Channel: 5210.00 MHz, Chain b, Temp: Ambient, Voltage: 55 Vdc

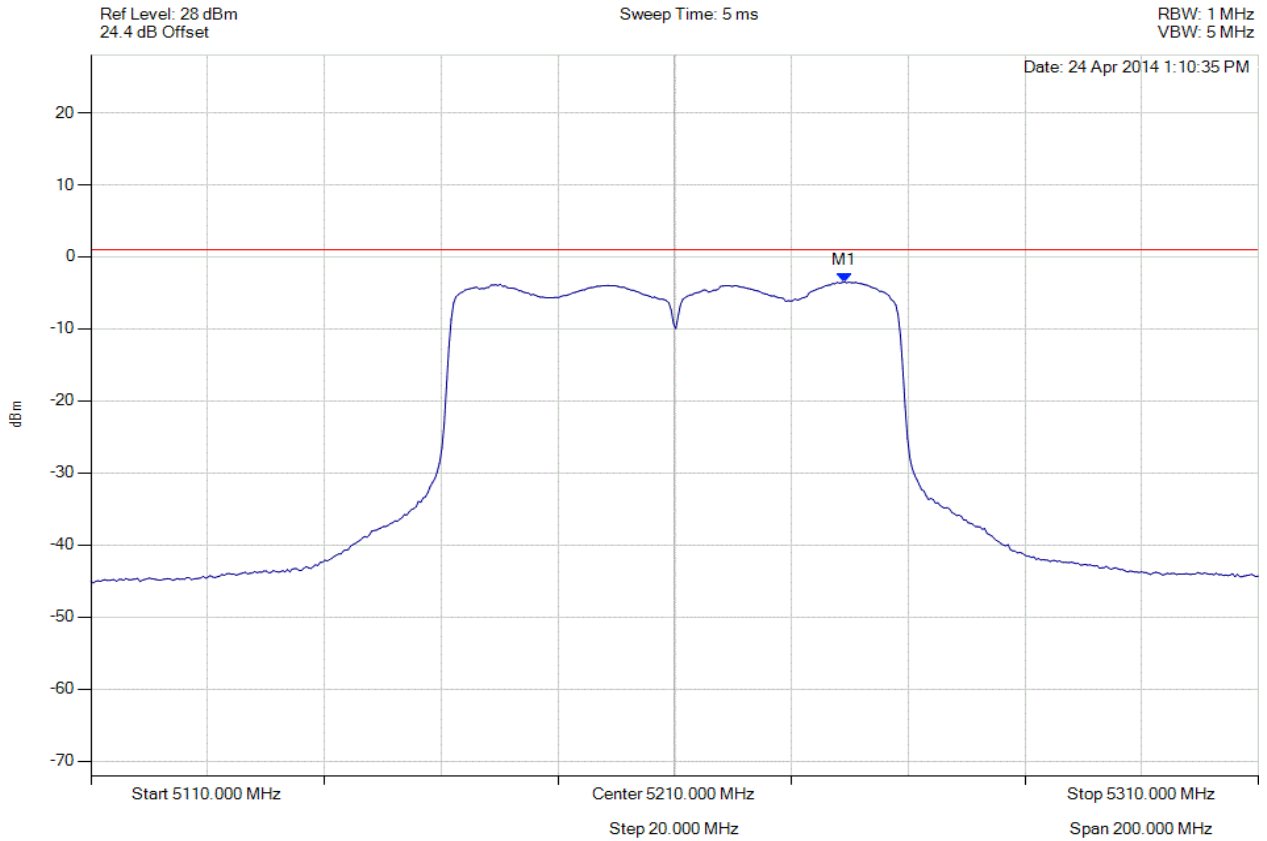

Analyser Setup	Marker : Frequency : Amplitude	Test Results
Detector = RMS Sweep Count = 100 RF Atten (dB) = 20 Trace Mode = VIEW	M1 : 5239.058 MHz : -3.495 dBm	Limit: ≤ 0.990 dBm Margin: 4.40 dB

[Back to the Matrix](#)

This test report may be reproduced in full only. The document may only be updated by MiCOM Labs personnel. Any changes will be noted in the Document History section of the report.



Title: Xirrus Inc. XI-AC1300, XI-AC867 (non-DFS Bands)
To: FCC 47 CFR Part 15.407 & IC RSS-210
Serial #: XIRR04-U6 Rev A
Issue Date: 29th April 2014
Page: 180 of 199



PEAK POWER SPECTRAL DENSITY

Variant: 802.11ac-80, Channel: 5210.00 MHz, SUM, Temp: Ambient, Voltage: 55 Vdc

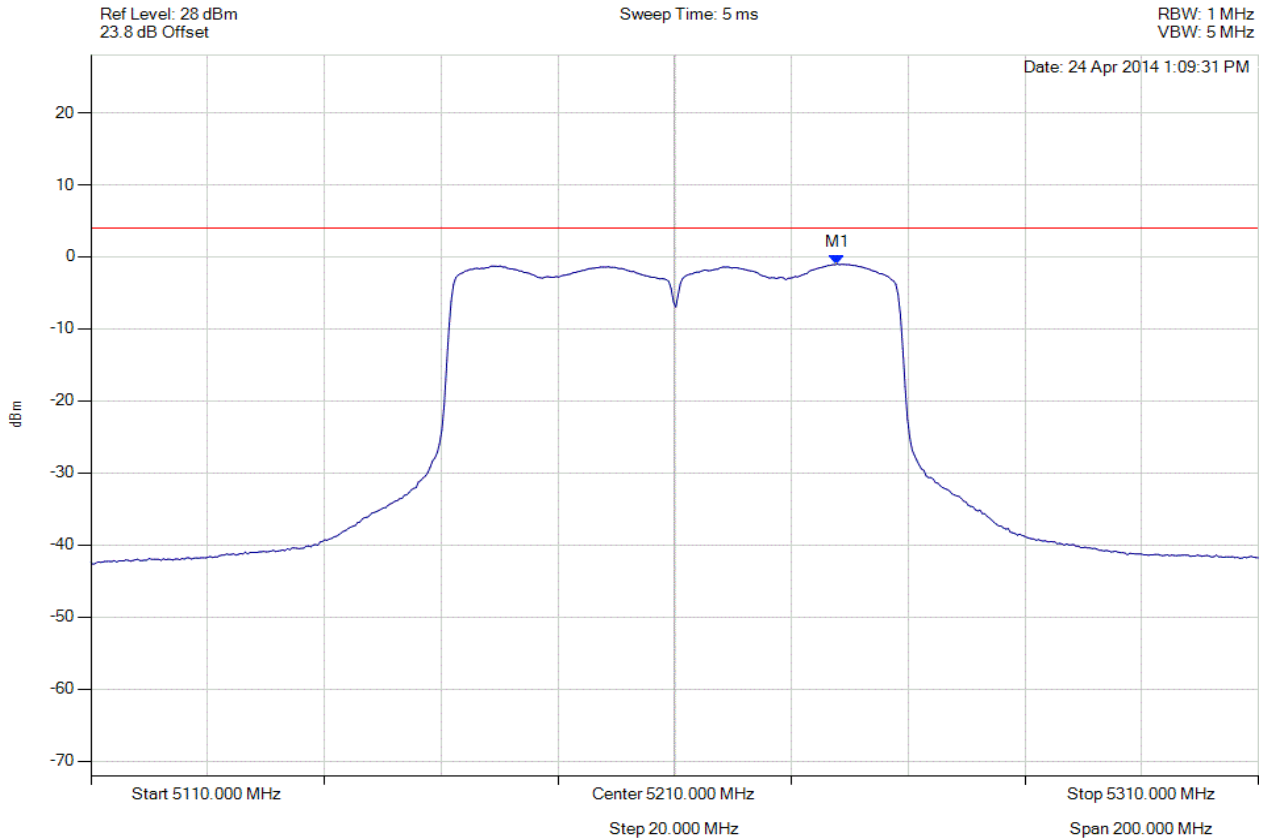

Analyser Setup	Marker : Frequency : Amplitude	Test Results
Detector = RMS Sweep Count = 100 RF Atten (dB) = 20 Trace Mode = VIEW	M1 : 5237.856 MHz : -0.999 dBm	Limit: ≤ 4.0 dBm Margin: -5.0 dB

[Back to the Matrix](#)

This test report may be reproduced in full only. The document may only be updated by MiCOM Labs personnel. Any changes will be noted in the Document History section of the report.



Title: Xirrus Inc. XI-AC1300, XI-AC867 (non-DFS Bands)
To: FCC 47 CFR Part 15.407 & IC RSS-210
Serial #: XIRR04-U6 Rev A
Issue Date: 29th April 2014
Page: 181 of 199



PEAK POWER SPECTRAL DENSITY

Variant: 802.11n HT-20, Channel: 5180.00 MHz, Chain a, Temp: Ambient, Voltage: 55 Vdc

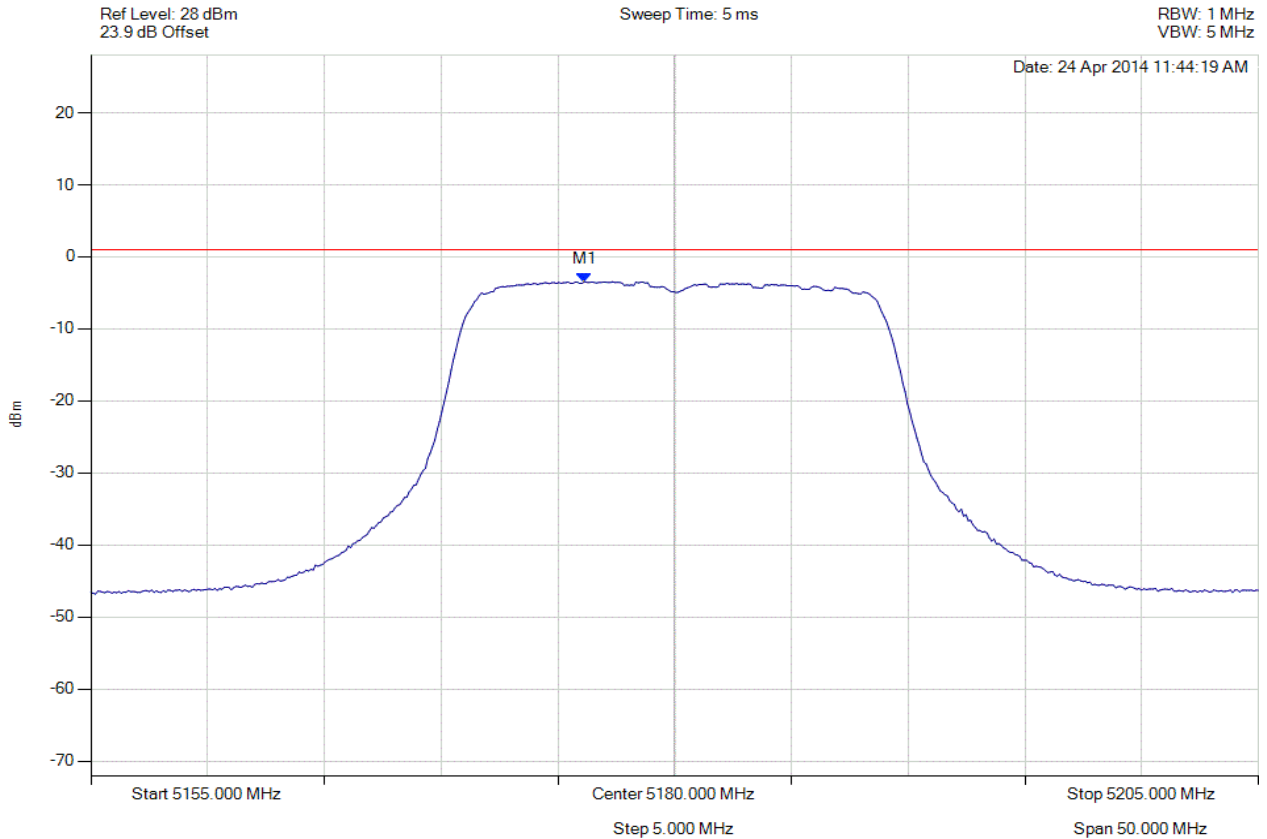

Analyser Setup	Marker : Frequency : Amplitude	Test Results
Detector = RMS Sweep Count = 100 RF Atten (dB) = 20 Trace Mode = VIEW	M1 : 5176.142 MHz : -3.459 dBm	Limit: ≤ 0.990 dBm Margin: 4.36 dB

[Back to the Matrix](#)

This test report may be reproduced in full only. The document may only be updated by MiCOM Labs personnel. Any changes will be noted in the Document History section of the report.



Title: Xirrus Inc. XI-AC1300, XI-AC867 (non-DFS Bands)
To: FCC 47 CFR Part 15.407 & IC RSS-210
Serial #: XIRR04-U6 Rev A
Issue Date: 29th April 2014
Page: 182 of 199



PEAK POWER SPECTRAL DENSITY

Variant: 802.11n HT-20, Channel: 5180.00 MHz, Chain b, Temp: Ambient, Voltage: 55 Vdc

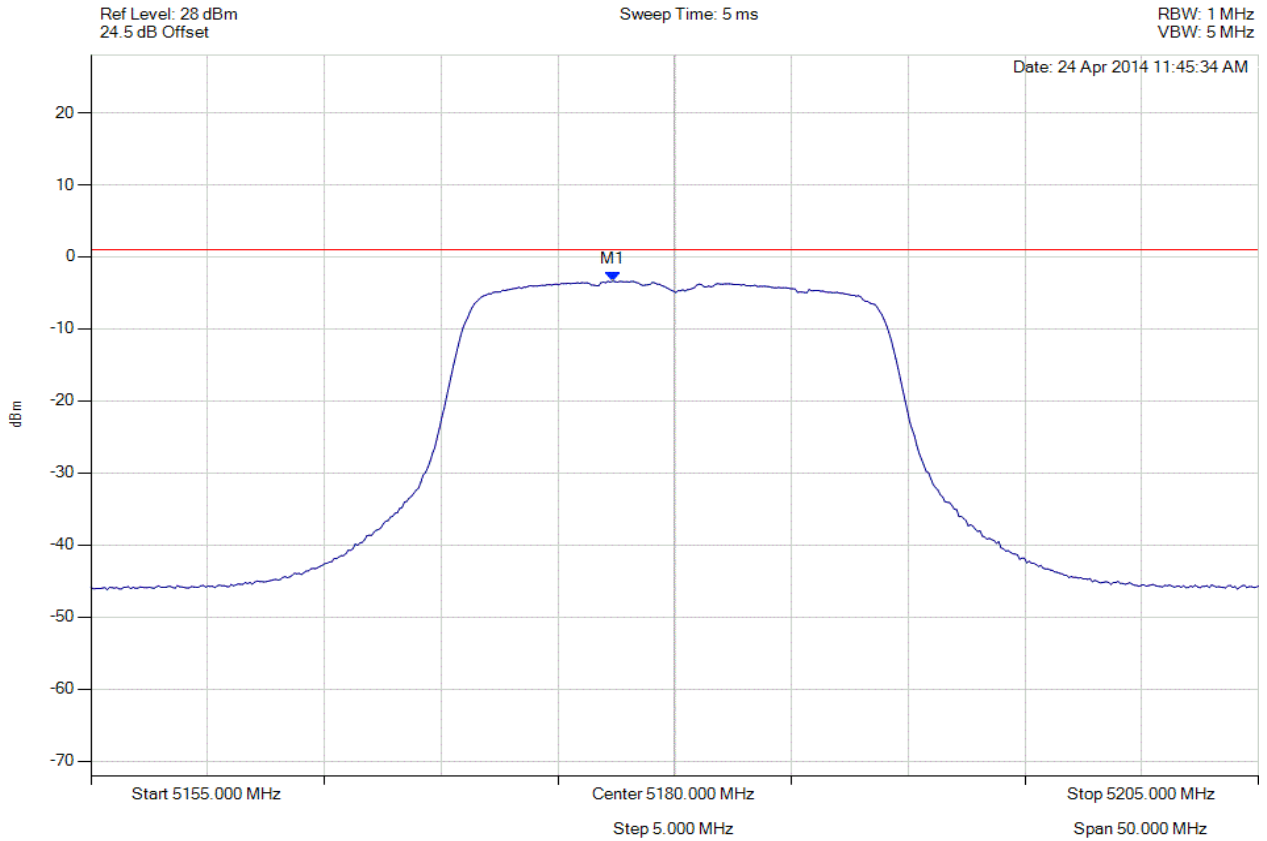

Analyser Setup	Marker : Frequency : Amplitude	Test Results
Detector = RMS Sweep Count = 100 RF Atten (dB) = 20 Trace Mode = VIEW	M1 : 5177.345 MHz : -3.377 dBm	Limit: ≤ 0.990 dBm Margin: 4.28 dB

[Back to the Matrix](#)

This test report may be reproduced in full only. The document may only be updated by MiCOM Labs personnel. Any changes will be noted in the Document History section of the report.



Title: Xirrus Inc. XI-AC1300, XI-AC867 (non-DFS Bands)
To: FCC 47 CFR Part 15.407 & IC RSS-210
Serial #: XIRR04-U6 Rev A
Issue Date: 29th April 2014
Page: 183 of 199



PEAK POWER SPECTRAL DENSITY

Variant: 802.11n HT-20, Channel: 5180.00 MHz, SUM, Temp: Ambient, Voltage: 55 Vdc

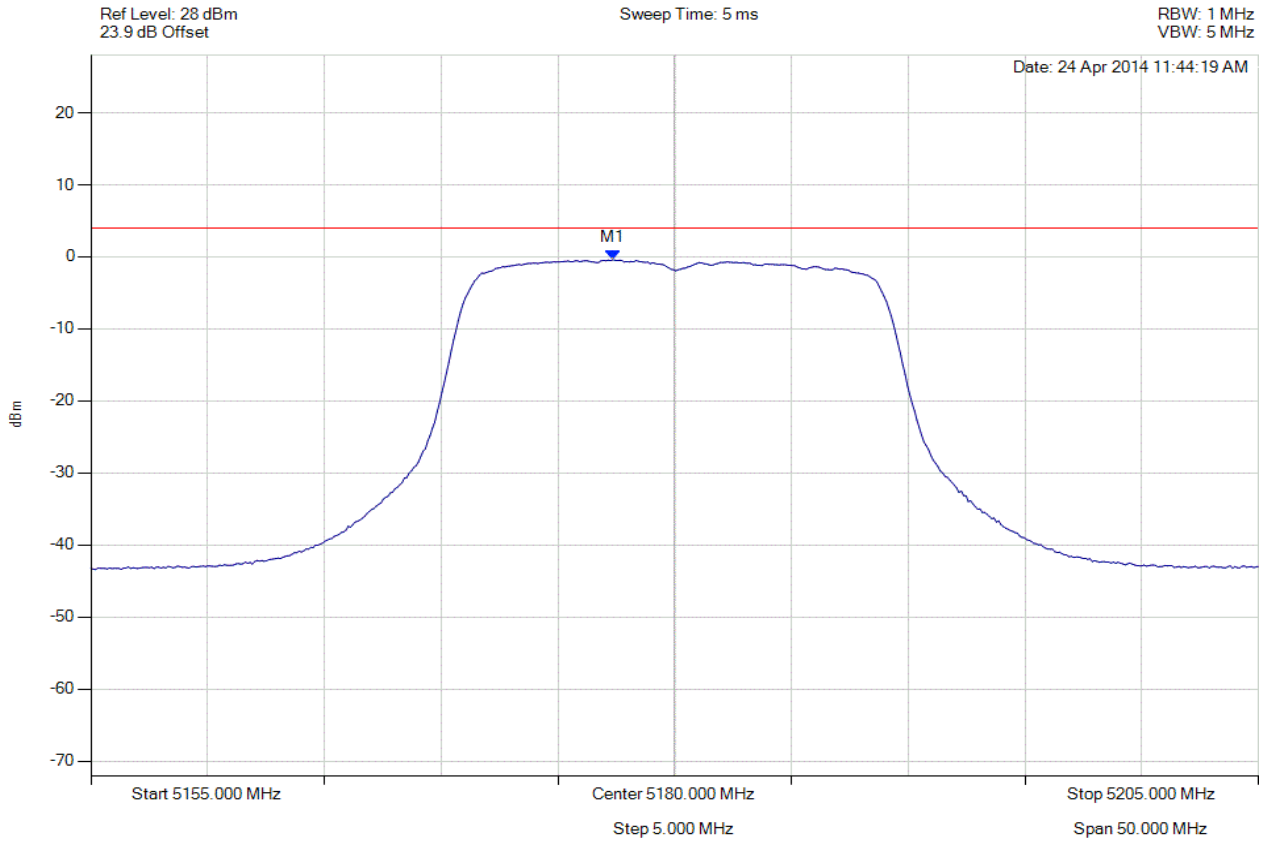

Analyser Setup	Marker : Frequency : Amplitude	Test Results
Detector = RMS Sweep Count = 100 RF Atten (dB) = 20 Trace Mode = VIEW	M1 : 5177.345 MHz : -0.412 dBm	Limit: ≤ 4.0 dBm Margin: -4.4 dB

[Back to the Matrix](#)

This test report may be reproduced in full only. The document may only be updated by MiCOM Labs personnel. Any changes will be noted in the Document History section of the report.



Title: Xirrus Inc. XI-AC1300, XI-AC867 (non-DFS Bands)
To: FCC 47 CFR Part 15.407 & IC RSS-210
Serial #: XIRR04-U6 Rev A
Issue Date: 29th April 2014
Page: 184 of 199



PEAK POWER SPECTRAL DENSITY

Variant: 802.11n HT-20, Channel: 5200.00 MHz, Chain a, Temp: Ambient, Voltage: 55 Vdc

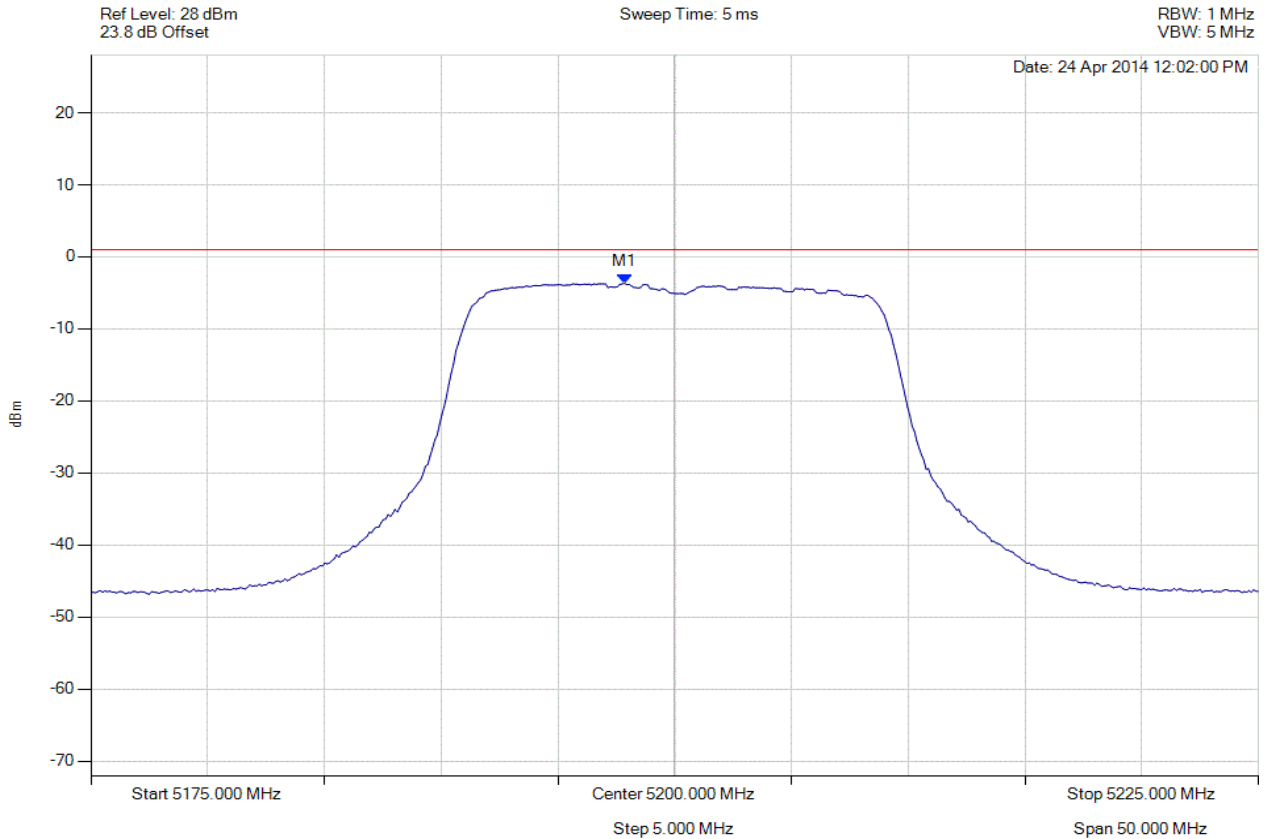

Analyser Setup	Marker : Frequency : Amplitude	Test Results
Detector = RMS Sweep Count = 100 RF Atten (dB) = 20 Trace Mode = VIEW	M1 : 5197.846 MHz : -3.682 dBm	Limit: ≤ 0.990 dBm Margin: 4.58 dB

[Back to the Matrix](#)

This test report may be reproduced in full only. The document may only be updated by MiCOM Labs personnel. Any changes will be noted in the Document History section of the report.



Title: Xirrus Inc. XI-AC1300, XI-AC867 (non-DFS Bands)
To: FCC 47 CFR Part 15.407 & IC RSS-210
Serial #: XIRR04-U6 Rev A
Issue Date: 29th April 2014
Page: 185 of 199



PEAK POWER SPECTRAL DENSITY

Variant: 802.11n HT-20, Channel: 5200.00 MHz, Chain b, Temp: Ambient, Voltage: 55 Vdc

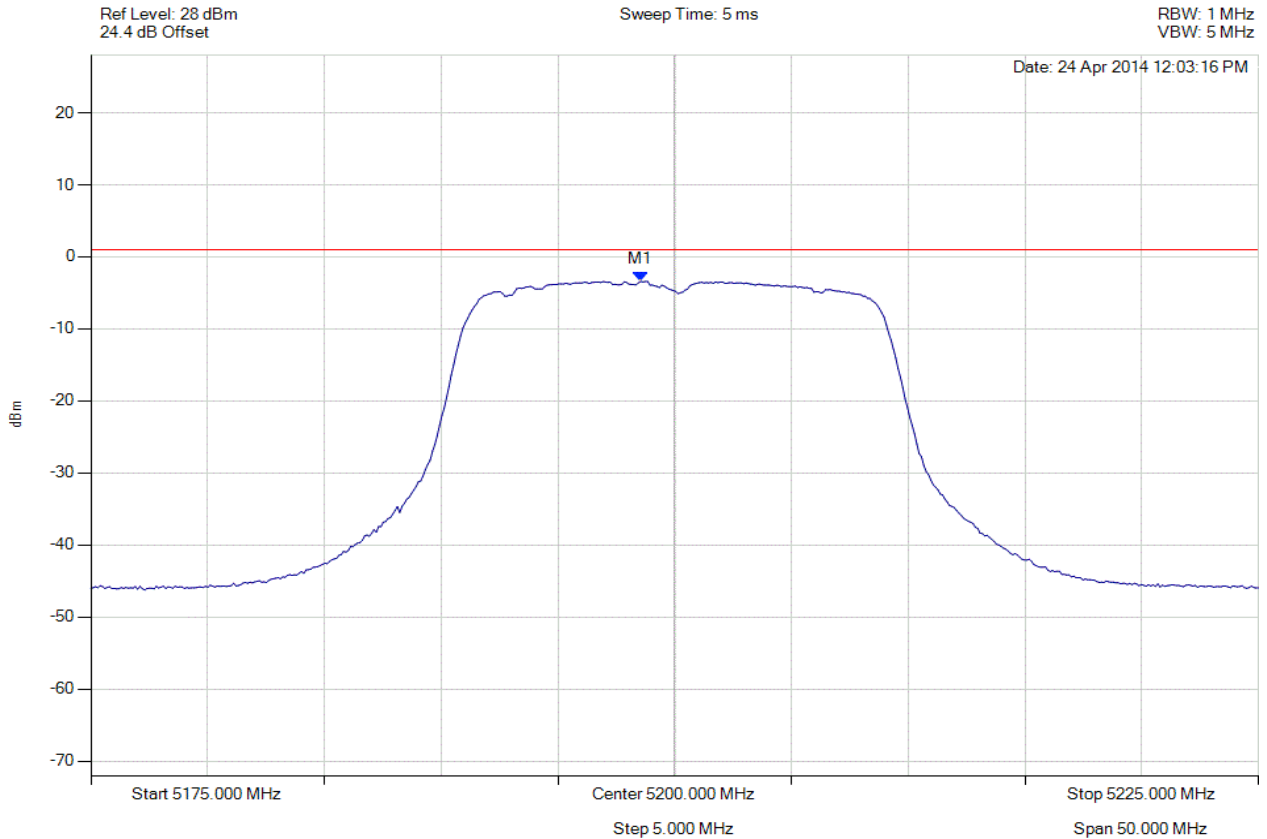

Analyser Setup	Marker : Frequency : Amplitude	Test Results
Detector = RMS Sweep Count = 100 RF Atten (dB) = 20 Trace Mode = VIEW	M1 : 5198.547 MHz : -3.419 dBm	Limit: ≤ 0.990 dBm Margin: 4.32 dB

[Back to the Matrix](#)

This test report may be reproduced in full only. The document may only be updated by MiCOM Labs personnel. Any changes will be noted in the Document History section of the report.



Title: Xirrus Inc. XI-AC1300, XI-AC867 (non-DFS Bands)
To: FCC 47 CFR Part 15.407 & IC RSS-210
Serial #: XIRR04-U6 Rev A
Issue Date: 29th April 2014
Page: 186 of 199



PEAK POWER SPECTRAL DENSITY

Variant: 802.11n HT-20, Channel: 5200.00 MHz, SUM, Temp: Ambient, Voltage: 55 Vdc

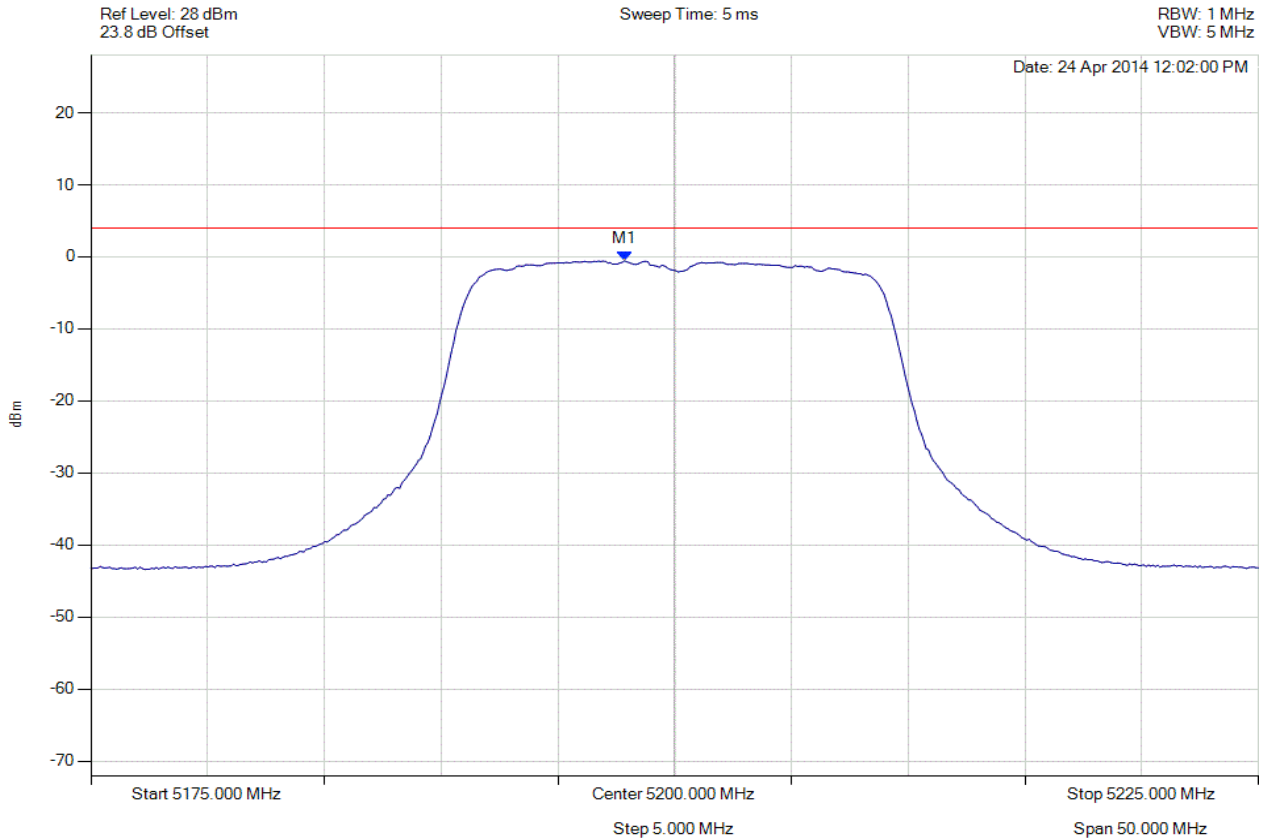

Analyser Setup	Marker : Frequency : Amplitude	Test Results
Detector = RMS Sweep Count = 100 RF Atten (dB) = 20 Trace Mode = VIEW	M1 : 5197.846 MHz : -0.566 dBm	Limit: ≤ 4.0 dBm Margin: -4.6 dB

[Back to the Matrix](#)

This test report may be reproduced in full only. The document may only be updated by MiCOM Labs personnel. Any changes will be noted in the Document History section of the report.



Title: Xirrus Inc. XI-AC1300, XI-AC867 (non-DFS Bands)
To: FCC 47 CFR Part 15.407 & IC RSS-210
Serial #: XIRR04-U6 Rev A
Issue Date: 29th April 2014
Page: 187 of 199



PEAK POWER SPECTRAL DENSITY

Variant: 802.11n HT-20, Channel: 5240.00 MHz, Chain a, Temp: Ambient, Voltage: 55 Vdc

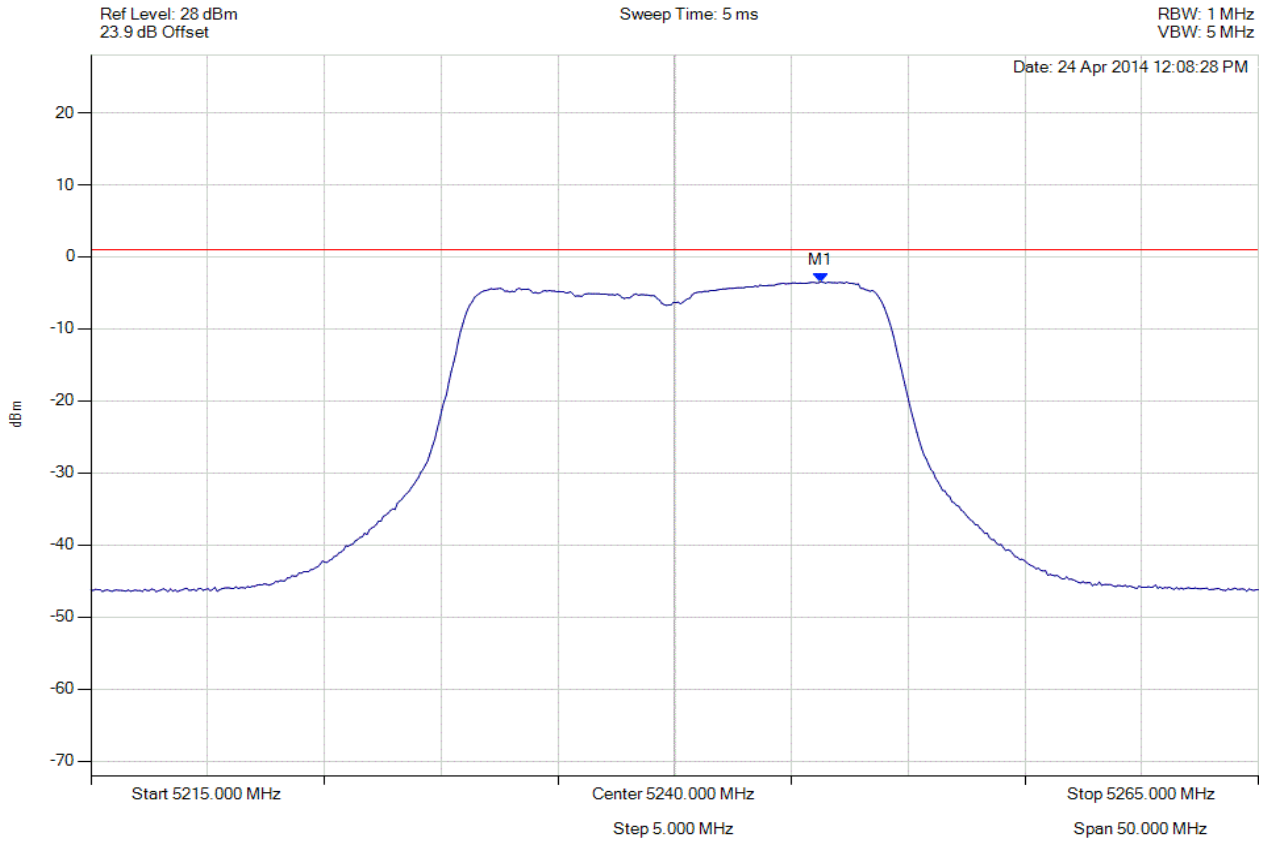

Analyser Setup	Marker : Frequency : Amplitude	Test Results
Detector = RMS Sweep Count = 100 RF Atten (dB) = 20 Trace Mode = VIEW	M1 : 5246.263 MHz : -3.464 dBm	Limit: ≤ 0.990 dBm Margin: 4.37 dB

[Back to the Matrix](#)

This test report may be reproduced in full only. The document may only be updated by MiCOM Labs personnel. Any changes will be noted in the Document History section of the report.



Title: Xirrus Inc. XI-AC1300, XI-AC867 (non-DFS Bands)
To: FCC 47 CFR Part 15.407 & IC RSS-210
Serial #: XIRR04-U6 Rev A
Issue Date: 29th April 2014
Page: 188 of 199



PEAK POWER SPECTRAL DENSITY

Variant: 802.11n HT-20, Channel: 5240.00 MHz, Chain b, Temp: Ambient, Voltage: 55 Vdc

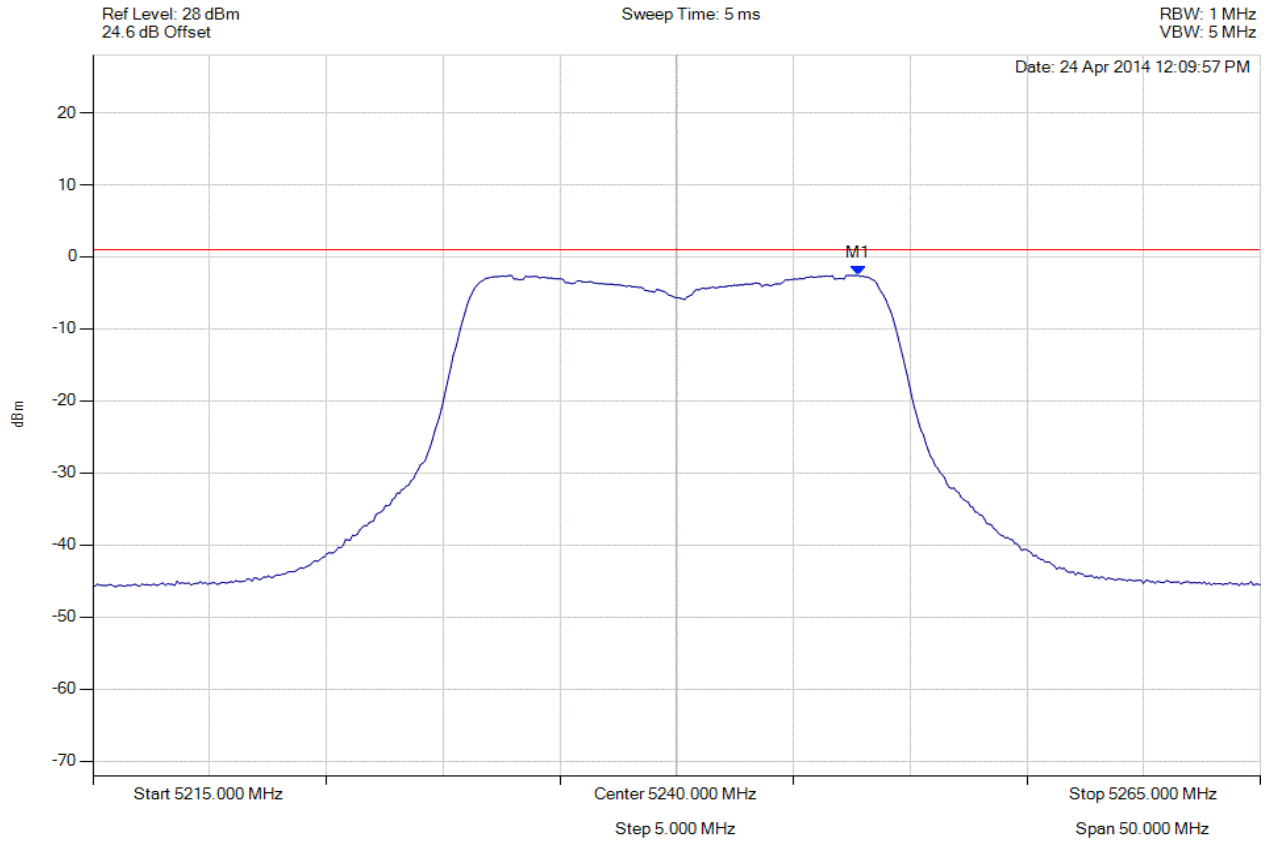

Analyser Setup	Marker : Frequency : Amplitude	Test Results
Detector = RMS Sweep Count = 100 RF Atten (dB) = 20 Trace Mode = VIEW	M1 : 5247.766 MHz : -2.565 dBm	Limit: ≤ 0.990 dBm Margin: 3.47 dB

[Back to the Matrix](#)

This test report may be reproduced in full only. The document may only be updated by MiCOM Labs personnel. Any changes will be noted in the Document History section of the report.



Title: Xirrus Inc. XI-AC1300, XI-AC867 (non-DFS Bands)
To: FCC 47 CFR Part 15.407 & IC RSS-210
Serial #: XIRR04-U6 Rev A
Issue Date: 29th April 2014
Page: 189 of 199



PEAK POWER SPECTRAL DENSITY

Variant: 802.11n HT-20, Channel: 5240.00 MHz, SUM, Temp: Ambient, Voltage: 55 Vdc

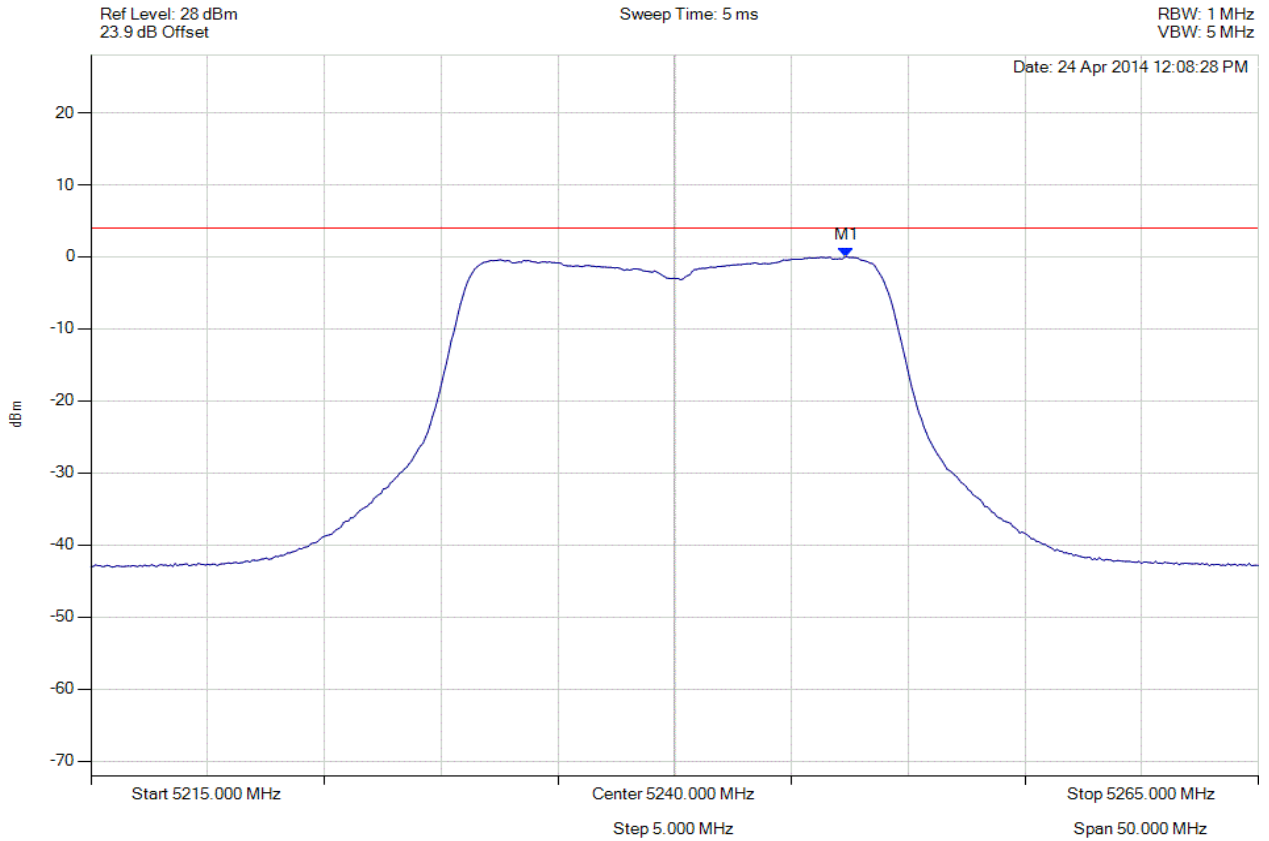

Analyser Setup	Marker : Frequency : Amplitude	Test Results
Detector = RMS Sweep Count = 100 RF Atten (dB) = 20 Trace Mode = VIEW	M1 : 5247.365 MHz : -0.001 dBm	Limit: ≤ 4.0 dBm Margin: -4.0 dB

[Back to the Matrix](#)

This test report may be reproduced in full only. The document may only be updated by MiCOM Labs personnel. Any changes will be noted in the Document History section of the report.



Title: Xirrus Inc. XI-AC1300, XI-AC867 (non-DFS Bands)
To: FCC 47 CFR Part 15.407 & IC RSS-210
Serial #: XIRR04-U6 Rev A
Issue Date: 29th April 2014
Page: 190 of 199



PEAK POWER SPECTRAL DENSITY

Variant: 802.11n HT-40, Channel: 5190.00 MHz, Chain a, Temp: Ambient, Voltage: 55 Vdc

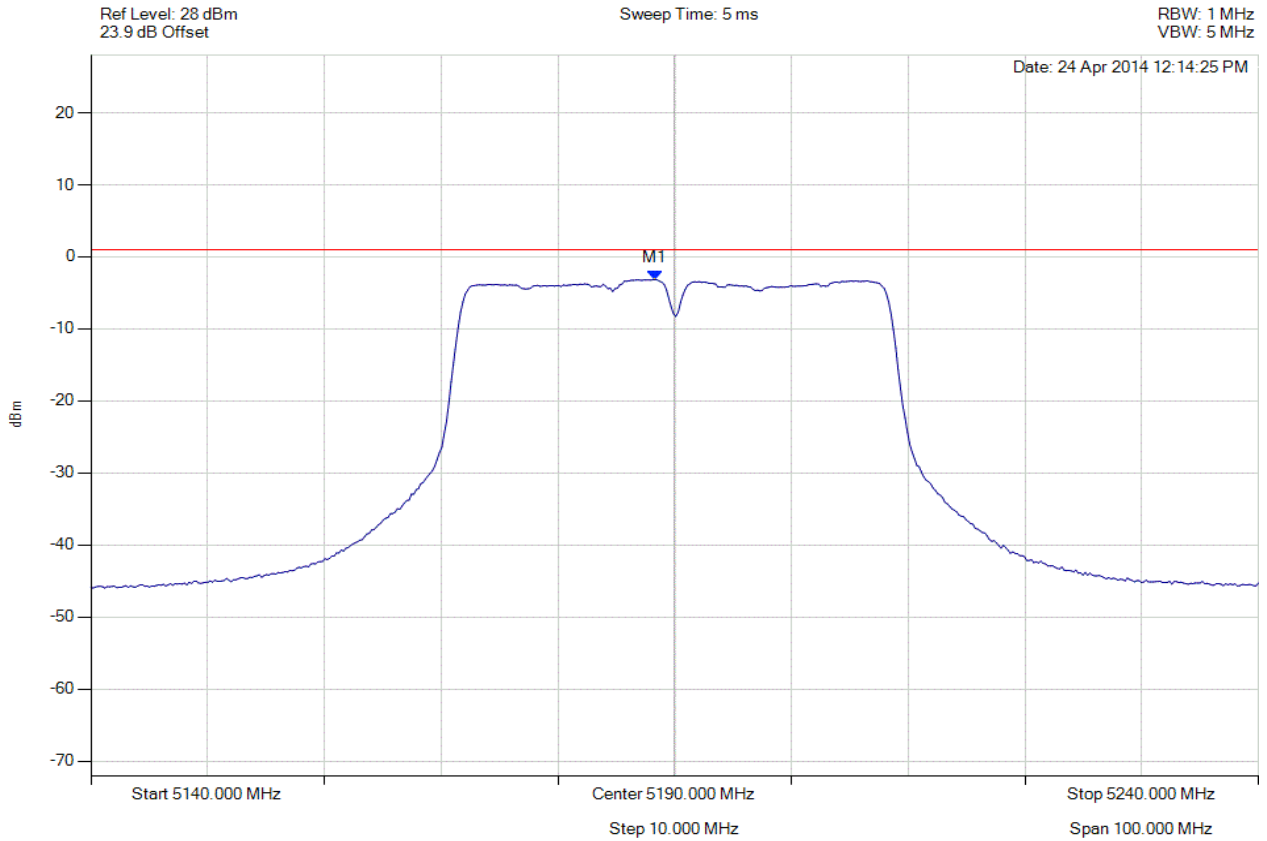

Analyser Setup	Marker : Frequency : Amplitude	Test Results
Detector = RMS Sweep Count = 100 RF Atten (dB) = 20 Trace Mode = VIEW	M1 : 5188.297 MHz : -3.155 dBm	Limit: ≤ 0.990 dBm Margin: 4.06 dB

[Back to the Matrix](#)

This test report may be reproduced in full only. The document may only be updated by MiCOM Labs personnel. Any changes will be noted in the Document History section of the report.



Title: Xirrus Inc. XI-AC1300, XI-AC867 (non-DFS Bands)
To: FCC 47 CFR Part 15.407 & IC RSS-210
Serial #: XIRR04-U6 Rev A
Issue Date: 29th April 2014
Page: 191 of 199



PEAK POWER SPECTRAL DENSITY

Variant: 802.11n HT-40, Channel: 5190.00 MHz, Chain b, Temp: Ambient, Voltage: 55 Vdc

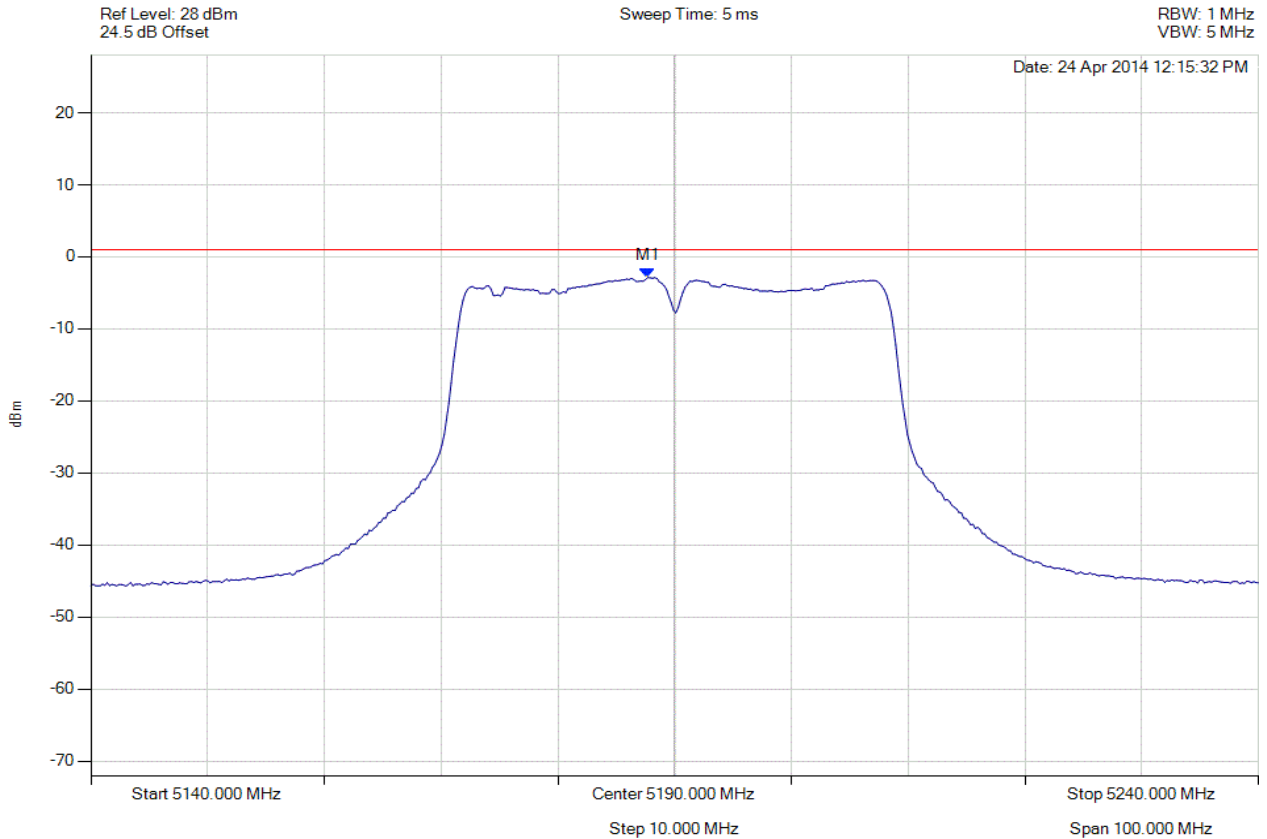

Analyser Setup	Marker : Frequency : Amplitude	Test Results
Detector = RMS Sweep Count = 100 RF Atten (dB) = 20 Trace Mode = VIEW	M1 : 5187.695 MHz : -2.885 dBm	Limit: ≤ 0.990 dBm Margin: 3.79 dB

[Back to the Matrix](#)

This test report may be reproduced in full only. The document may only be updated by MiCOM Labs personnel. Any changes will be noted in the Document History section of the report.



Title: Xirrus Inc. XI-AC1300, XI-AC867 (non-DFS Bands)
To: FCC 47 CFR Part 15.407 & IC RSS-210
Serial #: XIRR04-U6 Rev A
Issue Date: 29th April 2014
Page: 192 of 199



PEAK POWER SPECTRAL DENSITY

Variant: 802.11n HT-40, Channel: 5190.00 MHz, SUM, Temp: Ambient, Voltage: 55 Vdc

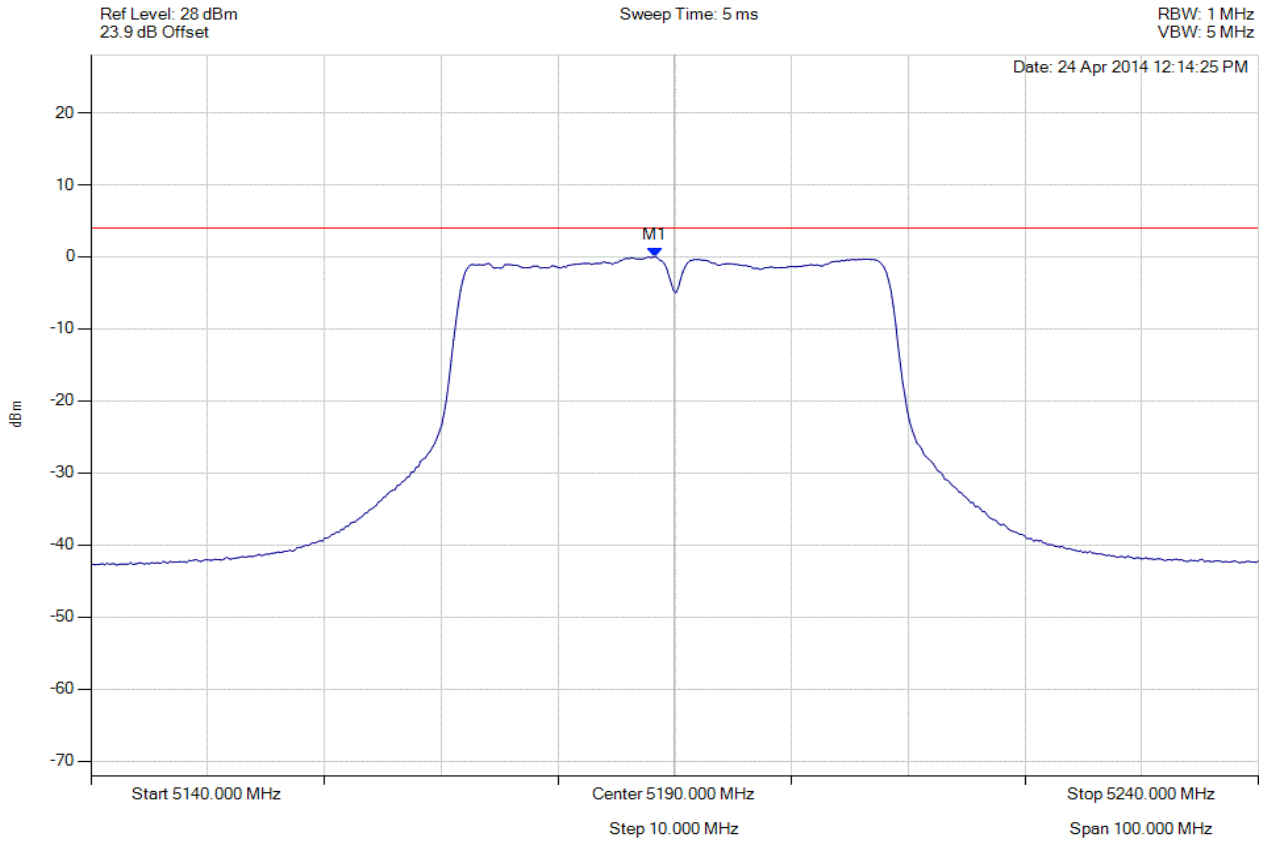

Analyser Setup	Marker : Frequency : Amplitude	Test Results
Detector = RMS Sweep Count = 100 RF Atten (dB) = 20 Trace Mode = VIEW	M1 : 5188.297 MHz : -0.009 dBm	Limit: ≤ 4.0 dBm Margin: -4.0 dB

[Back to the Matrix](#)

This test report may be reproduced in full only. The document may only be updated by MiCOM Labs personnel. Any changes will be noted in the Document History section of the report.



Title: Xirrus Inc. XI-AC1300, XI-AC867 (non-DFS Bands)
To: FCC 47 CFR Part 15.407 & IC RSS-210
Serial #: XIRR04-U6 Rev A
Issue Date: 29th April 2014
Page: 193 of 199



PEAK POWER SPECTRAL DENSITY

Variant: 802.11n HT-40, Channel: 5230.00 MHz, Chain a, Temp: Ambient, Voltage: 55 Vdc

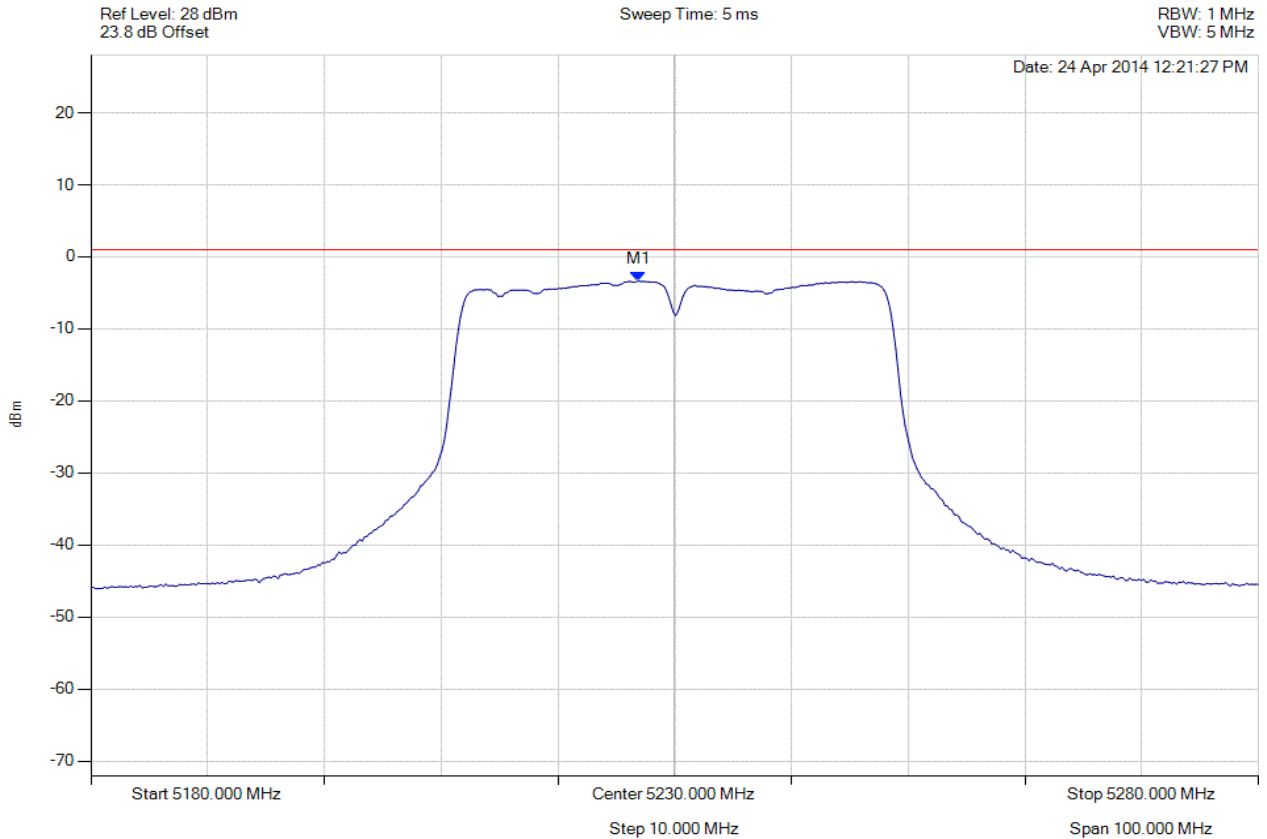

Analyser Setup	Marker : Frequency : Amplitude	Test Results
Detector = RMS Sweep Count = 100 RF Atten (dB) = 20 Trace Mode = VIEW	M1 : 5226.894 MHz : -3.349 dBm	Limit: ≤ 0.990 dBm Margin: 4.25 dB

[Back to the Matrix](#)

This test report may be reproduced in full only. The document may only be updated by MiCOM Labs personnel. Any changes will be noted in the Document History section of the report.



Title: Xirrus Inc. XI-AC1300, XI-AC867 (non-DFS Bands)
To: FCC 47 CFR Part 15.407 & IC RSS-210
Serial #: XIRR04-U6 Rev A
Issue Date: 29th April 2014
Page: 194 of 199



PEAK POWER SPECTRAL DENSITY

Variant: 802.11n HT-40, Channel: 5230.00 MHz, Chain b, Temp: Ambient, Voltage: 55 Vdc

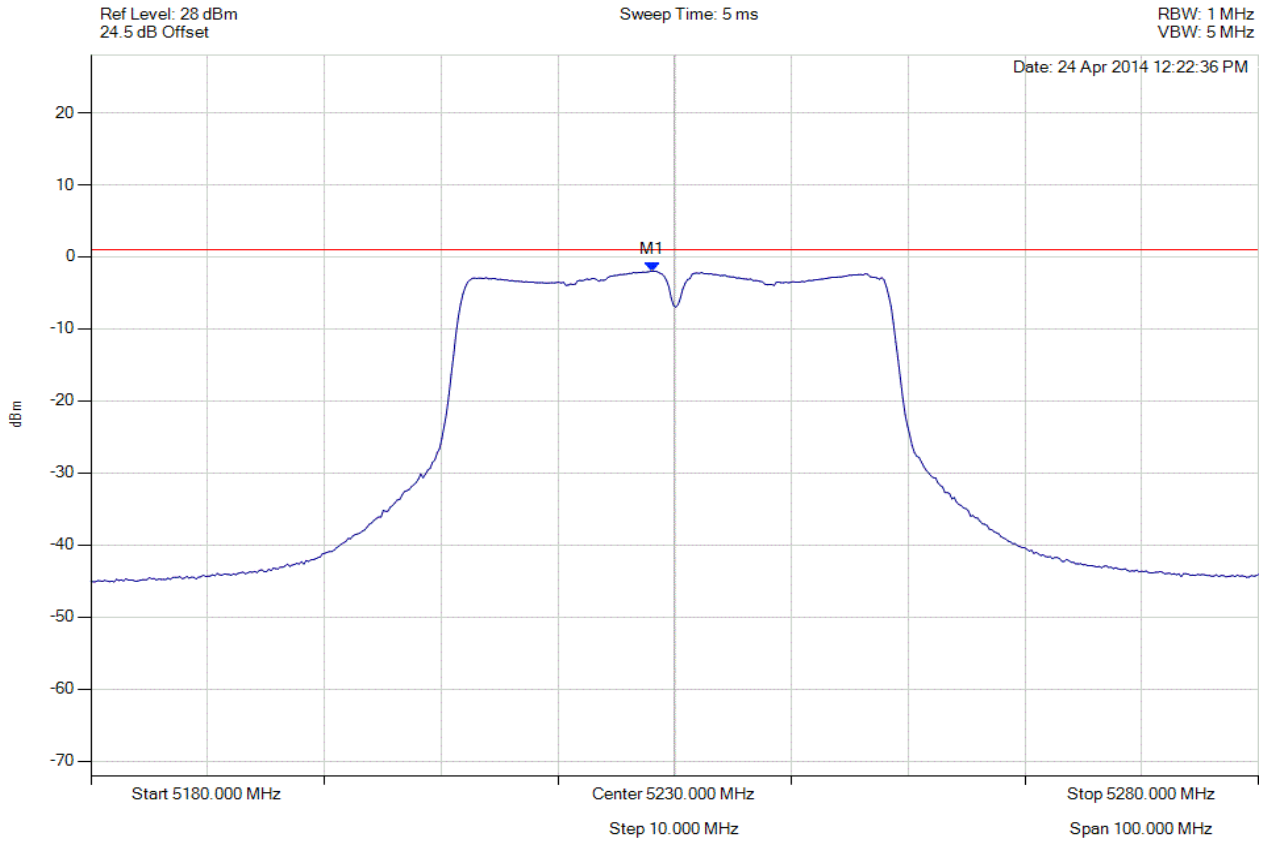

Analyser Setup	Marker : Frequency : Amplitude	Test Results
Detector = RMS Sweep Count = 100 RF Atten (dB) = 20 Trace Mode = VIEW	M1 : 5228.096 MHz : -1.993 dBm	Limit: ≤ 0.990 dBm Margin: 2.90 dB

[Back to the Matrix](#)

This test report may be reproduced in full only. The document may only be updated by MiCOM Labs personnel. Any changes will be noted in the Document History section of the report.



Title: Xirrus Inc. XI-AC1300, XI-AC867 (non-DFS Bands)
To: FCC 47 CFR Part 15.407 & IC RSS-210
Serial #: XIRR04-U6 Rev A
Issue Date: 29th April 2014
Page: 195 of 199



PEAK POWER SPECTRAL DENSITY

Variant: 802.11n HT-40, Channel: 5230.00 MHz, SUM, Temp: Ambient, Voltage: 55 Vdc

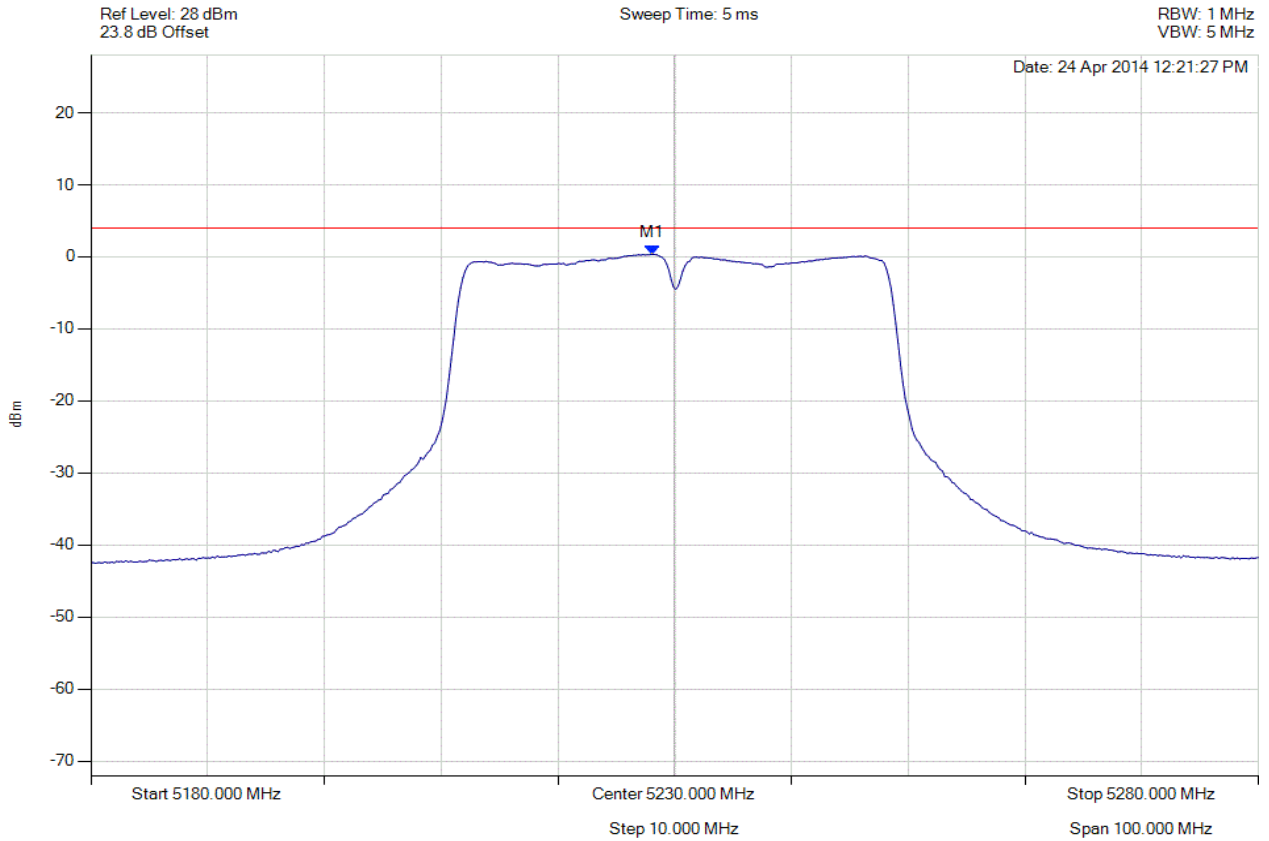

Analyser Setup	Marker : Frequency : Amplitude	Test Results
Detector = RMS Sweep Count = 100 RF Atten (dB) = 20 Trace Mode = VIEW	M1 : 5228.096 MHz : 0.336 dBm	Limit: ≤ 4.0 dBm Margin: -3.7 dB

[Back to the Matrix](#)

This test report may be reproduced in full only. The document may only be updated by MiCOM Labs personnel. Any changes will be noted in the Document History section of the report.



A.2.3. Peak Excursion Ratio



PEAK EXCURSION RATIO

Variant: 802.11a, Channel: 5180.00 MHz, Chain a, Temp: Ambient, Voltage: 55 Vdc

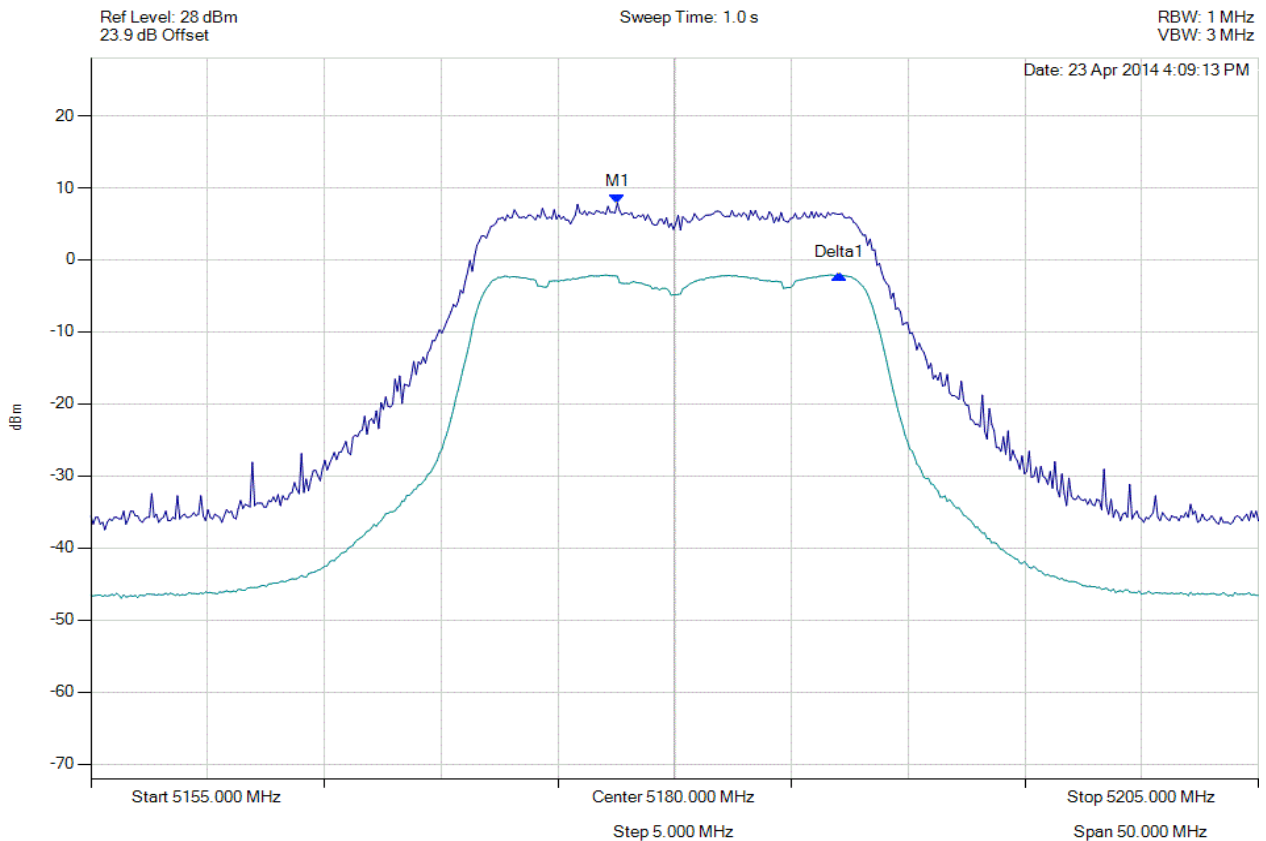

Analyser Setup	Marker : Frequency : Amplitude	Test Results
Sweep Count = 0 RF Atten (dB) = 20 TRACE 1: Detector = MAX PEAK Trace Mode = VIEW TRACE 2: Detector = RMS Trace Mode = VIEW	M1 : 5177.545 MHz : 7.862 dBm Delta1 : 9.519 MHz : -9.933 dB	Measured Excursion Ratio: 9.93 dB Limit: 13.0 dB Margin: -3.07 dB

[Back to the Matrix](#)

This test report may be reproduced in full only. The document may only be updated by MiCOM Labs personnel. Any changes will be noted in the Document History section of the report.



Title: Xirrus Inc. XI-AC1300, XI-AC867 (non-DFS Bands)
To: FCC 47 CFR Part 15.407 & IC RSS-210
Serial #: XIRR04-U6 Rev A
Issue Date: 29th April 2014
Page: 197 of 199



PEAK EXCURSION RATIO

Variant: 802.11n HT-20, Channel: 5180.00 MHz, Chain a, Temp: Ambient, Voltage: 55 Vdc

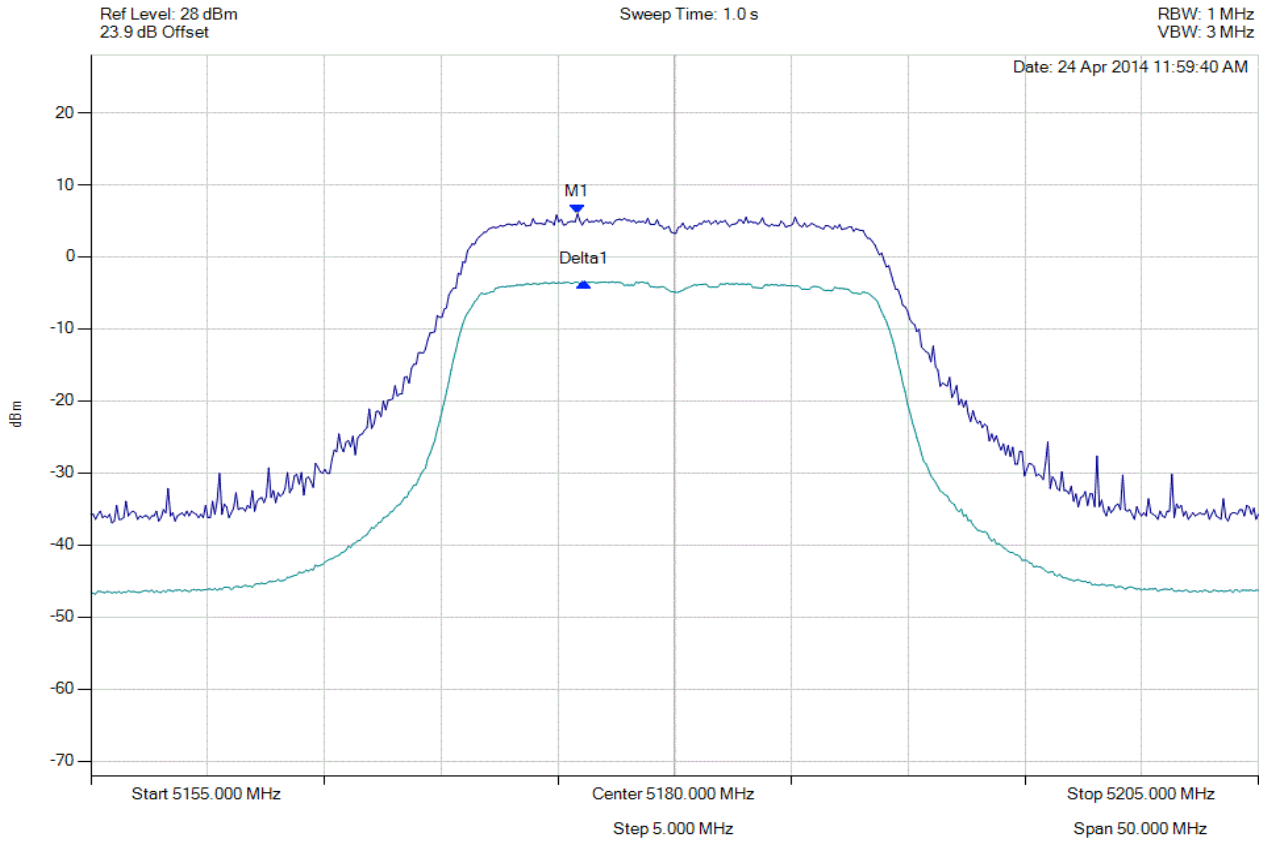

Analyser Setup	Marker : Frequency : Amplitude	Test Results
Sweep Count = 0 RF Atten (dB) = 20 TRACE 1: Detector = MAX PEAK Trace Mode = VIEW TRACE 2: Detector = RMS Trace Mode = VIEW	M1 : 5175.842 MHz : 5.972 dBm Delta1 : 301 KHz : -9.431 dB	Measured Excursion Ratio: 9.43 dB Limit: 13.0 dB Margin: -3.57 dB

[Back to the Matrix](#)

This test report may be reproduced in full only. The document may only be updated by MiCOM Labs personnel. Any changes will be noted in the Document History section of the report.



Title: Xirrus Inc. XI-AC1300, XI-AC867 (non-DFS Bands)
To: FCC 47 CFR Part 15.407 & IC RSS-210
Serial #: XIRR04-U6 Rev A
Issue Date: 29th April 2014
Page: 198 of 199



PEAK EXCURSION RATIO

Variant: 802.11n HT-40, Channel: 5190.00 MHz, Chain a, Temp: Ambient, Voltage: 55 Vdc

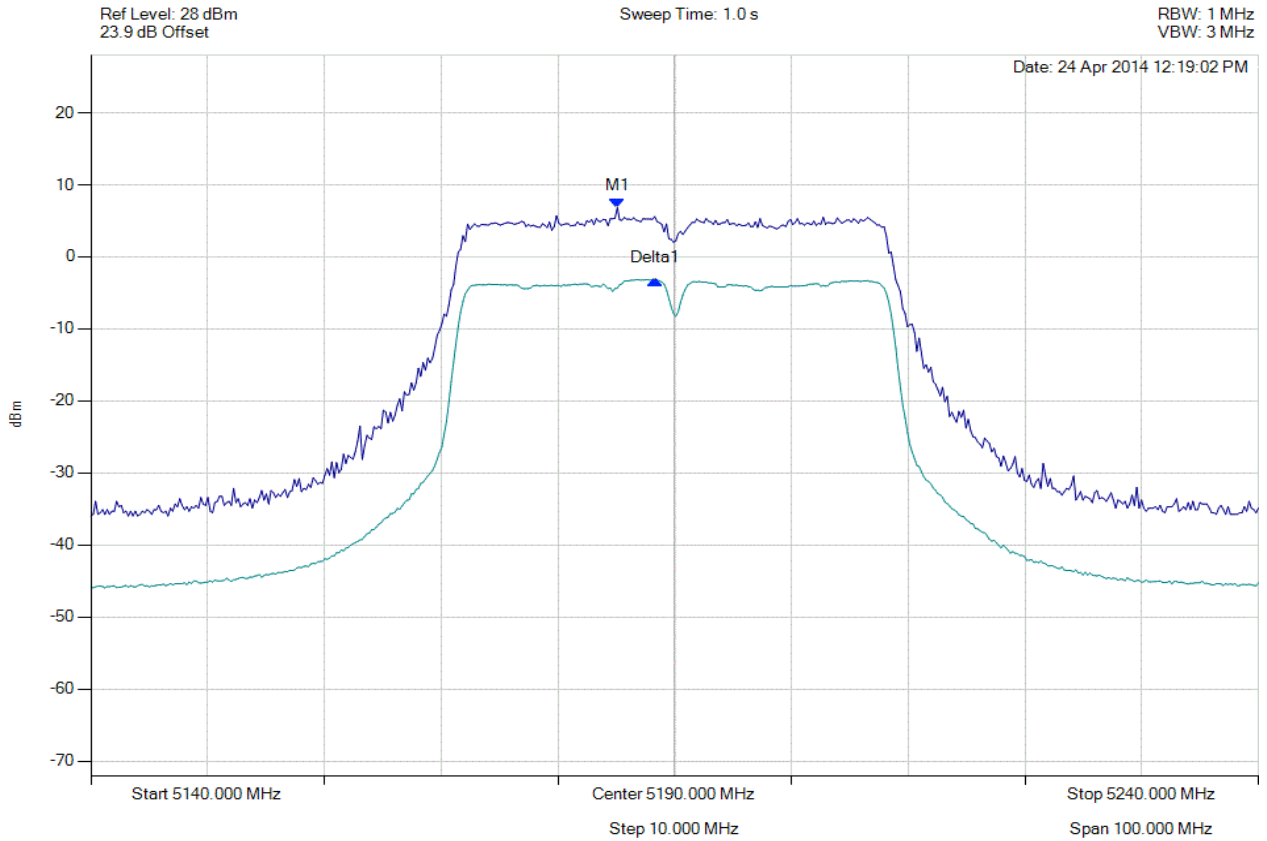

Analyser Setup	Marker : Frequency : Amplitude	Test Results
Sweep Count = 0 RF Atten (dB) = 20 TRACE 1: Detector = MAX PEAK Trace Mode = VIEW TRACE 2: Detector = RMS Trace Mode = VIEW	M1 : 5185.090 MHz : 6.813 dBm Delta1 : 3.206 MHz : -9.944 dB	Measured Excursion Ratio: 9.94 dB Limit: 13.0 dB Margin: -3.06 dB

[Back to the Matrix](#)

This test report may be reproduced in full only. The document may only be updated by MiCOM Labs personnel. Any changes will be noted in the Document History section of the report.



575 Boulder Court
Pleasanton, California 94566, USA
Tel: 1.925.462.0304
Fax: 1.925.462.0306
www.micomlabs.com