

Test of Xirrus Inc. XI-AC1300, XI-AC867

To: FCC 47 CFR Part 15.247 & IC RSS-210

Test Report Serial No.: XIRR04-U3 Rev A



This report has measurement results for two separate RF modules XI-AC1300 and XI-AC867. The results have been compiled into a single report for referencing purposes, see Section 2.2 Scope of Test Program;

3x3 FCC ID: SK6-XI-AC1300

2x2 FCC ID: SK6-XI-AC867

TEST REPORT

FROM



Test of Xirrus Inc. XI-AC1300, XI-AC867

to

To FCC 47 CFR Part 15.247 & IC RSS-210

Test Report Serial No.: XIRR04-U3 Rev A

Note: this report contains data with regard to the 2400 to 2483.5 MHz and 5725 to 5850 MHz operational modes of the Xirrus XI-AC1300 Wireless Access Point. Test data for the 5,150 - 5,250 (non-DFS bands) is reported in MiCOM Labs test report XIRR-U6

This report supersedes: NONE

Applicant: Xirrus Inc.
2101 Corporate Center Drive
Thousand Oaks
California 91320, USA

Product Function: 802.11a/b/g/n/ac Wireless
Access Point

Copy No: pdf Issue Date: 29th April 2014

This Test Report is Issued Under the Authority of:

MiCOM Labs, Inc.
440 Boulder Court, Suite 200
Pleasanton, CA 94566 USA
Phone: +1 (925) 462-0304
Fax: +1 (925) 462-0306
www.micomlabs.com



TESTING CERT #2381.01

MiCOM Labs is an ISO 17025 Accredited Testing Laboratory



Title: Xirrus Inc. XI-AC1300, XI-AC867
To: FCC 47 CFR Part 15.247 & IC RSS-210
Serial #: XIRR04-U3 Rev A
Issue Date: 29th April 2014
Page: 3 of 572

This page has been left intentionally blank



TABLE OF CONTENTS

ACCREDITATION, LISTINGS & RECOGNITION	5
TESTING ACCREDITATION	5
RECOGNITION	6
PRODUCT CERTIFICATION	7
TEST RESULT CERTIFICATE	9
1. REFERENCES AND MEASUREMENT UNCERTAINTY	10
1.1. Normative References	10
1.2. Test and Uncertainty Procedures	11
2. PRODUCT DETAILS AND TEST CONFIGURATIONS	12
2.1. Technical Details	12
2.2. Scope of Test Program	13
2.3. Equipment Model(s) and Serial Number(s)	18
2.4. Antenna Details	18
2.5. Cabling and I/O Ports	18
2.6. Test Configurations	19
2.7. Equipment Modifications	21
2.8. Deviations from the Test Standard	21
3. TEST EQUIPMENT CONFIGURATION(S)	22
3.1. Conducted RF Emission Test Set-up	22
3.2. Radiated Spurious Emission Test Set-up > 1 GHz	23
3.3. Digital Emissions Test Set-up (0.03 – 1 GHz)	24
3.4. ac Wireline Emission Test Set-up	25
4. TEST SUMMARY	26
5. TEST RESULTS	28
5.1. Device Characteristics	28
5.1.1. <i>Conducted Testing</i>	28
5.1.2. <i>Radiated Emission Testing</i>	101
5.1.3. <i>AC Wireline Conducted Emissions (150 kHz – 30 MHz)</i>	128
6. PHOTOGRAPHS	131
6.1. Conducted Test Setup	131
6.2. Test Setup - Digital Emissions below 1 GHz	132
6.3. Radiated Emissions Test Setup >1 GHz	133
7. TEST EQUIPMENT	134
APPENDIX	135
A. SUPPORTING INFORMATION	135
A.1. 3x3 CONDUCTED TEST PLOTS	135
A.1.1. <i>6 dB & 99% Bandwidth</i>	136
A.1.2. <i>Power Spectral Density</i>	205
A.1.3. <i>Conducted Spurious Emissions</i>	274
A.2. 2x2 CONDUCTED TEST PLOTS	397
A.2.1. <i>6 dB & 99% Bandwidth</i>	398
A.2.2. <i>Power Spectral Density</i>	440
A.2.3. <i>Conducted Spurious Emissions</i>	501

This test report may be reproduced in full only. The document may only be updated by MiCOM Labs personnel. Any changes will be noted in the Document History section of the report.



Title: Xirrus Inc. XI-AC1300, XI-AC867
To: FCC 47 CFR Part 15.247 & IC RSS-210
Serial #: XIRR04-U3 Rev A
Issue Date: 29th April 2014
Page: 5 of 572

ACCREDITATION, LISTINGS & RECOGNITION

TESTING ACCREDITATION

MiCOM Labs, Inc. is an accredited Electrical testing laboratory per the international standard EN ISO/IEC 17025. The company is accredited by the American Association for Laboratory Accreditation (A2LA) www.a2la.org test laboratory number 2381.01. MiCOM Labs test schedule is available at the following URL; <http://www.a2la.org/scopepdf/2381-01.pdf>



American Association for Laboratory Accreditation

Accredited Laboratory

A2LA has accredited

MICOM LABS

Pleasanton, CA

for technical competence in the field of

Electrical Testing

This laboratory is accredited in accordance with the recognized International Standard ISO/IEC 17025:2005 *General Requirements for the Competence of Testing and Calibration Laboratories*. This accreditation demonstrates technical competence for a defined scope and the operation of a laboratory quality management system (refer to joint ISO-ILAC-IAP Communiqué dated 8 January 2009).

Presented this 28th day of February 2014.

President & CEO
For the Accreditation Council
Certificate Number 2381.01
Valid to November 30, 2015



For the tests or types of tests to which this accreditation applies, please refer to the laboratory's Electrical Scope of Accreditation.

This test report may be reproduced in full only. The document may only be updated by MiCOM Labs personnel. Any changes will be noted in the Document History section of the report.



RECOGNITION

MiCOM Labs, Inc has widely recognized Electrical testing capabilities. Our international recognition includes Conformity Assessment Body designation by APEC MRA** countries. Our test reports are widely accepted for global type approvals.

Country	Recognition Body	Status	Phase	Identification No.
USA	Federal Communications Commission (FCC)	TCB	-	US0159 Listing #: 102167
Canada	Industry Canada (IC)	FCB	APEC MRA 2	US0159 Listing #: 4143A-2
Japan	MIC (Ministry of Internal Affairs and Communication)	CAB	APEC MRA 2	RCB 210
	VCCI	--	--	A-0012
Europe	European Commission	NB	EU MRA	NB 2280
Australia	Australian Communications and Media Authority (ACMA)	CAB	APEC MRA 1	US0159
Hong Kong	Office of the Telecommunication Authority (OFTA)	CAB	APEC MRA 1	
Korea	Ministry of Information and Communication Radio Research Laboratory (RRL)	CAB	APEC MRA 1	
Singapore	Infocomm Development Authority (IDA)	CAB	APEC MRA 1	
Taiwan	National Communications Commission (NCC) Bureau of Standards, Metrology and Inspection (BSMI)	CAB	APEC MRA 1	
Vietnam	Ministry of Communication (MIC)	CAB	APEC MRA 1	

**APEC MRA – Asia Pacific Economic Community Mutual Recognition Agreement.

Is a recognition agreement under which test lab is accredited to regulatory standards of the APEC member countries.

Phase I - recognition for product testing

Phase II – recognition for both product testing and certification

N/A – Not Applicable

**EU MRA – European Union Mutual Recognition Agreement.

Is a recognition agreement under which test lab is accredited to regulatory standards of the EU member countries.

**NB – Notified Body

This test report may be reproduced in full only. The document may only be updated by MiCOM Labs personnel. Any changes will be noted in the Document History section of the report.



Title: Xirrus Inc. XI-AC1300, XI-AC867
To: FCC 47 CFR Part 15.247 & IC RSS-210
Serial #: XIRR04-U3 Rev A
Issue Date: 29th April 2014
Page: 7 of 572

PRODUCT CERTIFICATION

MiCOM Labs, Inc. is an accredited Product Certification Body per the international standard EN ISO/IEC Guide 65. The company is accredited by the American Association for Laboratory Accreditation (A2LA) www.a2la.org test laboratory number 2381.02. MiCOM Labs test schedule is available at the following URL; <http://www.a2la.org/scopepdf/2381-02.pdf>



American Association for Laboratory Accreditation

Accredited Product Certification Body

A2LA has accredited

MICOM LABS

Pleasanton, CA

for technical competence as a

Product Certification Body

This product certification body is accredited in accordance with the recognized International Standard ISO/IEC 17065:2012 - *Requirements for bodies certifying products, processes and services*. This accreditation demonstrates technical competence for a defined scope and the operation of a quality management system.

Presented this 28th day of February 2014.



President & CEO
For the Accreditation Council
Certificate Number 2381.02
Valid to November 30, 2015

For the product certification schemes to which this accreditation applies, please refer to the organization's Product Certification Scope of Accreditation

United States of America – Telecommunication Certification Body (TCB)

TCB Identifier – US0159

Industry Canada – Certification Body

CAB Identifier – US0159

Europe – Notified Body

Notified Body Identifier - 2280

Japan – Recognized Certification Body (RCB)

RCB Identifier - 210

This test report may be reproduced in full only. The document may only be updated by MiCOM Labs personnel. Any changes will be noted in the Document History section of the report.



Title: Xirrus Inc. XI-AC1300, XI-AC867
To: FCC 47 CFR Part 15.247 & IC RSS-210
Serial #: XIRR04-U3 Rev A
Issue Date: 29th April 2014
Page: 8 of 572

DOCUMENT HISTORY

Document History		
Revision	Date	Comments
Draft		
Rev A	29 th April 2014	Initial release.

This test report may be reproduced in full only. The document may only be updated by MiCOM Labs personnel. Any changes will be noted in the Document History section of the report.



Title: Xirrus Inc. XI-AC1300, XI-AC867
To: FCC 47 CFR Part 15.247 & IC RSS-210
Serial #: XIRR04-U3 Rev A
Issue Date: 29th April 2014
Page: 9 of 572

TEST RESULT CERTIFICATE

Manufacturer:	Xirrus Inc. 2101 Corporate Center Drive Thousand Oaks California 91320, USA	Tested By:	MiCOM Labs, Inc. 575 Boulder Court Pleasanton California, 94566, USA
EUT:	802.11a/b/g/n 802.11a/b/g/n/ac Wireless Access Point	Telephone:	+1 925 462 0304
Model:	XI-AC1300, XI-AC867	Fax:	+1 925 462 0306
S/N's:	145		
Test Date(s):	24th Oct '13 - 6th March 2014	Website:	www.micomlabs.com

STANDARD(S)	TEST RESULTS
FCC 47 CFR Part 15.247 & IC RSS-210	EQUIPMENT COMPLIES

MiCOM Labs, Inc. tested the equipment mentioned in accordance with the requirements set forth in the above standards. Test results indicate that the equipment tested is capable of demonstrating compliance with the requirements as documented within this report.

Notes:

1. This document reports conditions under which testing was conducted and the results of testing performed.
2. Details of test methods used have been recorded and kept on file by the laboratory.
3. Test results apply only to the item(s) tested.

Approved & Released for MiCOM Labs, Inc. by:



TESTING CERT #2381.01



Graeme Grieve
Quality Manager MiCOM Labs,

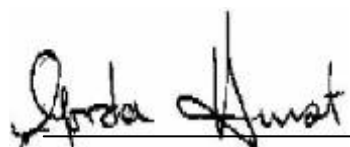

Gordon Hurst
President & CEO MiCOM Labs, Inc.

This test report may be reproduced in full only. The document may only be updated by MiCOM Labs personnel. Any changes will be noted in the Document History section of the report.

1. REFERENCES AND MEASUREMENT UNCERTAINTY

1.1. Normative References

REF.	PUBLICATION	YEAR	TITLE
i.	FCC 47 CFR Part 15, Subpart C	2010	Title 47: Telecommunication PART 15—RADIO FREQUENCY DEVICES Subpart C—Intentional Radiators
ii.	RSS-210 Annex 8	2010	Radio Standards Specification 210, Issue 8, Low-power License-exempt Radiocommunication Devices (All Frequency Bands): Category I Equipment
iii.	FCC OET KDB 662911	4 th April 2011	Emissions Testing of Transmitters with Multiple Outputs in the Same Band
iv.	DA 00-705	2000	FCC DA 00-705 "Filing and Measurement Guidelines for Frequency Hopping Spread Spectrum Systems" released March 30, 2000
v.	RSS-GEN	2010	Radio Standards Specification-Gen, Issue 3, General Requirements and Information for the Certification of Radiocommunication Equipment
vi.	FCC 47 CFR Part 15, Subpart B	2010	47 CFR Part 15, SubPart B; Unintentional Radiators
vii.	ICES-003	2004	Spectrum Management and Telecommunications Policy Interference-Causing Equipment Standard Digital Apparatus; Issue 4
viii.	ANSI C63.4	2009	American National Standards for Methods of Measurement of Radio-Noise Emissions from Low-Voltage Electrical and Electronic Equipment in the Range of 9 kHz to 40 GHz
ix.	CISPR 22/ EN 55022	2008 2006+A1:2007	Limits and Methods of Measurements of Radio Disturbance Characteristics of Information Technology Equipment
x.	M 3003	Edition 1 Dec. 1997	Expression of Uncertainty and Confidence in Measurements
xi.	LAB34	Edition 1 Aug 2002	The expression of uncertainty in EMC Testing
xii.	ETSI TR 100 028	2001	Parts 1 and 2 Electromagnetic compatibility and Radio Spectrum Matters (ERM); Uncertainties in the measurement of mobile radio equipment characteristics
xiii.	A2LA	July 2012	Reference to A2LA Accreditation Status – A2LA Advertising Policy

This test report may be reproduced in full only. The document may only be updated by MiCOM Labs personnel. Any changes will be noted in the Document History section of the report.



Title: Xirrus Inc. XI-AC1300, XI-AC867
To: FCC 47 CFR Part 15.247 & IC RSS-210
Serial #: XIRR04-U3 Rev A
Issue Date: 29th April 2014
Page: 11 of 572

1.2. Test and Uncertainty Procedures

Conducted and radiated emission measurements were conducted in accordance with American National Standards Institute ANSI C63.4, listed in the Normative References section of this report.

Measurement uncertainty figures are calculated in accordance with ETSI TR 100 028 Parts 1 and 2.

Measurement uncertainties stated are based on a standard uncertainty multiplied by a coverage factor $k = 2$, providing a level of confidence of approximately 95 % in accordance with UKAS document M 3003 listed in the Normative References section of this report.

This test report may be reproduced in full only. The document may only be updated by MiCOM Labs personnel. Any changes will be noted in the Document History section of the report.



Title: Xirrus Inc. XI-AC1300, XI-AC867
To: FCC 47 CFR Part 15.247 & IC RSS-210
Serial #: XIRR04-U3 Rev A
Issue Date: 29th April 2014
Page: 12 of 572

2. PRODUCT DETAILS AND TEST CONFIGURATIONS

2.1. Technical Details

Details	Description
Purpose:	Test of the Xirrus Inc. XI-AC1300, XI-AC867 to FCC Part 15.247 and Industry Canada RSS-210 regulations.
Applicant:	Xirrus Inc. 2101 Corporate Center Drive Thousand Oaks California 91320, USA
Manufacturer:	As applicant.
Laboratory performing the tests:	MiCOM Labs, Inc. 575 Boulder Court Pleasanton, California 94566 USA
Test report reference number:	XIRR04-U3 Rev A
Date EUT received:	24 th October 2013
Standard(s) applied:	FCC 47 CFR Part 15.247 & IC RSS-210
Dates of test (from - to):	24th Oct '13 - 6th March 2014
No of Units Tested:	One
Type of Equipment:	802.11a/b/g/n Wireless Access Point 2.4 GHz: 3x3, 5 GHz: 3x3 Spatial Multiplexing MIMO configuration
Manufacturers Trade Name:	Wireless Remote Access Point
Model(s):	XI-AC1300, XI-AC867
Location for use:	Indoor/Outdoor Use
Declared Frequency Range(s):	2400 - 2483.5 MHz; 5725 - 5850 MHz
Hardware Rev	Rev 2
Software Rev	6.7
Type of Modulation:	Per 802.11 –CCK, BPSK, QPSK, DSSS, OFDM
Declared Nominal Average Output Power:	802.11b/g/n/ac: +24 dBm 802.11a/n: +23 dBm 802.11ac: +22 dBm
EUT Modes of Operation:	Legacy 802.11a/b/g/n/ac
Transmit/Receive Operation:	Time Division Duplex
Rated Input Voltage and Current:	POE 56 Vdc
Operating Temperature Range:	Declared range 0° to +55°C.
ITU Emission Designator:	2400 – 2483.5 MHz 802.11b 13M0G1D 2400 – 2483.5 MHz 802.11g 22M0D1D 2400 – 2483.5 MHz 802.11n – HT-20 22M2D1D 2400 – 2483.5 MHz 802.11n – HT-40 36M9D1D 5725 – 5850 MHz 802.11a 16M9D1D 5725 – 5850 MHz 802.11n – HT-20 17M9D1D 5725 – 5850 MHz 802.11n – HT-40 36M4D1D 5725 – 5850 MHz 802.11n ac-20 36M4D1D 5725 – 5850 MHz 802.ac-80 76M3D1D
Equipment Dimensions:	114 mm (L) x 75 mm (W) x 55 mm (H)
Weight:	42 grams
Primary function of equipment:	Wireless Access Point for transmitting data and voice.

This test report may be reproduced in full only. The document may only be updated by MiCOM Labs personnel. Any changes will be noted in the Document History section of the report.



Title: Xirrus Inc. XI-AC1300, XI-AC867
To: FCC 47 CFR Part 15.247 & IC RSS-210
Serial #: XIRR04-U3 Rev A
Issue Date: 29th April 2014
Page: 13 of 572

2.2. Scope of Test Program

Xirrus Inc. Wireless Access Point

The scope of the test program was to test the Xirrus Inc. XI-AC1300, XI-AC867, 3x3 and 2x2 Spatial Multiplexing MIMO configurations in the frequency ranges 2400 - 2483.5 MHz and 5725 – 5850 MHz for compliance against FCC 47 CFR Part 15.247 and Industry Canada RSS-210 specifications.

The client requested that both the XI-AC1300 and XI-AC867 be treated as an SDR (Software Defined Radio)

2x2 Module: XI-AC867
3x3 Module: XI-AC1300

Module Differences

Client stated that the module differences between the 3x3 and 2x2 is that the 2x2 has the third antenna trace terminated with no access. As a result the test strategy determined full testing performed on the 3x3 module and limited testing on the 2x2. The output power on the 2x2 module was limited to approximately the same power that was observed on Ports a and b on the 3x3 module. This implies the maximum EIRP is less for the 2x2.

Multiple Antenna Configuration

The XI-1300 and XI-AC867 can have multiple wireless modules incorporated into a single host device. The client declared that at any given time only a single transmitter can be active at any given time. The device does operate 2.4 GHz and 5 GHz frequency bands simultaneously therefore colocation testing is considered.

FCC OET KDB Implementation

This test program implements the following FCC KDB – 662911 4/4/2011;

Emissions Testing of Transmitters with Multiple Outputs in the Same Band

The KDB document provides guidance for measurements of conducted output emissions of devices that employ a single transmitter with multiple outputs in the same band, with the outputs occupying the same or overlapping frequency ranges. It applies to EMC compliance measurements on devices that transmit on multiple antennas simultaneously in the same or overlapping frequency ranges through a coordinated process. Examples include, but are not limited to, devices employing beam forming or multiple-input and multiple-output (MIMO.) This guidance applies to both licensed and unlicensed devices wherever the FCC rules call for conducted output measurements. Guidance is provided for in-band, out-of-band and spurious emission measurements.

This guidance does not apply to the multiple transmitters included in a composite device, such as a device that combines an 802.11 modem with a cell phone in one enclosure with each driving its own antenna.

This test report may be reproduced in full only. The document may only be updated by MiCOM Labs personnel. Any changes will be noted in the Document History section of the report.

XIRR04 Wireless LAN Module

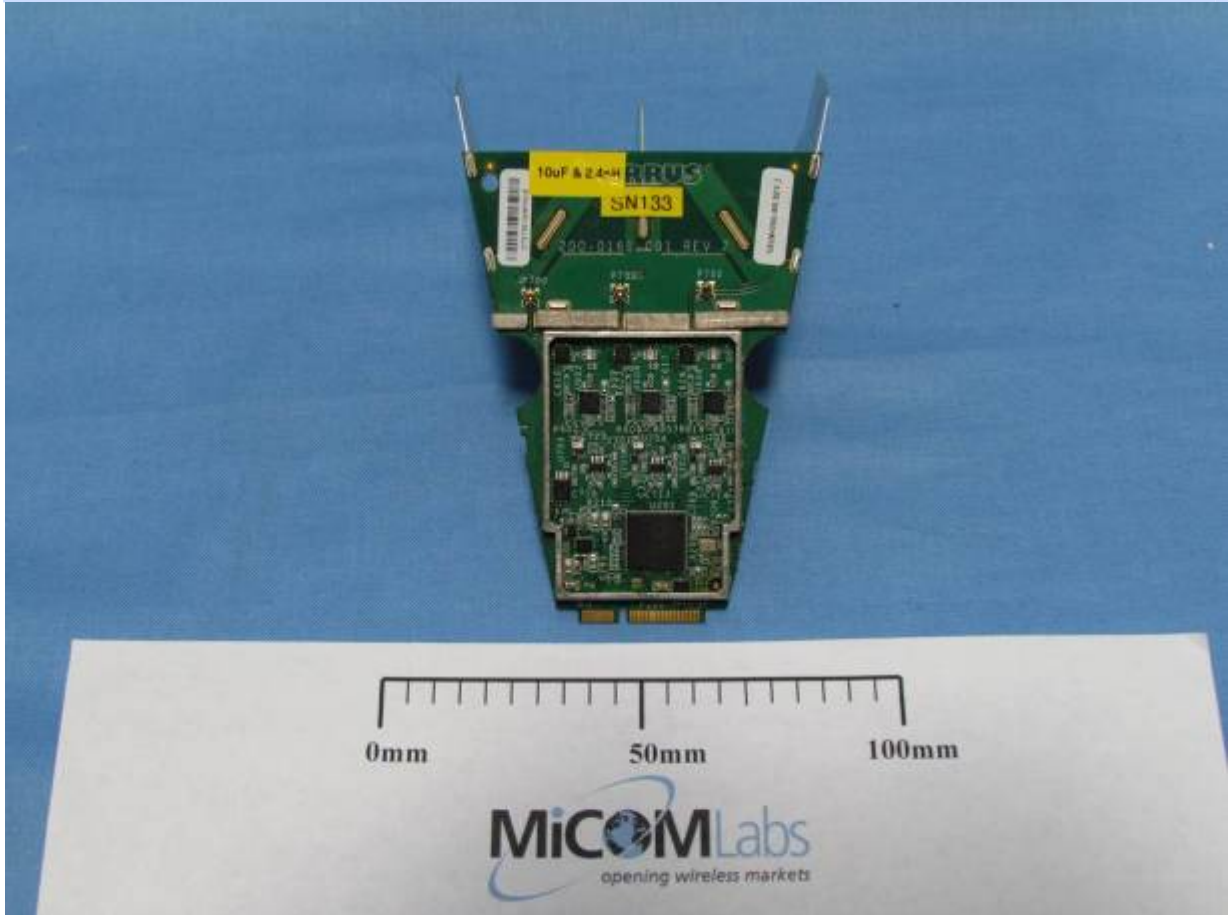

This test report may be reproduced in full only. The document may only be updated by MiCOM Labs personnel. Any changes will be noted in the Document History section of the report.

XIRR04 Wireless LAN Module

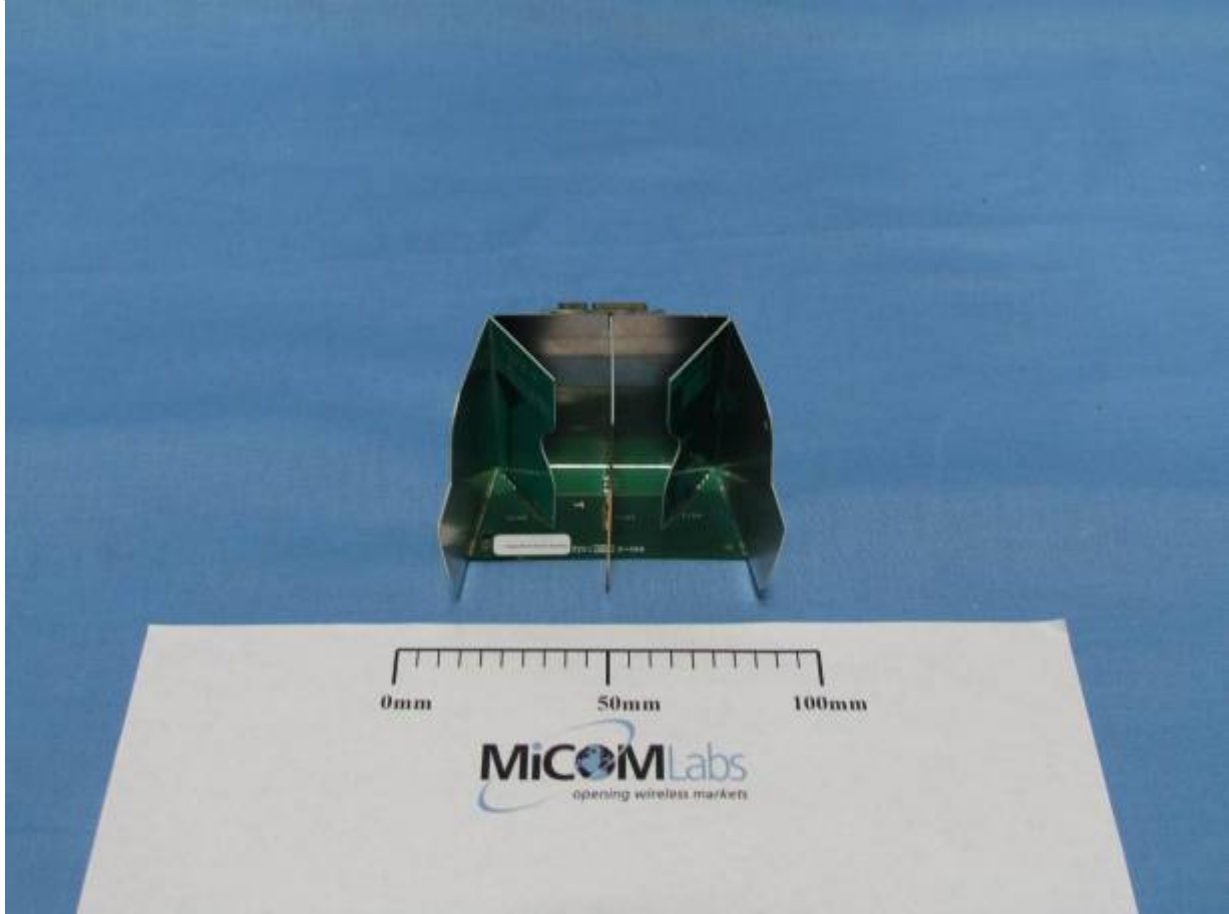

This test report may be reproduced in full only. The document may only be updated by MiCOM Labs personnel. Any changes will be noted in the Document History section of the report.

XIRR04 Wireless LAN Module

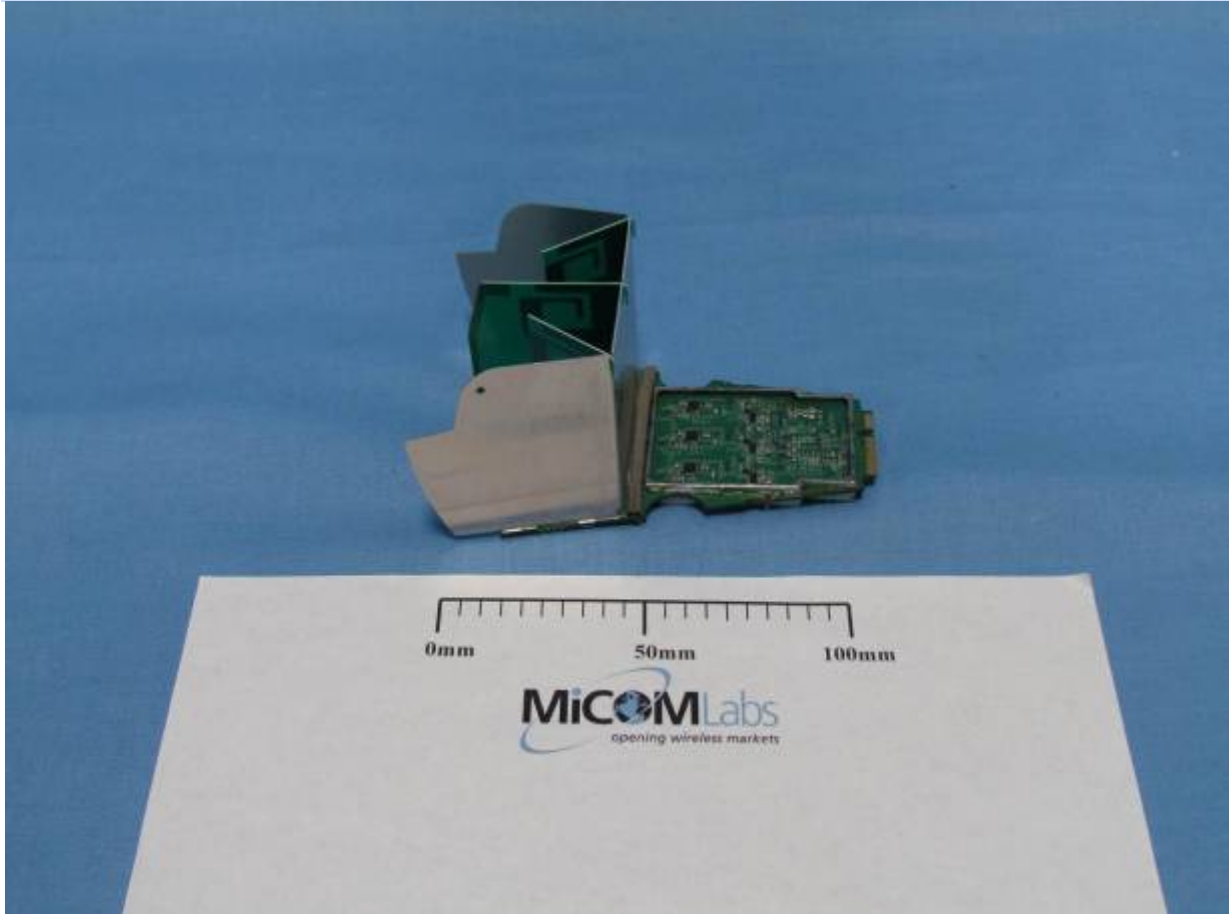

This test report may be reproduced in full only. The document may only be updated by MiCOM Labs personnel. Any changes will be noted in the Document History section of the report.



2.3. Equipment Model(s) and Serial Number(s)

Equipment Type	Equipment Description (Including Brand Name)	Mfr	Model No.	Serial No.
EUT	3x3 802.11a/b/g/n/ac WLAN	Xirrus	XI-AC1300	145
EUT	2x2 802.11a/b/g/n/ac WLAN	Xirrus	XI-AC867	145
Support	Single Port Injector (POE) Input: 100-240 Vac ~ 2.0A Output: 1). 56Vdc, 0.67A Output: 2). 56Vdc, 0.67A	Xirrus	XP1-MSI-75	None
Support	Laptop PC	IBM	Thinkpad	None

Note: Serial number is from the host device which was used to test both modules

2.4. Antenna Details

Model	Type	Gain (dBi)	Freq. Band (MHz)	Note
Integral	Omni Directional	3.0	2400 - 2500	
Integral	Omni Directional	5.0	5150 - 5850	

2.5. Cabling and I/O Ports

Number and type of I/O ports

Port Type	Port Description	Qty	Screened (Yes/ No)	Length
U.FI	RF port	3	NO	Not Applicable

This test report may be reproduced in full only. The document may only be updated by MiCOM Labs personnel. Any changes will be noted in the Document History section of the report.



2.6. Test Configurations

Testing was performed to determine the highest power level versus bit rate. The variant with the highest power was used to exercise the product.

Operational Mode(s) (802.11a/b/g/n)	Variant	Data Rate with Highest Power	Frequencies (MHz)
2.4 GHz			
b	Legacy	1 MBit/s	2,412
g	Legacy	6 MBit/s	2,437
n	HT-20	6.5 (MCS 0)	2,462
	HT-40	13.5 (MCS 0)	2,422 2,437 2,452
5.8 GHz			
a	Legacy	6 MBit/s	5,745 5,785
n	HT-20	6.5 (MCS 0)	5,825
	HT-40	13.5 (MCS 0)	5,755 5,795
ac	ac-80	29.3 MCS (0)	5,775

Legacy – data rates for 802.11abg products

Results for the above configurations are provided in this report



Antenna Test Configurations for Radiated Emissions

Results for the following configurations are provided in this report.

Radiated emissions testing was performed for three different antennas that represent the highest gain for each antenna type intended for use with the EUT;- Integral antenna (As used in APINR109) ; ANT-18 60 degree sector antenna; ANT-19 monopole antenna.

Radiated emissions testing was performed for all possible configurations for antenna ANT-18 which is the highest gain antenna used with the equipment. Radiated emissions testing was performed for the other two antennas in worst case mode (mode with the highest spectral density)

2,400 – 2483.5 MHz

5,725 – 5850 MHz

15.247	
802.11b	b SE 2412
	b SE 2437
	b SE 2462
	BE b 2390
	BE b 2483.5
802.11g	g SE 2412
	g SE 2437
	g SE 2462
	BE g 2390
	BE g 2483.5
802.11n HT-20	n HT-20 SE 2412
	n HT-20 SE 2437
	n HT-20 SE 2462
	BE n HT-20 2390
	BE n HT-20 2483.5
802.11n HT-40	n HT-40 SE 2422
	n HT-40 SE 2437
	n HT-40 SE 2452
	BE n HT-40 2390
	BE n HT-40 2483.5

15.247	
802.11a	a SE 5745
	a SE 5785
	a SE 5825
802.11n HT-20	n HT-20 SE 5745
	n HT-20 SE 5785
	n HT-20 SE 5825
802.11n HT-40	n HT-40 SE 5755
	n HT-40 SE 5795
802.11ac-80	ac-80 SE 5775

KEY;-

SE – Spurious Emission
BE – Band-Edge

This test report may be reproduced in full only. The document may only be updated by MiCOM Labs personnel. Any changes will be noted in the Document History section of the report.



Title: Xirrus Inc. XI-AC1300, XI-AC867
To: FCC 47 CFR Part 15.247 & IC RSS-210
Serial #: XIRR04-U3 Rev A
Issue Date: 29th April 2014
Page: 21 of 572

2.7. Equipment Modifications

The following modifications were required to bring the equipment into compliance:

1. NONE

2.8. Deviations from the Test Standard

The following deviations from the test standard were required in order to complete the test program:

1. NONE

This test report may be reproduced in full only. The document may only be updated by MiCOM Labs personnel. Any changes will be noted in the Document History section of the report.

3. TEST EQUIPMENT CONFIGURATION(S)

3.1. Conducted RF Emission Test Set-up

The following tests were performed using the conducted test set-up shown in the diagram below.

1. Section 6.1.1.1. 6 dB and 99% Bandwidth
2. Section 6.1.1.2. Peak Output Power
3. Section 6.1.1.3. Power Spectral Density
4. Section 6.1.1.4. Conducted Spurious Emissions

Conducted Test Set-Up Pictorial Representation

3 - Port Test Configuration

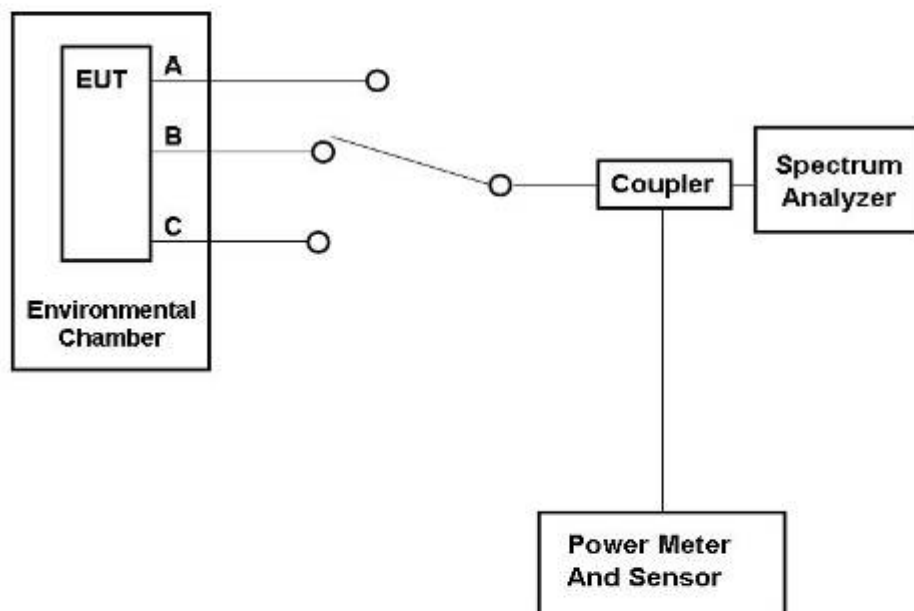

NOTE: 2.4 GHz operation had 2 antenna ports (2x2), 5.8 GHz operation had 3 antenna ports (3x3)

This test report may be reproduced in full only. The document may only be updated by MiCOM Labs personnel. Any changes will be noted in the Document History section of the report.

3.2. Radiated Spurious Emission Test Set-up > 1 GHz

The following tests were performed using the conducted test set-up shown in the diagram below.

Radiated Emission Measurement Setup – Above 1 GHz

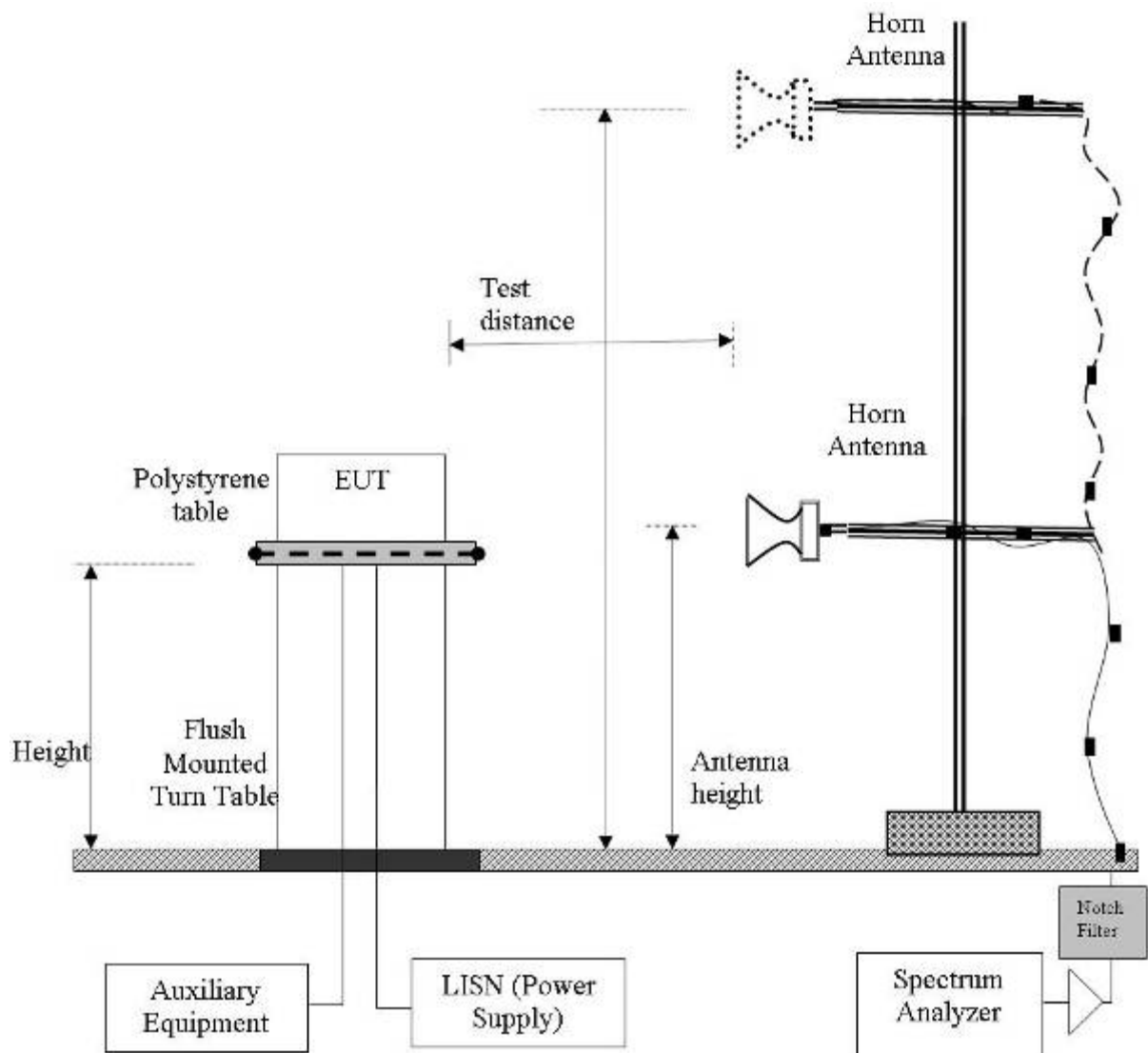

This test report may be reproduced in full only. The document may only be updated by MiCOM Labs personnel. Any changes will be noted in the Document History section of the report.

3.3. Digital Emissions Test Set-up (0.03 – 1 GHz)

The following tests were performed using the conducted test set-up shown in the diagram below.

Digital Emission Measurement Setup – Below 1 GHz

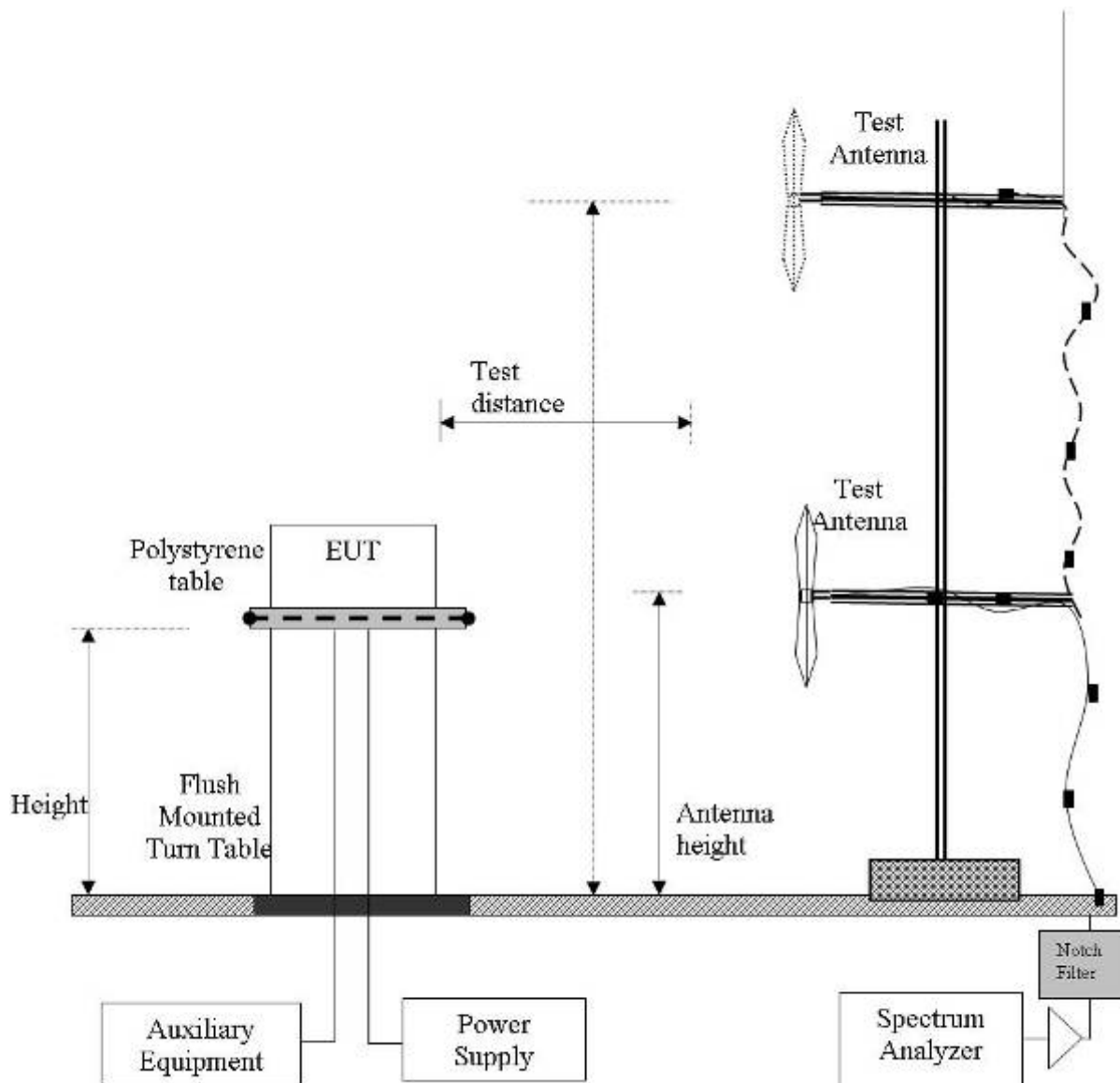

This test report may be reproduced in full only. The document may only be updated by MiCOM Labs personnel. Any changes will be noted in the Document History section of the report.

3.4. ac Wireline Emission Test Set-up

The following tests were performed using the conducted test set-up shown in the diagram below.

1. Section 5.1.3 ac Wireline Conducted Emissions

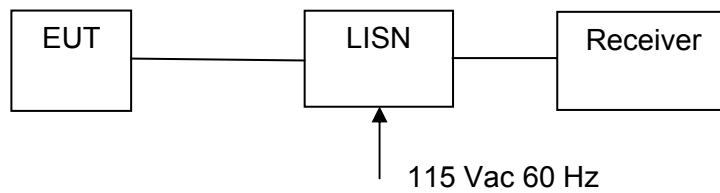

Conducted Test Set-Up Pictorial Representation



4. TEST SUMMARY

List of Measurements

The following table represents the list of measurements required under the **FCC CFR47 Part 15.247** and **Industry Canada RSS-210** and **Industry Canada RSS-Gen**.

Section(s)	Test Items	Description	Condition	Result	Test Report Section
15.247(a)(2) A8.2(1) 4.4	6 dB and 99 % Bandwidths	≥500 kHz	Conducted	Complies	5.1.1.1
15.247(b)(3) 15.31(e) A8.4(4)	Peak Output Power Voltage Variation	Shall not exceed 1W Variation of supply voltage 85 % -115 %	Conducted	Complies	5.1.1.2
15.247(e) A8.2	Peak Power Spectral Density	Shall not be greater than +8 dBm in any 3 kHz band	Conducted	Complies	5.1.1.3
15.247(d) 15.205 / 15.209 A8.5 2.2 4.7	Spurious Emissions (30MHz - 26 GHz b/g and 30 MHz – 40 GHz a)	The radiated emission in any 100 kHz of out- band shall be at least 20 dB below the highest in- band spectral density	Conducted	Complies	5.1.1.4

This test report may be reproduced in full only. The document may only be updated by MiCOM Labs personnel. Any changes will be noted in the Document History section of the report.



List of Measurements (continued)

The following table represents the list of measurements required under the **FCC CFR47 Part 15.247**, **Industry Canada RSS-210**, and **Industry Canada RSS-Gen**.

Section(s)	Test Items	Description	Condition	Result	Test Report Section
15.247(d) 15.205 / 15.209 A8.5 2.2 2.6 4.7	Radiated Emissions	Restricted Bands	Radiated	Complies	5.1.2
	Transmitter Radiated Spurious Emissions	Emissions above 1 GHz		Complies	
	Radiated Band Edge	Band-edge results Peak Emissions		Complies	
15.205 / 15.209 2.2	Radiated Spurious Emissions	Emissions <1 GHz (30M-1 GHz)	Radiated	Complies	5.1.2.4
15.207 7.2.2	AC Wireline Conducted Emissions 150 kHz– 30 MHz	Conducted Emissions	Conducted	Complies	5.1.3

Note 1: Test results reported in this document relate only to the items tested

Note 2: The required tests demonstrated compliance as per client declaration of test configuration, monitoring methodology and associated pass/fail criteria

Note 3: Section 3.7 Equipment Modifications highlights the equipment modifications that were required to bring the product into compliance with the above test matrix



Title: Xirrus Inc. XI-AC1300, XI-AC867
To: FCC 47 CFR Part 15.247 & IC RSS-210
Serial #: XIRR04-U3 Rev A
Issue Date: 29th April 2014
Page: 28 of 572

5. TEST RESULTS

5.1. Device Characteristics

5.1.1. Conducted Testing

5.1.1.1. 6 dB and 99 % Bandwidth

Conducted Test Conditions for 6 dB and 99% Bandwidth			
Standard:	FCC CFR 47:15.247	Ambient Temp. (°C):	24.0 - 27.5
Test Heading:	6 dB and 99 % Bandwidth	Rel. Humidity (%):	32 - 45
Standard Section(s):	15.247 (a)(2)	Pressure (mBars):	999 - 1001
Reference Document(s):	KDB 558074 - D01 DTS Measurement Guidance v01: Section 5.1 Emission Bandwidth		

Test Procedure for 6 dB and 99% Bandwidth Measurement
The bandwidth at 6 dB and 99 % was measured with a spectrum analyzer connected to the antenna terminal, while EUT is operating in transmission mode at the appropriate center frequency.

This test report may be reproduced in full only. The document may only be updated by MiCOM Labs personnel. Any changes will be noted in the Document History section of the report.



Title: Xirrus Inc. XI-AC1300, XI-AC867
To: FCC 47 CFR Part 15.247 & IC RSS-210
Serial #: XIRR04-U3 Rev A
Issue Date: 29th April 2014
Page: 29 of 572

XI-AC1300 3x3 Operation

Equipment Configuration for 6 dB & 99% Bandwidth

Variant:	3x3 802.11b	Duty Cycle (%):	99
Data Rate:	1 MBit/s	Antenna Gain (dBi):	Not Applicable
Modulation:	CCK	Beam Forming Gain (Y):	Not Applicable
TPC:	Not Applicable	Tested By:	GMH
Engineering Test Notes:	Test setup: 6" SMA pigtailed soldered onto the pcb. Loss of pigtail not considered		

Test Measurement Results

Test Frequency MHz	Measured 6 dB Bandwidth (MHz)				6 dB Bandwidth (MHz)		Limit KHz	Lowest Margin MHz
	Port(s)				Highest	Lowest		
	a	b	c	d				
2412.0	7.214	7.214	7.214		7.214	7.214	≥500.0	-6.71
2437.0	7.214	7.214	7.214		7.214	7.214	≥500.0	-6.71
2462.0	7.695	7.214	7.214		7.695	7.214	≥500.0	-6.71

Test Frequency MHz	Measured 99% Bandwidth (MHz)				Maximum 99% Bandwidth (MHz)		
	Port(s)						
	a	b	c	d			
2412.0	12.745	12.906	12.826		12.906		
2437.0	12.745	12.906	12.585		12.906		
2462.0	12.906	12.986	12.665		12.986		

Traceability to Industry Recognized Test Methodologies

Work Instruction:	WI-03 MEASURING RF SPECTRUM MASK
Measurement Uncertainty:	±2.81 dB

Note: click the links in the above matrix to view the graphical image (plot).

This test report may be reproduced in full only. The document may only be updated by MiCOM Labs personnel. Any changes will be noted in the Document History section of the report.



Title: Xirrus Inc. XI-AC1300, XI-AC867
To: FCC 47 CFR Part 15.247 & IC RSS-210
Serial #: XIRR04-U3 Rev A
Issue Date: 29th April 2014
Page: 30 of 572

Equipment Configuration for 6 dB & 99% Bandwidth

Variant:	3x3 802.11g	Duty Cycle (%):	95
Data Rate:	6 MBit/s	Antenna Gain (dBi):	Not Applicable
Modulation:	OFDM	Beam Forming Gain (Y):	Not Applicable
TPC:	Not Applicable	Tested By:	GMH
Engineering Test Notes:	Test setup: 6" SMA pigtailed soldered onto the pcb. Loss of pigtail not considered.		

Test Measurement Results

Test Frequency	Measured 6 dB Bandwidth (MHz)				6 dB Bandwidth (MHz)		Limit	Lowest Margin
	Port(s)				Highest	Lowest		
MHz	a	b	c	d			KHz	MHz
2412.0	16.513	16.513	16.513		16.513	16.513	≥500.0	-16.01
2437.0	16.513	16.513	16.513		16.513	16.513	≥500.0	-16.01
2462.0	16.513	16.513	16.513		16.513	16.513	≥500.0	-16.01

Test Frequency	Measured 99% Bandwidth (MHz)				Maximum 99% Bandwidth (MHz)		
	Port(s)						
MHz	a	b	c	d			
2412.0	16.593	16.593	16.593		16.593		
2437.0	21.964	21.964	20.922		21.964		
2462.0	16.834	16.914	16.673		16.914		

Traceability to Industry Recognized Test Methodologies	
Work Instruction:	WI-03 MEASURING RF SPECTRUM MASK
Measurement Uncertainty:	±2.81 dB

Note: click the links in the above matrix to view the graphical image (plot).

This test report may be reproduced in full only. The document may only be updated by MiCOM Labs personnel. Any changes will be noted in the Document History section of the report.



Title: Xirrus Inc. XI-AC1300, XI-AC867
To: FCC 47 CFR Part 15.247 & IC RSS-210
Serial #: XIRR04-U3 Rev A
Issue Date: 29th April 2014
Page: 31 of 572

Equipment Configuration for 6 dB & 99% Bandwidth

Variant:	3x3 802.11n HT-20	Duty Cycle (%):	94
Data Rate:	6.5 MBit/s	Antenna Gain (dBi):	Not Applicable
Modulation:	OFDM	Beam Forming Gain (Y):	Not Applicable
TPC:	Not Applicable	Tested By:	GMH
Engineering Test Notes:	Test setup: 6" SMA pigtailed soldered onto the pcb. Loss of pigtail not considered.		

Test Measurement Results

Test Frequency	Measured 6 dB Bandwidth (MHz)				6 dB Bandwidth (MHz)		Limit	Lowest Margin
	Port(s)				Highest	Lowest		
MHz	a	b	c	d			KHz	MHz
2412.0	17.475	17.715	17.475		17.715	17.475	≥500.0	-16.98
2437.0	17.715	17.475	17.715		17.715	17.475	≥500.0	-16.98
2462.0	17.475	17.475	17.715		17.715	17.475	≥500.0	-16.98

Test Frequency	Measured 99% Bandwidth (MHz)				Maximum 99% Bandwidth (MHz)		
	Port(s)						
MHz	a	b	c	d			
2412.0	17.715	17.796	17.715		17.796		
2437.0	21.884	22.204	20.681		22.204		
2462.0	17.876	17.876	17.796		17.876		

Traceability to Industry Recognized Test Methodologies	
Work Instruction:	WI-03 MEASURING RF SPECTRUM MASK
Measurement Uncertainty:	±2.81 dB

Note: click the links in the above matrix to view the graphical image (plot).

This test report may be reproduced in full only. The document may only be updated by MiCOM Labs personnel. Any changes will be noted in the Document History section of the report.



Title: Xirrus Inc. XI-AC1300, XI-AC867
To: FCC 47 CFR Part 15.247 & IC RSS-210
Serial #: XIRR04-U3 Rev A
Issue Date: 29th April 2014
Page: 32 of 572

Equipment Configuration for 6 dB & 99% Bandwidth

Variant:	3x3 802.11n HT-40	Duty Cycle (%):	94
Data Rate:	13.5 MBit/s	Antenna Gain (dBi):	Not Applicable
Modulation:	OFDM	Beam Forming Gain (Y):	Not Applicable
TPC:	Not Applicable	Tested By:	GMH
Engineering Test Notes:	Test setup: 6" SMA pigtailed soldered onto the pcb. Loss of pigtail not considered.		

Test Measurement Results

Test Frequency	Measured 6 dB Bandwidth (MHz)				6 dB Bandwidth (MHz)		Limit	Lowest Margin
	Port(s)				Highest	Lowest		
MHz	a	b	c	d			KHz	MHz
2422.0	36.072	36.713	36.713		36.713	36.072	≥500.0	-35.57
2437.0	36.072	36.072	36.553		36.553	36.072	≥500.0	-35.57
2452.0	36.393	36.713	36.713		36.713	36.393	≥500.0	-35.89

Test Frequency	Measured 99% Bandwidth (MHz)				Maximum 99% Bandwidth (MHz)		
	Port(s)						
MHz	a	b	c	d			
2422.0	36.393	36.393	36.393		36.393		
2437.0	36.874	36.874	36.713		36.874		
2452.0	36.393	36.393	36.393		36.393		

Traceability to Industry Recognized Test Methodologies	
Work Instruction:	WI-03 MEASURING RF SPECTRUM MASK
Measurement Uncertainty:	±2.81 dB

Note: click the links in the above matrix to view the graphical image (plot).

This test report may be reproduced in full only. The document may only be updated by MiCOM Labs personnel. Any changes will be noted in the Document History section of the report.



Title: Xirrus Inc. XI-AC1300, XI-AC867
To: FCC 47 CFR Part 15.247 & IC RSS-210
Serial #: XIRR04-U3 Rev A
Issue Date: 29th April 2014
Page: 33 of 572

Equipment Configuration for 6 dB & 99% Bandwidth

Variant:	3x3 802.11a	Duty Cycle (%):	94
Data Rate:	6 MBit/s	Antenna Gain (dBi):	Not Applicable
Modulation:	OFDM	Beam Forming Gain (Y):	Not Applicable
TPC:	Not Applicable	Tested By:	GMH
Engineering Test Notes:	Test setup: 6" SMA pigtailed soldered onto the pcb. Loss of pigtail not considered.		

Test Measurement Results

Test Frequency	Measured 6 dB Bandwidth (MHz)				6 dB Bandwidth (MHz)		Limit	Lowest Margin
	Port(s)				Highest	Lowest		
MHz	a	b	c	d			KHz	MHz
5745.0	16.433	16.433	16.433		16.433	16.433	≥500.0	-15.93
5785.0	16.513	16.513	16.433		16.513	16.433	≥500.0	-15.93
5825.0	16.513	16.513	16.513		16.513	16.513	≥500.0	-16.01

Test Frequency	Measured 99% Bandwidth (MHz)				Maximum 99% Bandwidth (MHz)		
	Port(s)						
MHz	a	b	c	d			
5745.0	16.754	16.914	16.593		16.914		
5785.0	16.754	16.914	16.593		16.914		
5825.0	16.593	16.754	16.593		16.754		

Traceability to Industry Recognized Test Methodologies	
Work Instruction:	WI-03 MEASURING RF SPECTRUM MASK
Measurement Uncertainty:	±2.81 dB

Note: click the links in the above matrix to view the graphical image (plot).

This test report may be reproduced in full only. The document may only be updated by MiCOM Labs personnel. Any changes will be noted in the Document History section of the report.



Title: Xirrus Inc. XI-AC1300, XI-AC867
To: FCC 47 CFR Part 15.247 & IC RSS-210
Serial #: XIRR04-U3 Rev A
Issue Date: 29th April 2014
Page: 34 of 572

Equipment Configuration for 6 dB & 99% Bandwidth

Variant:	3x3 802.11n HT-20	Duty Cycle (%):	94
Data Rate:	6.5 MBit/s	Antenna Gain (dBi):	Not Applicable
Modulation:	OFDM	Beam Forming Gain (Y):	Not Applicable
TPC:	Not Applicable	Tested By:	GMH
Engineering Test Notes:	Test setup: 6" SMA pigtailed soldered onto the pcb. Loss of pigtail not considered.		

Test Measurement Results

Test Frequency	Measured 6 dB Bandwidth (MHz)				6 dB Bandwidth (MHz)		Limit	Lowest Margin
	Port(s)				Highest	Lowest		
MHz	a	b	c	d				
5745.0	17.715	17.475	17.715		17.715	17.475	≥500.0	-16.98
5785.0	17.715	17.715	17.715		17.715	17.715	≥500.0	-17.22
5825.0	17.715	17.715	17.715		17.715	17.715	≥500.0	-17.22

Test Frequency	Measured 99% Bandwidth (MHz)				Maximum 99% Bandwidth (MHz)		
	Port(s)						
MHz	a	b	c	d			
5745.0	17.796	17.796	17.876		17.876		
5785.0	17.876	17.876	17.715		17.876		
5825.0	17.876	17.876	17.796		17.876		

Traceability to Industry Recognized Test Methodologies	
Work Instruction:	WI-03 MEASURING RF SPECTRUM MASK
Measurement Uncertainty:	±2.81 dB

Note: click the links in the above matrix to view the graphical image (plot).

This test report may be reproduced in full only. The document may only be updated by MiCOM Labs personnel. Any changes will be noted in the Document History section of the report.



Title: Xirrus Inc. XI-AC1300, XI-AC867
To: FCC 47 CFR Part 15.247 & IC RSS-210
Serial #: XIRR04-U3 Rev A
Issue Date: 29th April 2014
Page: 35 of 572

Equipment Configuration for 6 dB & 99% Bandwidth

Variant:	3x3 802.11n HT-40	Duty Cycle (%):	94
Data Rate:	13.5 MBit/s	Antenna Gain (dBi):	Not Applicable
Modulation:	OFDM	Beam Forming Gain (Y):	Not Applicable
TPC:	Not Applicable	Tested By:	GMH
Engineering Test Notes:	Test setup: 6" SMA pigtailed soldered onto the pcb. Loss of pigtail not considered.		

Test Measurement Results

Test Frequency	Measured 6 dB Bandwidth (MHz)				6 dB Bandwidth (MHz)		Limit	Lowest Margin
	Port(s)				Highest	Lowest		
	MHz	a	b	c			d	KHz
5755.0	36.713	36.713	36.393		36.713	36.393	≥500.0	-35.89
5795.0	36.713	36.713	36.393		36.713	36.393	≥500.0	-35.89

Test Frequency	Measured 99% Bandwidth (MHz)				Maximum 99% Bandwidth (MHz)		
	Port(s)						
	MHz	a	b	c	d		
5755.0	36.393	36.393	36.393		36.393		
5795.0	36.393	36.393	36.393		36.393		

Traceability to Industry Recognized Test Methodologies

Work Instruction:	WI-03 MEASURING RF SPECTRUM MASK
Measurement Uncertainty:	±2.81 dB

Note: click the links in the above matrix to view the graphical image (plot).

This test report may be reproduced in full only. The document may only be updated by MiCOM Labs personnel. Any changes will be noted in the Document History section of the report.



Title: Xirrus Inc. XI-AC1300, XI-AC867
To: FCC 47 CFR Part 15.247 & IC RSS-210
Serial #: XIRR04-U3 Rev A
Issue Date: 29th April 2014
Page: 36 of 572

Equipment Configuration for 6 dB & 99% Bandwidth

Variant:	3x3 802.11ac-40	Duty Cycle (%):	87
Data Rate:	13.5 MBit/s	Antenna Gain (dBi):	Not Applicable
Modulation:	OFDM	Beam Forming Gain (Y):	Not Applicable
TPC:	Not Applicable	Tested By:	GMH
Engineering Test Notes:	Test setup: 6" SMA pigtailed soldered onto the pcb. Loss of pigtail not considered.		

Test Measurement Results

Test Frequency MHz	Measured 6 dB Bandwidth (MHz)				6 dB Bandwidth (MHz)		Limit KHz	Lowest Margin MHz
	Port(s)				Highest	Lowest		
	a	b	c	d				
5755.0	36.713	36.393	36.393		36.713	36.393	≥500.0	-35.89
5795.0	36.713	35.752	36.713		36.713	35.752	≥500.0	-35.25

Test Frequency MHz	Measured 99% Bandwidth (MHz)				Maximum 99% Bandwidth (MHz)		
	Port(s)						
	a	b	c	d			
5755.0	36.393	36.393	36.393		36.393		
5795.0	36.393	36.393	36.393		36.393		

Traceability to Industry Recognized Test Methodologies

Work Instruction:	WI-03 MEASURING RF SPECTRUM MASK
Measurement Uncertainty:	±2.81 dB

Note: click the links in the above matrix to view the graphical image (plot).

This test report may be reproduced in full only. The document may only be updated by MiCOM Labs personnel. Any changes will be noted in the Document History section of the report.



Title: Xirrus Inc. XI-AC1300, XI-AC867
To: FCC 47 CFR Part 15.247 & IC RSS-210
Serial #: XIRR04-U3 Rev A
Issue Date: 29th April 2014
Page: 37 of 572

Equipment Configuration for 6 dB & 99% Bandwidth

Variant:	3x3 802.11ac-80	Duty Cycle (%):	76
Data Rate:	29.3 MBit/s	Antenna Gain (dBi):	Not Applicable
Modulation:	OFDM	Beam Forming Gain (Y):	Not Applicable
TPC:	Not Applicable	Tested By:	GMH
Engineering Test Notes:	Test setup: 6" SMA pigtailed soldered onto the pcb. Loss of pigtail not considered.		

Test Measurement Results

Test Frequency	Measured 6 dB Bandwidth (MHz)				6 dB Bandwidth (MHz)		Limit	Lowest Margin
	Port(s)				Highest	Lowest		
MHz	a	b	c	d			KHz	MHz
5775.0	76.633	74.068	73.747		76.633	73.747	≥500.0	-73.25

Test Frequency	Measured 99% Bandwidth (MHz)				Maximum 99% Bandwidth (MHz)		
	Port(s)						
MHz	a	b	c	d			
5775.0	75.992	76.313	75.671		76.313		

Traceability to Industry Recognized Test Methodologies

Work Instruction:	WI-03 MEASURING RF SPECTRUM MASK
Measurement Uncertainty:	±2.81 dB

Note: click the links in the above matrix to view the graphical image (plot).

This test report may be reproduced in full only. The document may only be updated by MiCOM Labs personnel. Any changes will be noted in the Document History section of the report.



Title: Xirrus Inc. XI-AC1300, XI-AC867
To: FCC 47 CFR Part 15.247 & IC RSS-210
Serial #: XIRR04-U3 Rev A
Issue Date: 29th April 2014
Page: 38 of 572

XI-AC867 2x2 Operation

Equipment Configuration for 6 dB & 99% Bandwidth

Variant:	2x2 802.11b	Duty Cycle (%):	99
Data Rate:	1 mbit	Antenna Gain (dBi):	Not Applicable
Modulation:	CCK	Beam Forming Gain (Y):	Not Applicable
TPC:	Not Applicable	Tested By:	
Engineering Test Notes:			

Test Measurement Results

Test Frequency MHz	Measured 6 dB Bandwidth (MHz)				6 dB Bandwidth (MHz)		Limit KHz	Lowest Margin MHz
	Port(s)				Highest	Lowest		
	a	b	c	d				
2412.0	7.214	7.214	--	--	7.214	7.214	≥500.0	-6.71
2437.0	7.695	7.214	--	--	7.695	7.214	≥500.0	-6.71
2462.0	7.214	7.214	--	--	7.214	7.214	≥500.0	-6.71

Test Frequency MHz	Measured 99% Bandwidth (MHz)				Maximum 99% Bandwidth (MHz)		
	Port(s)						
	a	b	c	d			
2412.0	12.265	11.784	--	--	12.265		
2437.0	12.745	11.944	--	--	12.745		
2462.0	12.585	11.864	--	--	12.585		

Traceability to Industry Recognized Test Methodologies	
Work Instruction:	WI-03 MEASURING RF SPECTRUM MASK
Measurement Uncertainty:	±2.81 dB

Note: click the links in the above matrix to view the graphical image (plot).

This test report may be reproduced in full only. The document may only be updated by MiCOM Labs personnel. Any changes will be noted in the Document History section of the report.



Title: Xirrus Inc. XI-AC1300, XI-AC867
To: FCC 47 CFR Part 15.247 & IC RSS-210
Serial #: XIRR04-U3 Rev A
Issue Date: 29th April 2014
Page: 39 of 572

Equipment Configuration for 6 dB & 99% Bandwidth

Variant:	2x2 802.11g	Duty Cycle (%):	99
Data Rate:	6 mbits	Antenna Gain (dBi):	Not Applicable
Modulation:	OFDM	Beam Forming Gain (Y):	Not Applicable
TPC:	Not Applicable	Tested By:	AH
Engineering Test Notes:			

Test Measurement Results

Test Frequency MHz	Measured 6 dB Bandwidth (MHz)				6 dB Bandwidth (MHz)		Limit KHz	Lowest Margin MHz
	Port(s)				Highest	Lowest		
	a	b	c	d				
2412.0	16.513	16.513	--	--	16.513	16.513	≥500.0	-16.01
2437.0	16.513	16.513	--	--	16.513	16.513	≥500.0	-16.01
2462.0	16.513	16.513	--	--	16.513	16.513	≥500.0	-16.01

Test Frequency MHz	Measured 99% Bandwidth (MHz)				Maximum 99% Bandwidth (MHz)		
	Port(s)						
	a	b	c	d			
2412.0	16.433	16.513	--	--	16.513		
2437.0	16.433	16.593	--	--	16.593		
2462.0	16.513	16.673	--	--	16.673		

Traceability to Industry Recognized Test Methodologies

Work Instruction:	WI-03 MEASURING RF SPECTRUM MASK
Measurement Uncertainty:	±2.81 dB

Note: click the links in the above matrix to view the graphical image (plot).

This test report may be reproduced in full only. The document may only be updated by MiCOM Labs personnel. Any changes will be noted in the Document History section of the report.



Title: Xirrus Inc. XI-AC1300, XI-AC867
To: FCC 47 CFR Part 15.247 & IC RSS-210
Serial #: XIRR04-U3 Rev A
Issue Date: 29th April 2014
Page: 40 of 572

Equipment Configuration for 6 dB & 99% Bandwidth

Variant:	2x2 802.11n HT-20	Duty Cycle (%):	98
Data Rate:	6.5 mbits	Antenna Gain (dBi):	Not Applicable
Modulation:	OFDM	Beam Forming Gain (Y):	Not Applicable
TPC:	Not Applicable	Tested By:	AH
Engineering Test Notes:			

Test Measurement Results

Test Frequency MHz	Measured 6 dB Bandwidth (MHz)				6 dB Bandwidth (MHz)		Limit KHz	Lowest Margin MHz
	Port(s)				Highest	Lowest		
	a	b	c	d				
2412.0	17.715	17.475	--	--	17.715	17.475	≥500.0	-16.98
2437.0	17.715	17.796	--	--	17.796	17.715	≥500.0	-17.22
2462.0	17.796	17.715	--	--	17.796	17.715	≥500.0	-17.22

Test Frequency MHz	Measured 99% Bandwidth (MHz)				Maximum 99% Bandwidth (MHz)		
	Port(s)						
	a	b	c	d			
2412.0	17.635	17.715	--	--	17.715		
2437.0	17.715	20.681	--	--	20.681		
2462.0	17.635	17.635	--	--	17.635		

Traceability to Industry Recognized Test Methodologies

Work Instruction:	WI-03 MEASURING RF SPECTRUM MASK
Measurement Uncertainty:	±2.81 dB

Note: click the links in the above matrix to view the graphical image (plot).

This test report may be reproduced in full only. The document may only be updated by MiCOM Labs personnel. Any changes will be noted in the Document History section of the report.



Title: Xirrus Inc. XI-AC1300, XI-AC867
To: FCC 47 CFR Part 15.247 & IC RSS-210
Serial #: XIRR04-U3 Rev A
Issue Date: 29th April 2014
Page: 41 of 572

Equipment Configuration for 6 dB & 99% Bandwidth

Variant:	2x2 802.11n HT-40	Duty Cycle (%):	98
Data Rate:	13.5 mbits	Antenna Gain (dBi):	Not Applicable
Modulation:	OFDM	Beam Forming Gain (Y):	Not Applicable
TPC:	Not Applicable	Tested By:	AH
Engineering Test Notes:			

Test Measurement Results

Test Frequency MHz	Measured 6 dB Bandwidth (MHz)				6 dB Bandwidth (MHz)		Limit KHz	Lowest Margin MHz
	Port(s)				Highest	Lowest		
	a	b	c	d				
2422.0	36.713	36.713	--	--	36.713	36.713	≥500.0	-36.21
2437.0	36.713	36.393	--	--	36.713	36.393	≥500.0	-35.89
2452.0	36.713	36.393	--	--	36.713	36.393	≥500.0	-35.89

Test Frequency MHz	Measured 99% Bandwidth (MHz)				Maximum 99% Bandwidth (MHz)		
	Port(s)						
	a	b	c	d			
2422.0	36.393	36.393	--	--	36.393		
2437.0	36.232	36.553	--	--	36.553		
2452.0	36.393	36.393	--	--	36.393		

Traceability to Industry Recognized Test Methodologies	
Work Instruction:	WI-03 MEASURING RF SPECTRUM MASK
Measurement Uncertainty:	±2.81 dB

Note: click the links in the above matrix to view the graphical image (plot).

This test report may be reproduced in full only. The document may only be updated by MiCOM Labs personnel. Any changes will be noted in the Document History section of the report.



Title: Xirrus Inc. XI-AC1300, XI-AC867
To: FCC 47 CFR Part 15.247 & IC RSS-210
Serial #: XIRR04-U3 Rev A
Issue Date: 29th April 2014
Page: 42 of 572

Equipment Configuration for 6 dB & 99% Bandwidth

Variant:	2x2 802.11a	Duty Cycle (%):	98
Data Rate:	6 mbits	Antenna Gain (dBi):	Not Applicable
Modulation:	OFDM	Beam Forming Gain (Y):	Not Applicable
TPC:	Not Applicable	Tested By:	AH
Engineering Test Notes:			

Test Measurement Results

Test Frequency MHz	Measured 6 dB Bandwidth (MHz) Port(s)				6 dB Bandwidth (MHz)		Limit KHz	Lowest Margin MHz
	a	b	c	d	Highest	Lowest		
5745.0	16.513	16.513	--	--	16.513	16.513	≥500.0	-16.01
5785.0	16.513	16.673	--	--	16.673	16.513	≥500.0	-16.01
5825.0	16.513	16.513	--	--	16.513	16.513	≥500.0	-16.01

Test Frequency MHz	Measured 99% Bandwidth (MHz) Port(s)				Maximum 99% Bandwidth (MHz)		
	a	b	c	d			
5745.0	16.513	16.593	--	--	16.593		
5785.0	16.513	16.593	--	--	16.593		
5825.0	16.513	16.593	--	--	16.593		

Traceability to Industry Recognized Test Methodologies	
Work Instruction:	WI-03 MEASURING RF SPECTRUM MASK
Measurement Uncertainty:	±2.81 dB

Note: click the links in the above matrix to view the graphical image (plot).

This test report may be reproduced in full only. The document may only be updated by MiCOM Labs personnel. Any changes will be noted in the Document History section of the report.



Title: Xirrus Inc. XI-AC1300, XI-AC867
To: FCC 47 CFR Part 15.247 & IC RSS-210
Serial #: XIRR04-U3 Rev A
Issue Date: 29th April 2014
Page: 43 of 572

Equipment Configuration for 6 dB & 99% Bandwidth

Variant:	2x2 802.11ac-80	Duty Cycle (%):	98
Data Rate:	29.3 mbits	Antenna Gain (dBi):	Not Applicable
Modulation:	OFDM	Beam Forming Gain (Y):	Not Applicable
TPC:	Not Applicable	Tested By:	AH
Engineering Test Notes:			

Test Measurement Results

Test Frequency	Measured 6 dB Bandwidth (MHz)				6 dB Bandwidth (MHz)		Limit	Lowest Margin
	Port(s)				Highest	Lowest		
MHz	a	b	c	d			KHz	MHz
5775.0	77.275	77.275	--	--	77.275	77.275	≥500.0	-76.78

Test Frequency	Measured 99% Bandwidth (MHz)				Maximum 99% Bandwidth (MHz)		
	Port(s)						
MHz	a	b	c	d			
5775.0	75.992	76.313	--	--	76.313		

Traceability to Industry Recognized Test Methodologies

Work Instruction:	WI-03 MEASURING RF SPECTRUM MASK
Measurement Uncertainty:	±2.81 dB

Note: click the links in the above matrix to view the graphical image (plot).

This test report may be reproduced in full only. The document may only be updated by MiCOM Labs personnel. Any changes will be noted in the Document History section of the report.



Title: Xirrus Inc. XI-AC1300, XI-AC867
To: FCC 47 CFR Part 15.247 & IC RSS-210
Serial #: XIRR04-U3 Rev A
Issue Date: 29th April 2014
Page: 44 of 572

Equipment Configuration for 6 dB & 99% Bandwidth

Variant:	2x2 802.11n HT-20	Duty Cycle (%):	98
Data Rate:	6.5 mbits	Antenna Gain (dBi):	Not Applicable
Modulation:	OFDM	Beam Forming Gain (Y):	Not Applicable
TPC:	Not Applicable	Tested By:	AH
Engineering Test Notes:			

Test Measurement Results

Test Frequency MHz	Measured 6 dB Bandwidth (MHz)				6 dB Bandwidth (MHz)		Limit KHz	Lowest Margin MHz
	Port(s)				Highest	Lowest		
	a	b	c	d				
5745.0	17.475	17.796	--	--	17.796	17.475	≥500.0	-16.98
5785.0	17.715	17.796	--	--	17.796	17.715	≥500.0	-17.22
5825.0	17.796	17.796	--	--	17.796	17.796	≥500.0	-17.30

Test Frequency MHz	Measured 99% Bandwidth (MHz)				Maximum 99% Bandwidth (MHz)		
	Port(s)						
	a	b	c	d			
5745.0	17.635	17.796	--	--	17.796		
5785.0	17.635	17.715	--	--	17.715		
5825.0	17.715	17.715	--	--	17.715		

Traceability to Industry Recognized Test Methodologies	
Work Instruction:	WI-03 MEASURING RF SPECTRUM MASK
Measurement Uncertainty:	±2.81 dB

Note: click the links in the above matrix to view the graphical image (plot).

This test report may be reproduced in full only. The document may only be updated by MiCOM Labs personnel. Any changes will be noted in the Document History section of the report.



Title: Xirrus Inc. XI-AC1300, XI-AC867
To: FCC 47 CFR Part 15.247 & IC RSS-210
Serial #: XIRR04-U3 Rev A
Issue Date: 29th April 2014
Page: 45 of 572

Equipment Configuration for 6 dB & 99% Bandwidth

Variant:	2x2 802.11n HT-40	Duty Cycle (%):	98
Data Rate:	13.5 mbits	Antenna Gain (dBi):	Not Applicable
Modulation:	OFDM	Beam Forming Gain (Y):	Not Applicable
TPC:	Not Applicable	Tested By:	AH
Engineering Test Notes:			

Test Measurement Results

Test Frequency MHz	Measured 6 dB Bandwidth (MHz)				6 dB Bandwidth (MHz)		Limit KHz	Lowest Margin MHz
	Port(s)				Highest	Lowest		
	a	b	c	d				
5755.0	36.713	36.713	--	--	36.713	36.713	≥500.0	-36.21
5795.0	36.713	36.713	--	--	36.713	36.713	≥500.0	-36.21

Test Frequency MHz	Measured 99% Bandwidth (MHz)				Maximum 99% Bandwidth (MHz)		
	Port(s)						
	a	b	c	d			
5755.0	36.393	36.393	--	--	36.393		
5795.0	36.393	36.393	--	--	36.393		

Traceability to Industry Recognized Test Methodologies

Work Instruction:	WI-03 MEASURING RF SPECTRUM MASK
Measurement Uncertainty:	±2.81 dB

Note: click the links in the above matrix to view the graphical image (plot).

This test report may be reproduced in full only. The document may only be updated by MiCOM Labs personnel. Any changes will be noted in the Document History section of the report.



Title: Xirrus Inc. XI-AC1300, XI-AC867
To: FCC 47 CFR Part 15.247 & IC RSS-210
Serial #: XIRR04-U3 Rev A
Issue Date: 29th April 2014
Page: 46 of 572

Specification

Limits

§15.247 (a)(2) & RSS-210 §A8.2(1)

The minimum 6 dB bandwidth shall be at least 500 kHz.

§ IC RSS-Gen 4.4.1 Occupied Bandwidth When an occupied bandwidth value is not specified in the applicable RSS, the transmitted signal bandwidth to be reported is to be its 99% emission bandwidth, as calculated or measured.

§ IC RSS-Gen 4.4.2 6 dB Bandwidth Where indicated, the 6 dB bandwidth is measured at the points when the spectral density of the signal is 6 dB down from the in-band spectral density of the modulated signal, with the transmitter modulated by a representative signal.

Traceability

Test Equipment Used

0158, 0287, 0252, 0313, 0314, 0070, 0116, 0117
--

This test report may be reproduced in full only. The document may only be updated by MiCOM Labs personnel. Any changes will be noted in the Document History section of the report.



Title: Xirrus Inc. XI-AC1300, XI-AC867
To: FCC 47 CFR Part 15.247 & IC RSS-210
Serial #: XIRR04-U3 Rev A
Issue Date: 29th April 2014
Page: 47 of 572

5.1.1.2. Peak Output Power

Conducted Test Conditions for Fundamental Emission Output Power			
Standard:	FCC CFR 47:15.247	Ambient Temp. (°C):	24.0 - 27.5
Test Heading:	Emission Output Power	Rel. Humidity (%):	32 - 45
Standard Section(s):	15.247 (a)(2)	Pressure (mBars):	999 - 1001
Reference Document(s):	KDB 558074 - D01 DTS Measurement Guidance v01: Section 5.2 Fundamental Emission Output Power KDB 662911 was implemented for In-band power measurements. The measure and sum technique was implemented in all cases.		

Test Procedure for Fundamental Emission Output Power Measurement

The transmitter terminal of EUT was connected to the input of the spectrum analyzer set to measure peak power. The resolution filter bandwidth was set to 6 dB, peak detector selected and the analyzer built-in power function was used to integrate peak power over the 20 dB bandwidth.

Supporting Information

Calculated Power = A + G + 10 log (1/x) dBm

A = Total Power [10 Log₁₀ (10^{a/10} + 10^{b/10} + 10^{c/10} + 10^{d/10})], G = Antenna Gain,

x = Duty Cycle

This test report may be reproduced in full only. The document may only be updated by MiCOM Labs personnel. Any changes will be noted in the Document History section of the report.



15.247 (c) Operation with directional antenna gains greater than 6 dBi.
If transmitting antennas of directional gain greater than 6 dBi are used, the conducted output power from the intentional radiator shall be reduced by the amount in dB that the directional gain of the antenna exceeds 6 dBi.

Uncorrelated Operation

2.4 GHz Uncorrelated Operation (MIMO)

Antenna (dB)	Gain (dBi)	Max. Allowable Conducted Peak Power (dBm)		Maximum EIRP (dBm)
		Uncorrelated	Max. Power Per Chain	
Integral	3.0	+30.0	+27.00	+33.0

5.8 GHz Uncorrelated Operation (MIMO)

Antenna (dB)	Gain (dBi)	Max. Allowable Conducted Peak Power (dBm)		Maximum EIRP (dBm)
		Uncorrelated	Max. Power Per Chain	
Integral	5.0	+30.0	+25.23	+35.0

Correlated Operation

2.4 GHz Correlated Operation (Non-MIMO i.e. Legacy)

Antenna (dB)	Gain dBi	Antenna Gain Increase V's No. Antenna Ports		Total Gain dBi	Max. Allowable Conducted Peak Power Σ (dBm)	Maximum EIRP (dBm)
		Ports	dB			
Integral	3.0	3	4.77	7.77	+28.23	+36.0

5.8 GHz Correlated Operation (Non-MIMO i.e. Legacy)

Antenna (dB)	Gain dBi	Antenna Gain Increase V's No. Antenna Ports		Total Gain dBi	Max. Allowable Conducted Peak Power Σ (dBm)	Maximum EIRP (dBm)
		Ports	dB			
Integral	5.0	3	4.77	9.77	+26.23	+36.0

This test report may be reproduced in full only. The document may only be updated by MiCOM Labs personnel. Any changes will be noted in the Document History section of the report.



Title: Xirrus Inc. XI-AC1300, XI-AC867
To: FCC 47 CFR Part 15.247 & IC RSS-210
Serial #: XIRR04-U3 Rev A
Issue Date: 29th April 2014
Page: 49 of 572

XI-AC1300 3x3 Operation

Equipment Configuration for Average Output Power

Variant:	3x3 802.11b	Duty Cycle (%):	99.0
Data Rate:	1 MBit/s	Antenna Gain (dBi):	2.50
Modulation:	CCK	Beam Forming Gain (Y):	Not Applicable
TPC:	Not Applicable	Tested By:	GMH
Engineering Test Notes:	Test setup: 6" SMA pigtailed soldered onto the pcb. Loss of pigtail not considered		

Test Measurement Results

Test Frequency	Measured Output Power (dBm)				Calculated Total Power Σ Port(s)	Limit	Margin	EUT Power Setting
	Port(s)							
MHz	a	b	c	d	dBm	dBm	dBm	
2412.0	19.39	20.12	18.77	--	24.24	30.00	-5.76	Target
2437.0	19.14	20.25	18.47	--	24.12	30.00	-5.88	Target
2462.0	18.89	20.09	17.47	--	23.72	30.00	-6.28	Target

Traceability to Industry Recognized Test Methodologies

Work Instruction:	WI-01 MEASURING RF OUTPUT POWER
Measurement Uncertainty:	± 1.33 dB

Equipment Configuration for Average Output Power

Variant:	3x3 802.11g	Duty Cycle (%):	94.5
Data Rate:	6 MBit/s	Antenna Gain (dBi):	2.50
Modulation:	OFDM	Beam Forming Gain (Y):	Not Applicable
TPC:	Not Applicable	Tested By:	GMH
Engineering Test Notes:	Test setup: 6" SMA pigtailed soldered onto the pcb. Loss of pigtail not considered.		

Test Measurement Results

Test Frequency	Measured Output Power (dBm)				Calculated Total Power Σ Port(s)	Limit	Margin	EUT Power Setting
	Port(s)							
MHz	a	b	c	d	dBm	dBm	dBm	
2412.0	16.55	16.61	16.16	--	21.21	30.00	-8.79	15.00
2437.0	19.52	20.45	18.74	--	24.39	30.00	-5.61	Target
2462.0	17.43	18.31	15.61	--	22.02	30.00	-7.98	16.00

Traceability to Industry Recognized Test Methodologies

Work Instruction:	WI-01 MEASURING RF OUTPUT POWER
Measurement Uncertainty:	± 1.33 dB

This test report may be reproduced in full only. The document may only be updated by MiCOM Labs personnel. Any changes will be noted in the Document History section of the report.



Title: Xirrus Inc. XI-AC1300, XI-AC867
To: FCC 47 CFR Part 15.247 & IC RSS-210
Serial #: XIRR04-U3 Rev A
Issue Date: 29th April 2014
Page: 50 of 572

Equipment Configuration for Average Output Power

Variant:	3x3 802.11n HT-20	Duty Cycle (%):	94.0
Data Rate:	6.5 MBit/s	Antenna Gain (dBi):	2.50
Modulation:	OFDM	Beam Forming Gain (Y):	Not Applicable
TPC:	Not Applicable	Tested By:	GMH
Engineering Test Notes:	Test setup: 6" SMA pigtails soldered onto the pcb. Loss of pigtail not considered.		

Test Measurement Results

Test Frequency	Measured Output Power (dBm)				Calculated Total Power Σ Port(s)	Limit	Margin	EUT Power Setting
	Port(s)							
MHz	a	b	c	d	dBm	dBm	dBm	
2412.0	16.72	17.59	16.02	--	21.59	30.00	-8.41	15.00
2437.0	19.55	20.56	18.43	--	24.37	30.00	-5.63	Target
2462.0	17.28	18.35	15.62	--	21.99	30.00	-8.01	16.00

Traceability to Industry Recognized Test Methodologies

Work Instruction:	WI-01 MEASURING RF OUTPUT POWER
Measurement Uncertainty:	± 1.33 dB

Equipment Configuration for Average Output Power

Variant:	3x3 802.11n HT-40	Duty Cycle (%):	94.0
Data Rate:	13.5 MBit/s	Antenna Gain (dBi):	2.50
Modulation:	OFDM	Beam Forming Gain (Y):	Not Applicable
TPC:	Not Applicable	Tested By:	GMH
Engineering Test Notes:	Test setup: 6" SMA pigtails soldered onto the pcb. Loss of pigtail not considered.		

Test Measurement Results

Test Frequency	Measured Output Power (dBm)				Calculated Total Power Σ Port(s)	Limit	Margin	EUT Power Setting
	Port(s)							
MHz	a	b	c	d	dBm	dBm	dBm	
2422.0	17.01	17.82	16.17	--	21.82	30.00	-8.18	16.00
2437.0	17.95	19.34	17.38	--	23.07	30.00	-6.93	Target
2452.0	16.85	17.90	15.45	--	21.62	30.00	-8.38	16.00

Traceability to Industry Recognized Test Methodologies

Work Instruction:	WI-01 MEASURING RF OUTPUT POWER
Measurement Uncertainty:	± 1.33 dB

This test report may be reproduced in full only. The document may only be updated by MiCOM Labs personnel. Any changes will be noted in the Document History section of the report.



Title: Xirrus Inc. XI-AC1300, XI-AC867
To: FCC 47 CFR Part 15.247 & IC RSS-210
Serial #: XIRR04-U3 Rev A
Issue Date: 29th April 2014
Page: 51 of 572

Equipment Configuration for Average Output Power

Variant:	3x3 802.11a	Duty Cycle (%):	94.0
Data Rate:	6 MBit/s	Antenna Gain (dBi):	5.00
Modulation:	OFDM	Beam Forming Gain (Y):	Not Applicable
TPC:	Not Applicable	Tested By:	GMH
Engineering Test Notes:	Test setup: 6" SMA pigtails soldered onto the pcb. Loss of pigtail not considered.		

Test Measurement Results

Test Frequency	Measured Output Power (dBm)				Calculated Total Power Σ Port(s)	Limit	Margin	EUT Power Setting
	Port(s)							
MHz	a	b	c	d	dBm	dBm	dBm	
5745.0	17.42	18.38	17.51	--	22.56	30.00	-7.44	17.00
5785.0	17.74	18.20	17.26	--	22.52	30.00	-7.48	17.00
5825.0	17.57	18.31	17.41	--	22.55	30.00	-7.45	17.00

Traceability to Industry Recognized Test Methodologies

Work Instruction:	WI-01 MEASURING RF OUTPUT POWER
Measurement Uncertainty:	± 1.33 dB

Equipment Configuration for Average Output Power

Variant:	3x3 802.11n HT-20	Duty Cycle (%):	94.0
Data Rate:	6.5 MBit/s	Antenna Gain (dBi):	5.00
Modulation:	OFDM	Beam Forming Gain (Y):	Not Applicable
TPC:	Not Applicable	Tested By:	GMH
Engineering Test Notes:	Test setup: 6" SMA pigtails soldered onto the pcb. Loss of pigtail not considered.		

Test Measurement Results

Test Frequency	Measured Output Power (dBm)				Calculated Total Power Σ Port(s)	Limit	Margin	EUT Power Setting
	Port(s)							
MHz	a	b	c	d	dBm	dBm	dBm	
5745.0	17.29	18.25	17.21	--	22.38	30.00	-7.62	17.00
5785.0	17.51	18.05	17.21	--	22.37	30.00	-7.63	17.00
5825.0	17.29	18.09	17.32	--	22.35	30.00	-7.65	17.00

Traceability to Industry Recognized Test Methodologies

Work Instruction:	WI-01 MEASURING RF OUTPUT POWER
Measurement Uncertainty:	± 1.33 dB

This test report may be reproduced in full only. The document may only be updated by MiCOM Labs personnel. Any changes will be noted in the Document History section of the report.



Title: Xirrus Inc. XI-AC1300, XI-AC867
To: FCC 47 CFR Part 15.247 & IC RSS-210
Serial #: XIRR04-U3 Rev A
Issue Date: 29th April 2014
Page: 52 of 572

Equipment Configuration for Average Output Power

Variant:	3x3 802.11n HT-40	Duty Cycle (%):	94.0
Data Rate:	13.5 MBit/s	Antenna Gain (dBi):	5.00
Modulation:	OFDM	Beam Forming Gain (Y):	Not Applicable
TPC:	Not Applicable	Tested By:	GMH
Engineering Test Notes:	Test setup: 6" SMA pigtailed soldered onto the pcb. Loss of pigtail not considered.		

Test Measurement Results

Test Frequency	Measured Output Power (dBm)				Calculated Total Power Σ Port(s)	Limit	Margin	EUT Power Setting
	Port(s)							
MHz	a	b	c	d	dBm	dBm	dBm	
5755.0	15.59	17.16	15.77	--	21.00	30.00	-9.00	17.00
5795.0	16.05	18.01	15.64	--	21.46	30.00	-8.54	17.00

Traceability to Industry Recognized Test Methodologies

Work Instruction:	WI-01 MEASURING RF OUTPUT POWER
Measurement Uncertainty:	± 1.33 dB

Equipment Configuration for Average Output Power

Variant:	3x3 802.11ac-40	Duty Cycle (%):	86.6
Data Rate:	13.5 MBit/s	Antenna Gain (dBi):	5.00
Modulation:	OFDM	Beam Forming Gain (Y):	Not Applicable
TPC:	Not Applicable	Tested By:	GMH
Engineering Test Notes:	Test setup: 6" SMA pigtailed soldered onto the pcb. Loss of pigtail not considered.		

Test Measurement Results

Test Frequency	Measured Output Power (dBm)				Calculated Total Power Σ Port(s)	Limit	Margin	EUT Power Setting
	Port(s)							
MHz	a	b	c	d	dBm	dBm	dBm	
5755.0	15.83	17.49	16.12	--	21.32	30.00	-8.68	17.00
5795.0	16.47	18.48	15.91	--	21.88	30.00	-8.12	17.00

Traceability to Industry Recognized Test Methodologies

Work Instruction:	WI-01 MEASURING RF OUTPUT POWER
Measurement Uncertainty:	± 1.33 dB

This test report may be reproduced in full only. The document may only be updated by MiCOM Labs personnel. Any changes will be noted in the Document History section of the report.



Title: Xirrus Inc. XI-AC1300, XI-AC867
To: FCC 47 CFR Part 15.247 & IC RSS-210
Serial #: XIRR04-U3 Rev A
Issue Date: 29th April 2014
Page: 53 of 572

Equipment Configuration for Average Output Power

Variant:	3x3 802.11ac-80	Duty Cycle (%):	76.3
Data Rate:	29.3 MBit/s	Antenna Gain (dBi):	5.00
Modulation:	OFDM	Beam Forming Gain (Y):	Not Applicable
TPC:	Not Applicable	Tested By:	GMH
Engineering Test Notes:	Test setup: 6" SMA pigtailed soldered onto the pcb. Loss of pigtail not considered.		

Test Measurement Results

Test Frequency	Measured Output Power (dBm)				Calculated Total Power Σ Port(s)	Limit	Margin	EUT Power Setting
	Port(s)							
MHz	a	b	c	d	dBm	dBm	dBm	
5775.0	16.22	17.97	15.97	--	21.59	30.00	-8.41	17.00

Traceability to Industry Recognized Test Methodologies

Work Instruction:	WI-01 MEASURING RF OUTPUT POWER
Measurement Uncertainty:	±1.33 dB

This test report may be reproduced in full only. The document may only be updated by MiCOM Labs personnel. Any changes will be noted in the Document History section of the report.



Title: Xirrus Inc. XI-AC1300, XI-AC867
To: FCC 47 CFR Part 15.247 & IC RSS-210
Serial #: XIRR04-U3 Rev A
Issue Date: 29th April 2014
Page: 54 of 572

XI-AC867 2x2 Operation

Equipment Configuration for Average Output Power

Variant:	2x2 802.11b	Duty Cycle (%):	99.0
Data Rate:	1 Mbit/s	Antenna Gain (dBi):	2.0
Modulation:	CCK	Beam Forming Gain (Y):	Not Applicable
TPC:	Not Applicable	Tested By:	AH
Engineering Test Notes:			

Test Measurement Results

Test Frequency	Measured Output Power (dBm)				Calculated Total Power Σ Port(s) + DCCF Duty Cycle Correction Factor : +0.04 dB	Limit	Margin	EUT Power Setting
	Port(s)							
MHz	a	b	c	d	dBm	dBm	dB	
2412.0	19.33	17.60	--	--	21.60	30.00	-8.40	18.00
2437.0	19.94	18.96	--	--	22.53	30.00	-7.47	19.00
2462.0	19.69	19.12	--	--	22.47	30.00	-7.53	19.00

Traceability to Industry Recognized Test Methodologies

Work Instruction:	WI-01 MEASURING RF OUTPUT POWER
Measurement Uncertainty:	± 1.33 dB

Equipment Configuration for Average Output Power

Variant:	2x2 802.11g	Duty Cycle (%):	99.0
Data Rate:	6 mbits	Antenna Gain (dBi):	2.0
Modulation:	OFDM	Beam Forming Gain (Y):	Not Applicable
TPC:	Not Applicable	Tested By:	AH
Engineering Test Notes:			

Test Measurement Results

Test Frequency	Measured Output Power (dBm)				Calculated Total Power Σ Port(s) + DCCF Duty Cycle Correction Factor : +0.04 dB	Limit	Margin	EUT Power Setting
	Port(s)							
MHz	a	b	c	d	dBm	dBm	dB	
2412.0	14.15	16.69	--	--	18.66	30.00	-11.34	15.00
2437.0	17.48	19.08	--	--	21.41	30.00	-8.59	18.00
2462.0	16.88	18.03	--	--	20.55	30.00	-9.45	17.00

Traceability to Industry Recognized Test Methodologies

Work Instruction:	WI-01 MEASURING RF OUTPUT POWER
Measurement Uncertainty:	± 1.33 dB

This test report may be reproduced in full only. The document may only be updated by MiCOM Labs personnel. Any changes will be noted in the Document History section of the report.



Title: Xirrus Inc. XI-AC1300, XI-AC867
To: FCC 47 CFR Part 15.247 & IC RSS-210
Serial #: XIRR04-U3 Rev A
Issue Date: 29th April 2014
Page: 55 of 572

Equipment Configuration for Average Output Power

Variant:	2x2 802.11n HT-20	Duty Cycle (%):	98.0
Data Rate:	6.5 mbits	Antenna Gain (dBi):	2.0
Modulation:	OFDM	Beam Forming Gain (Y):	Not Applicable
TPC:	Not Applicable	Tested By:	AH
Engineering Test Notes:			

Test Measurement Results

Test Frequency	Measured Output Power (dBm)				Calculated Total Power Σ Port(s) + DCCF Duty Cycle Correction Factor : +0.09 dB	Limit	Margin	EUT Power Setting
	Port(s)							
MHz	a	b	c	d	dBm	dBm	dB	
2412.0	15.11	17.49	--	--	19.56	30.00	-10.44	16.00
2437.0	18.24	19.72	--	--	22.14	30.00	-7.86	19.00
2462.0	15.65	17.10	--	--	19.53	30.00	-10.47	16.00

Traceability to Industry Recognized Test Methodologies

Work Instruction:	WI-01 MEASURING RF OUTPUT POWER
Measurement Uncertainty:	±1.33 dB

Equipment Configuration for Average Output Power

Variant:	2x2 802.11n HT-40	Duty Cycle (%):	98.0
Data Rate:	13.5 mbits	Antenna Gain (dBi):	2.0
Modulation:	OFDM	Beam Forming Gain (Y):	Not Applicable
TPC:	Not Applicable	Tested By:	AH
Engineering Test Notes:			

Test Measurement Results

Test Frequency	Measured Output Power (dBm)				Calculated Total Power Σ Port(s) + DCCF Duty Cycle Correction Factor : +0.09 dB	Limit	Margin	EUT Power Setting
	Port(s)							
MHz	a	b	c	d	dBm	dBm	dB	
2422.0	15.12	16.87	--	--	19.18	30.00	-10.82	16.00
2437.0	17.13	18.61	--	--	21.03	30.00	-8.97	18.00
2452.0	16.08	17.73	--	--	20.08	30.00	-9.92	17.00

Traceability to Industry Recognized Test Methodologies

Work Instruction:	WI-01 MEASURING RF OUTPUT POWER
Measurement Uncertainty:	±1.33 dB

This test report may be reproduced in full only. The document may only be updated by MiCOM Labs personnel. Any changes will be noted in the Document History section of the report.



Title: Xirrus Inc. XI-AC1300, XI-AC867
To: FCC 47 CFR Part 15.247 & IC RSS-210
Serial #: XIRR04-U3 Rev A
Issue Date: 29th April 2014
Page: 56 of 572

Equipment Configuration for Average Output Power

Variant:	2x2 802.11a	Duty Cycle (%):	98.0
Data Rate:	6 mbits	Antenna Gain (dBi):	2.0
Modulation:	OFDM	Beam Forming Gain (Y):	Not Applicable
TPC:	Not Applicable	Tested By:	AH
Engineering Test Notes:			

Test Measurement Results

Test Frequency	Measured Output Power (dBm)				Calculated Total Power Σ Port(s) + DCCF Duty Cycle Correction Factor : +0.09 dB	Limit	Margin	EUT Power Setting
	Port(s)							
MHz	a	b	c	d	dBm	dBm	dB	
5745.0	17.77	17.21	--	--	20.60	30.00	-9.40	18.00
5785.0	17.98	17.97	--	--	21.07	30.00	-8.93	18.00
5825.0	18.29	17.86	--	--	21.18	30.00	-8.82	18.00

Traceability to Industry Recognized Test Methodologies

Work Instruction:	WI-01 MEASURING RF OUTPUT POWER
Measurement Uncertainty:	±1.33 dB

Equipment Configuration for Average Output Power

Variant:	2x2 802.11ac-80	Duty Cycle (%):	98.0
Data Rate:	29.3 mbits	Antenna Gain (dBi):	2.0
Modulation:	OFDM	Beam Forming Gain (Y):	Not Applicable
TPC:	Not Applicable	Tested By:	AH
Engineering Test Notes:			

Test Measurement Results

Test Frequency	Measured Output Power (dBm)				Calculated Total Power Σ Port(s) + DCCF Duty Cycle Correction Factor : +0.09 dB	Limit	Margin	EUT Power Setting
	Port(s)							
MHz	a	b	c	d	dBm	dBm	dB	
5775.0	16.58	16.65	--	--	19.71	30.00	-10.29	18.00

Traceability to Industry Recognized Test Methodologies

Work Instruction:	WI-01 MEASURING RF OUTPUT POWER
Measurement Uncertainty:	±1.33 dB

This test report may be reproduced in full only. The document may only be updated by MiCOM Labs personnel. Any changes will be noted in the Document History section of the report.



Title: Xirrus Inc. XI-AC1300, XI-AC867
To: FCC 47 CFR Part 15.247 & IC RSS-210
Serial #: XIRR04-U3 Rev A
Issue Date: 29th April 2014
Page: 57 of 572

Equipment Configuration for Average Output Power

Variant:	2x2 802.11n HT-20	Duty Cycle (%):	98.0
Data Rate:	6.5 mbits	Antenna Gain (dBi):	2.0
Modulation:	OFDM	Beam Forming Gain (Y):	Not Applicable
TPC:	Not Applicable	Tested By:	AH
Engineering Test Notes:			

Test Measurement Results

Test Frequency	Measured Output Power (dBm)				Calculated Total Power Σ Port(s) + DCCF Duty Cycle Correction Factor : +0.09 dB	Limit	Margin	EUT Power Setting
	Port(s)							
MHz	a	b	c	d	dBm	dBm	dB	
5745.0	17.92	17.15	--	--	20.65	30.00	-9.35	18.00
5785.0	16.99	16.25	--	--	19.73	30.00	-10.27	17.00
5825.0	17.28	16.80	--	--	20.14	30.00	-9.86	17.00

Traceability to Industry Recognized Test Methodologies

Work Instruction:	WI-01 MEASURING RF OUTPUT POWER
Measurement Uncertainty:	±1.33 dB

Equipment Configuration for Average Output Power

Variant:	2x2 802.11n HT-40	Duty Cycle (%):	98.0
Data Rate:	13.5 mbits	Antenna Gain (dBi):	2.0
Modulation:	OFDM	Beam Forming Gain (Y):	Not Applicable
TPC:	Not Applicable	Tested By:	AH
Engineering Test Notes:			

Test Measurement Results

Test Frequency	Measured Output Power (dBm)				Calculated Total Power Σ Port(s) + DCCF Duty Cycle Correction Factor : +0.09 dB	Limit	Margin	EUT Power Setting
	Port(s)							
MHz	a	b	c	d	dBm	dBm	dB	
5755.0	15.59	16.01	--	--	18.90	30.00	-11.10	17.00
5795.0	15.94	16.03	--	--	19.08	30.00	-10.92	17.00

Traceability to Industry Recognized Test Methodologies

Work Instruction:	WI-01 MEASURING RF OUTPUT POWER
Measurement Uncertainty:	±1.33 dB

This test report may be reproduced in full only. The document may only be updated by MiCOM Labs personnel. Any changes will be noted in the Document History section of the report.



Specification

Limits

§15.247 (b) The maximum peak output power of the intentional radiator shall not exceed the following:

§15.247 (b) (3) For systems using digital modulation in the 902-928 MHz, 2400-2483.5 MHz and 5725-5850 MHz bands: 1.0 watt.

15.247 (b) (4) The conducted output power limit specified in paragraph (b) of this section is based on the use of antennas with directional gains that do not exceed 6 dBi. Except as shown in paragraph (c) of this section, if transmitting antennas of directional gain greater than 6 dBi are used, the conducted output power from the intentional radiator shall be reduced below the stated values in paragraphs (b)(1), (b)(2), and (b)(3) of this section, as appropriate, by the amount in dB that the directional gain of the antenna exceeds 6 dBi.

15.247 (c) Operation with directional antenna gains greater than 6 dBi.

(1) Fixed point-to-point operation:

(i) Systems operating in the 2400–2483.5 MHz band that are used exclusively for fixed, point-to-point operations may employ transmitting antennas with directional gain greater than 6 dBi provided the maximum conducted output power of the intentional radiator is reduced by 1 dB for every 3 dB that the directional gain of the antenna exceeds 6 dBi.

(ii) Systems operating in the 5725–5850 MHz band that are used exclusively for fixed, point-to-point operations may employ transmitting antennas with directional gain greater than 6 dBi without any corresponding reduction in transmitter conducted output power.

§15.31 (e) For intentional radiators, measurements of the variation of the input power or the radiated signal level of the fundamental frequency component of the emission, as appropriate, shall be performed with the supply voltage varied between 85% and 115% of the nominal rated supply voltage. For battery operated equipment, the equipment tests shall be performed using a new battery.

§ RSS-210 A8.4(4) For systems employing digital modulation techniques operating in the 902-928 MHz, 2400-2483.5 MHz and 5725-5850 MHz bands the maximum peak conducted power shall not exceed 1 watt.

Traceability

Method	Test Equipment Used
Measurements were made per work instruction WI-01 'Measuring RF Output Power'	0158, 0287, 0252, 0313, 0314, 0070, 0116, 0117

This test report may be reproduced in full only. The document may only be updated by MiCOM Labs personnel. Any changes will be noted in the Document History section of the report.



Title: Xirrus Inc. XI-AC1300, XI-AC867
To: FCC 47 CFR Part 15.247 & IC RSS-210
Serial #: XIRR04-U3 Rev A
Issue Date: 29th April 2014
Page: 59 of 572

5.1.1.3. Power Spectral Density

Conducted Test Conditions for Power Spectral Density			
Standard:	FCC CFR 47:15.247	Ambient Temp. (°C):	24.0 - 27.5
Test Heading:	Power Spectral Density	Rel. Humidity (%):	32 - 45
Standard Section(s):	15.247 (e)	Pressure (mBars):	999 - 1001
Reference Document(s):	KDB 558074 - D01 DTS Measurement Guidance v01: Section 5.3 Maximum Power Spectral Density Level in the Emission Bandwidth		
Test Procedure for Power Spectral Density The transmitter output was connected to a spectrum analyzer and the maximum level in a 3 kHz bandwidth was measured. A peak value was found over the full emission bandwidth and the frequency span reduced to obtain enhanced resolution. Sweep time \geq span / 3 kHz with video averaging turned off. The Peak Power Spectral Density is the highest level found across the emission in a 3 kHz resolution bandwidth.			
Supporting Information Calculated Power = $A + 10 \log (1/x)$ dBm $A = \text{Total Power Spectral Density } [10 \text{ Log}_{10} (10^{a/10} + 10^{b/10} + 10^{c/10} + 10^{d/10})]$ $x = \text{Duty Cycle}$ Limit Line: KDB 662911 was implemented for In-band power spectral density (PSD) measurements - Option (2) measure and subtract $10 \log (N)$ dB from the limit for devices with multiple RF ports			

This test report may be reproduced in full only. The document may only be updated by MiCOM Labs personnel. Any changes will be noted in the Document History section of the report.



Title: Xirrus Inc. XI-AC1300, XI-AC867
To: FCC 47 CFR Part 15.247 & IC RSS-210
Serial #: XIRR04-U3 Rev A
Issue Date: 29th April 2014
Page: 60 of 572

XI-AC1300 3x3 Operation

Equipment Configuration for Power Spectral Density - Average

Variant:	3x3 802.11b	Duty Cycle (%):	99
Data Rate:	1 MBit/s	Antenna Gain (dBi):	Not Applicable
Modulation:	CCK	Beam Forming Gain (Y):	Not Applicable
TPC:	Not Applicable	Tested By:	GMH
Engineering Test Notes:			

Test Measurement Results

Test Frequency	Measured Power Spectral Density (dBm)				Calculated Total Power Spectral Density		Limit	Margin
	Port(s)				dBm			
MHz	a	b	c	d	Σ Port(s) per 30kHz RBW	Conversion to 3 kHz RBW	dBm	dB
2412.0	1.607	3.049	0.820	--	6.696	-3.304	8.00	-11.30
2437.0	0.486	1.384	0.827	--	5.686	-4.314	8.00	-12.32
2462.0	1.607	2.591	-1.026	--	6.078	-3.922	8.00	-11.92

Traceability to Industry Recognized Test Methodologies

Work Instruction:	WI-03 MEASURING RF SPECTRUM MASK
Measurement Uncertainty:	±2.81 dB

Note: click the links in the above matrix to view the graphical image (plot).

Equipment Configuration for Power Spectral Density - Average

Variant:	3x3 802.11g	Duty Cycle (%):	95
Data Rate:	6 MBit/s	Antenna Gain (dBi):	Not Applicable
Modulation:	OFDM	Beam Forming Gain (Y):	Not Applicable
TPC:	Not Applicable	Tested By:	GMH
Engineering Test Notes:			

Test Measurement Results

Test Frequency	Measured Power Spectral Density (dBm)				Calculated Total Power Spectral Density		Limit	Margin
	Port(s)				dBm			
MHz	a	b	c	d	Σ Port(s) per 30kHz RBW	Conversion to 3 kHz RBW	dBm	dB
2412.0	-4.650	-3.342	-5.115	--	0.469	-9.531	8.00	-17.53
2437.0	-1.113	-0.373	-2.900	--	3.433	-6.567	8.00	-14.57
2462.0	-4.313	-2.771	-5.719	--	0.670	-9.330	8.00	-17.33

Traceability to Industry Recognized Test Methodologies

Work Instruction:	WI-03 MEASURING RF SPECTRUM MASK
Measurement Uncertainty:	±2.81 dB

Note: click the links in the above matrix to view the graphical image (plot).

This test report may be reproduced in full only. The document may only be updated by MiCOM Labs personnel. Any changes will be noted in the Document History section of the report.



Title: Xirrus Inc. XI-AC1300, XI-AC867
To: FCC 47 CFR Part 15.247 & IC RSS-210
Serial #: XIRR04-U3 Rev A
Issue Date: 29th April 2014
Page: 61 of 572

Equipment Configuration for Power Spectral Density - Average

Variant:	3x3 802.11n HT-20	Duty Cycle (%):	94
Data Rate:	6.5 MBit/s	Antenna Gain (dBi):	Not Applicable
Modulation:	OFDM	Beam Forming Gain (Y):	Not Applicable
TPC:	Not Applicable	Tested By:	GMH
Engineering Test Notes:			

Test Measurement Results

Test Frequency	Measured Power Spectral Density (dBm)				Calculated Total Power Spectral Density		Limit	Margin
	Port(s)				dBm			
MHz	a	b	c	d	Σ Port(s) per 30kHz RBW	Conversion to 3 kHz RBW	dBm	dB
2412.0	-5.412	-4.047	-5.606	--	-0.193	-10.193	8.00	-18.19
2437.0	-1.585	-1.703	-3.211	--	2.665	-7.335	8.00	-15.34
2462.0	-4.390	-3.114	-6.348	--	0.350	-9.650	8.00	-17.65

Traceability to Industry Recognized Test Methodologies

Work Instruction:	WI-03 MEASURING RF SPECTRUM MASK
Measurement Uncertainty:	±2.81 dB

Note: click the links in the above matrix to view the graphical image (plot).

Equipment Configuration for Power Spectral Density - Average

Variant:	3x3 802.11n HT-40	Duty Cycle (%):	94
Data Rate:	13.5 MBit/s	Antenna Gain (dBi):	Not Applicable
Modulation:	OFDM	Beam Forming Gain (Y):	Not Applicable
TPC:	Not Applicable	Tested By:	GMH
Engineering Test Notes:			

Test Measurement Results

Test Frequency	Measured Power Spectral Density (dBm)				Calculated Total Power Spectral Density		Limit	Margin
	Port(s)				dBm			
MHz	a	b	c	d	Σ Port(s) per 30kHz RBW	Conversion to 3 kHz RBW	dBm	dB
2422.0	-8.953	-7.787	-10.027	--	-4.055	-14.055	8.00	-22.06
2437.0	-7.459	-6.080	-8.095	--	-2.357	-12.357	8.00	-20.36
2452.0	-9.511	-8.676	-10.920	--	-4.835	-14.835	8.00	-22.84

Traceability to Industry Recognized Test Methodologies

Work Instruction:	WI-03 MEASURING RF SPECTRUM MASK
Measurement Uncertainty:	±2.81 dB

Note: click the links in the above matrix to view the graphical image (plot).

This test report may be reproduced in full only. The document may only be updated by MiCOM Labs personnel. Any changes will be noted in the Document History section of the report.



Title: Xirrus Inc. XI-AC1300, XI-AC867
To: FCC 47 CFR Part 15.247 & IC RSS-210
Serial #: XIRR04-U3 Rev A
Issue Date: 29th April 2014
Page: 62 of 572

Equipment Configuration for Power Spectral Density - Average

Variant:	3x3 802.11a	Duty Cycle (%):	94
Data Rate:	6 MBit/s	Antenna Gain (dBi):	Not Applicable
Modulation:	OFDM	Beam Forming Gain (Y):	Not Applicable
TPC:	Not Applicable	Tested By:	GMH
Engineering Test Notes:			

Test Measurement Results

Test Frequency	Measured Power Spectral Density (dBm)				Calculated Total Power Spectral Density		Limit	Margin
	Port(s)				dBm			
MHz	a	b	c	d	Σ Port(s) per 30kHz RBW	Conversion to 3 kHz RBW	dBm	dB
5745.0	-4.138	-3.045	-4.527	--	0.914	-9.086	8.00	-17.09
5785.0	-3.880	-3.233	-4.454	--	0.944	-9.056	8.00	-17.06
5825.0	-3.588	-3.293	-3.990	--	1.157	-8.843	8.00	-16.84

Traceability to Industry Recognized Test Methodologies

Work Instruction:	WI-03 MEASURING RF SPECTRUM MASK
Measurement Uncertainty:	±2.81 dB

Note: click the links in the above matrix to view the graphical image (plot).

Equipment Configuration for Power Spectral Density - Average

Variant:	3x3 802.11n HT-20	Duty Cycle (%):	94
Data Rate:	6.5 MBit/s	Antenna Gain (dBi):	Not Applicable
Modulation:	OFDM	Beam Forming Gain (Y):	Not Applicable
TPC:	Not Applicable	Tested By:	GMH
Engineering Test Notes:			

Test Measurement Results

Test Frequency	Measured Power Spectral Density (dBm)				Calculated Total Power Spectral Density		Limit	Margin
	Port(s)				dBm			
MHz	a	b	c	d	Σ Port(s) per 30kHz RBW	Conversion to 3 kHz RBW	dBm	dB
5745.0	-4.250	-3.403	-4.588	--	0.720	-9.280	8.00	-17.28
5785.0	-4.549	-4.010	-4.663	--	0.373	-9.627	8.00	-17.63
5825.0	-4.129	-4.254	-4.296	--	0.545	-9.455	8.00	-17.46

Traceability to Industry Recognized Test Methodologies

Work Instruction:	WI-03 MEASURING RF SPECTRUM MASK
Measurement Uncertainty:	±2.81 dB

Note: click the links in the above matrix to view the graphical image (plot).

This test report may be reproduced in full only. The document may only be updated by MiCOM Labs personnel. Any changes will be noted in the Document History section of the report.



Title: Xirrus Inc. XI-AC1300, XI-AC867
To: FCC 47 CFR Part 15.247 & IC RSS-210
Serial #: XIRR04-U3 Rev A
Issue Date: 29th April 2014
Page: 63 of 572

Equipment Configuration for Power Spectral Density - Average

Variant:	3x3 802.11n HT-40	Duty Cycle (%):	94
Data Rate:	13.5 MBit/s	Antenna Gain (dBi):	Not Applicable
Modulation:	OFDM	Beam Forming Gain (Y):	Not Applicable
TPC:	Not Applicable	Tested By:	GMH
Engineering Test Notes:			

Test Measurement Results

Test Frequency	Measured Power Spectral Density (dBm)				Calculated Total Power Spectral Density		Limit	Margin
	Port(s)				dBm			
MHz	a	b	c	d	Σ Port(s) per 30kHz RBW	Conversion to 3 kHz RBW	dBm	dB
5755.0	-9.897	-9.054	-10.166	--	-4.908	-14.908	8.00	-22.91
5795.0	-9.857	-8.496	-9.953	--	-4.612	-14.612	8.00	-22.61

Traceability to Industry Recognized Test Methodologies

Work Instruction:	WI-03 MEASURING RF SPECTRUM MASK
Measurement Uncertainty:	±2.81 dB

Note: click the links in the above matrix to view the graphical image (plot).

Equipment Configuration for Power Spectral Density - Average

Variant:	3x3 802.11ac-40	Duty Cycle (%):	87
Data Rate:	13.5 MBit/s	Antenna Gain (dBi):	Not Applicable
Modulation:	OFDM	Beam Forming Gain (Y):	Not Applicable
TPC:	Not Applicable	Tested By:	GMH
Engineering Test Notes:			

Test Measurement Results

Test Frequency	Measured Power Spectral Density (dBm)				Calculated Total Power Spectral Density		Limit	Margin
	Port(s)				dBm			
MHz	a	b	c	d	Σ Port(s) per 30kHz RBW	Conversion to 3 kHz RBW	dBm	dB
5755.0	-10.697	-9.299	-10.732	--	-5.418	-15.418	8.00	-23.42
5795.0	-10.183	-8.455	-10.884	--	-4.946	-14.946	8.00	-22.95

Traceability to Industry Recognized Test Methodologies

Work Instruction:	WI-03 MEASURING RF SPECTRUM MASK
Measurement Uncertainty:	±2.81 dB

Note: click the links in the above matrix to view the graphical image (plot).

This test report may be reproduced in full only. The document may only be updated by MiCOM Labs personnel. Any changes will be noted in the Document History section of the report.



Title: Xirrus Inc. XI-AC1300, XI-AC867
To: FCC 47 CFR Part 15.247 & IC RSS-210
Serial #: XIRR04-U3 Rev A
Issue Date: 29th April 2014
Page: 64 of 572

Equipment Configuration for Power Spectral Density - Average

Variant:	3x3 802.11ac-80	Duty Cycle (%):	76
Data Rate:	29.3 MBit/s	Antenna Gain (dBi):	Not Applicable
Modulation:	OFDM	Beam Forming Gain (Y):	Not Applicable
TPC:	Not Applicable	Tested By:	GMH
Engineering Test Notes:			

Test Measurement Results

Test Frequency	Measured Power Spectral Density (dBm)				Calculated Total Power Spectral Density		Limit	Margin
	Port(s)				dBm			
MHz	a	b	c	d	Σ Port(s) per 30kHz RBW	Conversion to 3 kHz RBW	dBm	dB
5775.0	-15.387	-13.639	-16.262	--	-10.185	-20.185	8.00	-28.19

Traceability to Industry Recognized Test Methodologies

Work Instruction:	WI-03 MEASURING RF SPECTRUM MASK
Measurement Uncertainty:	±2.81 dB

Note: click the links in the above matrix to view the graphical image (plot).

This test report may be reproduced in full only. The document may only be updated by MiCOM Labs personnel. Any changes will be noted in the Document History section of the report.



Title: Xirrus Inc. XI-AC1300, XI-AC867
To: FCC 47 CFR Part 15.247 & IC RSS-210
Serial #: XIRR04-U3 Rev A
Issue Date: 29th April 2014
Page: 65 of 572

XI-AC867 2x2 Operation

Equipment Configuration for Power Spectral Density - Average

Variant:	2x2 802.11b	Duty Cycle (%):	99.0
Data Rate:	1 mbit/s	Antenna Gain (dBi):	2.00
Modulation:	CCK	Beam Forming Gain (Y):	Not Applicable
TPC:	Not Applicable	Tested By:	
Engineering Test Notes:			

Test Measurement Results

Test Frequency	Measured Power Spectral Density				Amplitude Summation + DCCF Duty Cycle Correction Factor : +0.04 dB	Limit	Margin
	Port(s) (dBm/3KHz)						
MHz	a	b	c	d	dBm/3KHz	dBm/3KHz	dB
2412.0	-11.705	-13.565	--	--	-9.746	8.0	-17.8
2437.0	-11.705	-12.869	--	--	-9.273	8.0	-17.3
2462.0	-11.519	-12.591	--	--	-9.230	8.0	-17.2

Traceability to Industry Recognized Test Methodologies

Work Instruction:	WI-03 MEASURING RF SPECTRUM MASK
Measurement Uncertainty:	±2.81 dB

Note: click the links in the above matrix to view the graphical image (plot).

Equipment Configuration for Power Spectral Density - Average

Variant:	2x2 802.11g	Duty Cycle (%):	99.0
Data Rate:	6 mbits	Antenna Gain (dBi):	2.00
Modulation:	OFDM	Beam Forming Gain (Y):	Not Applicable
TPC:	Not Applicable	Tested By:	AH
Engineering Test Notes:			

Test Measurement Results

Test Frequency	Measured Power Spectral Density				Amplitude Summation + DCCF Duty Cycle Correction Factor : +0.04 dB	Limit	Margin
	Port(s) (dBm/3KHz)						
MHz	a	b	c	d	dBm/3KHz	dBm/3KHz	dB
2412.0	-21.023	-18.611	--	--	-16.940	8.0	-25.0
2437.0	-17.482	-17.310	--	--	-15.042	8.0	-23.1
2462.0	-18.142	-17.013	--	--	-14.855	8.0	-22.9

Traceability to Industry Recognized Test Methodologies

Work Instruction:	WI-03 MEASURING RF SPECTRUM MASK
Measurement Uncertainty:	±2.81 dB

Note: click the links in the above matrix to view the graphical image (plot).

This test report may be reproduced in full only. The document may only be updated by MiCOM Labs personnel. Any changes will be noted in the Document History section of the report.



Title: Xirrus Inc. XI-AC1300, XI-AC867
To: FCC 47 CFR Part 15.247 & IC RSS-210
Serial #: XIRR04-U3 Rev A
Issue Date: 29th April 2014
Page: 66 of 572

Equipment Configuration for Power Spectral Density - Average

Variants:	2x2 802.11n HT-20	Duty Cycle (%):	98.0
Data Rate:	6.5 mbits	Antenna Gain (dBi):	2.00
Modulation:	OFDM	Beam Forming Gain (Y):	Not Applicable
TPC:	Not Applicable	Tested By:	AH
Engineering Test Notes:			

Test Measurement Results

Test Frequency	Measured Power Spectral Density				Amplitude Summation + DCCF Duty Cycle Correction Factor : +0.09 dB	Limit	Margin
	Port(s) (dBm/3KHz)						
MHz	a	b	c	d	dBm/3KHz	dBm/3KHz	dB
2412.0	-20.738	-17.520	--	--	-15.794	8.0	-23.8
2437.0	-17.179	-15.966	--	--	-13.866	8.0	-21.9
2462.0	-19.961	-18.039	--	--	-16.132	8.0	-24.1

Traceability to Industry Recognized Test Methodologies

Work Instruction:	WI-03 MEASURING RF SPECTRUM MASK
Measurement Uncertainty:	±2.81 dB

Note: click the links in the above matrix to view the graphical image (plot).

Equipment Configuration for Power Spectral Density - Average

Variants:	2x2 802.11n HT-40	Duty Cycle (%):	98.0
Data Rate:	13.5 mbits	Antenna Gain (dBi):	2.00
Modulation:	OFDM	Beam Forming Gain (Y):	Not Applicable
TPC:	Not Applicable	Tested By:	AH
Engineering Test Notes:			

Test Measurement Results

Test Frequency	Measured Power Spectral Density				Amplitude Summation + DCCF Duty Cycle Correction Factor : +0.09 dB	Limit	Margin
	Port(s) (dBm/3KHz)						
MHz	a	b	c	d	dBm/3KHz	dBm/3KHz	dB
2422.0	-23.917	-22.367	--	--	-20.198	8.0	-28.2
2437.0	-21.874	-20.908	--	--	-18.710	8.0	-26.7
2452.0	-23.331	-21.023	--	--	-18.997	8.0	-27.0

Traceability to Industry Recognized Test Methodologies

Work Instruction:	WI-03 MEASURING RF SPECTRUM MASK
Measurement Uncertainty:	±2.81 dB

Note: click the links in the above matrix to view the graphical image (plot).

This test report may be reproduced in full only. The document may only be updated by MiCOM Labs personnel. Any changes will be noted in the Document History section of the report.



Title: Xirrus Inc. XI-AC1300, XI-AC867
To: FCC 47 CFR Part 15.247 & IC RSS-210
Serial #: XIRR04-U3 Rev A
Issue Date: 29th April 2014
Page: 67 of 572

Equipment Configuration for Power Spectral Density - Average

Variant:	2x2 802.11a	Duty Cycle (%):	98.0
Data Rate:	6 mbits	Antenna Gain (dBi):	2.00
Modulation:	OFDM	Beam Forming Gain (Y):	Not Applicable
TPC:	Not Applicable	Tested By:	AH
Engineering Test Notes:			

Test Measurement Results

Test Frequency	Measured Power Spectral Density				Amplitude Summation + DCCF Duty Cycle Correction Factor : +0.09 dB	Limit	Margin
	Port(s) (dBm/3KHz)						
MHz	a	b	c	d	dBm/3KHz	dBm/3KHz	dB
5745.0	-17.386	-17.936	--	--	-14.940	8.0	-23.0
5785.0	-17.050	-17.160	--	--	-14.635	8.0	-22.6
5825.0	-17.310	-17.050	--	--	-14.536	8.0	-22.5

Traceability to Industry Recognized Test Methodologies

Work Instruction:	WI-03 MEASURING RF SPECTRUM MASK
Measurement Uncertainty:	±2.81 dB

Note: click the links in the above matrix to view the graphical image (plot).

Equipment Configuration for Power Spectral Density - Average

Variant:	2x2 802.11ac-80	Duty Cycle (%):	98.0
Data Rate:	29.3 mbits	Antenna Gain (dBi):	2.00
Modulation:	OFDM	Beam Forming Gain (Y):	Not Applicable
TPC:	Not Applicable	Tested By:	AH
Engineering Test Notes:			

Test Measurement Results

Test Frequency	Measured Power Spectral Density				Amplitude Summation + DCCF Duty Cycle Correction Factor : +0.09 dB	Limit	Margin
	Port(s) (dBm/3KHz)						
MHz	a	b	c	d	dBm/3KHz	dBm/3KHz	dB
5775.0	-26.268	-26.322	--	--	-23.250	8.0	-31.3

Traceability to Industry Recognized Test Methodologies

Work Instruction:	WI-03 MEASURING RF SPECTRUM MASK
Measurement Uncertainty:	±2.81 dB

Note: click the links in the above matrix to view the graphical image (plot).

This test report may be reproduced in full only. The document may only be updated by MiCOM Labs personnel. Any changes will be noted in the Document History section of the report.



Title: Xirrus Inc. XI-AC1300, XI-AC867
To: FCC 47 CFR Part 15.247 & IC RSS-210
Serial #: XIRR04-U3 Rev A
Issue Date: 29th April 2014
Page: 68 of 572

Equipment Configuration for Power Spectral Density - Average

Variant:	2x2 802.11n HT-20	Duty Cycle (%):	98.0
Data Rate:	6.5 mbits	Antenna Gain (dBi):	2.00
Modulation:	OFDM	Beam Forming Gain (Y):	Not Applicable
TPC:	Not Applicable	Tested By:	AH
Engineering Test Notes:			

Test Measurement Results

Test Frequency	Measured Power Spectral Density				Amplitude Summation + DCCF Duty Cycle Correction Factor : +0.09 dB	Limit	Margin
	Port(s) (dBm/3KHz)						
MHz	a	b	c	d	dBm/3KHz	dBm/3KHz	dB
5745.0	-17.579	-18.246	--	--	-15.127	8.0	-23.1
5785.0	-18.655	-19.561	--	--	-16.259	8.0	-24.3
5825.0	-18.438	-18.879	--	--	-15.973	8.0	-24.0

Traceability to Industry Recognized Test Methodologies

Work Instruction:	WI-03 MEASURING RF SPECTRUM MASK
Measurement Uncertainty:	±2.81 dB

Note: click the links in the above matrix to view the graphical image (plot).

Equipment Configuration for Power Spectral Density - Average

Variant:	2x2 802.11n HT-40	Duty Cycle (%):	98.0
Data Rate:	13.5 mbits	Antenna Gain (dBi):	2.00
Modulation:	OFDM	Beam Forming Gain (Y):	Not Applicable
TPC:	Not Applicable	Tested By:	AH
Engineering Test Notes:			

Test Measurement Results

Test Frequency	Measured Power Spectral Density				Amplitude Summation + DCCF Duty Cycle Correction Factor : +0.09 dB	Limit	Margin
	Port(s) (dBm/3KHz)						
MHz	a	b	c	d	dBm/3KHz	dBm/3KHz	dB
5755.0	-23.522	-22.782	--	--	-20.559	8.0	-28.6
5795.0	-23.483	-22.925	--	--	-20.375	8.0	-28.4

Traceability to Industry Recognized Test Methodologies

Work Instruction:	WI-03 MEASURING RF SPECTRUM MASK
Measurement Uncertainty:	±2.81 dB

Note: click the links in the above matrix to view the graphical image (plot).

This test report may be reproduced in full only. The document may only be updated by MiCOM Labs personnel. Any changes will be noted in the Document History section of the report.



Title: Xirrus Inc. XI-AC1300, XI-AC867
To: FCC 47 CFR Part 15.247 & IC RSS-210
Serial #: XIRR04-U3 Rev A
Issue Date: 29th April 2014
Page: 69 of 572

Specification
Peak Power Spectral Density Limits

§15.247(e) For digitally modulated systems, the power spectral density conducted from the intentional radiator to the antenna shall not be greater than +8 dBm in any 3 kHz band during any time interval of continuous transmission

RSS-210 §A8.2(2) The transmitter power spectral density (into the antenna) shall not be greater than +8 dBm in any 3 kHz band during any time interval of continuous transmission or over 1.0 second if the transmission exceeds 1.0 second duration.

Traceability

Method	Test Equipment Used
Measurements were made per work instruction WI-01 'Measuring RF Output Power'	0158, 0287, 0252, 0313, 0314, 0070, 0116, 0117

This test report may be reproduced in full only. The document may only be updated by MiCOM Labs personnel. Any changes will be noted in the Document History section of the report.



Title: Xirrus Inc. XI-AC1300, XI-AC867
To: FCC 47 CFR Part 15.247 & IC RSS-210
Serial #: XIRR04-U3 Rev A
Issue Date: 29th April 2014
Page: 70 of 572

5.1.1.4. Conducted Spurious Emissions

Conducted Test Conditions for Transmitter Conducted Spurious and Band-Edge Emissions			
Standard:	FCC CFR 47:15.247	Ambient Temp. (°C):	24.0 - 27.5
Test Heading:	Max Unwanted Emission Levels	Rel. Humidity (%):	32 - 45
Standard Section(s):	15.247 (d)	Pressure (mBars):	999 - 1001
Reference Document(s):	KDB 558074 - D01 DTS Measurement Guidance v01: Section 5.4 Maximum Unwanted Emission Levels		
Test Procedure for Transmitter Conducted Spurious and Band-Edge Emissions Measurement Transmitter Conducted Spurious and Band-Edge emissions were measured at a limit of 20 dB below the highest in-band spectral density measured with a spectrum analyzer connected to the antenna terminal. Measurements were made while EUT was operating in transmit mode of operation at the appropriate centre frequency closest to the band-edge. Emissions were maximized during the measurement and limits derived from the peak spectral power and drawn on each plot.			

This test report may be reproduced in full only. The document may only be updated by MiCOM Labs personnel. Any changes will be noted in the Document History section of the report.



Title: Xirrus Inc. XI-AC1300, XI-AC867
To: FCC 47 CFR Part 15.247 & IC RSS-210
Serial #: XIRR04-U3 Rev A
Issue Date: 29th April 2014
Page: 71 of 572

XI-AC1300 3x3 Operation

Equipment Configuration for Conducted Low Band-Edge Emissions - Average

Variant:	3x3 802.11b	Duty Cycle (%):	99
Data Rate:	1 MBit/s	Antenna Gain (dBi):	Not Applicable
Modulation:	CCK	Beam Forming Gain (Y):	Not Applicable
TPC:	Not Applicable	Tested By:	GMH
Engineering Test Notes:	Test setup: 6" SMA pigtailed soldered onto the pcb. Loss of pigtail not considered.		

Test Measurement Results

Channel Frequency:	2412.0 MHz					
Band-Edge Frequency:	2400.0 MHz					
Test Frequency Range:	2350.0 - 2422.0 MHz					
Port(s)	Band-Edge Markers and Limit			Amended Limit		Margin (MHz)
	M1 Amplitude (dBm)	Plot Limit (dBm)	M2 Frequency (MHz)	Amplitude (dBm)	M2A Frequency (MHz)	
a	-40.38	-27.17	2403.20			-13.21
b	-39.78	-26.46	2403.10			-13.32
c	-40.18	-27.82	2403.10			-12.36

Traceability to Industry Recognized Test Methodologies

Work Instruction:	WI-05 MEASUREMENT OF SPURIOUS EMISSIONS
Measurement Uncertainty:	≤40 GHz ±2.37 dB, > 40 GHz ±4.6 dB

Note: click the links in the above matrix to view the graphical image (plot).

Equipment Configuration for Conducted High Band-Edge Emissions - Average

Variant:	3x3 802.11b	Duty Cycle (%):	99
Data Rate:	1 MBit/s	Antenna Gain (dBi):	Not Applicable
Modulation:	CCK	Beam Forming Gain (Y):	Not Applicable
TPC:	Not Applicable	Tested By:	GMH
Engineering Test Notes:	Test setup: 6" SMA pigtailed soldered onto the pcb. Loss of pigtail not considered		

Test Measurement Results

Channel Frequency:	2462.0 MHz					
Band-Edge Frequency:	2483.5 MHz					
Test Frequency Range:	2452.0 - 2524.0 MHz					
Port(s)	Band-Edge Markers and Limit			Amended Limit		Margin (MHz)
	M3 Amplitude (dBm)	Plot Limit (dBm)	M2 Frequency (MHz)	Amplitude (dBm)	M2A Frequency (MHz)	
a	-51.84	-28.18	2470.90	--	--	-12.600
b	-47.82	-26.89	2471.00	--	--	-12.500
c	-52.39	-29.14	2470.80	--	--	-12.700

Traceability to Industry Recognized Test Methodologies

Work Instruction:	WI-05 MEASUREMENT OF SPURIOUS EMISSIONS
Measurement Uncertainty:	≤40 GHz ±2.37 dB, > 40 GHz ±4.6 dB

Note: click the links in the above matrix to view the graphical image (plot).

This test report may be reproduced in full only. The document may only be updated by MiCOM Labs personnel. Any changes will be noted in the Document History section of the report.



Title: Xirrus Inc. XI-AC1300, XI-AC867
To: FCC 47 CFR Part 15.247 & IC RSS-210
Serial #: XIRR04-U3 Rev A
Issue Date: 29th April 2014
Page: 72 of 572

Equipment Configuration for Transmitter Conducted Spurious Emissions

Variant:	3x3 802.11b	Duty Cycle (%):	99
Data Rate:	1 MBit/s	Antenna Gain (dBi):	Not Applicable
Modulation:	CCK	Beam Forming Gain (Y):	Not Applicable
TPC:	Not Applicable	Tested By:	GMH
Engineering Test Notes:	Test setup: 6" SMA pigtailed soldered onto the pcb. Loss of pigtail not considered		

Test Measurement Results

Test Frequency	Frequency Range	Transmitter Conducted Spurious Emissions (dBm)							
		Port a		Port b		Port c		Port d	
MHz	MHz	SE	Limit	SE	Limit	SE	Limit	SE	Limit
2412.0	30.0 - 26000.0	-66.480	-44.31	-66.480	-43.39	-66.480	-44.66	--	--
2437.0	30.0 - 26000.0	-66.480	-44.54	-66.480	-43.40	-66.480	-45.42	--	--
2462.0	30.0 - 26000.0	-66.480	-45.15	-66.480	-43.84	-67.504	-46.52	--	--

Traceability to Industry Recognized Test Methodologies

Work Instruction:	WI-05 MEASUREMENT OF SPURIOUS EMISSIONS
Measurement Uncertainty:	≤40 GHz ±2.37 dB, > 40 GHz ±4.6 dB

Note: click the links in the above matrix to view the graphical image (plot).

This test report may be reproduced in full only. The document may only be updated by MiCOM Labs personnel. Any changes will be noted in the Document History section of the report.



Title: Xirrus Inc. XI-AC1300, XI-AC867
To: FCC 47 CFR Part 15.247 & IC RSS-210
Serial #: XIRR04-U3 Rev A
Issue Date: 29th April 2014
Page: 73 of 572

Equipment Configuration for Conducted Low Band-Edge Emissions - Average

Variant:	3x3 802.11g	Duty Cycle (%):	95
Data Rate:	6 MBit/s	Antenna Gain (dBi):	Not Applicable
Modulation:	OFDM	Beam Forming Gain (Y):	Not Applicable
TPC:	Not Applicable	Tested By:	GMH
Engineering Test Notes:	Test setup: 6" SMA pigtailed soldered onto the pcb. Loss of pigtail not considered. Limit for Band-Edge conducted emissions was found to be 802.11b 2412 MHz Port b = -26.46 dBm		

Test Measurement Results

Channel Frequency:	2412.0 MHz					
Band-Edge Frequency:	2400.0 MHz					
Test Frequency Range:	2350.0 - 2422.0 MHz					
Port(s)	Band-Edge Markers and Limit			Amended Limit		Margin (MHz)
	M1 Amplitude (dBm)	Plot Limit (dBm)	M2 Frequency (MHz)	Amplitude (dBm)	M2A Frequency (MHz)	
a	-33.65	-26.46	2402.50			-7.19
b	-32.68	-26.46	2402.20			-6.22
c	-34.24	-26.46	2402.80			-7.78

Traceability to Industry Recognized Test Methodologies

Work Instruction:	WI-05 MEASUREMENT OF SPURIOUS EMISSIONS
Measurement Uncertainty:	≤40 GHz ±2.37 dB, > 40 GHz ±4.6 dB

Note: click the links in the above matrix to view the graphical image (plot).

Per communication with the FCC the limit for Conducted Band-Edge Emissions can be increased to the highest limit observed for any operational mode in the same frequency band. The highest limit found was 802.11b 2412 MHz @ -26.46 dBm. This limit was used to determine compliance.

Equipment Configuration for Conducted High Band-Edge Emissions - Average

Variant:	3x3 802.11g	Duty Cycle (%):	95
Data Rate:	6 MBit/s	Antenna Gain (dBi):	Not Applicable
Modulation:	OFDM	Beam Forming Gain (Y):	Not Applicable
TPC:	Not Applicable	Tested By:	GMH
Engineering Test Notes:	Test setup: 6" SMA pigtailed soldered onto the pcb. Loss of pigtail not considered.		

Test Measurement Results

Channel Frequency:	2462.0 MHz					
Band-Edge Frequency:	2483.5 MHz					
Test Frequency Range:	2452.0 - 2524.0 MHz					
Port(s)	Band-Edge Markers and Limit			Amended Limit		Margin (MHz)
	M3 Amplitude (dBm)	Plot Limit (dBm)	M2 Frequency (MHz)	Amplitude (dBm)	M2A Frequency (MHz)	
a	-48.32	-34.07	2474.90	--	--	-8.600
b	-44.72	-32.92	2475.80	--	--	-7.700
c	-50.06	-35.54	2475.20	--	--	-8.300

Traceability to Industry Recognized Test Methodologies

Work Instruction:	WI-05 MEASUREMENT OF SPURIOUS EMISSIONS
Measurement Uncertainty:	≤40 GHz ±2.37 dB, > 40 GHz ±4.6 dB

Note: click the links in the above matrix to view the graphical image (plot).

This test report may be reproduced in full only. The document may only be updated by MiCOM Labs personnel. Any changes will be noted in the Document History section of the report.



Title: Xirrus Inc. XI-AC1300, XI-AC867
To: FCC 47 CFR Part 15.247 & IC RSS-210
Serial #: XIRR04-U3 Rev A
Issue Date: 29th April 2014
Page: 74 of 572

Equipment Configuration for Transmitter Conducted Spurious Emissions

Variant:	3x3 802.11g	Duty Cycle (%):	95
Data Rate:	6 MBit/s	Antenna Gain (dBi):	Not Applicable
Modulation:	OFDM	Beam Forming Gain (Y):	Not Applicable
TPC:	Not Applicable	Tested By:	GMH
Engineering Test Notes:	Test setup: 6" SMA pigtailed soldered onto the pcb. Loss of pigtail not considered.		

Test Measurement Results

Test Frequency	Frequency Range	Transmitter Conducted Spurious Emissions (dBm)							
		Port a		Port b		Port c		Port d	
MHz	MHz	SE	Limit	SE	Limit	SE	Limit	SE	Limit
2412.0	30.0 - 26000.0	-66.480	-45.89	-66.480	-44.93	-66.480	-46.52	--	--
2437.0	30.0 - 26000.0	-66.480	-42.24	-66.480	-42.63	-66.480	-42.94	--	--
2462.0	30.0 - 26000.0	-66.480	-45.46	-66.480	-44.17	-67.504	-46.90	--	--

Traceability to Industry Recognized Test Methodologies

Work Instruction:	WI-05 MEASUREMENT OF SPURIOUS EMISSIONS
Measurement Uncertainty:	≤40 GHz ±2.37 dB, > 40 GHz ±4.6 dB

Note: click the links in the above matrix to view the graphical image (plot).

This test report may be reproduced in full only. The document may only be updated by MiCOM Labs personnel. Any changes will be noted in the Document History section of the report.



Title: Xirrus Inc. XI-AC1300, XI-AC867
To: FCC 47 CFR Part 15.247 & IC RSS-210
Serial #: XIRR04-U3 Rev A
Issue Date: 29th April 2014
Page: 75 of 572

Equipment Configuration for Conducted Low Band-Edge Emissions - Average

Variant:	3x3 802.11n HT-20	Duty Cycle (%):	94
Data Rate:	6.5 MBit/s	Antenna Gain (dBi):	Not Applicable
Modulation:	OFDM	Beam Forming Gain (Y):	Not Applicable
TPC:	Not Applicable	Tested By:	GMH
Engineering Test Notes:	Test setup: 6" SMA pigtailed soldered onto the pcb. Loss of pigtail not considered. Loss of pigtail not considered. Limit for Band-Edge conducted emissions was found to be 802.11b 2412 MHz Port b = -26.46 dBm		

Test Measurement Results

Channel Frequency:	2412.0 MHz					
Band-Edge Frequency:	2400.0 MHz					
Test Frequency Range:	2350.0 - 2422.0 MHz					
Port(s)	Band-Edge Markers and Limit			Amended Limit		Margin (MHz)
	M1 Amplitude (dBm)	Plot Limit (dBm)	M2 Frequency (MHz)	Amplitude (dBm)	M2A Frequency (MHz)	
a	-33.73	-26.46	2402.10	--	--	-7.27
b	-32.05	-26.46	2401.80	--	--	-5.59
c	-33.68	-26.46	2402.20	--	--	-7.22

Traceability to Industry Recognized Test Methodologies

Work Instruction:	WI-05 MEASUREMENT OF SPURIOUS EMISSIONS
Measurement Uncertainty:	≤40 GHz ±2.37 dB, > 40 GHz ±4.6 dB

Note: click the links in the above matrix to view the graphical image (plot).

Per communication with the FCC the limit for Conducted Band-Edge Emissions can be increased to the highest limit observed for any operational mode in the same frequency band. The highest limit found was 802.11b 2412 MHz @ -26.46 dBm. This limit was used to determine compliance.

Equipment Configuration for Conducted High Band-Edge Emissions - Average

Variant:	3x3 802.11n HT-20	Duty Cycle (%):	94
Data Rate:	6.5 MBit/s	Antenna Gain (dBi):	Not Applicable
Modulation:	OFDM	Beam Forming Gain (Y):	Not Applicable
TPC:	Not Applicable	Tested By:	GMH
Engineering Test Notes:	Test setup: 6" SMA pigtailed soldered onto the pcb. Loss of pigtail not considered.		

Test Measurement Results

Channel Frequency:	2462.0 MHz					
Band-Edge Frequency:	2483.5 MHz					
Test Frequency Range:	2452.0 - 2524.0 MHz					
Port(s)	Band-Edge Markers and Limit			Amended Limit		Margin (MHz)
	M3 Amplitude (dBm)	Plot Limit (dBm)	M2 Frequency (MHz)	Amplitude (dBm)	M2A Frequency (MHz)	
a	-47.53	-34.29	2475.20	--	--	-8.300
b	-44.44	-33.34	2475.80	--	--	-7.700
c	-50.58	-35.92	2475.20	--	--	-8.300

Traceability to Industry Recognized Test Methodologies

Work Instruction:	WI-05 MEASUREMENT OF SPURIOUS EMISSIONS
Measurement Uncertainty:	≤40 GHz ±2.37 dB, > 40 GHz ±4.6 dB

Note: click the links in the above matrix to view the graphical image (plot).

This test report may be reproduced in full only. The document may only be updated by MiCOM Labs personnel. Any changes will be noted in the Document History section of the report.



Title: Xirrus Inc. XI-AC1300, XI-AC867
To: FCC 47 CFR Part 15.247 & IC RSS-210
Serial #: XIRR04-U3 Rev A
Issue Date: 29th April 2014
Page: 76 of 572

Equipment Configuration for Transmitter Conducted Spurious Emissions

Variant:	3x3 802.11n HT-20	Duty Cycle (%):	94
Data Rate:	6.5 MBit/s	Antenna Gain (dBi):	Not Applicable
Modulation:	OFDM	Beam Forming Gain (Y):	Not Applicable
TPC:	Not Applicable	Tested By:	GMH
Engineering Test Notes:	Test setup: 6" SMA pigtails soldered onto the pcb. Loss of pigtail not considered.		

Test Measurement Results

Test Frequency	Frequency Range	Transmitter Conducted Spurious Emissions (dBm)							
		Port a		Port b		Port c		Port d	
MHz	MHz	SE	Limit	SE	Limit	SE	Limit	SE	Limit
2412.0	30.0 - 26000.0	-66.480	-46.51	-66.480	-45.02	-66.480	-46.38	--	--
2437.0	30.0 - 26000.0	-66.480	-42.01	-66.480	-40.92	-66.480	-42.87	--	--
2462.0	30.0 - 26000.0	-66.480	-44.94	-66.480	-43.97	-67.504	-46.53	--	--

Traceability to Industry Recognized Test Methodologies

Work Instruction:	WI-05 MEASUREMENT OF SPURIOUS EMISSIONS
Measurement Uncertainty:	≤40 GHz ±2.37 dB, > 40 GHz ±4.6 dB

Note: click the links in the above matrix to view the graphical image (plot).

This test report may be reproduced in full only. The document may only be updated by MiCOM Labs personnel. Any changes will be noted in the Document History section of the report.



Title: Xirrus Inc. XI-AC1300, XI-AC867
To: FCC 47 CFR Part 15.247 & IC RSS-210
Serial #: XIRR04-U3 Rev A
Issue Date: 29th April 2014
Page: 77 of 572

Equipment Configuration for Conducted Low Band-Edge Emissions - Average

Variant:	3x3 802.11n HT-40	Duty Cycle (%):	94
Data Rate:	13.5 MBit/s	Antenna Gain (dBi):	Not Applicable
Modulation:	OFDM	Beam Forming Gain (Y):	Not Applicable
TPC:	Not Applicable	Tested By:	GMH
Engineering Test Notes:	Test setup: 6" SMA pigtailed soldered onto the pcb. Loss of pigtail not considered. Limit for Band-Edge conducted emissions was found to be 802.11b 2412 MHz Port b = -26.46 dBm		

Test Measurement Results

Channel Frequency:	2422.0 MHz					
Band-Edge Frequency:	2400.0 MHz					
Test Frequency Range:	2292.0 - 2442.0 MHz					
Port(s)	Band-Edge Markers and Limit			Amended Limit		Margin (MHz)
	M1 Amplitude (dBm)	Plot Limit (dBm)	M2 Frequency (MHz)	Amplitude (dBm)	M2A Frequency (MHz)	
a	-32.29	-26.46	2403.20	--	--	-5.83
b	-32.90	-26.46	2402.90	--	--	-6.44
c	-33.43	-26.46	2403.20	--	--	-6.97

Traceability to Industry Recognized Test Methodologies

Work Instruction:	WI-05 MEASUREMENT OF SPURIOUS EMISSIONS
Measurement Uncertainty:	≤40 GHz ±2.37 dB, > 40 GHz ±4.6 dB

Note: click the links in the above matrix to view the graphical image (plot).

Per communication with the FCC the limit for Conducted Band-Edge Emissions can be increased to the highest limit observed for any operational mode in the same frequency band. The highest limit found was 802.11b 2412 MHz @ -26.46 dBm. This limit was used to determine compliance.

Equipment Configuration for Conducted High Band-Edge Emissions - Average

Variant:	3x3 802.11n HT-40	Duty Cycle (%):	94
Data Rate:	13.5 MBit/s	Antenna Gain (dBi):	Not Applicable
Modulation:	OFDM	Beam Forming Gain (Y):	Not Applicable
TPC:	Not Applicable	Tested By:	GMH
Engineering Test Notes:	Test setup: 6" SMA pigtailed soldered onto the pcb. Loss of pigtail not considered.		

Test Measurement Results

Channel Frequency:	2452.0 MHz					
Band-Edge Frequency:	2483.5 MHz					
Test Frequency Range:	2432.0 - 2582.0 MHz					
Port(s)	Band-Edge Markers and Limit			Amended Limit		Margin (MHz)
	M3 Amplitude (dBm)	Plot Limit (dBm)	M2 Frequency (MHz)	Amplitude (dBm)	M2A Frequency (MHz)	
a	-42.94	-38.60	2478.60	--	--	-4.900
b	-39.95	-37.47	2480.70	--	--	-2.800
c	-44.84	-39.74	2478.60	--	--	-4.900

Traceability to Industry Recognized Test Methodologies

Work Instruction:	WI-05 MEASUREMENT OF SPURIOUS EMISSIONS
Measurement Uncertainty:	≤40 GHz ±2.37 dB, > 40 GHz ±4.6 dB

Note: click the links in the above matrix to view the graphical image (plot).

This test report may be reproduced in full only. The document may only be updated by MiCOM Labs personnel. Any changes will be noted in the Document History section of the report.



Title: Xirrus Inc. XI-AC1300, XI-AC867
To: FCC 47 CFR Part 15.247 & IC RSS-210
Serial #: XIRR04-U3 Rev A
Issue Date: 29th April 2014
Page: 78 of 572

Equipment Configuration for Transmitter Conducted Spurious Emissions

Variant:	3x3 802.11n HT-40	Duty Cycle (%):	94
Data Rate:	13.5 MBit/s	Antenna Gain (dBi):	Not Applicable
Modulation:	OFDM	Beam Forming Gain (Y):	Not Applicable
TPC:	Not Applicable	Tested By:	GMH
Engineering Test Notes:	Test setup: 6" SMA pigtailed soldered onto the pcb. Loss of pigtail not considered.		

Test Measurement Results

Test Frequency	Frequency Range	Transmitter Conducted Spurious Emissions (dBm)							
		Port a		Port b		Port c		Port d	
MHz	MHz	SE	Limit	SE	Limit	SE	Limit	SE	Limit
2422.0	30.0 - 26000.0	-66.480	-47.05	-66.480	-45.89	-66.480	-47.64	--	--
2437.0	30.0 - 26000.0	-66.480	-41.05	-66.480	-40.21	-66.480	-42.58	--	--
2452.0	30.0 - 26000.0	-66.480	-42.45	-66.480	-41.60	-67.504	-44.36	--	--

Traceability to Industry Recognized Test Methodologies

Work Instruction:	WI-05 MEASUREMENT OF SPURIOUS EMISSIONS
Measurement Uncertainty:	≤40 GHz ±2.37 dB, > 40 GHz ±4.6 dB

Note: click the links in the above matrix to view the graphical image (plot).

This test report may be reproduced in full only. The document may only be updated by MiCOM Labs personnel. Any changes will be noted in the Document History section of the report.



Title: Xirrus Inc. XI-AC1300, XI-AC867
To: FCC 47 CFR Part 15.247 & IC RSS-210
Serial #: XIRR04-U3 Rev A
Issue Date: 29th April 2014
Page: 79 of 572

Equipment Configuration for Low Conducted Band-Edge Emissions - Average

Variant:	3x3 802.11a	Duty Cycle (%):	94
Data Rate:	6 MBit/s	Antenna Gain (dBi):	Not Applicable
Modulation:	OFDM	Beam Forming Gain (Y):	Not Applicable
TPC:	Not Applicable	Tested By:	GMH
Engineering Test Notes:	Test setup: 6" SMA pigtailed soldered onto the pcb. Loss of pigtail not considered.		

Test Measurement Results

Channel Frequency:	5745.0 MHz					
Band-Edge Frequency:	5725.0 MHz					
Test Frequency Range:	5683.0 - 5755.0 MHz					
Port(s)	Band-Edge Markers and Limit			Amended Limit		Margin (MHz)
	M1 Amplitude (dBm)	Plot Limit (dBm)	M2 Frequency (MHz)	Amplitude (dBm)	M2A Frequency (MHz)	
a	-49.68	-33.64	5732.80			-16.04
b	-47.04	-33.25	5731.80			-13.79
c	-51.37	-33.87	5732.30			-17.50

Traceability to Industry Recognized Test Methodologies

Work Instruction:	WI-05 MEASUREMENT OF SPURIOUS EMISSIONS
Measurement Uncertainty:	≤40 GHz ±2.37 dB, > 40 GHz ±4.6 dB

Note: click the links in the above matrix to view the graphical image (plot).

Equipment Configuration for Conducted High Band-Edge Emissions - Average

Variant:	3x3 802.11a	Duty Cycle (%):	94
Data Rate:	6 MBit/s	Antenna Gain (dBi):	Not Applicable
Modulation:	OFDM	Beam Forming Gain (Y):	Not Applicable
TPC:	Not Applicable	Tested By:	GMH
Engineering Test Notes:	Test setup: 6" SMA pigtailed soldered onto the pcb. Loss of pigtail not considered.		

Test Measurement Results

Channel Frequency:	5825.0 MHz					
Band-Edge Frequency:	5850.0 MHz					
Test Frequency Range:	5815.0 - 5887.0 MHz					
Port(s)	Band-Edge Markers and Limit			Amended Limit		Margin (MHz)
	M3 Amplitude (dBm)	Plot Limit (dBm)	M2 Frequency (MHz)	Amplitude (dBm)	M2A Frequency (MHz)	
a	-48.89	-33.49	5837.70	--	--	-12.300
b	-56.59	-33.45	5837.90	--	--	-12.100
c	-57.39	-33.93	5837.40	--	--	-12.600

Traceability to Industry Recognized Test Methodologies

Work Instruction:	WI-05 MEASUREMENT OF SPURIOUS EMISSIONS
Measurement Uncertainty:	≤40 GHz ±2.37 dB, > 40 GHz ±4.6 dB

Note: click the links in the above matrix to view the graphical image (plot).

This test report may be reproduced in full only. The document may only be updated by MiCOM Labs personnel. Any changes will be noted in the Document History section of the report.



Title: Xirrus Inc. XI-AC1300, XI-AC867
To: FCC 47 CFR Part 15.247 & IC RSS-210
Serial #: XIRR04-U3 Rev A
Issue Date: 29th April 2014
Page: 80 of 572

Equipment Configuration for Transmitter Conducted Spurious Emissions

Variant:	3x3 802.11a	Duty Cycle (%):	94
Data Rate:	6 MBit/s	Antenna Gain (dBi):	Not Applicable
Modulation:	OFDM	Beam Forming Gain (Y):	Not Applicable
TPC:	Not Applicable	Tested By:	GMH
Engineering Test Notes:	Test setup: 6" SMA pigtailed soldered onto the pcb. Loss of pigtail not considered.		

Test Measurement Results

Test Frequency	Frequency Range	Transmitter Conducted Spurious Emissions (dBm)							
		Port a		Port b		Port c		Port d	
MHz	MHz	SE	Limit	SE	Limit	SE	Limit	SE	Limit
5745.0	30.0 - 26000.0	-59.121	-49.53	-57.266	-48.49	-56.938	-49.30	--	--
5785.0	30.0 - 26000.0	-59.121	-44.62	-55.462	-44.16	-56.938	-44.81	--	--
5825.0	30.0 - 26000.0	-56.938	-44.86	-55.195	-43.85	-56.938	-44.95	--	--

Traceability to Industry Recognized Test Methodologies

Work Instruction:	WI-05 MEASUREMENT OF SPURIOUS EMISSIONS
Measurement Uncertainty:	≤40 GHz ±2.37 dB, > 40 GHz ±4.6 dB

Note: click the links in the above matrix to view the graphical image (plot).

This test report may be reproduced in full only. The document may only be updated by MiCOM Labs personnel. Any changes will be noted in the Document History section of the report.



Title: Xirrus Inc. XI-AC1300, XI-AC867
To: FCC 47 CFR Part 15.247 & IC RSS-210
Serial #: XIRR04-U3 Rev A
Issue Date: 29th April 2014
Page: 81 of 572

Equipment Configuration for Low Conducted Low Band-Edge Emissions - Average

Variant:	3x3 802.11n HT-20	Duty Cycle (%):	94
Data Rate:	6.5 MBit/s	Antenna Gain (dBi):	Not Applicable
Modulation:	OFDM	Beam Forming Gain (Y):	Not Applicable
TPC:	Not Applicable	Tested By:	GMH
Engineering Test Notes:	Test setup: 6" SMA pigtailed soldered onto the pcb. Loss of pigtail not considered.		

Test Measurement Results

Channel Frequency:	5745.0 MHz					
Band-Edge Frequency:	5725.0 MHz					
Test Frequency Range:	5683.0 - 5755.0 MHz					
Port(s)	Band-Edge Markers and Limit			Amended Limit		Margin (MHz)
	M1 Amplitude (dBm)	Plot Limit (dBm)	M2 Frequency (MHz)	Amplitude (dBm)	M2A Frequency (MHz)	
a	-48.34	-34.19	5732.10	--	--	-14.15
b	-46.48	-33.74	5731.50	--	--	-12.74
c	-50.54	-34.76	5731.80	--	--	-15.78

Traceability to Industry Recognized Test Methodologies

Work Instruction:	WI-05 MEASUREMENT OF SPURIOUS EMISSIONS
Measurement Uncertainty:	≤40 GHz ±2.37 dB, > 40 GHz ±4.6 dB

Note: click the links in the above matrix to view the graphical image (plot).

Equipment Configuration for High Conducted High Band-Edge Emissions - Average

Variant:	3x3 802.11n HT-20	Duty Cycle (%):	94
Data Rate:	6.5 MBit/s	Antenna Gain (dBi):	Not Applicable
Modulation:	OFDM	Beam Forming Gain (Y):	Not Applicable
TPC:	Not Applicable	Tested By:	GMH
Engineering Test Notes:	Test setup: 6" SMA pigtailed soldered onto the pcb. Loss of pigtail not considered.		

Test Measurement Results

Channel Frequency:	5825.0 MHz					
Band-Edge Frequency:	5850.0 MHz					
Test Frequency Range:	5815.0 - 5887.0 MHz					
Port(s)	Band-Edge Markers and Limit			Amended Limit		Margin (MHz)
	M3 Amplitude (dBm)	Plot Limit (dBm)	M2 Frequency (MHz)	Amplitude (dBm)	M2A Frequency (MHz)	
a	-48.24	-34.28	5837.90	--	--	-12.100
b	-55.00	-33.78	5838.20	--	--	-11.800
c	-55.80	-34.65	5837.70	--	--	-12.300

Traceability to Industry Recognized Test Methodologies

Work Instruction:	WI-05 MEASUREMENT OF SPURIOUS EMISSIONS
Measurement Uncertainty:	≤40 GHz ±2.37 dB, > 40 GHz ±4.6 dB

Note: click the links in the above matrix to view the graphical image (plot).

This test report may be reproduced in full only. The document may only be updated by MiCOM Labs personnel. Any changes will be noted in the Document History section of the report.



Title: Xirrus Inc. XI-AC1300, XI-AC867
To: FCC 47 CFR Part 15.247 & IC RSS-210
Serial #: XIRR04-U3 Rev A
Issue Date: 29th April 2014
Page: 82 of 572

Equipment Configuration for Transmitter Conducted Spurious Emissions

Variant:	3x3 802.11n HT-20	Duty Cycle (%):	94
Data Rate:	6.5 MBit/s	Antenna Gain (dBi):	Not Applicable
Modulation:	OFDM	Beam Forming Gain (Y):	Not Applicable
TPC:	Not Applicable	Tested By:	GMH
Engineering Test Notes:	Test setup: 6" SMA pigtailed soldered onto the pcb. Loss of pigtail not considered.		

Test Measurement Results

Test Frequency	Frequency Range	Transmitter Conducted Spurious Emissions (dBm)							
		Port a		Port b		Port c		Port d	
MHz	MHz	SE	Limit	SE	Limit	SE	Limit	SE	Limit
5745.0	30.0 - 26000.0	-59.121	-49.64	-57.266	-48.50	-56.938	-49.52	--	--
5785.0	30.0 - 26000.0	-57.607	-45.12	-55.738	-44.09	-56.938	-44.80	--	--
5825.0	30.0 - 26000.0	-56.938	-44.92	-55.462	-44.00	-57.266	-44.66	--	--

Traceability to Industry Recognized Test Methodologies

Work Instruction:	WI-05 MEASUREMENT OF SPURIOUS EMISSIONS
Measurement Uncertainty:	≤40 GHz ±2.37 dB, > 40 GHz ±4.6 dB

Note: click the links in the above matrix to view the graphical image (plot).

This test report may be reproduced in full only. The document may only be updated by MiCOM Labs personnel. Any changes will be noted in the Document History section of the report.



Title: Xirrus Inc. XI-AC1300, XI-AC867
To: FCC 47 CFR Part 15.247 & IC RSS-210
Serial #: XIRR04-U3 Rev A
Issue Date: 29th April 2014
Page: 83 of 572

Equipment Configuration for Conducted Low Band-Edge Emissions - Average

Variant:	3x3 802.11n HT-40	Duty Cycle (%):	94
Data Rate:	13.5 MBit/s	Antenna Gain (dBi):	Not Applicable
Modulation:	OFDM	Beam Forming Gain (Y):	Not Applicable
TPC:	Not Applicable	Tested By:	GMH
Engineering Test Notes:	Test setup: 6" SMA pigtailed soldered onto the pcb. Loss of pigtail not considered.		

Test Measurement Results

Channel Frequency:	5755.0 MHz					
Band-Edge Frequency:	5725.0 MHz					
Test Frequency Range:	5625.0 - 5775.0 MHz					
Port(s)	Band-Edge Markers and Limit			Amended Limit		Margin (MHz)
	M1 Amplitude (dBm)	Plot Limit (dBm)	M2 Frequency (MHz)	Amplitude (dBm)	M2A Frequency (MHz)	
a	-42.87	-38.97	5727.80			-3.90
b	-41.52	-38.11	5728.10			-3.41
c	-44.82	-39.43	5729.30			-5.39

Traceability to Industry Recognized Test Methodologies	
Work Instruction:	WI-05 MEASUREMENT OF SPURIOUS EMISSIONS
Measurement Uncertainty:	=40 GHz ±2.37 dB, > 40 GHz □4.6 dB

Note: click the links in the above matrix to view the graphical image (plot).

Equipment Configuration for Conducted High Band-Edge Emissions - Average

Variant:	3x3 802.11n HT-40	Duty Cycle (%):	94
Data Rate:	13.5 MBit/s	Antenna Gain (dBi):	Not Applicable
Modulation:	OFDM	Beam Forming Gain (Y):	Not Applicable
TPC:	Not Applicable	Tested By:	GMH
Engineering Test Notes:	Test setup: 6" SMA pigtailed soldered onto the pcb. Loss of pigtail not considered.		

Test Measurement Results

Channel Frequency:	5795.0 MHz					
Band-Edge Frequency:	5850.0 MHz					
Test Frequency Range:	5775.0 - 5925.0 MHz					
Port(s)	Band-Edge Markers and Limit			Amended Limit		Margin (MHz)
	M3 Amplitude (dBm)	Plot Limit (dBm)	M2 Frequency (MHz)	Amplitude (dBm)	M2A Frequency (MHz)	
a	-48.89	-39.03	5820.70	--	--	-29.300
b	-58.42	-37.56	5821.30	--	--	-28.700
c	-59.22	-39.91	5820.40	--	--	-29.600

Traceability to Industry Recognized Test Methodologies	
Work Instruction:	WI-05 MEASUREMENT OF SPURIOUS EMISSIONS
Measurement Uncertainty:	≤40 GHz ±2.37 dB, > 40 GHz ±4.6 dB

Note: click the links in the above matrix to view the graphical image (plot).

This test report may be reproduced in full only. The document may only be updated by MiCOM Labs personnel. Any changes will be noted in the Document History section of the report.



Title: Xirrus Inc. XI-AC1300, XI-AC867
To: FCC 47 CFR Part 15.247 & IC RSS-210
Serial #: XIRR04-U3 Rev A
Issue Date: 29th April 2014
Page: 84 of 572

Equipment Configuration for Transmitter Conducted Spurious Emissions

Variant:	3x3 802.11n HT-40	Duty Cycle (%):	94
Data Rate:	13.5 MBit/s	Antenna Gain (dBi):	Not Applicable
Modulation:	OFDM	Beam Forming Gain (Y):	Not Applicable
TPC:	Not Applicable	Tested By:	GMH
Engineering Test Notes:	Test setup: 6" SMA pigtailed soldered onto the pcb. Loss of pigtail not considered.		

Test Measurement Results

Test Frequency	Frequency Range	Transmitter Conducted Spurious Emissions (dBm)							
		Port a		Port b		Port c		Port d	
MHz	MHz	SE	Limit	SE	Limit	SE	Limit	SE	Limit
5755.0	30.0 - 26000.0	-62.044	-45.40	-59.990	-44.12	-62.044	-45.45	--	--
5795.0	30.0 - 26000.0	-59.990	-48.90	-55.738	-46.90	-63.286	-49.46	--	--

Traceability to Industry Recognized Test Methodologies	
Work Instruction:	WI-05 MEASUREMENT OF SPURIOUS EMISSIONS
Measurement Uncertainty:	≤40 GHz ±2.37 dB, > 40 GHz ±4.6 dB

Note: click the links in the above matrix to view the graphical image (plot).

This test report may be reproduced in full only. The document may only be updated by MiCOM Labs personnel. Any changes will be noted in the Document History section of the report.



Title: Xirrus Inc. XI-AC1300, XI-AC867
To: FCC 47 CFR Part 15.247 & IC RSS-210
Serial #: XIRR04-U3 Rev A
Issue Date: 29th April 2014
Page: 85 of 572

Equipment Configuration for Conducted Low Band-Edge Emissions - Average

Variant:	3x3 802.11ac-40	Duty Cycle (%):	87
Data Rate:	13.5 MBit/s	Antenna Gain (dBi):	Not Applicable
Modulation:	OFDM	Beam Forming Gain (Y):	Not Applicable
TPC:	Not Applicable	Tested By:	GMH
Engineering Test Notes:	Test setup: 6" SMA pigtailed soldered onto the pcb. Loss of pigtail not considered.		

Test Measurement Results

Channel Frequency:	5755.0 MHz					
Band-Edge Frequency:	5725.0 MHz					
Test Frequency Range:	5625.0 - 5775.0 MHz					
Port(s)	Band-Edge Markers and Limit			Amended Limit		Margin (MHz)
	M1 Amplitude (dBm)	Plot Limit (dBm)	M2 Frequency (MHz)	Amplitude (dBm)	M2A Frequency (MHz)	
a	-42.54	-39.47	5728.10	--	--	-3.07
b	-41.52	-38.41	5727.50	--	--	-3.11
c	-44.82	-39.48	5729.30	--	--	-5.34

Traceability to Industry Recognized Test Methodologies

Work Instruction:	WI-05 MEASUREMENT OF SPURIOUS EMISSIONS
Measurement Uncertainty:	≤40 GHz ±2.37 dB, > 40 GHz ±4.6 dB

Note: click the links in the above matrix to view the graphical image (plot).

Equipment Configuration for Conducted High Band-Edge Emissions - Average

Variant:	3x3 802.11ac-40	Duty Cycle (%):	87
Data Rate:	13.5 MBit/s	Antenna Gain (dBi):	Not Applicable
Modulation:	OFDM	Beam Forming Gain (Y):	Not Applicable
TPC:	Not Applicable	Tested By:	GMH
Engineering Test Notes:	Test setup: 6" SMA pigtailed soldered onto the pcb. Loss of pigtail not considered.		

Test Measurement Results

Channel Frequency:	5795.0 MHz					
Band-Edge Frequency:	5850.0 MHz					
Test Frequency Range:	5775.0 - 5925.0 MHz					
Port(s)	Band-Edge Markers and Limit			Amended Limit		Margin (MHz)
	M3 Amplitude (dBm)	Plot Limit (dBm)	M2 Frequency (MHz)	Amplitude (dBm)	M2A Frequency (MHz)	
a	-48.89	-39.14	5821.30	--	--	-28.700
b	-58.42	-37.23	5821.30	--	--	-28.700
c	-59.22	-40.00	5820.40	--	--	-29.600

Traceability to Industry Recognized Test Methodologies

Work Instruction:	WI-05 MEASUREMENT OF SPURIOUS EMISSIONS
Measurement Uncertainty:	≤40 GHz ±2.37 dB, > 40 GHz ±4.6 dB

Note: click the links in the above matrix to view the graphical image (plot).

This test report may be reproduced in full only. The document may only be updated by MiCOM Labs personnel. Any changes will be noted in the Document History section of the report.



Title: Xirrus Inc. XI-AC1300, XI-AC867
To: FCC 47 CFR Part 15.247 & IC RSS-210
Serial #: XIRR04-U3 Rev A
Issue Date: 29th April 2014
Page: 86 of 572

Equipment Configuration for Transmitter Conducted Spurious Emissions

Variant:	3x3 802.11ac-40	Duty Cycle (%):	87
Data Rate:	13.5 MBit/s	Antenna Gain (dBi):	Not Applicable
Modulation:	OFDM	Beam Forming Gain (Y):	Not Applicable
TPC:	Not Applicable	Tested By:	GMH
Engineering Test Notes:	Test setup: 6" SMA pigtailed soldered onto the pcb. Loss of pigtail not considered.		

Test Measurement Results

Test Frequency	Frequency Range	Transmitter Conducted Spurious Emissions (dBm)							
		Port a		Port b		Port c		Port d	
MHz	MHz	SE	Limit	SE	Limit	SE	Limit	SE	Limit
5755.0	30.0 - 26000.0	-62.044	-45.50	-60.956	-44.02	-63.286	-45.51	--	--
5795.0	30.0 - 26000.0	-59.990	-48.81	-55.738	-46.71	-63.286	-49.32	--	--

Traceability to Industry Recognized Test Methodologies

Work Instruction:	WI-05 MEASUREMENT OF SPURIOUS EMISSIONS
Measurement Uncertainty:	≤40 GHz ±2.37 dB, > 40 GHz ±4.6 dB

Note: click the links in the above matrix to view the graphical image (plot).

This test report may be reproduced in full only. The document may only be updated by MiCOM Labs personnel. Any changes will be noted in the Document History section of the report.



Title: Xirrus Inc. XI-AC1300, XI-AC867
To: FCC 47 CFR Part 15.247 & IC RSS-210
Serial #: XIRR04-U3 Rev A
Issue Date: 29th April 2014
Page: 87 of 572

Equipment Configuration for Conducted Low and High Band-Edge Emissions - Average

Variant:	3x3 802.11ac-80	Duty Cycle (%):	76
Data Rate:	29.3 MBit/s	Antenna Gain (dBi):	Not Applicable
Modulation:	OFDM	Beam Forming Gain (Y):	Not Applicable
TPC:	Not Applicable	Tested By:	GMH
Engineering Test Notes:	Test setup: 6" SMA pigtailed soldered onto the pcb. Loss of pigtail not considered. Limit for Band-Edge conducted emissions was found to be 802.11a 5825 MHz @ -33.45 dBm		

Test Measurement Results

Channel Frequency:	5775.0 MHz					
Band-Edge Frequency:	5725.0 MHz					
Test Frequency Range:	5600.0 - 5900.0 MHz					
Port(s)	Band-Edge Markers and Limit			Amended Limit		Margin (MHz)
	M1 Amplitude (dBm)	Plot Limit (dBm)	M2 Frequency (MHz)	Amplitude (dBm)	M2A Frequency (MHz)	
a	-43.561	-33.45	5735.90	--	--	-10.11
b	-41.738	-33.45	5732.90	--	--	-8.29
c	-43.661	-33.45	5735.90	--	--	-10.21

Traceability to Industry Recognized Test Methodologies

Work Instruction:	WI-05 MEASUREMENT OF SPURIOUS EMISSIONS
Measurement Uncertainty:	≤40 GHz ±2.37 dB, > 40 GHz ±4.6 dB

Note: click the links in the above matrix to view the graphical image (plot).

Per communication with the FCC the limit for Band-Edge 5755 MHz "Port a" can be increased to the highest limit observed for any operational mode in the same frequency band. The highest limit found was 802.11a 5825 MHz @ -33.45 dBm which was used to determine compliance.

Equipment Configuration for Transmitter Conducted Spurious Emissions

Variant:	3x3 802.11ac-80	Duty Cycle (%):	76
Data Rate:	29.3 MBit/s	Antenna Gain (dBi):	Not Applicable
Modulation:	OFDM	Beam Forming Gain (Y):	Not Applicable
TPC:	Not Applicable	Tested By:	GMH
Engineering Test Notes:	Test setup: 6" SMA pigtailed soldered onto the pcb. Loss of pigtail not considered.		

Test Measurement Results

Test Frequency (MHz)	Frequency Range (MHz)	Transmitter Conducted Spurious Emissions (dBm)							
		Port a		Port b		Port c		Port d	
		SE	Limit	SE	Limit	SE	Limit	SE	Limit
5775.0	30.0 - 26000.0	-60.956	-44.92	-56.622	-43.17	-63.286	-45.17	--	--

Traceability to Industry Recognized Test Methodologies

Work Instruction:	WI-05 MEASUREMENT OF SPURIOUS EMISSIONS
Measurement Uncertainty:	≤40 GHz ±2.37 dB, > 40 GHz ±4.6 dB

Note: click the links in the above matrix to view the graphical image (plot).

This test report may be reproduced in full only. The document may only be updated by MiCOM Labs personnel. Any changes will be noted in the Document History section of the report.



Title: Xirrus Inc. XI-AC1300, XI-AC867
To: FCC 47 CFR Part 15.247 & IC RSS-210
Serial #: XIRR04-U3 Rev A
Issue Date: 29th April 2014
Page: 88 of 572

XI-AC867 2x2 Operation

Equipment Configuration for Conducted Low Band-Edge Emissions - Average

Variant:	2x2 802.11b	Duty Cycle (%):	99
Data Rate:	1 mbit	Antenna Gain (dBi):	Not Applicable
Modulation:	CCK	Beam Forming Gain (Y):	Not Applicable
TPC:	Not Applicable	Tested By:	
Engineering Test Notes:			

Test Measurement Results

Channel Frequency:	2412.0 MHz					
Band-Edge Frequency:	2400.0 MHz					
Test Frequency Range:	2350.0 - 2422.0 MHz					
Port(s)	Band-Edge Markers and Limit			Amended Limit		Margin (MHz)
	M1 Amplitude (dBm)	Plot Limit (dBm)	M2 Frequency (MHz)	Amplitude (dBm)	M2A Frequency (MHz)	
a	-40.33	-27.11	2403.50			-3.500
b	-52.26	-28.56	2404.00			-4.000

Traceability to Industry Recognized Test Methodologies

Work Instruction:	WI-05 MEASUREMENT OF SPURIOUS EMISSIONS
Measurement Uncertainty:	≤40 GHz ±2.37 dB, > 40 GHz ±4.6 dB

Note: click the links in the above matrix to view the graphical image (plot).

Equipment Configuration for Conducted Low Band-Edge Emissions - Average

Variant:	2x2 802.11g	Duty Cycle (%):	99
Data Rate:	6 mbits	Antenna Gain (dBi):	Not Applicable
Modulation:	OFDM	Beam Forming Gain (Y):	Not Applicable
TPC:	Not Applicable	Tested By:	AH
Engineering Test Notes:			

Test Measurement Results

Channel Frequency:	2412.0 MHz					
Band-Edge Frequency:	2400.0 MHz					
Test Frequency Range:	2350.0 - 2422.0 MHz					
Port(s)	Band-Edge Markers and Limit			Amended Limit		Margin (MHz)
	M1 Amplitude (dBm)	Plot Limit (dBm)	M2 Frequency (MHz)	Amplitude (dBm)	M2A Frequency (MHz)	
a	-42.34	-36.71	2401.40			-1.400
b	-36.58	-33.92	2401.10			-1.100

Traceability to Industry Recognized Test Methodologies

Work Instruction:	WI-05 MEASUREMENT OF SPURIOUS EMISSIONS
Measurement Uncertainty:	≤40 GHz ±2.37 dB, > 40 GHz ±4.6 dB

Note: click the links in the above matrix to view the graphical image (plot).

This test report may be reproduced in full only. The document may only be updated by MiCOM Labs personnel. Any changes will be noted in the Document History section of the report.



Title: Xirrus Inc. XI-AC1300, XI-AC867
To: FCC 47 CFR Part 15.247 & IC RSS-210
Serial #: XIRR04-U3 Rev A
Issue Date: 29th April 2014
Page: 89 of 572

Equipment Configuration for Conducted Low Band-Edge Emissions - Average

Variant:	2x2 802.11n HT-20	Duty Cycle (%):	98
Data Rate:	6.5 mbits	Antenna Gain (dBi):	Not Applicable
Modulation:	OFDM	Beam Forming Gain (Y):	Not Applicable
TPC:	Not Applicable	Tested By:	AH
Engineering Test Notes:			

Test Measurement Results

Channel Frequency:	2412.0 MHz					
Band-Edge Frequency:	2400.0 MHz					
Test Frequency Range:	2350.0 - 2422.0 MHz					
Port(s)	Band-Edge Markers and Limit			Amended Limit		Margin (MHz)
	M1 Amplitude (dBm)	Plot Limit (dBm)	M2 Frequency (MHz)	Amplitude (dBm)	M2A Frequency (MHz)	
a	-41.48	-37.10	2400.90			-0.900
b	-36.23	-34.15	2400.60			-0.600

Traceability to Industry Recognized Test Methodologies

Work Instruction:	WI-05 MEASUREMENT OF SPURIOUS EMISSIONS
Measurement Uncertainty:	≤40 GHz ±2.37 dB, > 40 GHz ±4.6 dB

Note: click the links in the above matrix to view the graphical image (plot).

Equipment Configuration for Conducted Low Band-Edge Emissions - Average

Variant:	2x2 802.11n HT-40	Duty Cycle (%):	98
Data Rate:	13.5 mbits	Antenna Gain (dBi):	Not Applicable
Modulation:	OFDM	Beam Forming Gain (Y):	Not Applicable
TPC:	Not Applicable	Tested By:	AH
Engineering Test Notes:			

Test Measurement Results

Channel Frequency:	2422.0 MHz					
Band-Edge Frequency:	2400.0 MHz					
Test Frequency Range:	2292.0 - 2442.0 MHz					
Port(s)	Band-Edge Markers and Limit			Amended Limit		Margin (MHz)
	M1 Amplitude (dBm)	Plot Limit (dBm)	M2 Frequency (MHz)	Amplitude (dBm)	M2A Frequency (MHz)	
a	-42.45	-40.89	2400.50			-0.500
b	-38.00	-27.11	2403.20			-3.200

Traceability to Industry Recognized Test Methodologies

Work Instruction:	WI-05 MEASUREMENT OF SPURIOUS EMISSIONS
Measurement Uncertainty:	≤40 GHz ±2.37 dB, > 40 GHz ±4.6 dB

Note: click the links in the above matrix to view the graphical image (plot).

This test report may be reproduced in full only. The document may only be updated by MiCOM Labs personnel. Any changes will be noted in the Document History section of the report.



Title: Xirrus Inc. XI-AC1300, XI-AC867
To: FCC 47 CFR Part 15.247 & IC RSS-210
Serial #: XIRR04-U3 Rev A
Issue Date: 29th April 2014
Page: 90 of 572

Equipment Configuration for Conducted Low Band-Edge Emissions - Average

Variant:	2x2 802.11a	Duty Cycle (%):	98
Data Rate:	6 mbits	Antenna Gain (dBi):	Not Applicable
Modulation:	OFDM	Beam Forming Gain (Y):	Not Applicable
TPC:	Not Applicable	Tested By:	AH
Engineering Test Notes:			

Test Measurement Results

Channel Frequency:	5745.0 MHz					
Band-Edge Frequency:	5725.0 MHz					
Test Frequency Range:	5683.0 - 5755.0 MHz					
Port(s)	Band-Edge Markers and Limit			Amended Limit		Margin
	M1 Amplitude (dBm)	Plot Limit (dBm)	M2 Frequency (MHz)	Amplitude (dBm)	M2A Frequency (MHz)	(MHz)
a	-49.22	-32.61	5734.20			-9.200
b	-50.69	-33.70	5733.90			-8.900

Traceability to Industry Recognized Test Methodologies

Work Instruction:	WI-05 MEASUREMENT OF SPURIOUS EMISSIONS
Measurement Uncertainty:	≤40 GHz ±2.37 dB, > 40 GHz ±4.6 dB

Note: click the links in the above matrix to view the graphical image (plot).

Equipment Configuration for Conducted Low Band-Edge Emissions - Average

Variant:	2x2 802.11ac-80	Duty Cycle (%):	98
Data Rate:	29.3 mbits	Antenna Gain (dBi):	Not Applicable
Modulation:	OFDM	Beam Forming Gain (Y):	Not Applicable
TPC:	Not Applicable	Tested By:	AH
Engineering Test Notes:			

Test Measurement Results

Channel Frequency:	5775.0 MHz					
Band-Edge Frequency:	5725.0 MHz					
Test Frequency Range:	5600.0 - 5900.0 MHz					
Port(s)	Band-Edge Markers and Limit			Amended Limit		Margin
	M1 Amplitude (dBm)	Plot Limit (dBm)	M2 Frequency (MHz)	Amplitude (dBm)	M2A Frequency (MHz)	(MHz)
a	-44.77	-41.22	5730.50			-5.500
b	-45.00	-41.20	5730.50			-5.500

Traceability to Industry Recognized Test Methodologies

Work Instruction:	WI-05 MEASUREMENT OF SPURIOUS EMISSIONS
Measurement Uncertainty:	≤40 GHz ±2.37 dB, > 40 GHz ±4.6 dB

Note: click the links in the above matrix to view the graphical image (plot).

This test report may be reproduced in full only. The document may only be updated by MiCOM Labs personnel. Any changes will be noted in the Document History section of the report.



Title: Xirrus Inc. XI-AC1300, XI-AC867
To: FCC 47 CFR Part 15.247 & IC RSS-210
Serial #: XIRR04-U3 Rev A
Issue Date: 29th April 2014
Page: 91 of 572

Equipment Configuration for Conducted Low Band-Edge Emissions - Average

Variants:	2x2 802.11n HT-20	Duty Cycle (%):	98
Data Rate:	6.5 mbits	Antenna Gain (dBi):	Not Applicable
Modulation:	OFDM	Beam Forming Gain (Y):	Not Applicable
TPC:	Not Applicable	Tested By:	AH
Engineering Test Notes:			

Test Measurement Results

Channel Frequency:	5745.0 MHz					
Band-Edge Frequency:	5725.0 MHz					
Test Frequency Range:	5683.0 - 5755.0 MHz					
Port(s)	Band-Edge Markers and Limit			Amended Limit		Margin (MHz)
	M1 Amplitude (dBm)	Plot Limit (dBm)	M2 Frequency (MHz)	Amplitude (dBm)	M2A Frequency (MHz)	
a	-48.83	-33.22	5733.60			-8.600
b	-49.42	-33.95	5733.40			-8.400

Traceability to Industry Recognized Test Methodologies

Work Instruction:	WI-05 MEASUREMENT OF SPURIOUS EMISSIONS
Measurement Uncertainty:	≤40 GHz ±2.37 dB, > 40 GHz ±4.6 dB

Note: click the links in the above matrix to view the graphical image (plot).

Equipment Configuration for Conducted Low Band-Edge Emissions - Average

Variants:	2x2 802.11n HT-40	Duty Cycle (%):	98
Data Rate:	13.5 mbits	Antenna Gain (dBi):	Not Applicable
Modulation:	OFDM	Beam Forming Gain (Y):	Not Applicable
TPC:	Not Applicable	Tested By:	AH
Engineering Test Notes:			

Test Measurement Results

Channel Frequency:	5755.0 MHz					
Band-Edge Frequency:	5725.0 MHz					
Test Frequency Range:	5625.0 - 5775.0 MHz					
Port(s)	Band-Edge Markers and Limit			Amended Limit		Margin (MHz)
	M1 Amplitude (dBm)	Plot Limit (dBm)	M2 Frequency (MHz)	Amplitude (dBm)	M2A Frequency (MHz)	
a	-49.42	-39.31	5732.30			-7.300
b	-46.06	-38.35	5732.30			-7.300

Traceability to Industry Recognized Test Methodologies

Work Instruction:	WI-05 MEASUREMENT OF SPURIOUS EMISSIONS
Measurement Uncertainty:	≤40 GHz ±2.37 dB, > 40 GHz ±4.6 dB

Note: click the links in the above matrix to view the graphical image (plot).

This test report may be reproduced in full only. The document may only be updated by MiCOM Labs personnel. Any changes will be noted in the Document History section of the report.



Title: Xirrus Inc. XI-AC1300, XI-AC867
To: FCC 47 CFR Part 15.247 & IC RSS-210
Serial #: XIRR04-U3 Rev A
Issue Date: 29th April 2014
Page: 92 of 572

Equipment Configuration for Conducted High Band-Edge Emissions - Average

Variant:	2x2 802.11b	Duty Cycle (%):	99
Data Rate:	1 mbit	Antenna Gain (dBi):	Not Applicable
Modulation:	CCK	Beam Forming Gain (Y):	Not Applicable
TPC:	Not Applicable	Tested By:	
Engineering Test Notes:			

Test Measurement Results

Channel Frequency:	2462.0 MHz					
Band-Edge Frequency:	2483.5 MHz					
Test Frequency Range:	2452.0 - 2524.0 MHz					
Port(s)	Band-Edge Markers and Limit			Amended Limit		Margin (MHz)
	M3 Amplitude (dBm)	Plot Limit (dBm)	M2 Frequency (MHz)	Amplitude (dBm)	M2A Frequency (MHz)	
a	-54.39	-26.50	2470.60			-12.900
b	-61.80	-27.78	2470.30			-13.200

Traceability to Industry Recognized Test Methodologies

Work Instruction:	WI-05 MEASUREMENT OF SPURIOUS EMISSIONS
Measurement Uncertainty:	≤40 GHz ±2.37 dB, > 40 GHz ±4.6 dB

Note: click the links in the above matrix to view the graphical image (plot).

Equipment Configuration for Conducted High Band-Edge Emissions - Average

Variant:	2x2 802.11g	Duty Cycle (%):	99
Data Rate:	6 mbits	Antenna Gain (dBi):	Not Applicable
Modulation:	OFDM	Beam Forming Gain (Y):	Not Applicable
TPC:	Not Applicable	Tested By:	AH
Engineering Test Notes:			

Test Measurement Results

Channel Frequency:	2462.0 MHz					
Band-Edge Frequency:	2483.5 MHz					
Test Frequency Range:	2452.0 - 2524.0 MHz					
Port(s)	Band-Edge Markers and Limit			Amended Limit		Margin (MHz)
	M3 Amplitude (dBm)	Plot Limit (dBm)	M2 Frequency (MHz)	Amplitude (dBm)	M2A Frequency (MHz)	
a	-52.36	-34.06	2473.10			-10.400
b	-42.84	-32.56	2475.20			-8.300

Traceability to Industry Recognized Test Methodologies

Work Instruction:	WI-05 MEASUREMENT OF SPURIOUS EMISSIONS
Measurement Uncertainty:	≤40 GHz ±2.37 dB, > 40 GHz ±4.6 dB

Note: click the links in the above matrix to view the graphical image (plot).

This test report may be reproduced in full only. The document may only be updated by MiCOM Labs personnel. Any changes will be noted in the Document History section of the report.



Title: Xirrus Inc. XI-AC1300, XI-AC867
To: FCC 47 CFR Part 15.247 & IC RSS-210
Serial #: XIRR04-U3 Rev A
Issue Date: 29th April 2014
Page: 93 of 572

Equipment Configuration for Conducted High Band-Edge Emissions - Average

Variant:	2x2 802.11n HT-20	Duty Cycle (%):	98
Data Rate:	6.5 mbits	Antenna Gain (dBi):	Not Applicable
Modulation:	OFDM	Beam Forming Gain (Y):	Not Applicable
TPC:	Not Applicable	Tested By:	AH
Engineering Test Notes:			

Test Measurement Results

Channel Frequency:	2462.0 MHz					
Band-Edge Frequency:	2483.5 MHz					
Test Frequency Range:	2452.0 - 2524.0 MHz					
Port(s)	Band-Edge Markers and Limit			Amended Limit		Margin (MHz)
	M3 Amplitude (dBm)	Plot Limit (dBm)	M2 Frequency (MHz)	Amplitude (dBm)	M2A Frequency (MHz)	
a	-58.38	-35.61	2473.10			-10.400

Traceability to Industry Recognized Test Methodologies

Work Instruction:	WI-05 MEASUREMENT OF SPURIOUS EMISSIONS
Measurement Uncertainty:	≤40 GHz ±2.37 dB, > 40 GHz ±4.6 dB

Note: click the links in the above matrix to view the graphical image (plot).

Equipment Configuration for Conducted High Band-Edge Emissions - Average

Variant:	2x2 802.11n HT-40	Duty Cycle (%):	98
Data Rate:	13.5 mbits	Antenna Gain (dBi):	Not Applicable
Modulation:	OFDM	Beam Forming Gain (Y):	Not Applicable
TPC:	Not Applicable	Tested By:	AH
Engineering Test Notes:			

Test Measurement Results

Channel Frequency:	2452.0 MHz					
Band-Edge Frequency:	2483.5 MHz					
Test Frequency Range:	2432.0 - 2582.0 MHz					
Port(s)	Band-Edge Markers and Limit			Amended Limit		Margin (MHz)
	M3 Amplitude (dBm)	Plot Limit (dBm)	M2 Frequency (MHz)	Amplitude (dBm)	M2A Frequency (MHz)	
a	-51.67	-39.22	2474.10			-9.400
b	-39.95	-36.72	2478.90			-4.600

Traceability to Industry Recognized Test Methodologies

Work Instruction:	WI-05 MEASUREMENT OF SPURIOUS EMISSIONS
Measurement Uncertainty:	≤40 GHz ±2.37 dB, > 40 GHz ±4.6 dB

Note: click the links in the above matrix to view the graphical image (plot).

This test report may be reproduced in full only. The document may only be updated by MiCOM Labs personnel. Any changes will be noted in the Document History section of the report.



Title: Xirrus Inc. XI-AC1300, XI-AC867
To: FCC 47 CFR Part 15.247 & IC RSS-210
Serial #: XIRR04-U3 Rev A
Issue Date: 29th April 2014
Page: 94 of 572

Equipment Configuration for Conducted High Band-Edge Emissions - Average

Variant:	2x2 802.11a	Duty Cycle (%):	98
Data Rate:	6 mbits	Antenna Gain (dBi):	Not Applicable
Modulation:	OFDM	Beam Forming Gain (Y):	Not Applicable
TPC:	Not Applicable	Tested By:	AH
Engineering Test Notes:			

Test Measurement Results

Channel Frequency:	5825.0 MHz					
Band-Edge Frequency:	5850.0 MHz					
Test Frequency Range:	5815.0 - 5887.0 MHz					
Port(s)	Band-Edge Markers and Limit			Amended Limit		Margin
	M3 Amplitude (dBm)	Plot Limit (dBm)	M2 Frequency (MHz)	Amplitude (dBm)	M2A Frequency (MHz)	(MHz)
a	-51.16	-32.67	5836.10			-13.900
b	-55.34	-32.75	5836.10			-13.900

Traceability to Industry Recognized Test Methodologies

Work Instruction:	WI-05 MEASUREMENT OF SPURIOUS EMISSIONS
Measurement Uncertainty:	≤40 GHz ±2.37 dB, > 40 GHz ±4.6 dB

Note: click the links in the above matrix to view the graphical image (plot).

Equipment Configuration for Conducted High Band-Edge Emissions - Average

Variant:	2x2 802.11n HT-20	Duty Cycle (%):	98
Data Rate:	6.5 mbits	Antenna Gain (dBi):	Not Applicable
Modulation:	OFDM	Beam Forming Gain (Y):	Not Applicable
TPC:	Not Applicable	Tested By:	AH
Engineering Test Notes:			

Test Measurement Results

Channel Frequency:	5825.0 MHz					
Band-Edge Frequency:	5850.0 MHz					
Test Frequency Range:	5815.0 - 5887.0 MHz					
Port(s)	Band-Edge Markers and Limit			Amended Limit		Margin
	M3 Amplitude (dBm)	Plot Limit (dBm)	M2 Frequency (MHz)	Amplitude (dBm)	M2A Frequency (MHz)	(MHz)
a	-51.66	-33.87	5836.50			-13.500
b	-56.17	-34.44	5836.50			-13.500

Traceability to Industry Recognized Test Methodologies

Work Instruction:	WI-05 MEASUREMENT OF SPURIOUS EMISSIONS
Measurement Uncertainty:	≤40 GHz ±2.37 dB, > 40 GHz ±4.6 dB

Note: click the links in the above matrix to view the graphical image (plot).

This test report may be reproduced in full only. The document may only be updated by MiCOM Labs personnel. Any changes will be noted in the Document History section of the report.



Title: Xirrus Inc. XI-AC1300, XI-AC867
To: FCC 47 CFR Part 15.247 & IC RSS-210
Serial #: XIRR04-U3 Rev A
Issue Date: 29th April 2014
Page: 95 of 572

Equipment Configuration for Conducted High Band-Edge Emissions - Average

Variant:	2x2 802.11n HT-40	Duty Cycle (%):	98
Data Rate:	13.5 mbits	Antenna Gain (dBi):	Not Applicable
Modulation:	OFDM	Beam Forming Gain (Y):	Not Applicable
TPC:	Not Applicable	Tested By:	AH
Engineering Test Notes:			

Test Measurement Results

Channel Frequency:	5795.0 MHz					
Band-Edge Frequency:	5850.0 MHz					
Test Frequency Range:	5775.0 - 5925.0 MHz					
Port(s)	Band-Edge Markers and Limit			Amended Limit		Margin (MHz)
	M3 Amplitude (dBm)	Plot Limit (dBm)	M2 Frequency (MHz)	Amplitude (dBm)	M2A Frequency (MHz)	
a	-53.89	-38.59	5817.40			-32.600
b	-62.29	-38.80	5817.10			-32.900

Traceability to Industry Recognized Test Methodologies

Work Instruction:	WI-05 MEASUREMENT OF SPURIOUS EMISSIONS
Measurement Uncertainty:	≤40 GHz ±2.37 dB, > 40 GHz ±4.6 dB

Note: click the links in the above matrix to view the graphical image (plot).

This test report may be reproduced in full only. The document may only be updated by MiCOM Labs personnel. Any changes will be noted in the Document History section of the report.



Title: Xirrus Inc. XI-AC1300, XI-AC867
To: FCC 47 CFR Part 15.247 & IC RSS-210
Serial #: XIRR04-U3 Rev A
Issue Date: 29th April 2014
Page: 96 of 572

Equipment Configuration for Transmitter Conducted Spurious Emissions

Variant:	2x2 802.11b	Duty Cycle (%):	99
Data Rate:	1 mbit	Antenna Gain (dBi):	Not Applicable
Modulation:	CCK	Beam Forming Gain (Y):	Not Applicable
TPC:	Not Applicable	Tested By:	
Engineering Test Notes:			

Test Measurement Results

Test Frequency	Frequency Range	Transmitter Conducted Spurious Emissions (dBm)							
		Port a		Port b		Port c		Port d	
MHz	MHz	SE	Limit	SE	Limit	SE	Limit	SE	Limit
2412.0	30.0 - 26000.0	-70.002	-44.56	-68.663	-46.17				
2437.0	30.0 - 26000.0	-70.002	-43.75	-68.663	-45.04				
2462.0	30.0 - 26000.0	-70.002	-44.21	-70.002	-45.19				

Traceability to Industry Recognized Test Methodologies

Work Instruction:	WI-05 MEASUREMENT OF SPURIOUS EMISSIONS
Measurement Uncertainty:	≤40 GHz ±2.37 dB, > 40 GHz ±4.6 dB

Note: click the links in the above matrix to view the graphical image (plot).

Equipment Configuration for Transmitter Conducted Spurious Emissions

Variant:	802.11g	Duty Cycle (%):	99
Data Rate:	6 mbits	Antenna Gain (dBi):	Not Applicable
Modulation:	OFDM	Beam Forming Gain (Y):	Not Applicable
TPC:	Not Applicable	Tested By:	AH
Engineering Test Notes:			

Test Measurement Results

Test Frequency	Frequency Range	Transmitter Conducted Spurious Emissions (dBm)							
		Port a		Port b		Port c		Port d	
MHz	MHz	SE	Limit	SE	Limit	SE	Limit	SE	Limit
2412.0	30.0 - 26000.0	-67.504	-48.08	-66.480	-45.51	--	--	--	--
2437.0	30.0 - 26000.0	-66.480	-46.11	-66.480	-44.36	--	--	--	--
2462.0	30.0 - 26000.0	-66.480	-45.38	-65.565	-43.79	--	--	--	--

Traceability to Industry Recognized Test Methodologies

Work Instruction:	WI-05 MEASUREMENT OF SPURIOUS EMISSIONS
Measurement Uncertainty:	≤40 GHz ±2.37 dB, > 40 GHz ±4.6 dB

Note: click the links in the above matrix to view the graphical image (plot).

This test report may be reproduced in full only. The document may only be updated by MiCOM Labs personnel. Any changes will be noted in the Document History section of the report.



Title: Xirrus Inc. XI-AC1300, XI-AC867
To: FCC 47 CFR Part 15.247 & IC RSS-210
Serial #: XIRR04-U3 Rev A
Issue Date: 29th April 2014
Page: 97 of 572

Equipment Configuration for Transmitter Conducted Spurious Emissions

Variant:	2x2 802.11n HT-20	Duty Cycle (%):	98
Data Rate:	6.5 mbits	Antenna Gain (dBi):	Not Applicable
Modulation:	OFDM	Beam Forming Gain (Y):	Not Applicable
TPC:	Not Applicable	Tested By:	AH
Engineering Test Notes:			

Test Measurement Results

Test Frequency	Frequency Range	Transmitter Conducted Spurious Emissions (dBm)							
		Port a		Port b		Port c		Port d	
MHz	MHz	SE	Limit	SE	Limit	SE	Limit	SE	Limit
2412.0	30.0 - 26000.0	-67.504	-47.15	-66.480	-44.65	--	--	--	--
2437.0	30.0 - 26000.0	-66.480	-43.05	-64.737	-41.62	--	--	--	--
2462.0	30.0 - 26000.0	-66.480	-46.16	-66.480	-44.77	--	--	--	--

Traceability to Industry Recognized Test Methodologies

Work Instruction:	WI-05 MEASUREMENT OF SPURIOUS EMISSIONS
Measurement Uncertainty:	≤40 GHz ±2.37 dB, > 40 GHz ±4.6 dB

Note: click the links in the above matrix to view the graphical image (plot).

Equipment Configuration for Transmitter Conducted Spurious Emissions

Variant:	2x2 802.11n HT-40	Duty Cycle (%):	98
Data Rate:	13.5 mbits	Antenna Gain (dBi):	Not Applicable
Modulation:	OFDM	Beam Forming Gain (Y):	Not Applicable
TPC:	Not Applicable	Tested By:	AH
Engineering Test Notes:			

Test Measurement Results

Test Frequency	Frequency Range	Transmitter Conducted Spurious Emissions (dBm)							
		Port a		Port b		Port c		Port d	
MHz	MHz	SE	Limit	SE	Limit	SE	Limit	SE	Limit
2422.0	30.0 - 26000.0	-67.504	-48.20	-66.480	-46.52	--	--	--	--
2437.0	30.0 - 26000.0	-66.480	-41.66	-66.480	-40.30	--	--	--	--
2452.0	30.0 - 26000.0	-66.480	-42.59	-66.480	-41.09	--	--	--	--

Traceability to Industry Recognized Test Methodologies

Work Instruction:	WI-05 MEASUREMENT OF SPURIOUS EMISSIONS
Measurement Uncertainty:	≤40 GHz ±2.37 dB, > 40 GHz ±4.6 dB

Note: click the links in the above matrix to view the graphical image (plot).

This test report may be reproduced in full only. The document may only be updated by MiCOM Labs personnel. Any changes will be noted in the Document History section of the report.



Title: Xirrus Inc. XI-AC1300, XI-AC867
To: FCC 47 CFR Part 15.247 & IC RSS-210
Serial #: XIRR04-U3 Rev A
Issue Date: 29th April 2014
Page: 98 of 572

Equipment Configuration for Transmitter Conducted Spurious Emissions

Variant:	2x2 802.11a	Duty Cycle (%):	98
Data Rate:	6 mbits	Antenna Gain (dBi):	Not Applicable
Modulation:	OFDM	Beam Forming Gain (Y):	Not Applicable
TPC:	Not Applicable	Tested By:	AH
Engineering Test Notes:			

Test Measurement Results

Test Frequency	Frequency Range	Transmitter Conducted Spurious Emissions (dBm)							
		Port a		Port b		Port c		Port d	
MHz	MHz	SE	Limit	SE	Limit	SE	Limit	SE	Limit
5745.0	30.0 - 26000.0	-56.938	-48.35	-60.956	-48.99	--	--	--	--
5785.0	30.0 - 26000.0	-57.607	-43.91	-58.717	-43.99	--	--	--	--
5825.0	30.0 - 26000.0	-55.738	-43.62	-55.738	-43.96	--	--	--	--

Traceability to Industry Recognized Test Methodologies

Work Instruction:	WI-05 MEASUREMENT OF SPURIOUS EMISSIONS
Measurement Uncertainty:	≤40 GHz ±2.37 dB, > 40 GHz ±4.6 dB

Note: click the links in the above matrix to view the graphical image (plot).

Equipment Configuration for Transmitter Conducted Spurious Emissions

Variant:	2x2 802.11ac-80	Duty Cycle (%):	98
Data Rate:	29.3 mbits	Antenna Gain (dBi):	Not Applicable
Modulation:	OFDM	Beam Forming Gain (Y):	Not Applicable
TPC:	Not Applicable	Tested By:	AH
Engineering Test Notes:			

Test Measurement Results

Test Frequency	Frequency Range	Transmitter Conducted Spurious Emissions (dBm)							
		Port a		Port b		Port c		Port d	
MHz	MHz	SE	Limit	SE	Limit	SE	Limit	SE	Limit
5775.0	30.0 - 26000.0	-62.643	-42.51	-58.717	-42.12	--	--	--	--

Traceability to Industry Recognized Test Methodologies

Work Instruction:	WI-05 MEASUREMENT OF SPURIOUS EMISSIONS
Measurement Uncertainty:	≤40 GHz ±2.37 dB, > 40 GHz ±4.6 dB

Note: click the links in the above matrix to view the graphical image (plot).

This test report may be reproduced in full only. The document may only be updated by MiCOM Labs personnel. Any changes will be noted in the Document History section of the report.



Title: Xirrus Inc. XI-AC1300, XI-AC867
To: FCC 47 CFR Part 15.247 & IC RSS-210
Serial #: XIRR04-U3 Rev A
Issue Date: 29th April 2014
Page: 99 of 572

Equipment Configuration for Transmitter Conducted Spurious Emissions

Variant:	2x2 802.11n HT-20	Duty Cycle (%):	98
Data Rate:	6.5 mbits	Antenna Gain (dBi):	Not Applicable
Modulation:	OFDM	Beam Forming Gain (Y):	Not Applicable
TPC:	Not Applicable	Tested By:	AH
Engineering Test Notes:			

Test Measurement Results

Test Frequency	Frequency Range	Transmitter Conducted Spurious Emissions (dBm)							
		Port a		Port b		Port c		Port d	
MHz	MHz	SE	Limit	SE	Limit	SE	Limit	SE	Limit
5745.0	30.0 - 26000.0	-57.266	-48.02	-60.956	-49.13	--	--	--	--
5785.0	30.0 - 26000.0	-57.607	-44.46	-61.483	-45.50	--	--	--	--
5825.0	30.0 - 26000.0	-58.331	-44.36	-58.717	-44.86	--	--	--	--

Traceability to Industry Recognized Test Methodologies

Work Instruction:	WI-05 MEASUREMENT OF SPURIOUS EMISSIONS
Measurement Uncertainty:	≤40 GHz ±2.37 dB, > 40 GHz ±4.6 dB

Note: click the links in the above matrix to view the graphical image (plot).

Equipment Configuration for Transmitter Conducted Spurious Emissions

Variant:	2x2 802.11n HT-40	Duty Cycle (%):	98
Data Rate:	13.5 mbits	Antenna Gain (dBi):	Not Applicable
Modulation:	OFDM	Beam Forming Gain (Y):	Not Applicable
TPC:	Not Applicable	Tested By:	AH
Engineering Test Notes:			

Test Measurement Results

Test Frequency	Frequency Range	Transmitter Conducted Spurious Emissions (dBm)							
		Port a		Port b		Port c		Port d	
MHz	MHz	SE	Limit	SE	Limit	SE	Limit	SE	Limit
5755.0	30.0 - 26000.0	-59.990	-44.78	-62.643	-44.26	--	--	--	--
5795.0	30.0 - 26000.0	-60.460	-48.22	-63.286	-48.32	--	--	--	--

Traceability to Industry Recognized Test Methodologies

Work Instruction:	WI-05 MEASUREMENT OF SPURIOUS EMISSIONS
Measurement Uncertainty:	≤40 GHz ±2.37 dB, > 40 GHz ±4.6 dB

Note: click the links in the above matrix to view the graphical image (plot).

This test report may be reproduced in full only. The document may only be updated by MiCOM Labs personnel. Any changes will be noted in the Document History section of the report.



Specification

Limits Band-Edge

Lower Limit Band-edge	Upper Limit Band-edge	Limit below highest level of desired power
2,400 MHz	2,483.5 MHz	≥ 20 dB
5725 MHz	5850 MHz	

§15.247(d) and RSS-210 §A8.5 In any 100 kHz bandwidth outside the frequency band in which the spread spectrum or digitally modulated intentional radiator is operating, the radio frequency power that is produced by the intentional radiator shall be at least 20 dB below that in the 100 kHz bandwidth within the band that contains the highest level of the desired power, based on either an RF conducted or radiated measurement, provided the transmitter demonstrates compliance with the peak conducted power limits.

§15.247(d)

If the transmitter complies with the conducted power limits based on the use of RMS averaging over a time interval, as permitted under paragraph (b)(3) of this section, the attenuation required under this paragraph shall be 30 dB instead of 20 dB. Attenuation below the general limits specified §15.209(a) is not required. In addition, radiated emissions which fall in the restricted bands, as defined in Section §15.205(a), must also comply with the radiated emission limits specified in Section 15.209(a) (see Section 15.205(a)).

RSS-210 §A8.5 If the transmitter complies with the conducted power limits based on the use of RMS averaging over a time interval, as permitted under section A8.4(4), the attenuation required shall be 30 dB instead of 20 dB. Attenuation below the general limits specified in Tables 2 and 3 is not required. In addition, radiated emissions which fall in the restricted bands of Table 1 must also comply with the radiated emission limits specified in Tables 2 and 3.

RSS-Gen §4.7

The search for unwanted emissions shall be from the lowest frequency internally generated or used in the device (local oscillator, intermediate of carrier frequency), or from 30 MHz , whichever is the lowest frequency, to the 5th harmonic of the highest frequency generated without exceeding 40 GHz.

Laboratory Measurement Uncertainty for Conducted Spurious Emissions

Measurement uncertainty	±2.37 dB
-------------------------	----------

Traceability

Method	Test Equipment Used
Measurements were made per work instruction WI-05 'Measurement of Spurious Emissions'	0088, 0158, 0287, 0252, 0313, 0314, 0070, 0116, 0117.

This test report may be reproduced in full only. The document may only be updated by MiCOM Labs personnel. Any changes will be noted in the Document History section of the report.



5.1.2. Radiated Emission Testing

Transmitter Radiated Spurious Emissions (above 1 GHz); Peak Field Strength Measurements; and Radiated Band Edge Measurements – Restricted Bands

FCC, Part 15 Subpart C §15.247(d) 15.205; 15.209

Industry Canada RSS-210 §A8.5, §2.2, §2.6

Industry Canada RSS-Gen §4.7

Test Procedure

Radiated emissions above 1 GHz are measured in the anechoic chamber at a 3-meter distance on every azimuth in both horizontal and vertical polarities. The emissions are recorded and maximized as a function of azimuth by rotation through 360° with a spectrum analyzer in peak hold mode. Depending on the frequency band spanned a notch filter and waveguide filter was used to remove the fundamental frequency. The highest emissions relative to the limit are listed for each frequency spanned.

All measurements on any frequency or frequencies over 1 MHz are based on the use of measurement instrumentation employing an average detector function. All measurements above 1 GHz were performed using a minimum resolution bandwidth of 1 MHz.

Field Strength Calculation

The field strength is calculated by adding the Antenna Factor and Cable Loss, and subtracting Amplifier Gain from the measured reading. All factors are included in the reported data.

$$FS = R + AF + CORR - FO$$

where: FS = Field Strength

R = Measured Spectrum analyzer Input Amplitude

AF = Antenna Factor

CORR = Correction Factor = CL – AG + NFL

CL = Cable Loss

AG = Amplifier Gain

FO = Distance Falloff Factor

NFL = Notch Filter Loss or Waveguide Loss

For example:

Given receiver input reading of 51.5 dB μ V; Antenna Factor of 8.5 dB; Cable Loss of 1.3 dB; Falloff Factor of 0 dB, an Amplifier Gain of 26 dB and Notch Filter Loss of 1 dB. The Field Strength of the measured emission is:

$$FS = 51.5 + 8.5 + 1.3 - 26.0 + 1 = 36.3 \text{ dB}\mu\text{V/m}$$

Conversion between dB μ V/m (or dB μ V) and μ V/m (or μ V) are done as:

$$\text{Level (dB}\mu\text{V/m)} = 20 * \text{Log (level (\mu\text{V/m}))}$$

$$40 \text{ dB}\mu\text{V/m} = 100 \mu\text{V/m}$$

$$48 \text{ dB}\mu\text{V/m} = 250 \mu\text{V/m}$$



Title: Xirrus Inc. XI-AC1300, XI-AC867
To: FCC 47 CFR Part 15.247 & IC RSS-210
Serial #: XIRR04-U3 Rev A
Issue Date: 29th April 2014
Page: 102 of 572

NOTE: KDB 662911 was implemented for Out-of-Band measurements. Where necessary Option (2) Measure and add $10 \log(N)$ dB was implemented

Selection of test modes were operational modes that returned the highest power spectral density during conducted testing.

This test report may be reproduced in full only. The document may only be updated by MiCOM Labs personnel. Any changes will be noted in the Document History section of the report.



Title: Xirrus Inc. XI-AC1300, XI-AC867
To: FCC 47 CFR Part 15.247 & IC RSS-210
Serial #: XIRR04-U3 Rev A
Issue Date: 29th April 2014
Page: 103 of 572

5.1.2.1. Spurious Emissions

Test Freq.	2412 MHz	Engineer	SB
Variant	802.11b; 1 Mbs	Temp (°C)	21
Freq. Range	1000 MHz - 18000 MHz	Rel. Hum.(%)	27
Power Setting	12	Press. (mBars)	1008
Antenna	Integral	Duty Cycle (%)	100
Test Notes 1			
Test Notes 2			

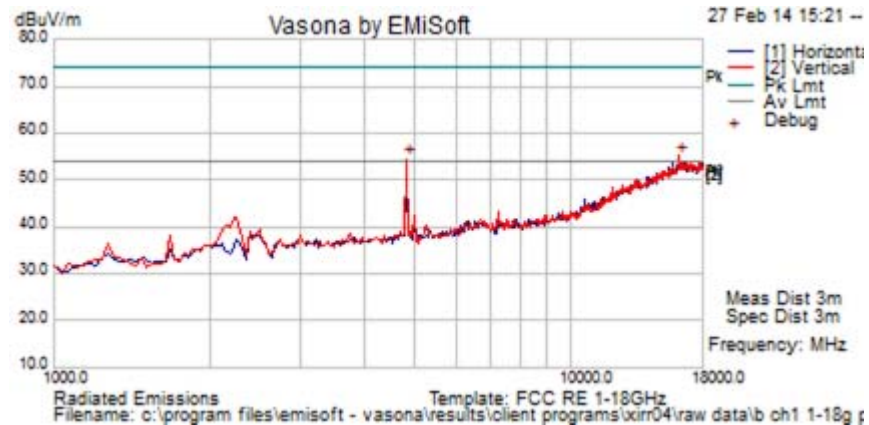

Formally measured emission peaks

Frequency MHz	Raw dBuV	Cable Loss	AF dB	Level dBuV/m	Measurement Type	Pol	Hgt cm	Azt Deg	Limit dBuV/m	Margin dB	Pass /Fail	Comments
2409.165	51.8	3.9	-5.6	50.2	Peak [Scan]	V						FUND
16228.457	41.2	11.9	9.4	62.5	Peak Max	V	170	295	74.0	-11.5	Pass	Noise Floor
4825.651	57.9	5.7	-2.6	61.0	Peak Max	V	138	361	74.0	-13.0	Pass	RB
16228.457	28.0	11.9	9.4	49.3	Average Max	V	170	295	54	-4.7	Pass	Noise Floor
4825.651	43.0	5.7	-2.6	46.1	Average Max	V	138	361	54	-7.9	Pass	RB

Legend: TX = Transmitter Emissions; DIG = Digital Emissions; FUND = Fundamental; WB = Wideband Emission
 RB = Restricted Band (15.209 Limits); NRB = Non Restricted Band, Limit is 20dB below fundamental peak

This test report may be reproduced in full only. The document may only be updated by MiCOM Labs personnel. Any changes will be noted in the Document History section of the report.



Title: Xirrus Inc. XI-AC1300, XI-AC867
To: FCC 47 CFR Part 15.247 & IC RSS-210
Serial #: XIRR04-U3 Rev A
Issue Date: 29th April 2014
Page: 104 of 572

Test Freq.	2437 MHz	Engineer	SB
Variant	802.11b; 1 Mbs	Temp (°C)	21
Freq. Range	1000 MHz - 18000 MHz	Rel. Hum.(%)	27
Power Setting	12	Press. (mBars)	1008
Antenna	Integral	Duty Cycle (%)	100
Test Notes 1			
Test Notes 2			

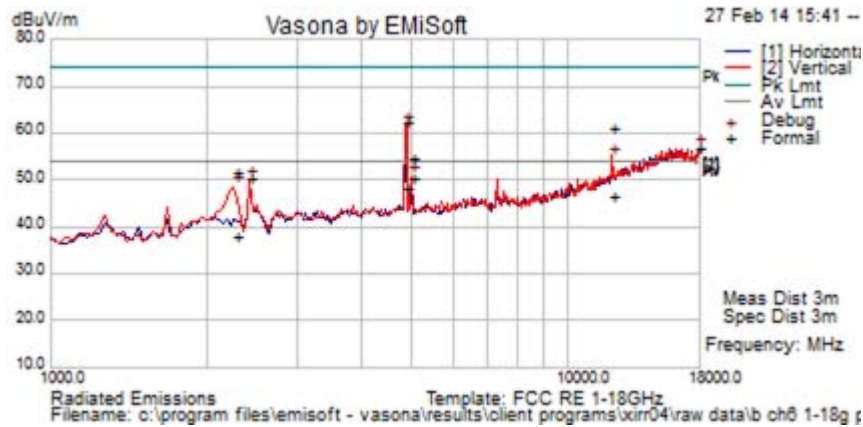

Formally measured emission peaks

Frequency MHz	Raw dBuV	Cable Loss	AF dB	Level dBuV/m	Measurement Type	Pol	Hgt cm	Azt Deg	Limit dBuV/m	Margin dB	Pass /Fail	Comments
4873.046	59.2	5.7	-2.6	62.3	Peak Max	V	147	352	74.0	-11.7	Pass	RB
5000.05	51.5	5.8	-2.8	54.5	Peak Max	V	126	316	74.0	-19.5	Pass	RB
2278.156	53.8	3.8	-6.0	51.6	Peak Max	V	99	245	74.0	-22.5	Pass	RB
12183.81	46.1	9.7	5.3	61.0	Peak Max	V	98	221	74.0	-13.0	Pass	RB
17931.864	41.2	11.9	9.4	62.5	Peak Max	V	170	295	74.0	-11.5	Pass	Noise Floor
4873.046	45.2	5.7	-2.6	48.3	Average Max	V	147	352	54	-5.7	Pass	RB
5000.050	47.2	5.8	-2.8	50.2	Average Max	V	126	316	54	-3.8	Pass	RB
2278.156	40.2	3.8	-6.0	38.0	Average Max	V	99	245	54	-16.0	Pass	RB
12183.810	31.6	9.7	5.3	46.5	Average Max	V	98	221	54	-7.5	Pass	RB
17931.864	28.0	11.9	9.4	49.3	Average Max	V	170	295	54	-4.7	Pass	Noise Floor
2430.862	51.8	3.9	-5.6	50.2	Peak [Scan]	V						

Legend: TX = Transmitter Emissions; DIG = Digital Emissions; FUND = Fundamental; WB = Wideband Emission
 RB = Restricted Band (15.209 Limits); NRB = Non Restricted Band, Limit is 20dB below fundamental peak

This test report may be reproduced in full only. The document may only be updated by MiCOM Labs personnel. Any changes will be noted in the Document History section of the report.



Title: Xirrus Inc. XI-AC1300, XI-AC867
To: FCC 47 CFR Part 15.247 & IC RSS-210
Serial #: XIRR04-U3 Rev A
Issue Date: 29th April 2014
Page: 105 of 572

Test Freq.	2462 MHz	Engineer	SB
Variants	802.11b; 1 Mbs	Temp (°C)	21
Freq. Range	1000 MHz - 18000 MHz	Rel. Hum.(%)	27
Power Setting	13	Press. (mBars)	1008
Antenna	Integral	Duty Cycle (%)	100
Test Notes 1			
Test Notes 2			

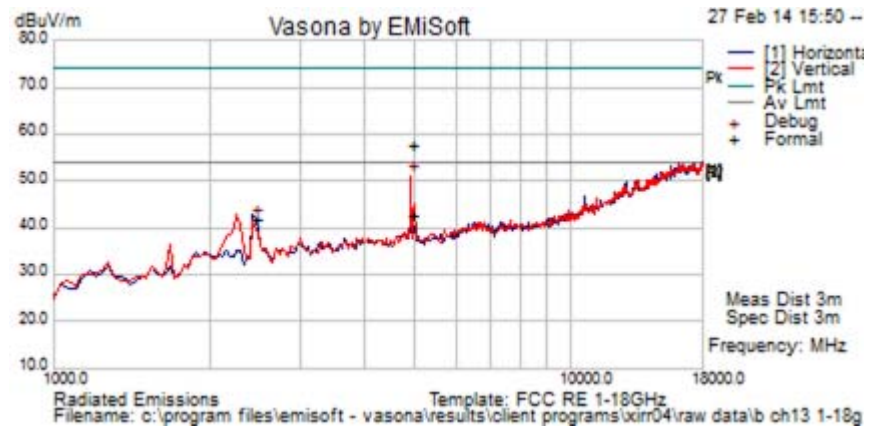

Formally measured emission peaks

Frequency MHz	Raw dBuV	Cable Loss	AF dB	Level dBuV/m	Measurement Type	Pol	Hgt cm	Azt Deg	Limit dBuV/m	Margin dB	Pass /Fail	Comments
4924.800	54.5	5.7	-2.7	57.6	Peak Max	V	113	352	74.0	-16.4	Pass	RB
4924.800	39.6	5.7	-2.7	42.6	Average Max	V	113	352	54.0	-11.4	Pass	RB
2464.024	43.5	4.0	-5.5	42.0	Peak [Scan]	V						FUND
Legend: TX = Transmitter Emissions; DIG = Digital Emissions; FUND = Fundamental; WB = Wideband Emission RB = Restricted Band (15.209 Limits); NRB = Non Restricted Band, Limit is 20dB below fundamental peak												

This test report may be reproduced in full only. The document may only be updated by MiCOM Labs personnel. Any changes will be noted in the Document History section of the report.



Title: Xirrus Inc. XI-AC1300, XI-AC867
To: FCC 47 CFR Part 15.247 & IC RSS-210
Serial #: XIRR04-U3 Rev A
Issue Date: 29th April 2014
Page: 106 of 572

Test Freq.	5745 MHz	Engineer	SB
Variants	802.11a; 6.5 Mbs	Temp (°C)	22.5
Freq. Range	1000 MHz - 18000 MHz	Rel. Hum.(%)	25
Power Setting	Target	Press. (mBars)	1007
Antenna	Integral	Duty Cycle (%)	100
Test Notes 1			
Test Notes 2			

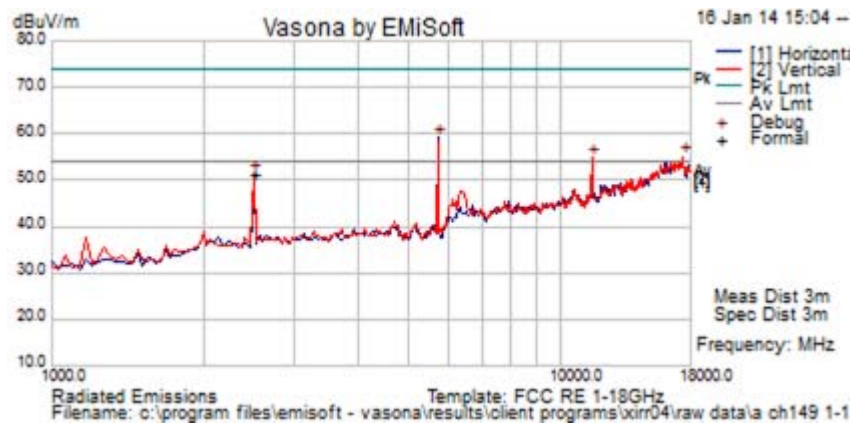

Formally measured emission peaks

Frequency MHz	Raw dBuV	Cable Loss	AF dB	Level dBuV/m	Measurement Type	Pol	Hgt cm	Azt Deg	Limit dBuV/m	Margin dB	Pass /Fail	Comments
2500.050	60.4	4.0	-11.5	53.0	Peak Max	V	177	196	74	-21.0	Pass	RB
2500.05	58.9	4.0	-11.5	51.4	Average Max	V	177	196	54.0	-2.6	Pass	RB
17386.774	43.1	12.4	1.4	56.9	Peak Max	V	99	100	74	-17.1	Pass	Noise Floor
11492.356	49.6	9.4	-2.0	57.0	Peak Max	V	361	151	74	-17.0	Pass	RB
17386.774	29.9	12.4	1.4	43.6	Average Max	V	99	100	54	-10.4	Pass	Noise Floor
11494.051	35.6	9.4	-2.0	43.0	Average Max	V	361	151	54	-11.0	Pass	RB
5735.471	62.5	6.2	-9.5	59.2	Peak [Scan]	H						FUND

Legend: TX = Transmitter Emissions; DIG = Digital Emissions; FUND = Fundamental; WB = Wideband Emission
 RB = Restricted Band (15.209 Limits); NRB = Non Restricted Band, Limit is 20dB below fundamental peak

This test report may be reproduced in full only. The document may only be updated by MiCOM Labs personnel. Any changes will be noted in the Document History section of the report.



Title: Xirrus Inc. XI-AC1300, XI-AC867
To: FCC 47 CFR Part 15.247 & IC RSS-210
Serial #: XIRR04-U3 Rev A
Issue Date: 29th April 2014
Page: 107 of 572

Test Freq.	5785 MHz	Engineer	SB
Variant	802.11a; 6.5 Mbs	Temp (°C)	22.5
Freq. Range	1000 MHz - 18000 MHz	Rel. Hum.(%)	25
Power Setting	Target	Press. (mBars)	1007
Antenna	Integral	Duty Cycle (%)	100
Test Notes 1			
Test Notes 2			

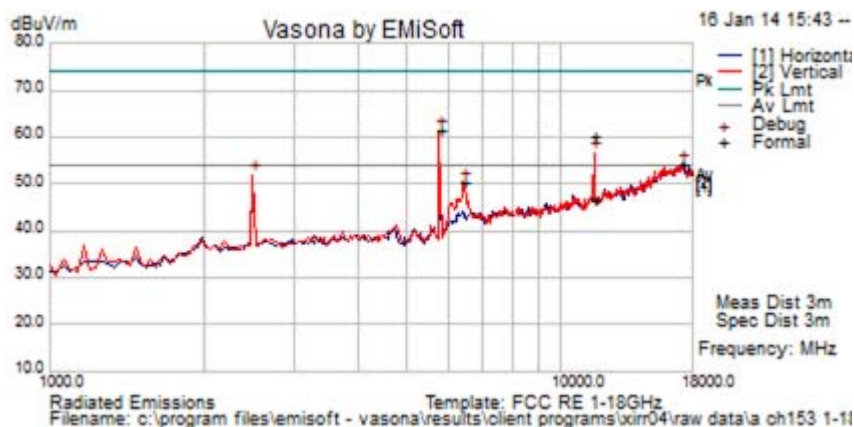

Formally measured emission peaks

Frequency MHz	Raw dBuV	Cable Loss	AF dB	Level dBuV/m	Measurement Type	Pol	Hgt cm	Azt Deg	Limit dBuV/m	Margin dB	Pass /Fail	Comments
11571.142	52.8	9.4	-2.0	60.2	Peak Max	V	111	361	74.0	-13.8	Pass	RB
2500.050	60.4	4.0	-11.5	53.0	Peak Max	V	177	196	74	-21.0	Pass	RB
11571.142	39.1	9.4	-2.0	46.5	Average Max	V	111	361	54.0	-7.5	Pass	RB
2500.05	58.9	4.0	-11.5	51.4	Average Max	V	177	196	54.0	-2.6	Pass	RB
5769.539	64.5	6.3	-9.5	61.3	Peak [Scan]	V	200	0	54	7.3	Fail	FUND
17250.501	41.0	12.4	1.0	54.4	Peak [Scan]	H	100	0	54	0.4	Fail	Noise Floor
6416.834	51.0	6.7	-7.2	50.5	Peak [Scan]	V	100	0	54	-3.5	Pass	NRB

Legend: TX = Transmitter Emissions; DIG = Digital Emissions; FUND = Fundamental; WB = Wideband Emission
 RB = Restricted Band (15.209 Limits); NRB = Non Restricted Band, Limit is 20dB below fundamental peak

This test report may be reproduced in full only. The document may only be updated by MiCOM Labs personnel. Any changes will be noted in the Document History section of the report.



Title: Xirrus Inc. XI-AC1300, XI-AC867
To: FCC 47 CFR Part 15.247 & IC RSS-210
Serial #: XIRR04-U3 Rev A
Issue Date: 29th April 2014
Page: 108 of 572

Test Freq.	5825 MHz	Engineer	SB
Variant	802.11a; 6.5 Mbs	Temp (°C)	22.5
Freq. Range	1000 MHz - 18000 MHz	Rel. Hum.(%)	25
Power Setting	Target	Press. (mBars)	1007
Antenna	Integral	Duty Cycle (%)	100
Test Notes 1			
Test Notes 2			

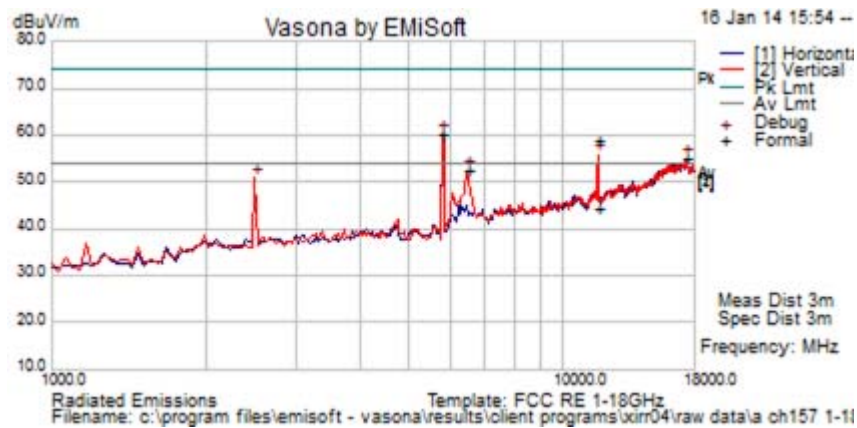

Formally measured emission peaks

Frequency MHz	Raw dBuV	Cable Loss	AF dB	Level dBuV/m	Measurement Type	Pol	Hgt cm	Azt Deg	Limit dBuV/m	Margin dB	Pass /Fail	Comments
11651.028	51.9	9.4	-2.3	59.0	Peak Max	V	102	350	74.0	-15.0	Pass	RB
2500.050	60.4	4.0	-11.5	53.0	Peak Max	V	177	196	74	-21.0	Pass	RB
11651.028	37.3	9.4	-2.3	44.5	Average Max	V	102	350	54.0	-9.5	Pass	RB
2500.05	58.9	4.0	-11.5	51.4	Average Max	V	177	196	54.0	-2.6	Pass	RB
5803.607	63.4	6.3	-9.4	60.3	Peak [Scan]	V	200	0	54	6.3	Fail	FUND
17318.637	41.3	12.4	1.2	54.9	Peak [Scan]	V	150	0	54	0.9	Fail	Noise Floor
6484.970	52.8	6.7	-7.1	52.5	Peak [Scan]	V	150	0	54	-1.6	Pass	NRB

Legend: TX = Transmitter Emissions; DIG = Digital Emissions; FUND = Fundamental; WB = Wideband Emission
 RB = Restricted Band (15.209 Limits); NRB = Non Restricted Band, Limit is 20dB below fundamental peak

This test report may be reproduced in full only. The document may only be updated by MiCOM Labs personnel. Any changes will be noted in the Document History section of the report.



5.1.2.2. Radiated Band-Edge

2.4 GHz Frequency Band

Peak Limit 74.0 dB μ V, Peak Limit 54.0 dB μ V

Integral Antenna

Operational Mode	2390 MHz			2483.5 MHz		
	dB μ V		Power Setting	dB μ V		Power Setting
	Peak	Average		Peak	Average	
b	67.28	52.58	12	70.66	51.62	14
g	66.57	51.75	12	68.78	51.40	14
n HT-20	69.09	53.72	12	69.86	51.28	14
n HT-40	67.45	53.25	12	70.08	52.44	12

5.8 GHz Frequency Band

Integral Antenna

Operational Mode	5460 MHz		
	Peak	Average	Power Setting
a	65.41	53.82	18
n HT-20	66.11	53.85	18
n HT-40	51.66	66.50	18
ac-40	64.04	51.72	18
ac-80	66.16	52.06	18

This test report may be reproduced in full only. The document may only be updated by MiCOM Labs personnel. Any changes will be noted in the Document History section of the report.



11b 2483.5 MHz Band Edge

Power Setting = 14

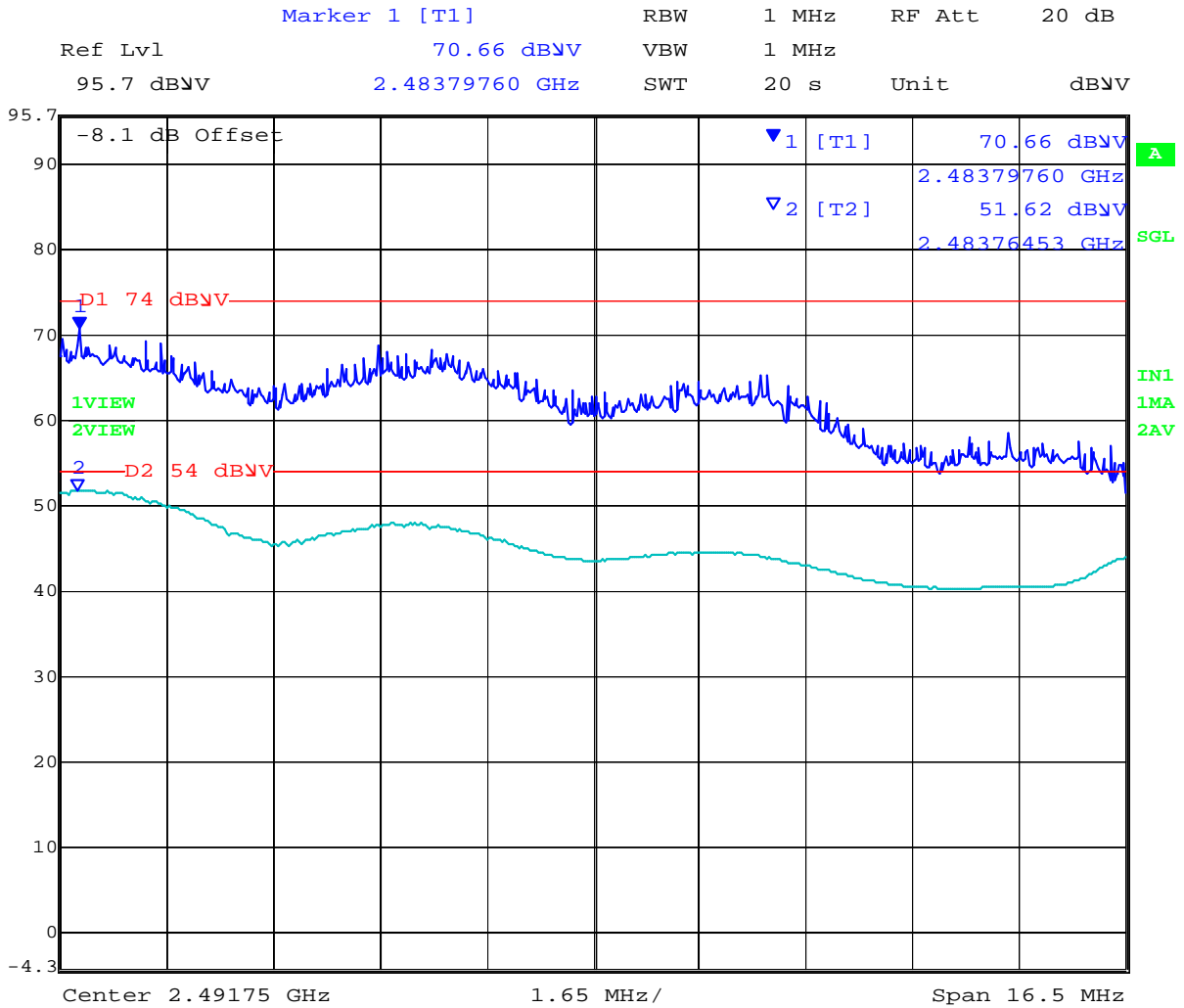

Date: 15.JAN.2014 13:55:17

This test report may be reproduced in full only. The document may only be updated by MiCOM Labs personnel. Any changes will be noted in the Document History section of the report.



11g 2390 MHz Band Edge

Power Setting = 12

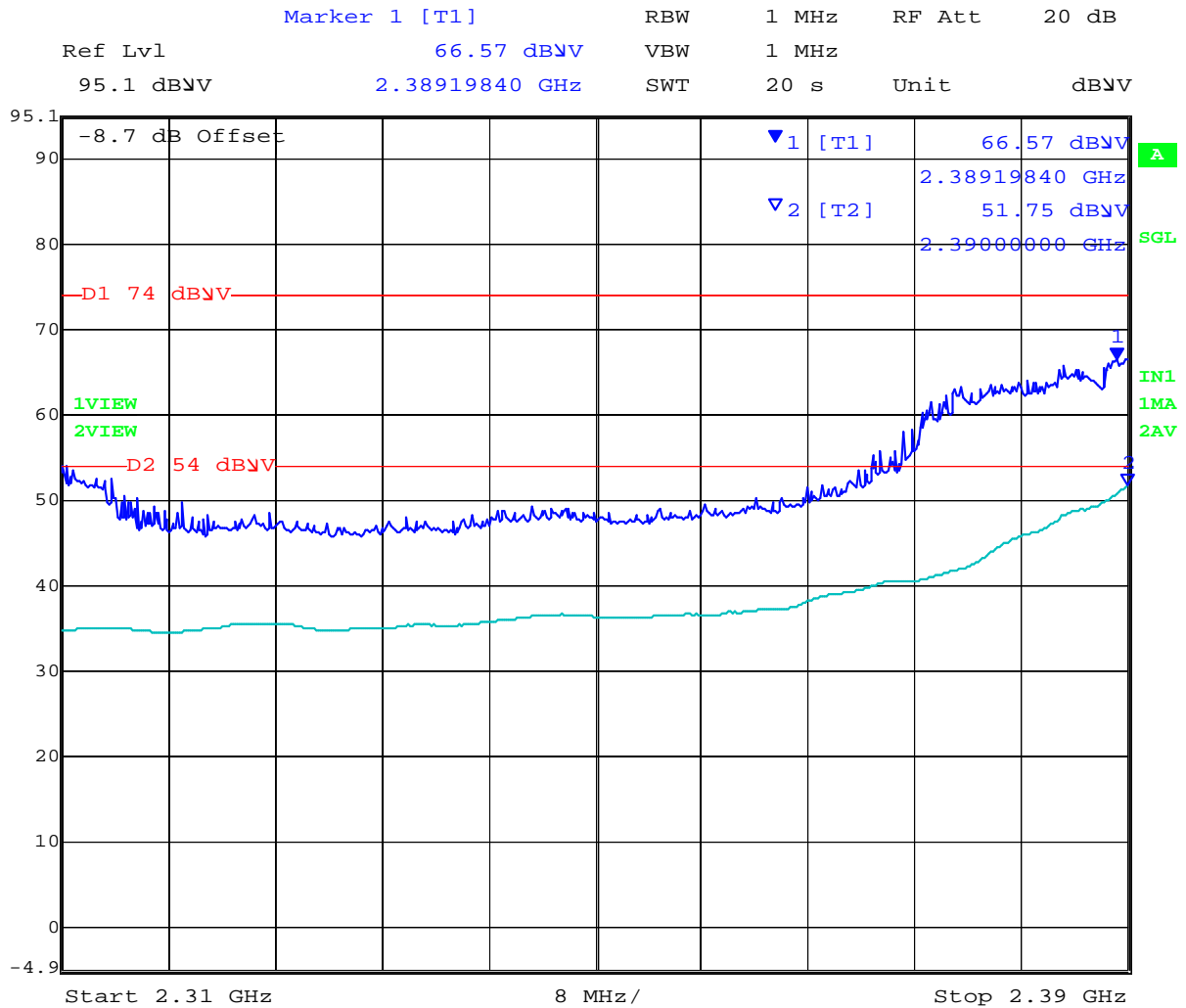

Date: 15.JAN.2014 11:49:25

This test report may be reproduced in full only. The document may only be updated by MiCOM Labs personnel. Any changes will be noted in the Document History section of the report.



11g 2483.5 MHz Band Edge

Power Setting = 14

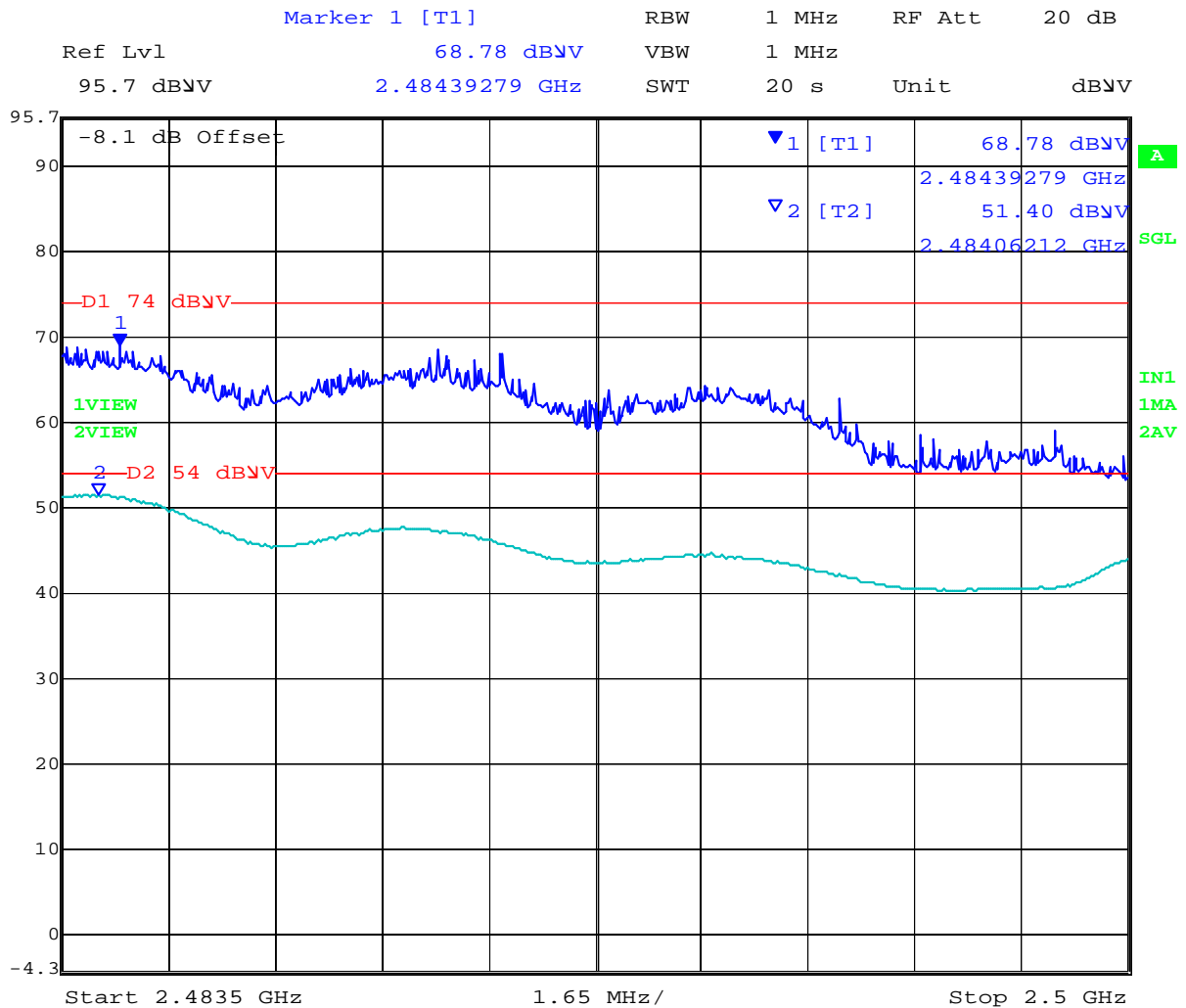

Date: 15.JAN.2014 13:53:30

This test report may be reproduced in full only. The document may only be updated by MiCOM Labs personnel. Any changes will be noted in the Document History section of the report.



11n HT-20 2390 MHz Band Edge

Power Setting = 12

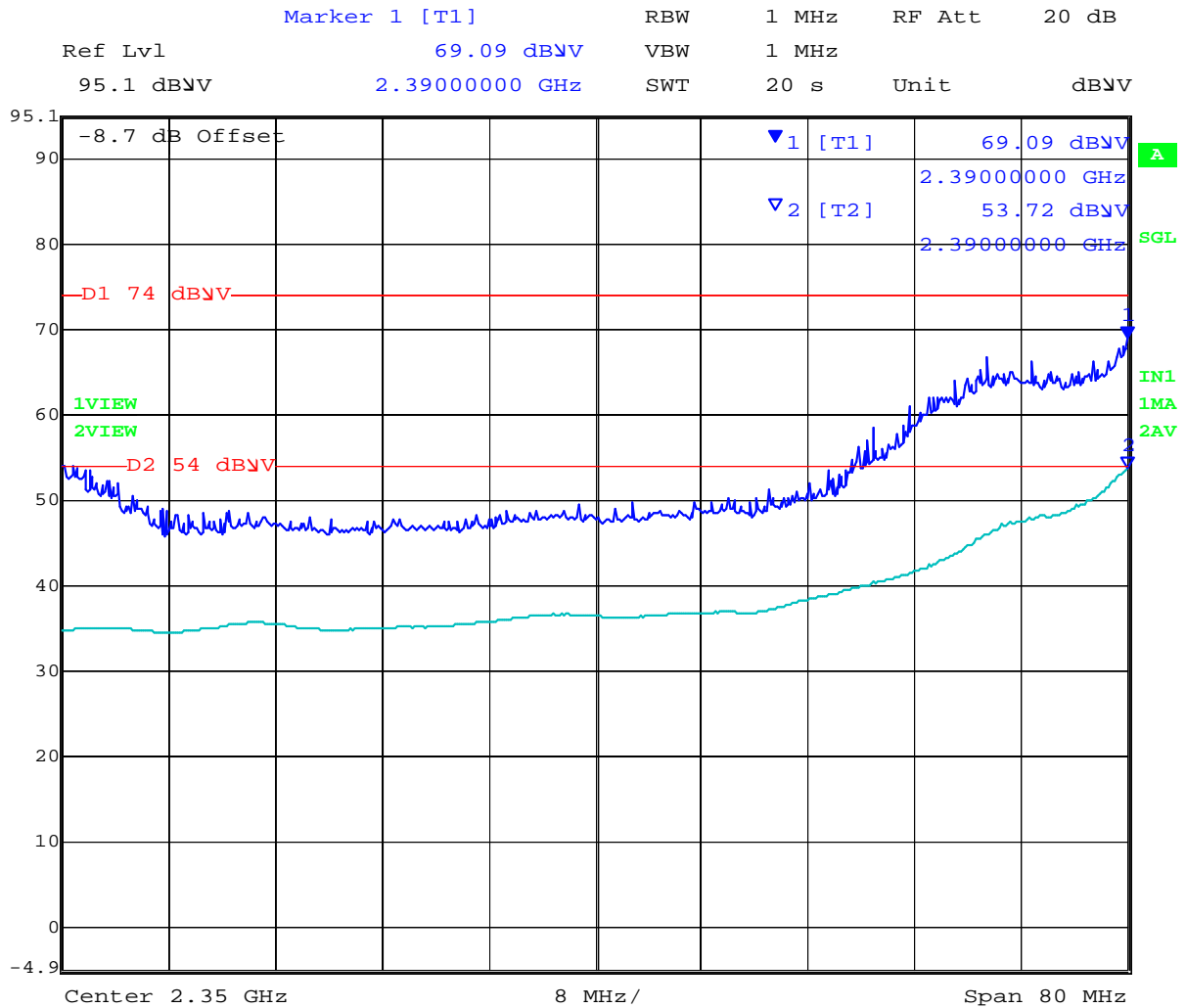

Date: 15.JAN.2014 11:52:26

This test report may be reproduced in full only. The document may only be updated by MiCOM Labs personnel. Any changes will be noted in the Document History section of the report.



11n HT20 2483.5 MHz Band Edge

Power Setting = 14

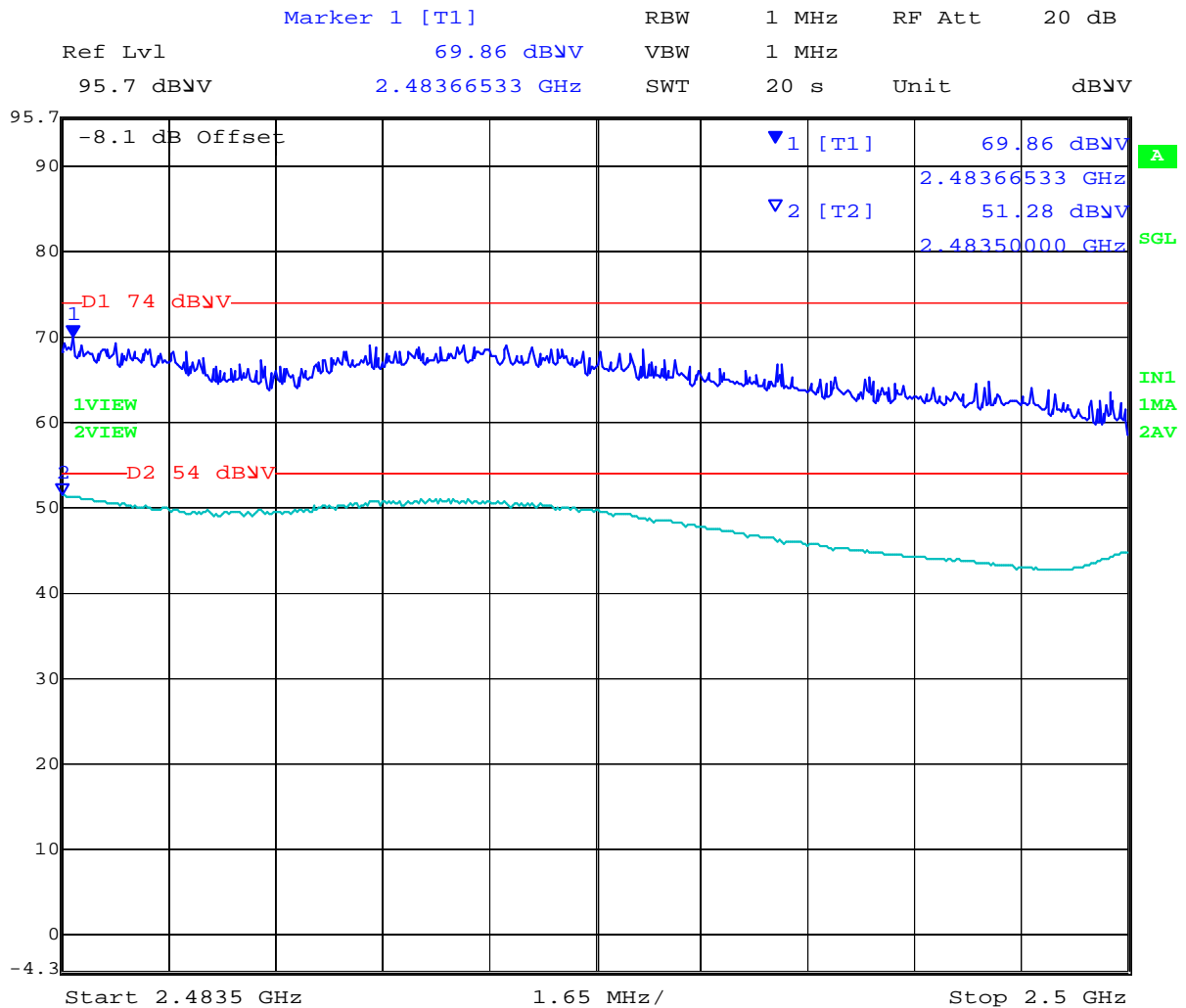

Date: 15.JAN.2014 13:51:08

This test report may be reproduced in full only. The document may only be updated by MiCOM Labs personnel. Any changes will be noted in the Document History section of the report.



11n HT-40 2390 MHz Band Edge

Power Setting = 12

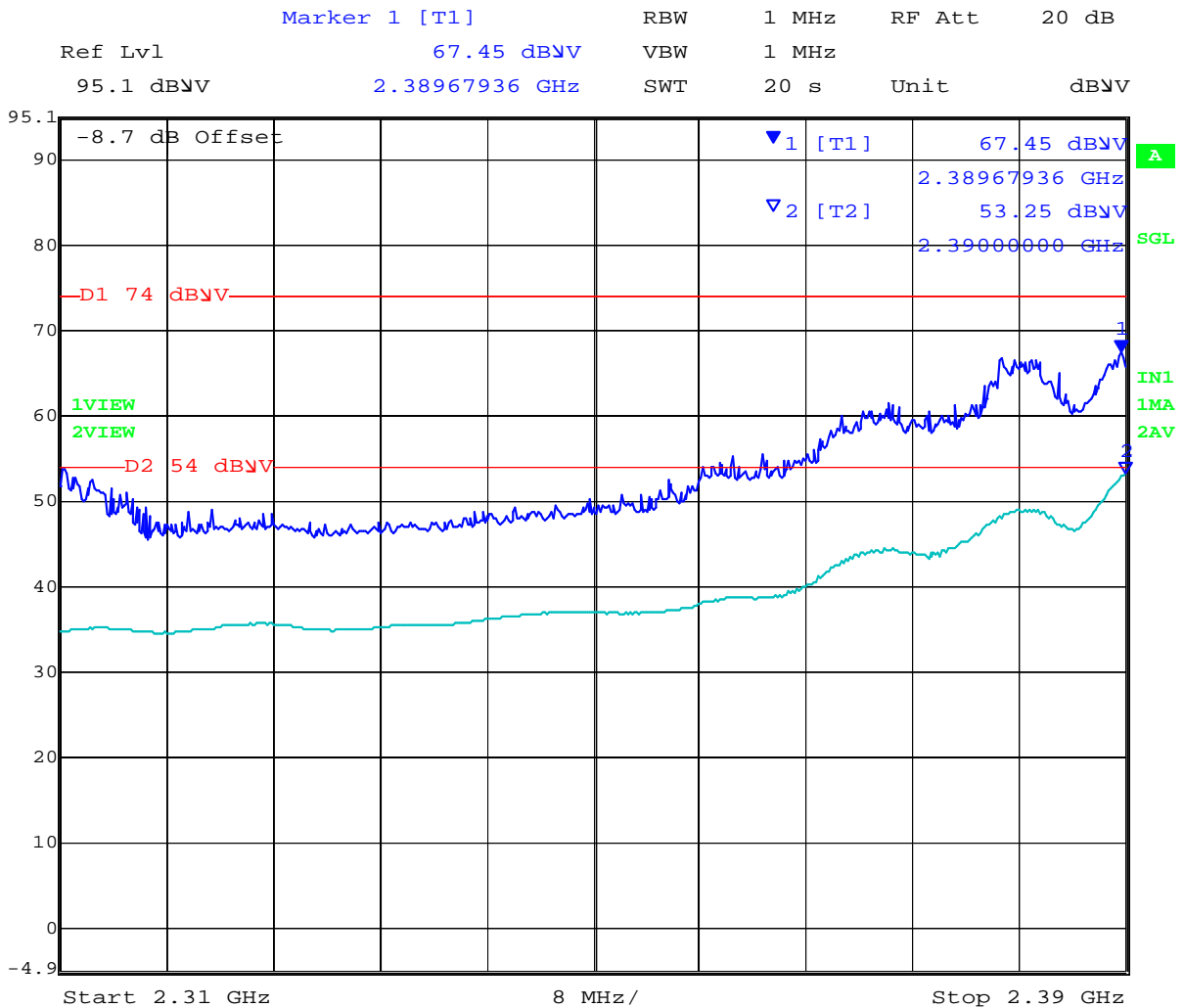

Date: 15.JAN.2014 11:56:16

This test report may be reproduced in full only. The document may only be updated by MiCOM Labs personnel. Any changes will be noted in the Document History section of the report.



11n HT-40 2483.5 MHz Band Edge

Power Setting = 12

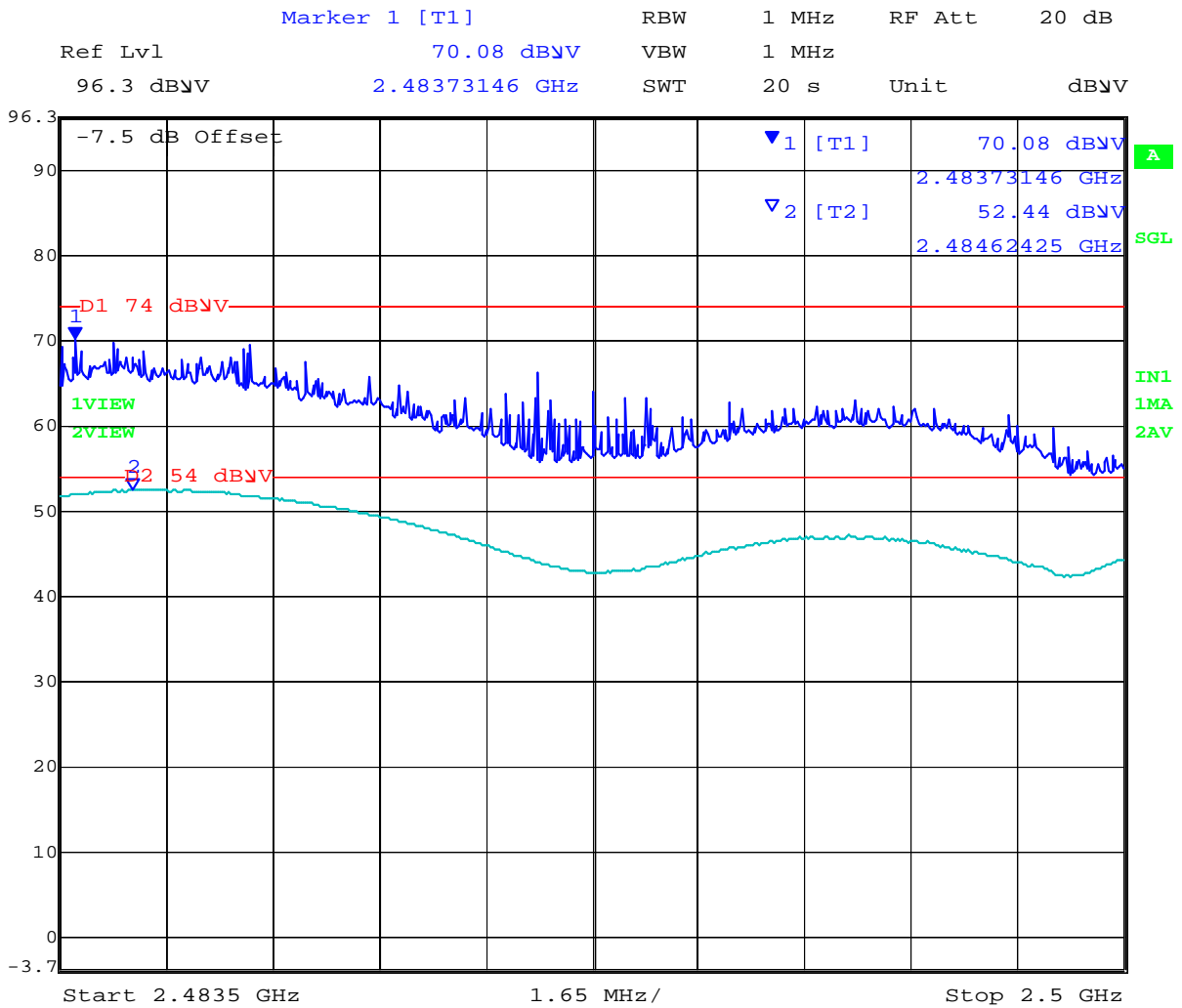

Date: 16.JAN.2014 09:52:11

This test report may be reproduced in full only. The document may only be updated by MiCOM Labs personnel. Any changes will be noted in the Document History section of the report.



11n HT-20 5460 MHz Band Edge

Power Setting = 18

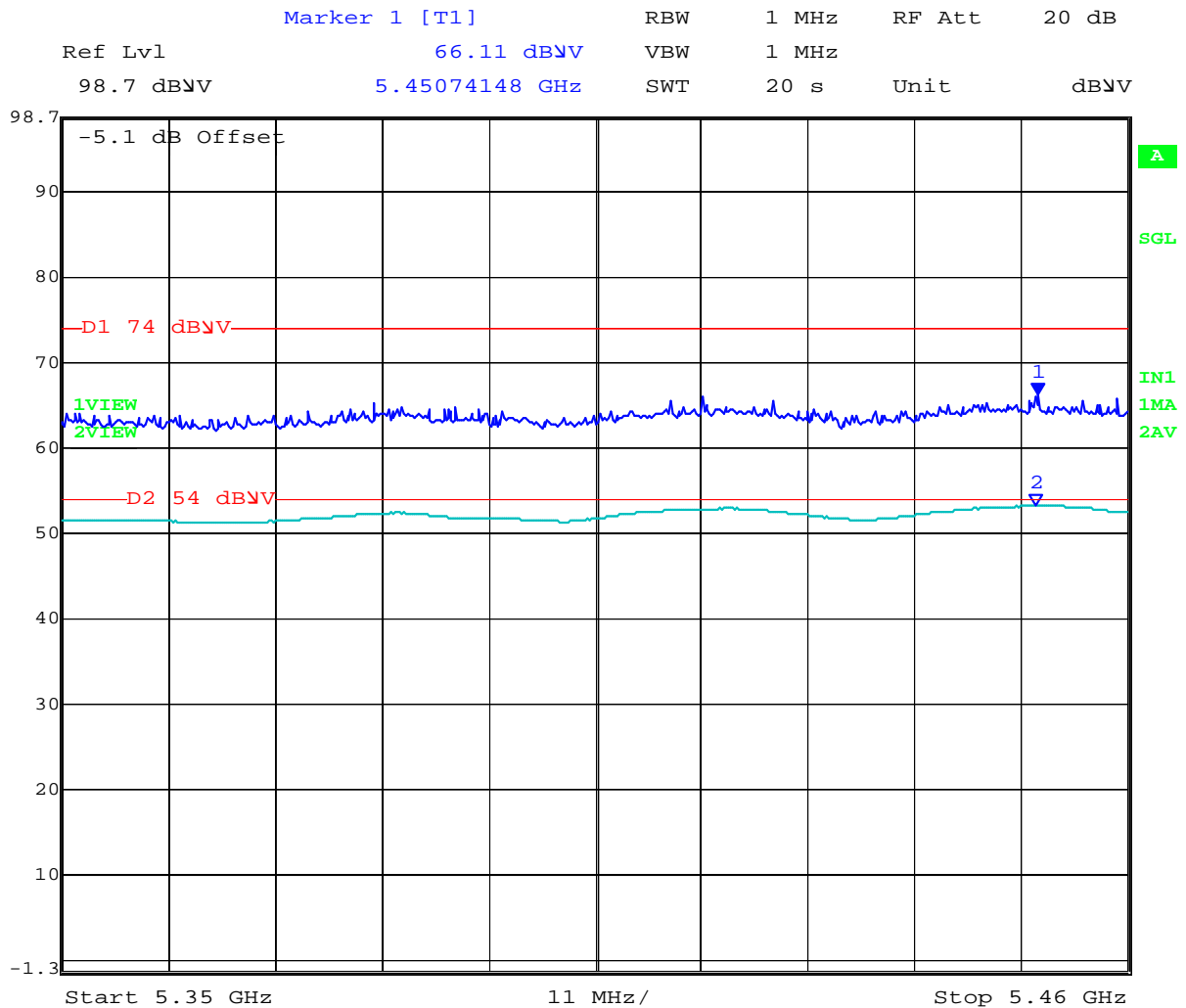

Date: 15.JAN.2014 14:12:15

This test report may be reproduced in full only. The document may only be updated by MiCOM Labs personnel. Any changes will be noted in the Document History section of the report.



Specification Limits

FCC §15.247(d) and RSS-210 §A8.5 In any 100 kHz bandwidth outside the frequency band in which the spread spectrum or digitally modulated intentional radiator is operating, the radio frequency power that is produced by the intentional radiator shall be at least 20 dB below that in the 100 kHz bandwidth within the band that contains the highest level of the desired power, based on either an RF conducted or radiated measurement, provided the transmitter demonstrates compliance with the peak conducted power limits.

FCC §15.247(d)

If the transmitter complies with the conducted power limits based on the use of RMS averaging over a time interval, as permitted under paragraph (b)(3) of this section, the attenuation required under this paragraph shall be 30 dB instead of 20 dB. Attenuation below the general limits specified §15.209(a) is not required. In addition, radiated emissions which fall in the restricted bands, as defined in Section §15.205(a), must also comply with the radiated emission limits specified in Section 15.209(a) (see Section 15.205(a)).

IC RSS-210 §A8.5 If the transmitter complies with the conducted power limits based on the use of RMS averaging over a time interval, as permitted under section A8.4(4), the attenuation required shall be 30 dB instead of 20 dB. Attenuation below the general limits specified in Tables 2 and 3 is not required. In addition, radiated emissions which fall in the restricted bands of Table 1 must also comply with the radiated emission limits specified in Tables 2 and 3.

IC RSS-Gen §4.7

The search for unwanted emissions shall be from the lowest frequency internally generated or used in the device (local oscillator, intermediate or carrier frequency), or from 30 MHz, whichever is the lowest frequency, to the 5th harmonic of the highest frequency generated without exceeding 40 GHz.

FCC §15.205 (a) Except as shown in paragraph (d) of 15.205 (a), only spurious emissions are permitted in any of the frequency bands listed.

FCC §15.205 (a) Except as shown in paragraphs (d) and (e) of this section, the field strength of emissions appearing within these frequency bands shall not exceed the limits shown in Section §15.209. At frequencies equal to or less than 1000 MHz, compliance with the limits in Section 15.209 shall be demonstrated using measurement instrumentation employing a CISPR quasi-peak detector. Above 1000 MHz, compliance with the emission limits in Section 15.209 shall be demonstrated based on the average value of the measured emissions. The provisions in Section 15.35 apply to these measurements.

FCC §15.209 (a) Except as provided elsewhere in this subpart, the emissions from an intentional radiator shall not exceed the field strength levels specified in the following table.



§15.209 (a) Limit Matrix

Frequency(MHz)	Field Strength ($\mu\text{V}/\text{m}$)	Field Strength ($\text{dB}\mu\text{V}/\text{m}$)	Measurement Distance (meters)
30-88	100	40.0	3
88-216	150	43.5	3
216-960	200	46.0	3
Above 960	500	54.0	3

Laboratory Measurement Uncertainty for Radiated Emissions

Measurement uncertainty	+5.6/ -4.5 dB
-------------------------	---------------

Traceability

Method	Test Equipment Used
Measurements were made per work instruction WI-03 'Measurement of Radiated Emissions'	0088, 0158, 0134, 0304, 0311, 0315, 0310, 0312

This test report may be reproduced in full only. The document may only be updated by MiCOM Labs personnel. Any changes will be noted in the Document History section of the report.



5.1.2.3. Digital Emissions (0.03-1 GHz)

FCC, Part 15 Subpart C §15.205/ §15.209
Industry Canada RSS-210 §2.2

Test Procedure

Testing 30M-1 GHz was performed in a 3-meter anechoic chamber using a CISPR compliant receiver. Preliminary radiated emissions were measured on every azimuth and with the receiving antenna in both horizontal and vertical polarizations. To further maximize emissions the receive antenna was varied between 1 and 4 meters. The emissions are recorded with receiver in peak hold mode. Emissions closest to the limits are measured in the quasi-peak mode with the tuned receiver using a bandwidth of 120 kHz. Only the highest emissions relative to the limit are listed. The anechoic chamber test set-up is identified in Section 6 Test Set-Up Photographs.

The EUT had two methods of powering on ac/dc converter and Power over Ethernet (POE). Both modes were tested for emissions below 1GHz.

Field Strength Calculation

The field strength is calculated by adding the Antenna Factor and Cable Loss, and subtracting Amplifier Gain from the measured reading. In this test facility, the Antenna Factor, Cable Loss, and Amplifier Gains are loaded into the Rohde & Schwarz Receiver and the corrected field strength can be read directly on the receiver.

$$FS = R + AF + CORR$$

where:

FS = Field Strength
R = Measured Receiver Input Amplitude
AF = Antenna Factor
CORR = Correction Factor = CL – AG + NFL
CL = Cable Loss
AG = Amplifier Gain

For example:

Given a Receiver input reading of 51.5dB μ V; Antenna Factor of 8.5dB; Cable Loss of 1.3dB; Falloff Factor of 0dB, an Amplifier Gain of 26dB and Notch Filter Loss of 1dB. The Field Strength of the measured emission is:

$$FS = 51.5 + 8.5 + 1.3 - 26.0 + 1 = 36.3\text{dB}\mu\text{V/m}$$

Conversion between dB μ V/m (or dB μ V) and μ V/m (or μ V) are done as:

$$\text{Level (dB}\mu\text{V/m)} = 20 * \text{Log (level (\mu\text{V/m}))}$$

$$40 \text{ dB}\mu\text{V/m} = 100\mu\text{V/m}$$
$$48 \text{ dB}\mu\text{V/m} = 250\mu\text{V/m}$$



Title: Xirrus Inc. XI-AC1300, XI-AC867
To: FCC 47 CFR Part 15.247 & IC RSS-210
Serial #: XIRR04-U3 Rev A
Issue Date: 29th April 2014
Page: 126 of 572

Test Freq.	2437 MHz	Engineer	SB
Variant	Digital Emissions	Temp (°C)	22.5
Freq. Range	30 MHz - 1000 MHz	Rel. Hum.(%)	25
Power Setting	Target	Press. (mBars)	1007
Antenna	Integral		
Test Notes 1			
Test Notes 2			

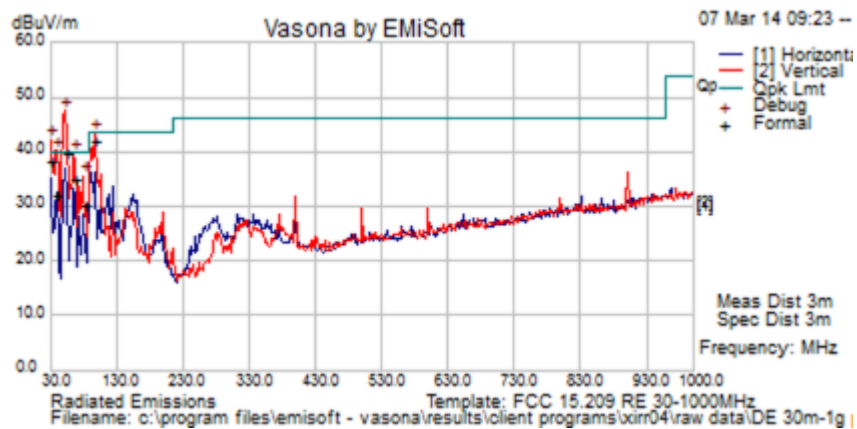

Formally measured emission peaks

Frequency MHz	Raw dBuV	Cable Loss	AF dB	Level dBuV/m	Measurement Type	Pol	Hgt cm	Azt Deg	Limit dBuV/m	Margin dB	Pass /Fail	Comments
54.139	60.1	3.7	-24.0	39.8	Quasi Max	V	103	212	40	-0.2	Pass	
30.000	44.4	3.5	-9.7	38.1	Quasi Max	V	109	35	40	-1.9	Pass	
37.776	44.3	3.6	-15.9	32.0	Quasi Max	V	123	83	40	-8.0	Pass	
97.252	60.0	4.1	-22.1	42.0	Quasi Max	V	98	27	43.5	-1.5	Pass	
66.608	54.5	3.8	-23.4	34.9	Quasi Max	V	115	303	40	-5.1	Pass	
80.025	49.7	3.9	-23.5	30.1	Quasi Max	V	143	77	40	-9.9	Pass	

Legend: DIG = Digital Device Emission; TX = Transmitter Emission; FUND = Fundamental Frequency
 NRB = Non-Restricted Band, Limit is 20 dB below Fundamental; RB = Restricted Band

This test report may be reproduced in full only. The document may only be updated by MiCOM Labs personnel. Any changes will be noted in the Document History section of the report.



Specification

Limits

§15.205 (a) Except as shown in paragraph (d) of 15.205 (a), only spurious emissions are permitted in any of the frequency bands listed.

§15.205 (a) Except as shown in paragraphs (d) and (e) of this section, the field strength of emissions appearing within these frequency bands shall not exceed the limits shown in Section §15.209. At frequencies equal to or less than 1000 MHz, compliance with the limits in Section 15.209 shall be demonstrated using measurement instrumentation employing a CISPR quasi-peak detector. Above 1000 MHz, compliance with the emission limits in Section 15.209 shall be demonstrated based on the average value of the measured emissions. The provisions in Section 15.35 apply to these measurements.

§15.209 (a) Except as provided elsewhere in this subpart, the emissions from an intentional radiator shall not exceed the field strength levels specified in the following table.

§15.209 (a) and RSS-Gen §2.2 Limit Matrix

Frequency(MHz)	Field Strength (µV/m)	Field Strength (dBµV/m)	Measurement Distance (meters)
30-88	100	40.0	3
88-216	150	43.5	3
216-960	200	46.0	3
Above 960	500	54.0	3

Laboratory Measurement Uncertainty for Radiated Emissions

Measurement uncertainty	+5.6/ -4.5 dB
-------------------------	---------------

Traceability

Method	Test Equipment Used
Measurements were made per work instruction WI-03 'Measurement of Radiated Emissions'	0088, 0158, 0134, 0304, 0311, 0315, 0310, 0312

This test report may be reproduced in full only. The document may only be updated by MiCOM Labs personnel. Any changes will be noted in the Document History section of the report.

5.1.3. AC Wireline Conducted Emissions (150 kHz – 30 MHz)

FCC, Part 15 Subpart C §15.207
Industry Canada RSS-Gen §7.2.2

Test Procedure

The EUT is configured in accordance with ANSI C63.4. The conducted emissions are measured in a shielded room with a spectrum analyzer in peak hold in the first instance. Emissions closest to the limit are measured in the quasi-peak mode (QP) with the tuned receiver using a bandwidth of 9 kHz. The emissions are maximized further by cable manipulation. The highest emissions relative to the limit are listed.

Test Measurement Set up

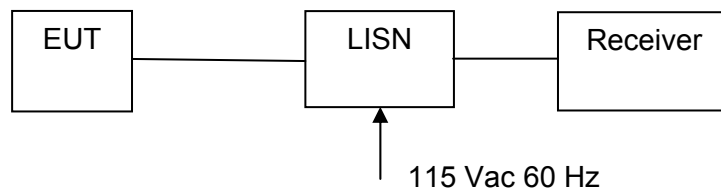

Measurement set up for AC Wireline Conducted Emissions Test

Measurement Results for AC Wireline Conducted Emissions (150 kHz – 30 MHz)

Ambient conditions.

Temperature: 17 to 23 °C Relative humidity: 31 to 57 % Pressure: 999 to 1012 mbar



Title: Xirrus Inc. XI-AC1300, XI-AC867
To: FCC 47 CFR Part 15.247 & IC RSS-210
Serial #: XIRR04-U3 Rev A
Issue Date: 29th April 2014
Page: 129 of 572

Test Freq.	N/A	Engineer	JMH
Variant	AC Line Emissions	Temp (°C)	23
Freq. Range	0.150 MHz - 30 MHz	Rel. Hum.(%)	35
Power Setting	NA	Press. (mBars)	1008
Antenna	N/A		
Test Notes 1	EUT CHASSIS Model#XR-2426, SN#XR213470F09C9, PowerDsine Model 3501G POE		
Test Notes 2	230 Vac, 50 Hz		

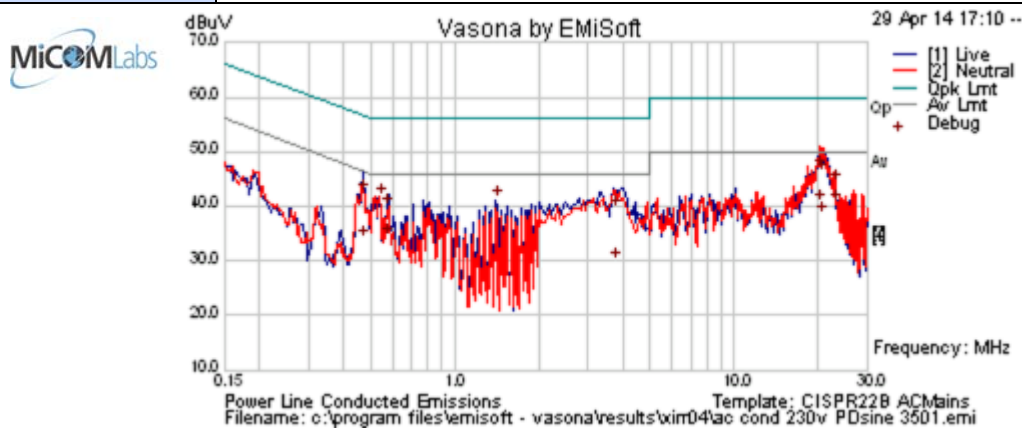

Formally measured emission peaks

Frequency MHz	Raw dBuV	Cable Loss	Factors dB	Level dBuV	Measurement Type	Line	Limit dBuV	Margin dB	Pass /Fail	Comments
0.469	24.0	9.9	0.1	34.0	Average	Live	46.5	-12.5	Pass	
0.469	32.5	9.9	0.1	42.5	Quasi Peak	Live	56.5	-14.0	Pass	
0.574	24.4	9.9	0.1	34.4	Average	Live	46.0	-11.6	Pass	
0.574	29.7	9.9	0.1	39.7	Quasi Peak	Live	56.0	-16.3	Pass	
3.743	29.3	10.1	0.2	39.6	Quasi Peak	Live	56.0	-16.4	Pass	
3.743	19.8	10.1	0.2	30.1	Average	Live	46.0	-16.0	Pass	
20.258	35.7	10.5	0.7	46.9	Quasi Peak	Neutral	60.0	-13.1	Pass	
20.258	29.1	10.5	0.7	40.4	Average	Neutral	50.0	-9.6	Pass	
20.648	27.1	10.5	0.8	38.4	Average	Live	50.0	-11.6	Pass	
20.648	35.0	10.5	0.8	46.3	Quasi Peak	Live	60.0	-13.8	Pass	
23.130	29.0	10.6	0.9	40.4	Average	Neutral	50.0	-9.6	Pass	
23.130	32.8	10.6	0.9	44.3	Quasi Peak	Neutral	60.0	-15.7	Pass	
0.539	31.7	9.9	0.1	41.7	Peak [Scan]	Neutral	46.0	-4.3	Pass	
1.411	31.1	10.0	0.1	41.1	Peak [Scan]	Live	46.0	-4.9	Pass	

Legend: DIG = Digital Device Emission; TX = Transmitter Emission; FUND = Fundamental Frequency
 NRB = Non-Restricted Band, Limit is 20 dB below Fundamental; RB = Restricted Band

This test report may be reproduced in full only. The document may only be updated by MiCOM Labs personnel. Any changes will be noted in the Document History section of the report.



Specification

Limit

§15.207 (a) Except as shown in paragraphs (b) and (c) of this section, for an intentional radiator that is designed to be connected to the public utility (AC) power line, the radio frequency voltage that is conducted back onto the AC power line on any frequency or frequencies within the band 150 kHz to 30 MHz shall not exceed the limits in the following table, as measured using a 50 $\mu\Omega$ line impedance stabilization network (LISN), see §15.207 (a) matrix below. Compliance with the provisions of this paragraph shall be based on the measurement of the radio frequency voltage between each power line and ground at the power terminal.

RSS-Gen §7.2.2

The radio frequency voltage that is conducted back into the AC power lines in the frequency range of 0.15 MHz to 30 MHz shall not exceed the limits shown in the table below. The tighter limit applies at the frequency range boundaries.

§15.207 (a) and RSS-Gen §7.2.2 Limit Matrix

The lower limit applies at the boundary between frequency ranges

Frequency of Emission (MHz)	Conducted Limit (dB μ V)	
	Quasi-peak	Average
0.15-0.5	66 to 56*	56 to 46*
0.5-5	56	46
5-30	60	50

* Decreases with the logarithm of the frequency

Laboratory Measurement Uncertainty for Conducted Emissions

Measurement uncertainty	± 2.64 dB
-------------------------	---------------

Traceability

Method	Test Equipment Used
Measurements were made per work instruction WI-EMC-01 'Measurement of Conducted Emissions'	0158, 0184, 0287, 0190, 0293, 0307

This test report may be reproduced in full only. The document may only be updated by MiCOM Labs personnel. Any changes will be noted in the Document History section of the report.

6. PHOTOGRAPHS

6.1. Conducted Test Setup

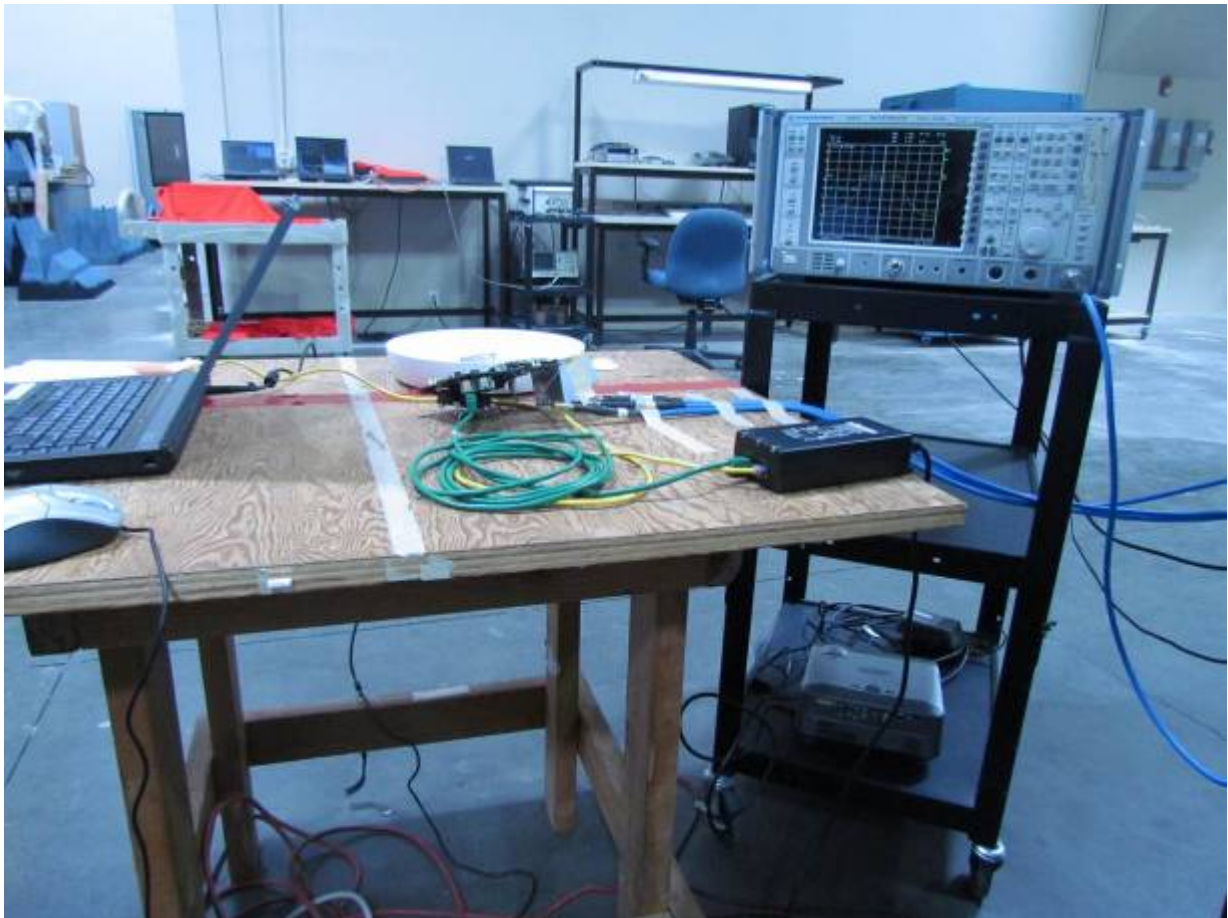

This test report may be reproduced in full only. The document may only be updated by MiCOM Labs personnel. Any changes will be noted in the Document History section of the report.

6.2. Test Setup - Digital Emissions below 1 GHz

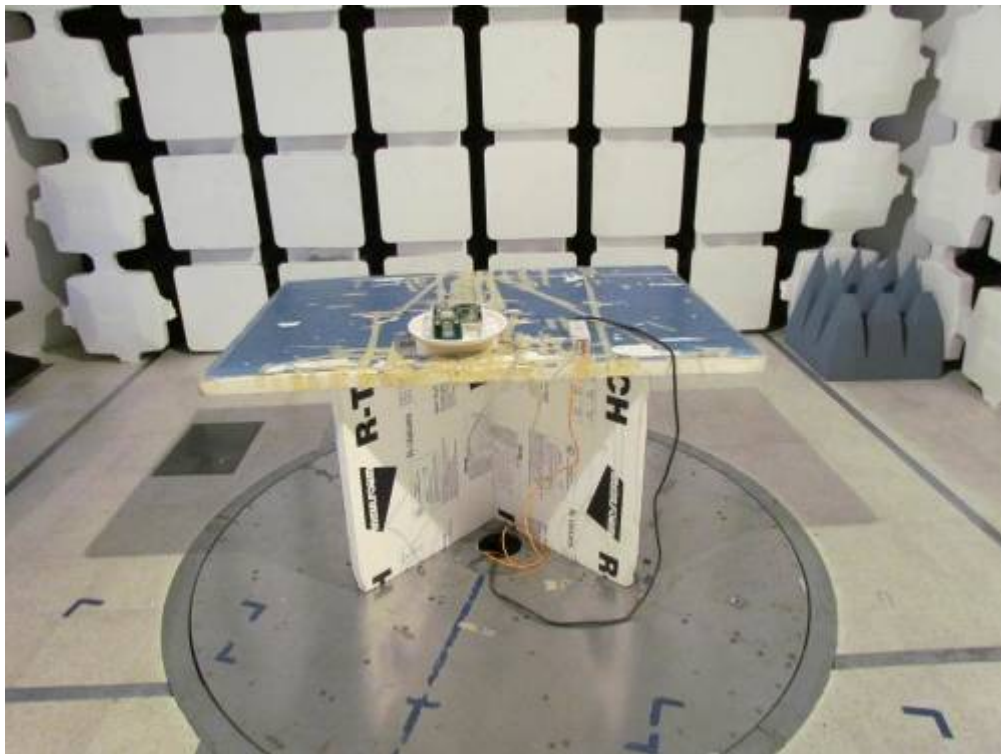

This test report may be reproduced in full only. The document may only be updated by MiCOM Labs personnel. Any changes will be noted in the Document History section of the report.

6.3. Radiated Emissions Test Setup >1 GHz

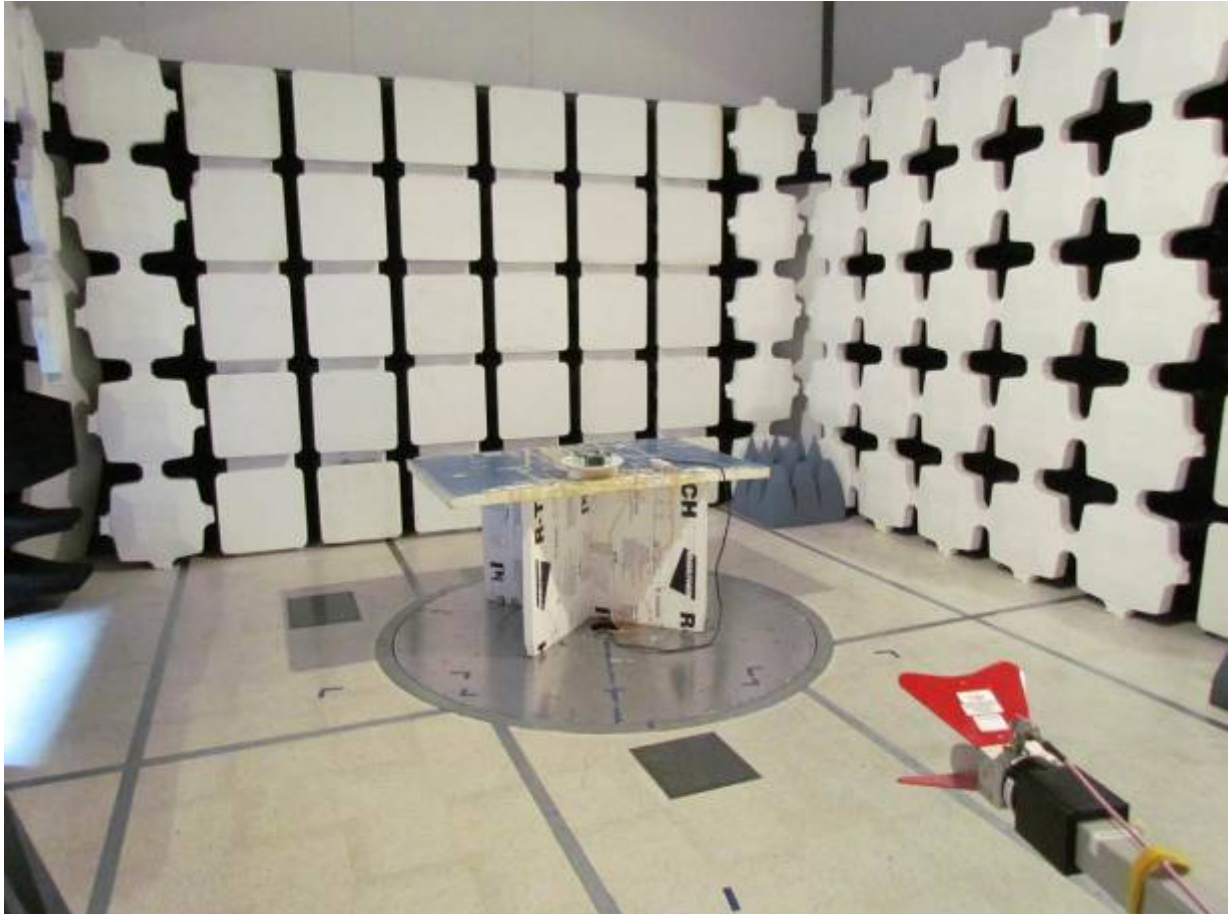

This test report may be reproduced in full only. The document may only be updated by MiCOM Labs personnel. Any changes will be noted in the Document History section of the report.



Title: Xirrus Inc. XI-AC1300, XI-AC867
To: FCC 47 CFR Part 15.247 & IC RSS-210
Serial #: XIRR04-U3 Rev A
Issue Date: 29th April 2014
Page: 134 of 572

7. TEST EQUIPMENT

Asset #	Instrument	Manufacturer	Part #	Serial #	Calibration Due Date
0117	Power Sensor	Hewlett Packard	8487D	3318A00371	18 th Oct 14
0223	Power Meter	Hewlett Packard	EPM-442A	US37480256	18 th Oct 14
0376	Power Sensor	Agilent	U2000A	MY51440005	28 th Oct 14
0390	Power Sensor	Agilent	U2002A	MY50000103	17 th Oct 14
0158	Barometer /Thermometer	Control Co.	4196	E2846	6 th Dec 14
0193	EMI Receiver	Rhode & Schwartz	ESI 7	838496/007	2 nd Dec 14
0287	EMI Receiver	Rhode & Schwartz	ESIB40	100201	31 st Jul 14
0378	EMI Receiver	Rhode & Schwartz	ESIB40	100107/040	17 th Jul 14
0338	30 - 3000 MHz Antenna	Sunol	JB3	A052907	14 th Aug 14
0399	1-18 GHz Horn Antenna	EMCO	3117	00154575	10 th Oct 14
0252	SMA Cable	Megaphase	Sucoflex 104	None	N/A
0310	2m SMA Cable	Micro-Coax	UFA210A-0-0787-3G03G0	209089-001	N/A
0312	3m SMA Cable	Micro-Coax	UFA210A-1-1181-3G0300	209092-001	N/A
0314	30dB N-Type Attenuator	ARRA	N9444-30	1623	N/A
0359	DFS Test System	Aeroflex	PXI-1042	300001/004	21 st Oct 14
0299	DFS Test Software	Aeroflex	PXI Module	Version 7.1.0	N/A
0502	EMC Test Software	EMISoft	Vasona	5.0051	N/A
0503	RF Conducted Test Software	National Instruments	Labview	Version 8.2	N/A
0398	RF Conducted Test Software	MiCOM Labs ATS	--	Version 1.8	N/A
0380	RF Switch	MiCOM Labs	MIC001	MIC001	20 th March 14

This test report may be reproduced in full only. The document may only be updated by MiCOM Labs personnel. Any changes will be noted in the Document History section of the report.



Title: Xirrus Inc. XI-AC1300, XI-AC867
To: FCC 47 CFR Part 15.247 & IC RSS-210
Serial #: XIRR04-U3 Rev A
Issue Date: 29th April 2014
Page: 135 of 572

APPENDIX

A. SUPPORTING INFORMATION

A.1. 3x3 CONDUCTED TEST PLOTS

This test report may be reproduced in full only. The document may only be updated by MiCOM Labs personnel. Any changes will be noted in the Document History section of the report.



A.1.1. 6 dB & 99% Bandwidth



6 dB & 99% BANDWIDTH

Variant: 802.11b, Channel: 2412.00 MHz, Chain a, Temp: Ambient, Voltage: 56 Vdc

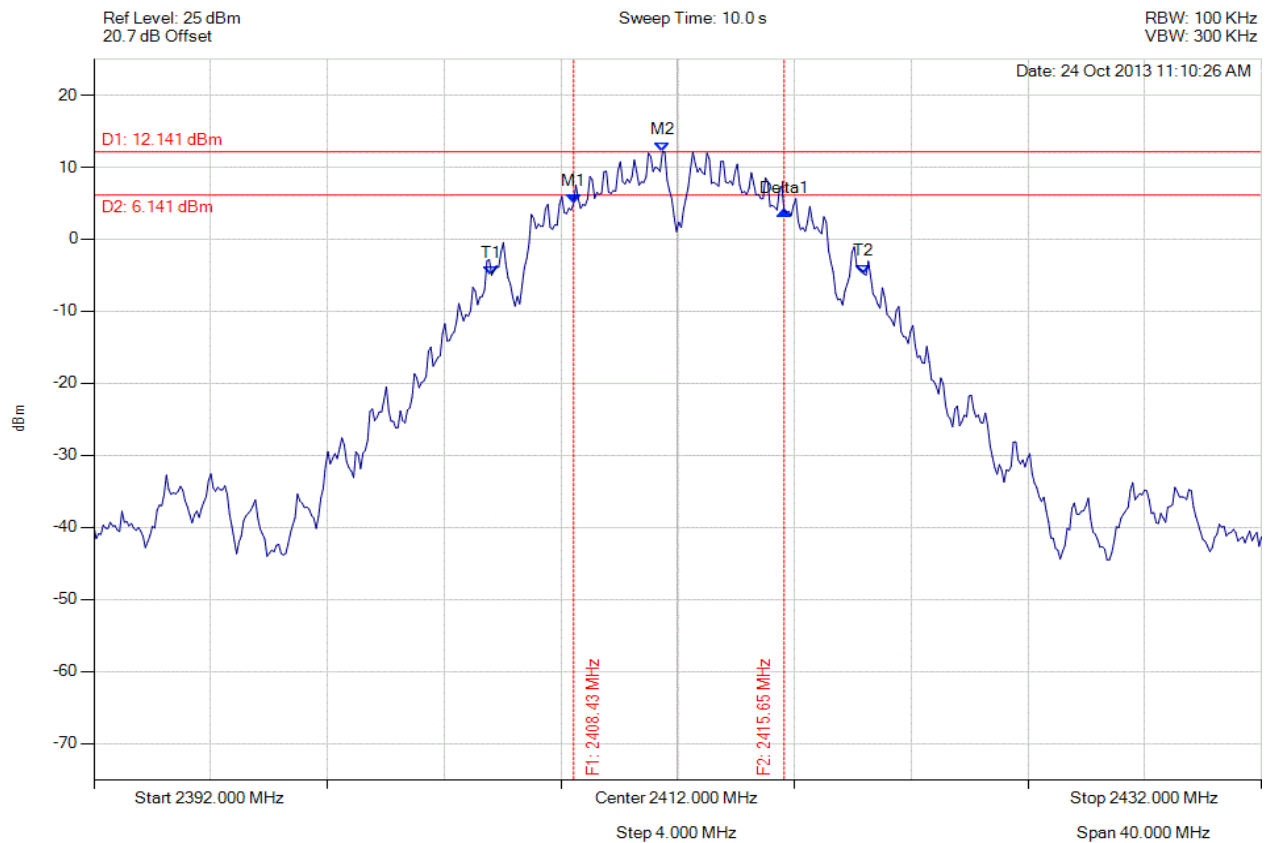

Analyser Setup	Marker : Frequency : Amplitude	Test Results
Detector = MAX PEAK Sweep Count = 0 RF Atten (dB) = 20 Trace Mode = VIEW	M1 : 2408.433 MHz : 4.980 dBm M2 : 2411.479 MHz : 12.141 dBm Delta1 : 7.214 MHz : -1.070 dB T1 : 2405.627 MHz : -5.020 dBm T2 : 2418.373 MHz : -4.782 dBm OBW : 12.745 MHz	Measured 6 dB Bandwidth: 7.214 MHz Limit: ≥ 500.0 kHz Margin: -6.71 MHz

[Back to the Matrix](#)

This test report may be reproduced in full only. The document may only be updated by MiCOM Labs personnel. Any changes will be noted in the Document History section of the report.



6 dB & 99% BANDWIDTH

Variant: 802.11b, Channel: 2412.00 MHz, Chain b, Temp: Ambient, Voltage: 56 Vdc

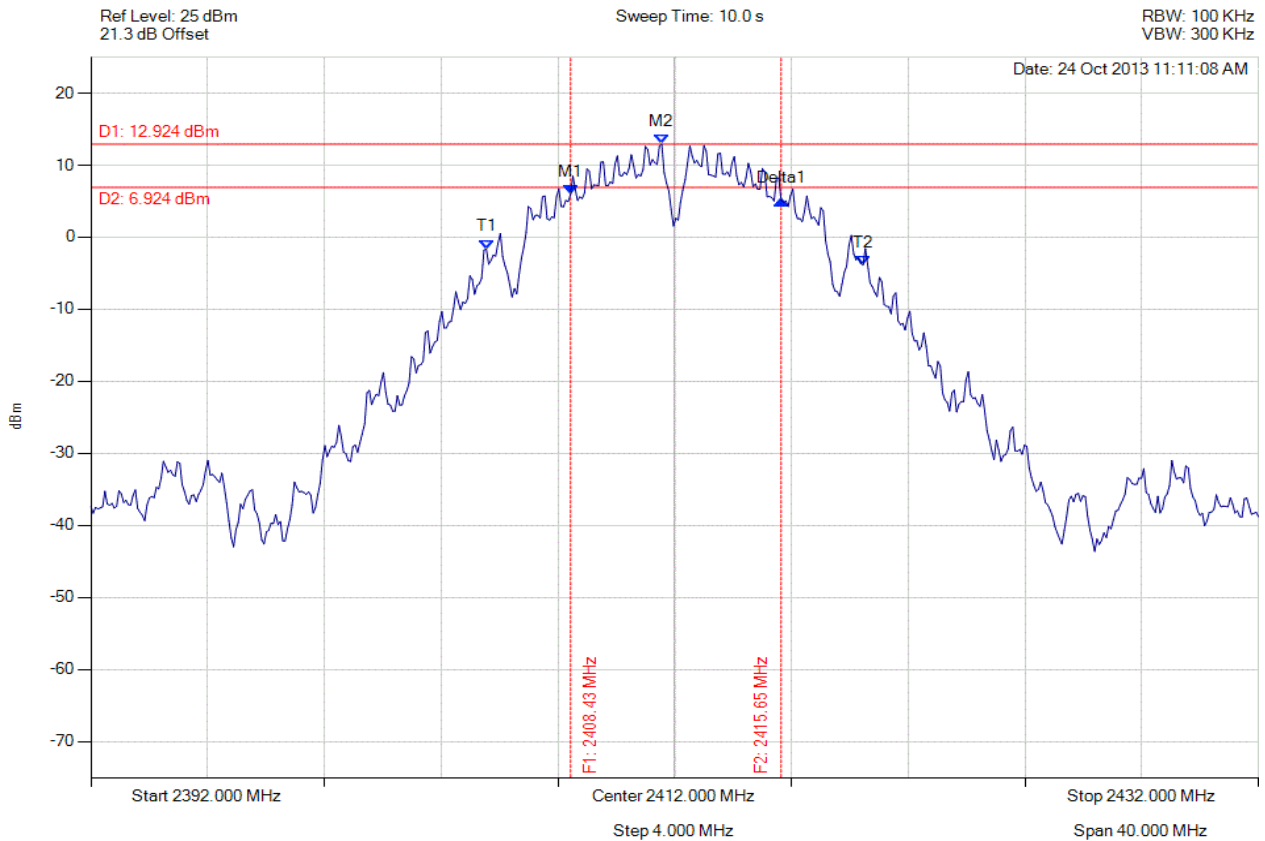

Analyser Setup	Marker : Frequency : Amplitude	Test Results
Detector = MAX PEAK Sweep Count = 0 RF Atten (dB) = 20 Trace Mode = VIEW	M1 : 2408.433 MHz : 5.976 dBm M2 : 2411.559 MHz : 12.924 dBm Delta1 : 7.214 MHz : -0.889 dB T1 : 2405.547 MHz : -1.618 dBm T2 : 2418.453 MHz : -3.879 dBm OBW : 12.906 MHz	Measured 6 dB Bandwidth: 7.214 MHz Limit: ≥ 500.0 kHz Margin: -6.71 MHz

[Back to the Matrix](#)

This test report may be reproduced in full only. The document may only be updated by MiCOM Labs personnel. Any changes will be noted in the Document History section of the report.



Title: Xirrus Inc. XI-AC1300, XI-AC867
To: FCC 47 CFR Part 15.247 & IC RSS-210
Serial #: XIRR04-U3 Rev A
Issue Date: 29th April 2014
Page: 138 of 572



6 dB & 99% BANDWIDTH

Variant: 802.11b, Channel: 2412.00 MHz, Chain c, Temp: Ambient, Voltage: 56 Vdc

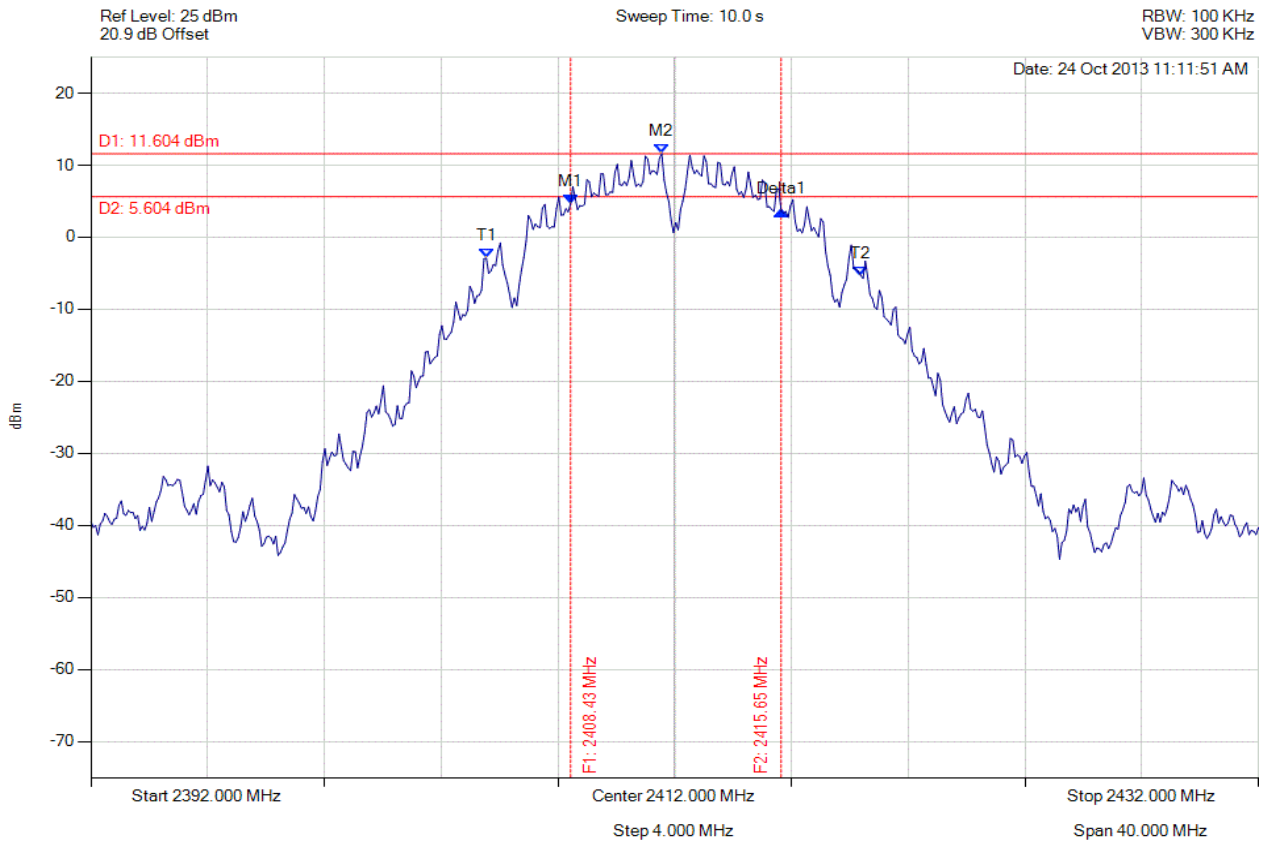

Analyser Setup	Marker : Frequency : Amplitude	Test Results
Detector = MAX PEAK Sweep Count = 0 RF Atten (dB) = 20 Trace Mode = VIEW	M1 : 2408.433 MHz : 4.620 dBm M2 : 2411.559 MHz : 11.604 dBm Delta1 : 7.214 MHz : -1.019 dB T1 : 2405.547 MHz : -2.907 dBm T2 : 2418.373 MHz : -5.303 dBm OBW : 12.826 MHz	Measured 6 dB Bandwidth: 7.214 MHz Limit: ≥ 500.0 kHz Margin: -6.71 MHz

[Back to the Matrix](#)

This test report may be reproduced in full only. The document may only be updated by MiCOM Labs personnel. Any changes will be noted in the Document History section of the report.



Title: Xirrus Inc. XI-AC1300, XI-AC867
To: FCC 47 CFR Part 15.247 & IC RSS-210
Serial #: XIRR04-U3 Rev A
Issue Date: 29th April 2014
Page: 139 of 572



6 dB & 99% BANDWIDTH

Variant: 802.11b, Channel: 2437.00 MHz, Chain a, Temp: Ambient, Voltage: 56 Vdc

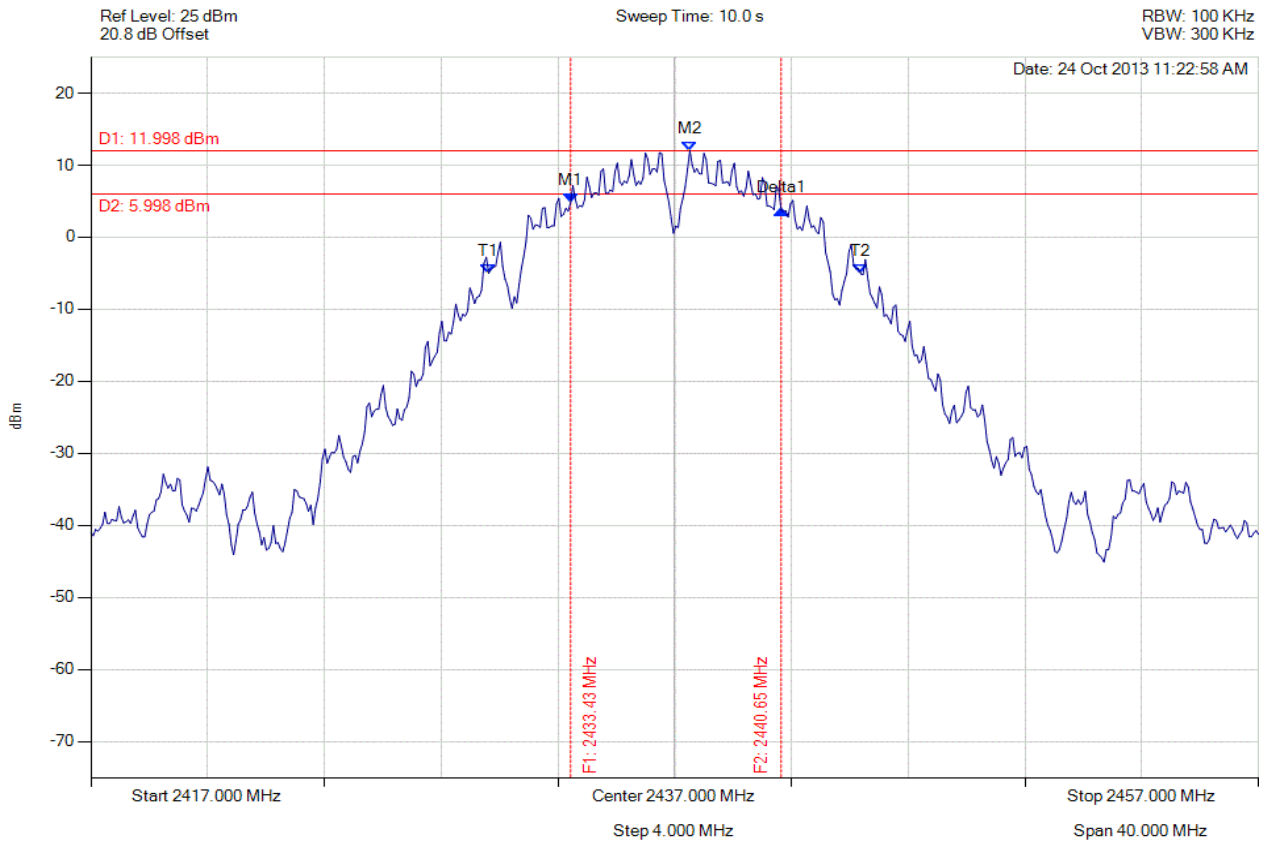

Analyser Setup	Marker : Frequency : Amplitude	Test Results
Detector = MAX PEAK Sweep Count = 0 RF Atten (dB) = 20 Trace Mode = VIEW	M1 : 2433.433 MHz : 4.791 dBm M2 : 2437.521 MHz : 11.998 dBm Delta1 : 7.214 MHz : -1.027 dB T1 : 2430.627 MHz : -5.018 dBm T2 : 2443.373 MHz : -5.065 dBm OBW : 12.745 MHz	Measured 6 dB Bandwidth: 7.214 MHz Limit: ≥ 500.0 kHz Margin: -6.71 MHz

[Back to the Matrix](#)

This test report may be reproduced in full only. The document may only be updated by MiCOM Labs personnel. Any changes will be noted in the Document History section of the report.



Title: Xirrus Inc. XI-AC1300, XI-AC867
To: FCC 47 CFR Part 15.247 & IC RSS-210
Serial #: XIRR04-U3 Rev A
Issue Date: 29th April 2014
Page: 140 of 572



6 dB & 99% BANDWIDTH

Variant: 802.11b, Channel: 2437.00 MHz, Chain b, Temp: Ambient, Voltage: 56 Vdc

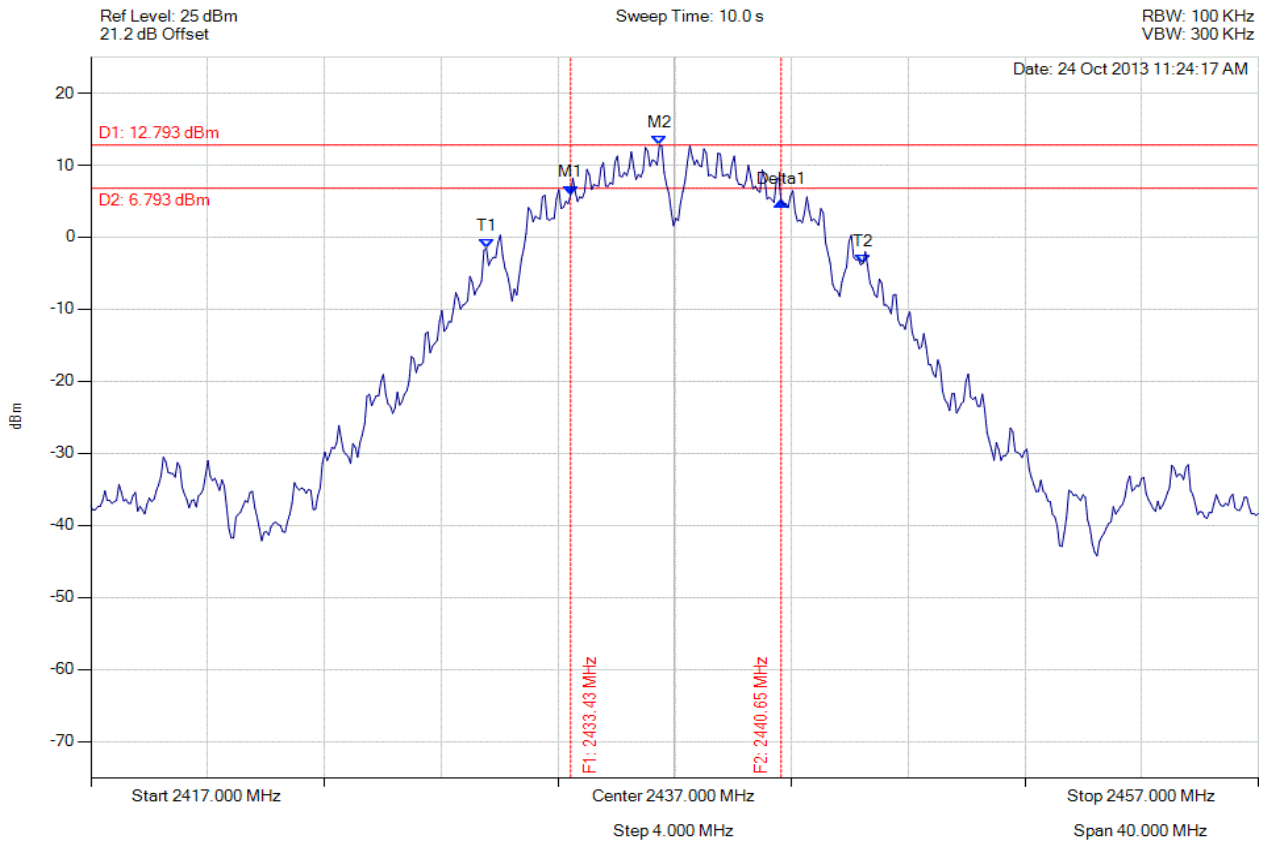

Analyser Setup	Marker : Frequency : Amplitude	Test Results
Detector = MAX PEAK Sweep Count = 0 RF Atten (dB) = 20 Trace Mode = VIEW	M1 : 2433.433 MHz : 5.887 dBm M2 : 2436.479 MHz : 12.793 dBm Delta1 : 7.214 MHz : -0.980 dB T1 : 2430.547 MHz : -1.481 dBm T2 : 2443.453 MHz : -3.631 dBm OBW : 12.906 MHz	Measured 6 dB Bandwidth: 7.214 MHz Limit: ≥ 500.0 kHz Margin: -6.71 MHz

[Back to the Matrix](#)

This test report may be reproduced in full only. The document may only be updated by MiCOM Labs personnel. Any changes will be noted in the Document History section of the report.



Title: Xirrus Inc. XI-AC1300, XI-AC867
To: FCC 47 CFR Part 15.247 & IC RSS-210
Serial #: XIRR04-U3 Rev A
Issue Date: 29th April 2014
Page: 141 of 572



6 dB & 99% BANDWIDTH

Variant: 802.11b, Channel: 2437.00 MHz, Chain c, Temp: Ambient, Voltage: 56 Vdc

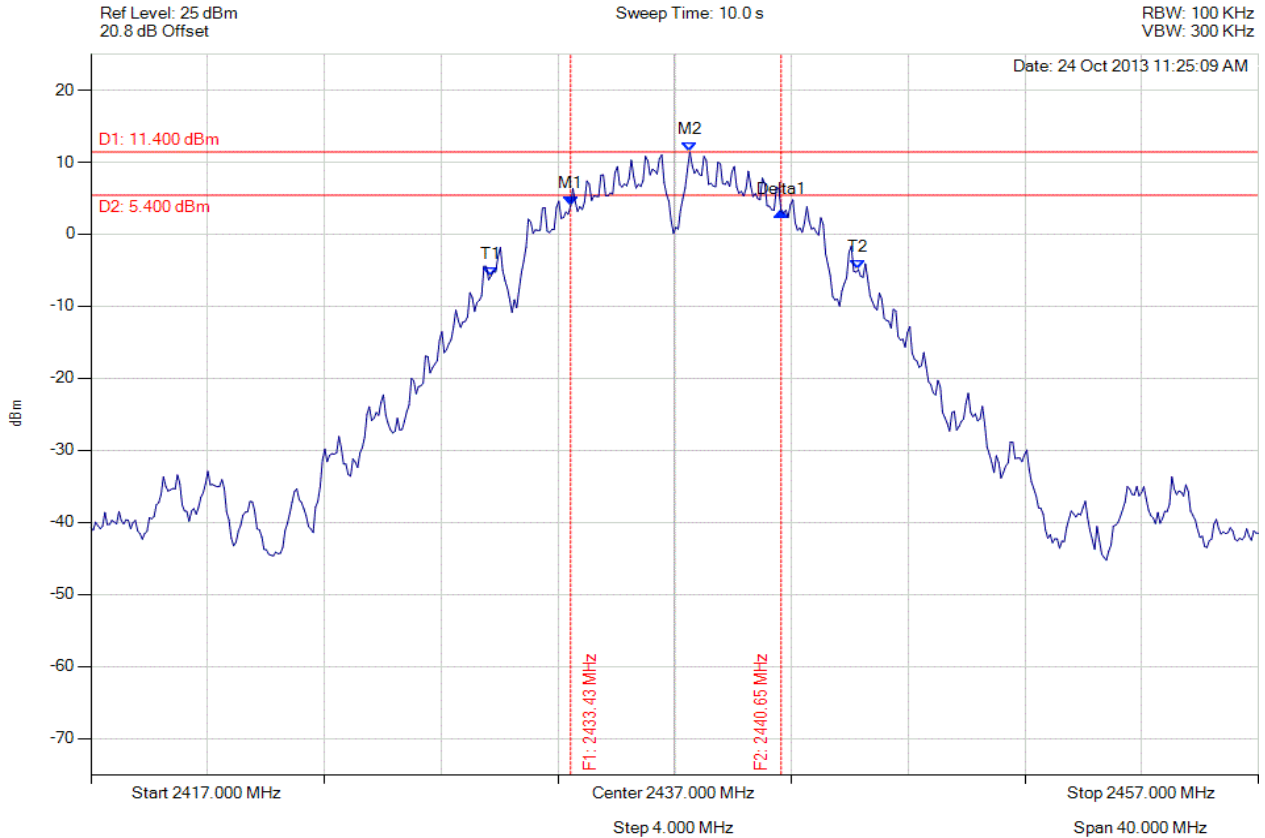

Analyser Setup	Marker : Frequency : Amplitude	Test Results
Detector = MAX PEAK Sweep Count = 0 RF Atten (dB) = 20 Trace Mode = VIEW	M1 : 2433.433 MHz : 3.936 dBm M2 : 2437.521 MHz : 11.400 dBm Delta1 : 7.214 MHz : -0.757 dB T1 : 2430.707 MHz : -5.797 dBm T2 : 2443.293 MHz : -4.908 dBm OBW : 12.585 MHz	Measured 6 dB Bandwidth: 7.214 MHz Limit: ≥500.0 kHz Margin: -6.71 MHz

[Back to the Matrix](#)

This test report may be reproduced in full only. The document may only be updated by MiCOM Labs personnel. Any changes will be noted in the Document History section of the report.



Title: Xirrus Inc. XI-AC1300, XI-AC867
To: FCC 47 CFR Part 15.247 & IC RSS-210
Serial #: XIRR04-U3 Rev A
Issue Date: 29th April 2014
Page: 142 of 572



6 dB & 99% BANDWIDTH

Variant: 802.11b, Channel: 2462.00 MHz, Chain a, Temp: Ambient, Voltage: 56 Vdc

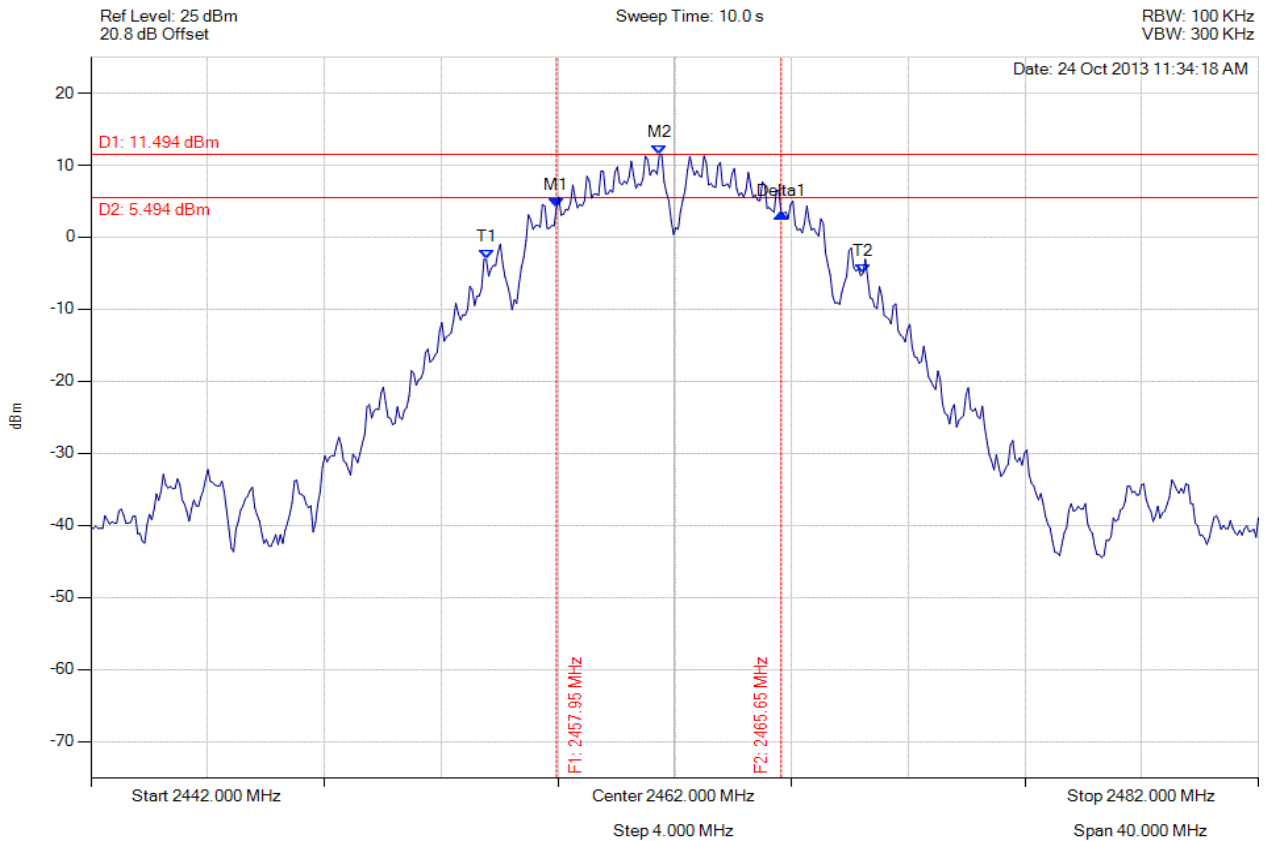

Analyser Setup	Marker : Frequency : Amplitude	Test Results
Detector = MAX PEAK Sweep Count = 0 RF Atten (dB) = 20 Trace Mode = VIEW	M1 : 2457.952 MHz : 4.189 dBm M2 : 2461.479 MHz : 11.494 dBm Delta1 : 7.695 MHz : -0.852 dB T1 : 2455.547 MHz : -3.066 dBm T2 : 2468.453 MHz : -5.059 dBm OBW : 12.906 MHz	Measured 6 dB Bandwidth: 7.695 MHz Limit: ≥500.0 kHz Margin: -7.20 MHz

[Back to the Matrix](#)

This test report may be reproduced in full only. The document may only be updated by MiCOM Labs personnel. Any changes will be noted in the Document History section of the report.



6 dB & 99% BANDWIDTH

Variant: 802.11b, Channel: 2462.00 MHz, Chain b, Temp: Ambient, Voltage: 56 Vdc

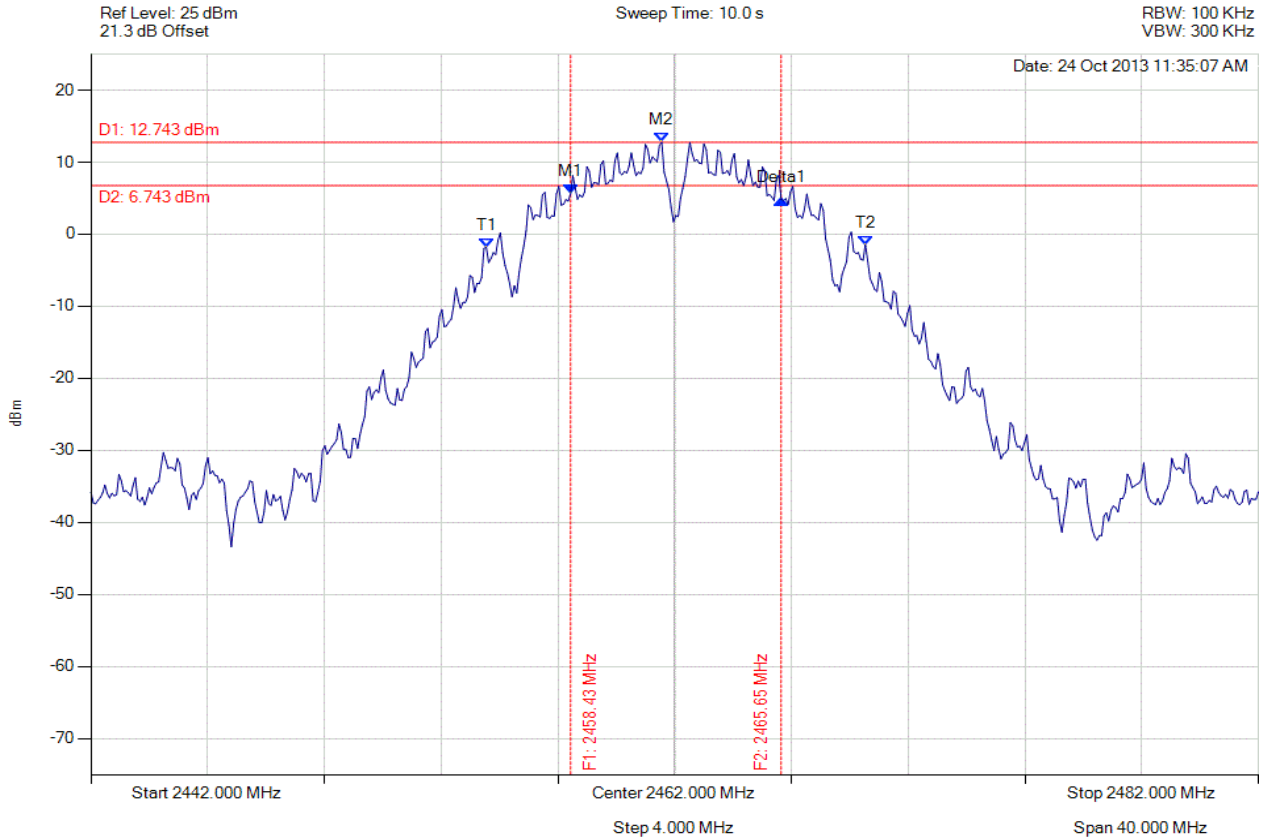

Analyser Setup	Marker : Frequency : Amplitude	Test Results
Detector = MAX PEAK Sweep Count = 0 RF Atten (dB) = 20 Trace Mode = VIEW	M1 : 2458.433 MHz : 5.629 dBm M2 : 2461.559 MHz : 12.743 dBm Delta1 : 7.214 MHz : -0.775 dB T1 : 2455.547 MHz : -1.819 dBm T2 : 2468.533 MHz : -1.473 dBm OBW : 12.986 MHz	Measured 6 dB Bandwidth: 7.214 MHz Limit: ≥ 500.0 kHz Margin: -6.71 MHz

[Back to the Matrix](#)

This test report may be reproduced in full only. The document may only be updated by MiCOM Labs personnel. Any changes will be noted in the Document History section of the report.



Title: Xirrus Inc. XI-AC1300, XI-AC867
To: FCC 47 CFR Part 15.247 & IC RSS-210
Serial #: XIRR04-U3 Rev A
Issue Date: 29th April 2014
Page: 144 of 572



6 dB & 99% BANDWIDTH

Variant: 802.11b, Channel: 2462.00 MHz, Chain c, Temp: Ambient, Voltage: 56 Vdc

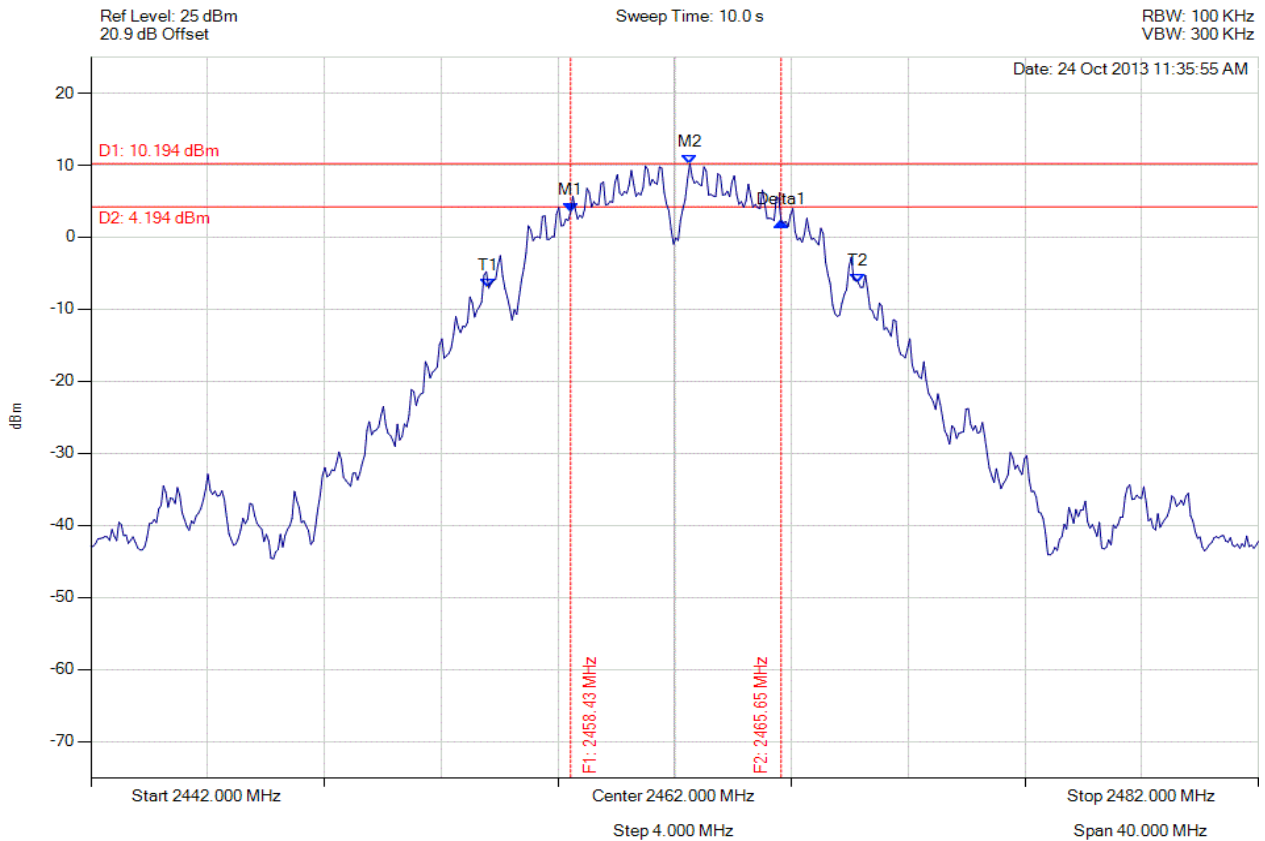

Analyser Setup	Marker : Frequency : Amplitude	Test Results
Detector = MAX PEAK Sweep Count = 0 RF Atten (dB) = 20 Trace Mode = VIEW	M1 : 2458.433 MHz : 3.454 dBm M2 : 2462.521 MHz : 10.194 dBm Delta1 : 7.214 MHz : -1.273 dB T1 : 2455.627 MHz : -7.078 dBm T2 : 2468.293 MHz : -6.326 dBm OBW : 12.665 MHz	Measured 6 dB Bandwidth: 7.214 MHz Limit: ≥500.0 kHz Margin: -6.71 MHz

[Back to the Matrix](#)

This test report may be reproduced in full only. The document may only be updated by MiCOM Labs personnel. Any changes will be noted in the Document History section of the report.



6 dB & 99% BANDWIDTH

Variant: 802.11g, Channel: 2412.00 MHz, Chain a, Temp: Ambient, Voltage: 56 Vdc

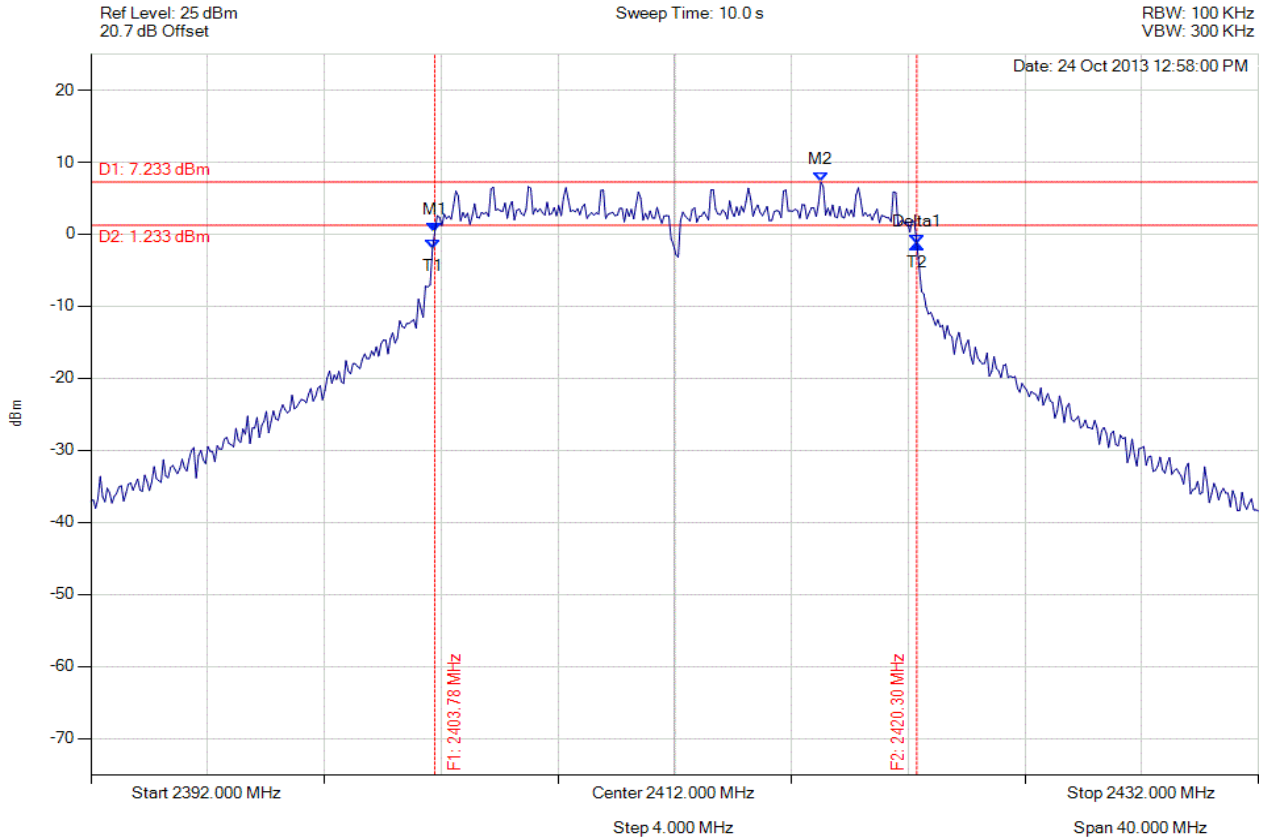

Analyser Setup	Marker : Frequency : Amplitude	Test Results
Detector = MAX PEAK Sweep Count = 0 RF Atten (dB) = 20 Trace Mode = VIEW	M1 : 2403.784 MHz : 0.325 dBm M2 : 2417.010 MHz : 7.233 dBm Delta1 : 16.513 MHz : -1.763 dB T1 : 2403.703 MHz : -1.996 dBm T2 : 2420.297 MHz : -1.439 dBm OBW : 16.593 MHz	Measured 6 dB Bandwidth: 16.513 MHz Limit: ≥ 500.0 kHz Margin: -16.01 MHz

[Back to the Matrix](#)

This test report may be reproduced in full only. The document may only be updated by MiCOM Labs personnel. Any changes will be noted in the Document History section of the report.



6 dB & 99% BANDWIDTH

Variant: 802.11g, Channel: 2412.00 MHz, Chain b, Temp: Ambient, Voltage: 56 Vdc

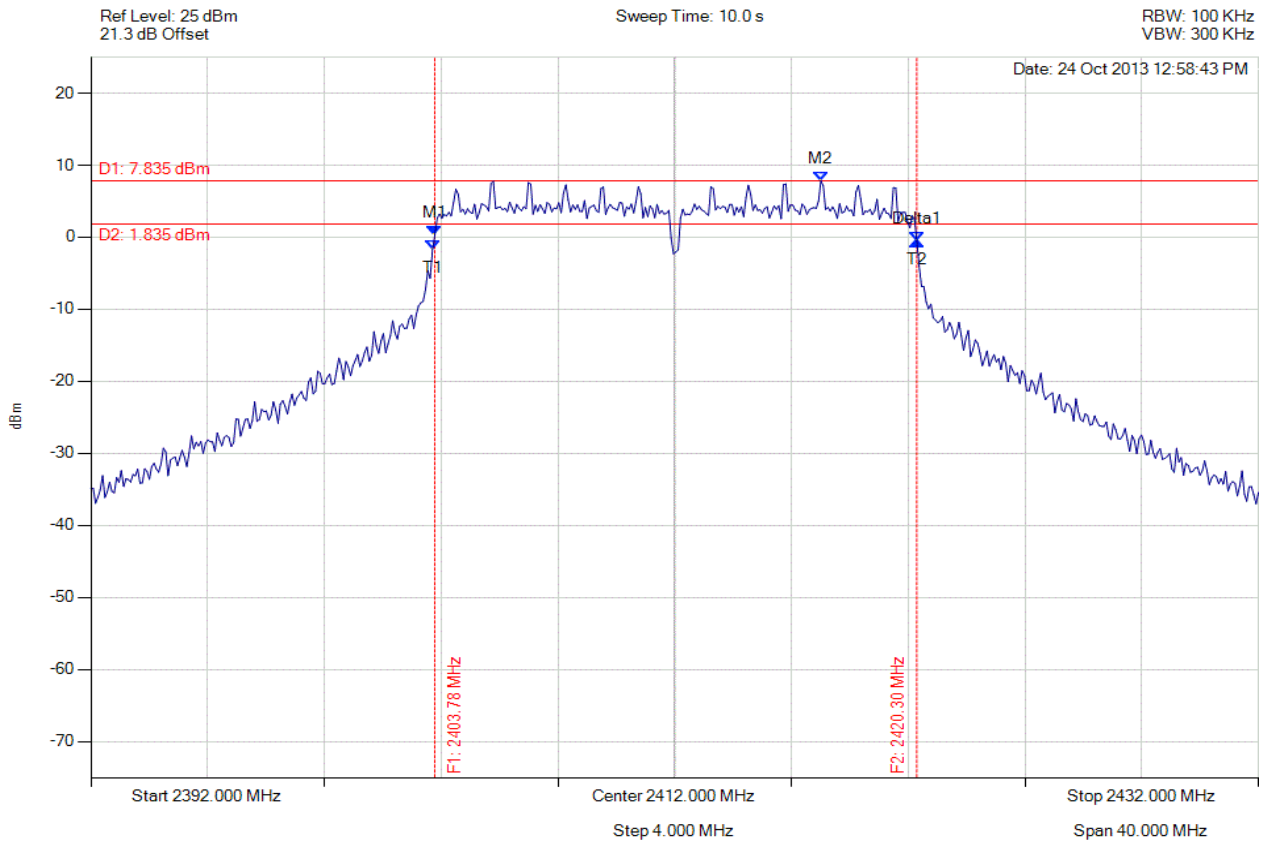

Analyser Setup	Marker : Frequency : Amplitude	Test Results
Detector = MAX PEAK Sweep Count = 0 RF Atten (dB) = 20 Trace Mode = VIEW	M1 : 2403.784 MHz : 0.270 dBm M2 : 2417.010 MHz : 7.835 dBm Delta1 : 16.513 MHz : -0.803 dB T1 : 2403.703 MHz : -1.723 dBm T2 : 2420.297 MHz : -0.534 dBm OBW : 16.593 MHz	Measured 6 dB Bandwidth: 16.513 MHz Limit: ≥ 500.0 kHz Margin: -16.01 MHz

[Back to the Matrix](#)

This test report may be reproduced in full only. The document may only be updated by MiCOM Labs personnel. Any changes will be noted in the Document History section of the report.



6 dB & 99% BANDWIDTH

Variant: 802.11g, Channel: 2412.00 MHz, Chain c, Temp: Ambient, Voltage: 56 Vdc

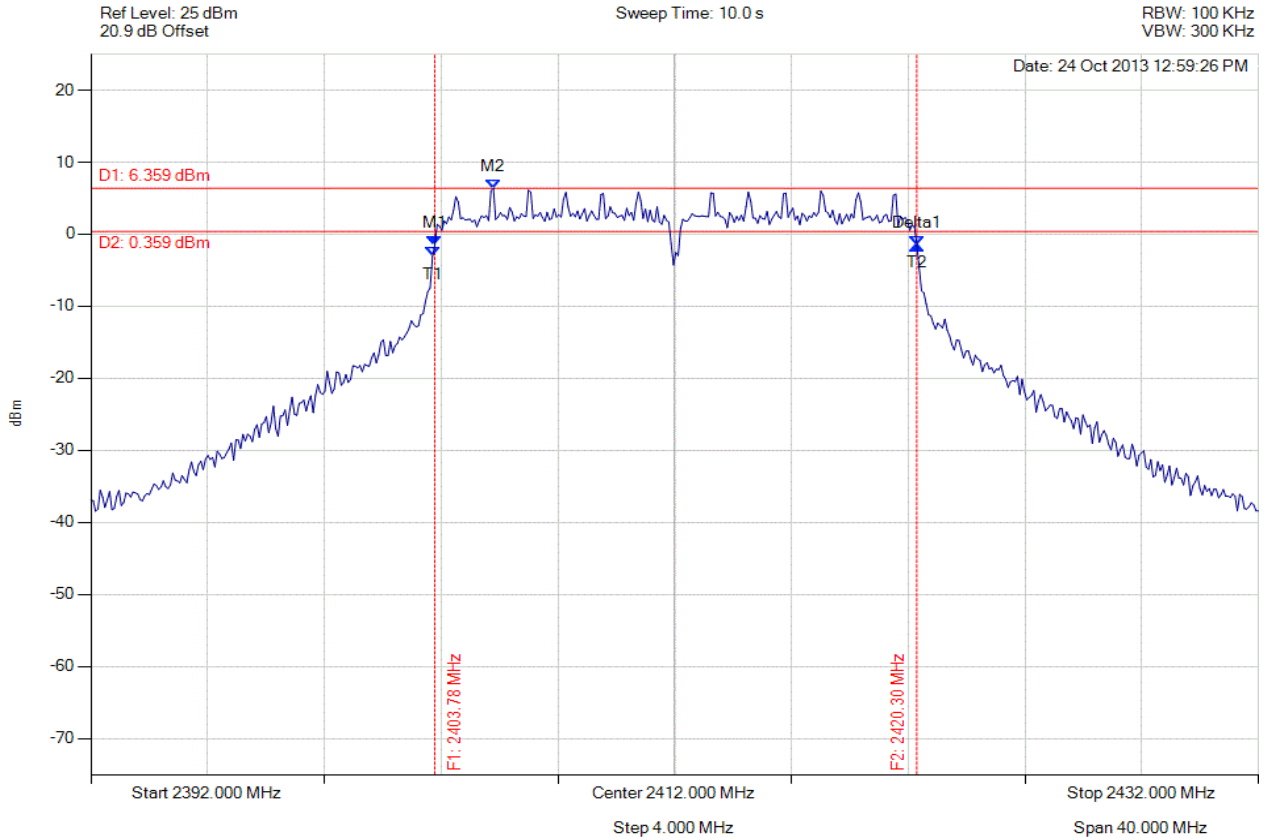

Analyser Setup	Marker : Frequency : Amplitude	Test Results
Detector = MAX PEAK Sweep Count = 0 RF Atten (dB) = 20 Trace Mode = VIEW	M1 : 2403.784 MHz : -1.483 dBm M2 : 2405.788 MHz : 6.359 dBm Delta1 : 16.513 MHz : -0.002 dB T1 : 2403.703 MHz : -3.068 dBm T2 : 2420.297 MHz : -1.485 dBm OBW : 16.593 MHz	Measured 6 dB Bandwidth: 16.513 MHz Limit: ≥500.0 kHz Margin: -16.01 MHz

[Back to the Matrix](#)

This test report may be reproduced in full only. The document may only be updated by MiCOM Labs personnel. Any changes will be noted in the Document History section of the report.



Title: Xirrus Inc. XI-AC1300, XI-AC867
To: FCC 47 CFR Part 15.247 & IC RSS-210
Serial #: XIRR04-U3 Rev A
Issue Date: 29th April 2014
Page: 148 of 572



6 dB & 99% BANDWIDTH

Variant: 802.11g, Channel: 2437.00 MHz, Chain a, Temp: Ambient, Voltage: 56 Vdc

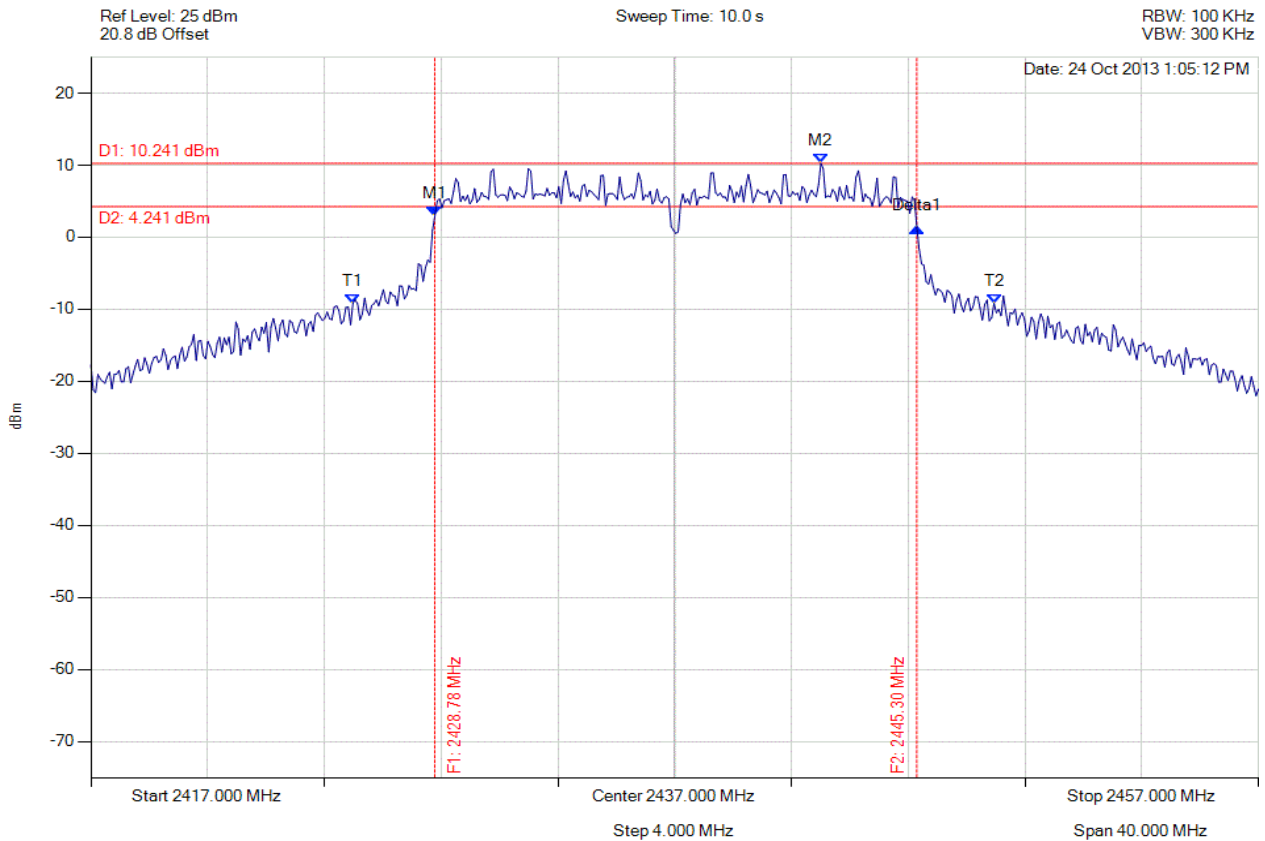

Analyser Setup	Marker : Frequency : Amplitude	Test Results
Detector = MAX PEAK Sweep Count = 0 RF Atten (dB) = 20 Trace Mode = VIEW	M1 : 2428.784 MHz : 2.907 dBm M2 : 2442.010 MHz : 10.241 dBm Delta1 : 16.513 MHz : -1.562 dB T1 : 2425.978 MHz : -9.149 dBm T2 : 2447.942 MHz : -9.177 dBm OBW : 21.964 MHz	Measured 6 dB Bandwidth: 16.513 MHz Limit: ≥ 500.0 kHz Margin: -16.01 MHz

[Back to the Matrix](#)

This test report may be reproduced in full only. The document may only be updated by MiCOM Labs personnel. Any changes will be noted in the Document History section of the report.



Title: Xirrus Inc. XI-AC1300, XI-AC867
To: FCC 47 CFR Part 15.247 & IC RSS-210
Serial #: XIRR04-U3 Rev A
Issue Date: 29th April 2014
Page: 149 of 572



6 dB & 99% BANDWIDTH

Variant: 802.11g, Channel: 2437.00 MHz, Chain b, Temp: Ambient, Voltage: 56 Vdc

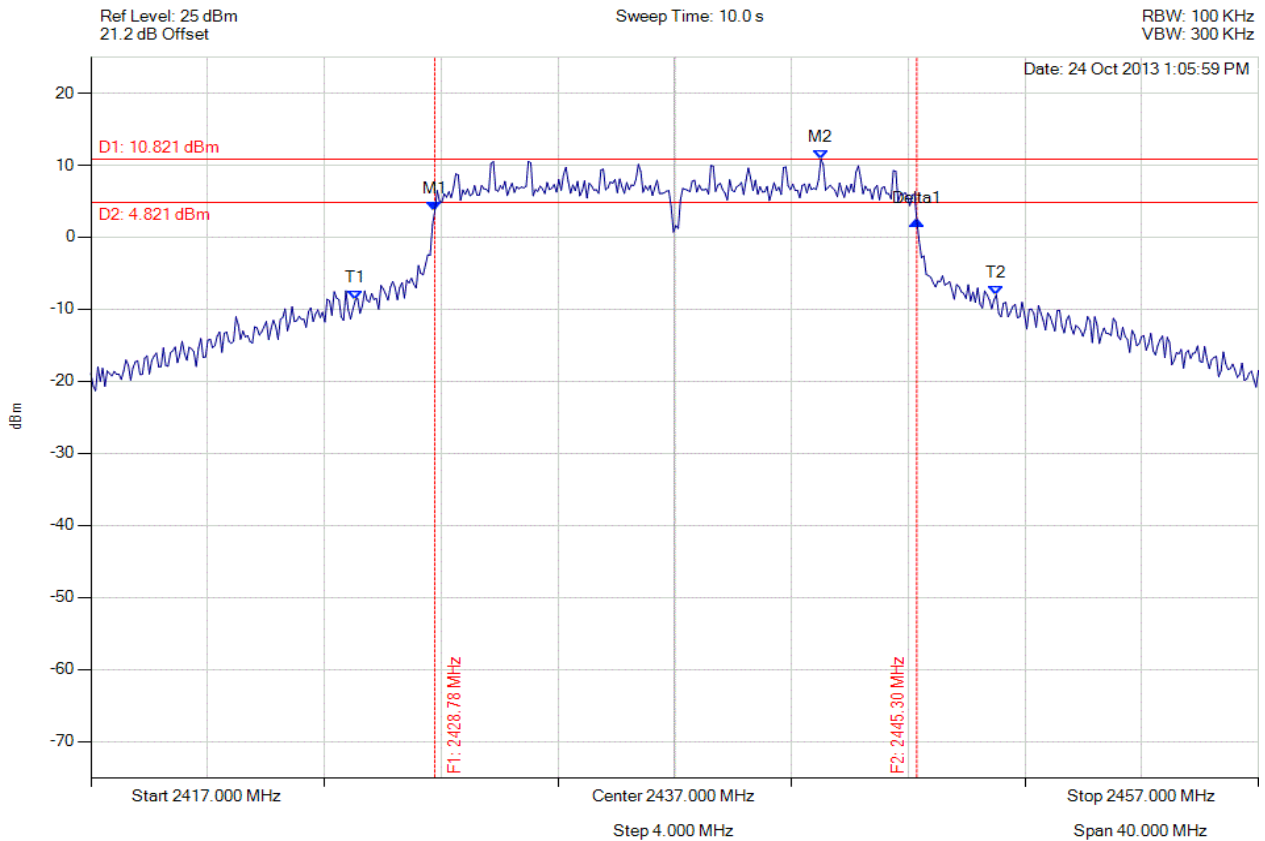

Analyser Setup	Marker : Frequency : Amplitude	Test Results
Detector = MAX PEAK Sweep Count = 0 RF Atten (dB) = 20 Trace Mode = VIEW	M1 : 2428.784 MHz : 3.629 dBm M2 : 2442.010 MHz : 10.821 dBm Delta1 : 16.513 MHz : -1.363 dB T1 : 2426.058 MHz : -8.736 dBm T2 : 2448.022 MHz : -8.026 dBm OBW : 21.964 MHz	Measured 6 dB Bandwidth: 16.513 MHz Limit: ≥ 500.0 kHz Margin: -16.01 MHz

[Back to the Matrix](#)

This test report may be reproduced in full only. The document may only be updated by MiCOM Labs personnel. Any changes will be noted in the Document History section of the report.



6 dB & 99% BANDWIDTH

Variant: 802.11g, Channel: 2437.00 MHz, Chain c, Temp: Ambient, Voltage: 56 Vdc

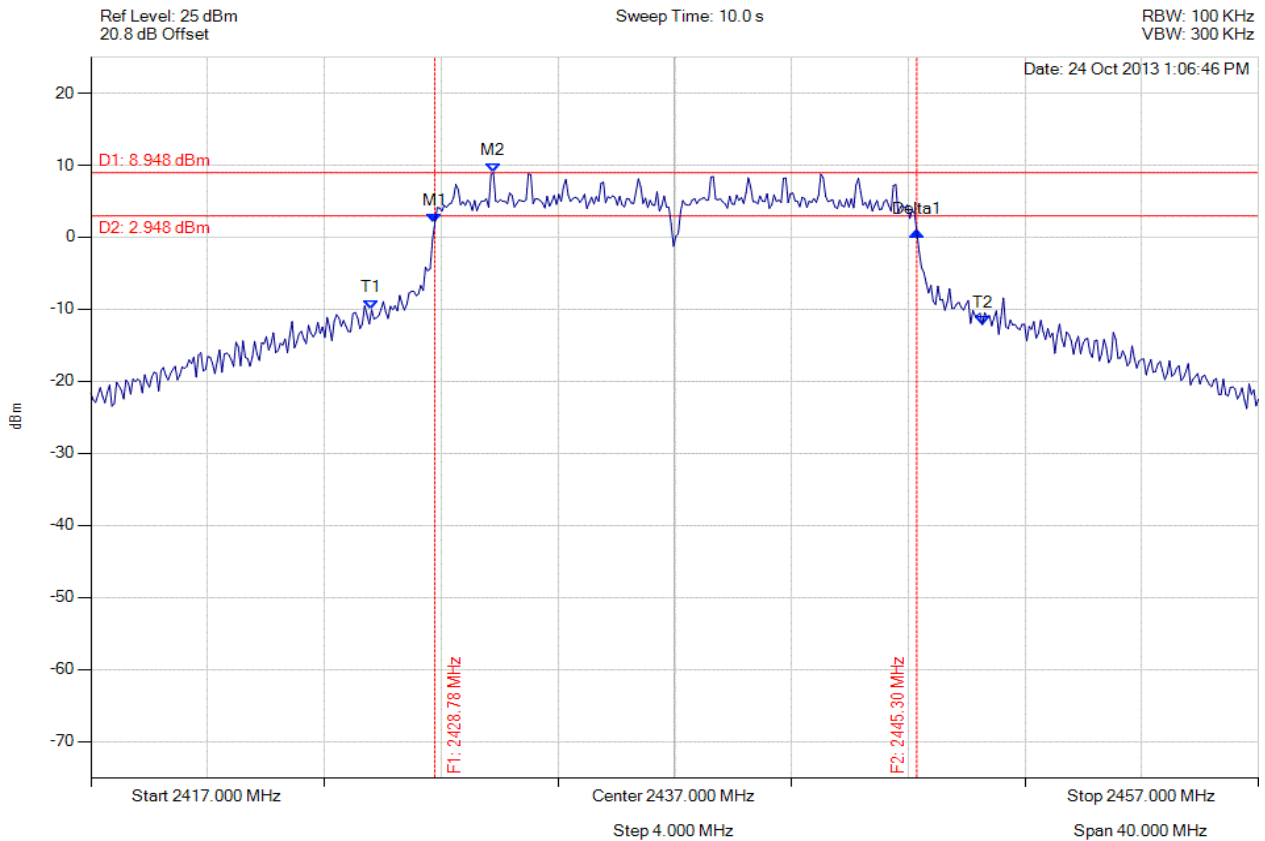

Analyser Setup	Marker : Frequency : Amplitude	Test Results
Detector = MAX PEAK Sweep Count = 0 RF Atten (dB) = 20 Trace Mode = VIEW	M1 : 2428.784 MHz : 1.921 dBm M2 : 2430.788 MHz : 8.948 dBm Delta1 : 16.513 MHz : -1.192 dB T1 : 2426.619 MHz : -10.082 dBm T2 : 2447.541 MHz : -12.138 dBm OBW : 20.922 MHz	Measured 6 dB Bandwidth: 16.513 MHz Limit: ≥ 500.0 kHz Margin: -16.01 MHz

[Back to the Matrix](#)

This test report may be reproduced in full only. The document may only be updated by MiCOM Labs personnel. Any changes will be noted in the Document History section of the report.



Title: Xirrus Inc. XI-AC1300, XI-AC867
To: FCC 47 CFR Part 15.247 & IC RSS-210
Serial #: XIRR04-U3 Rev A
Issue Date: 29th April 2014
Page: 151 of 572



6 dB & 99% BANDWIDTH

Variant: 802.11g, Channel: 2462.00 MHz, Chain a, Temp: Ambient, Voltage: 56 Vdc

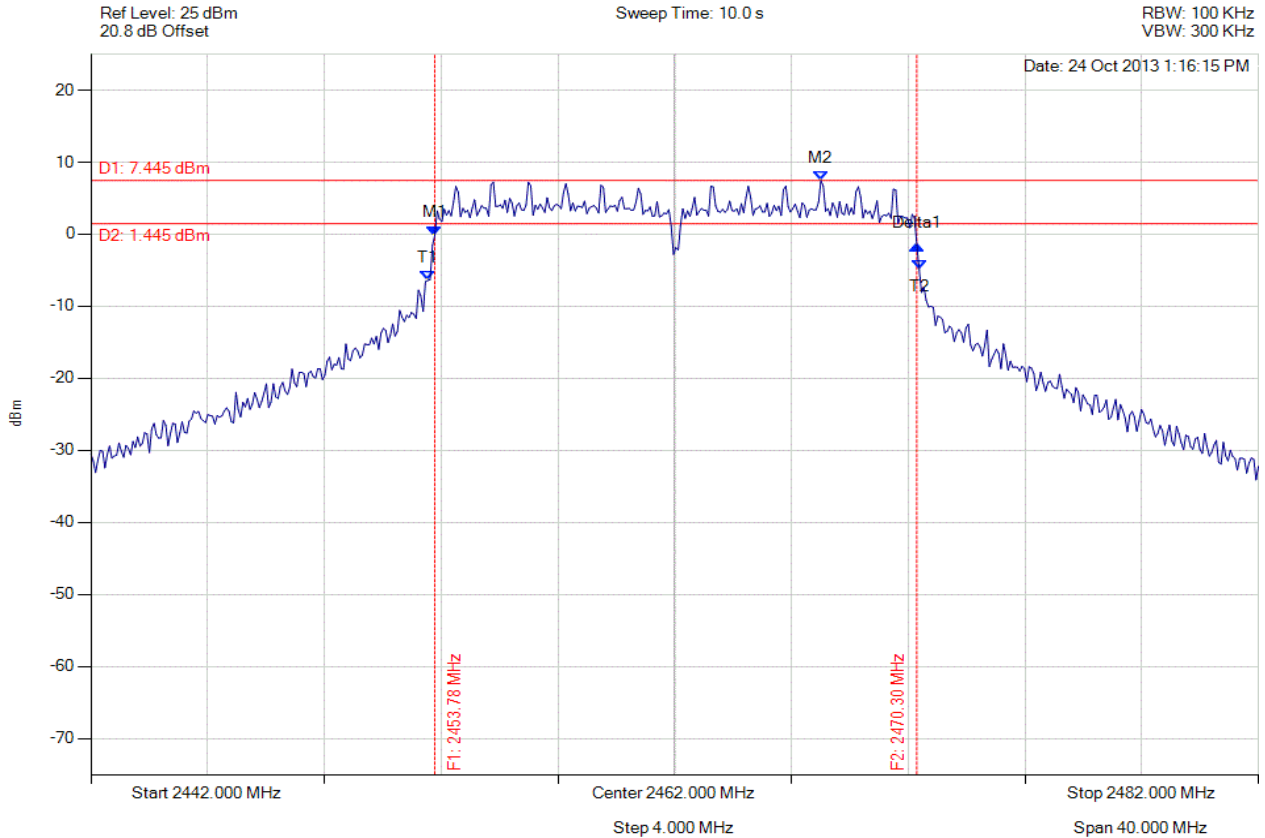

Analyser Setup	Marker : Frequency : Amplitude	Test Results
Detector = MAX PEAK Sweep Count = 0 RF Atten (dB) = 20 Trace Mode = VIEW	M1 : 2453.784 MHz : -0.121 dBm M2 : 2467.010 MHz : 7.445 dBm Delta1 : 16.513 MHz : -1.385 dB T1 : 2453.543 MHz : -6.401 dBm T2 : 2470.377 MHz : -4.807 dBm OBW : 16.834 MHz	Measured 6 dB Bandwidth: 16.513 MHz Limit: ≥ 500.0 kHz Margin: -16.01 MHz

[Back to the Matrix](#)

This test report may be reproduced in full only. The document may only be updated by MiCOM Labs personnel. Any changes will be noted in the Document History section of the report.



Title: Xirrus Inc. XI-AC1300, XI-AC867
To: FCC 47 CFR Part 15.247 & IC RSS-210
Serial #: XIRR04-U3 Rev A
Issue Date: 29th April 2014
Page: 152 of 572



6 dB & 99% BANDWIDTH

Variant: 802.11g, Channel: 2462.00 MHz, Chain b, Temp: Ambient, Voltage: 56 Vdc

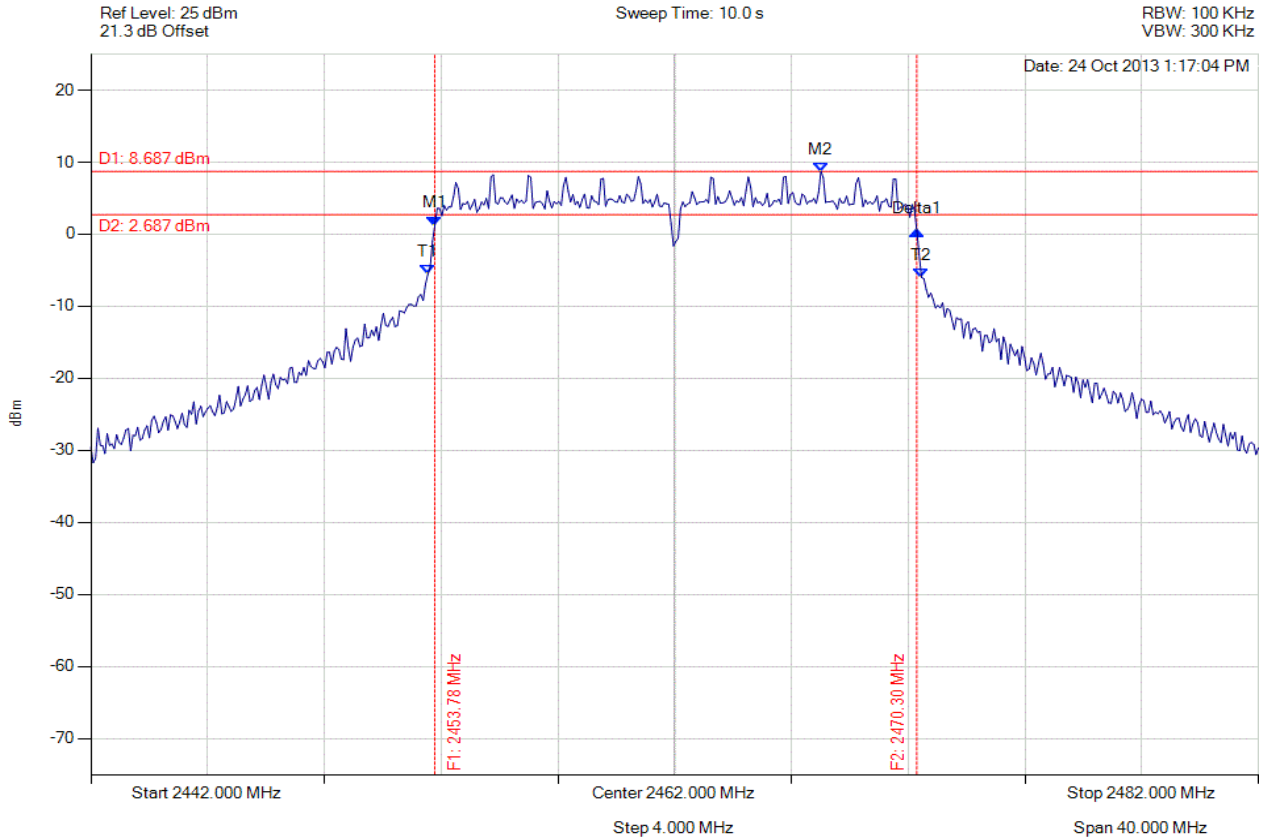

Analyser Setup	Marker : Frequency : Amplitude	Test Results
Detector = MAX PEAK Sweep Count = 0 RF Atten (dB) = 20 Trace Mode = VIEW	M1 : 2453.784 MHz : 1.213 dBm M2 : 2467.010 MHz : 8.687 dBm Delta1 : 16.513 MHz : -0.773 dB T1 : 2453.543 MHz : -5.573 dBm T2 : 2470.457 MHz : -5.992 dBm OBW : 16.914 MHz	Measured 6 dB Bandwidth: 16.513 MHz Limit: ≥ 500.0 kHz Margin: -16.01 MHz

[Back to the Matrix](#)

This test report may be reproduced in full only. The document may only be updated by MiCOM Labs personnel. Any changes will be noted in the Document History section of the report.



6 dB & 99% BANDWIDTH

Variant: 802.11g, Channel: 2462.00 MHz, Chain c, Temp: Ambient, Voltage: 56 Vdc

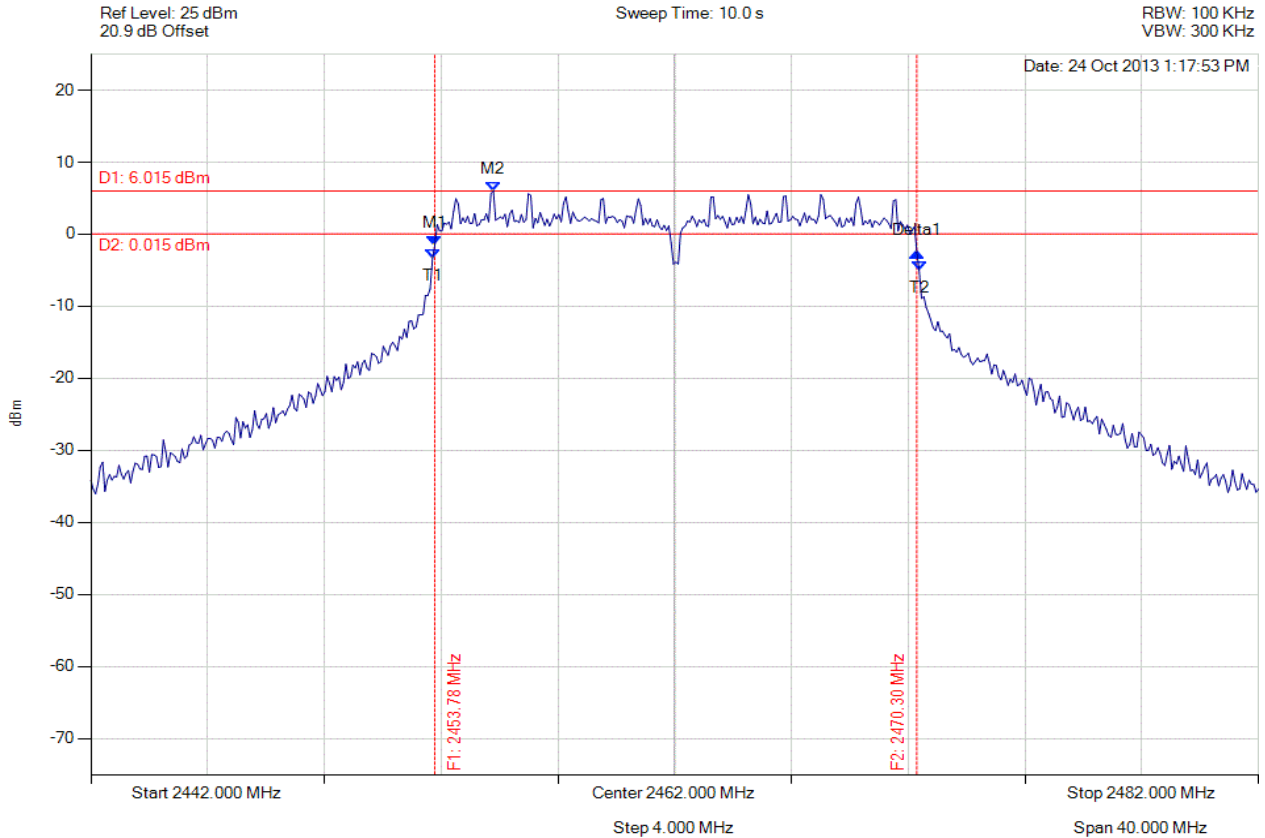

Analyser Setup	Marker : Frequency : Amplitude	Test Results
Detector = MAX PEAK Sweep Count = 0 RF Atten (dB) = 20 Trace Mode = VIEW	M1 : 2453.784 MHz : -1.528 dBm M2 : 2455.788 MHz : 6.015 dBm Delta1 : 16.513 MHz : -0.994 dB T1 : 2453.703 MHz : -3.326 dBm T2 : 2470.377 MHz : -5.002 dBm OBW : 16.673 MHz	Measured 6 dB Bandwidth: 16.513 MHz Limit: ≥ 500.0 kHz Margin: -16.01 MHz

[Back to the Matrix](#)

This test report may be reproduced in full only. The document may only be updated by MiCOM Labs personnel. Any changes will be noted in the Document History section of the report.



6 dB & 99% BANDWIDTH

Variant: 802.11n HT-20, Channel: 2412.00 MHz, Chain a, Temp: Ambient, Voltage: 56 Vdc

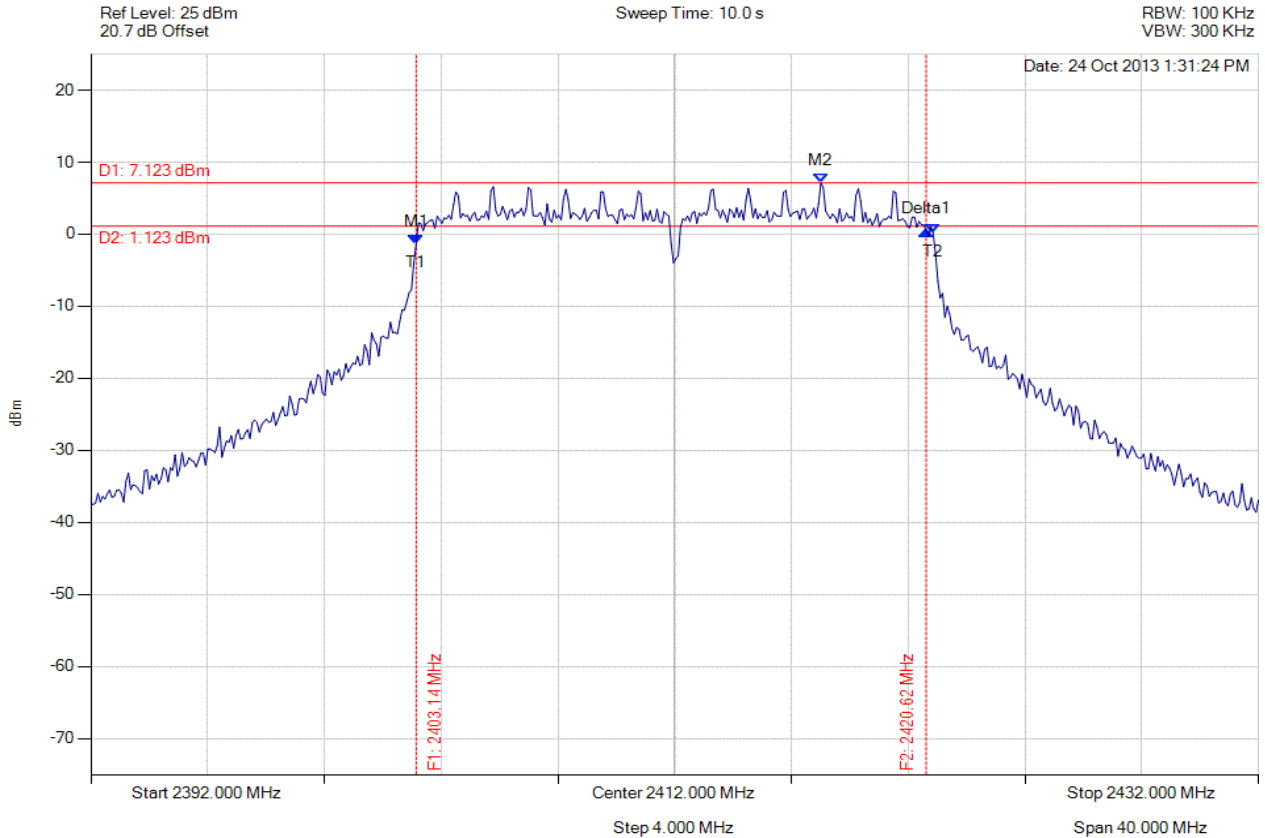

Analyser Setup	Marker : Frequency : Amplitude	Test Results
Detector = MAX PEAK Sweep Count = 0 RF Atten (dB) = 20 Trace Mode = VIEW	M1 : 2403.142 MHz : -1.382 dBm M2 : 2417.010 MHz : 7.123 dBm Delta1 : 17.475 MHz : 1.869 dB T1 : 2403.142 MHz : -1.382 dBm T2 : 2420.858 MHz : 0.068 dBm OBW : 17.715 MHz	Measured 6 dB Bandwidth: 17.475 MHz Limit: ≥ 500.0 kHz Margin: -16.98 MHz

[Back to the Matrix](#)

This test report may be reproduced in full only. The document may only be updated by MiCOM Labs personnel. Any changes will be noted in the Document History section of the report.



Title: Xirrus Inc. XI-AC1300, XI-AC867
To: FCC 47 CFR Part 15.247 & IC RSS-210
Serial #: XIRR04-U3 Rev A
Issue Date: 29th April 2014
Page: 155 of 572



6 dB & 99% BANDWIDTH

Variant: 802.11n HT-20, Channel: 2412.00 MHz, Chain b, Temp: Ambient, Voltage: 56 Vdc

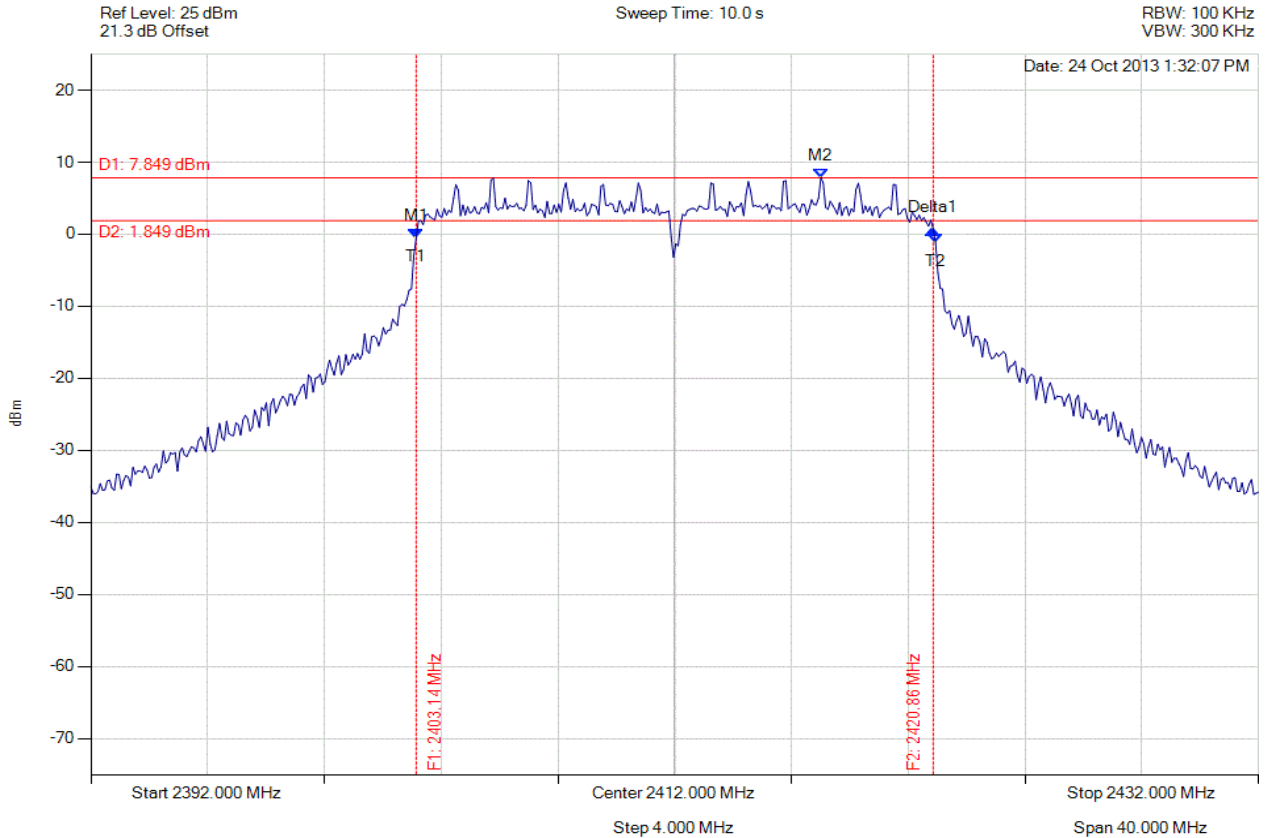

Analyser Setup	Marker : Frequency : Amplitude	Test Results
Detector = MAX PEAK Sweep Count = 0 RF Atten (dB) = 20 Trace Mode = VIEW	M1 : 2403.142 MHz : -0.585 dBm M2 : 2417.010 MHz : 7.849 dBm Delta1 : 17.715 MHz : 1.289 dB T1 : 2403.142 MHz : -0.585 dBm T2 : 2420.938 MHz : -1.197 dBm OBW : 17.796 MHz	Measured 6 dB Bandwidth: 17.715 MHz Limit: ≥ 500.0 kHz Margin: -17.22 MHz

[Back to the Matrix](#)

This test report may be reproduced in full only. The document may only be updated by MiCOM Labs personnel. Any changes will be noted in the Document History section of the report.



Title: Xirrus Inc. XI-AC1300, XI-AC867
To: FCC 47 CFR Part 15.247 & IC RSS-210
Serial #: XIRR04-U3 Rev A
Issue Date: 29th April 2014
Page: 156 of 572



6 dB & 99% BANDWIDTH

Variant: 802.11n HT-20, Channel: 2412.00 MHz, Chain c, Temp: Ambient, Voltage: 56 Vdc

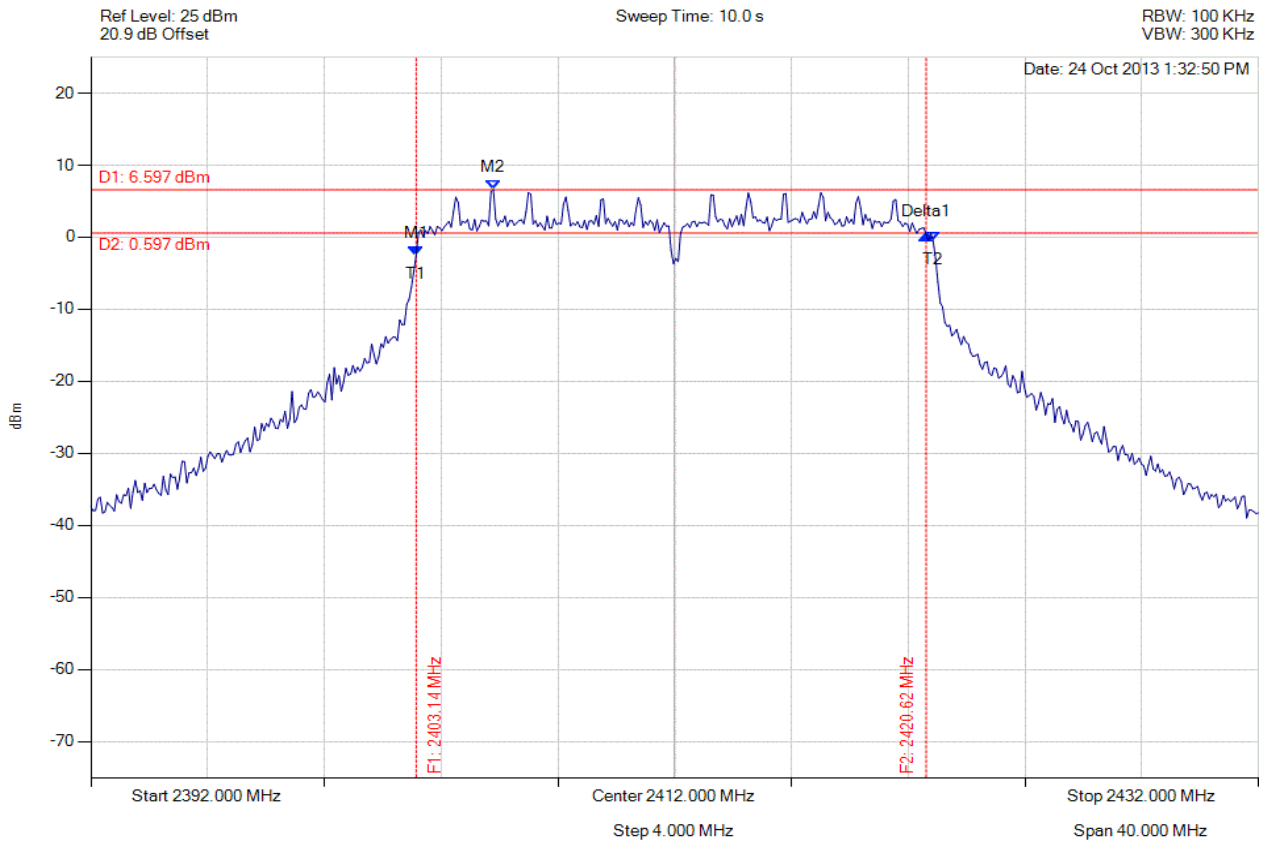

Analyser Setup	Marker : Frequency : Amplitude	Test Results
Detector = MAX PEAK Sweep Count = 0 RF Atten (dB) = 20 Trace Mode = VIEW	M1 : 2403.142 MHz : -2.525 dBm M2 : 2405.788 MHz : 6.597 dBm Delta1 : 17.475 MHz : 2.900 dB T1 : 2403.142 MHz : -2.525 dBm T2 : 2420.858 MHz : -0.591 dBm OBW : 17.715 MHz	Measured 6 dB Bandwidth : 17.475 MHz Limit : ≥ 500.0 kHz Margin : -16.98 MHz

[Back to the Matrix](#)

This test report may be reproduced in full only. The document may only be updated by MiCOM Labs personnel. Any changes will be noted in the Document History section of the report.



Title: Xirrus Inc. XI-AC1300, XI-AC867
To: FCC 47 CFR Part 15.247 & IC RSS-210
Serial #: XIRR04-U3 Rev A
Issue Date: 29th April 2014
Page: 157 of 572



6 dB & 99% BANDWIDTH

Variant: 802.11n HT-20, Channel: 2437.00 MHz, Chain a, Temp: Ambient, Voltage: 56 Vdc

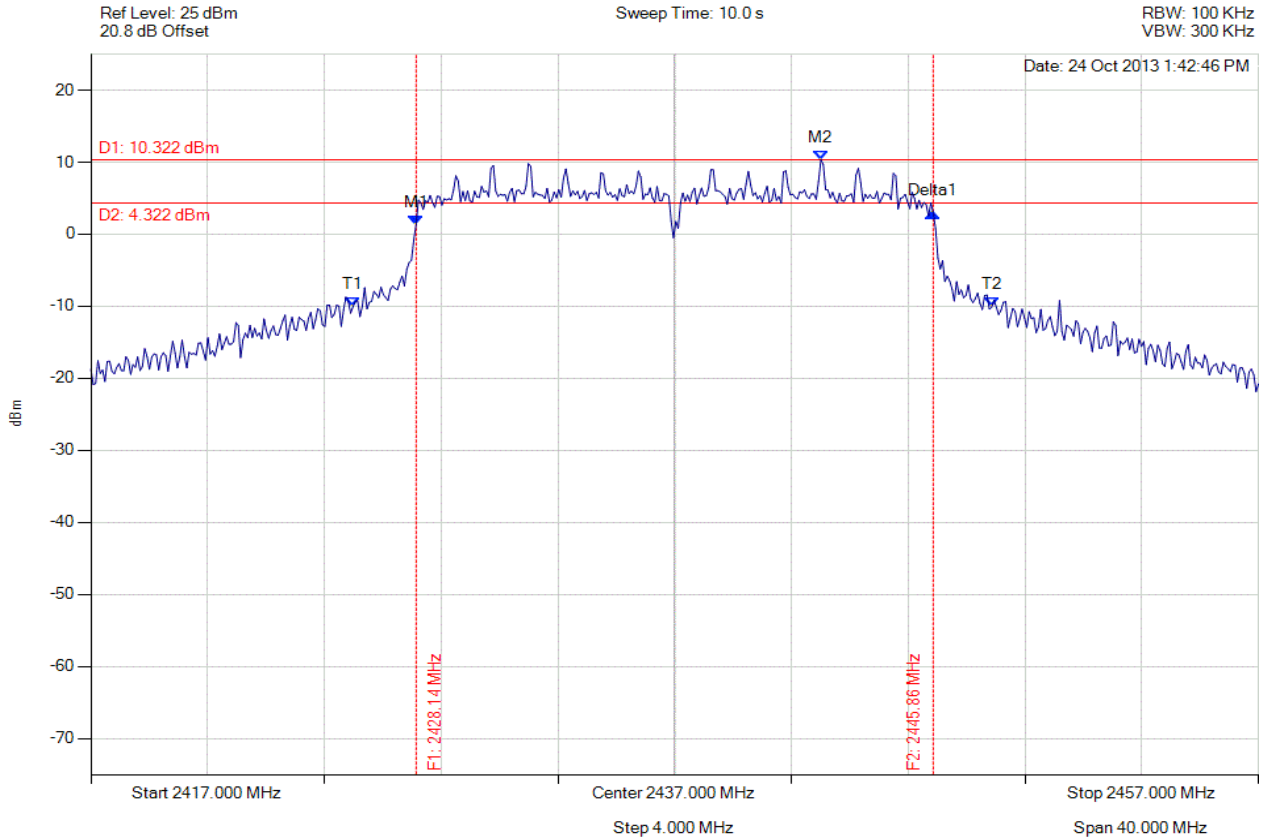

Analyser Setup	Marker : Frequency : Amplitude	Test Results
Detector = MAX PEAK Sweep Count = 0 RF Atten (dB) = 20 Trace Mode = VIEW	M1 : 2428.142 MHz : 1.370 dBm M2 : 2442.010 MHz : 10.322 dBm Delta1 : 17.715 MHz : 1.633 dB T1 : 2425.978 MHz : -10.076 dBm T2 : 2447.862 MHz : -10.113 dBm OBW : 21.884 MHz	Measured 6 dB Bandwidth: 17.715 MHz Limit: ≥ 500.0 kHz Margin: -17.22 MHz

[Back to the Matrix](#)

This test report may be reproduced in full only. The document may only be updated by MiCOM Labs personnel. Any changes will be noted in the Document History section of the report.



Title: Xirrus Inc. XI-AC1300, XI-AC867
To: FCC 47 CFR Part 15.247 & IC RSS-210
Serial #: XIRR04-U3 Rev A
Issue Date: 29th April 2014
Page: 158 of 572



6 dB & 99% BANDWIDTH

Variant: 802.11n HT-20, Channel: 2437.00 MHz, Chain b, Temp: Ambient, Voltage: 56 Vdc

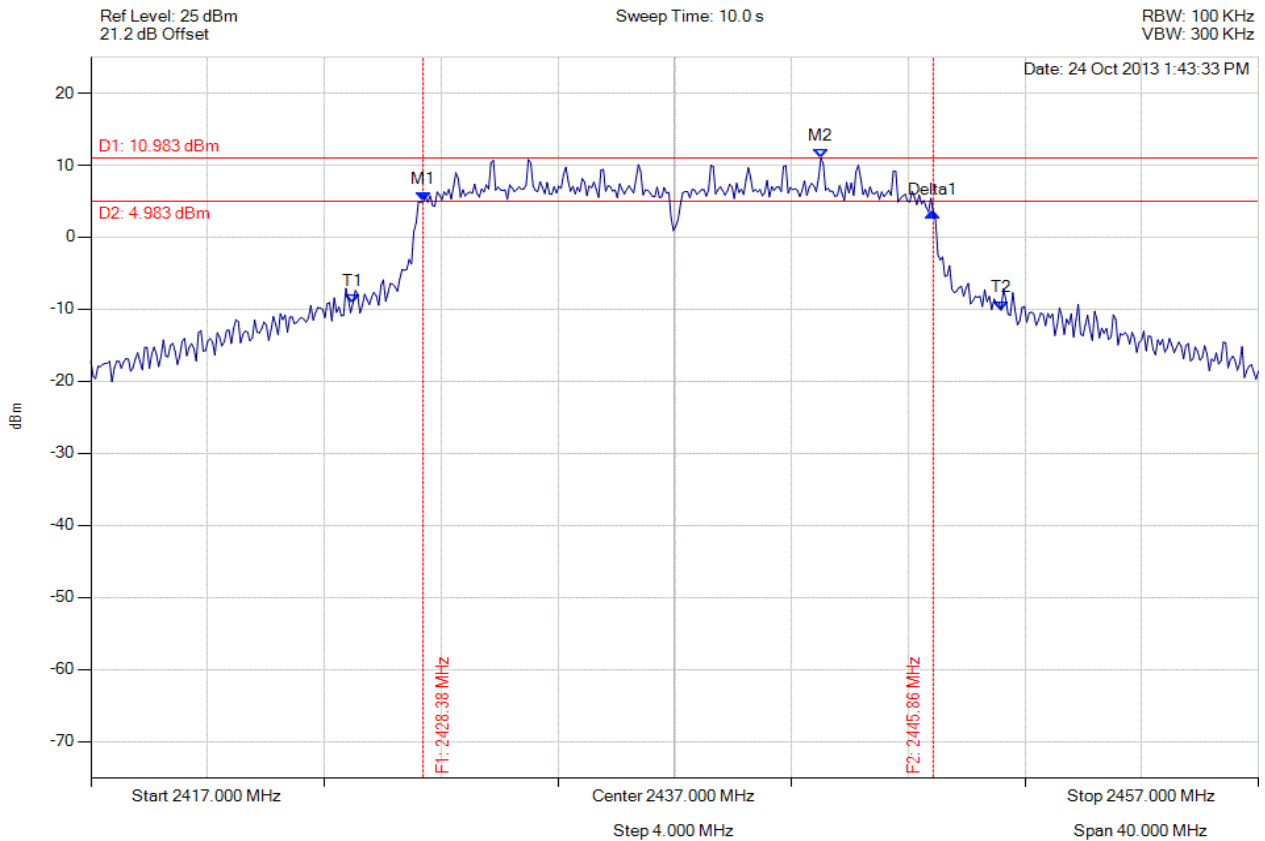

Analyser Setup	Marker : Frequency : Amplitude	Test Results
Detector = MAX PEAK Sweep Count = 0 RF Atten (dB) = 20 Trace Mode = VIEW	M1 : 2428.383 MHz : 4.923 dBm M2 : 2442.010 MHz : 10.983 dBm Delta1 : 17.475 MHz : -1.483 dB T1 : 2425.978 MHz : -9.161 dBm T2 : 2448.182 MHz : -10.123 dBm OBW : 22.204 MHz	Measured 6 dB Bandwidth: 17.475 MHz Limit: ≥ 500.0 kHz Margin: -16.98 MHz

[Back to the Matrix](#)

This test report may be reproduced in full only. The document may only be updated by MiCOM Labs personnel. Any changes will be noted in the Document History section of the report.



Title: Xirrus Inc. XI-AC1300, XI-AC867
To: FCC 47 CFR Part 15.247 & IC RSS-210
Serial #: XIRR04-U3 Rev A
Issue Date: 29th April 2014
Page: 159 of 572



6 dB & 99% BANDWIDTH

Variant: 802.11n HT-20, Channel: 2437.00 MHz, Chain c, Temp: Ambient, Voltage: 56 Vdc

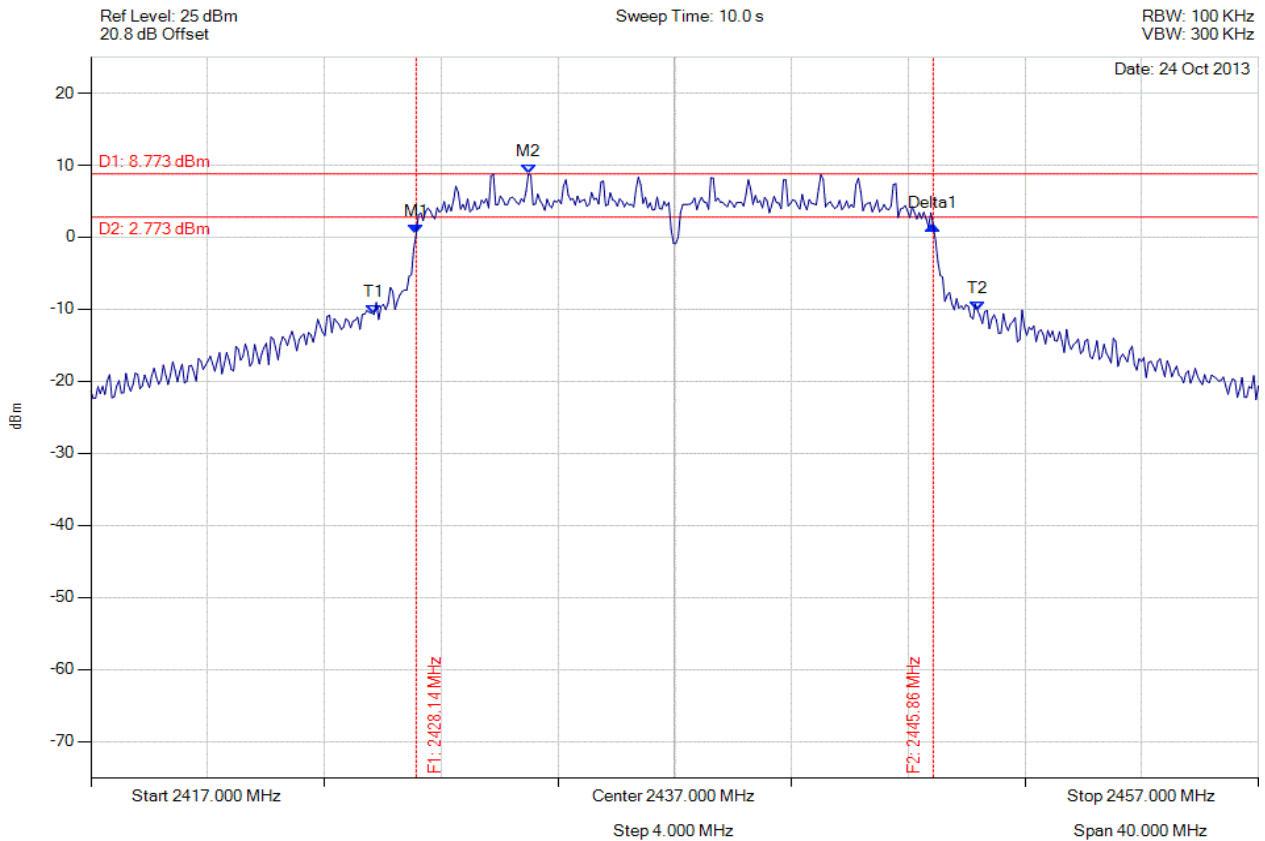

Analyser Setup	Marker : Frequency : Amplitude	Test Results
Detector = MAX PEAK Sweep Count = 0 RF Atten (dB) = 20 Trace Mode = VIEW	M1 : 2428.142 MHz : 0.402 dBm M2 : 2431.990 MHz : 8.773 dBm Delta1 : 17.715 MHz : 1.214 dB T1 : 2426.699 MHz : -10.729 dBm T2 : 2447.381 MHz : -10.200 dBm OBW : 20.681 MHz	Measured 6 dB Bandwidth: 17.715 MHz Limit: ≥ 500.0 kHz Margin: -17.22 MHz

[Back to the Matrix](#)

This test report may be reproduced in full only. The document may only be updated by MiCOM Labs personnel. Any changes will be noted in the Document History section of the report.



Title: Xirrus Inc. XI-AC1300, XI-AC867
To: FCC 47 CFR Part 15.247 & IC RSS-210
Serial #: XIRR04-U3 Rev A
Issue Date: 29th April 2014
Page: 160 of 572



6 dB & 99% BANDWIDTH

Variant: 802.11n HT-20, Channel: 2462.00 MHz, Chain a, Temp: Ambient, Voltage: 56 Vdc

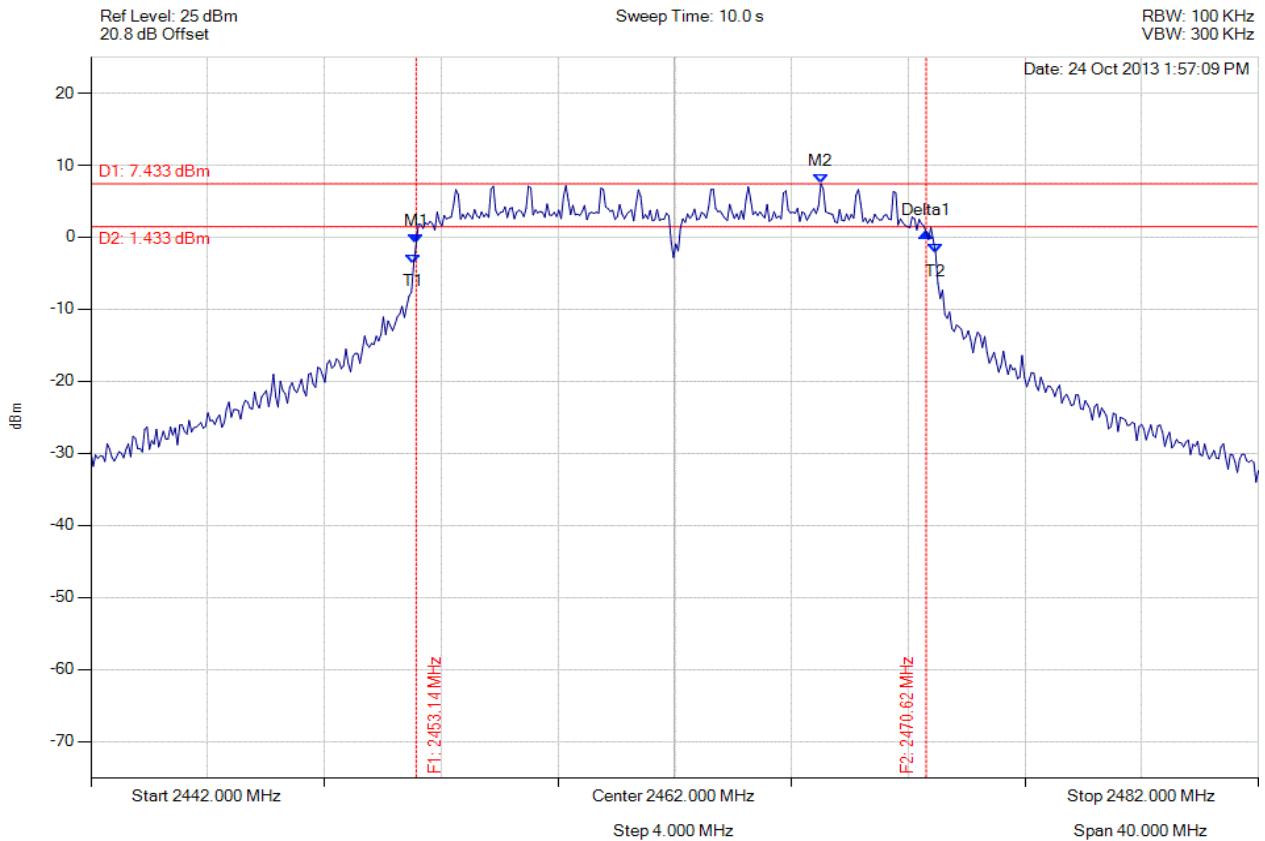

Analyser Setup	Marker : Frequency : Amplitude	Test Results
Detector = MAX PEAK Sweep Count = 0 RF Atten (dB) = 20 Trace Mode = VIEW	M1 : 2453.142 MHz : -0.920 dBm M2 : 2467.010 MHz : 7.432 dBm Delta1 : 17.475 MHz : 1.544 dB T1 : 2453.062 MHz : -3.651 dBm T2 : 2470.938 MHz : -2.214 dBm OBW : 17.876 MHz	Measured 6 dB Bandwidth : 17.475 MHz Limit : ≥ 500.0 kHz Margin : -16.98 MHz

[Back to the Matrix](#)

This test report may be reproduced in full only. The document may only be updated by MiCOM Labs personnel. Any changes will be noted in the Document History section of the report.



Title: Xirrus Inc. XI-AC1300, XI-AC867
To: FCC 47 CFR Part 15.247 & IC RSS-210
Serial #: XIRR04-U3 Rev A
Issue Date: 29th April 2014
Page: 161 of 572



6 dB & 99% BANDWIDTH

Variant: 802.11n HT-20, Channel: 2462.00 MHz, Chain b, Temp: Ambient, Voltage: 56 Vdc

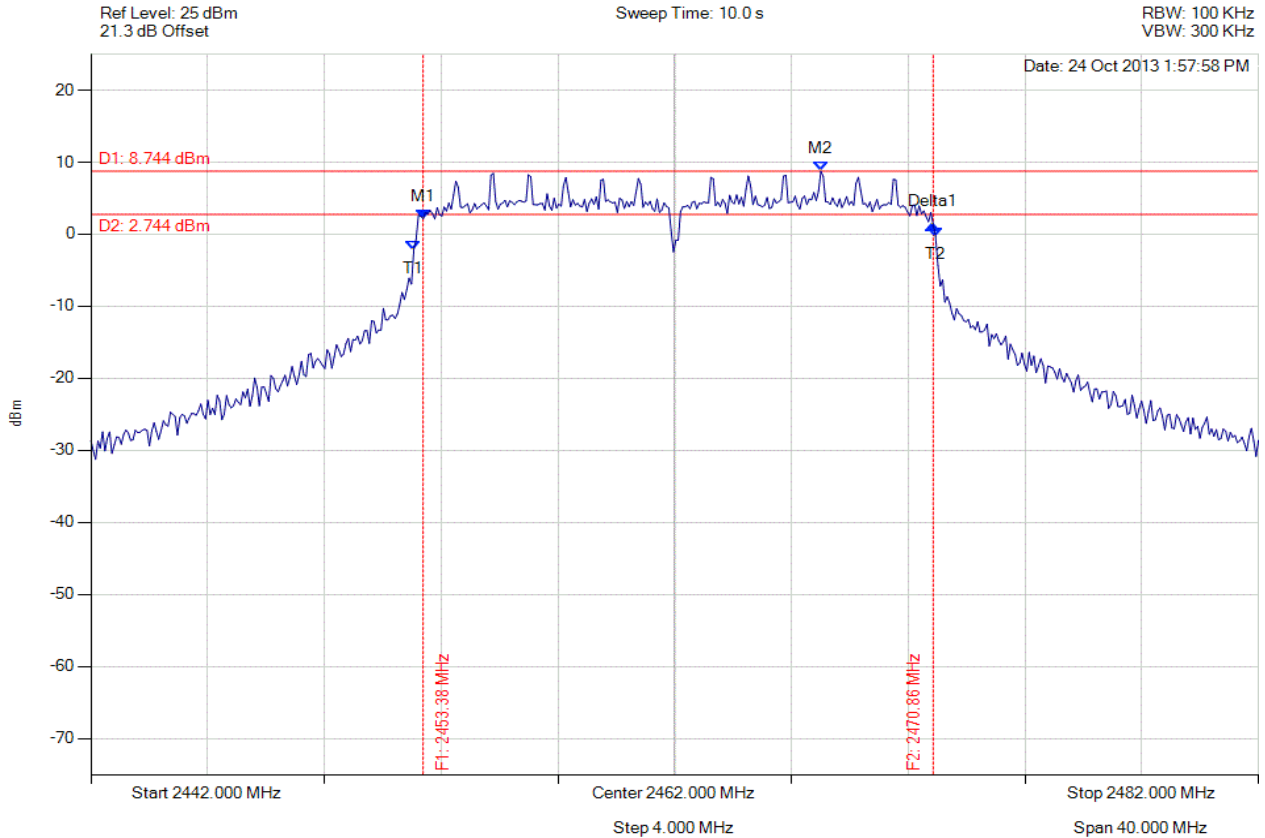

Analyser Setup	Marker : Frequency : Amplitude	Test Results
Detector = MAX PEAK Sweep Count = 0 RF Atten (dB) = 20 Trace Mode = VIEW	M1 : 2453.383 MHz : 2.147 dBm M2 : 2467.010 MHz : 8.744 dBm Delta1 : 17.475 MHz : -0.765 dB T1 : 2453.062 MHz : -2.228 dBm T2 : 2470.938 MHz : -0.330 dBm OBW : 17.876 MHz	Measured 6 dB Bandwidth: 17.475 MHz Limit: ≥ 500.0 kHz Margin: -16.98 MHz

[Back to the Matrix](#)

This test report may be reproduced in full only. The document may only be updated by MiCOM Labs personnel. Any changes will be noted in the Document History section of the report.



Title: Xirrus Inc. XI-AC1300, XI-AC867
To: FCC 47 CFR Part 15.247 & IC RSS-210
Serial #: XIRR04-U3 Rev A
Issue Date: 29th April 2014
Page: 162 of 572



6 dB & 99% BANDWIDTH

Variant: 802.11n HT-20, Channel: 2462.00 MHz, Chain c, Temp: Ambient, Voltage: 56 Vdc

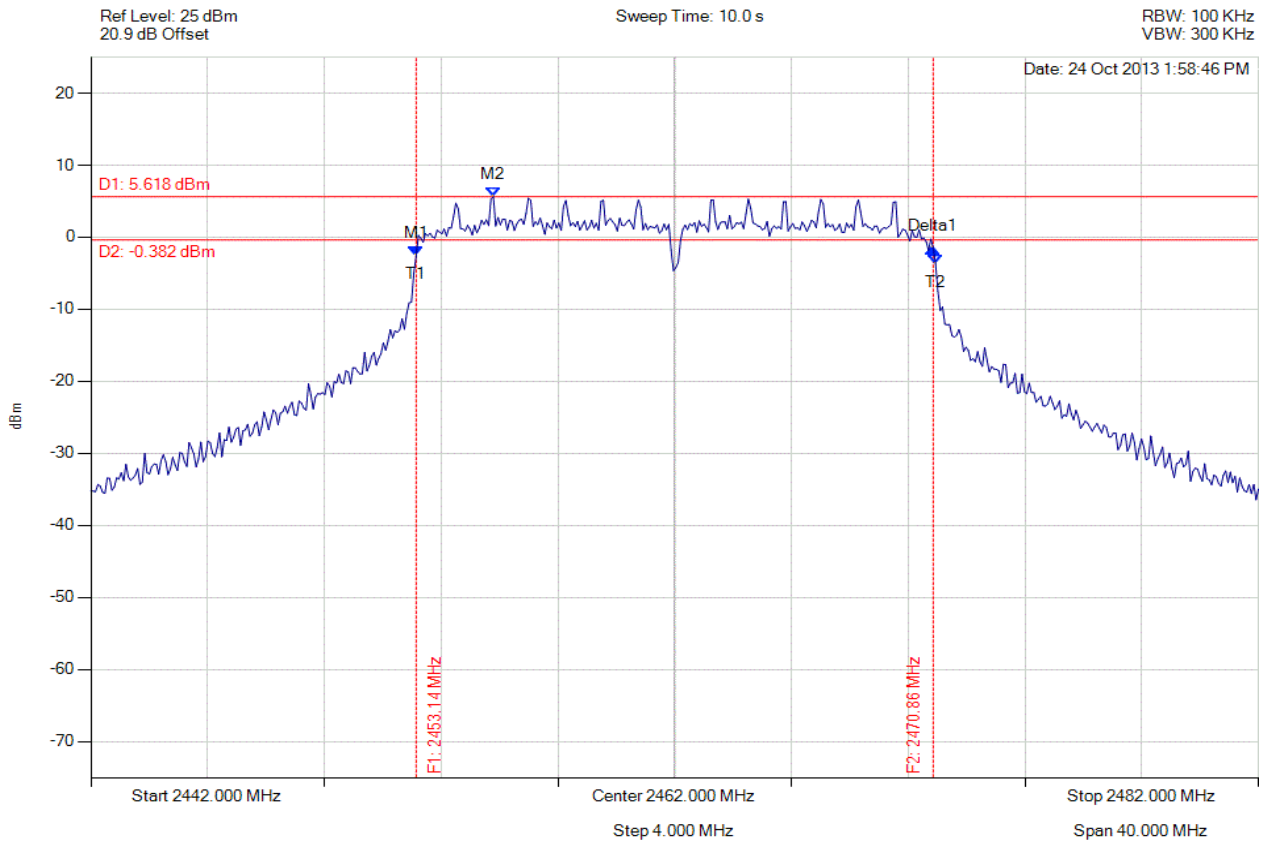

Analyser Setup	Marker : Frequency : Amplitude	Test Results
Detector = MAX PEAK Sweep Count = 0 RF Atten (dB) = 20 Trace Mode = VIEW	M1 : 2453.142 MHz : -2.600 dBm M2 : 2455.788 MHz : 5.618 dBm Delta1 : 17.715 MHz : 1.117 dB T1 : 2453.142 MHz : -2.600 dBm T2 : 2470.938 MHz : -3.737 dBm OBW : 17.796 MHz	Measured 6 dB Bandwidth: 17.715 MHz Limit: ≥ 500.0 kHz Margin: -17.22 MHz

[Back to the Matrix](#)

This test report may be reproduced in full only. The document may only be updated by MiCOM Labs personnel. Any changes will be noted in the Document History section of the report.



6 dB & 99% BANDWIDTH

Variant: 802.11n HT-40, Channel: 2422.00 MHz, Chain a, Temp: Ambient, Voltage: 56 Vdc

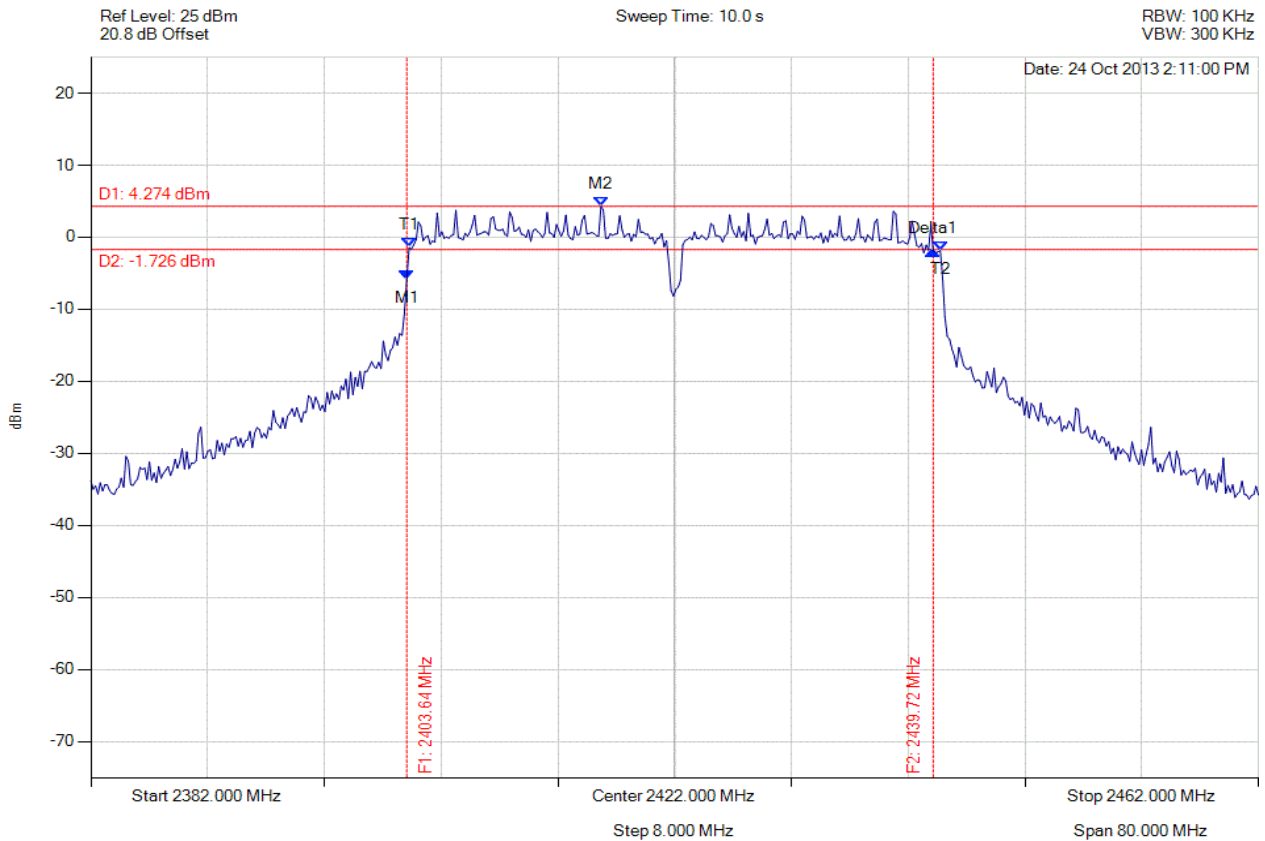

Analyser Setup	Marker : Frequency : Amplitude	Test Results
Detector = MAX PEAK Sweep Count = 0 RF Atten (dB) = 20 Trace Mode = VIEW	M1 : 2403.643 MHz : -5.870 dBm M2 : 2416.950 MHz : 4.274 dBm Delta1 : 36.072 MHz : 3.964 dB T1 : 2403.804 MHz : -1.441 dBm T2 : 2440.196 MHz : -1.880 dBm OBW : 36.393 MHz	Measured 6 dB Bandwidth: 36.072 MHz Limit: ≥ 500.0 kHz Margin: -35.57 MHz

[Back to the Matrix](#)

This test report may be reproduced in full only. The document may only be updated by MiCOM Labs personnel. Any changes will be noted in the Document History section of the report.



6 dB & 99% BANDWIDTH

Variant: 802.11n HT-40, Channel: 2422.00 MHz, Chain b, Temp: Ambient, Voltage: 56 Vdc

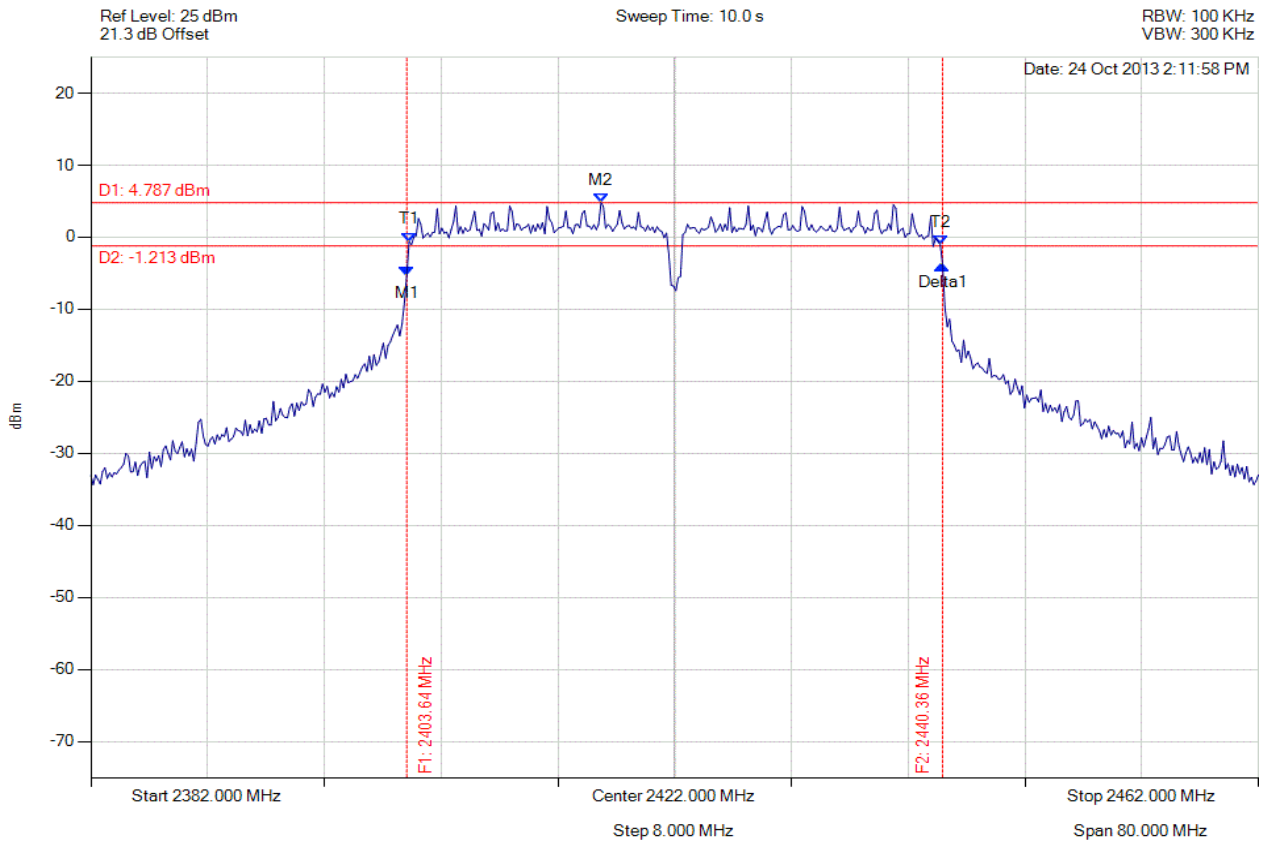

Analyser Setup	Marker : Frequency : Amplitude	Test Results
Detector = MAX PEAK Sweep Count = 0 RF Atten (dB) = 20 Trace Mode = VIEW	M1 : 2403.643 MHz : -5.289 dBm M2 : 2416.950 MHz : 4.787 dBm Delta1 : 36.713 MHz : 1.491 dB T1 : 2403.804 MHz : -0.615 dBm T2 : 2440.196 MHz : -1.024 dBm OBW : 36.393 MHz	Measured 6 dB Bandwidth: 36.713 MHz Limit: ≥ 500.0 kHz Margin: -36.21 MHz

[Back to the Matrix](#)

This test report may be reproduced in full only. The document may only be updated by MiCOM Labs personnel. Any changes will be noted in the Document History section of the report.



6 dB & 99% BANDWIDTH

Variant: 802.11n HT-40, Channel: 2422.00 MHz, Chain c, Temp: Ambient, Voltage: 56 Vdc

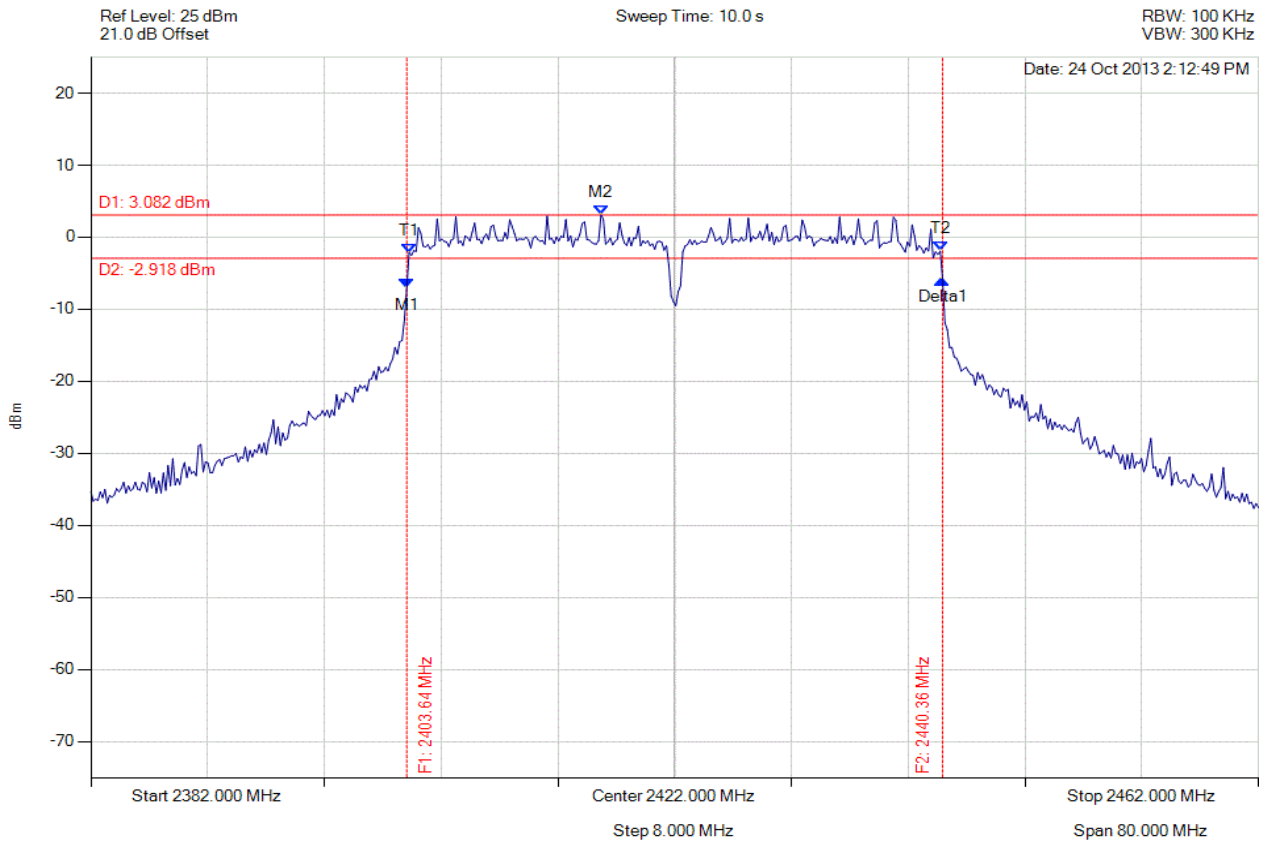

Analyser Setup	Marker : Frequency : Amplitude	Test Results
Detector = MAX PEAK Sweep Count = 0 RF Atten (dB) = 20 Trace Mode = VIEW	M1 : 2403.643 MHz : -6.968 dBm M2 : 2416.950 MHz : 3.082 dBm Delta1 : 36.713 MHz : 1.135 dB T1 : 2403.804 MHz : -2.140 dBm T2 : 2440.196 MHz : -1.933 dBm OBW : 36.393 MHz	Measured 6 dB Bandwidth: 36.713 MHz Limit: ≥ 500.0 kHz Margin: -36.21 MHz

[Back to the Matrix](#)

This test report may be reproduced in full only. The document may only be updated by MiCOM Labs personnel. Any changes will be noted in the Document History section of the report.



6 dB & 99% BANDWIDTH

Variant: 802.11n HT-40, Channel: 2437.00 MHz, Chain a, Temp: Ambient, Voltage: 56 Vdc

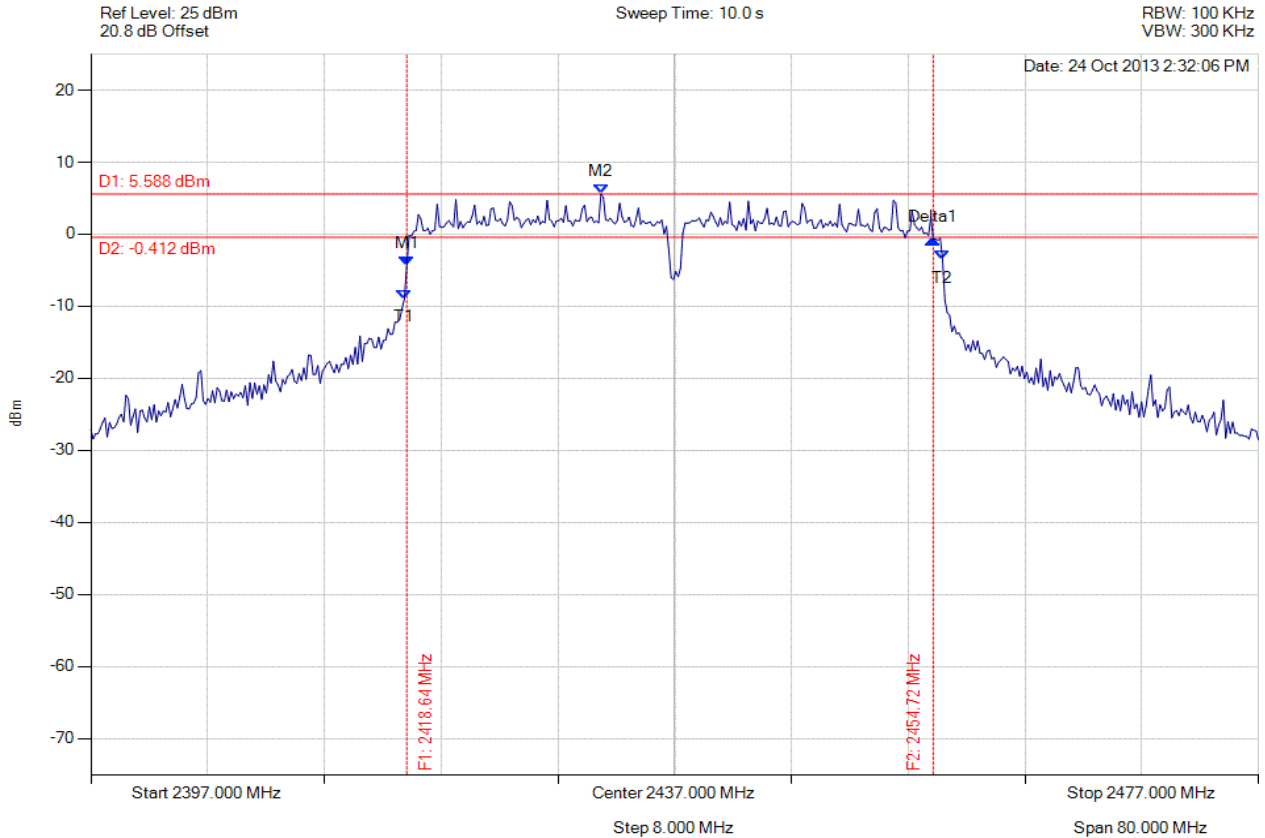

Analyser Setup	Marker : Frequency : Amplitude	Test Results
Detector = MAX PEAK Sweep Count = 0 RF Atten (dB) = 20 Trace Mode = VIEW	M1 : 2418.643 MHz : -4.327 dBm M2 : 2431.950 MHz : 5.588 dBm Delta1 : 36.072 MHz : 3.588 dB T1 : 2418.483 MHz : -8.962 dBm T2 : 2455.357 MHz : -3.566 dBm OBW : 36.874 MHz	Measured 6 dB Bandwidth: 36.072 MHz Limit: ≥ 500.0 kHz Margin: -35.57 MHz

[Back to the Matrix](#)

This test report may be reproduced in full only. The document may only be updated by MiCOM Labs personnel. Any changes will be noted in the Document History section of the report.



6 dB & 99% BANDWIDTH

Variant: 802.11n HT-40, Channel: 2437.00 MHz, Chain b, Temp: Ambient, Voltage: 56 Vdc

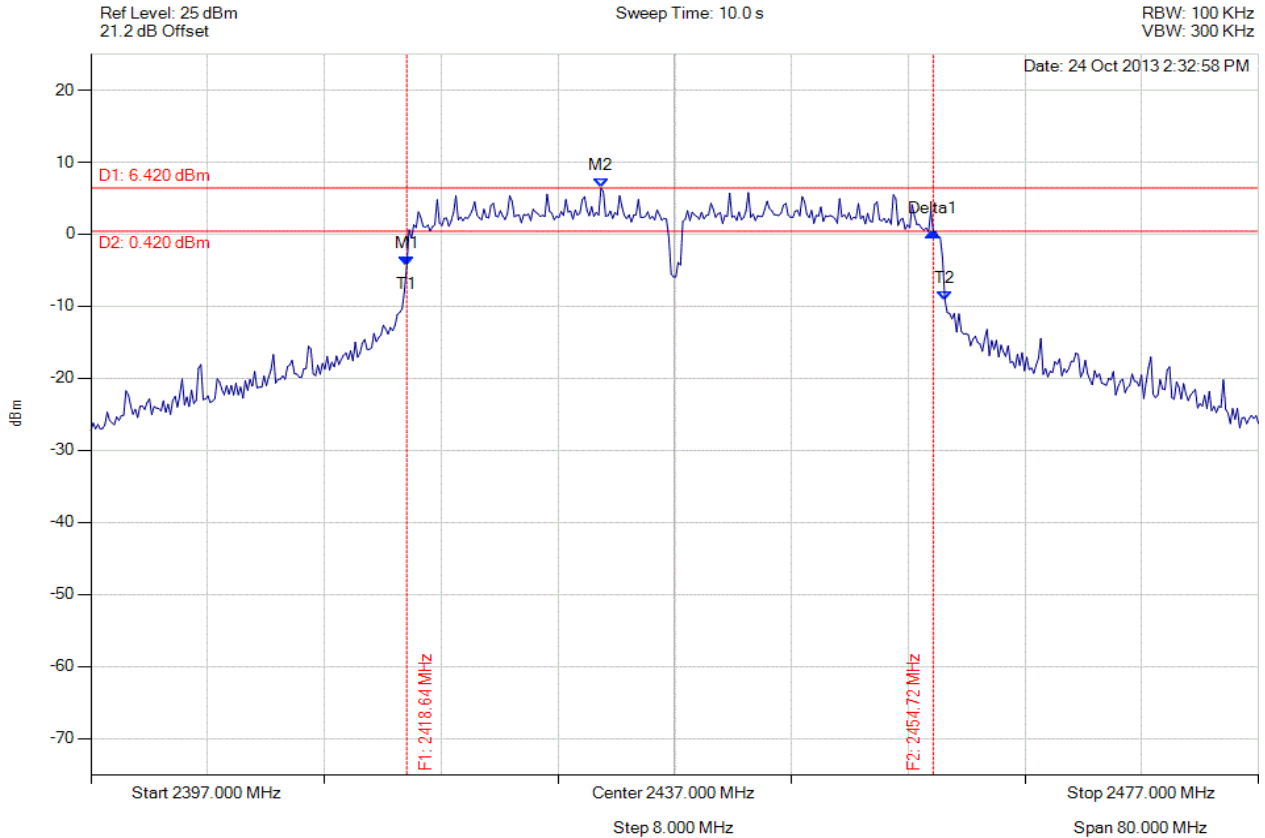

Analyser Setup	Marker : Frequency : Amplitude	Test Results
Detector = MAX PEAK Sweep Count = 0 RF Atten (dB) = 20 Trace Mode = VIEW	M1 : 2418.643 MHz : -4.365 dBm M2 : 2431.950 MHz : 6.420 dBm Delta1 : 36.072 MHz : 4.751 dB T1 : 2418.643 MHz : -4.365 dBm T2 : 2455.517 MHz : -9.132 dBm OBW : 36.874 MHz	Measured 6 dB Bandwidth: 36.072 MHz Limit: ≥ 500.0 kHz Margin: -35.57 MHz

[Back to the Matrix](#)

This test report may be reproduced in full only. The document may only be updated by MiCOM Labs personnel. Any changes will be noted in the Document History section of the report.



6 dB & 99% BANDWIDTH

Variant: 802.11n HT-40, Channel: 2437.00 MHz, Chain c, Temp: Ambient, Voltage: 56 Vdc

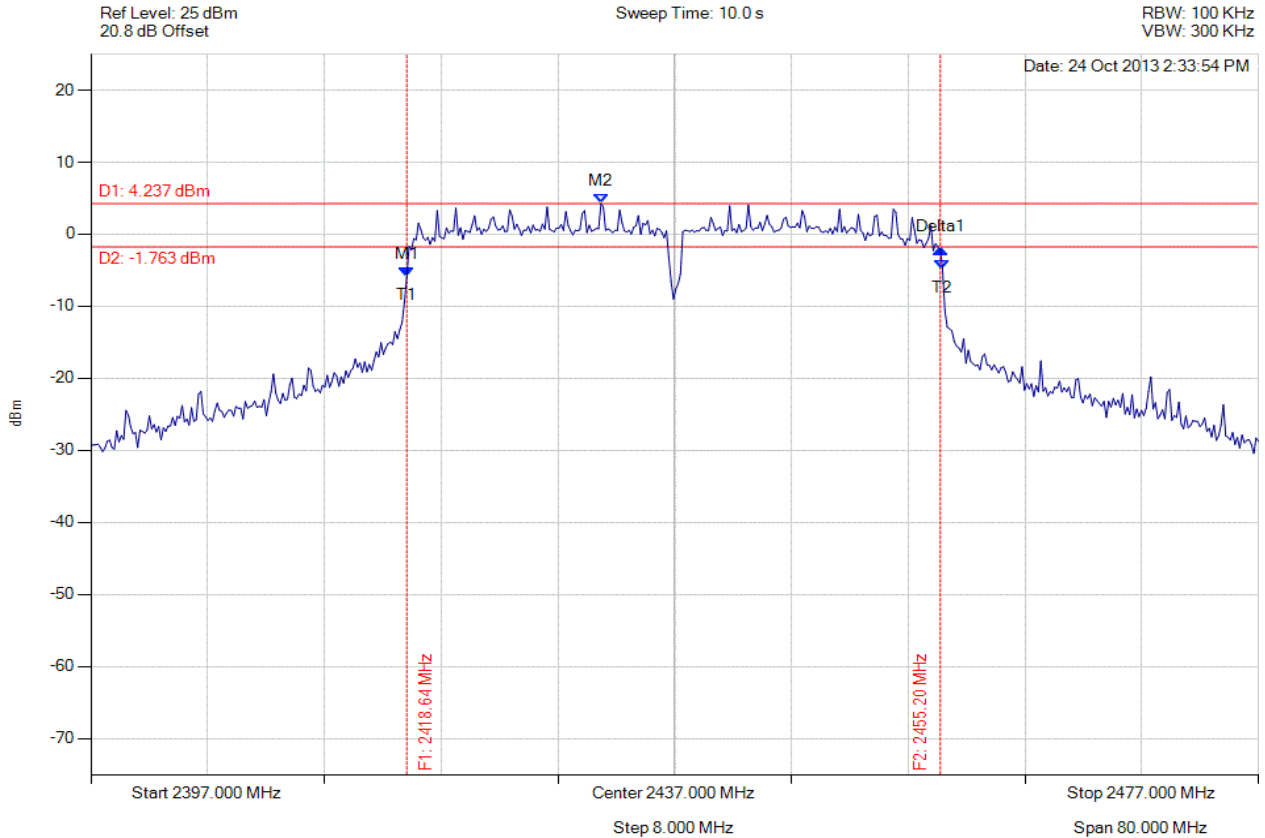

Analyser Setup	Marker : Frequency : Amplitude	Test Results
Detector = MAX PEAK Sweep Count = 0 RF Atten (dB) = 20 Trace Mode = VIEW	M1 : 2418.643 MHz : -5.882 dBm M2 : 2431.950 MHz : 4.237 dBm Delta1 : 36.553 MHz : 3.807 dB T1 : 2418.643 MHz : -5.882 dBm T2 : 2455.357 MHz : -4.923 dBm OBW : 36.713 MHz	Measured 6 dB Bandwidth: 36.553 MHz Limit: ≥ 500.0 kHz Margin: -36.05 MHz

[Back to the Matrix](#)

This test report may be reproduced in full only. The document may only be updated by MiCOM Labs personnel. Any changes will be noted in the Document History section of the report.



Title: Xirrus Inc. XI-AC1300, XI-AC867
To: FCC 47 CFR Part 15.247 & IC RSS-210
Serial #: XIRR04-U3 Rev A
Issue Date: 29th April 2014
Page: 169 of 572



6 dB & 99% BANDWIDTH

Variant: 802.11n HT-40, Channel: 2452.00 MHz, Chain a, Temp: Ambient, Voltage: 56 Vdc

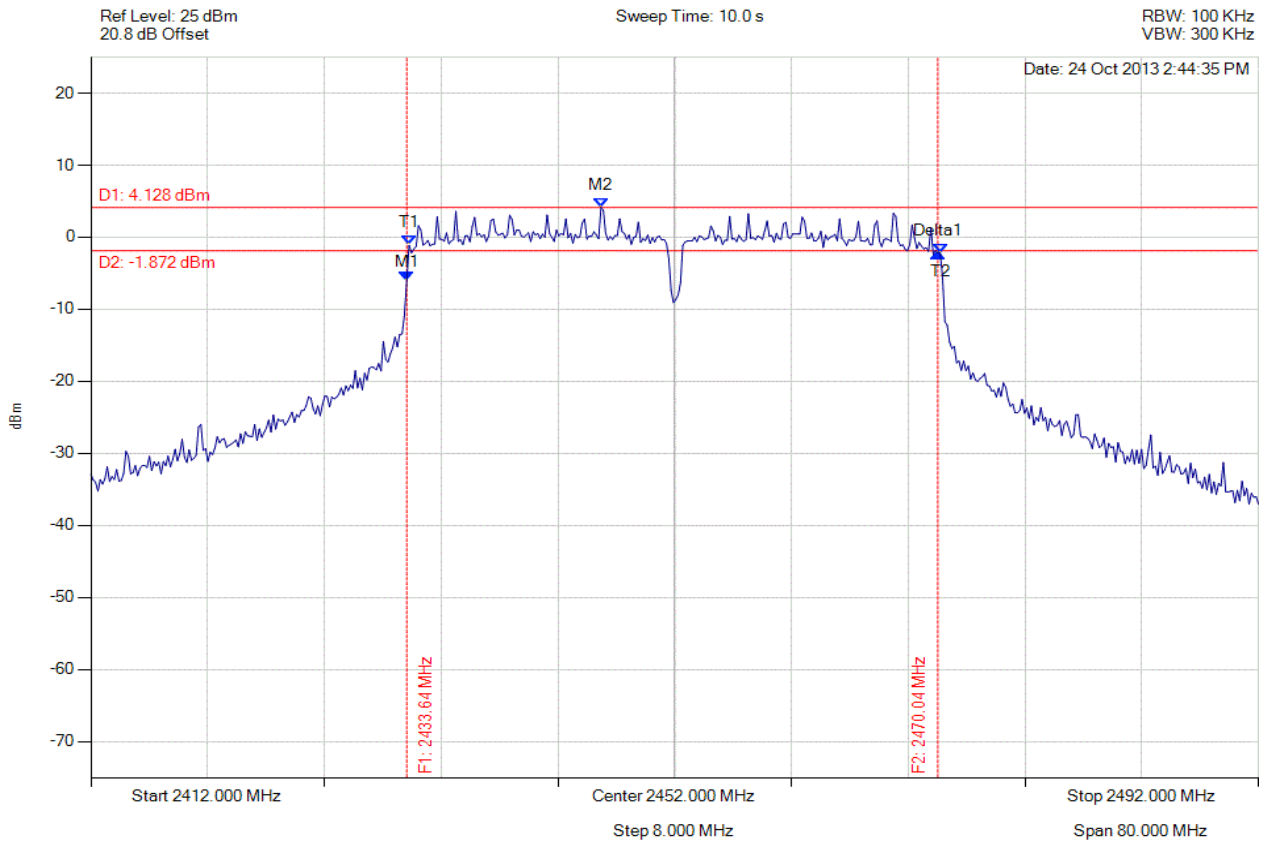

Analyser Setup	Marker : Frequency : Amplitude	Test Results
Detector = MAX PEAK Sweep Count = 0 RF Atten (dB) = 20 Trace Mode = VIEW	M1 : 2433.643 MHz : -5.956 dBm M2 : 2446.950 MHz : 4.128 dBm Delta1 : 36.393 MHz : 3.758 dB T1 : 2433.804 MHz : -1.107 dBm T2 : 2470.196 MHz : -2.201 dBm OBW : 36.393 MHz	Measured 6 dB Bandwidth: 36.393 MHz Limit: ≥ 500.0 kHz Margin: -35.89 MHz

[Back to the Matrix](#)

This test report may be reproduced in full only. The document may only be updated by MiCOM Labs personnel. Any changes will be noted in the Document History section of the report.



6 dB & 99% BANDWIDTH

Variants: 802.11n HT-40, Channel: 2452.00 MHz, Chain b, Temp: Ambient, Voltage: 56 Vdc

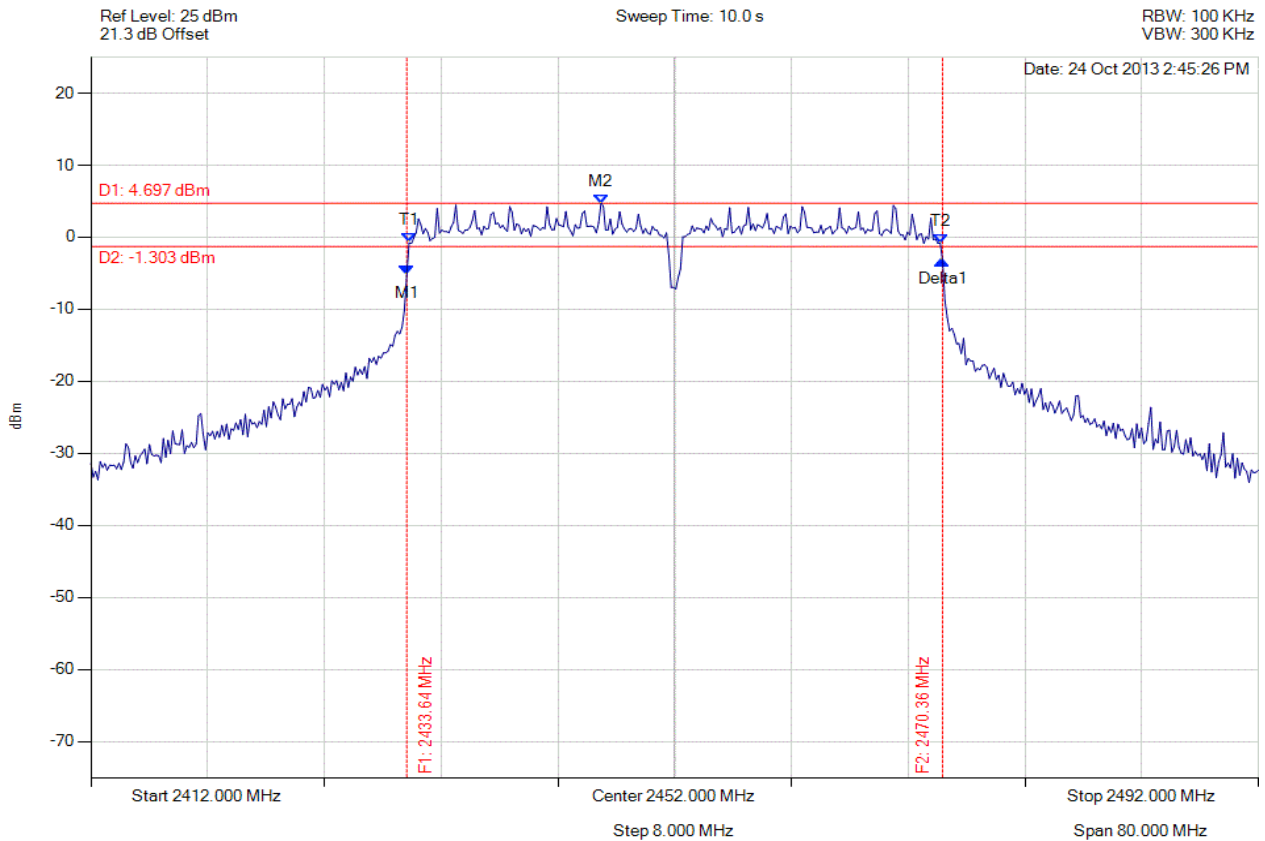

Analyser Setup	Marker : Frequency : Amplitude	Test Results
Detector = MAX PEAK Sweep Count = 0 RF Atten (dB) = 20 Trace Mode = VIEW	M1 : 2433.643 MHz : -5.193 dBm M2 : 2446.950 MHz : 4.697 dBm Delta1 : 36.713 MHz : 1.918 dB T1 : 2433.804 MHz : -0.770 dBm T2 : 2470.196 MHz : -0.853 dBm OBW : 36.393 MHz	Measured 6 dB Bandwidth: 36.713 MHz Limit: ≥ 500.0 kHz Margin: -36.21 MHz

[Back to the Matrix](#)

This test report may be reproduced in full only. The document may only be updated by MiCOM Labs personnel. Any changes will be noted in the Document History section of the report.



6 dB & 99% BANDWIDTH

Variant: 802.11n HT-40, Channel: 2452.00 MHz, Chain c, Temp: Ambient, Voltage: 56 Vdc

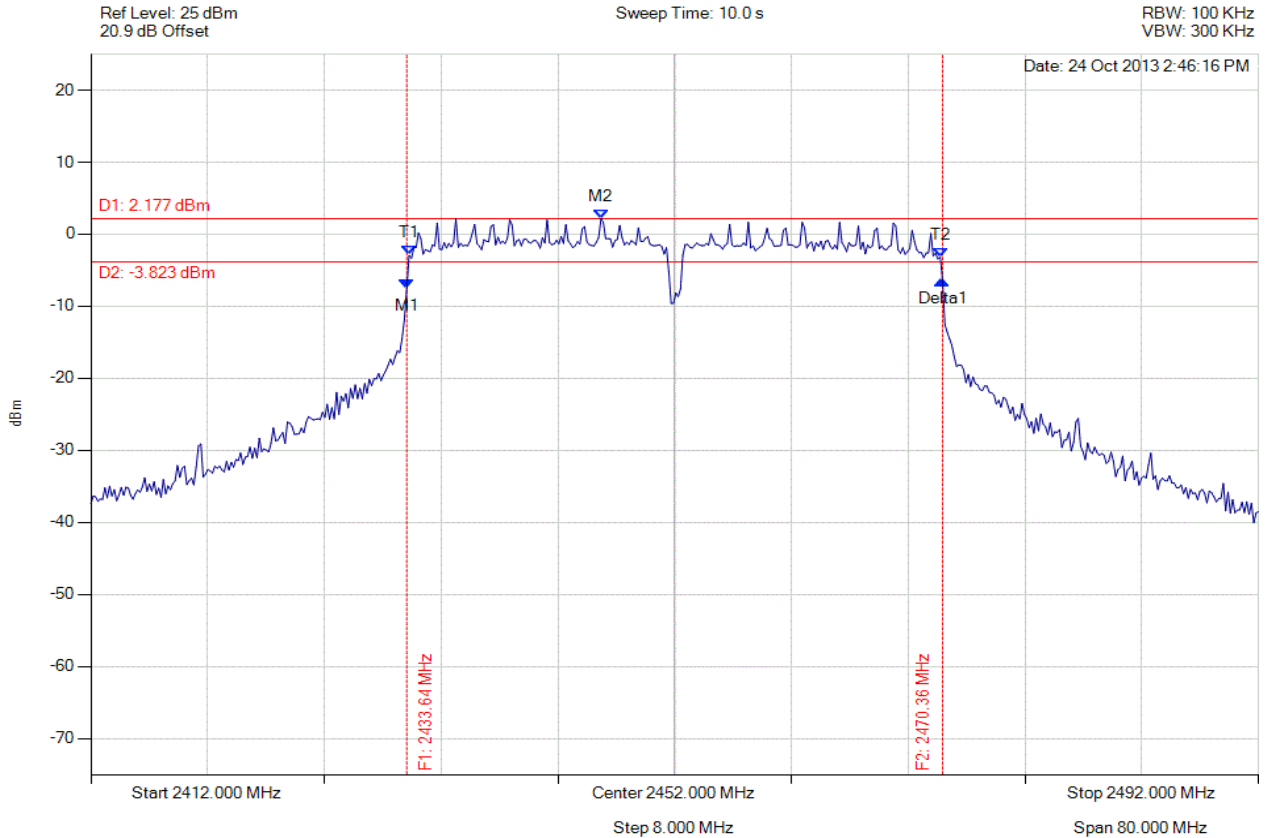

Analyser Setup	Marker : Frequency : Amplitude	Test Results
Detector = MAX PEAK Sweep Count = 0 RF Atten (dB) = 20 Trace Mode = VIEW	M1 : 2433.643 MHz : -7.475 dBm M2 : 2446.950 MHz : 2.177 dBm Delta1 : 36.713 MHz : 1.051 dB T1 : 2433.804 MHz : -2.940 dBm T2 : 2470.196 MHz : -3.202 dBm OBW : 36.393 MHz	Measured 6 dB Bandwidth: 36.713 MHz Limit: ≥500.0 kHz Margin: -36.21 MHz

[Back to the Matrix](#)

This test report may be reproduced in full only. The document may only be updated by MiCOM Labs personnel. Any changes will be noted in the Document History section of the report.



Title: Xirrus Inc. XI-AC1300, XI-AC867
To: FCC 47 CFR Part 15.247 & IC RSS-210
Serial #: XIRR04-U3 Rev A
Issue Date: 29th April 2014
Page: 172 of 572



6 dB & 99% BANDWIDTH

Variant: 802.11a, Channel: 5745.00 MHz, Chain a, Temp: Ambient, Voltage: 56 Vdc

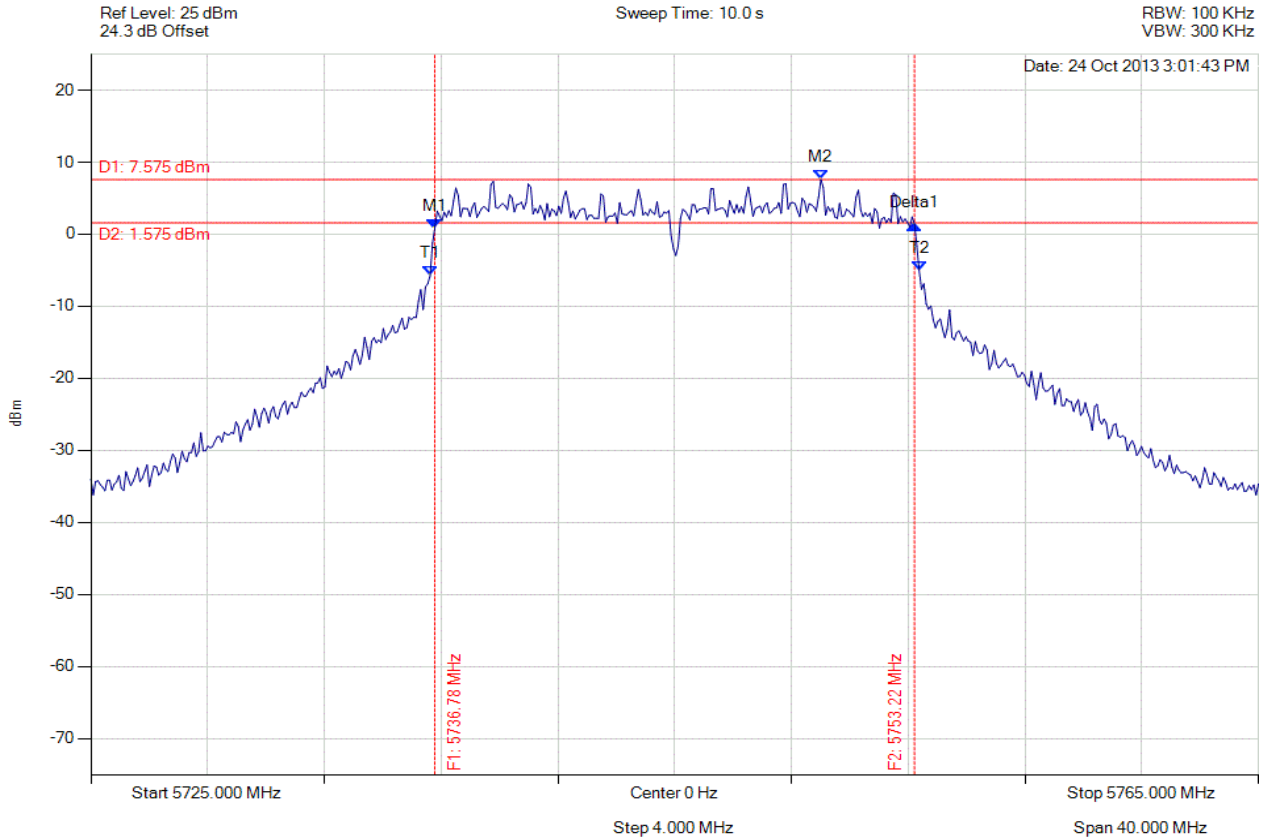

Analyser Setup	Marker : Frequency : Amplitude	Test Results
Detector = MAX PEAK Sweep Count = 0 RF Atten (dB) = 20 Trace Mode = VIEW	M1 : 5736.784 MHz : 0.843 dBm M2 : 5750.010 MHz : 7.575 dBm Delta1 : 16.433 MHz : 0.521 dB T1 : 5736.623 MHz : -5.762 dBm T2 : 5753.377 MHz : -4.990 dBm OBW : 16.754 MHz	Measured 6 dB Bandwidth: 16.433 MHz Limit: ≥ 500.0 kHz Margin: -15.93 MHz

[Back to the Matrix](#)

This test report may be reproduced in full only. The document may only be updated by MiCOM Labs personnel. Any changes will be noted in the Document History section of the report.



Title: Xirrus Inc. XI-AC1300, XI-AC867
To: FCC 47 CFR Part 15.247 & IC RSS-210
Serial #: XIRR04-U3 Rev A
Issue Date: 29th April 2014
Page: 173 of 572



6 dB & 99% BANDWIDTH

Variant: 802.11a, Channel: 5745.00 MHz, Chain b, Temp: Ambient, Voltage: 56 Vdc

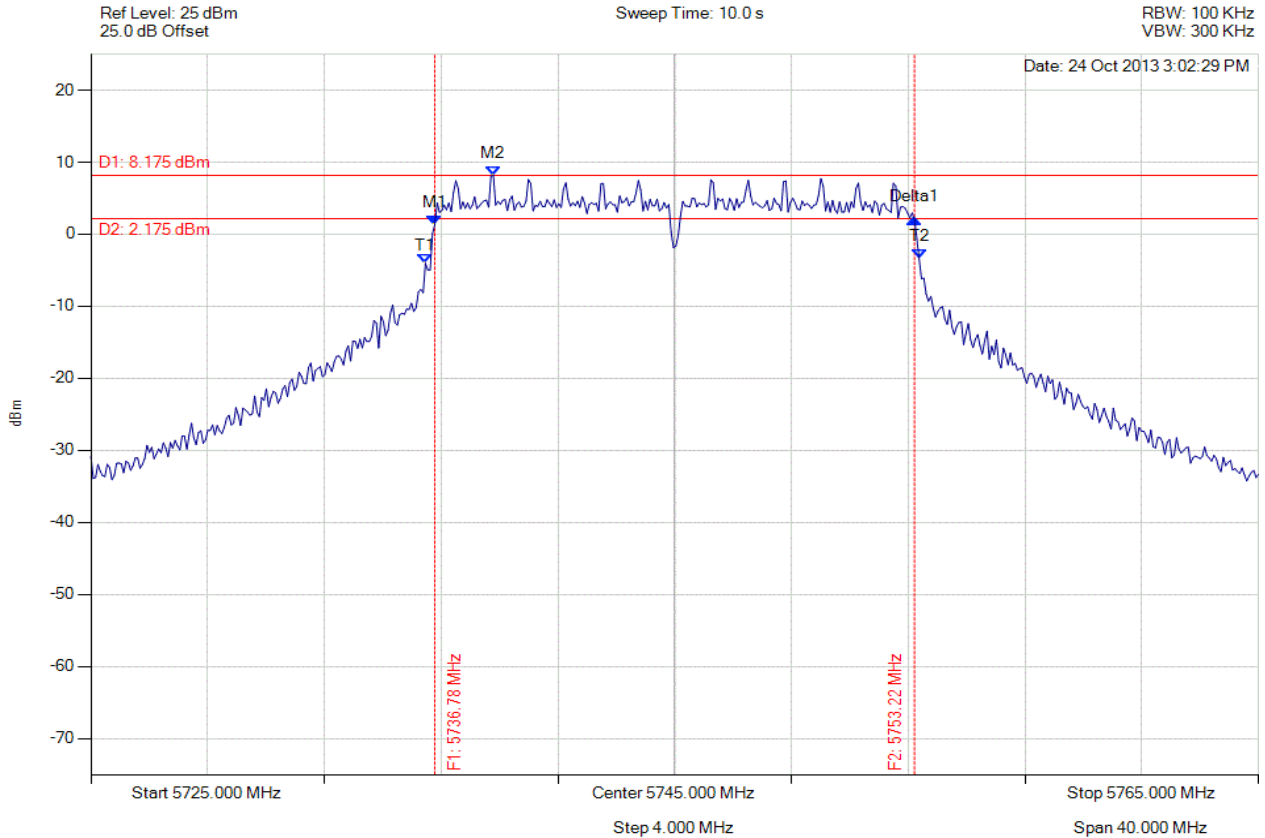

Analyser Setup	Marker : Frequency : Amplitude	Test Results
Detector = MAX PEAK Sweep Count = 0 RF Atten (dB) = 20 Trace Mode = VIEW	M1 : 5736.784 MHz : 1.356 dBm M2 : 5738.788 MHz : 8.175 dBm Delta1 : 16.433 MHz : 0.712 dB T1 : 5736.463 MHz : -4.040 dBm T2 : 5753.377 MHz : -3.428 dBm OBW : 16.914 MHz	Measured 6 dB Bandwidth: 16.433 MHz Limit: ≥ 500.0 kHz Margin: -15.93 MHz

[Back to the Matrix](#)

This test report may be reproduced in full only. The document may only be updated by MiCOM Labs personnel. Any changes will be noted in the Document History section of the report.



6 dB & 99% BANDWIDTH

Variant: 802.11a, Channel: 5745.00 MHz, Chain c, Temp: Ambient, Voltage: 56 Vdc

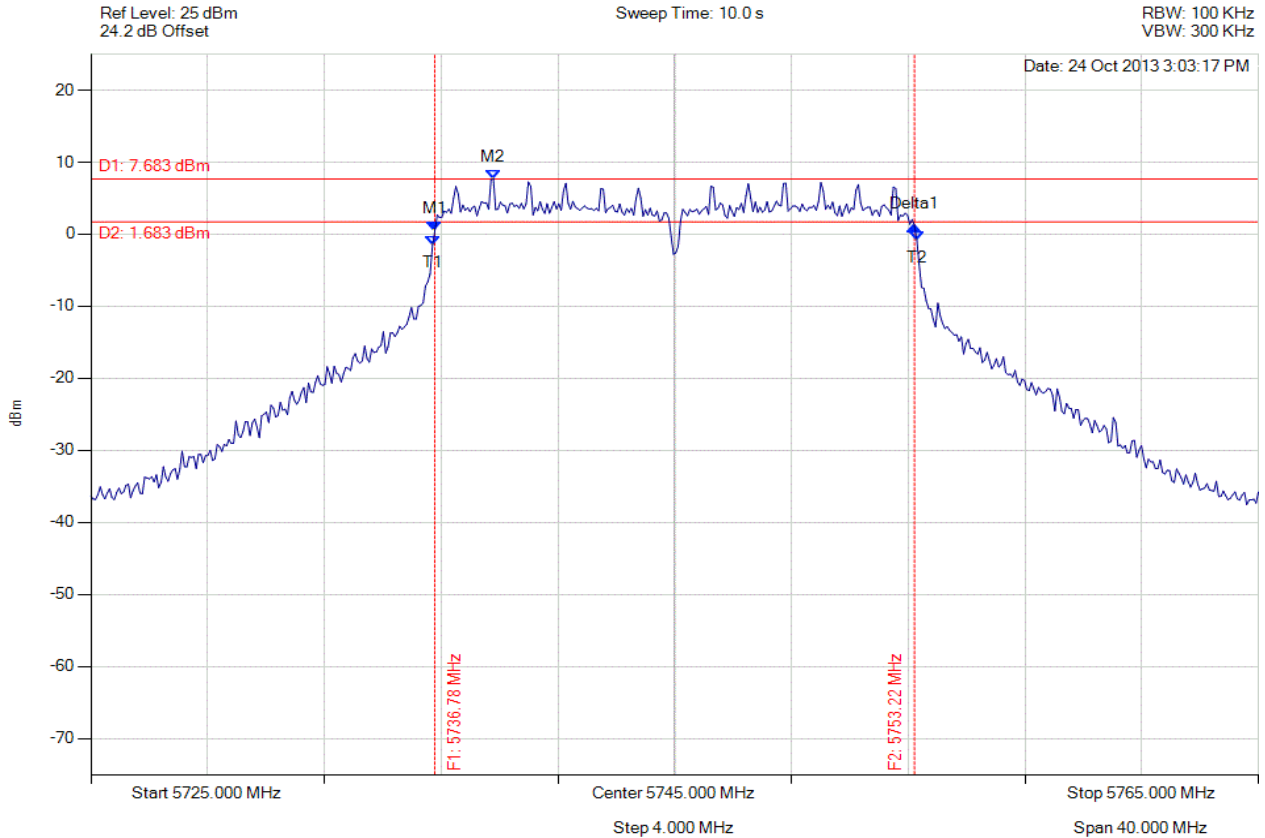

Analyser Setup	Marker : Frequency : Amplitude	Test Results
Detector = MAX PEAK Sweep Count = 0 RF Atten (dB) = 20 Trace Mode = VIEW	M1 : 5736.784 MHz : 0.412 dBm M2 : 5738.788 MHz : 7.683 dBm Delta1 : 16.433 MHz : 0.732 dB T1 : 5736.703 MHz : -1.500 dBm T2 : 5753.297 MHz : -0.822 dBm OBW : 16.593 MHz	Measured 6 dB Bandwidth: 16.433 MHz Limit: ≥ 500.0 kHz Margin: -15.93 MHz

[Back to the Matrix](#)

This test report may be reproduced in full only. The document may only be updated by MiCOM Labs personnel. Any changes will be noted in the Document History section of the report.



Title: Xirrus Inc. XI-AC1300, XI-AC867
To: FCC 47 CFR Part 15.247 & IC RSS-210
Serial #: XIRR04-U3 Rev A
Issue Date: 29th April 2014
Page: 175 of 572



6 dB & 99% BANDWIDTH

Variant: 802.11a, Channel: 5785.00 MHz, Chain a, Temp: Ambient, Voltage: 56 Vdc

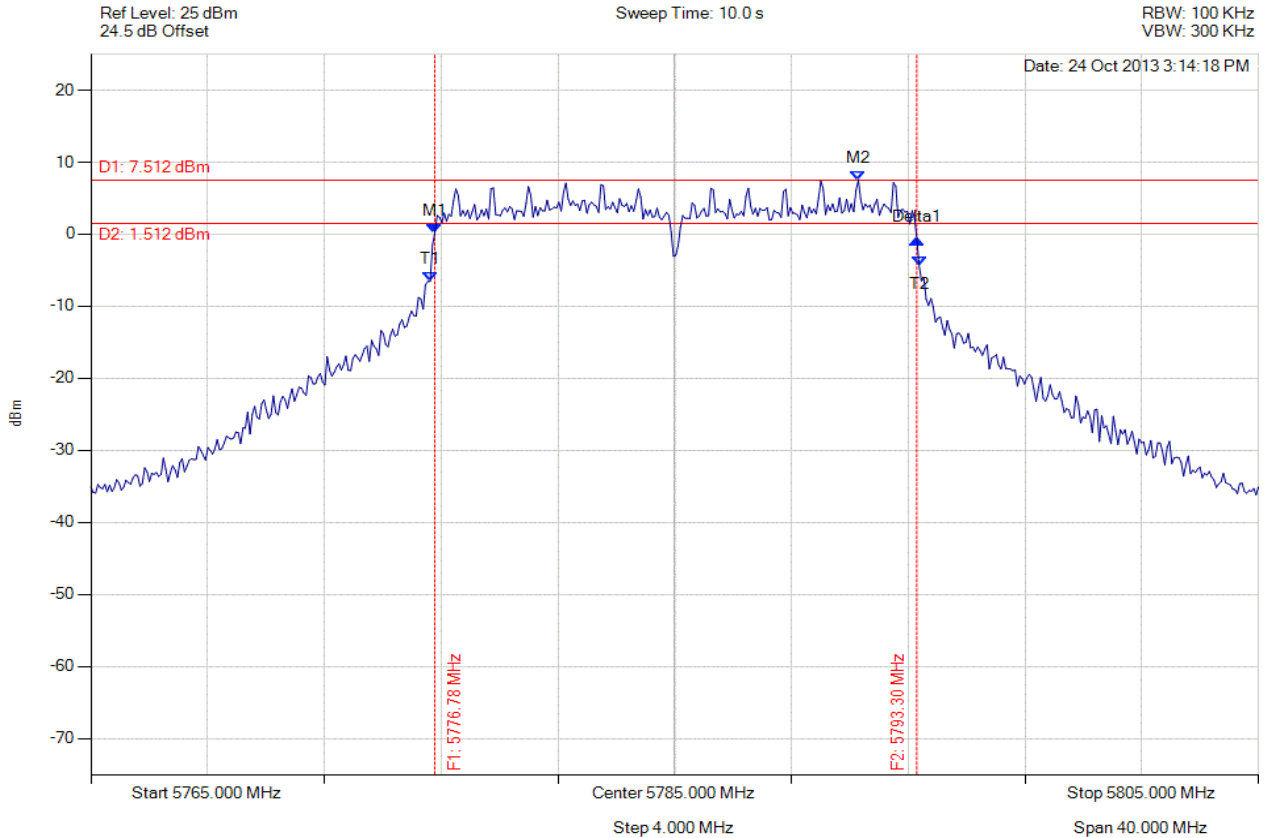

Analyser Setup	Marker : Frequency : Amplitude	Test Results
Detector = MAX PEAK Sweep Count = 0 RF Atten (dB) = 20 Trace Mode = VIEW	M1 : 5776.784 MHz : 0.178 dBm M2 : 5791.293 MHz : 7.512 dBm Delta1 : 16.513 MHz : -0.842 dB T1 : 5776.623 MHz : -6.554 dBm T2 : 5793.377 MHz : -4.365 dBm OBW : 16.754 MHz	Measured 6 dB Bandwidth: 16.513 MHz Limit: ≥ 500.0 kHz Margin: -16.01 MHz

[Back to the Matrix](#)

This test report may be reproduced in full only. The document may only be updated by MiCOM Labs personnel. Any changes will be noted in the Document History section of the report.



6 dB & 99% BANDWIDTH

Variant: 802.11a, Channel: 5785.00 MHz, Chain b, Temp: Ambient, Voltage: 56 Vdc

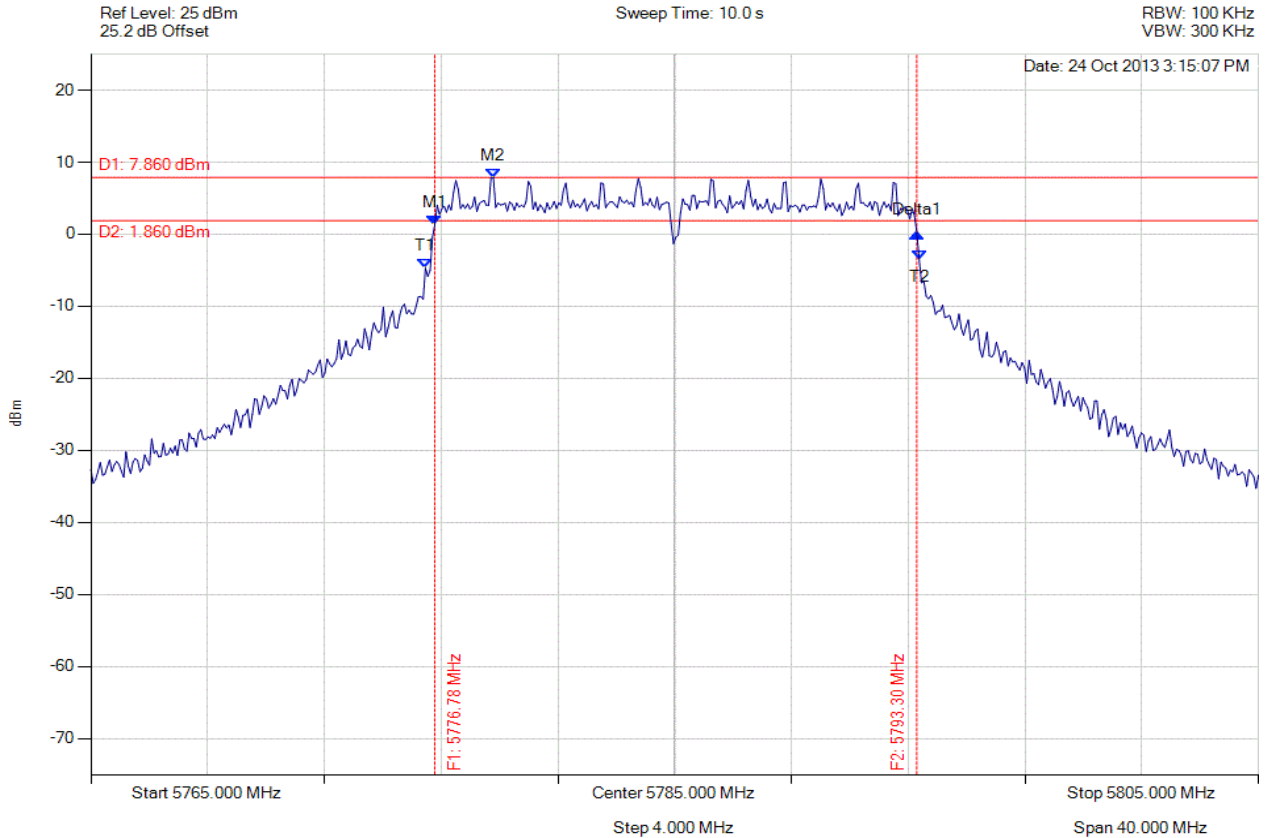

Analyser Setup	Marker : Frequency : Amplitude	Test Results
Detector = MAX PEAK Sweep Count = 0 RF Atten (dB) = 20 Trace Mode = VIEW	M1 : 5776.784 MHz : 1.333 dBm M2 : 5778.788 MHz : 7.860 dBm Delta1 : 16.513 MHz : -1.121 dB T1 : 5776.463 MHz : -4.699 dBm T2 : 5793.377 MHz : -3.468 dBm OBW : 16.914 MHz	Measured 6 dB Bandwidth: 16.513 MHz Limit: ≥ 500.0 kHz Margin: -16.01 MHz

[Back to the Matrix](#)

This test report may be reproduced in full only. The document may only be updated by MiCOM Labs personnel. Any changes will be noted in the Document History section of the report.



6 dB & 99% BANDWIDTH

Variant: 802.11a, Channel: 5785.00 MHz, Chain c, Temp: Ambient, Voltage: 56 Vdc

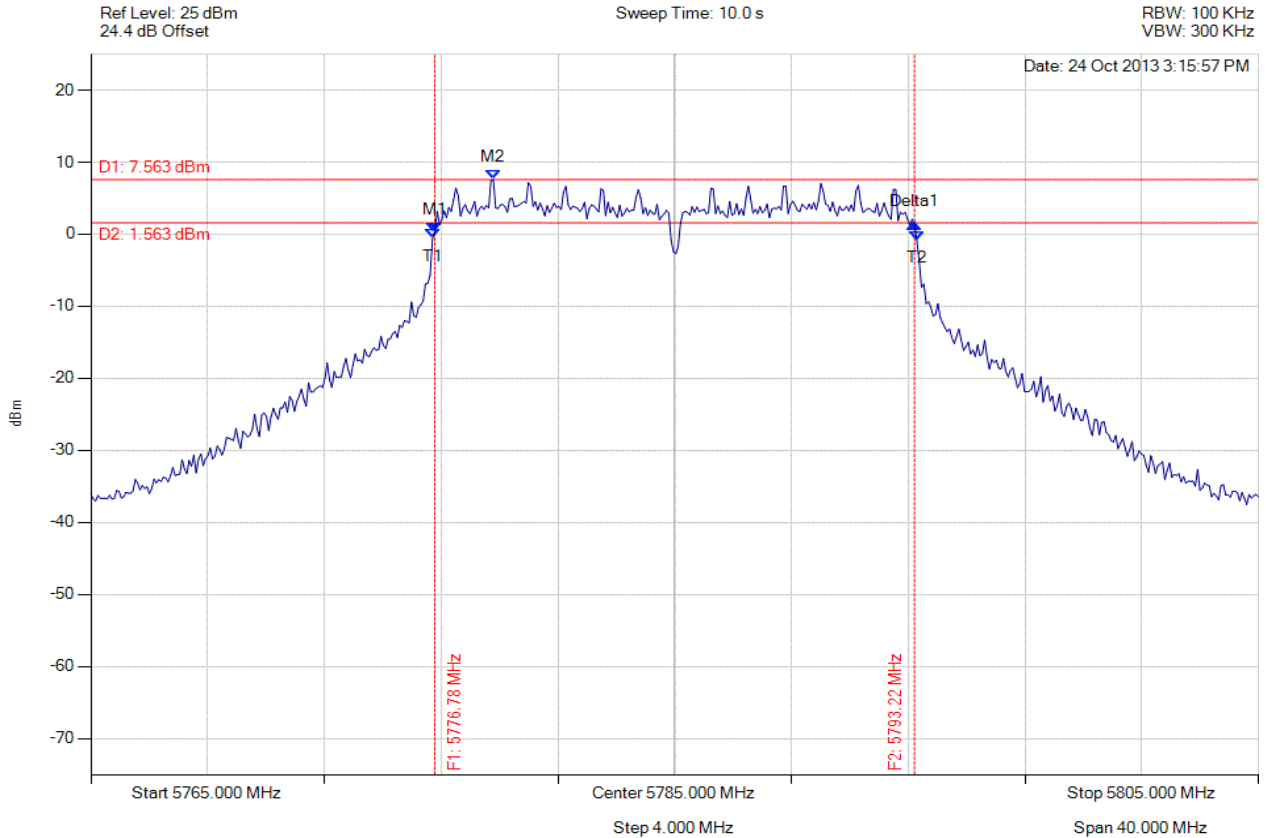

Analyser Setup	Marker : Frequency : Amplitude	Test Results
Detector = MAX PEAK Sweep Count = 0 RF Atten (dB) = 20 Trace Mode = VIEW	M1 : 5776.784 MHz : 0.314 dBm M2 : 5778.788 MHz : 7.563 dBm Delta1 : 16.433 MHz : 1.086 dB T1 : 5776.703 MHz : -0.589 dBm T2 : 5793.297 MHz : -0.839 dBm OBW : 16.593 MHz	Measured 6 dB Bandwidth: 16.433 MHz Limit: ≥ 500.0 kHz Margin: -15.93 MHz

[Back to the Matrix](#)

This test report may be reproduced in full only. The document may only be updated by MiCOM Labs personnel. Any changes will be noted in the Document History section of the report.



Title: Xirrus Inc. XI-AC1300, XI-AC867
To: FCC 47 CFR Part 15.247 & IC RSS-210
Serial #: XIRR04-U3 Rev A
Issue Date: 29th April 2014
Page: 178 of 572



6 dB & 99% BANDWIDTH

Variant: 802.11a, Channel: 5825.00 MHz, Chain a, Temp: Ambient, Voltage: 56 Vdc

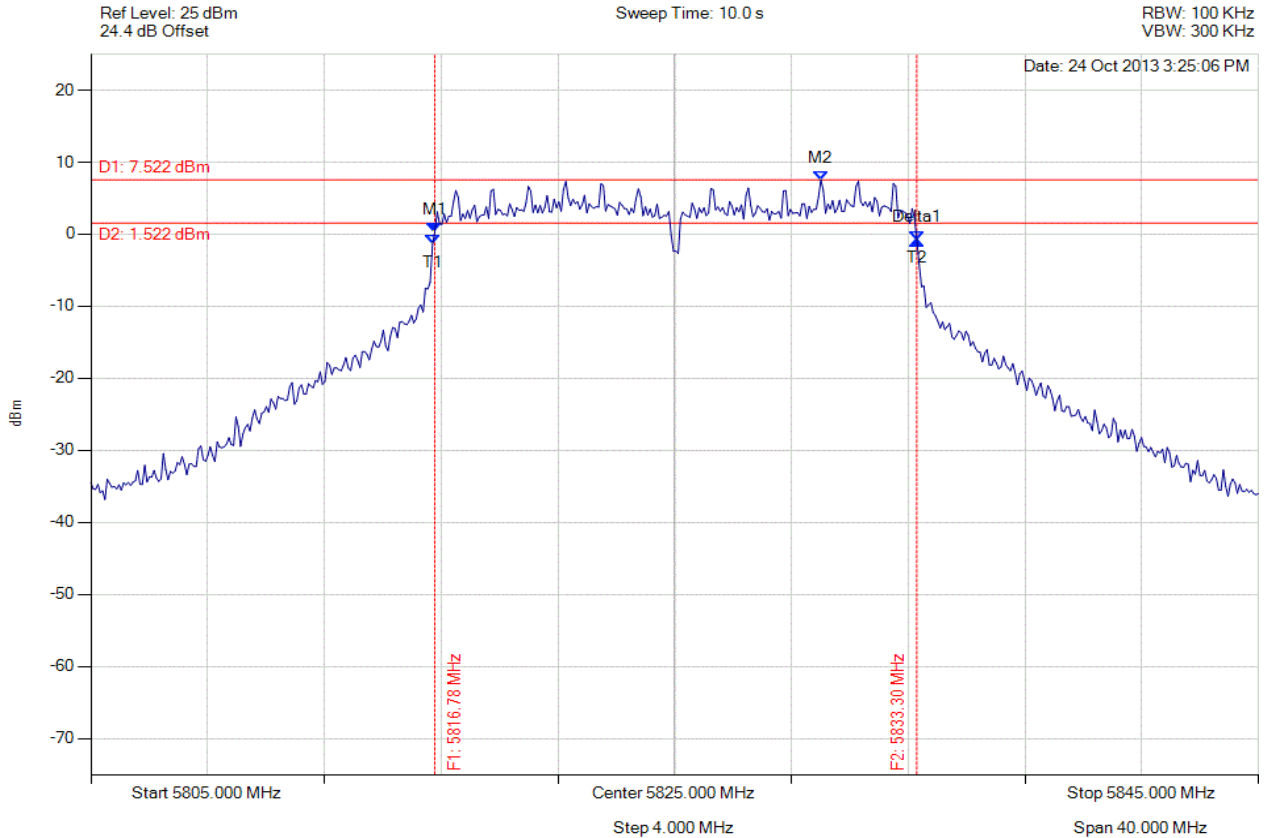

Analyser Setup	Marker : Frequency : Amplitude	Test Results
Detector = MAX PEAK Sweep Count = 0 RF Atten (dB) = 20 Trace Mode = VIEW	M1 : 5816.784 MHz : 0.347 dBm M2 : 5830.010 MHz : 7.522 dBm Delta1 : 16.513 MHz : -1.127 dB T1 : 5816.703 MHz : -1.410 dBm T2 : 5833.297 MHz : -0.780 dBm OBW : 16.593 MHz	Measured 6 dB Bandwidth: 16.513 MHz Limit: ≥ 500.0 kHz Margin: -16.01 MHz

[Back to the Matrix](#)

This test report may be reproduced in full only. The document may only be updated by MiCOM Labs personnel. Any changes will be noted in the Document History section of the report.



Title: Xirrus Inc. XI-AC1300, XI-AC867
To: FCC 47 CFR Part 15.247 & IC RSS-210
Serial #: XIRR04-U3 Rev A
Issue Date: 29th April 2014
Page: 179 of 572



6 dB & 99% BANDWIDTH

Variant: 802.11a, Channel: 5825.00 MHz, Chain b, Temp: Ambient, Voltage: 56 Vdc

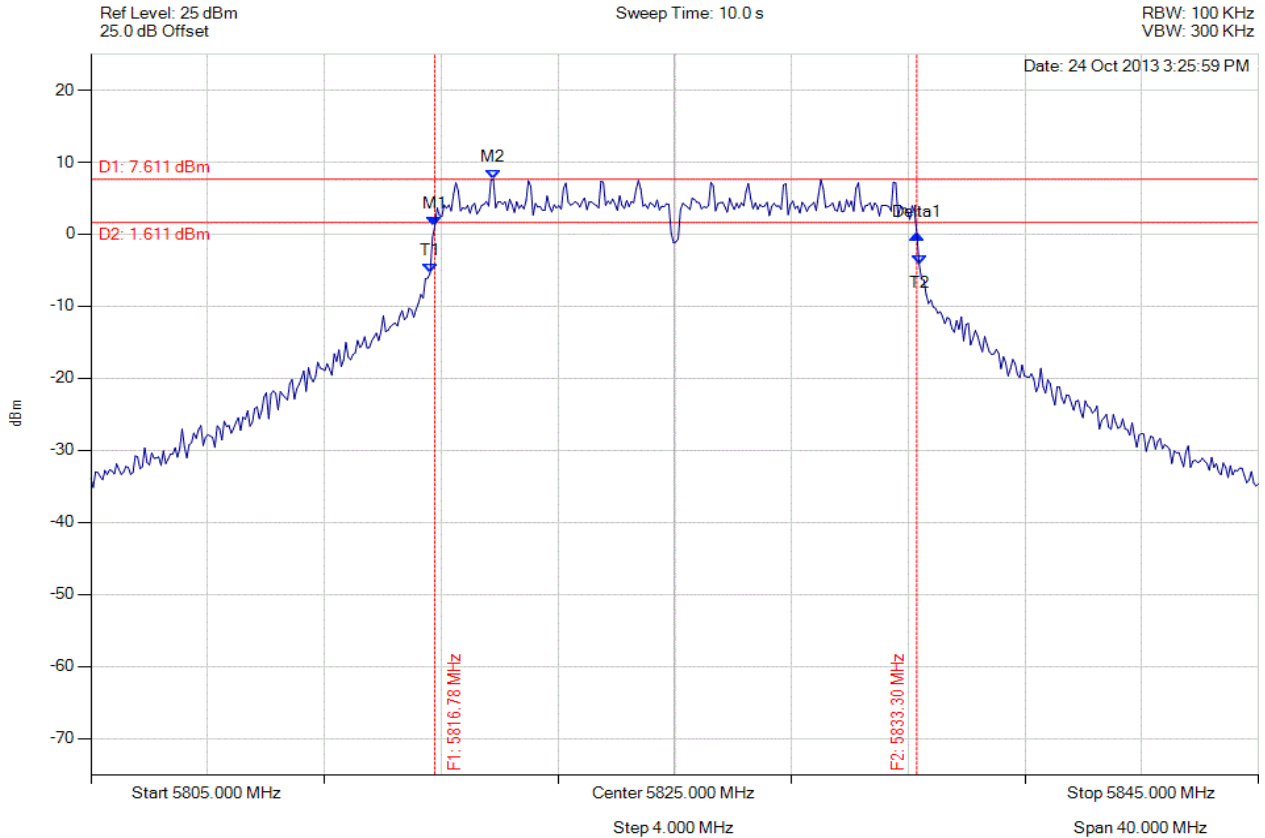

Analyser Setup	Marker : Frequency : Amplitude	Test Results
Detector = MAX PEAK Sweep Count = 0 RF Atten (dB) = 20 Trace Mode = VIEW	M1 : 5816.784 MHz : 1.093 dBm M2 : 5818.788 MHz : 7.611 dBm Delta1 : 16.513 MHz : -1.088 dB T1 : 5816.623 MHz : -5.409 dBm T2 : 5833.377 MHz : -4.180 dBm OBW : 16.754 MHz	Measured 6 dB Bandwidth: 16.513 MHz Limit: ≥ 500.0 kHz Margin: -16.01 MHz

[Back to the Matrix](#)

This test report may be reproduced in full only. The document may only be updated by MiCOM Labs personnel. Any changes will be noted in the Document History section of the report.



Title: Xirrus Inc. XI-AC1300, XI-AC867
To: FCC 47 CFR Part 15.247 & IC RSS-210
Serial #: XIRR04-U3 Rev A
Issue Date: 29th April 2014
Page: 180 of 572



6 dB & 99% BANDWIDTH

Variant: 802.11a, Channel: 5825.00 MHz, Chain c, Temp: Ambient, Voltage: 56 Vdc

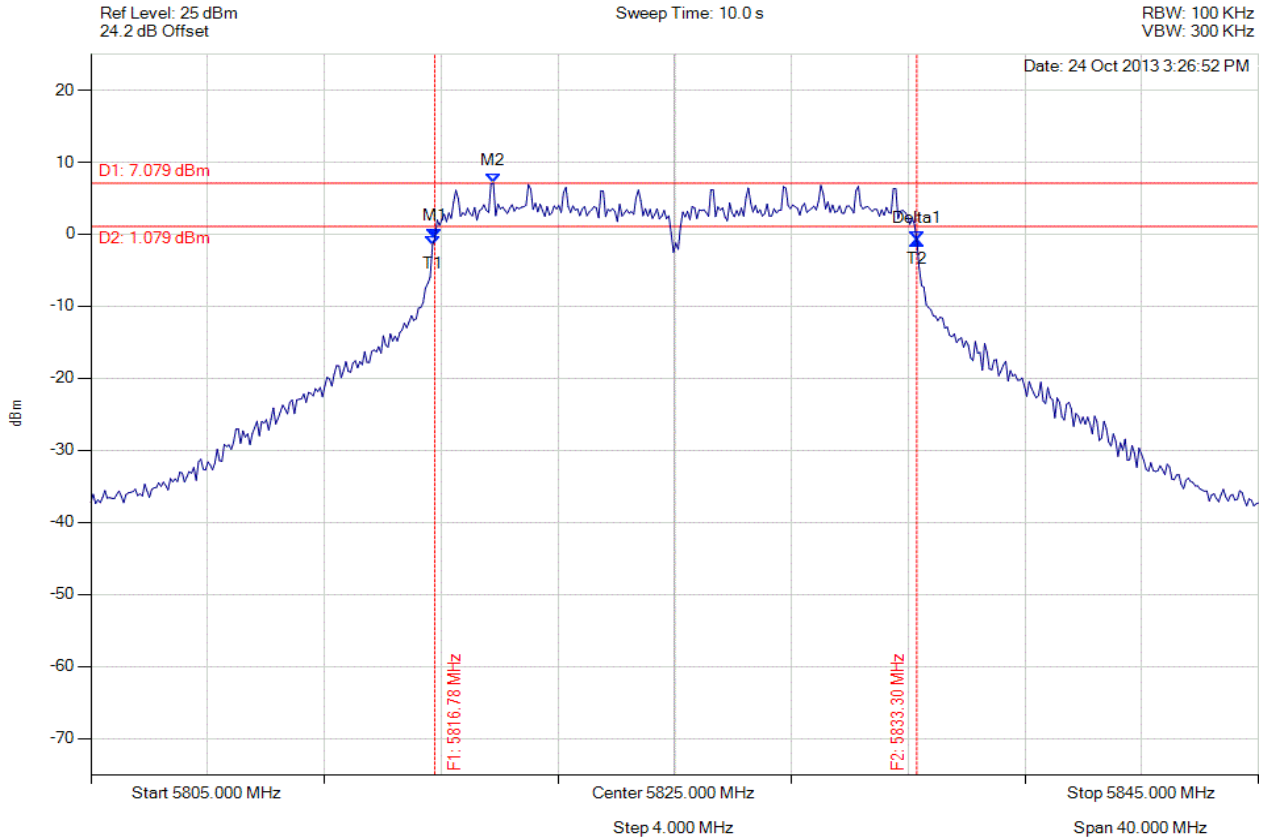

Analyser Setup	Marker : Frequency : Amplitude	Test Results
Detector = MAX PEAK Sweep Count = 0 RF Atten (dB) = 20 Trace Mode = VIEW	M1 : 5816.784 MHz : -0.552 dBm M2 : 5818.788 MHz : 7.079 dBm Delta1 : 16.513 MHz : -0.386 dB T1 : 5816.703 MHz : -1.512 dBm T2 : 5833.297 MHz : -0.938 dBm OBW : 16.593 MHz	Measured 6 dB Bandwidth: 16.513 MHz Limit: \geq 500.0 kHz Margin: -16.01 MHz

[Back to the Matrix](#)

This test report may be reproduced in full only. The document may only be updated by MiCOM Labs personnel. Any changes will be noted in the Document History section of the report.



6 dB & 99% BANDWIDTH

Variant: 802.11ac-40, Channel: 5755.00 MHz, Chain a, Temp: Ambient, Voltage: 56 Vdc

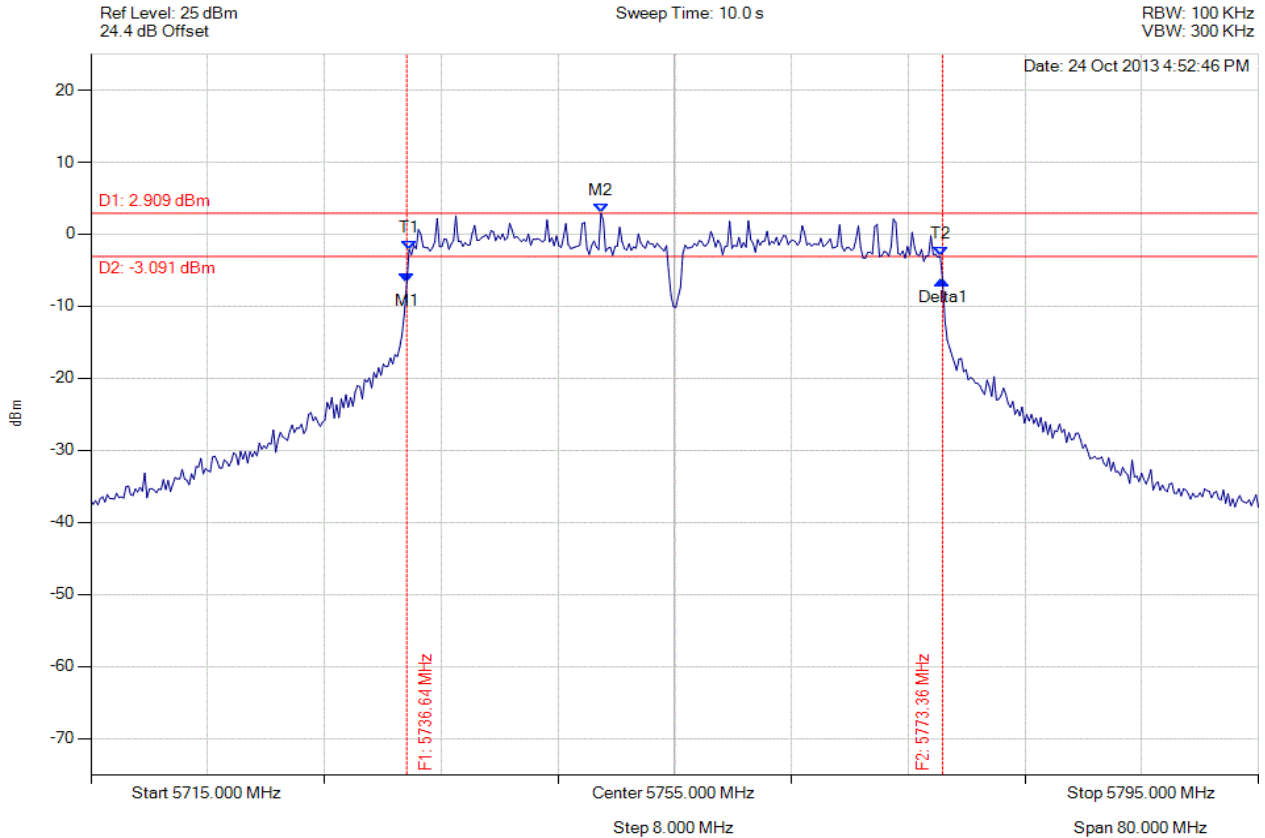

Analyser Setup	Marker : Frequency : Amplitude	Test Results
Detector = MAX PEAK Sweep Count = 0 RF Atten (dB) = 20 Trace Mode = VIEW	M1 : 5736.643 MHz : -6.749 dBm M2 : 5749.950 MHz : 2.909 dBm Delta1 : 36.713 MHz : 0.411 dB T1 : 5736.804 MHz : -2.132 dBm T2 : 5773.196 MHz : -3.078 dBm OBW : 36.393 MHz	Measured 6 dB Bandwidth: 36.713 MHz Limit: ≥ 500.0 kHz Margin: -36.21 MHz

[Back to the Matrix](#)

This test report may be reproduced in full only. The document may only be updated by MiCOM Labs personnel. Any changes will be noted in the Document History section of the report.



6 dB & 99% BANDWIDTH

Variant: 802.11ac-40, Channel: 5755.00 MHz, Chain b, Temp: Ambient, Voltage: 56 Vdc

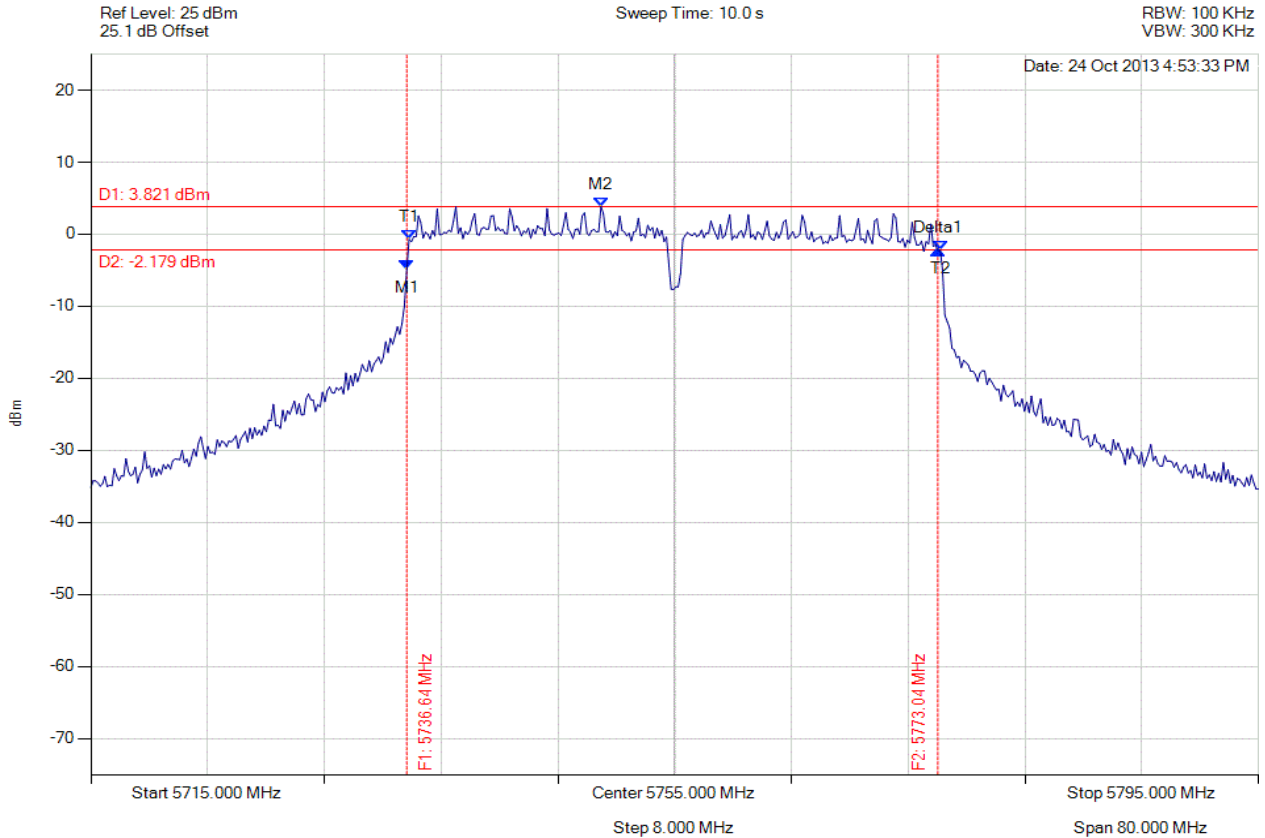

Analyser Setup	Marker : Frequency : Amplitude	Test Results
Detector = MAX PEAK Sweep Count = 0 RF Atten (dB) = 20 Trace Mode = VIEW	M1 : 5736.643 MHz : -4.888 dBm M2 : 5749.950 MHz : 3.821 dBm Delta1 : 36.393 MHz : 2.628 dB T1 : 5736.804 MHz : -0.684 dBm T2 : 5773.196 MHz : -2.246 dBm OBW : 36.393 MHz	Measured 6 dB Bandwidth: 36.393 MHz Limit: ≥ 500.0 kHz Margin: -35.89 MHz

[Back to the Matrix](#)

This test report may be reproduced in full only. The document may only be updated by MiCOM Labs personnel. Any changes will be noted in the Document History section of the report.



6 dB & 99% BANDWIDTH

Variant: 802.11ac-40, Channel: 5755.00 MHz, Chain c, Temp: Ambient, Voltage: 56 Vdc

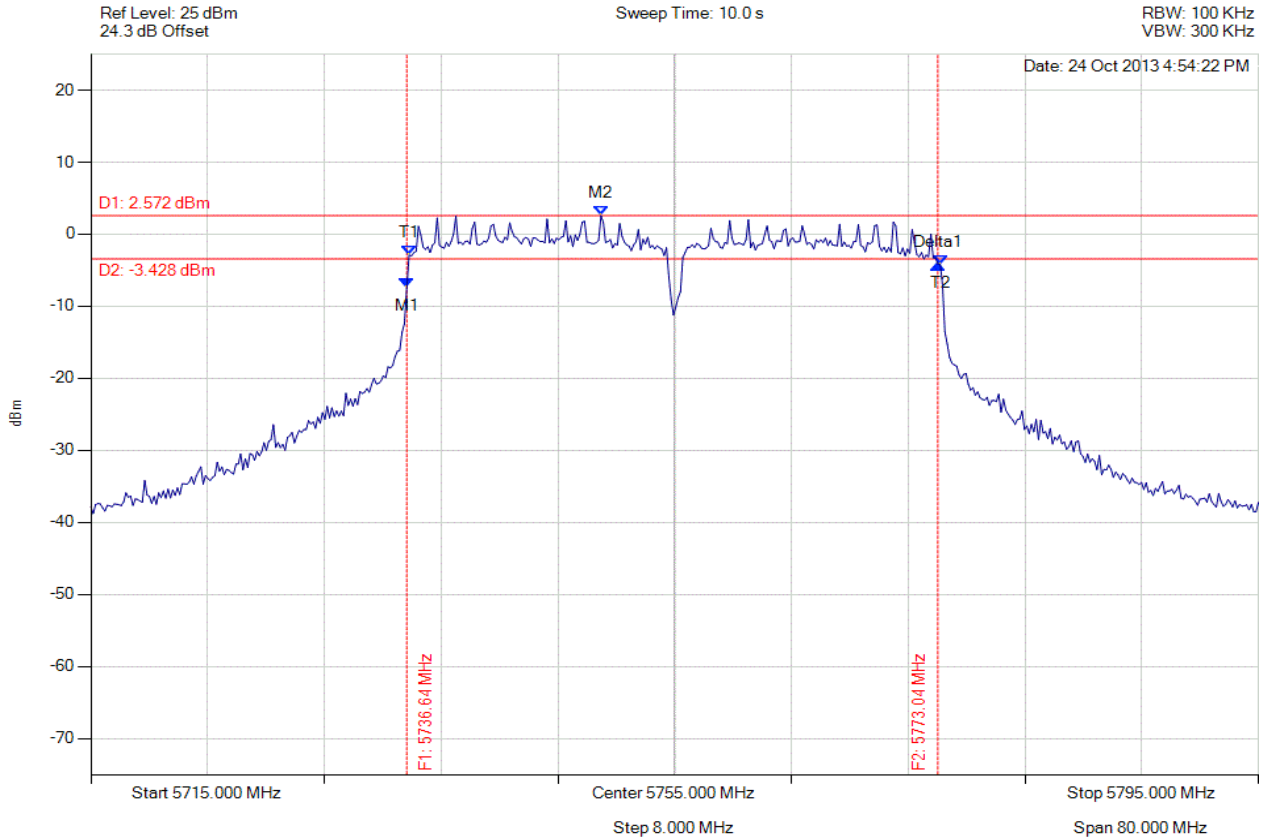

Analyser Setup	Marker : Frequency : Amplitude	Test Results
Detector = MAX PEAK Sweep Count = 0 RF Atten (dB) = 20 Trace Mode = VIEW	M1 : 5736.643 MHz : -7.440 dBm M2 : 5749.950 MHz : 2.572 dBm Delta1 : 36.393 MHz : 3.282 dB T1 : 5736.804 MHz : -2.901 dBm T2 : 5773.196 MHz : -4.184 dBm OBW : 36.393 MHz	Measured 6 dB Bandwidth: 36.393 MHz Limit: ≥ 500.0 kHz Margin: -35.89 MHz

[Back to the Matrix](#)

This test report may be reproduced in full only. The document may only be updated by MiCOM Labs personnel. Any changes will be noted in the Document History section of the report.



6 dB & 99% BANDWIDTH

Variant: 802.11ac-40, Channel: 5795.00 MHz, Chain a, Temp: Ambient, Voltage: 56 Vdc

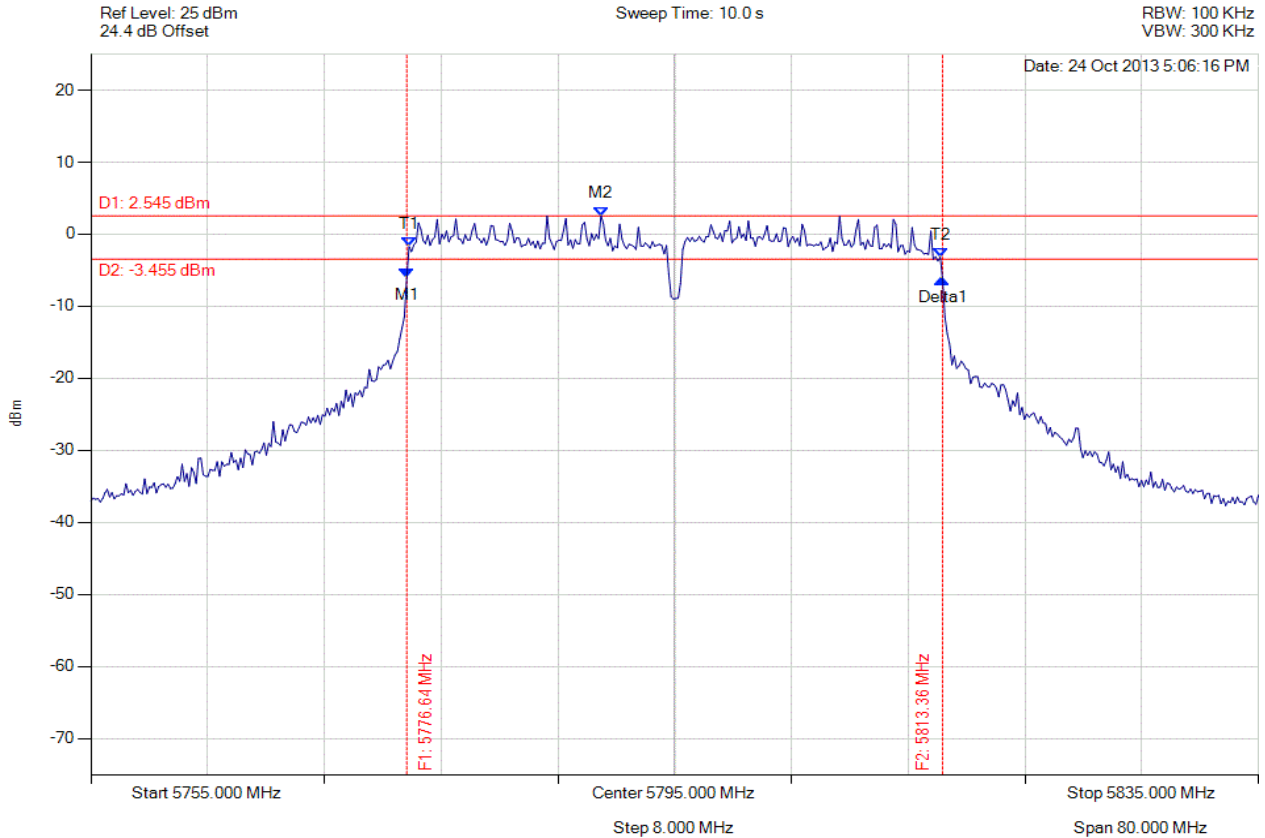

Analyser Setup	Marker : Frequency : Amplitude	Test Results
Detector = MAX PEAK Sweep Count = 0 RF Atten (dB) = 20 Trace Mode = VIEW	M1 : 5776.643 MHz : -5.962 dBm M2 : 5789.950 MHz : 2.545 dBm Delta1 : 36.713 MHz : -0.291 dB T1 : 5776.804 MHz : -1.709 dBm T2 : 5813.196 MHz : -3.173 dBm OBW : 36.393 MHz	Measured 6 dB Bandwidth: 36.713 MHz Limit: ≥ 500.0 kHz Margin: -36.21 MHz

[Back to the Matrix](#)

This test report may be reproduced in full only. The document may only be updated by MiCOM Labs personnel. Any changes will be noted in the Document History section of the report.



Title: Xirrus Inc. XI-AC1300, XI-AC867
To: FCC 47 CFR Part 15.247 & IC RSS-210
Serial #: XIRR04-U3 Rev A
Issue Date: 29th April 2014
Page: 185 of 572



6 dB & 99% BANDWIDTH

Variant: 802.11ac-40, Channel: 5795.00 MHz, Chain b, Temp: Ambient, Voltage: 56 Vdc

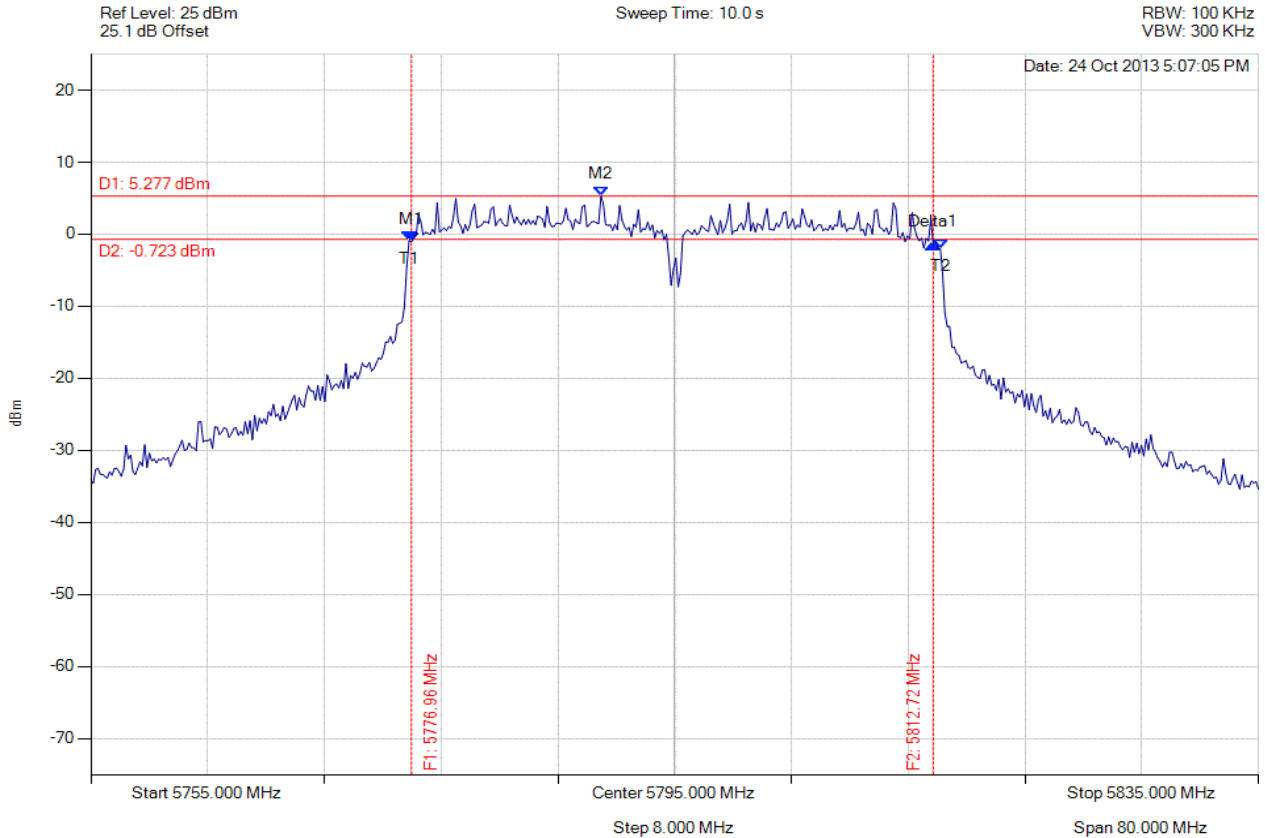

Analyser Setup	Marker : Frequency : Amplitude	Test Results
Detector = MAX PEAK Sweep Count = 0 RF Atten (dB) = 20 Trace Mode = VIEW	M1 : 5776.964 MHz : -1.032 dBm M2 : 5789.950 MHz : 5.277 dBm Delta1 : 35.752 MHz : -0.360 dB T1 : 5776.804 MHz : -0.916 dBm T2 : 5813.196 MHz : -1.967 dBm OBW : 36.393 MHz	Measured 6 dB Bandwidth: 35.752 MHz Limit: ≥500.0 kHz Margin: -35.25 MHz

[Back to the Matrix](#)

This test report may be reproduced in full only. The document may only be updated by MiCOM Labs personnel. Any changes will be noted in the Document History section of the report.



Title: Xirrus Inc. XI-AC1300, XI-AC867
To: FCC 47 CFR Part 15.247 & IC RSS-210
Serial #: XIRR04-U3 Rev A
Issue Date: 29th April 2014
Page: 186 of 572



6 dB & 99% BANDWIDTH

Variant: 802.11ac-40, Channel: 5795.00 MHz, Chain c, Temp: Ambient, Voltage: 56 Vdc

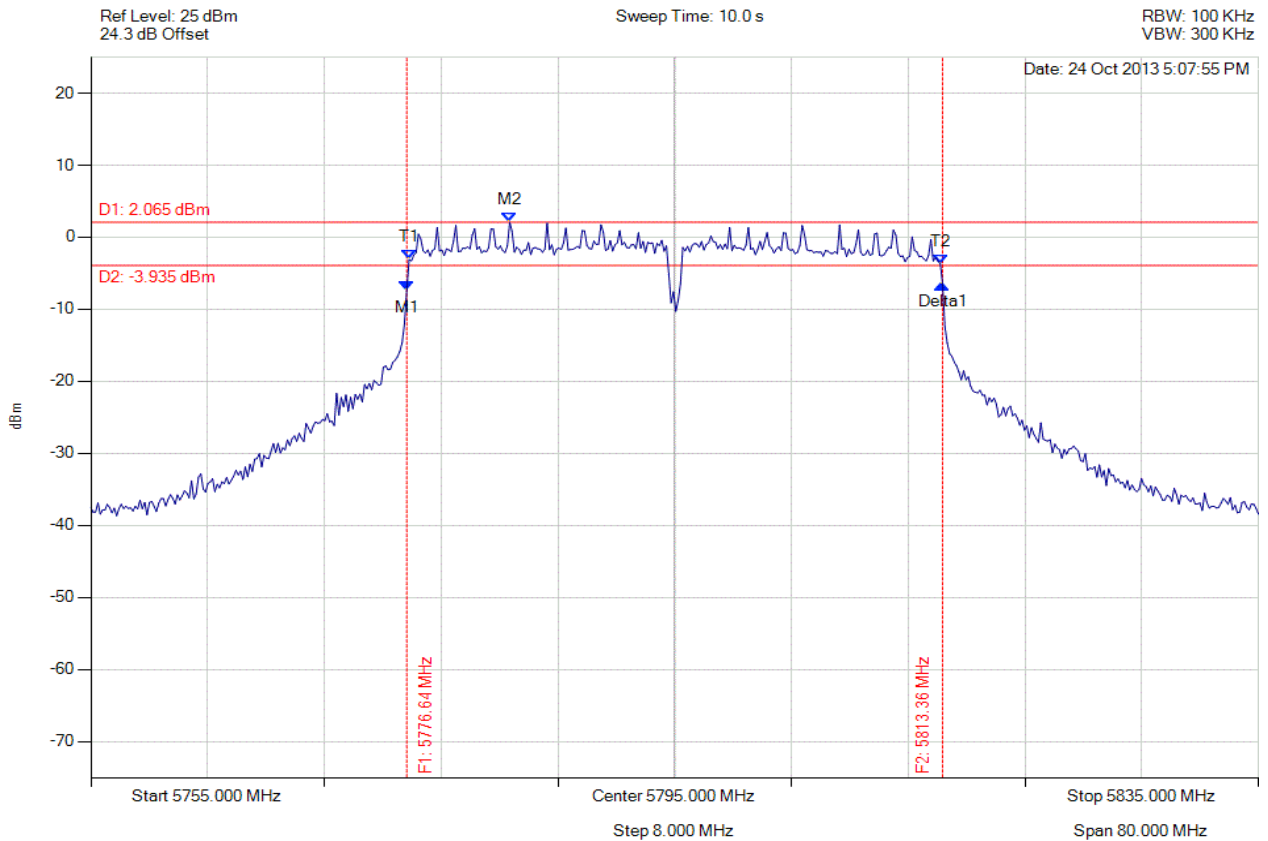

Analyser Setup	Marker : Frequency : Amplitude	Test Results
Detector = MAX PEAK Sweep Count = 0 RF Atten (dB) = 20 Trace Mode = VIEW	M1 : 5776.643 MHz : -7.328 dBm M2 : 5783.697 MHz : 2.065 dBm Delta1 : 36.713 MHz : 0.856 dB T1 : 5776.804 MHz : -3.098 dBm T2 : 5813.196 MHz : -3.692 dBm OBW : 36.393 MHz	Measured 6 dB Bandwidth: 36.713 MHz Limit: ≥ 500.0 kHz Margin: -36.21 MHz

[Back to the Matrix](#)

This test report may be reproduced in full only. The document may only be updated by MiCOM Labs personnel. Any changes will be noted in the Document History section of the report.



6 dB & 99% BANDWIDTH

Variant: 802.11ac-80, Channel: 5775.00 MHz, Chain a, Temp: Ambient, Voltage: 56 Vdc

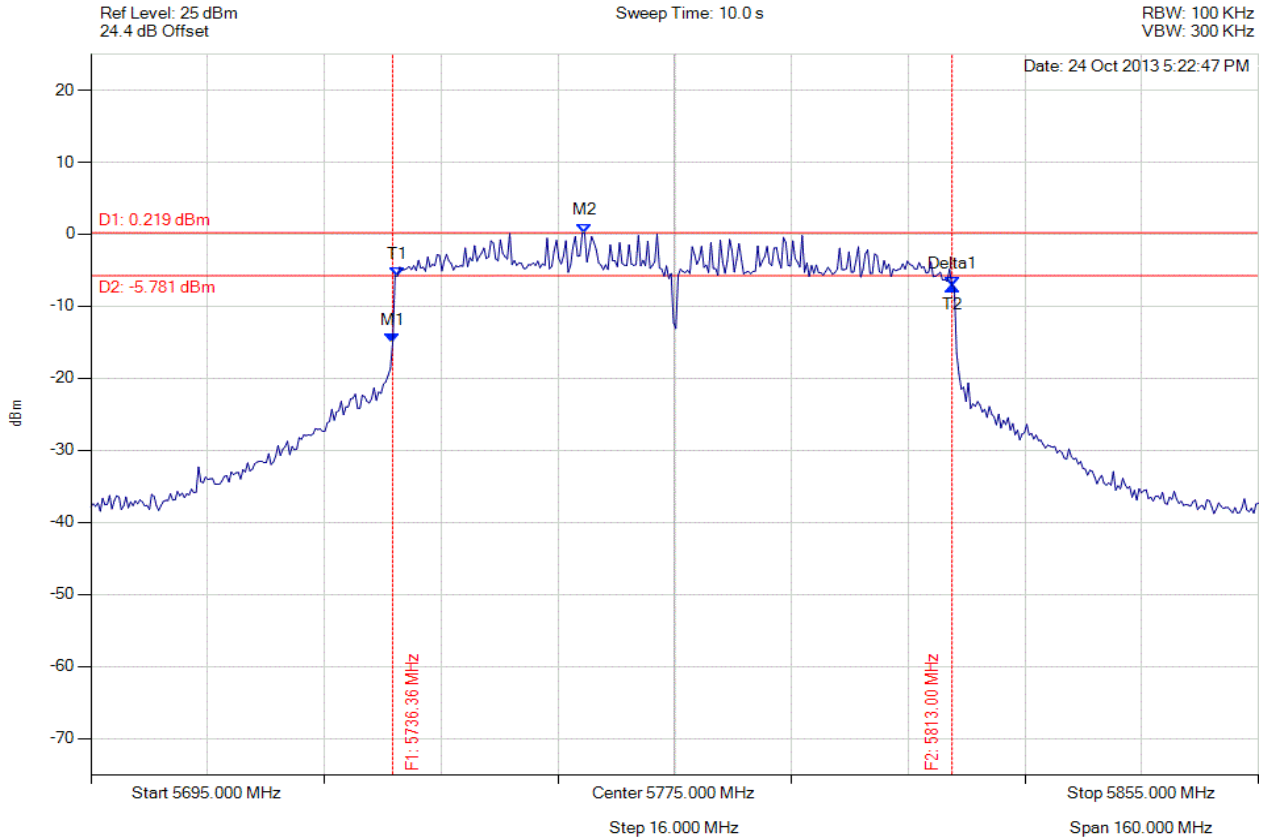

Analyser Setup	Marker : Frequency : Amplitude	Test Results
Detector = MAX PEAK Sweep Count = 0 RF Atten (dB) = 20 Trace Mode = VIEW	M1 : 5736.363 MHz : -15.030 dBm M2 : 5762.655 MHz : 0.219 dBm Delta1 : 76.633 MHz : 7.844 dB T1 : 5737.004 MHz : -5.819 dBm T2 : 5812.996 MHz : -7.186 dBm OBW : 75.992 MHz	Measured 6 dB Bandwidth: 76.633 MHz Limit: ≥ 500.0 kHz Margin: -76.13 MHz

[Back to the Matrix](#)

This test report may be reproduced in full only. The document may only be updated by MiCOM Labs personnel. Any changes will be noted in the Document History section of the report.



6 dB & 99% BANDWIDTH

Variant: 802.11ac-80, Channel: 5775.00 MHz, Chain b, Temp: Ambient, Voltage: 56 Vdc

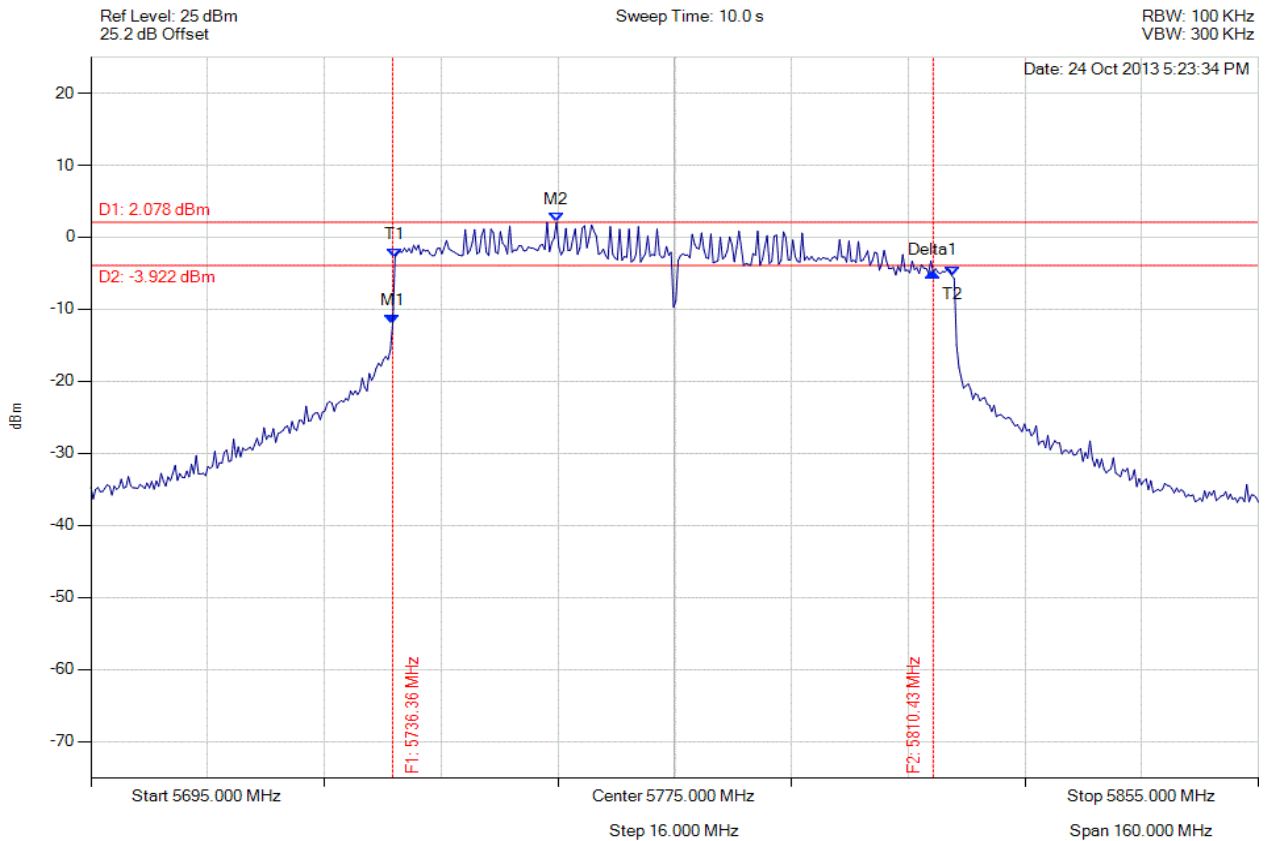

Analyser Setup	Marker : Frequency : Amplitude	Test Results
Detector = MAX PEAK Sweep Count = 0 RF Atten (dB) = 20 Trace Mode = VIEW	M1 : 5736.363 MHz : -11.965 dBm M2 : 5758.808 MHz : 2.078 dBm Delta1 : 74.068 MHz : 7.104 dB T1 : 5736.683 MHz : -2.787 dBm T2 : 5812.996 MHz : -5.343 dBm OBW : 76.313 MHz	Measured 6 dB Bandwidth: 74.068 MHz Limit: ≥ 500.0 kHz Margin: -73.57 MHz

[Back to the Matrix](#)

This test report may be reproduced in full only. The document may only be updated by MiCOM Labs personnel. Any changes will be noted in the Document History section of the report.



Title: Xirrus Inc. XI-AC1300, XI-AC867
To: FCC 47 CFR Part 15.247 & IC RSS-210
Serial #: XIRR04-U3 Rev A
Issue Date: 29th April 2014
Page: 189 of 572



6 dB & 99% BANDWIDTH

Variant: 802.11ac-80, Channel: 5775.00 MHz, Chain c, Temp: Ambient, Voltage: 56 Vdc

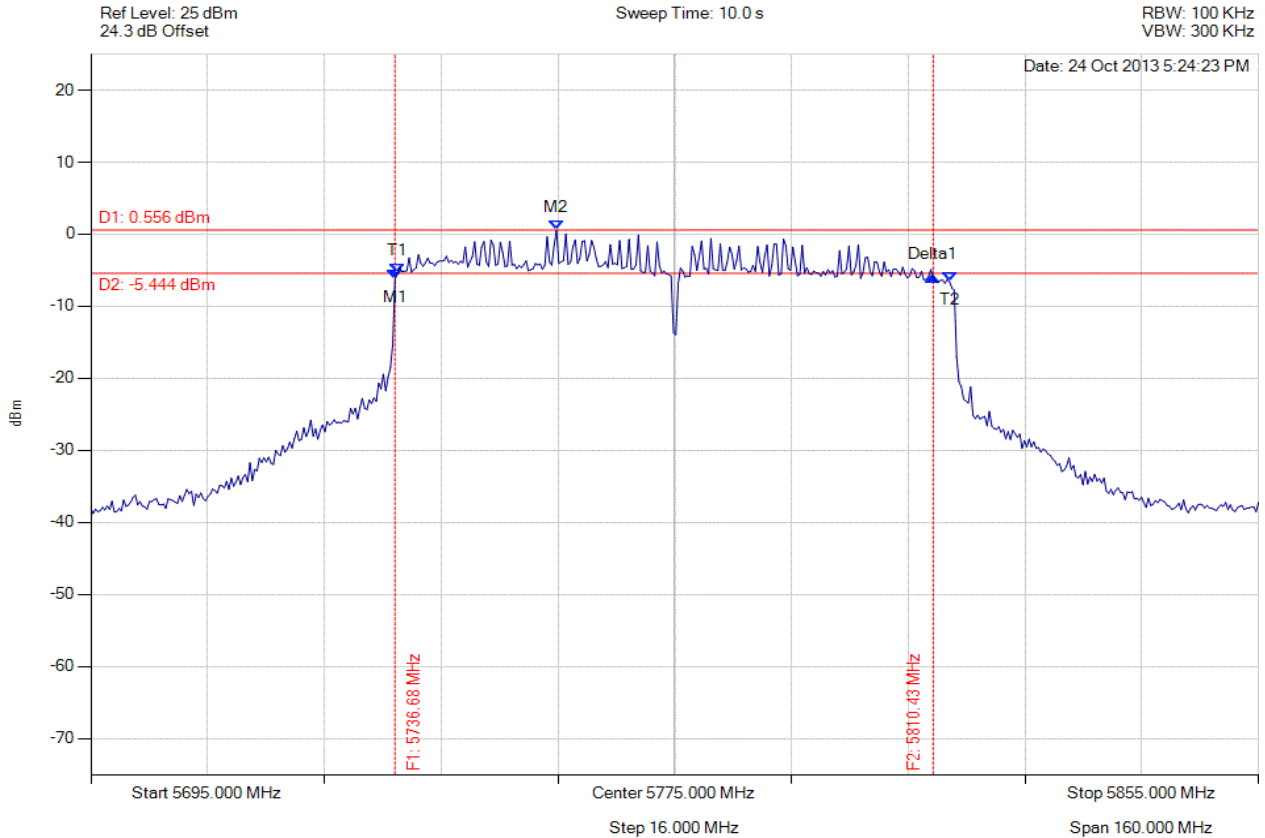

Analyser Setup	Marker : Frequency : Amplitude	Test Results
Detector = MAX PEAK Sweep Count = 0 RF Atten (dB) = 20 Trace Mode = VIEW	M1 : 5736.683 MHz : -6.249 dBm M2 : 5758.808 MHz : 0.556 dBm Delta1 : 73.747 MHz : 0.305 dB T1 : 5737.004 MHz : -5.398 dBm T2 : 5812.675 MHz : -6.564 dBm OBW : 75.671 MHz	Measured 6 dB Bandwidth: 73.747 MHz Limit: ≥500.0 kHz Margin: -73.25 MHz

[Back to the Matrix](#)

This test report may be reproduced in full only. The document may only be updated by MiCOM Labs personnel. Any changes will be noted in the Document History section of the report.



Title: Xirrus Inc. XI-AC1300, XI-AC867
To: FCC 47 CFR Part 15.247 & IC RSS-210
Serial #: XIRR04-U3 Rev A
Issue Date: 29th April 2014
Page: 190 of 572



6 dB & 99% BANDWIDTH

Variant: 802.11n HT-20, Channel: 5745.00 MHz, Chain a, Temp: Ambient, Voltage: 56 Vdc

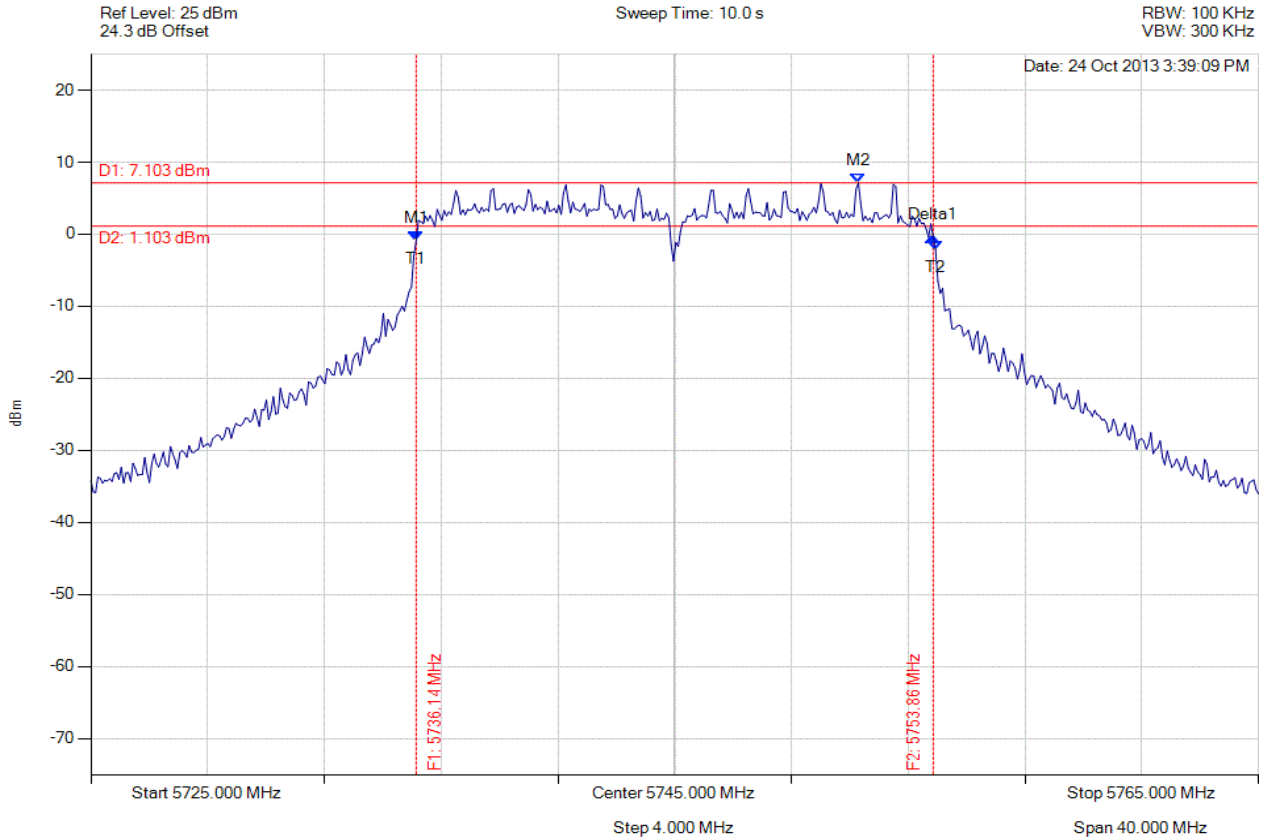

Analyser Setup	Marker : Frequency : Amplitude	Test Results
Detector = MAX PEAK Sweep Count = 0 RF Atten (dB) = 20 Trace Mode = VIEW	M1 : 5736.142 MHz : -0.900 dBm M2 : 5751.293 MHz : 7.103 dBm Delta1 : 17.715 MHz : 0.498 dB T1 : 5736.142 MHz : -0.900 dBm T2 : 5753.938 MHz : -2.171 dBm OBW : 17.796 MHz	Measured 6 dB Bandwidth : 17.715 MHz Limit: ≥ 500.0 kHz Margin: -17.22 MHz

[Back to the Matrix](#)

This test report may be reproduced in full only. The document may only be updated by MiCOM Labs personnel. Any changes will be noted in the Document History section of the report.



Title: Xirrus Inc. XI-AC1300, XI-AC867
To: FCC 47 CFR Part 15.247 & IC RSS-210
Serial #: XIRR04-U3 Rev A
Issue Date: 29th April 2014
Page: 191 of 572



6 dB & 99% BANDWIDTH

Variant: 802.11n HT-20, Channel: 5745.00 MHz, Chain b, Temp: Ambient, Voltage: 56 Vdc

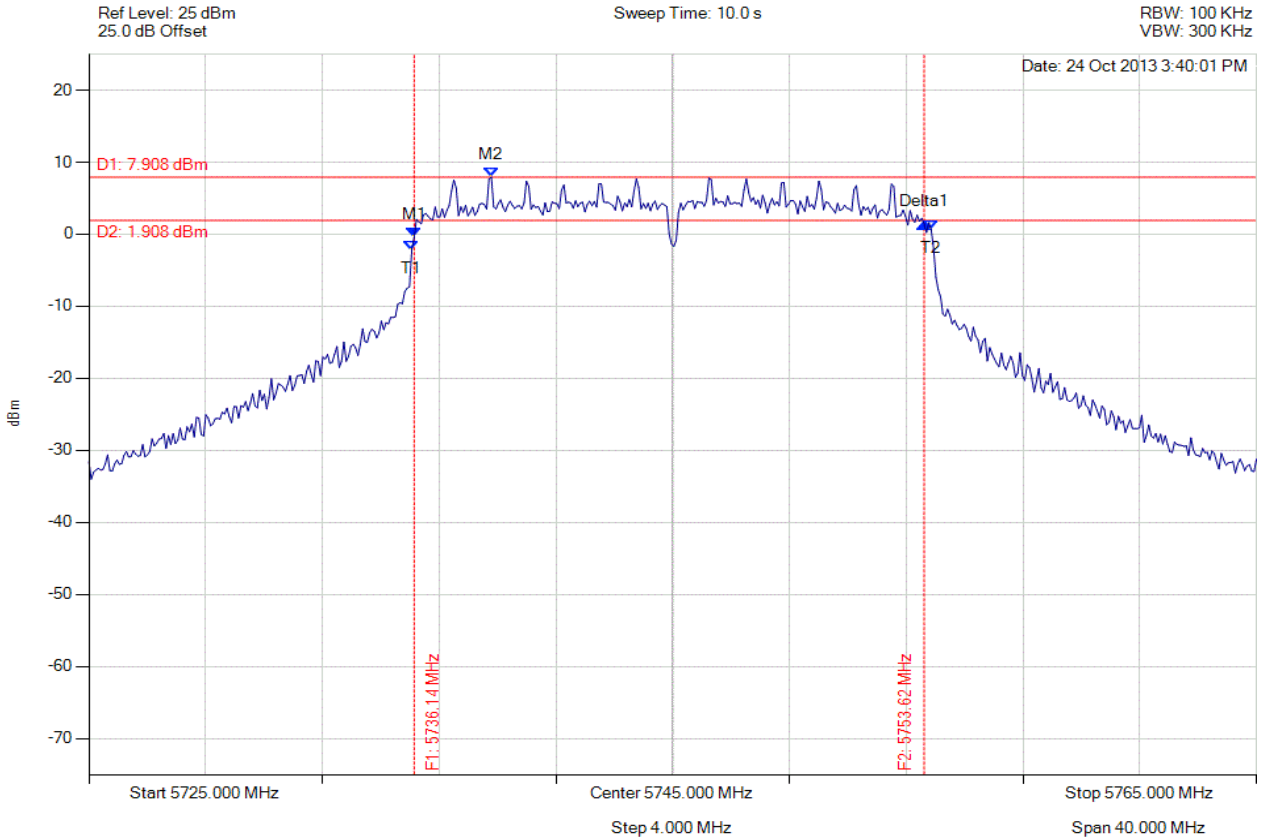

Analyser Setup	Marker : Frequency : Amplitude	Test Results
Detector = MAX PEAK Sweep Count = 0 RF Atten (dB) = 20 Trace Mode = VIEW	M1 : 5736.142 MHz : -0.424 dBm M2 : 5738.788 MHz : 7.908 dBm Delta1 : 17.475 MHz : 1.855 dB T1 : 5736.062 MHz : -2.183 dBm T2 : 5753.858 MHz : 0.650 dBm OBW : 17.796 MHz	Measured 6 dB Bandwidth : 17.475 MHz Limit : ≥ 500.0 kHz Margin : -16.98 MHz

[Back to the Matrix](#)

This test report may be reproduced in full only. The document may only be updated by MiCOM Labs personnel. Any changes will be noted in the Document History section of the report.



6 dB & 99% BANDWIDTH

Variant: 802.11n HT-20, Channel: 5745.00 MHz, Chain c, Temp: Ambient, Voltage: 56 Vdc

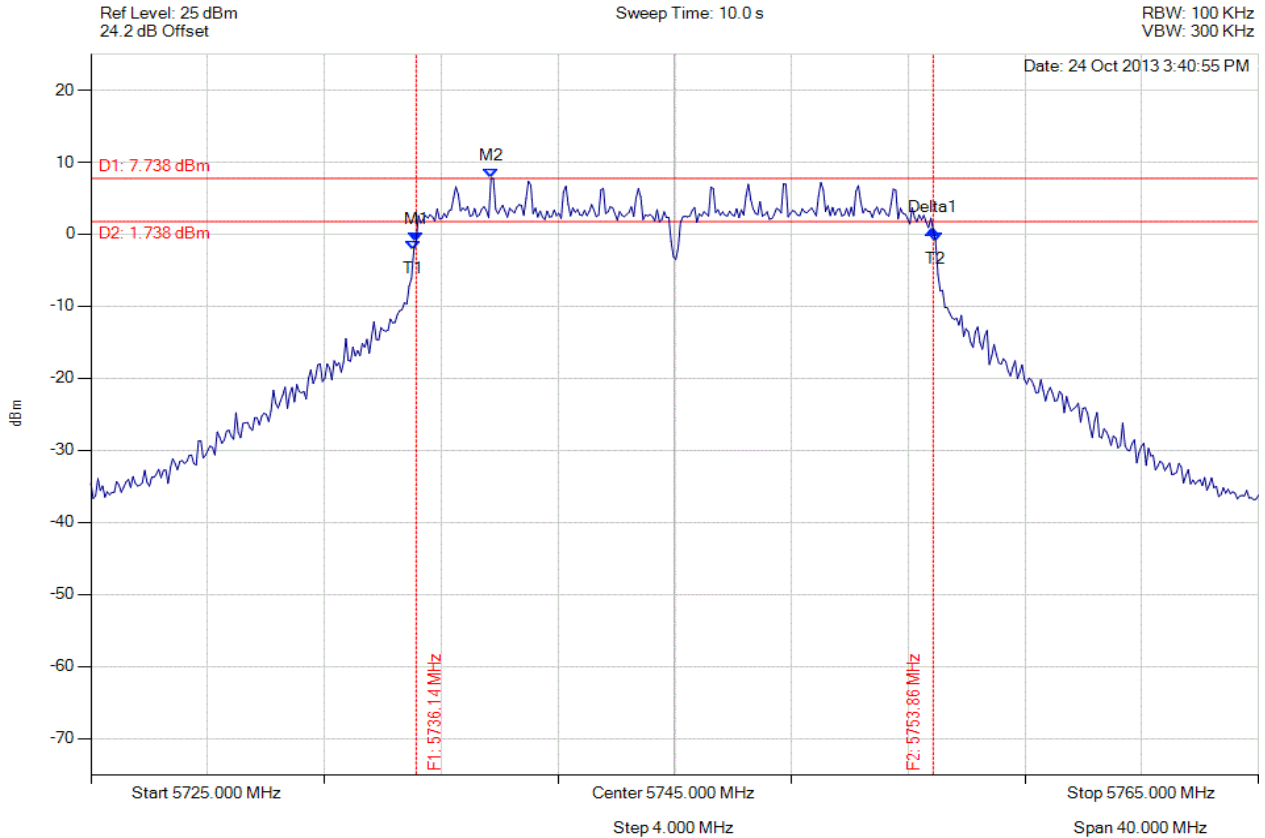

Analyser Setup	Marker : Frequency : Amplitude	Test Results
Detector = MAX PEAK Sweep Count = 0 RF Atten (dB) = 20 Trace Mode = VIEW	M1 : 5736.142 MHz : -0.971 dBm M2 : 5738.707 MHz : 7.738 dBm Delta1 : 17.715 MHz : 1.548 dB T1 : 5736.062 MHz : -2.248 dBm T2 : 5753.938 MHz : -0.999 dBm OBW : 17.876 MHz	Measured 6 dB Bandwidth : 17.715 MHz Limit: ≥ 500.0 kHz Margin: -17.22 MHz

[Back to the Matrix](#)

This test report may be reproduced in full only. The document may only be updated by MiCOM Labs personnel. Any changes will be noted in the Document History section of the report.



Title: Xirrus Inc. XI-AC1300, XI-AC867
To: FCC 47 CFR Part 15.247 & IC RSS-210
Serial #: XIRR04-U3 Rev A
Issue Date: 29th April 2014
Page: 193 of 572



6 dB & 99% BANDWIDTH

Variant: 802.11n HT-20, Channel: 5785.00 MHz, Chain a, Temp: Ambient, Voltage: 56 Vdc

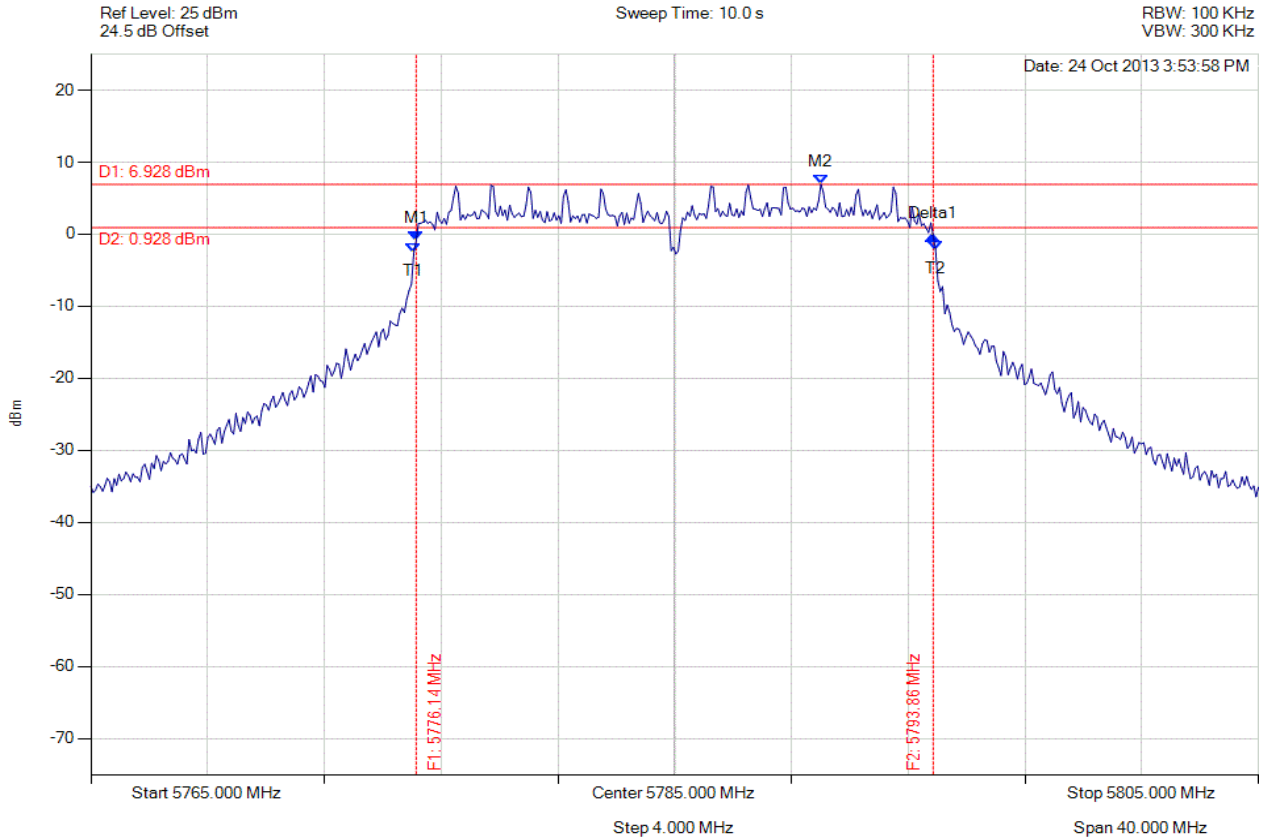

Analyser Setup	Marker : Frequency : Amplitude	Test Results
Detector = MAX PEAK Sweep Count = 0 RF Atten (dB) = 20 Trace Mode = VIEW	M1 : 5776.142 MHz : -0.920 dBm M2 : 5790.010 MHz : 6.928 dBm Delta1 : 17.715 MHz : 0.689 dB T1 : 5776.062 MHz : -2.604 dBm T2 : 5793.938 MHz : -2.183 dBm OBW : 17.876 MHz	Measured 6 dB Bandwidth : 17.715 MHz Limit : ≥ 500.0 kHz Margin : -17.22 MHz

[Back to the Matrix](#)

This test report may be reproduced in full only. The document may only be updated by MiCOM Labs personnel. Any changes will be noted in the Document History section of the report.



6 dB & 99% BANDWIDTH

Variant: 802.11n HT-20, Channel: 5785.00 MHz, Chain b, Temp: Ambient, Voltage: 56 Vdc

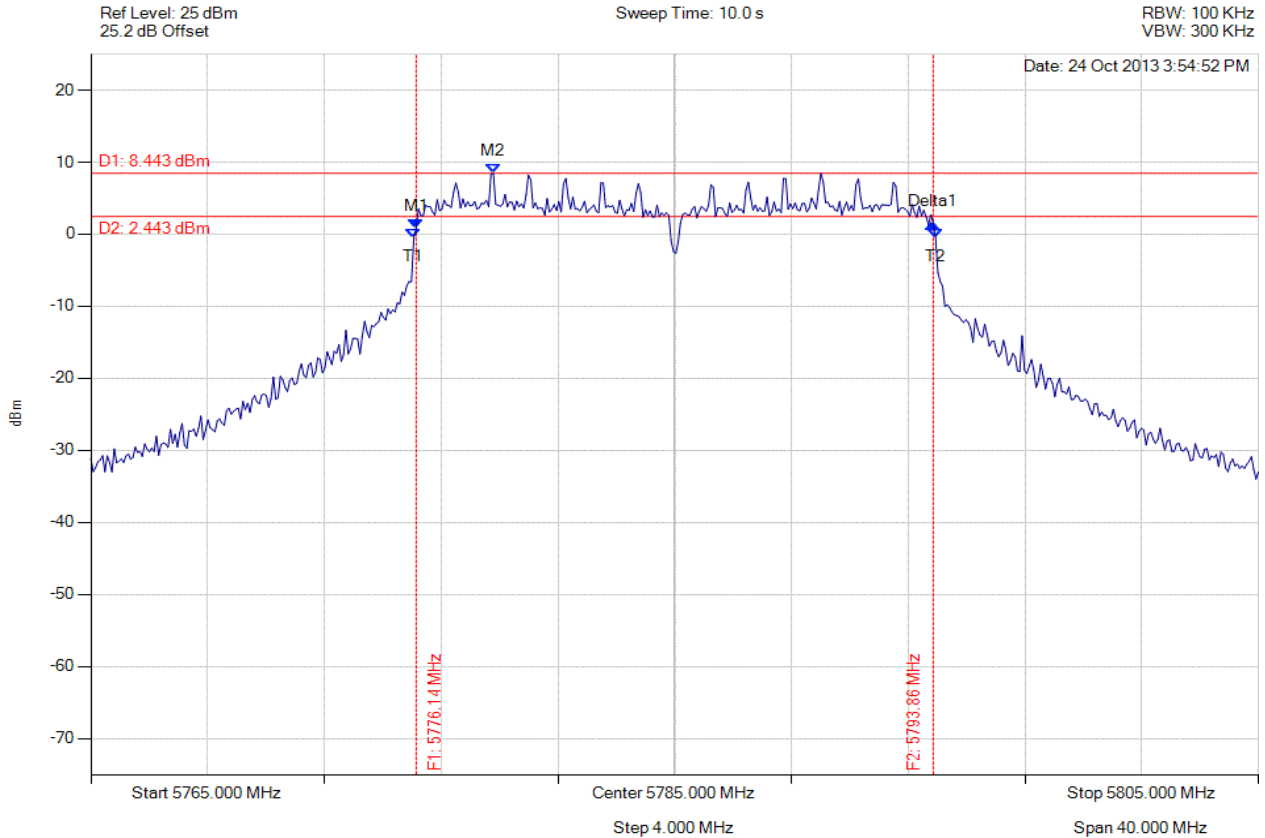

Analyser Setup	Marker : Frequency : Amplitude	Test Results
Detector = MAX PEAK Sweep Count = 0 RF Atten (dB) = 20 Trace Mode = VIEW	M1 : 5776.142 MHz : 0.874 dBm M2 : 5778.788 MHz : 8.443 dBm Delta1 : 17.715 MHz : 0.645 dB T1 : 5776.062 MHz : -0.609 dBm T2 : 5793.938 MHz : -0.558 dBm OBW : 17.876 MHz	Measured 6 dB Bandwidth: 17.715 MHz Limit: ≥ 500.0 kHz Margin: -17.22 MHz

[Back to the Matrix](#)

This test report may be reproduced in full only. The document may only be updated by MiCOM Labs personnel. Any changes will be noted in the Document History section of the report.



Title: Xirrus Inc. XI-AC1300, XI-AC867
To: FCC 47 CFR Part 15.247 & IC RSS-210
Serial #: XIRR04-U3 Rev A
Issue Date: 29th April 2014
Page: 195 of 572



6 dB & 99% BANDWIDTH

Variant: 802.11n HT-20, Channel: 5785.00 MHz, Chain c, Temp: Ambient, Voltage: 56 Vdc

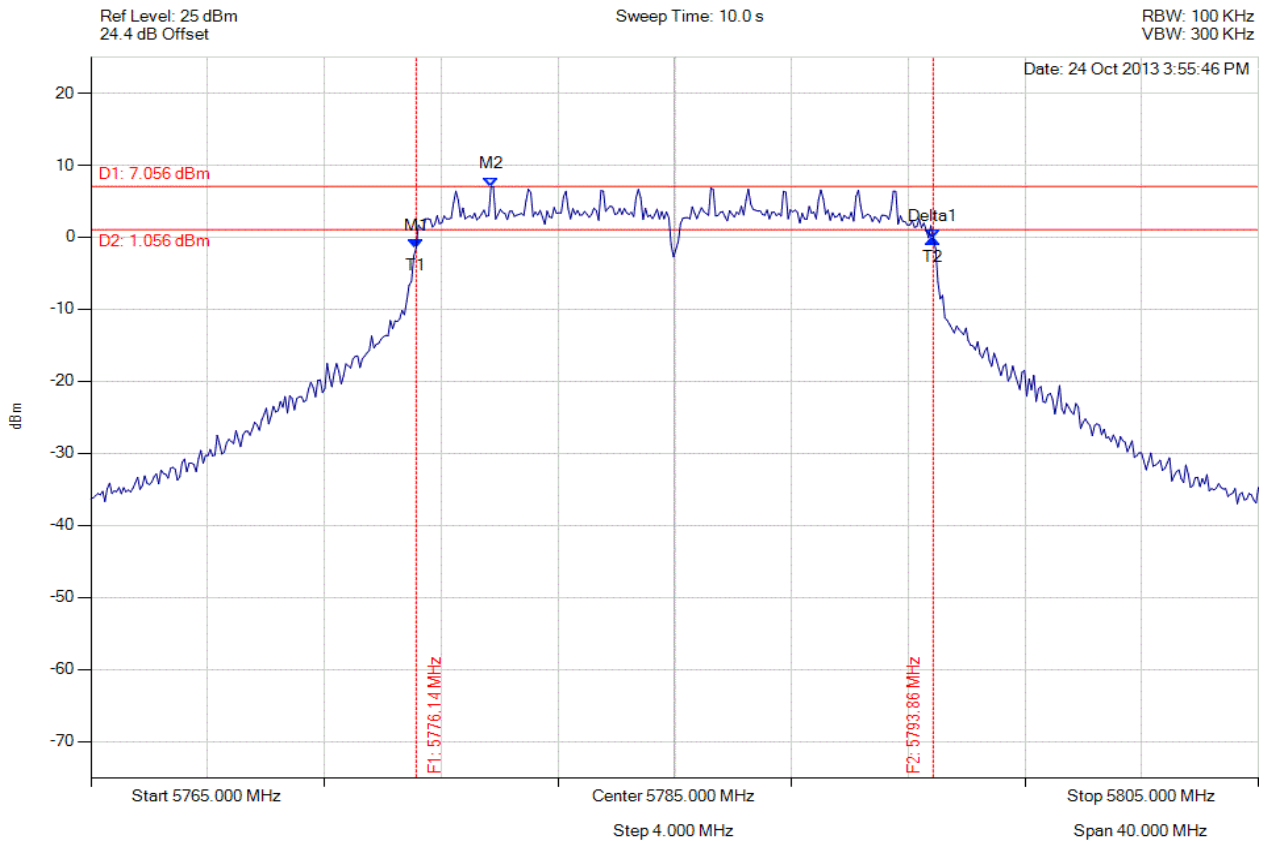

Analyser Setup	Marker : Frequency : Amplitude	Test Results
Detector = MAX PEAK Sweep Count = 0 RF Atten (dB) = 20 Trace Mode = VIEW	M1 : 5776.142 MHz : -1.483 dBm M2 : 5778.707 MHz : 7.056 dBm Delta1 : 17.715 MHz : 1.245 dB T1 : 5776.142 MHz : -1.483 dBm T2 : 5793.858 MHz : -0.239 dBm OBW : 17.715 MHz	Measured 6 dB Bandwidth : 17.715 MHz Limit : ≥ 500.0 kHz Margin : -17.22 MHz

[Back to the Matrix](#)

This test report may be reproduced in full only. The document may only be updated by MiCOM Labs personnel. Any changes will be noted in the Document History section of the report.



Title: Xirrus Inc. XI-AC1300, XI-AC867
To: FCC 47 CFR Part 15.247 & IC RSS-210
Serial #: XIRR04-U3 Rev A
Issue Date: 29th April 2014
Page: 196 of 572



6 dB & 99% BANDWIDTH

Variant: 802.11n HT-20, Channel: 5825.00 MHz, Chain a, Temp: Ambient, Voltage: 56 Vdc

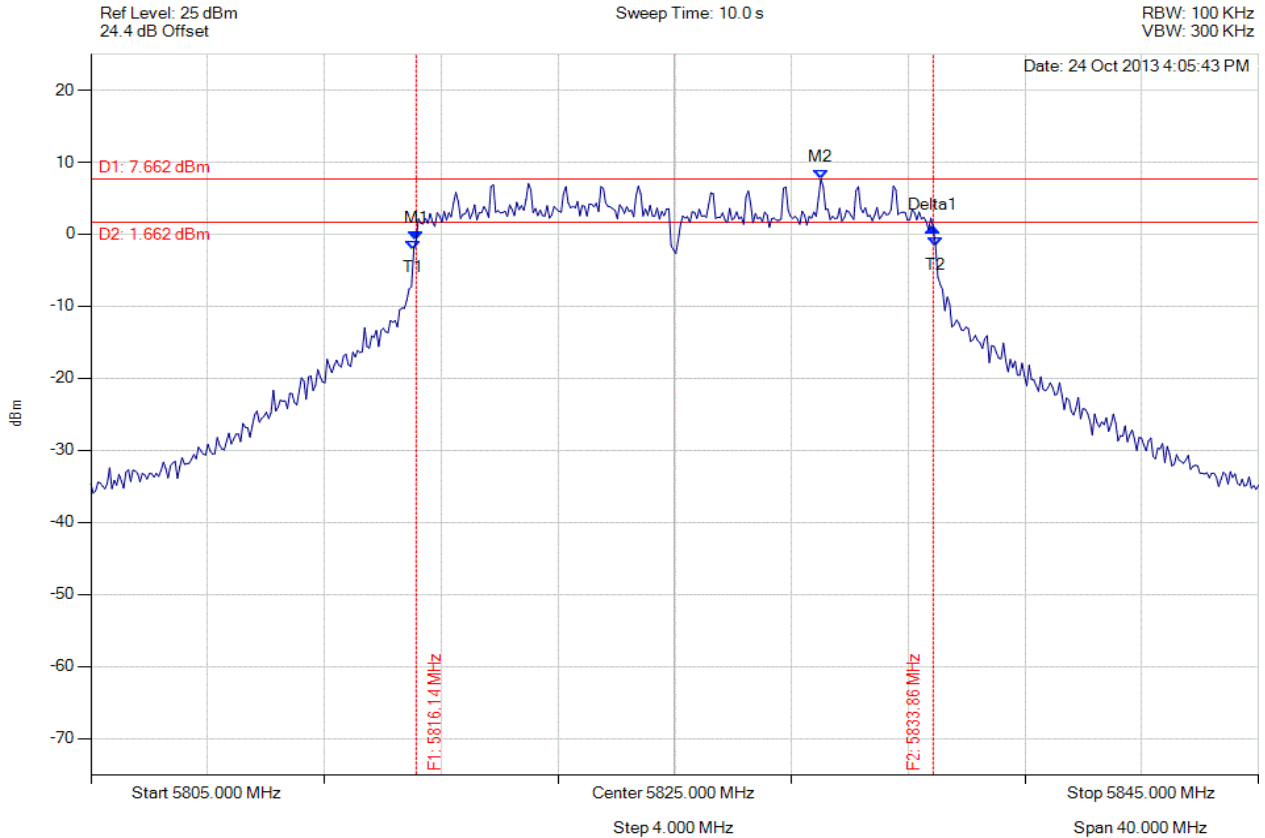

Analyser Setup	Marker : Frequency : Amplitude	Test Results
Detector = MAX PEAK Sweep Count = 0 RF Atten (dB) = 20 Trace Mode = VIEW	M1 : 5816.142 MHz : -0.851 dBm M2 : 5830.010 MHz : 7.662 dBm Delta1 : 17.715 MHz : 1.853 dB T1 : 5816.062 MHz : -2.134 dBm T2 : 5833.938 MHz : -1.703 dBm OBW : 17.876 MHz	Measured 6 dB Bandwidth : 17.715 MHz Limit: ≥ 500.0 kHz Margin: -17.22 MHz

[Back to the Matrix](#)

This test report may be reproduced in full only. The document may only be updated by MiCOM Labs personnel. Any changes will be noted in the Document History section of the report.



6 dB & 99% BANDWIDTH

Variant: 802.11n HT-20, Channel: 5825.00 MHz, Chain b, Temp: Ambient, Voltage: 56 Vdc

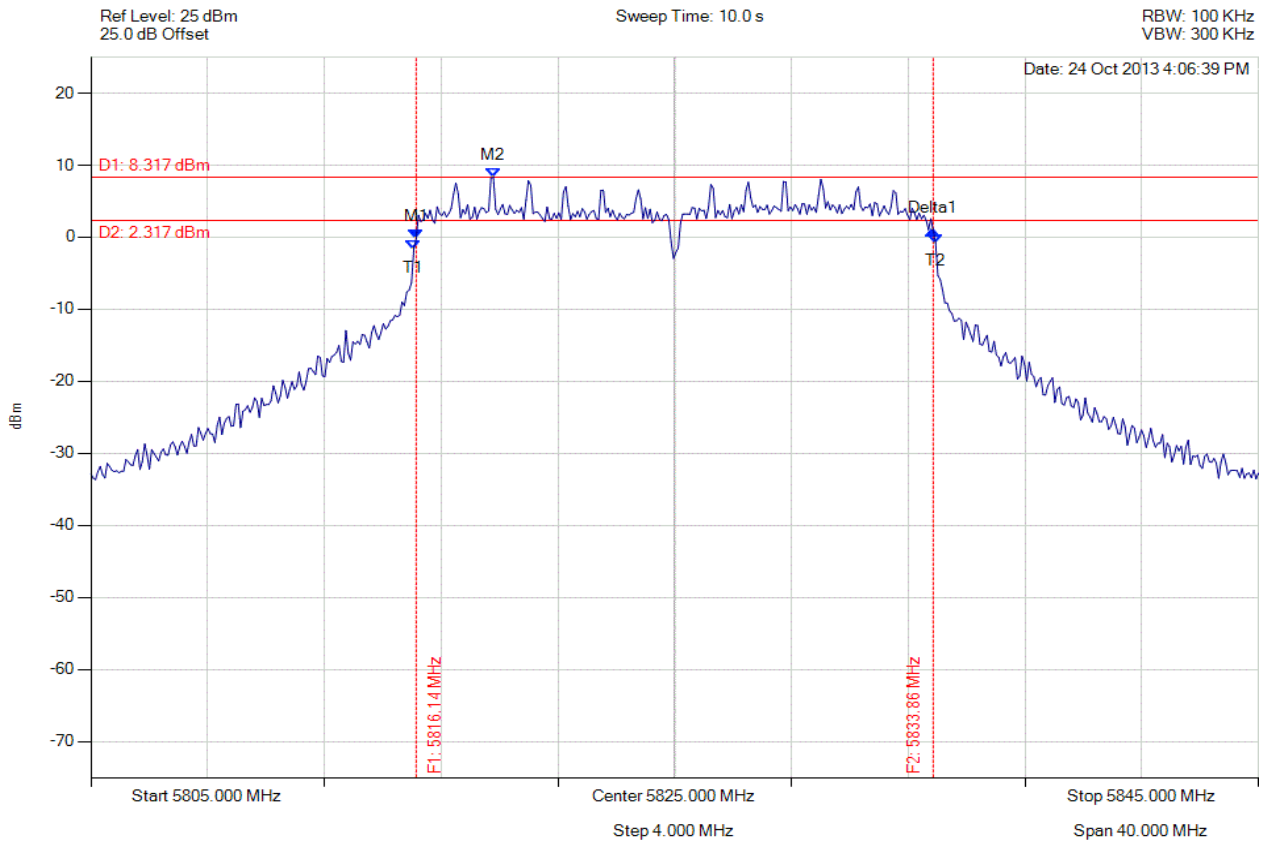

Analyser Setup	Marker : Frequency : Amplitude	Test Results
Detector = MAX PEAK Sweep Count = 0 RF Atten (dB) = 20 Trace Mode = VIEW	M1 : 5816.142 MHz : -0.231 dBm M2 : 5818.788 MHz : 8.317 dBm Delta1 : 17.715 MHz : 1.173 dB T1 : 5816.062 MHz : -1.736 dBm T2 : 5833.938 MHz : -0.784 dBm OBW : 17.876 MHz	Measured 6 dB Bandwidth: 17.715 MHz Limit: ≥ 500.0 kHz Margin: -17.22 MHz

[Back to the Matrix](#)

This test report may be reproduced in full only. The document may only be updated by MiCOM Labs personnel. Any changes will be noted in the Document History section of the report.



6 dB & 99% BANDWIDTH

Variant: 802.11n HT-20, Channel: 5825.00 MHz, Chain c, Temp: Ambient, Voltage: 56 Vdc

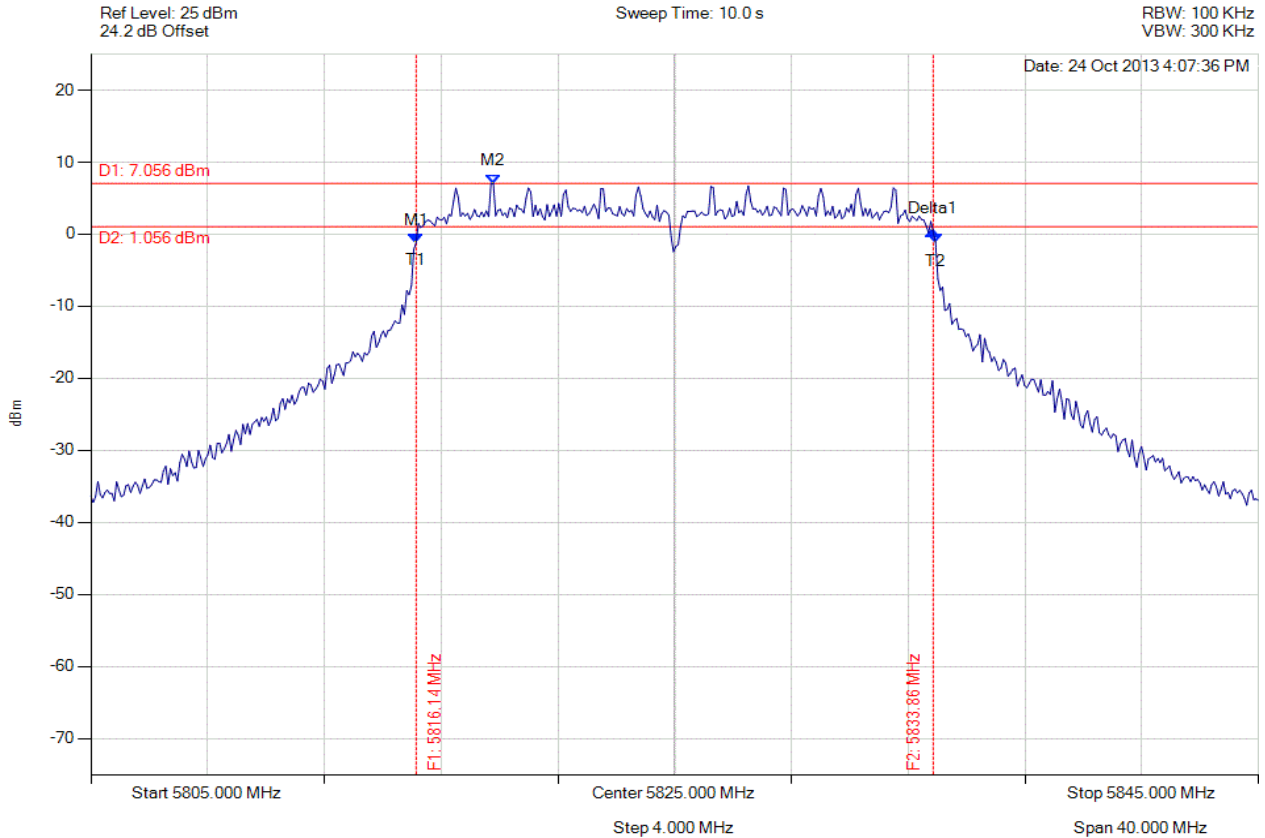

Analyser Setup	Marker : Frequency : Amplitude	Test Results
Detector = MAX PEAK Sweep Count = 0 RF Atten (dB) = 20 Trace Mode = VIEW	M1 : 5816.142 MHz : -1.166 dBm M2 : 5818.788 MHz : 7.056 dBm Delta1 : 17.715 MHz : 1.572 dB T1 : 5816.142 MHz : -1.166 dBm T2 : 5833.938 MHz : -1.201 dBm OBW : 17.796 MHz	Measured 6 dB Bandwidth : 17.715 MHz Limit : ≥ 500.0 kHz Margin : -17.22 MHz

[Back to the Matrix](#)

This test report may be reproduced in full only. The document may only be updated by MiCOM Labs personnel. Any changes will be noted in the Document History section of the report.



6 dB & 99% BANDWIDTH

Variant: 802.11n HT-40, Channel: 5755.00 MHz, Chain a, Temp: Ambient, Voltage: 56 Vdc

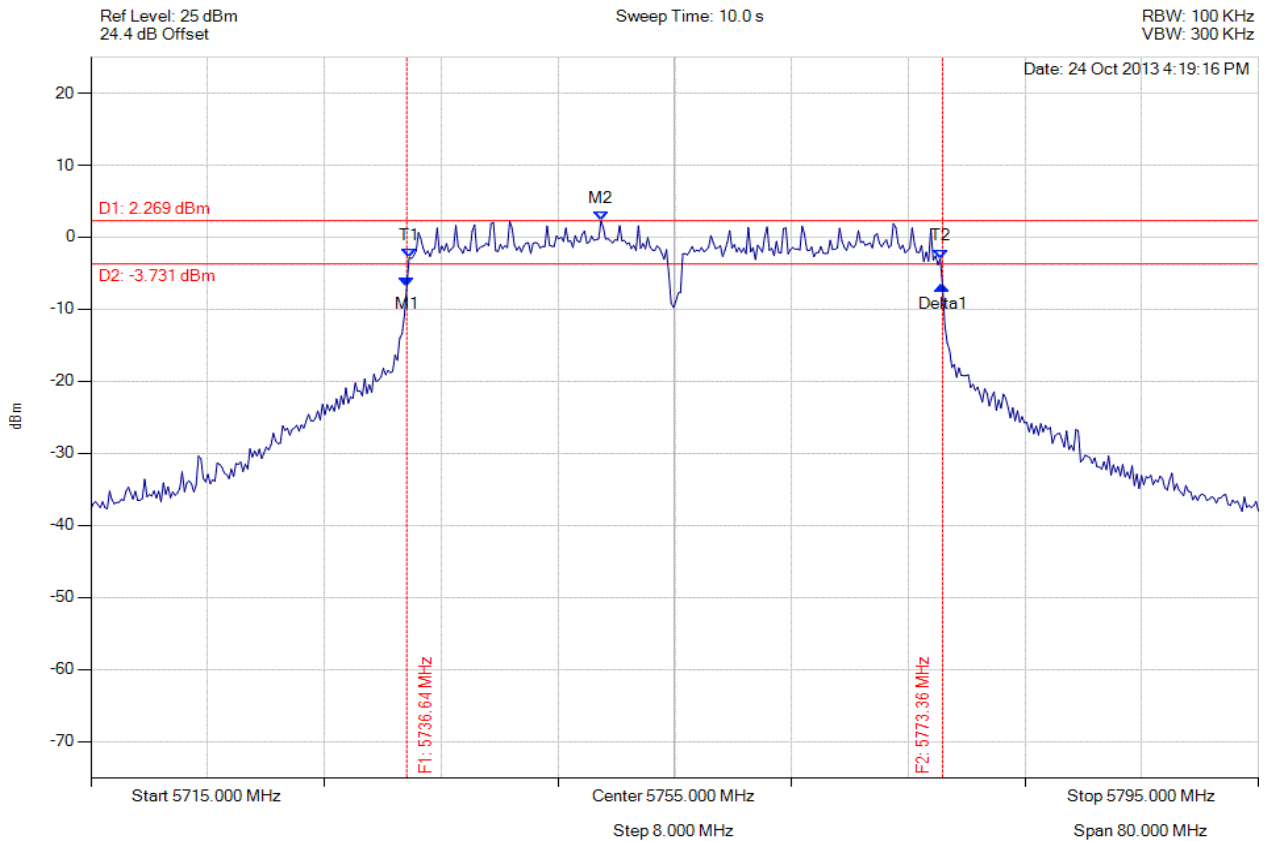

Analyser Setup	Marker : Frequency : Amplitude	Test Results
Detector = MAX PEAK Sweep Count = 0 RF Atten (dB) = 20 Trace Mode = VIEW	M1 : 5736.643 MHz : -6.834 dBm M2 : 5749.950 MHz : 2.269 dBm Delta1 : 36.713 MHz : 0.087 dB T1 : 5736.804 MHz : -2.864 dBm T2 : 5773.196 MHz : -2.960 dBm OBW : 36.393 MHz	Measured 6 dB Bandwidth: 36.713 MHz Limit: ≥ 500.0 kHz Margin: -36.21 MHz

[Back to the Matrix](#)

This test report may be reproduced in full only. The document may only be updated by MiCOM Labs personnel. Any changes will be noted in the Document History section of the report.



6 dB & 99% BANDWIDTH

Variant: 802.11n HT-40, Channel: 5755.00 MHz, Chain b, Temp: Ambient, Voltage: 56 Vdc

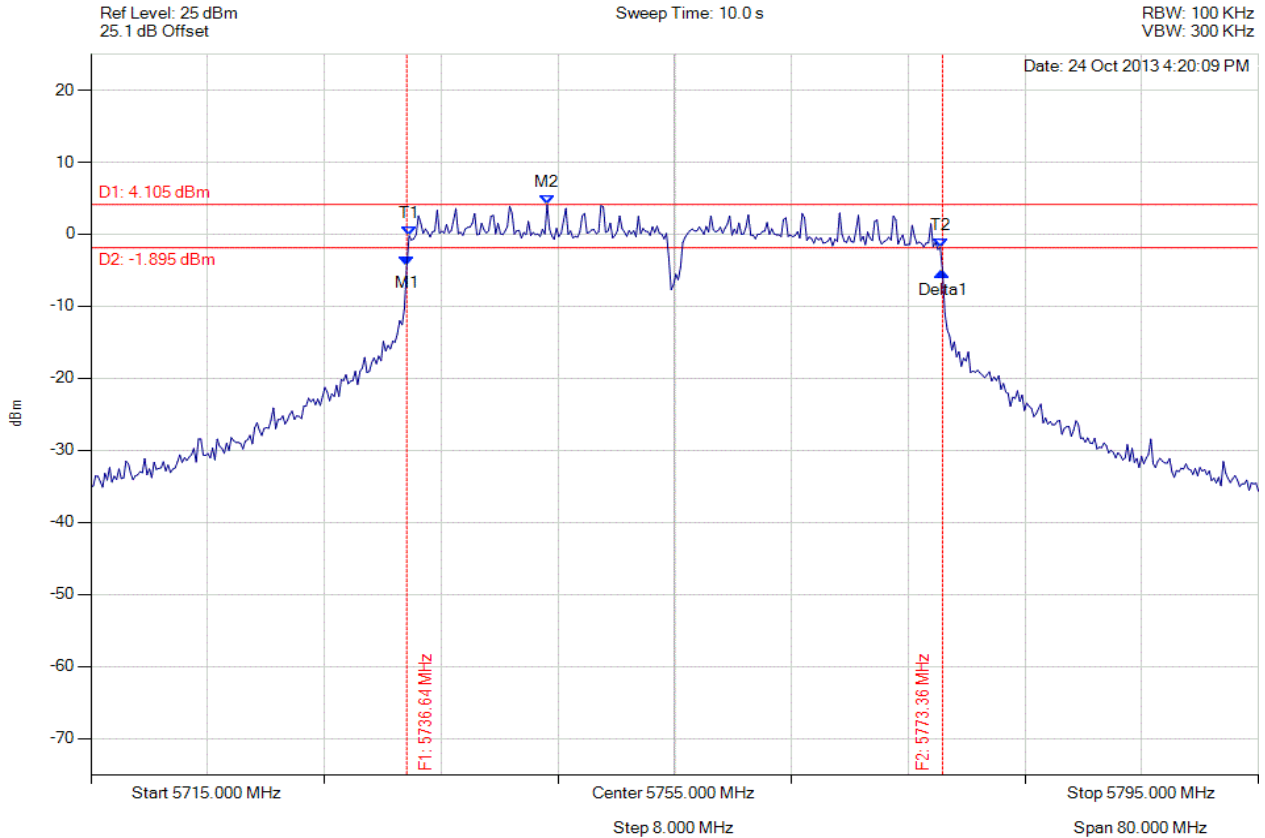

Analyser Setup	Marker : Frequency : Amplitude	Test Results
Detector = MAX PEAK Sweep Count = 0 RF Atten (dB) = 20 Trace Mode = VIEW	M1 : 5736.643 MHz : -4.314 dBm M2 : 5746.263 MHz : 4.105 dBm Delta1 : 36.713 MHz : -0.868 dB T1 : 5736.804 MHz : -0.212 dBm T2 : 5773.196 MHz : -1.852 dBm OBW : 36.393 MHz	Measured 6 dB Bandwidth: 36.713 MHz Limit: ≥ 500.0 kHz Margin: -36.21 MHz

[Back to the Matrix](#)

This test report may be reproduced in full only. The document may only be updated by MiCOM Labs personnel. Any changes will be noted in the Document History section of the report.



6 dB & 99% BANDWIDTH

Variant: 802.11n HT-40, Channel: 5755.00 MHz, Chain c, Temp: Ambient, Voltage: 56 Vdc

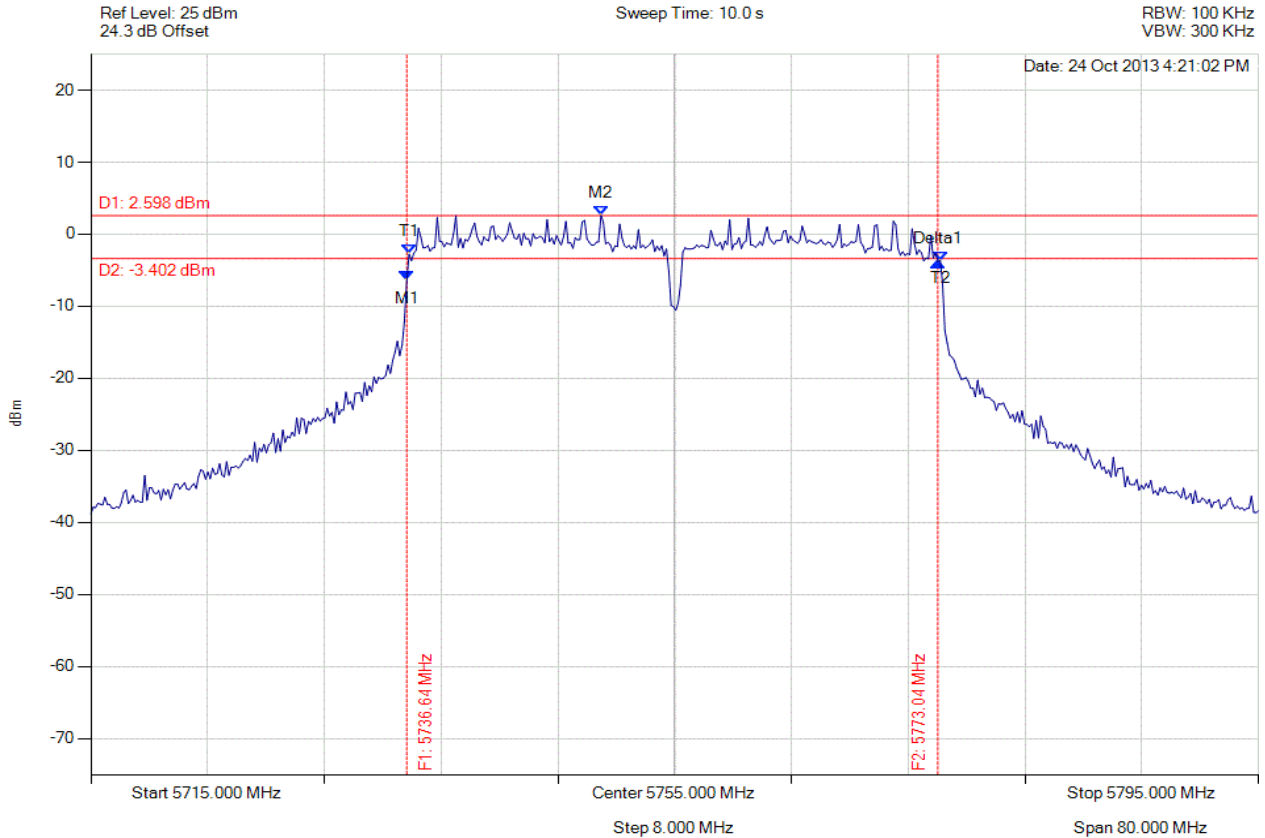

Analyser Setup	Marker : Frequency : Amplitude	Test Results
Detector = MAX PEAK Sweep Count = 0 RF Atten (dB) = 20 Trace Mode = VIEW	M1 : 5736.643 MHz : -6.434 dBm M2 : 5749.950 MHz : 2.598 dBm Delta1 : 36.393 MHz : 2.652 dB T1 : 5736.804 MHz : -2.757 dBm T2 : 5773.196 MHz : -3.666 dBm OBW : 36.393 MHz	Measured 6 dB Bandwidth: 36.393 MHz Limit: \geq 500.0 kHz Margin: -35.89 MHz

[Back to the Matrix](#)

This test report may be reproduced in full only. The document may only be updated by MiCOM Labs personnel. Any changes will be noted in the Document History section of the report.



6 dB & 99% BANDWIDTH

Variante: 802.11n HT-40, Channel: 5795.00 MHz, Chain a, Temp: Ambient, Voltage: 56 Vdc

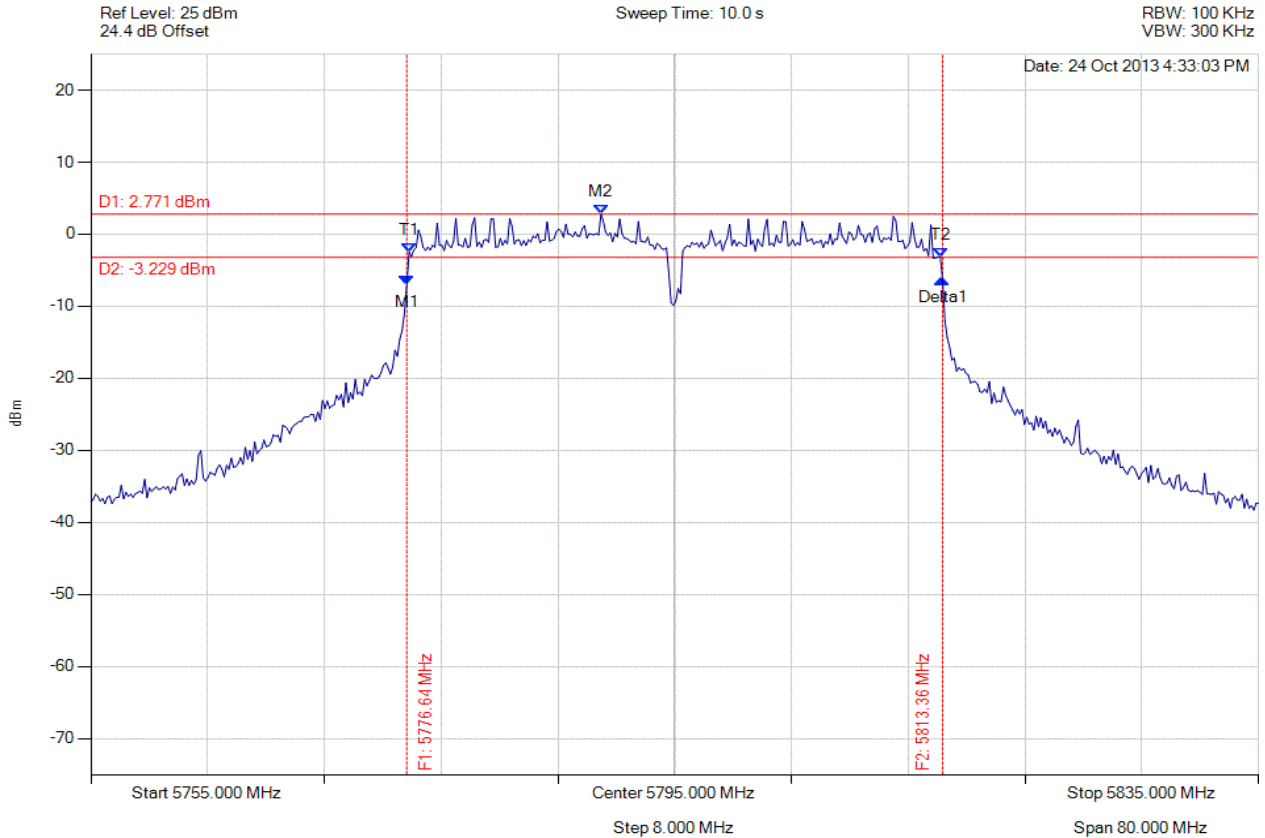

Analyser Setup	Marker : Frequency : Amplitude	Test Results
Detector = MAX PEAK Sweep Count = 0 RF Atten (dB) = 20 Trace Mode = VIEW	M1 : 5776.643 MHz : -6.970 dBm M2 : 5789.950 MHz : 2.771 dBm Delta1 : 36.713 MHz : 0.724 dB T1 : 5776.804 MHz : -2.496 dBm T2 : 5813.196 MHz : -3.163 dBm OBW : 36.393 MHz	Measured 6 dB Bandwidth: 36.713 MHz Limit: ≥ 500.0 kHz Margin: -36.21 MHz

[Back to the Matrix](#)

This test report may be reproduced in full only. The document may only be updated by MiCOM Labs personnel. Any changes will be noted in the Document History section of the report.



6 dB & 99% BANDWIDTH

Variant: 802.11n HT-40, Channel: 5795.00 MHz, Chain b, Temp: Ambient, Voltage: 56 Vdc

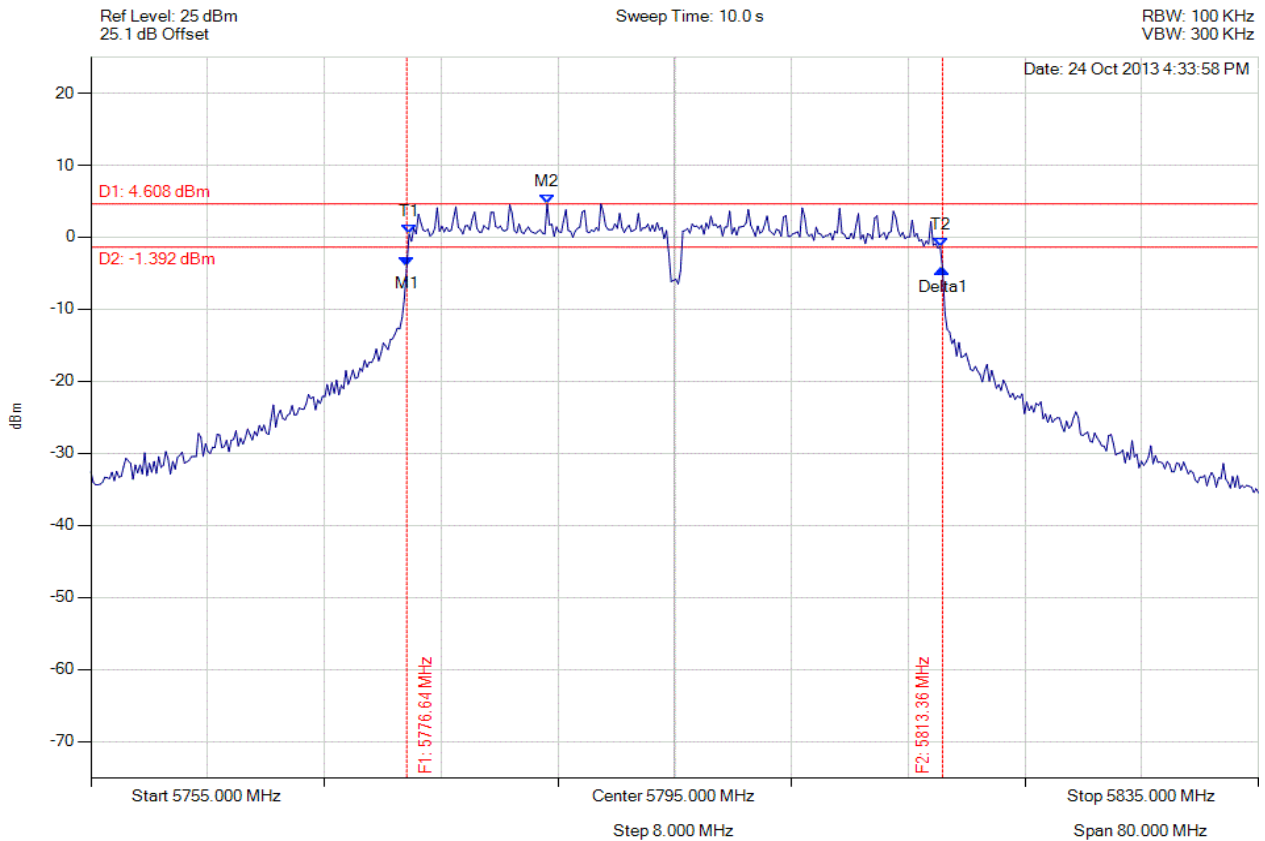

Analyser Setup	Marker : Frequency : Amplitude	Test Results
Detector = MAX PEAK Sweep Count = 0 RF Atten (dB) = 20 Trace Mode = VIEW	M1 : 5776.643 MHz : -3.967 dBm M2 : 5786.263 MHz : 4.608 dBm Delta1 : 36.713 MHz : -0.395 dB T1 : 5776.804 MHz : 0.459 dBm T2 : 5813.196 MHz : -1.341 dBm OBW : 36.393 MHz	Measured 6 dB Bandwidth: 36.713 MHz Limit: ≥ 500.0 kHz Margin: -36.21 MHz

[Back to the Matrix](#)

This test report may be reproduced in full only. The document may only be updated by MiCOM Labs personnel. Any changes will be noted in the Document History section of the report.



6 dB & 99% BANDWIDTH

Variant: 802.11n HT-40, Channel: 5795.00 MHz, Chain c, Temp: Ambient, Voltage: 56 Vdc

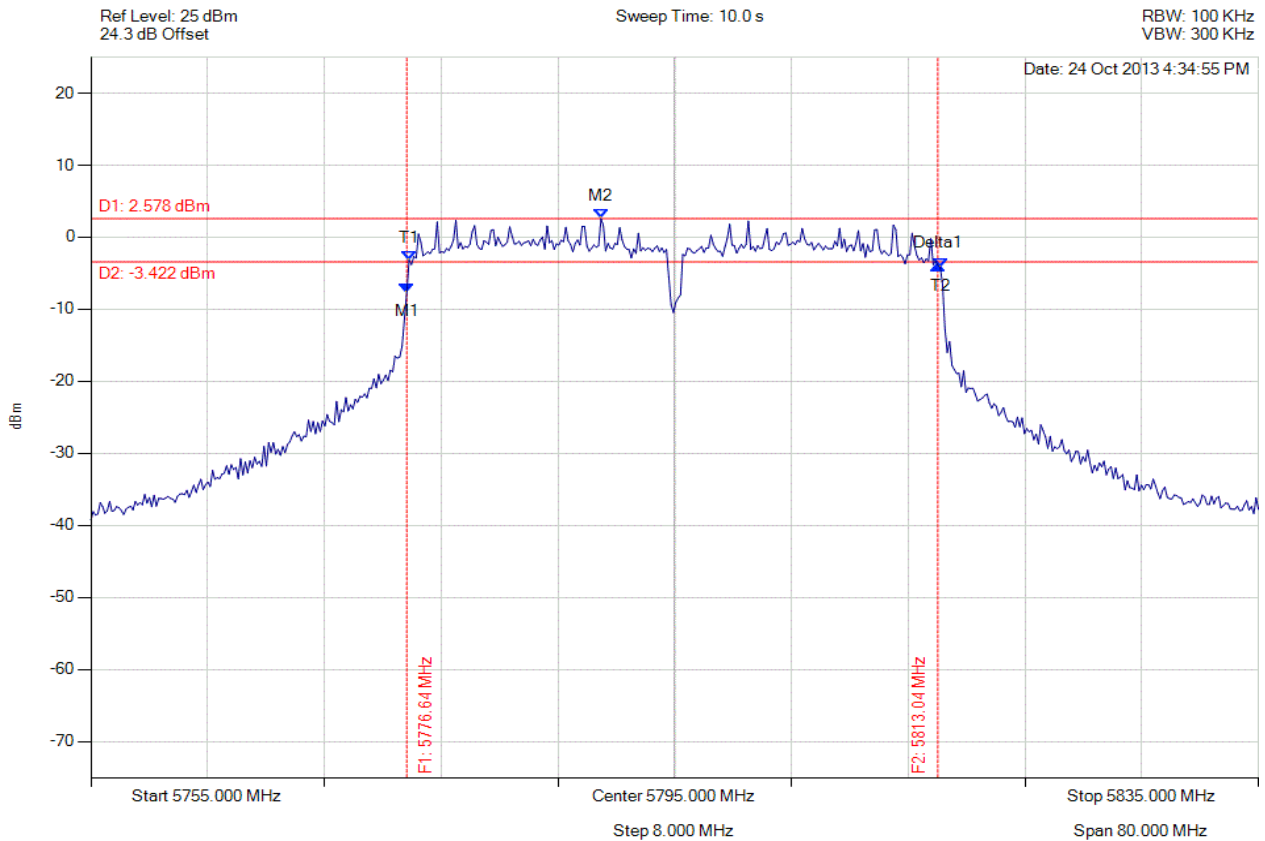

Analyser Setup	Marker : Frequency : Amplitude	Test Results
Detector = MAX PEAK Sweep Count = 0 RF Atten (dB) = 20 Trace Mode = VIEW	M1 : 5776.643 MHz : -7.701 dBm M2 : 5789.950 MHz : 2.578 dBm Delta1 : 36.393 MHz : 3.809 dB T1 : 5776.804 MHz : -3.141 dBm T2 : 5813.196 MHz : -4.176 dBm OBW : 36.393 MHz	Measured 6 dB Bandwidth: 36.393 MHz Limit: ≥500.0 kHz Margin: -35.89 MHz

[Back to the Matrix](#)

This test report may be reproduced in full only. The document may only be updated by MiCOM Labs personnel. Any changes will be noted in the Document History section of the report.



A.1.2. Power Spectral Density



POWER SPECTRAL DENSITY - AVERAGE

Variant: 802.11b, Channel: 2412.00 MHz, Chain a, Temp: Ambient, Voltage: 56 Vdc

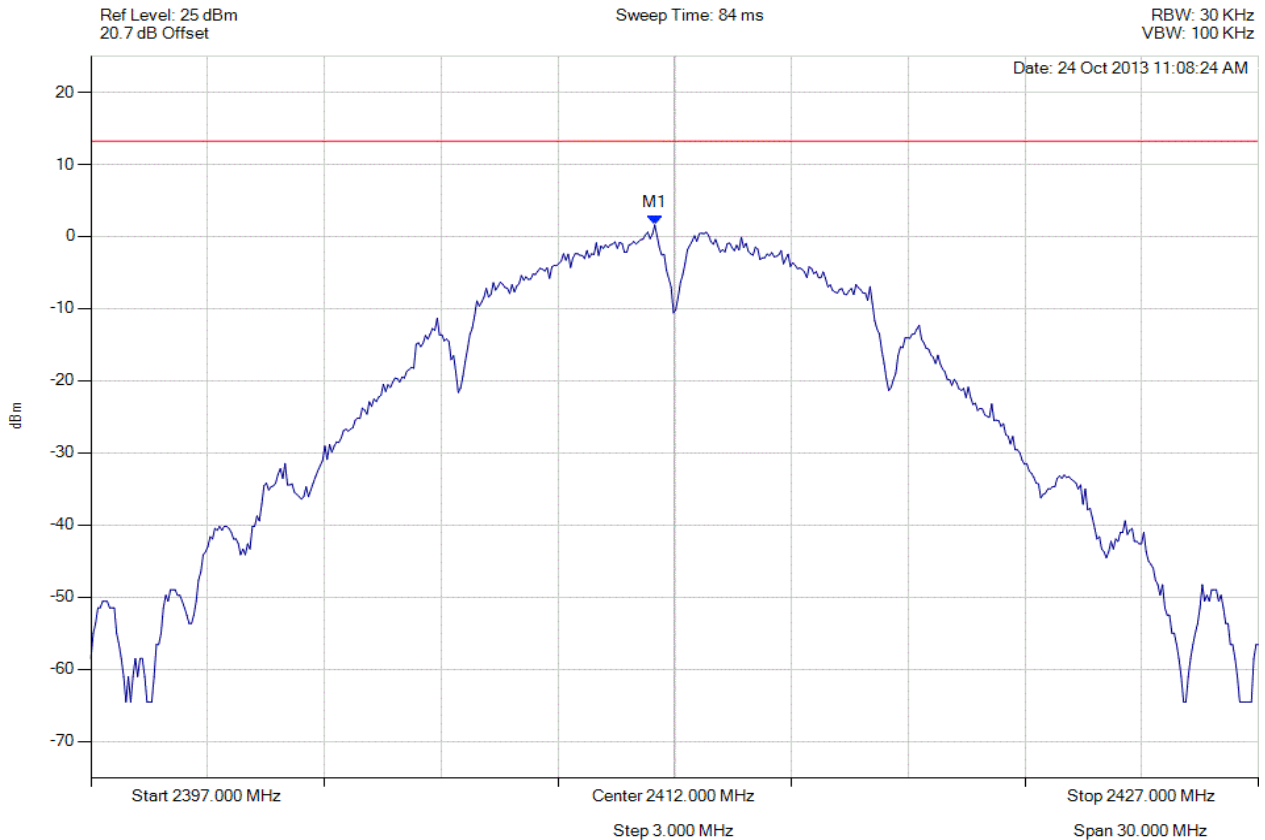

Analyser Setup	Marker : Frequency : Amplitude	Test Results
Detector = AVERAGE Sweep Count = 0 RF Atten (dB) = 20 Trace Mode = VIEW	M1 : 2411.489 MHz : 1.607 dBm	Limit: ≤ 13.229 dBm Margin: -11.62 dB

[Back to the Matrix](#)

This test report may be reproduced in full only. The document may only be updated by MiCOM Labs personnel. Any changes will be noted in the Document History section of the report.



Title: Xirrus Inc. XI-AC1300, XI-AC867
To: FCC 47 CFR Part 15.247 & IC RSS-210
Serial #: XIRR04-U3 Rev A
Issue Date: 29th April 2014
Page: 206 of 572



POWER SPECTRAL DENSITY - AVERAGE

Variant: 802.11b, Channel: 2412.00 MHz, Chain b, Temp: Ambient, Voltage: 56 Vdc

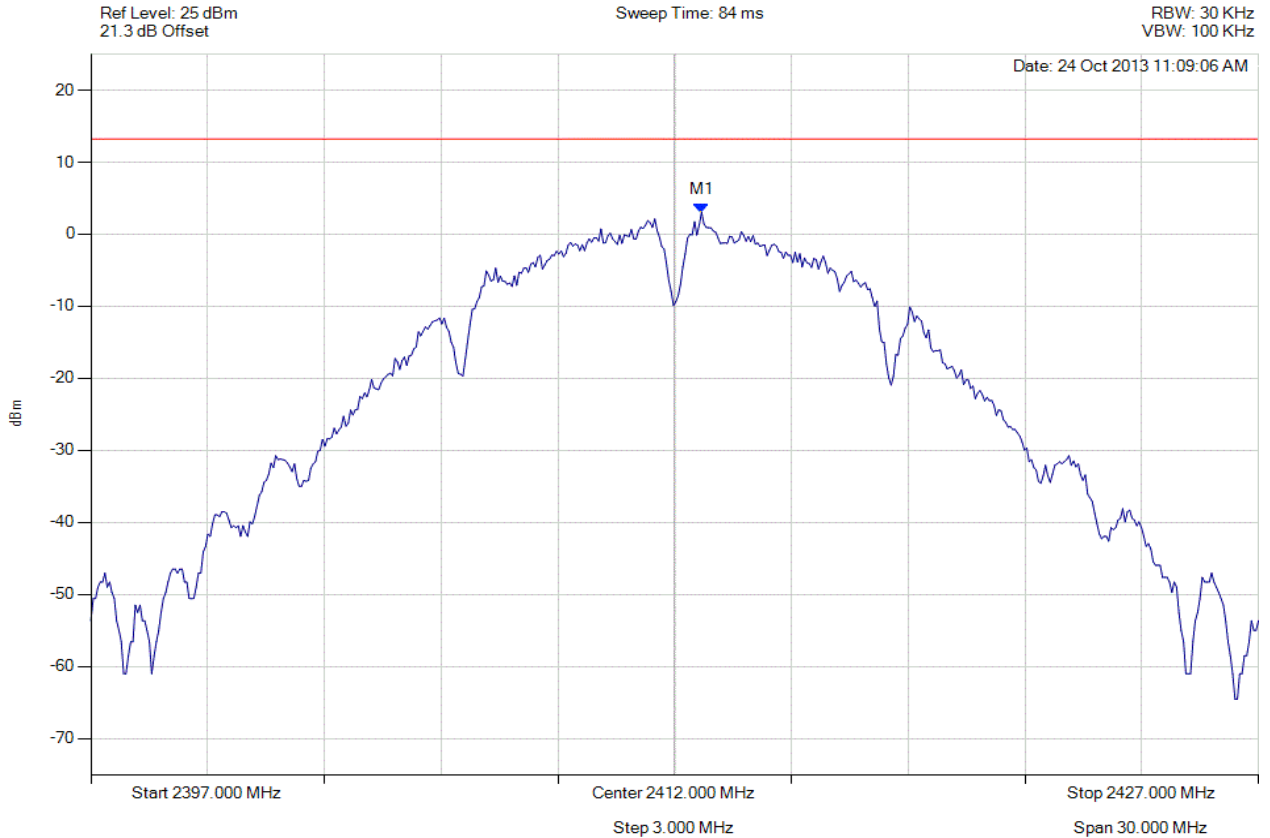

Analyser Setup	Marker : Frequency : Amplitude	Test Results
Detector = AVERAGE Sweep Count = 0 RF Atten (dB) = 20 Trace Mode = VIEW	M1 : 2412.691 MHz : 3.049 dBm	Limit: ≤ 13.229 dBm Margin: -10.18 dB

[Back to the Matrix](#)

This test report may be reproduced in full only. The document may only be updated by MiCOM Labs personnel. Any changes will be noted in the Document History section of the report.



Title: Xirrus Inc. XI-AC1300, XI-AC867
To: FCC 47 CFR Part 15.247 & IC RSS-210
Serial #: XIRR04-U3 Rev A
Issue Date: 29th April 2014
Page: 207 of 572



POWER SPECTRAL DENSITY - AVERAGE

Variant: 802.11b, Channel: 2412.00 MHz, Chain c, Temp: Ambient, Voltage: 56 Vdc

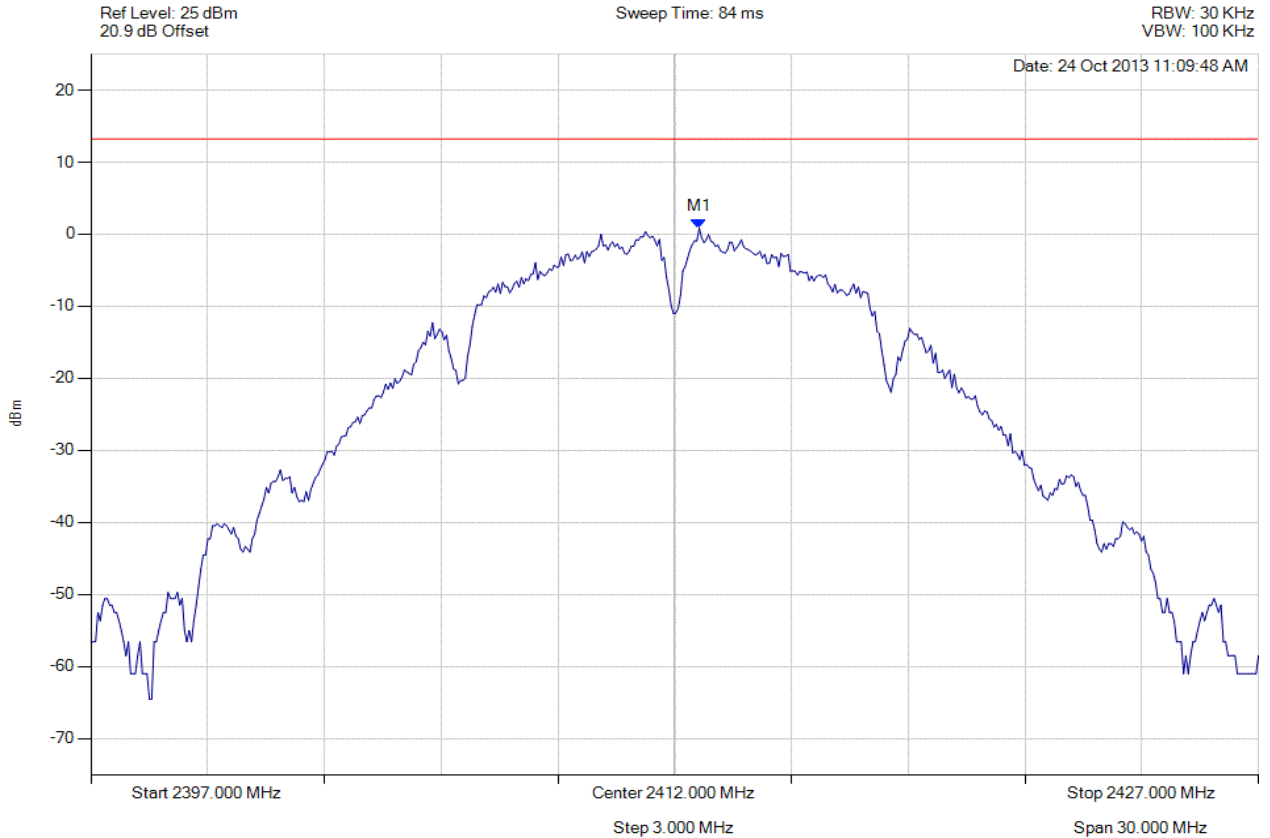

Analyser Setup	Marker : Frequency : Amplitude	Test Results
Detector = AVERAGE Sweep Count = 0 RF Atten (dB) = 20 Trace Mode = VIEW	M1 : 2412.631 MHz : 0.820 dBm	Limit: ≤ 13.229 dBm Margin: -12.41 dB

[Back to the Matrix](#)

This test report may be reproduced in full only. The document may only be updated by MiCOM Labs personnel. Any changes will be noted in the Document History section of the report.



Title: Xirrus Inc. XI-AC1300, XI-AC867
To: FCC 47 CFR Part 15.247 & IC RSS-210
Serial #: XIRR04-U3 Rev A
Issue Date: 29th April 2014
Page: 208 of 572



POWER SPECTRAL DENSITY - AVERAGE

Variant: 802.11b, Channel: 2437.00 MHz, Chain a, Temp: Ambient, Voltage: 56 Vdc

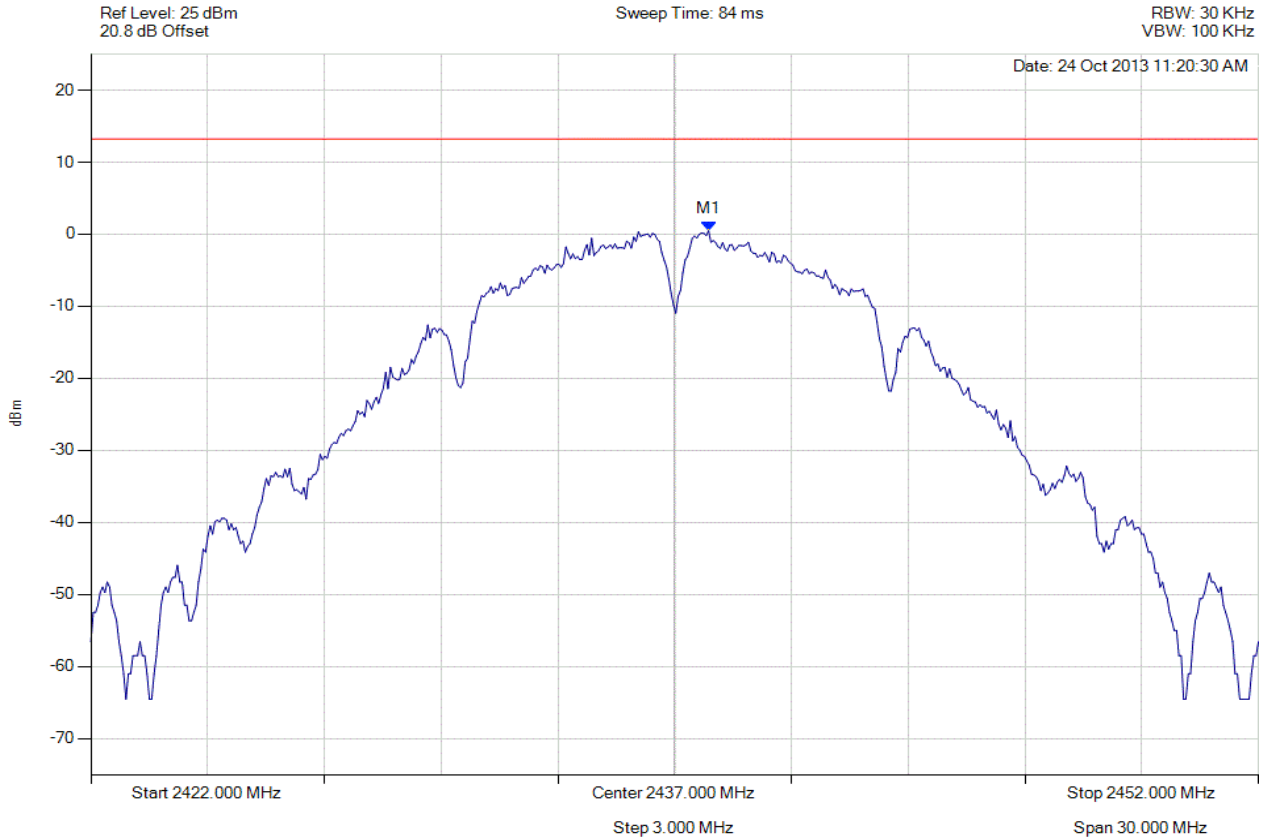

Analyser Setup	Marker : Frequency : Amplitude	Test Results
Detector = AVERAGE Sweep Count = 0 RF Atten (dB) = 20 Trace Mode = VIEW	M1 : 2437.872 MHz : 0.486 dBm	Limit: ≤ 13.229 dBm Margin: -12.74 dB

[Back to the Matrix](#)

This test report may be reproduced in full only. The document may only be updated by MiCOM Labs personnel. Any changes will be noted in the Document History section of the report.



Title: Xirrus Inc. XI-AC1300, XI-AC867
To: FCC 47 CFR Part 15.247 & IC RSS-210
Serial #: XIRR04-U3 Rev A
Issue Date: 29th April 2014
Page: 209 of 572



POWER SPECTRAL DENSITY - AVERAGE

Variant: 802.11b, Channel: 2437.00 MHz, Chain b, Temp: Ambient, Voltage: 56 Vdc

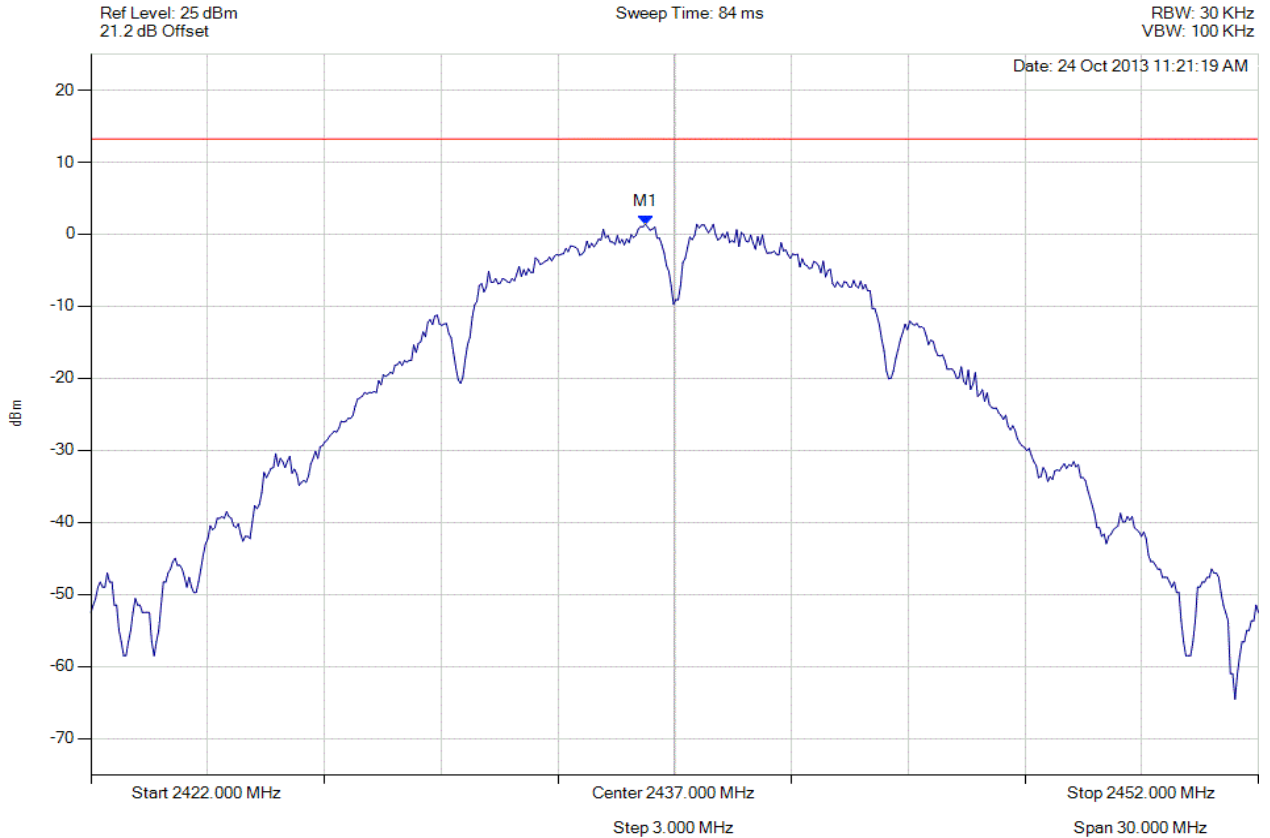

Analyser Setup	Marker : Frequency : Amplitude	Test Results
Detector = AVERAGE Sweep Count = 0 RF Atten (dB) = 20 Trace Mode = VIEW	M1 : 2436.248 MHz : 1.384 dBm	Limit: ≤ 13.229 dBm Margin: -11.85 dB

[Back to the Matrix](#)

This test report may be reproduced in full only. The document may only be updated by MiCOM Labs personnel. Any changes will be noted in the Document History section of the report.



Title: Xirrus Inc. XI-AC1300, XI-AC867
To: FCC 47 CFR Part 15.247 & IC RSS-210
Serial #: XIRR04-U3 Rev A
Issue Date: 29th April 2014
Page: 210 of 572



POWER SPECTRAL DENSITY - AVERAGE

Variant: 802.11b, Channel: 2437.00 MHz, Chain c, Temp: Ambient, Voltage: 56 Vdc

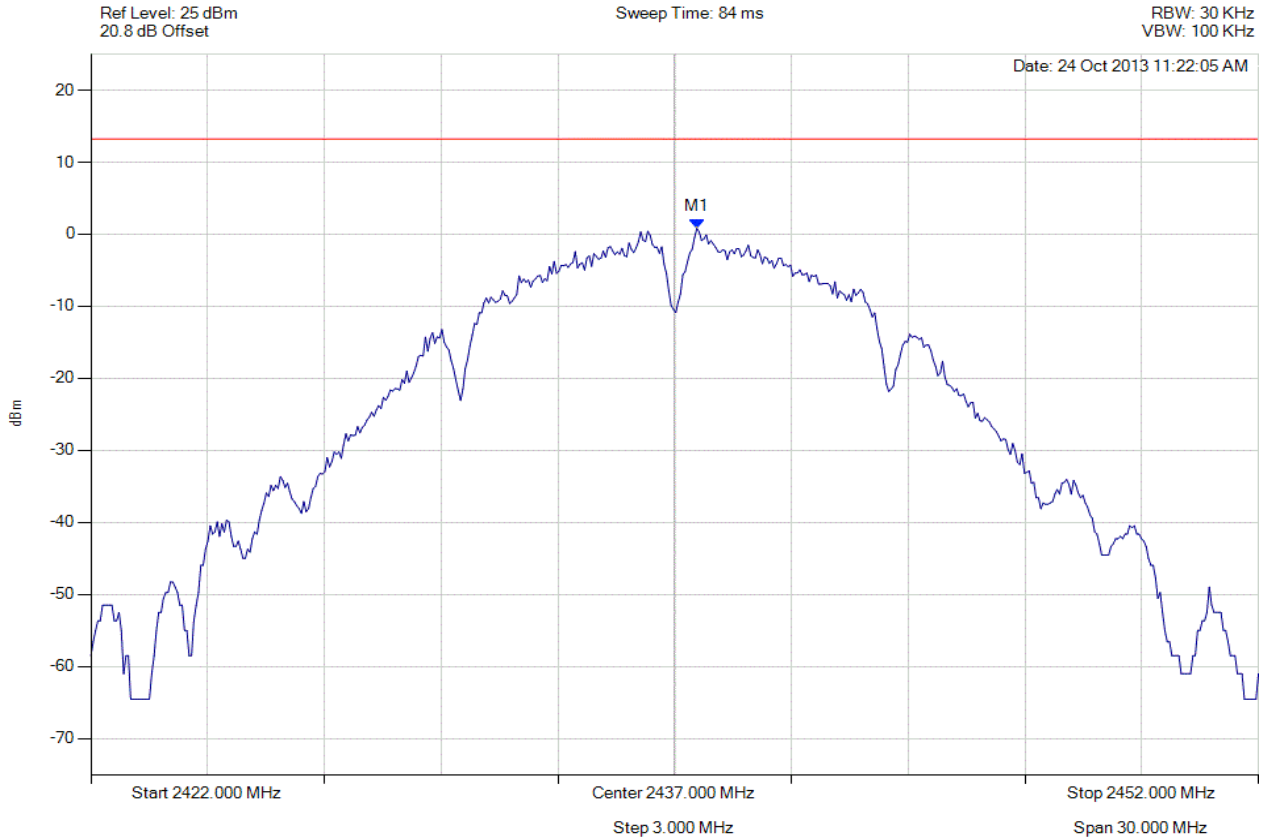

Analyser Setup	Marker : Frequency : Amplitude	Test Results
Detector = AVERAGE Sweep Count = 0 RF Atten (dB) = 20 Trace Mode = VIEW	M1 : 2437.571 MHz : 0.827 dBm	Limit: ≤ 13.229 dBm Margin: -12.40 dB

[Back to the Matrix](#)

This test report may be reproduced in full only. The document may only be updated by MiCOM Labs personnel. Any changes will be noted in the Document History section of the report.



Title: Xirrus Inc. XI-AC1300, XI-AC867
To: FCC 47 CFR Part 15.247 & IC RSS-210
Serial #: XIRR04-U3 Rev A
Issue Date: 29th April 2014
Page: 211 of 572



POWER SPECTRAL DENSITY - AVERAGE

Variant: 802.11b, Channel: 2462.00 MHz, Chain a, Temp: Ambient, Voltage: 56 Vdc

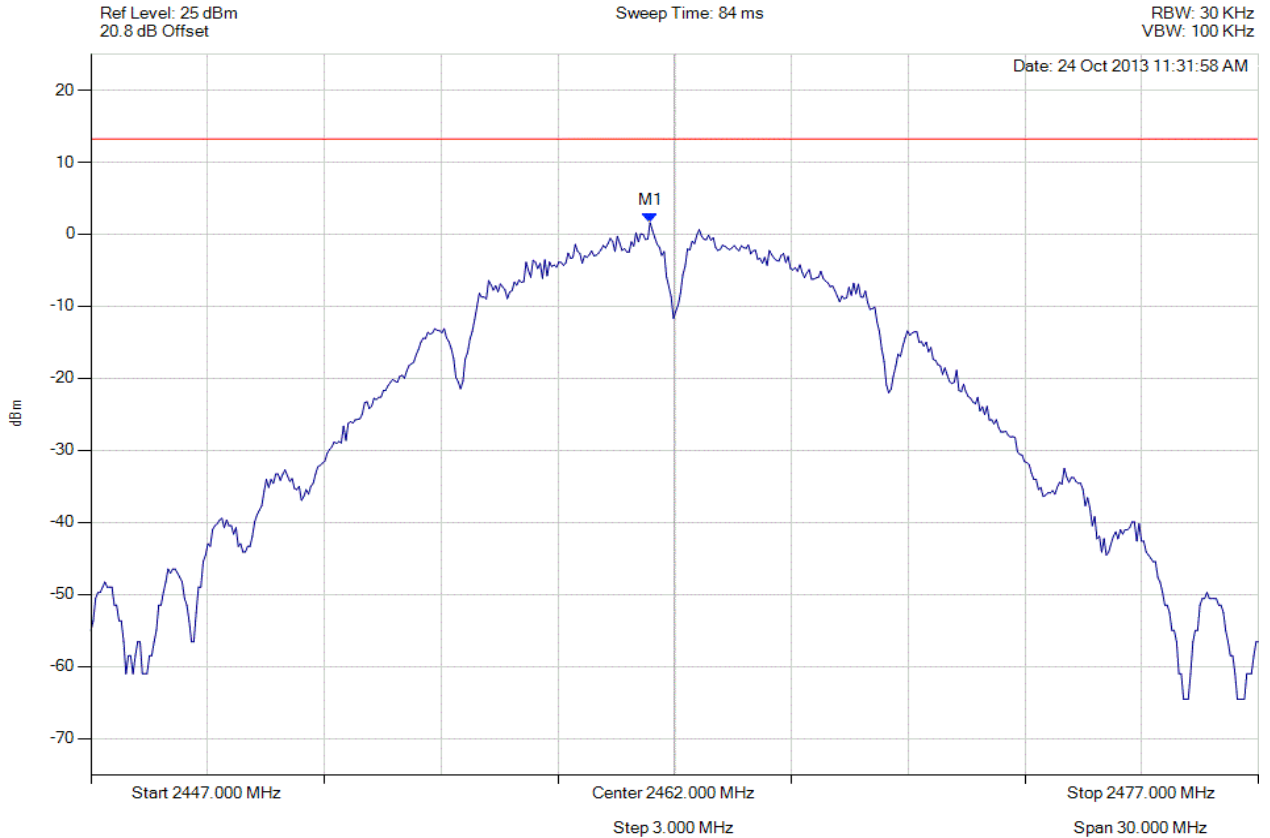

Analyser Setup	Marker : Frequency : Amplitude	Test Results
Detector = AVERAGE Sweep Count = 0 RF Atten (dB) = 20 Trace Mode = VIEW	M1 : 2461.369 MHz : 1.607 dBm	Limit: ≤ 13.229 dBm Margin: -11.62 dB

[Back to the Matrix](#)

This test report may be reproduced in full only. The document may only be updated by MiCOM Labs personnel. Any changes will be noted in the Document History section of the report.



Title: Xirrus Inc. XI-AC1300, XI-AC867
To: FCC 47 CFR Part 15.247 & IC RSS-210
Serial #: XIRR04-U3 Rev A
Issue Date: 29th April 2014
Page: 212 of 572



POWER SPECTRAL DENSITY - AVERAGE

Variant: 802.11b, Channel: 2462.00 MHz, Chain b, Temp: Ambient, Voltage: 56 Vdc

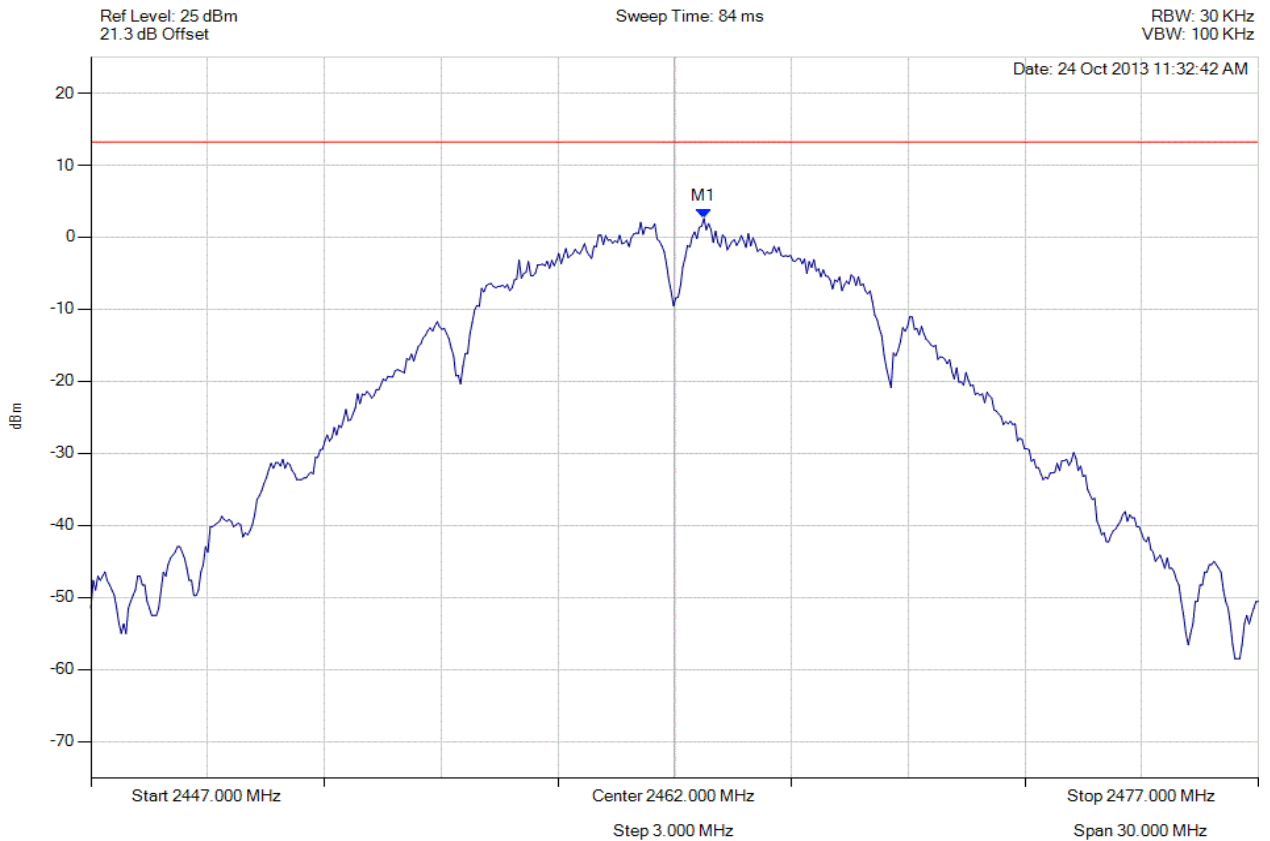

Analyser Setup	Marker : Frequency : Amplitude	Test Results
Detector = AVERAGE Sweep Count = 0 RF Atten (dB) = 20 Trace Mode = VIEW	M1 : 2462.752 MHz : 2.591 dBm	Limit: ≤ 13.229 dBm Margin: -10.64 dB

[Back to the Matrix](#)

This test report may be reproduced in full only. The document may only be updated by MiCOM Labs personnel. Any changes will be noted in the Document History section of the report.



Title: Xirrus Inc. XI-AC1300, XI-AC867
To: FCC 47 CFR Part 15.247 & IC RSS-210
Serial #: XIRR04-U3 Rev A
Issue Date: 29th April 2014
Page: 213 of 572



POWER SPECTRAL DENSITY - AVERAGE

Variant: 802.11b, Channel: 2462.00 MHz, Chain c, Temp: Ambient, Voltage: 56 Vdc

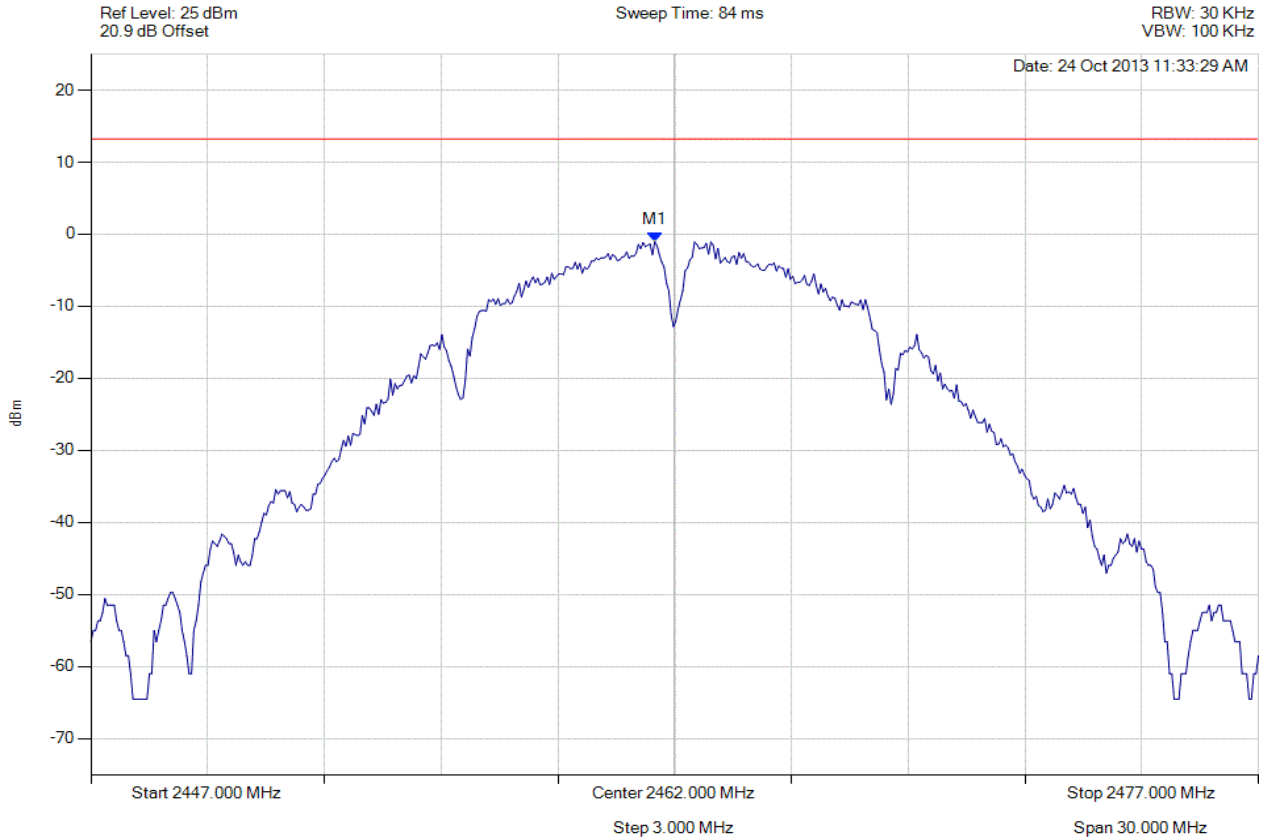

Analyser Setup	Marker : Frequency : Amplitude	Test Results
Detector = AVERAGE Sweep Count = 0 RF Atten (dB) = 20 Trace Mode = VIEW	M1 : 2461.489 MHz : -1.026 dBm	Limit: ≤ 13.229 dBm Margin: -14.26 dB

[Back to the Matrix](#)

This test report may be reproduced in full only. The document may only be updated by MiCOM Labs personnel. Any changes will be noted in the Document History section of the report.



Title: Xirrus Inc. XI-AC1300, XI-AC867
To: FCC 47 CFR Part 15.247 & IC RSS-210
Serial #: XIRR04-U3 Rev A
Issue Date: 29th April 2014
Page: 214 of 572



POWER SPECTRAL DENSITY - AVERAGE

Variant: 802.11g, Channel: 2412.00 MHz, Chain a, Temp: Ambient, Voltage: 56 Vdc

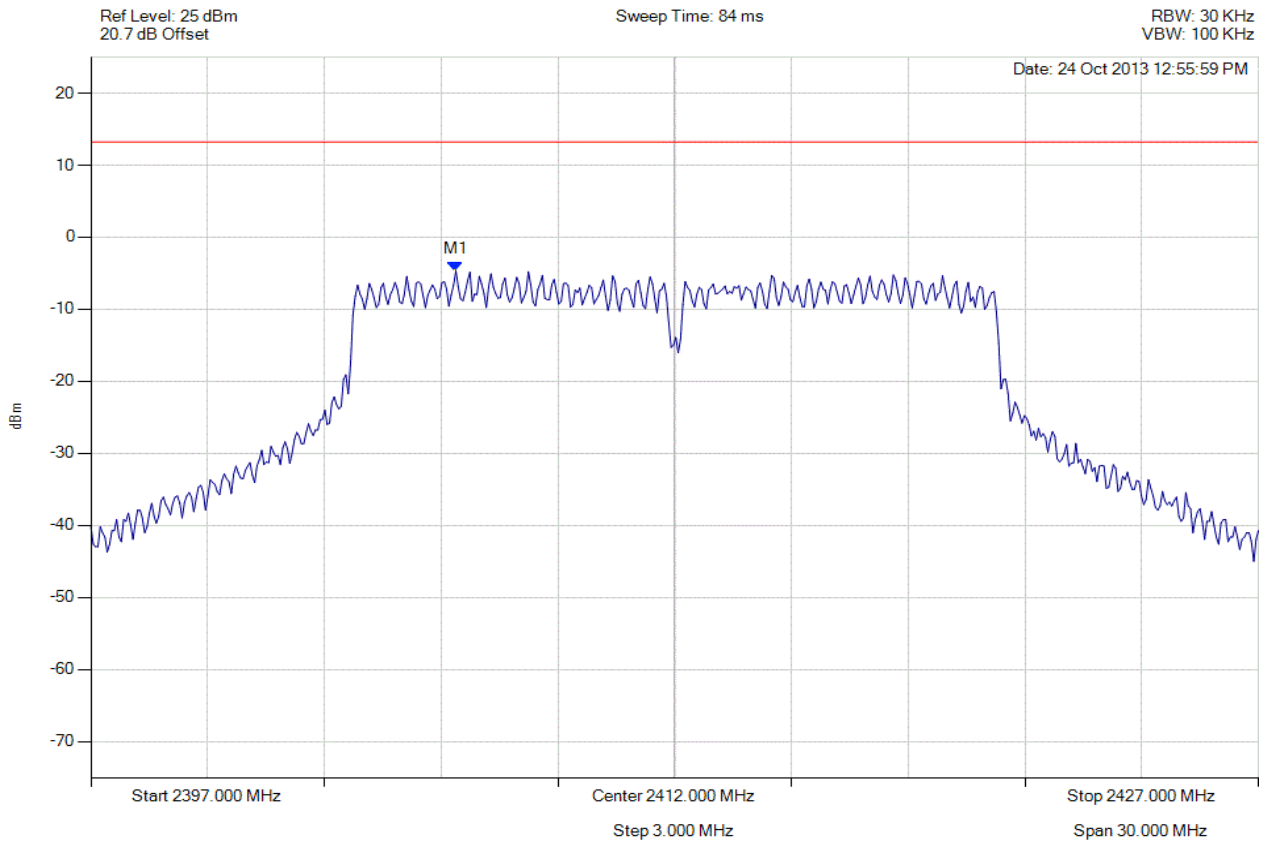

Analyser Setup	Marker : Frequency : Amplitude	Test Results
Detector = AVERAGE Sweep Count = 0 RF Atten (dB) = 20 Trace Mode = VIEW	M1 : 2406.379 MHz : -4.650 dBm	Limit: ≤ 13.229 dBm Margin: -17.88 dB

[Back to the Matrix](#)

This test report may be reproduced in full only. The document may only be updated by MiCOM Labs personnel. Any changes will be noted in the Document History section of the report.



Title: Xirrus Inc. XI-AC1300, XI-AC867
To: FCC 47 CFR Part 15.247 & IC RSS-210
Serial #: XIRR04-U3 Rev A
Issue Date: 29th April 2014
Page: 215 of 572



POWER SPECTRAL DENSITY - AVERAGE

Variant: 802.11g, Channel: 2412.00 MHz, Chain b, Temp: Ambient, Voltage: 56 Vdc

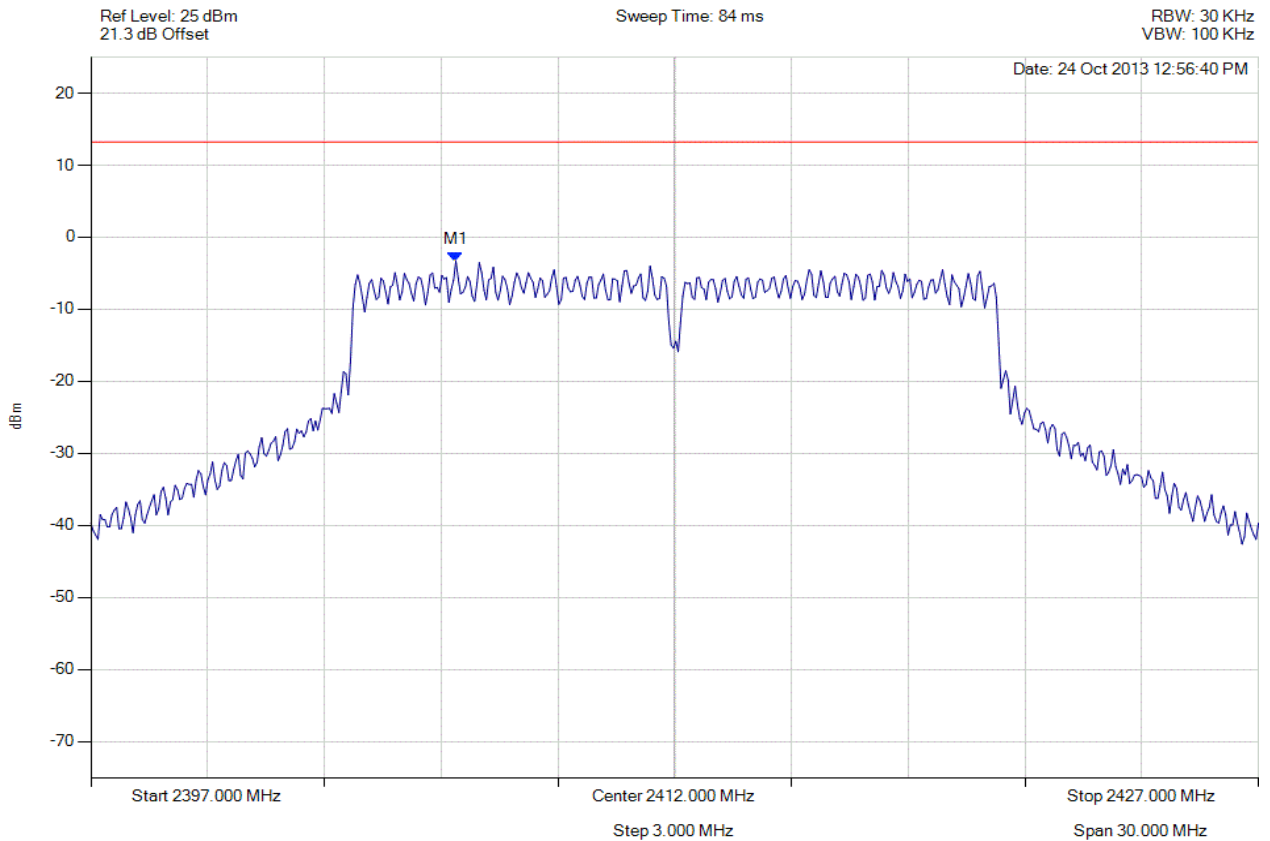

Analyser Setup	Marker : Frequency : Amplitude	Test Results
Detector = AVERAGE Sweep Count = 0 RF Atten (dB) = 20 Trace Mode = VIEW	M1 : 2406.379 MHz : -3.342 dBm	Limit: ≤ 13.229 dBm Margin: -16.57 dB

[Back to the Matrix](#)

This test report may be reproduced in full only. The document may only be updated by MiCOM Labs personnel. Any changes will be noted in the Document History section of the report.



Title: Xirrus Inc. XI-AC1300, XI-AC867
To: FCC 47 CFR Part 15.247 & IC RSS-210
Serial #: XIRR04-U3 Rev A
Issue Date: 29th April 2014
Page: 216 of 572



POWER SPECTRAL DENSITY - AVERAGE

Variant: 802.11g, Channel: 2412.00 MHz, Chain c, Temp: Ambient, Voltage: 56 Vdc

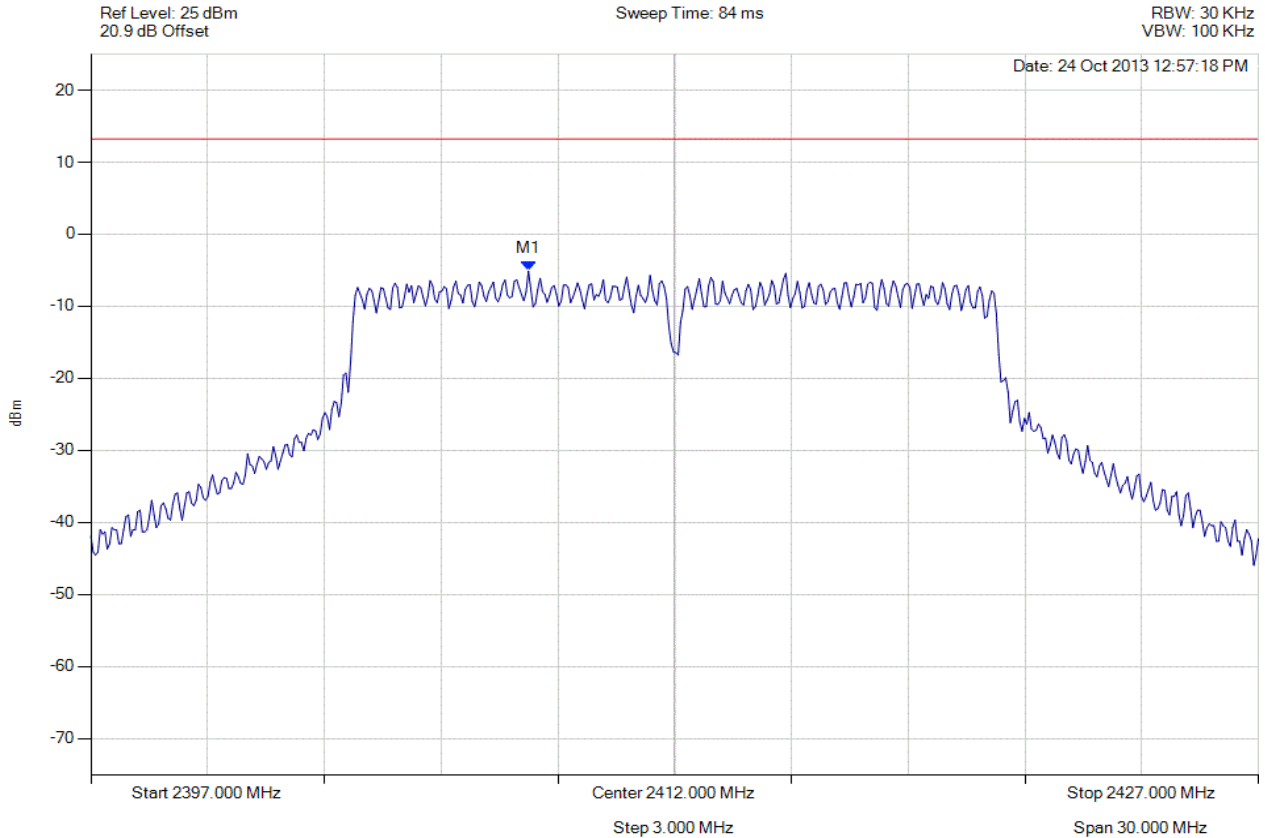

Analyser Setup	Marker : Frequency : Amplitude	Test Results
Detector = AVERAGE Sweep Count = 0 RF Atten (dB) = 20 Trace Mode = VIEW	M1 : 2408.242 MHz : -5.115 dBm	Limit: ≤ 13.229 dBm Margin: -18.34 dB

[Back to the Matrix](#)

This test report may be reproduced in full only. The document may only be updated by MiCOM Labs personnel. Any changes will be noted in the Document History section of the report.



Title: Xirrus Inc. XI-AC1300, XI-AC867
To: FCC 47 CFR Part 15.247 & IC RSS-210
Serial #: XIRR04-U3 Rev A
Issue Date: 29th April 2014
Page: 217 of 572



POWER SPECTRAL DENSITY - AVERAGE

Variant: 802.11g, Channel: 2437.00 MHz, Chain a, Temp: Ambient, Voltage: 56 Vdc

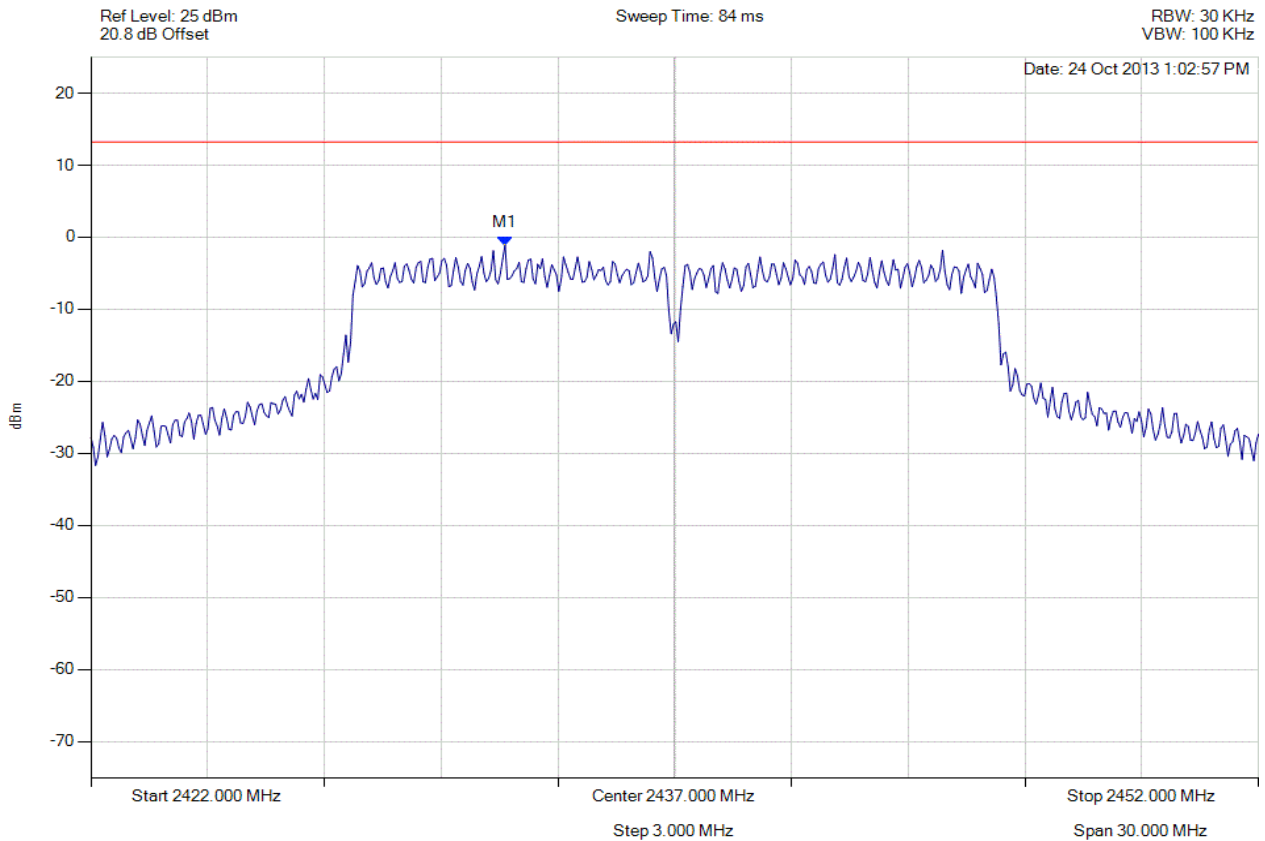

Analyser Setup	Marker : Frequency : Amplitude	Test Results
Detector = AVERAGE Sweep Count = 0 RF Atten (dB) = 20 Trace Mode = VIEW	M1 : 2432.641 MHz : -1.113 dBm	Limit: ≤ 13.229 dBm Margin: -14.34 dB

[Back to the Matrix](#)

This test report may be reproduced in full only. The document may only be updated by MiCOM Labs personnel. Any changes will be noted in the Document History section of the report.



Title: Xirrus Inc. XI-AC1300, XI-AC867
To: FCC 47 CFR Part 15.247 & IC RSS-210
Serial #: XIRR04-U3 Rev A
Issue Date: 29th April 2014
Page: 218 of 572



POWER SPECTRAL DENSITY - AVERAGE

Variant: 802.11g, Channel: 2437.00 MHz, Chain b, Temp: Ambient, Voltage: 56 Vdc

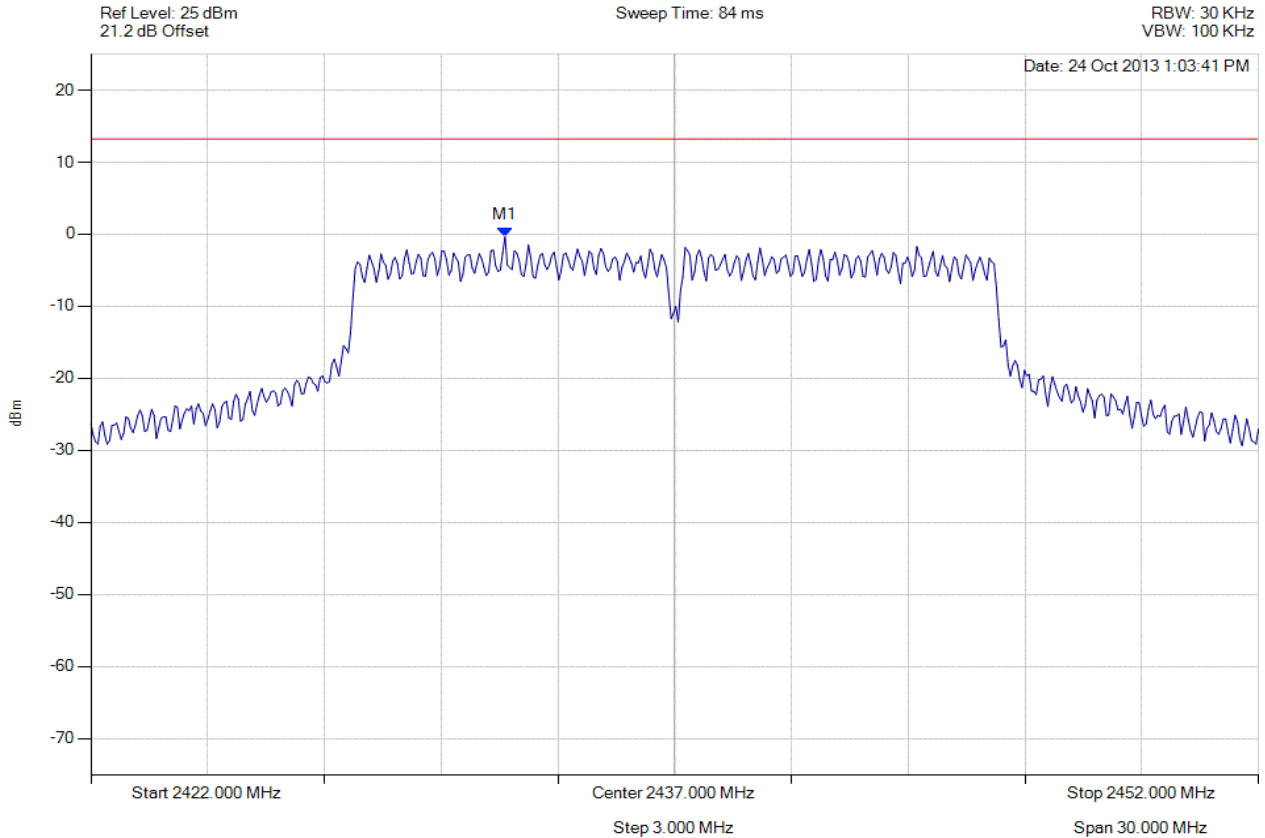

Analyser Setup	Marker : Frequency : Amplitude	Test Results
Detector = AVERAGE Sweep Count = 0 RF Atten (dB) = 20 Trace Mode = VIEW	M1 : 2432.641 MHz : -0.373 dBm	Limit: ≤ 13.229 dBm Margin: -13.60 dB

[Back to the Matrix](#)

This test report may be reproduced in full only. The document may only be updated by MiCOM Labs personnel. Any changes will be noted in the Document History section of the report.



Title: Xirrus Inc. XI-AC1300, XI-AC867
To: FCC 47 CFR Part 15.247 & IC RSS-210
Serial #: XIRR04-U3 Rev A
Issue Date: 29th April 2014
Page: 219 of 572



POWER SPECTRAL DENSITY - AVERAGE

Variant: 802.11g, Channel: 2437.00 MHz, Chain c, Temp: Ambient, Voltage: 56 Vdc

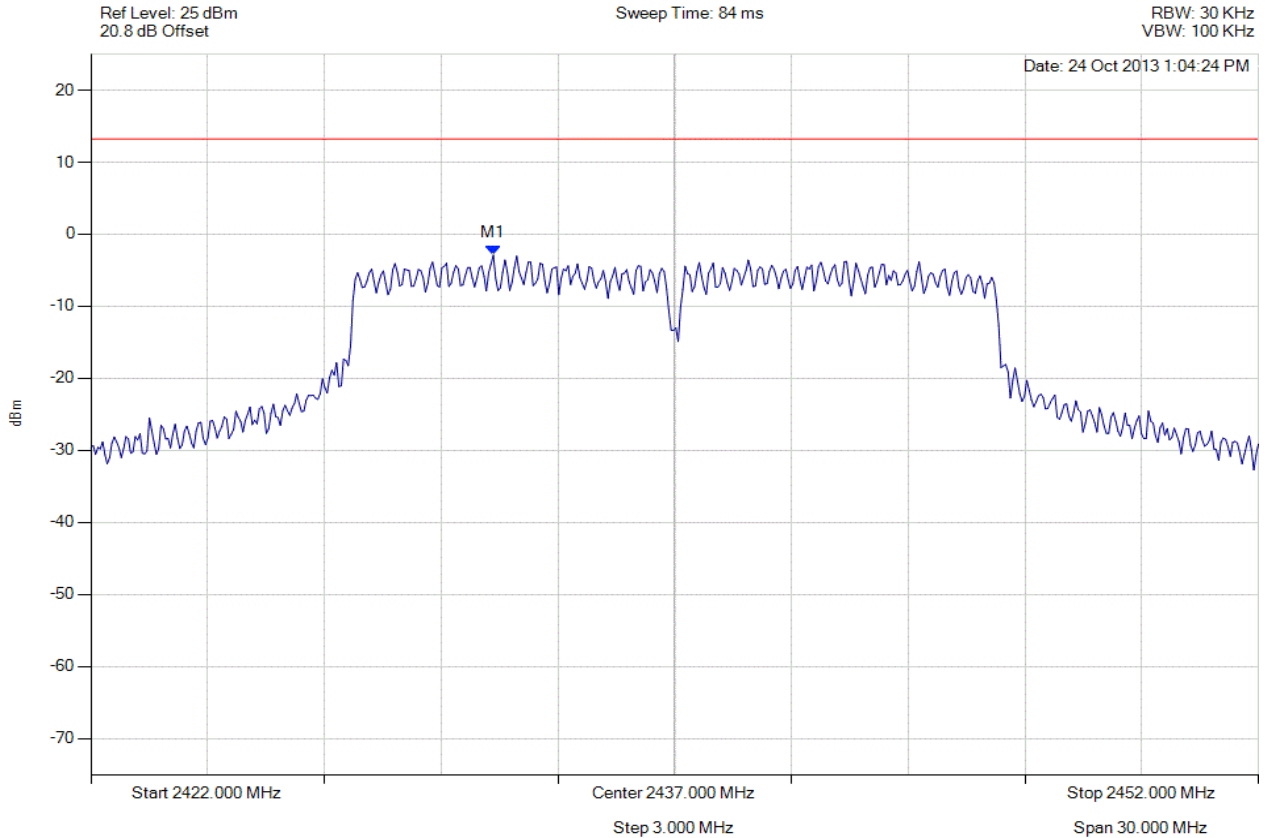

Analyser Setup	Marker : Frequency : Amplitude	Test Results
Detector = AVERAGE Sweep Count = 0 RF Atten (dB) = 20 Trace Mode = VIEW	M1 : 2432.341 MHz : -2.900 dBm	Limit: ≤ 13.229 dBm Margin: -16.13 dB

[Back to the Matrix](#)

This test report may be reproduced in full only. The document may only be updated by MiCOM Labs personnel. Any changes will be noted in the Document History section of the report.



Title: Xirrus Inc. XI-AC1300, XI-AC867
To: FCC 47 CFR Part 15.247 & IC RSS-210
Serial #: XIRR04-U3 Rev A
Issue Date: 29th April 2014
Page: 220 of 572



POWER SPECTRAL DENSITY - AVERAGE

Variant: 802.11g, Channel: 2462.00 MHz, Chain a, Temp: Ambient, Voltage: 56 Vdc

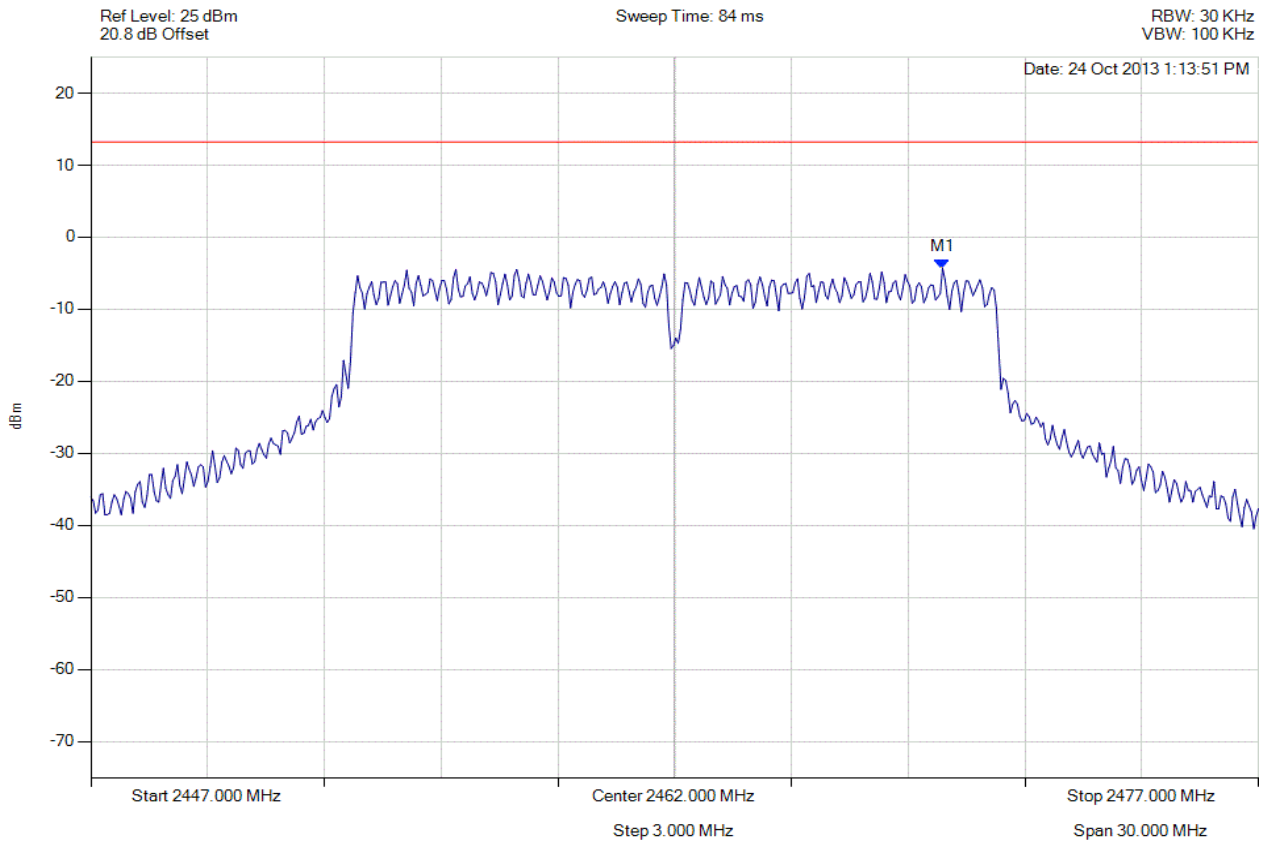

Analyser Setup	Marker : Frequency : Amplitude	Test Results
Detector = AVERAGE Sweep Count = 0 RF Atten (dB) = 20 Trace Mode = VIEW	M1 : 2468.884 MHz : -4.313 dBm	Limit: ≤ 13.229 dBm Margin: -17.54 dB

[Back to the Matrix](#)

This test report may be reproduced in full only. The document may only be updated by MiCOM Labs personnel. Any changes will be noted in the Document History section of the report.



Title: Xirrus Inc. XI-AC1300, XI-AC867
To: FCC 47 CFR Part 15.247 & IC RSS-210
Serial #: XIRR04-U3 Rev A
Issue Date: 29th April 2014
Page: 221 of 572



POWER SPECTRAL DENSITY - AVERAGE

Variant: 802.11g, Channel: 2462.00 MHz, Chain b, Temp: Ambient, Voltage: 56 Vdc

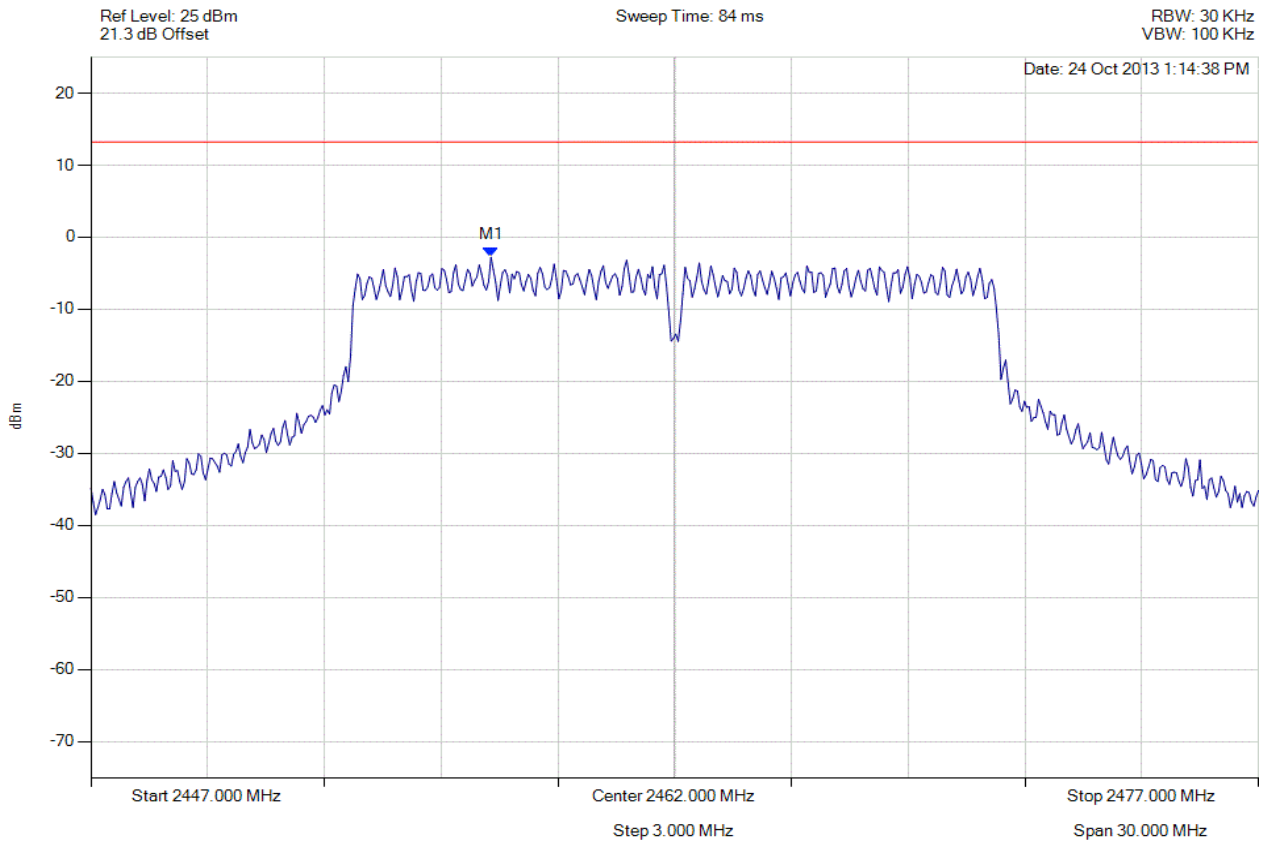

Analyser Setup	Marker : Frequency : Amplitude	Test Results
Detector = AVERAGE Sweep Count = 0 RF Atten (dB) = 20 Trace Mode = VIEW	M1 : 2457.281 MHz : -2.771 dBm	Limit: ≤ 13.229 dBm Margin: -16.00 dB

[Back to the Matrix](#)

This test report may be reproduced in full only. The document may only be updated by MiCOM Labs personnel. Any changes will be noted in the Document History section of the report.



Title: Xirrus Inc. XI-AC1300, XI-AC867
To: FCC 47 CFR Part 15.247 & IC RSS-210
Serial #: XIRR04-U3 Rev A
Issue Date: 29th April 2014
Page: 222 of 572



POWER SPECTRAL DENSITY - AVERAGE

Variant: 802.11g, Channel: 2462.00 MHz, Chain c, Temp: Ambient, Voltage: 56 Vdc

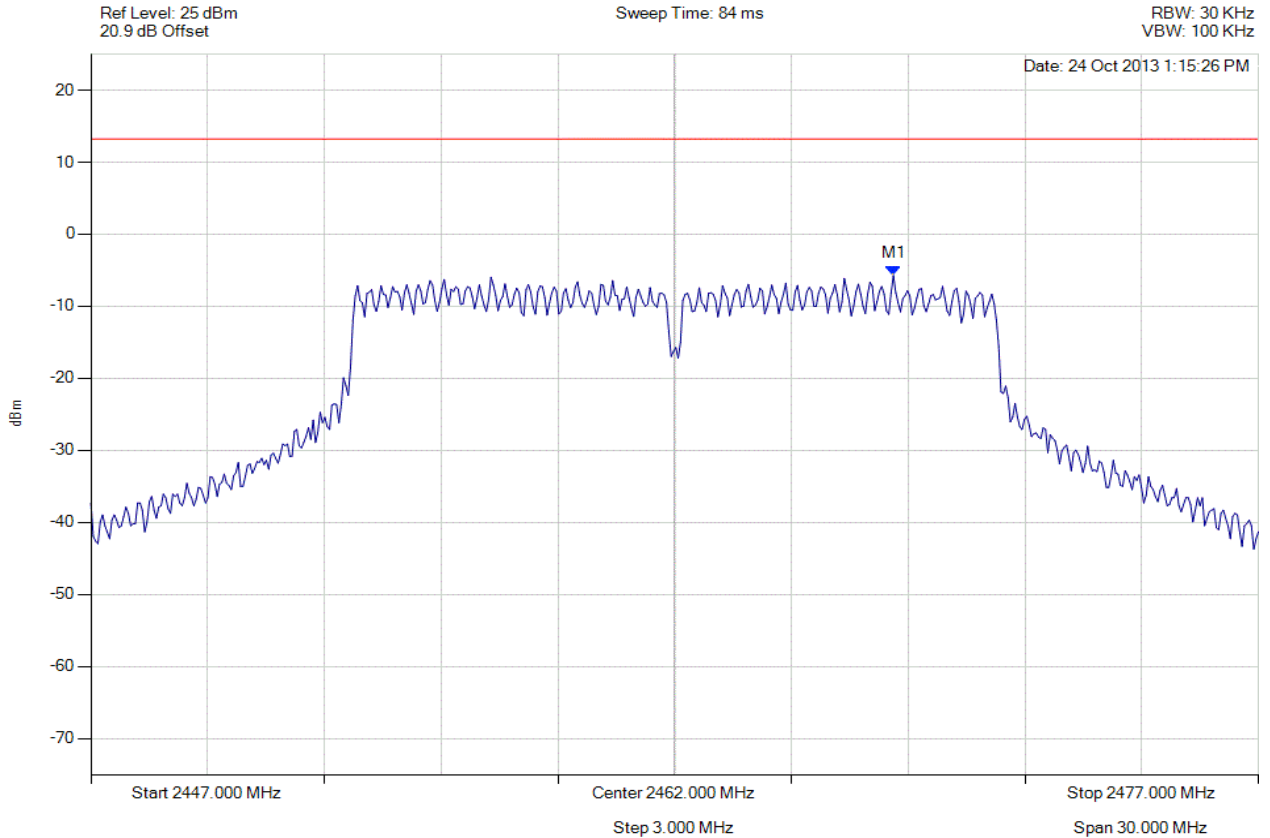

Analyser Setup	Marker : Frequency : Amplitude	Test Results
Detector = AVERAGE Sweep Count = 0 RF Atten (dB) = 20 Trace Mode = VIEW	M1 : 2467.621 MHz : -5.719 dBm	Limit: ≤ 13.229 dBm Margin: -18.95 dB

[Back to the Matrix](#)

This test report may be reproduced in full only. The document may only be updated by MiCOM Labs personnel. Any changes will be noted in the Document History section of the report.



Title: Xirrus Inc. XI-AC1300, XI-AC867
To: FCC 47 CFR Part 15.247 & IC RSS-210
Serial #: XIRR04-U3 Rev A
Issue Date: 29th April 2014
Page: 223 of 572



POWER SPECTRAL DENSITY - AVERAGE

Variant: 802.11n HT-20, Channel: 2412.00 MHz, Chain a, Temp: Ambient, Voltage: 56 Vdc

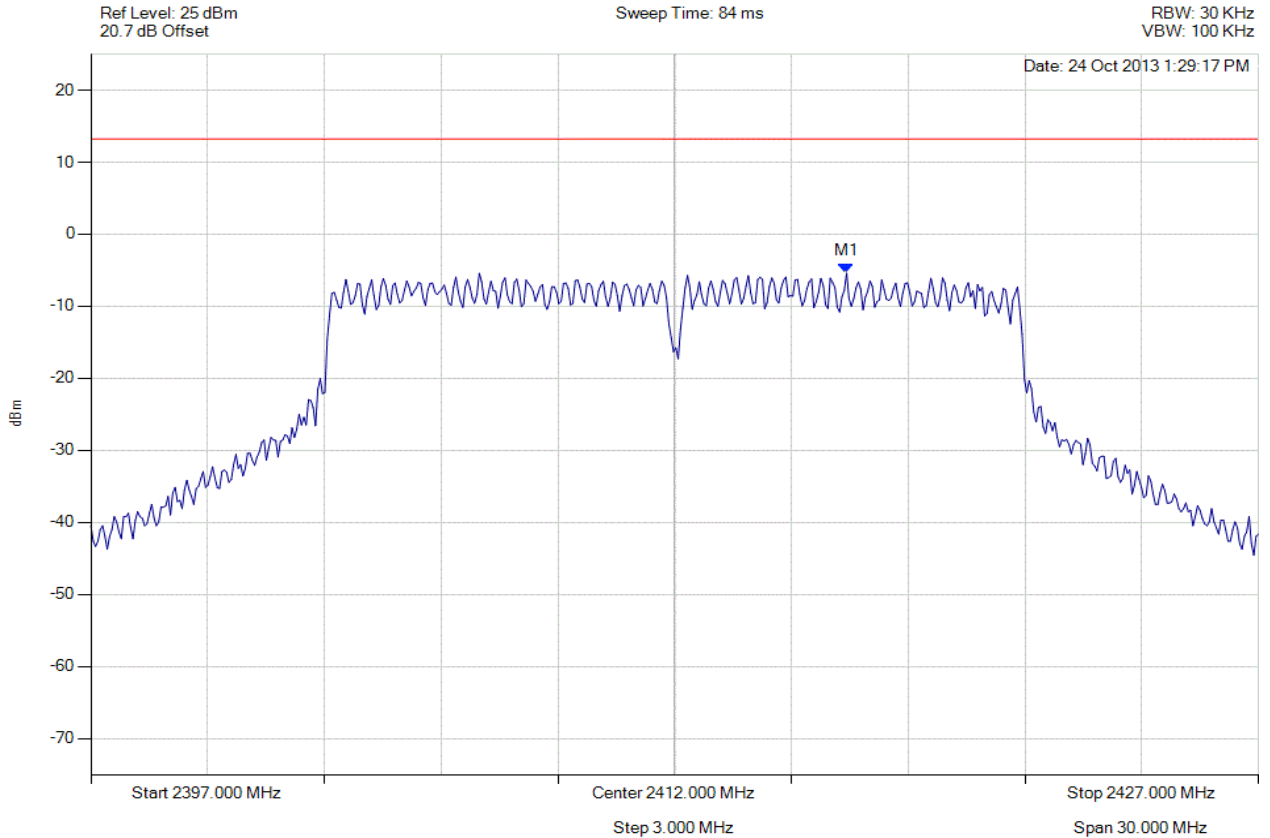

Analyser Setup	Marker : Frequency : Amplitude	Test Results
Detector = AVERAGE Sweep Count = 0 RF Atten (dB) = 20 Trace Mode = VIEW	M1 : 2416.419 MHz : -5.412 dBm	Limit: ≤ 13.229 dBm Margin: -18.64 dB

[Back to the Matrix](#)

This test report may be reproduced in full only. The document may only be updated by MiCOM Labs personnel. Any changes will be noted in the Document History section of the report.



Title: Xirrus Inc. XI-AC1300, XI-AC867
To: FCC 47 CFR Part 15.247 & IC RSS-210
Serial #: XIRR04-U3 Rev A
Issue Date: 29th April 2014
Page: 224 of 572



POWER SPECTRAL DENSITY - AVERAGE

Variation: 802.11n HT-20, Channel: 2412.00 MHz, Chain b, Temp: Ambient, Voltage: 56 Vdc

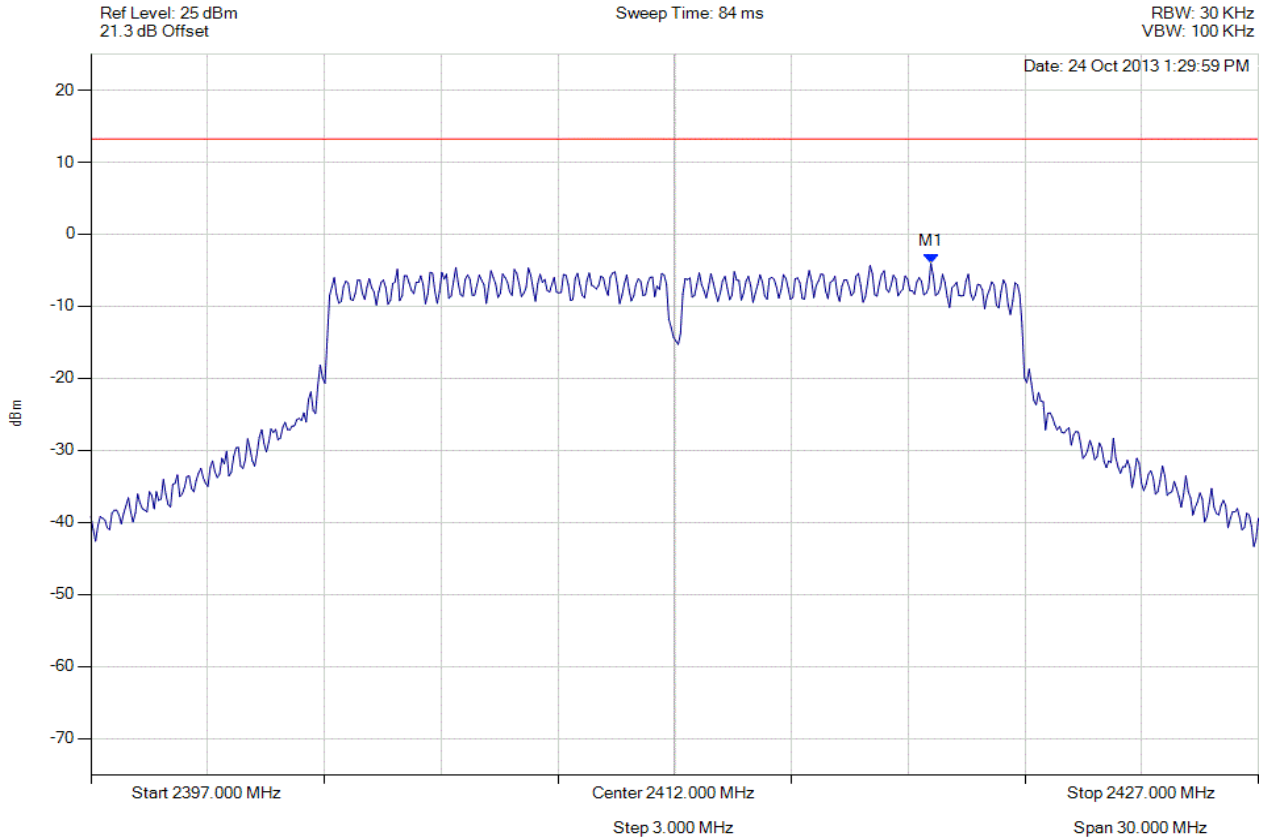

Analyser Setup	Marker : Frequency : Amplitude	Test Results
Detector = AVERAGE Sweep Count = 0 RF Atten (dB) = 20 Trace Mode = VIEW	M1 : 2418.583 MHz : -4.047 dBm	Limit: ≤ 13.229 dBm Margin: -17.28 dB

[Back to the Matrix](#)

This test report may be reproduced in full only. The document may only be updated by MiCOM Labs personnel. Any changes will be noted in the Document History section of the report.



Title: Xirrus Inc. XI-AC1300, XI-AC867
To: FCC 47 CFR Part 15.247 & IC RSS-210
Serial #: XIRR04-U3 Rev A
Issue Date: 29th April 2014
Page: 225 of 572



POWER SPECTRAL DENSITY - AVERAGE

Variant: 802.11n HT-20, Channel: 2412.00 MHz, Chain c, Temp: Ambient, Voltage: 56 Vdc

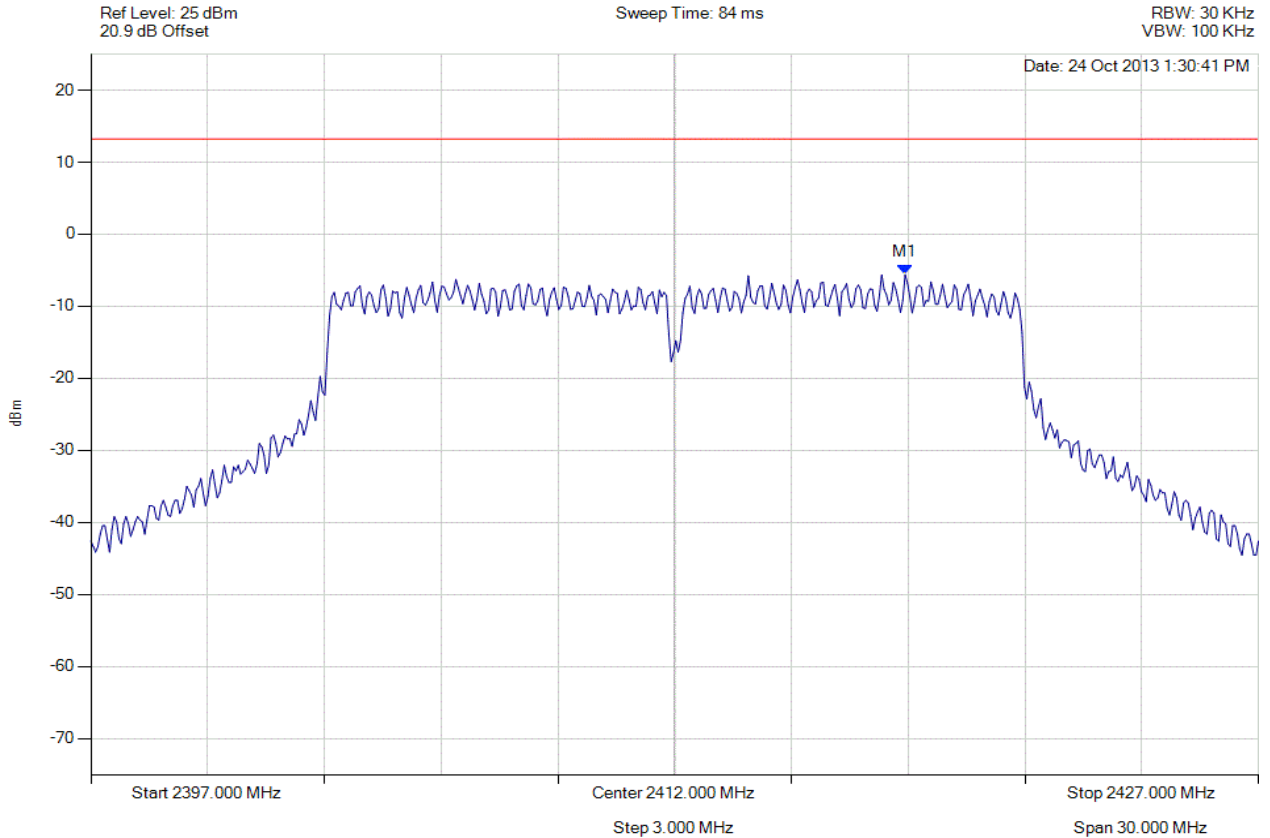

Analyser Setup	Marker : Frequency : Amplitude	Test Results
Detector = AVERAGE Sweep Count = 0 RF Atten (dB) = 20 Trace Mode = VIEW	M1 : 2417.922 MHz : -5.606 dBm	Limit: \leq 13.229 dBm Margin: -18.84 dB

[Back to the Matrix](#)

This test report may be reproduced in full only. The document may only be updated by MiCOM Labs personnel. Any changes will be noted in the Document History section of the report.



Title: Xirrus Inc. XI-AC1300, XI-AC867
To: FCC 47 CFR Part 15.247 & IC RSS-210
Serial #: XIRR04-U3 Rev A
Issue Date: 29th April 2014
Page: 226 of 572



POWER SPECTRAL DENSITY - AVERAGE

Variant: 802.11n HT-20, Channel: 2437.00 MHz, Chain a, Temp: Ambient, Voltage: 56 Vdc

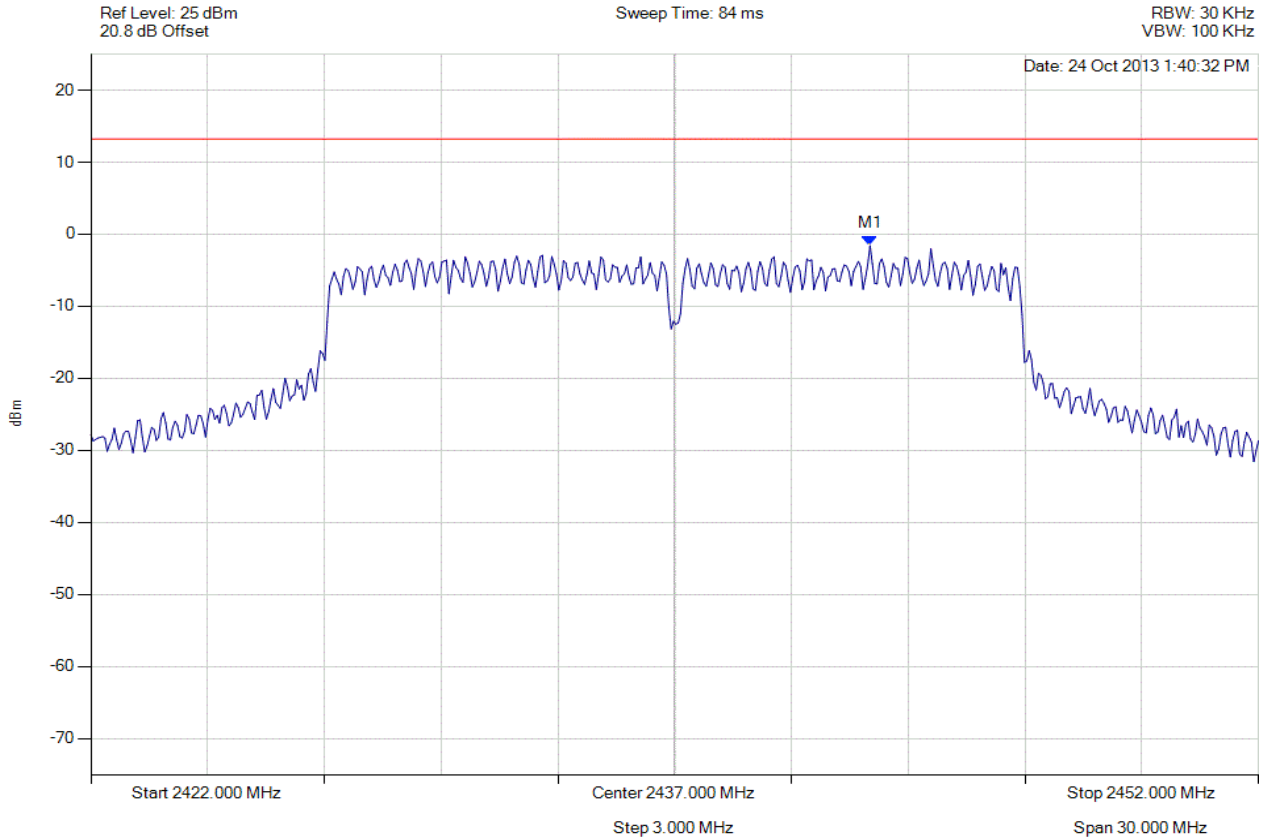

Analyser Setup	Marker : Frequency : Amplitude	Test Results
Detector = AVERAGE Sweep Count = 0 RF Atten (dB) = 20 Trace Mode = VIEW	M1 : 2442.020 MHz : -1.585 dBm	Limit: ≤ 13.229 dBm Margin: -14.82 dB

[Back to the Matrix](#)

This test report may be reproduced in full only. The document may only be updated by MiCOM Labs personnel. Any changes will be noted in the Document History section of the report.



Title: Xirrus Inc. XI-AC1300, XI-AC867
To: FCC 47 CFR Part 15.247 & IC RSS-210
Serial #: XIRR04-U3 Rev A
Issue Date: 29th April 2014
Page: 227 of 572



POWER SPECTRAL DENSITY - AVERAGE

Variation: 802.11n HT-20, Channel: 2437.00 MHz, Chain b, Temp: Ambient, Voltage: 56 Vdc

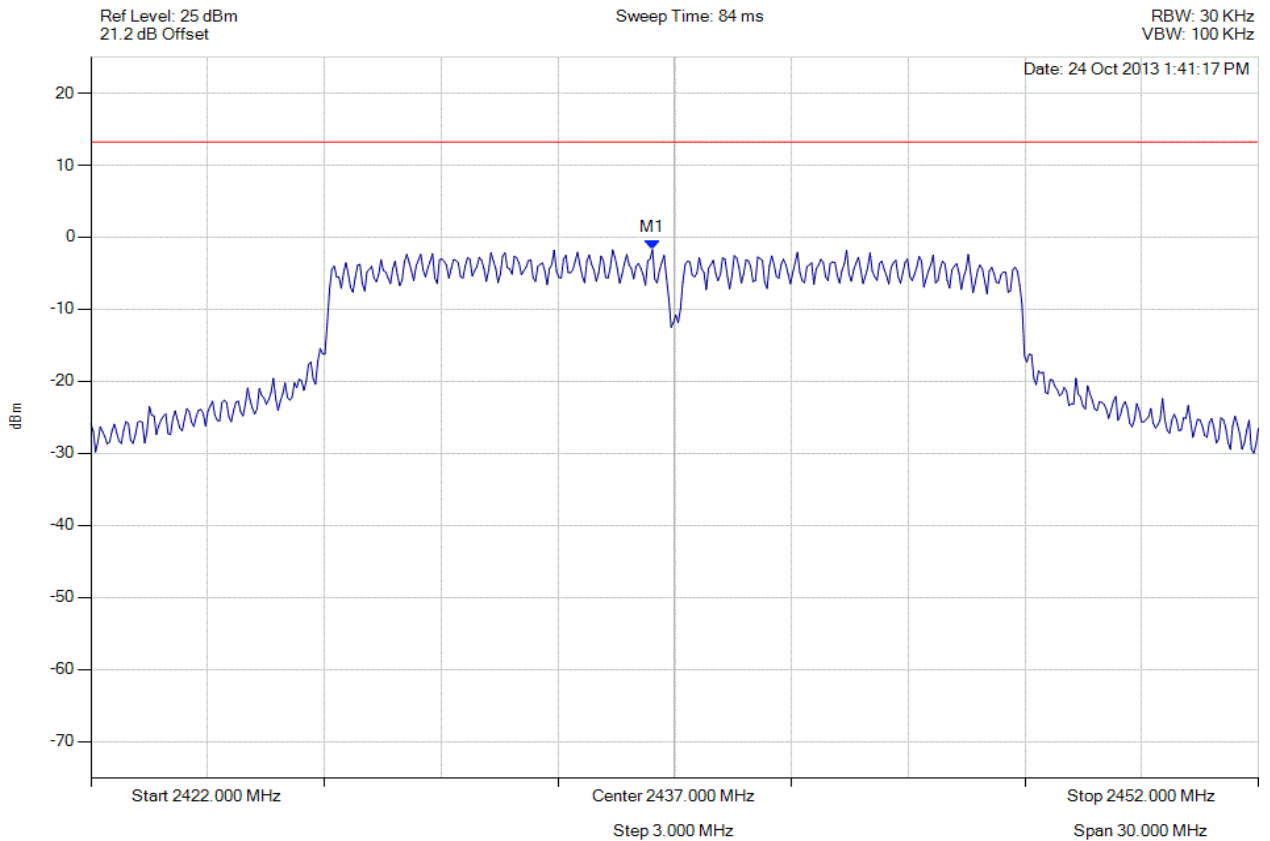

Analyser Setup	Marker : Frequency : Amplitude	Test Results
Detector = AVERAGE Sweep Count = 0 RF Atten (dB) = 20 Trace Mode = VIEW	M1 : 2436.429 MHz : -1.703 dBm	Limit: ≤ 13.229 dBm Margin: -14.93 dB

[Back to the Matrix](#)

This test report may be reproduced in full only. The document may only be updated by MiCOM Labs personnel. Any changes will be noted in the Document History section of the report.



Title: Xirrus Inc. XI-AC1300, XI-AC867
To: FCC 47 CFR Part 15.247 & IC RSS-210
Serial #: XIRR04-U3 Rev A
Issue Date: 29th April 2014
Page: 228 of 572



POWER SPECTRAL DENSITY - AVERAGE

Variant: 802.11n HT-20, Channel: 2437.00 MHz, Chain c, Temp: Ambient, Voltage: 56 Vdc

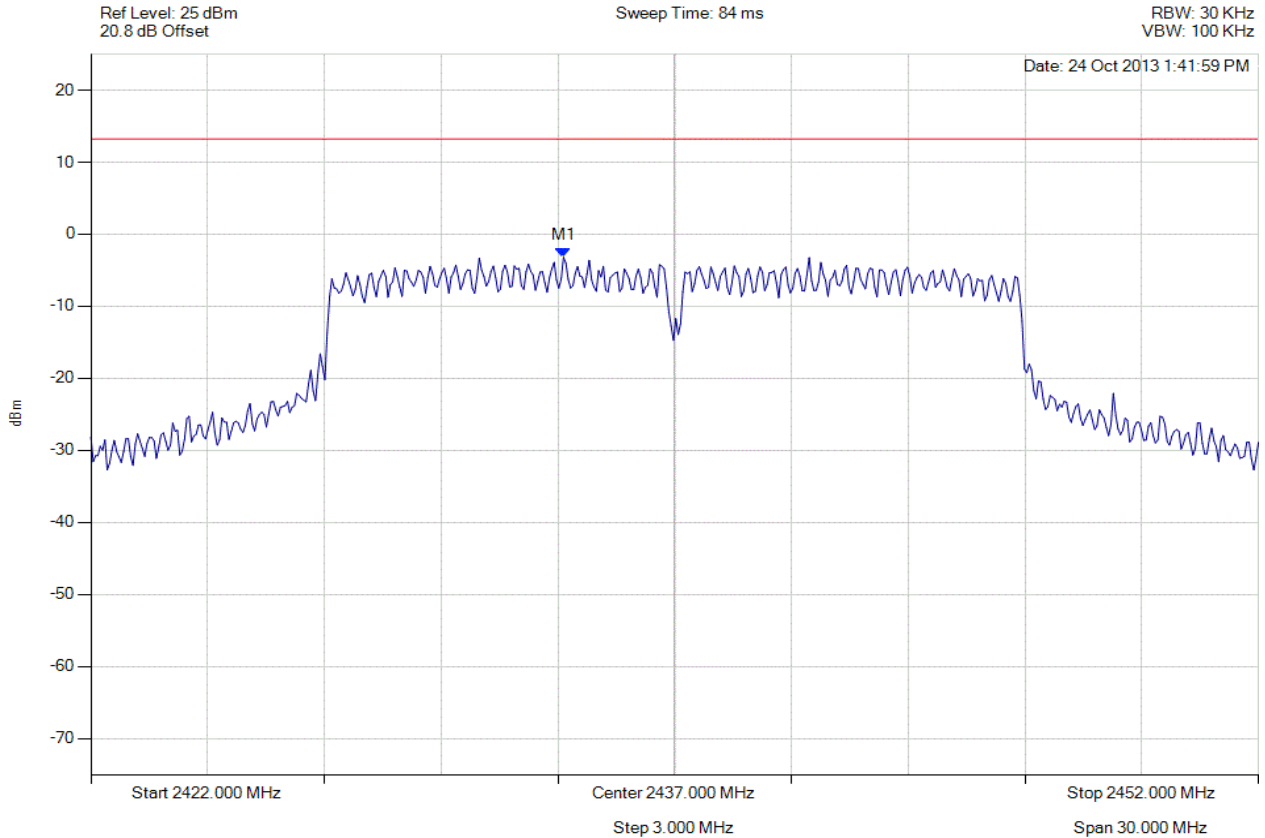

Analyser Setup	Marker : Frequency : Amplitude	Test Results
Detector = AVERAGE Sweep Count = 0 RF Atten (dB) = 20 Trace Mode = VIEW	M1 : 2434.144 MHz : -3.211 dBm	Limit: ≤ 13.229 dBm Margin: -16.44 dB

[Back to the Matrix](#)

This test report may be reproduced in full only. The document may only be updated by MiCOM Labs personnel. Any changes will be noted in the Document History section of the report.



Title: Xirrus Inc. XI-AC1300, XI-AC867
To: FCC 47 CFR Part 15.247 & IC RSS-210
Serial #: XIRR04-U3 Rev A
Issue Date: 29th April 2014
Page: 229 of 572



POWER SPECTRAL DENSITY - AVERAGE

Variation: 802.11n HT-20, Channel: 2462.00 MHz, Chain a, Temp: Ambient, Voltage: 56 Vdc

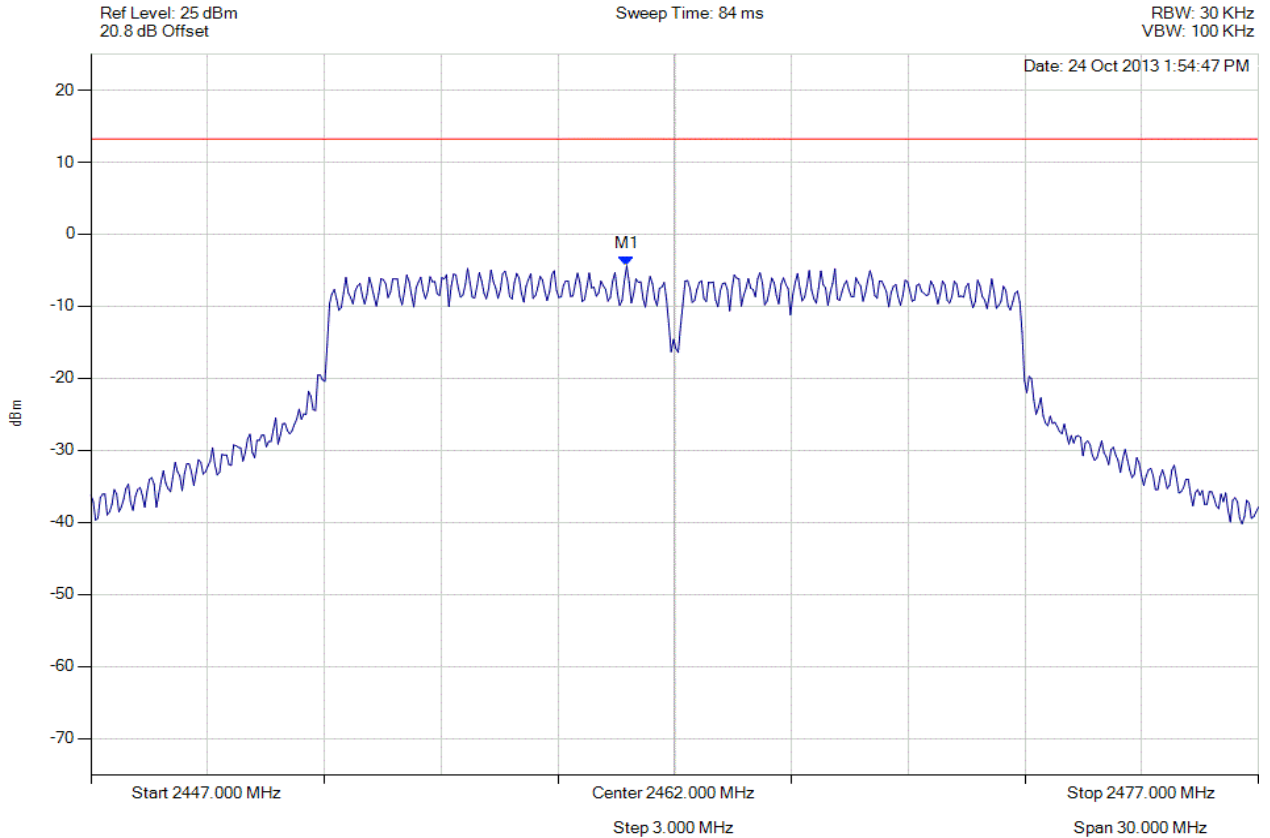

Analyser Setup	Marker : Frequency : Amplitude	Test Results
Detector = AVERAGE Sweep Count = 0 RF Atten (dB) = 20 Trace Mode = VIEW	M1 : 2460.768 MHz : -4.390 dBm	Limit: ≤ 13.229 dBm Margin: -17.62 dB

[Back to the Matrix](#)

This test report may be reproduced in full only. The document may only be updated by MiCOM Labs personnel. Any changes will be noted in the Document History section of the report.



Title: Xirrus Inc. XI-AC1300, XI-AC867
To: FCC 47 CFR Part 15.247 & IC RSS-210
Serial #: XIRR04-U3 Rev A
Issue Date: 29th April 2014
Page: 230 of 572



POWER SPECTRAL DENSITY - AVERAGE

Variant: 802.11n HT-20, Channel: 2462.00 MHz, Chain b, Temp: Ambient, Voltage: 56 Vdc

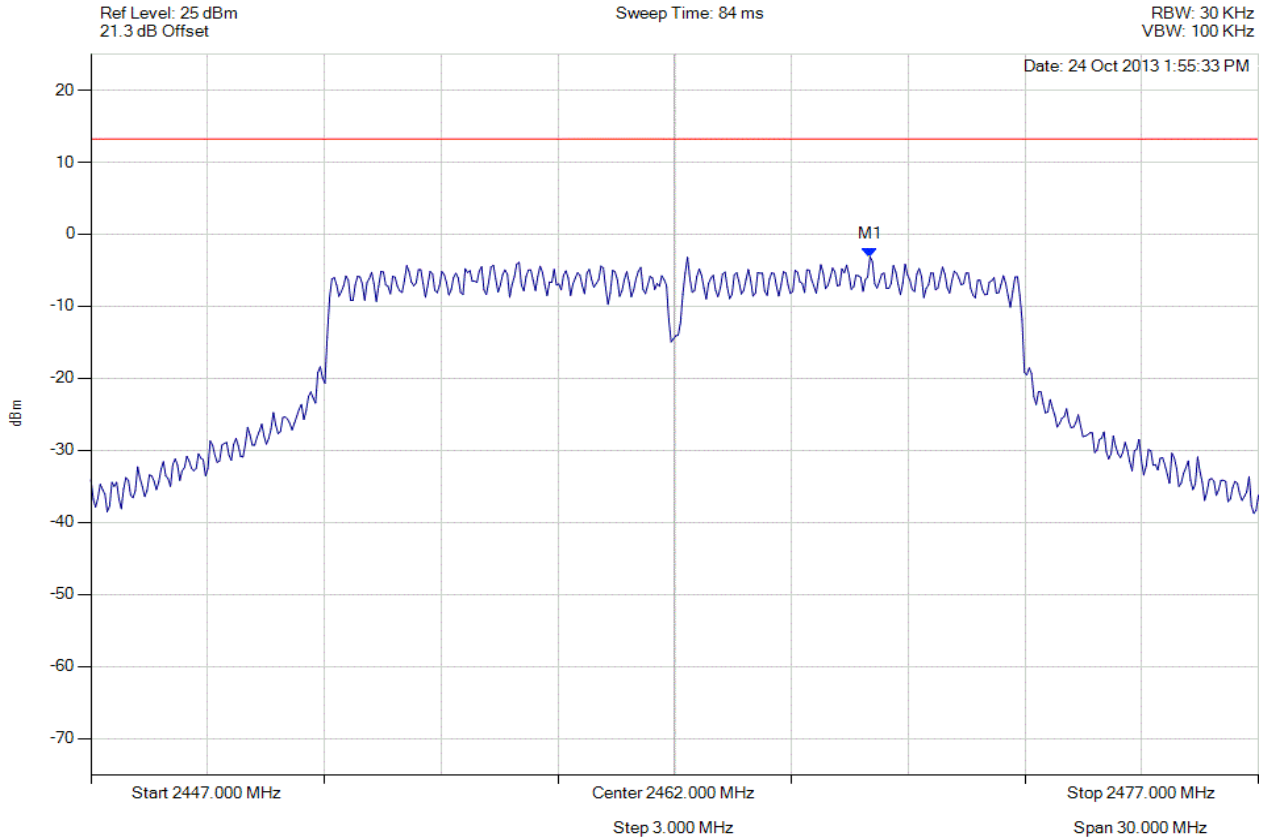

Analyser Setup	Marker : Frequency : Amplitude	Test Results
Detector = AVERAGE Sweep Count = 0 RF Atten (dB) = 20 Trace Mode = VIEW	M1 : 2467.020 MHz : -3.114 dBm	Limit: ≤ 13.229 dBm Margin: -16.34 dB

[Back to the Matrix](#)

This test report may be reproduced in full only. The document may only be updated by MiCOM Labs personnel. Any changes will be noted in the Document History section of the report.



Title: Xirrus Inc. XI-AC1300, XI-AC867
To: FCC 47 CFR Part 15.247 & IC RSS-210
Serial #: XIRR04-U3 Rev A
Issue Date: 29th April 2014
Page: 231 of 572



POWER SPECTRAL DENSITY - AVERAGE

Variant: 802.11n HT-20, Channel: 2462.00 MHz, Chain c, Temp: Ambient, Voltage: 56 Vdc

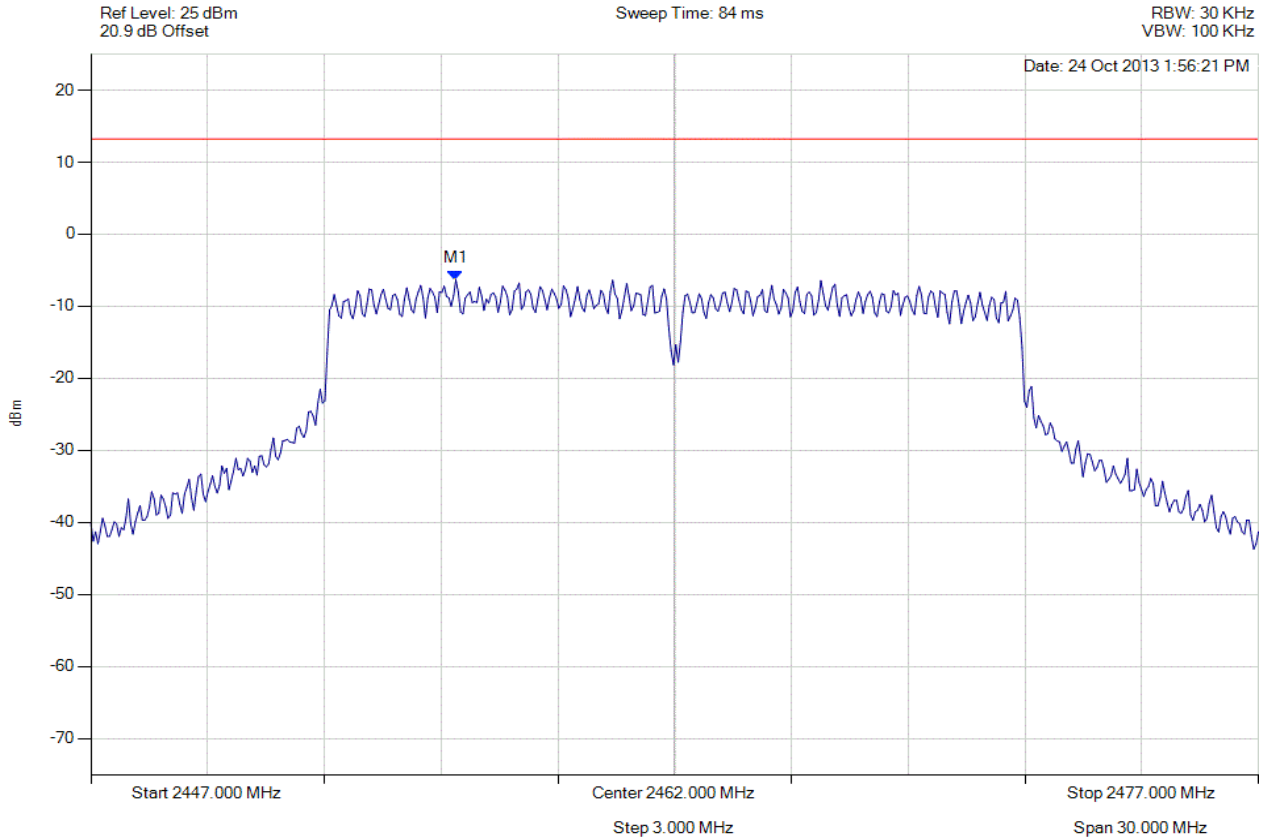

Analyser Setup	Marker : Frequency : Amplitude	Test Results
Detector = AVERAGE Sweep Count = 0 RF Atten (dB) = 20 Trace Mode = VIEW	M1 : 2456.379 MHz : -6.348 dBm	Limit: ≤ 13.229 dBm Margin: -19.58 dB

[Back to the Matrix](#)

This test report may be reproduced in full only. The document may only be updated by MiCOM Labs personnel. Any changes will be noted in the Document History section of the report.



Title: Xirrus Inc. XI-AC1300, XI-AC867
To: FCC 47 CFR Part 15.247 & IC RSS-210
Serial #: XIRR04-U3 Rev A
Issue Date: 29th April 2014
Page: 232 of 572



POWER SPECTRAL DENSITY - AVERAGE

Variant: 802.11n HT-40, Channel: 2422.00 MHz, Chain a, Temp: Ambient, Voltage: 56 Vdc

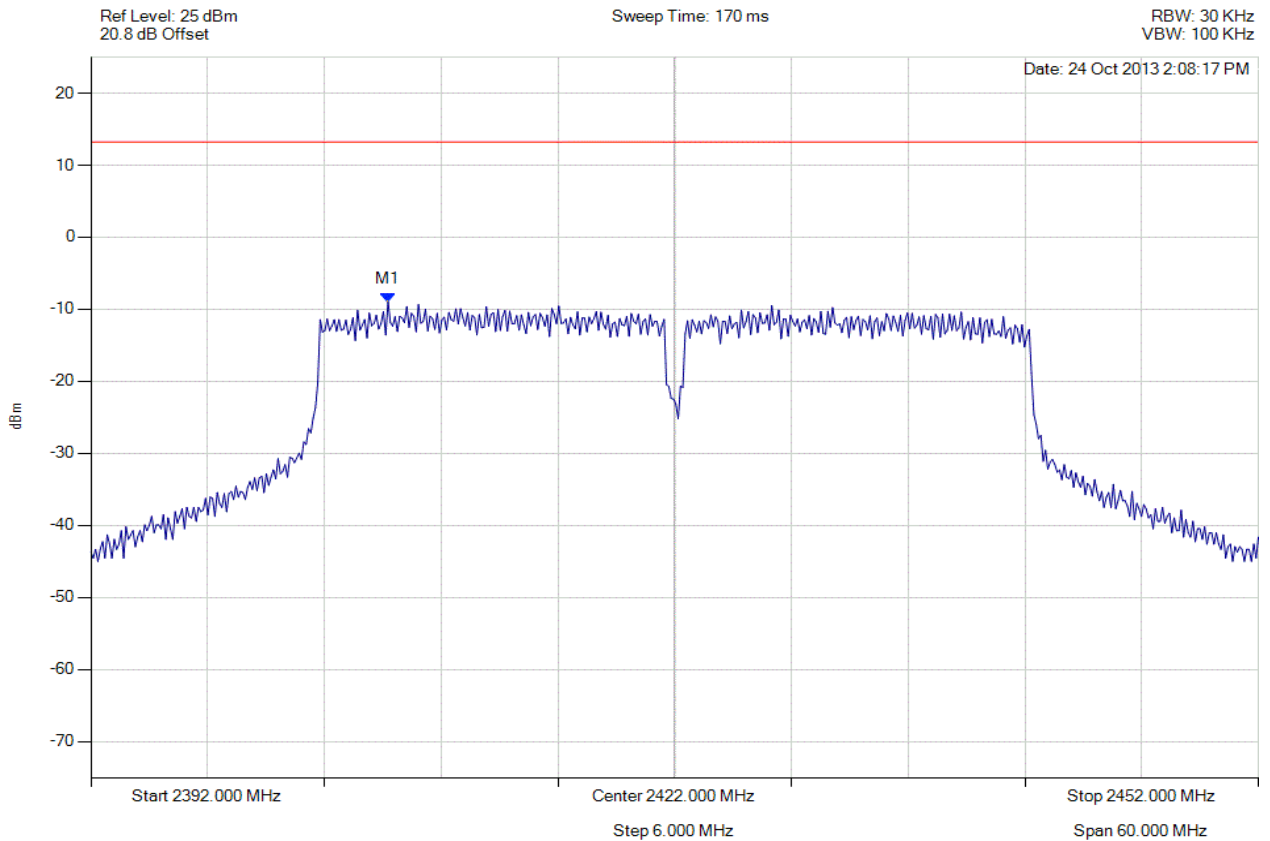

Analyser Setup	Marker : Frequency : Amplitude	Test Results
Detector = AVERAGE Sweep Count = 0 RF Atten (dB) = 20 Trace Mode = VIEW	M1 : 2407.271 MHz : -8.953 dBm	Limit: ≤ 13.229 dBm Margin: -22.18 dB

[Back to the Matrix](#)

This test report may be reproduced in full only. The document may only be updated by MiCOM Labs personnel. Any changes will be noted in the Document History section of the report.



Title: Xirrus Inc. XI-AC1300, XI-AC867
To: FCC 47 CFR Part 15.247 & IC RSS-210
Serial #: XIRR04-U3 Rev A
Issue Date: 29th April 2014
Page: 233 of 572



POWER SPECTRAL DENSITY - AVERAGE

Variant: 802.11n HT-40, Channel: 2422.00 MHz, Chain b, Temp: Ambient, Voltage: 56 Vdc

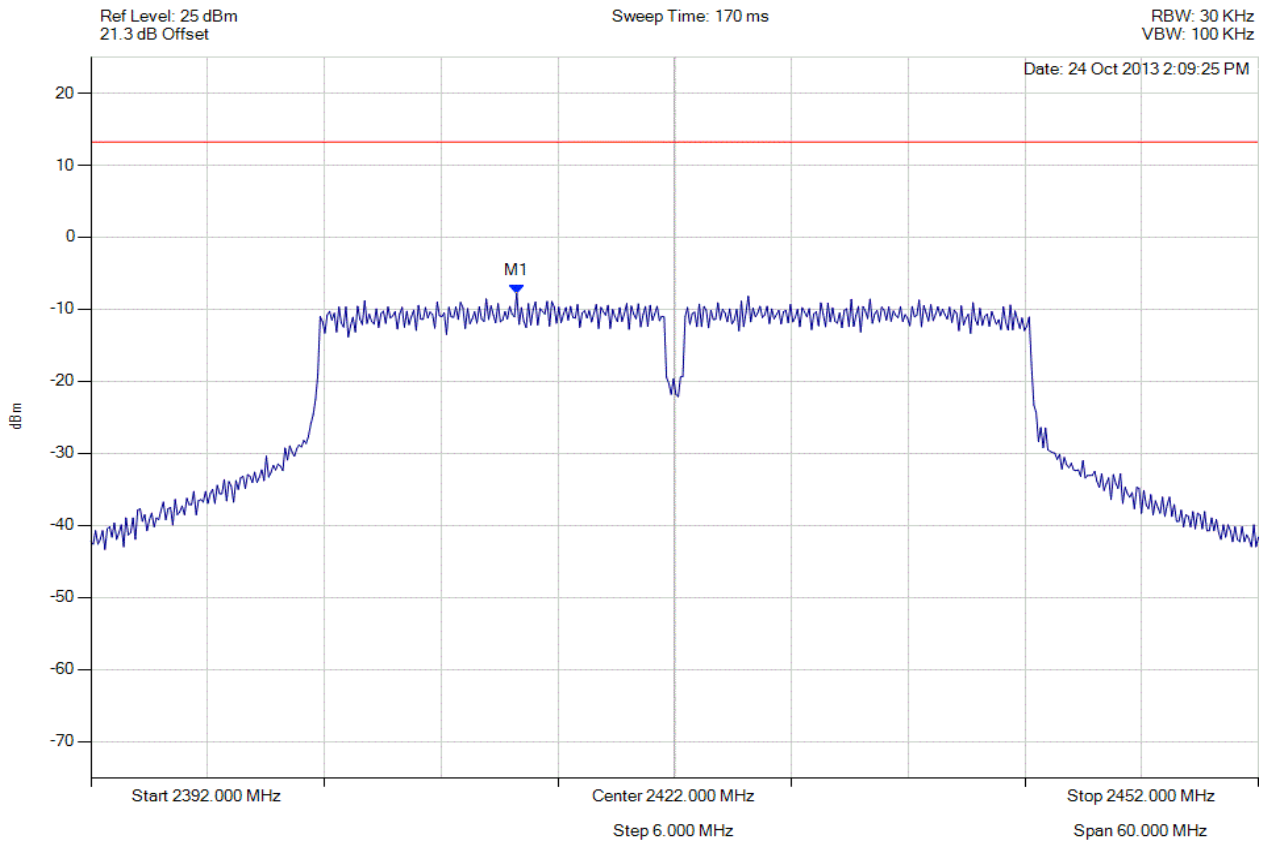

Analyser Setup	Marker : Frequency : Amplitude	Test Results
Detector = AVERAGE Sweep Count = 0 RF Atten (dB) = 20 Trace Mode = VIEW	M1 : 2413.884 MHz : -7.787 dBm	Limit: ≤ 13.229 dBm Margin: -21.02 dB

[Back to the Matrix](#)

This test report may be reproduced in full only. The document may only be updated by MiCOM Labs personnel. Any changes will be noted in the Document History section of the report.



Title: Xirrus Inc. XI-AC1300, XI-AC867
To: FCC 47 CFR Part 15.247 & IC RSS-210
Serial #: XIRR04-U3 Rev A
Issue Date: 29th April 2014
Page: 234 of 572



POWER SPECTRAL DENSITY - AVERAGE

Variant: 802.11n HT-40, Channel: 2422.00 MHz, Chain c, Temp: Ambient, Voltage: 56 Vdc

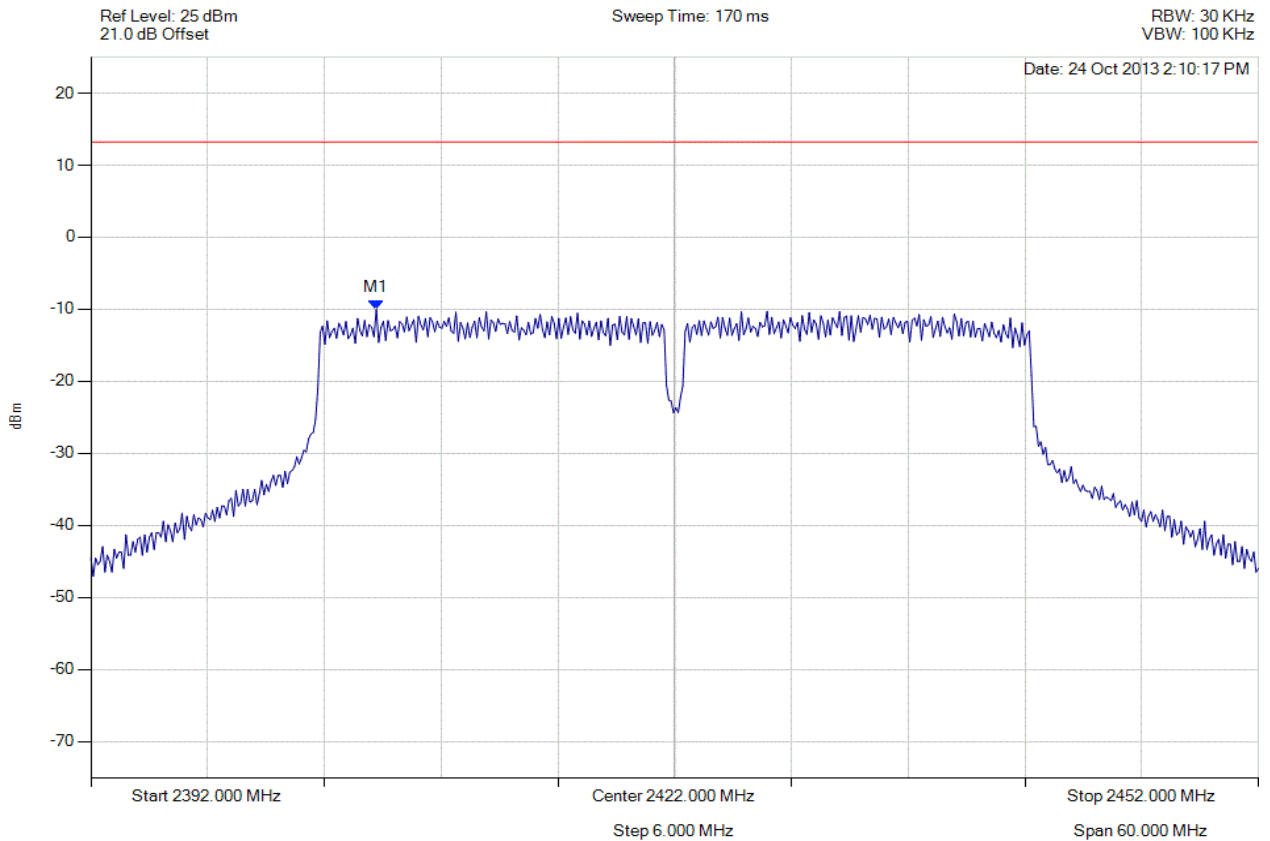

Analyser Setup	Marker : Frequency : Amplitude	Test Results
Detector = AVERAGE Sweep Count = 0 RF Atten (dB) = 20 Trace Mode = VIEW	M1 : 2406.669 MHz : -10.027 dBm	Limit: ≤ 13.229 dBm Margin: -23.26 dB

[Back to the Matrix](#)

This test report may be reproduced in full only. The document may only be updated by MiCOM Labs personnel. Any changes will be noted in the Document History section of the report.



Title: Xirrus Inc. XI-AC1300, XI-AC867
To: FCC 47 CFR Part 15.247 & IC RSS-210
Serial #: XIRR04-U3 Rev A
Issue Date: 29th April 2014
Page: 235 of 572



POWER SPECTRAL DENSITY - AVERAGE

Variant: 802.11n HT-40, Channel: 2437.00 MHz, Chain a, Temp: Ambient, Voltage: 56 Vdc

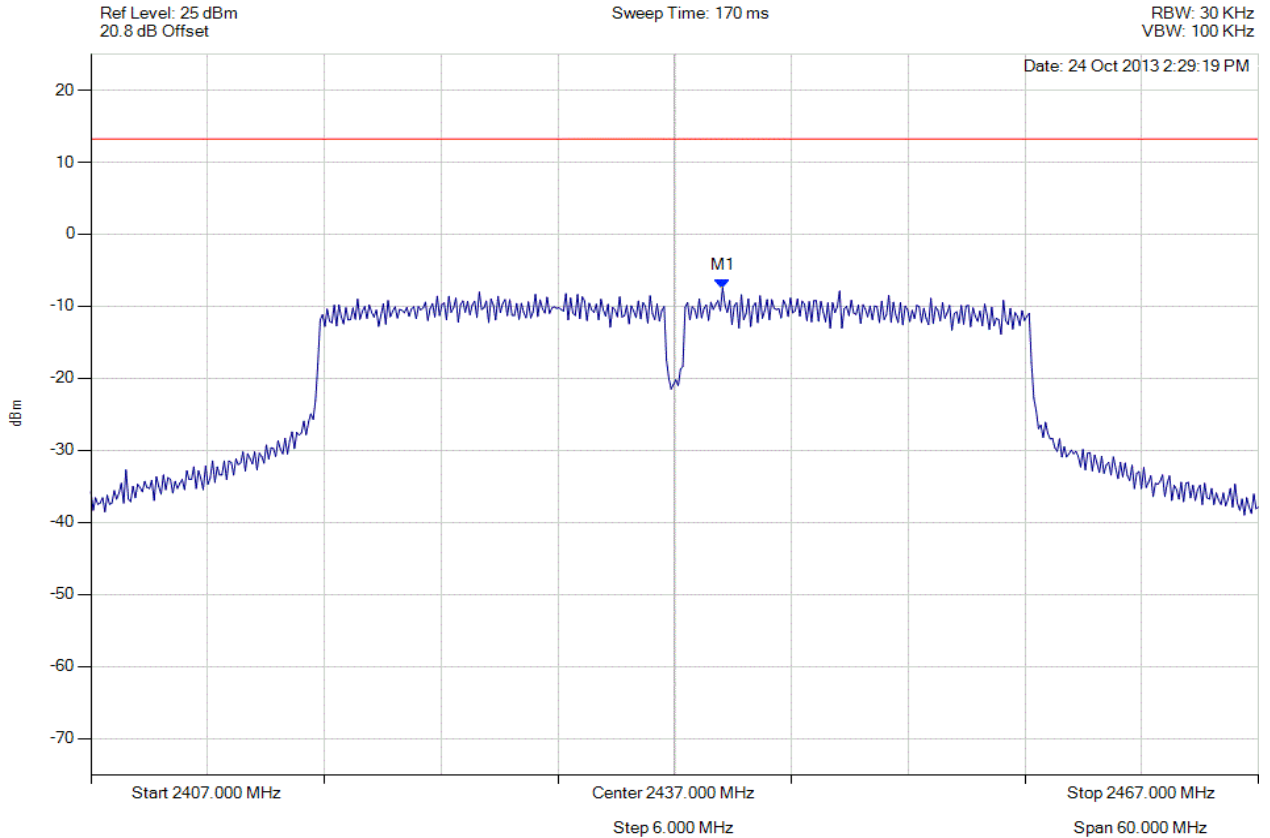

Analyser Setup	Marker : Frequency : Amplitude	Test Results
Detector = AVERAGE Sweep Count = 0 RF Atten (dB) = 20 Trace Mode = VIEW	M1 : 2439.465 MHz : -7.459 dBm	Limit: ≤ 13.229 dBm Margin: -20.69 dB

[Back to the Matrix](#)

This test report may be reproduced in full only. The document may only be updated by MiCOM Labs personnel. Any changes will be noted in the Document History section of the report.



Title: Xirrus Inc. XI-AC1300, XI-AC867
To: FCC 47 CFR Part 15.247 & IC RSS-210
Serial #: XIRR04-U3 Rev A
Issue Date: 29th April 2014
Page: 236 of 572



POWER SPECTRAL DENSITY - AVERAGE

Variant: 802.11n HT-40, Channel: 2437.00 MHz, Chain b, Temp: Ambient, Voltage: 56 Vdc

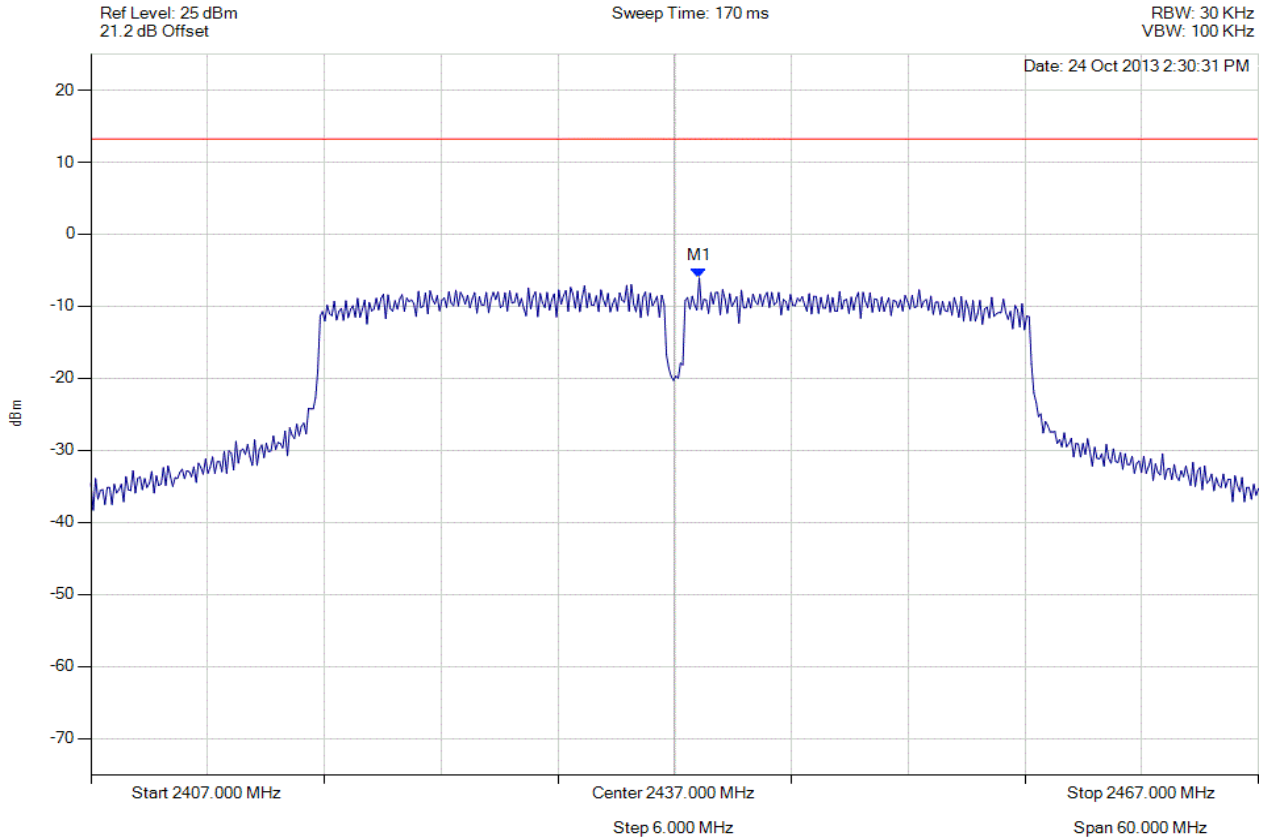

Analyser Setup	Marker : Frequency : Amplitude	Test Results
Detector = AVERAGE Sweep Count = 0 RF Atten (dB) = 20 Trace Mode = VIEW	M1 : 2438.263 MHz : -6.080 dBm	Limit: ≤ 13.229 dBm Margin: -19.31 dB

[Back to the Matrix](#)

This test report may be reproduced in full only. The document may only be updated by MiCOM Labs personnel. Any changes will be noted in the Document History section of the report.



Title: Xirrus Inc. XI-AC1300, XI-AC867
To: FCC 47 CFR Part 15.247 & IC RSS-210
Serial #: XIRR04-U3 Rev A
Issue Date: 29th April 2014
Page: 237 of 572



POWER SPECTRAL DENSITY - AVERAGE

Variant: 802.11n HT-40, Channel: 2437.00 MHz, Chain c, Temp: Ambient, Voltage: 56 Vdc

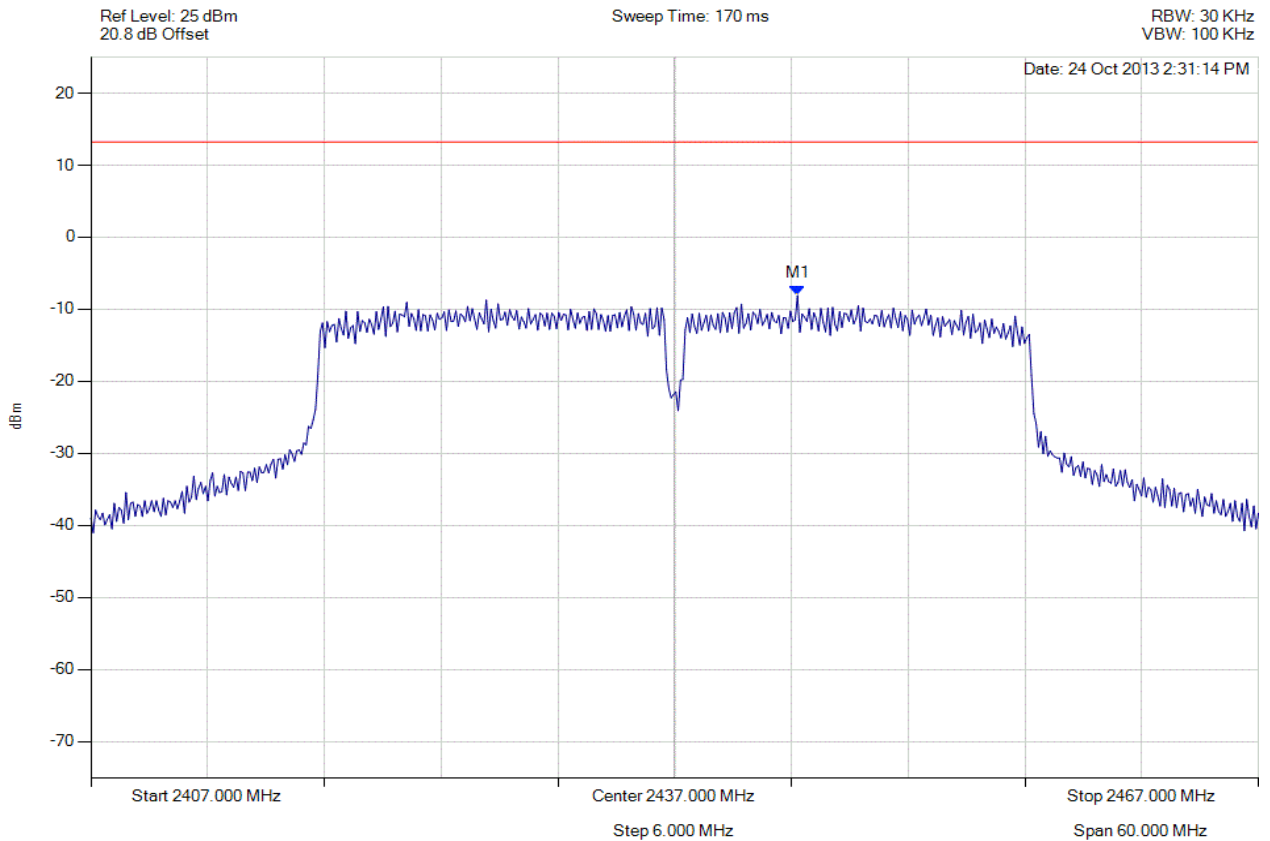

Analyser Setup	Marker : Frequency : Amplitude	Test Results
Detector = AVERAGE Sweep Count = 0 RF Atten (dB) = 20 Trace Mode = VIEW	M1 : 2443.313 MHz : -8.095 dBm	Limit: ≤ 13.229 dBm Margin: -21.33 dB

[Back to the Matrix](#)

This test report may be reproduced in full only. The document may only be updated by MiCOM Labs personnel. Any changes will be noted in the Document History section of the report.



Title: Xirrus Inc. XI-AC1300, XI-AC867
To: FCC 47 CFR Part 15.247 & IC RSS-210
Serial #: XIRR04-U3 Rev A
Issue Date: 29th April 2014
Page: 238 of 572



POWER SPECTRAL DENSITY - AVERAGE

Variation: 802.11n HT-40, Channel: 2452.00 MHz, Chain a, Temp: Ambient, Voltage: 56 Vdc

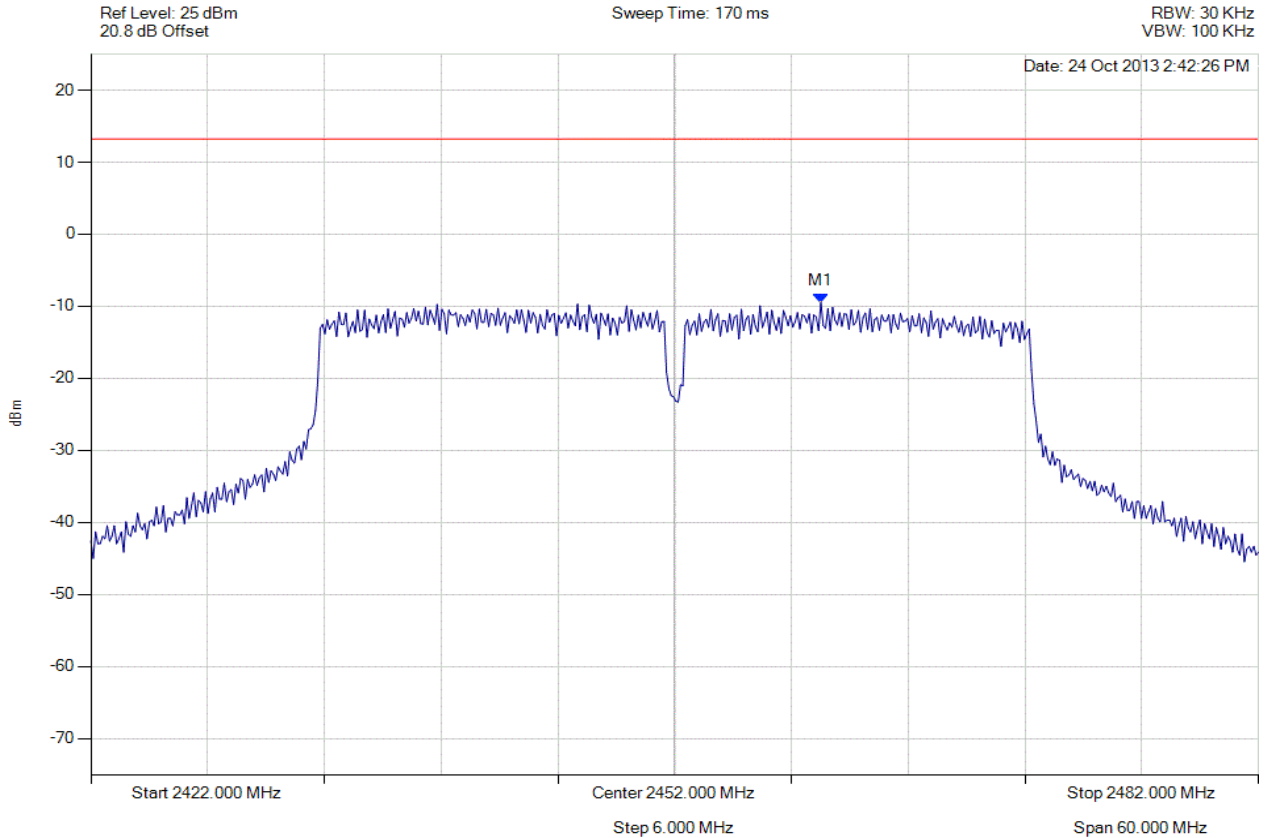

Analyser Setup	Marker : Frequency : Amplitude	Test Results
Detector = AVERAGE Sweep Count = 0 RF Atten (dB) = 20 Trace Mode = VIEW	M1 : 2459.515 MHz : -9.511 dBm	Limit: ≤ 13.229 dBm Margin: -22.74 dB

[Back to the Matrix](#)

This test report may be reproduced in full only. The document may only be updated by MiCOM Labs personnel. Any changes will be noted in the Document History section of the report.



Title: Xirrus Inc. XI-AC1300, XI-AC867
To: FCC 47 CFR Part 15.247 & IC RSS-210
Serial #: XIRR04-U3 Rev A
Issue Date: 29th April 2014
Page: 239 of 572



POWER SPECTRAL DENSITY - AVERAGE

Variant: 802.11n HT-40, Channel: 2452.00 MHz, Chain b, Temp: Ambient, Voltage: 56 Vdc

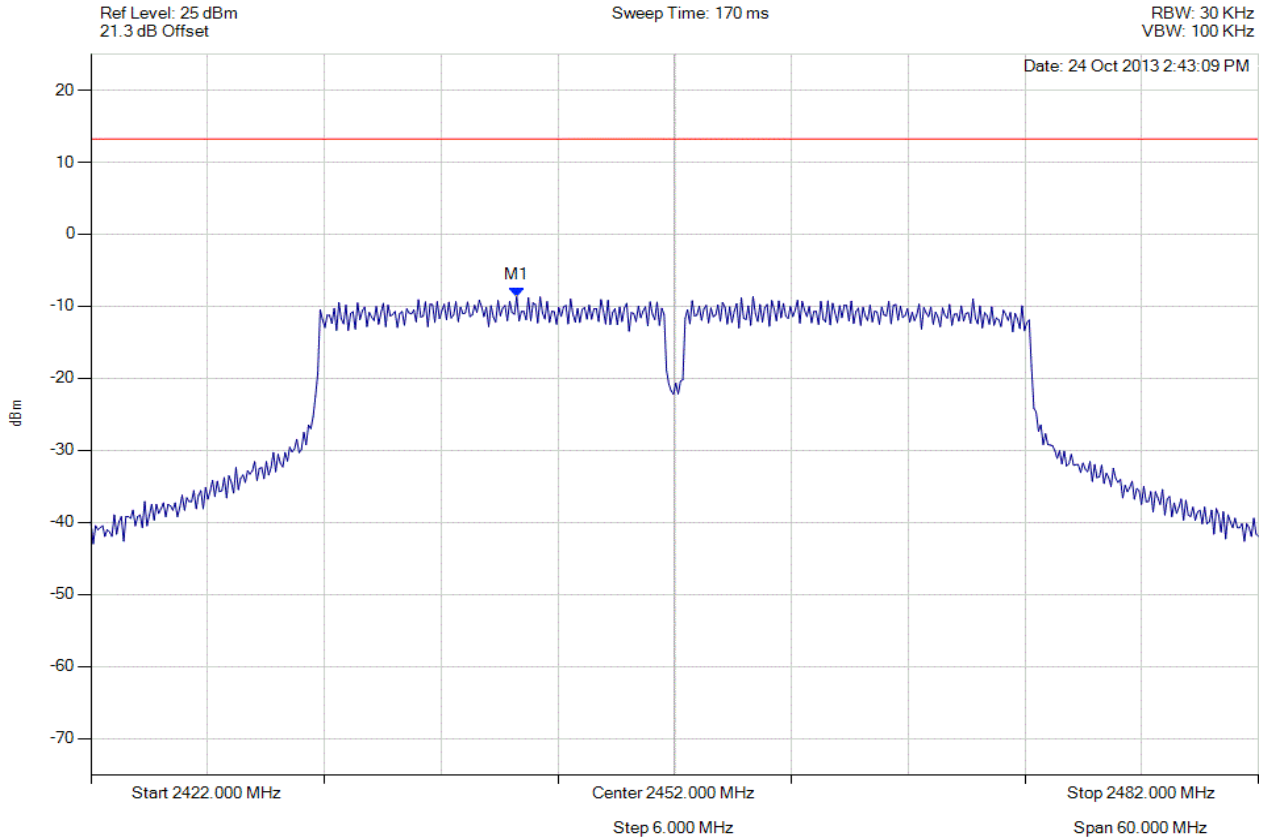

Analyser Setup	Marker : Frequency : Amplitude	Test Results
Detector = AVERAGE Sweep Count = 0 RF Atten (dB) = 20 Trace Mode = VIEW	M1 : 2443.884 MHz : -8.676 dBm	Limit: ≤ 13.229 dBm Margin: -21.91 dB

[Back to the Matrix](#)

This test report may be reproduced in full only. The document may only be updated by MiCOM Labs personnel. Any changes will be noted in the Document History section of the report.



Title: Xirrus Inc. XI-AC1300, XI-AC867
To: FCC 47 CFR Part 15.247 & IC RSS-210
Serial #: XIRR04-U3 Rev A
Issue Date: 29th April 2014
Page: 240 of 572



POWER SPECTRAL DENSITY - AVERAGE

Variant: 802.11n HT-40, Channel: 2452.00 MHz, Chain c, Temp: Ambient, Voltage: 56 Vdc

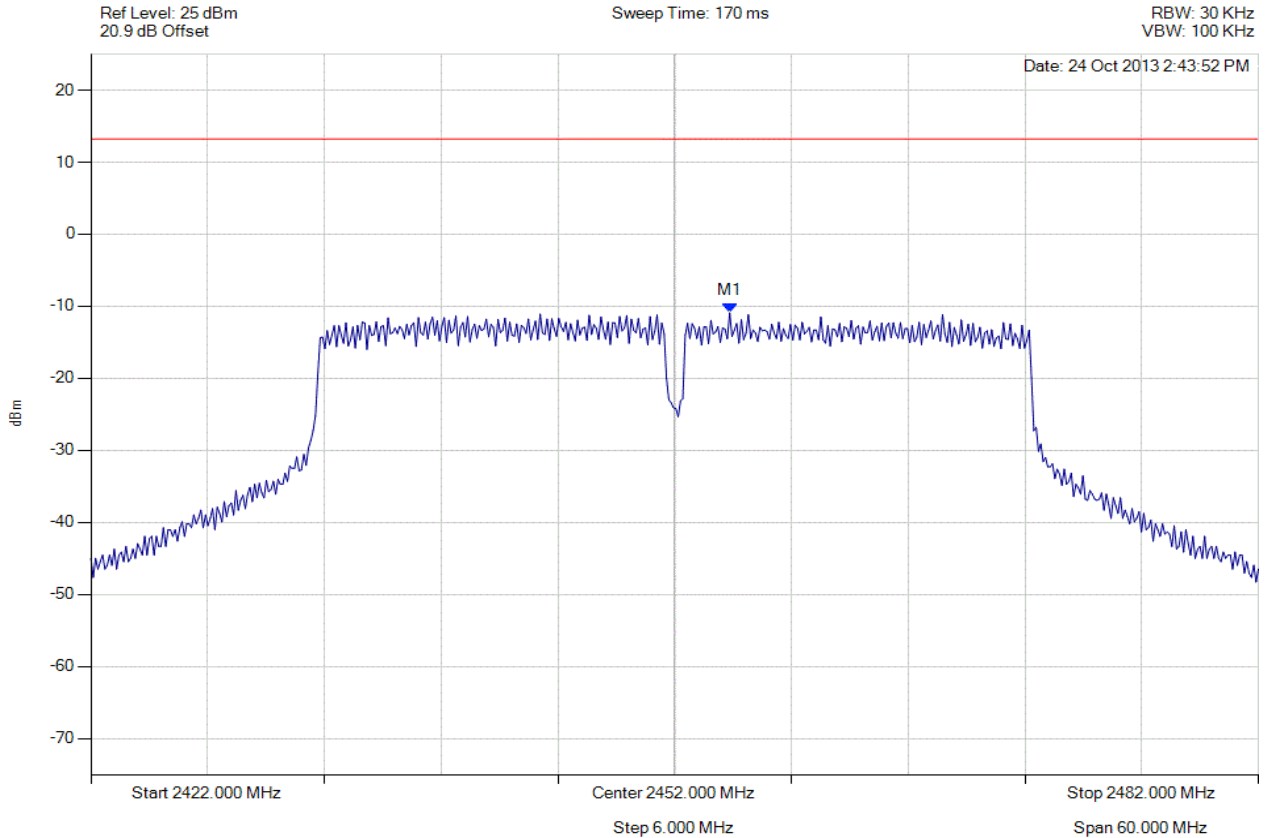

Analyser Setup	Marker : Frequency : Amplitude	Test Results
Detector = AVERAGE Sweep Count = 0 RF Atten (dB) = 20 Trace Mode = VIEW	M1 : 2454.826 MHz : -10.920 dBm	Limit : ≤ 13.229 dBm Margin : -24.15 dB

[Back to the Matrix](#)

This test report may be reproduced in full only. The document may only be updated by MiCOM Labs personnel. Any changes will be noted in the Document History section of the report.



Title: Xirrus Inc. XI-AC1300, XI-AC867
To: FCC 47 CFR Part 15.247 & IC RSS-210
Serial #: XIRR04-U3 Rev A
Issue Date: 29th April 2014
Page: 241 of 572



POWER SPECTRAL DENSITY - AVERAGE

Variant: 802.11a, Channel: 5745.00 MHz, Chain a, Temp: Ambient, Voltage: 56 Vdc

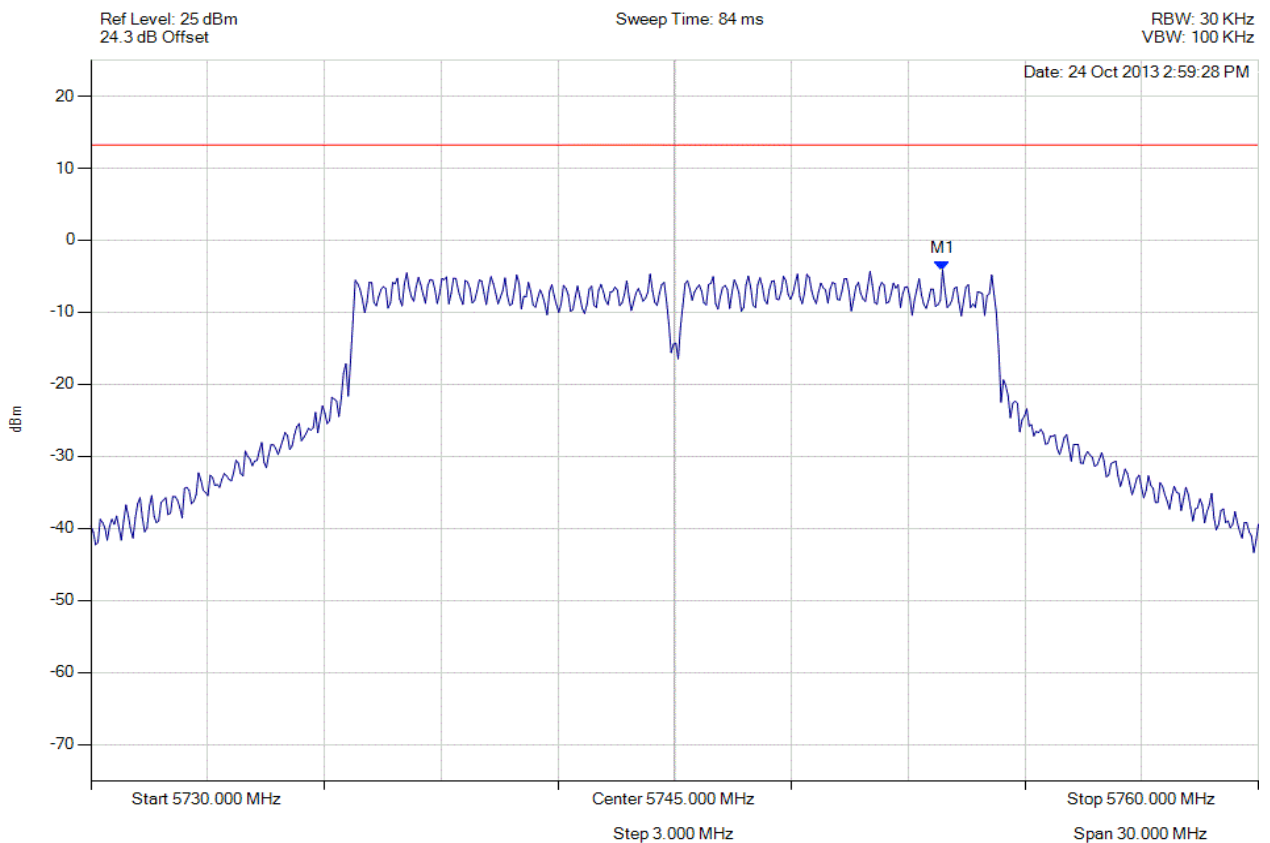

Analyser Setup	Marker : Frequency : Amplitude	Test Results
Detector = AVERAGE Sweep Count = 0 RF Atten (dB) = 20 Trace Mode = VIEW	M1 : 5751.884 MHz : -4.138 dBm	Limit: ≤ 13.229 dBm Margin: -17.37 dB

[Back to the Matrix](#)

This test report may be reproduced in full only. The document may only be updated by MiCOM Labs personnel. Any changes will be noted in the Document History section of the report.



Title: Xirrus Inc. XI-AC1300, XI-AC867
To: FCC 47 CFR Part 15.247 & IC RSS-210
Serial #: XIRR04-U3 Rev A
Issue Date: 29th April 2014
Page: 242 of 572



POWER SPECTRAL DENSITY - AVERAGE

Variant: 802.11a, Channel: 5745.00 MHz, Chain b, Temp: Ambient, Voltage: 56 Vdc

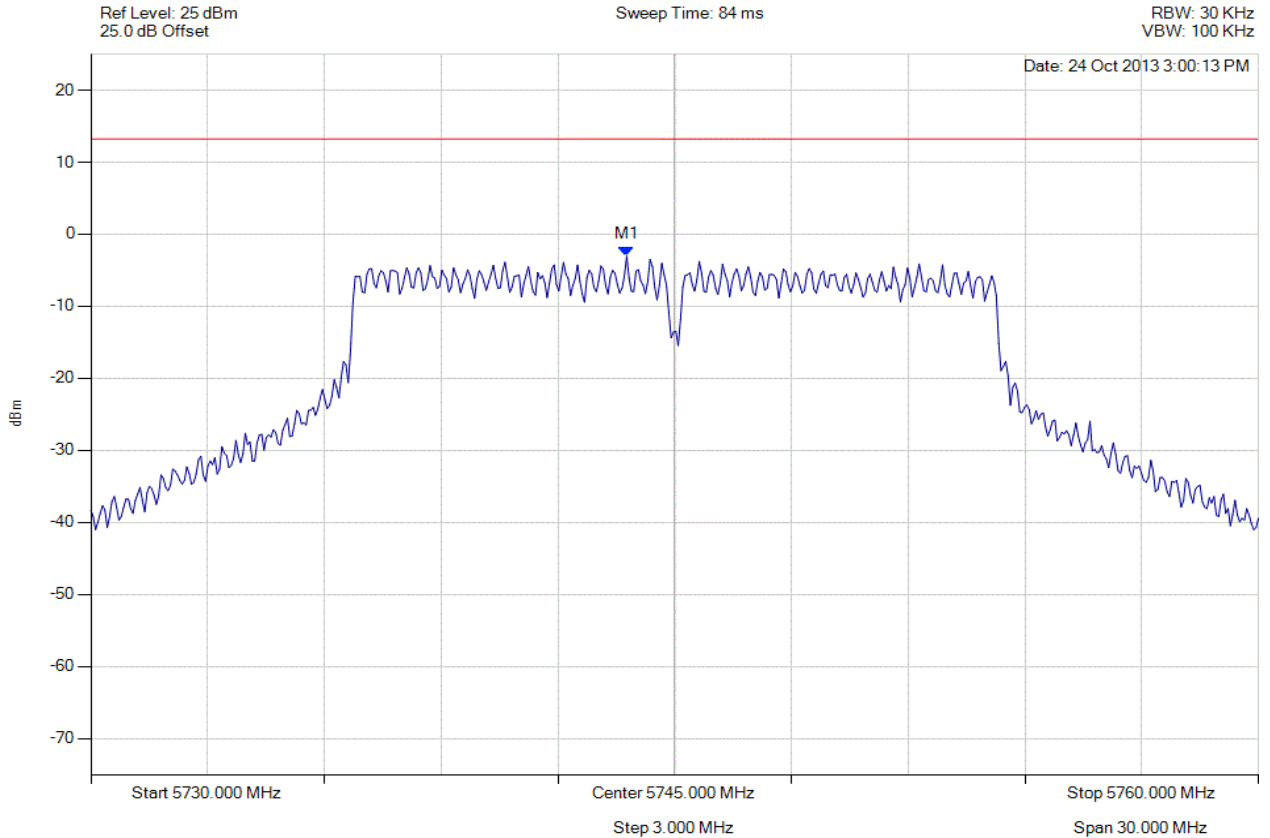

Analyser Setup	Marker : Frequency : Amplitude	Test Results
Detector = AVERAGE Sweep Count = 0 RF Atten (dB) = 20 Trace Mode = VIEW	M1 : 5743.768 MHz : -3.045 dBm	Limit: \leq 13.229 dBm Margin: -16.27 dB

[Back to the Matrix](#)

This test report may be reproduced in full only. The document may only be updated by MiCOM Labs personnel. Any changes will be noted in the Document History section of the report.



Title: Xirrus Inc. XI-AC1300, XI-AC867
To: FCC 47 CFR Part 15.247 & IC RSS-210
Serial #: XIRR04-U3 Rev A
Issue Date: 29th April 2014
Page: 243 of 572



POWER SPECTRAL DENSITY - AVERAGE

Variant: 802.11a, Channel: 5745.00 MHz, Chain c, Temp: Ambient, Voltage: 56 Vdc

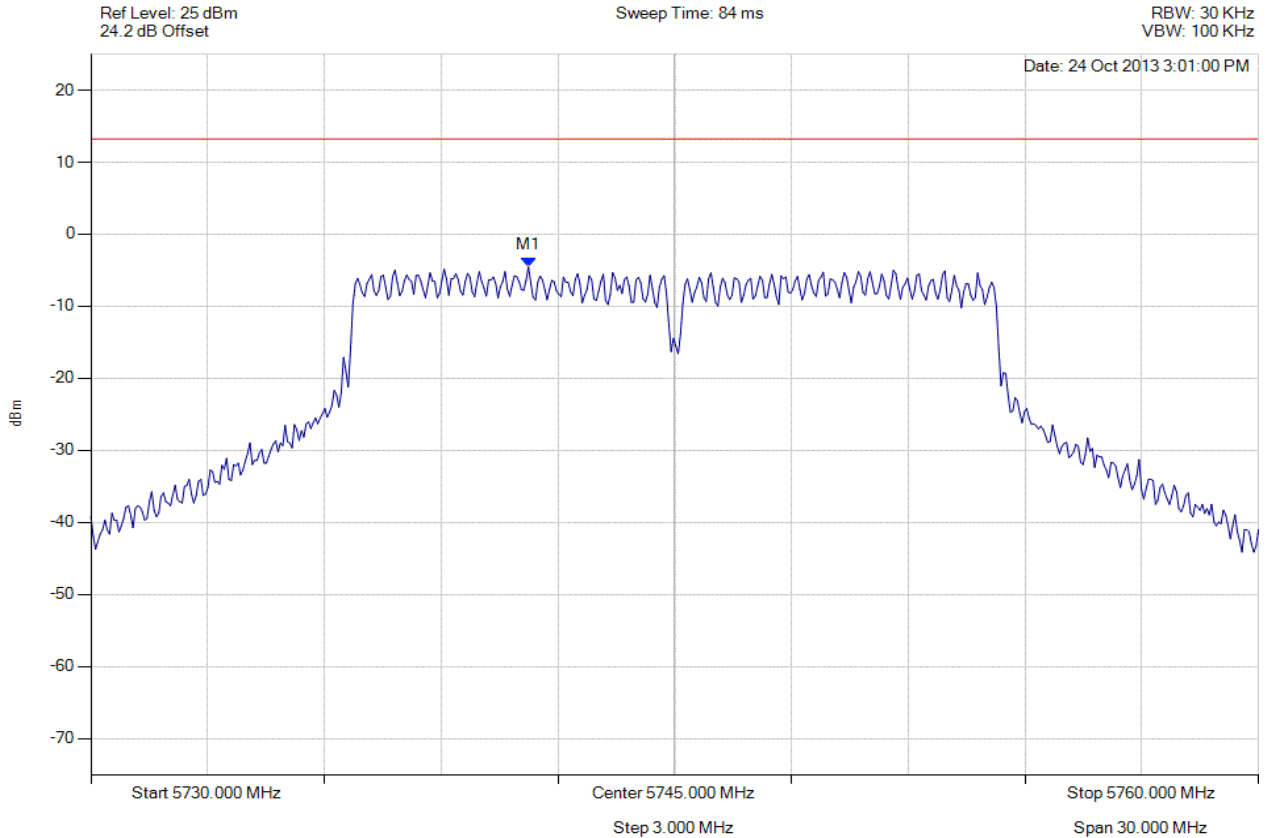

Analyser Setup	Marker : Frequency : Amplitude	Test Results
Detector = AVERAGE Sweep Count = 0 RF Atten (dB) = 20 Trace Mode = VIEW	M1 : 5741.242 MHz : -4.527 dBm	Limit: ≤ 13.229 dBm Margin: -17.76 dB

[Back to the Matrix](#)

This test report may be reproduced in full only. The document may only be updated by MiCOM Labs personnel. Any changes will be noted in the Document History section of the report.



Title: Xirrus Inc. XI-AC1300, XI-AC867
To: FCC 47 CFR Part 15.247 & IC RSS-210
Serial #: XIRR04-U3 Rev A
Issue Date: 29th April 2014
Page: 244 of 572



POWER SPECTRAL DENSITY - AVERAGE

Variant: 802.11a, Channel: 5785.00 MHz, Chain a, Temp: Ambient, Voltage: 56 Vdc

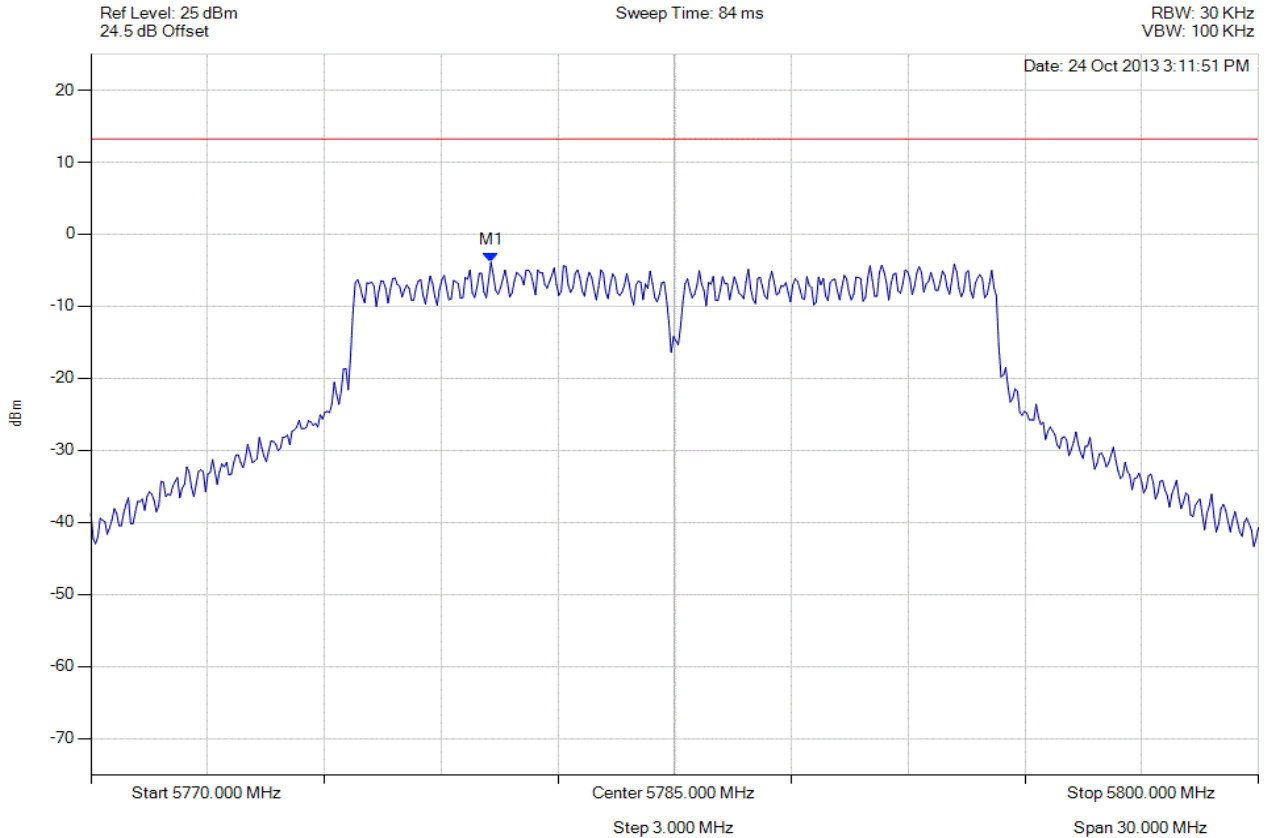

Analyser Setup	Marker : Frequency : Amplitude	Test Results
Detector = AVERAGE Sweep Count = 0 RF Atten (dB) = 20 Trace Mode = VIEW	M1 : 5780.281 MHz : -3.880 dBm	Limit: ≤ 13.229 dBm Margin: -17.11 dB

[Back to the Matrix](#)

This test report may be reproduced in full only. The document may only be updated by MiCOM Labs personnel. Any changes will be noted in the Document History section of the report.



Title: Xirrus Inc. XI-AC1300, XI-AC867
To: FCC 47 CFR Part 15.247 & IC RSS-210
Serial #: XIRR04-U3 Rev A
Issue Date: 29th April 2014
Page: 245 of 572



POWER SPECTRAL DENSITY - AVERAGE

Variant: 802.11a, Channel: 5785.00 MHz, Chain b, Temp: Ambient, Voltage: 56 Vdc

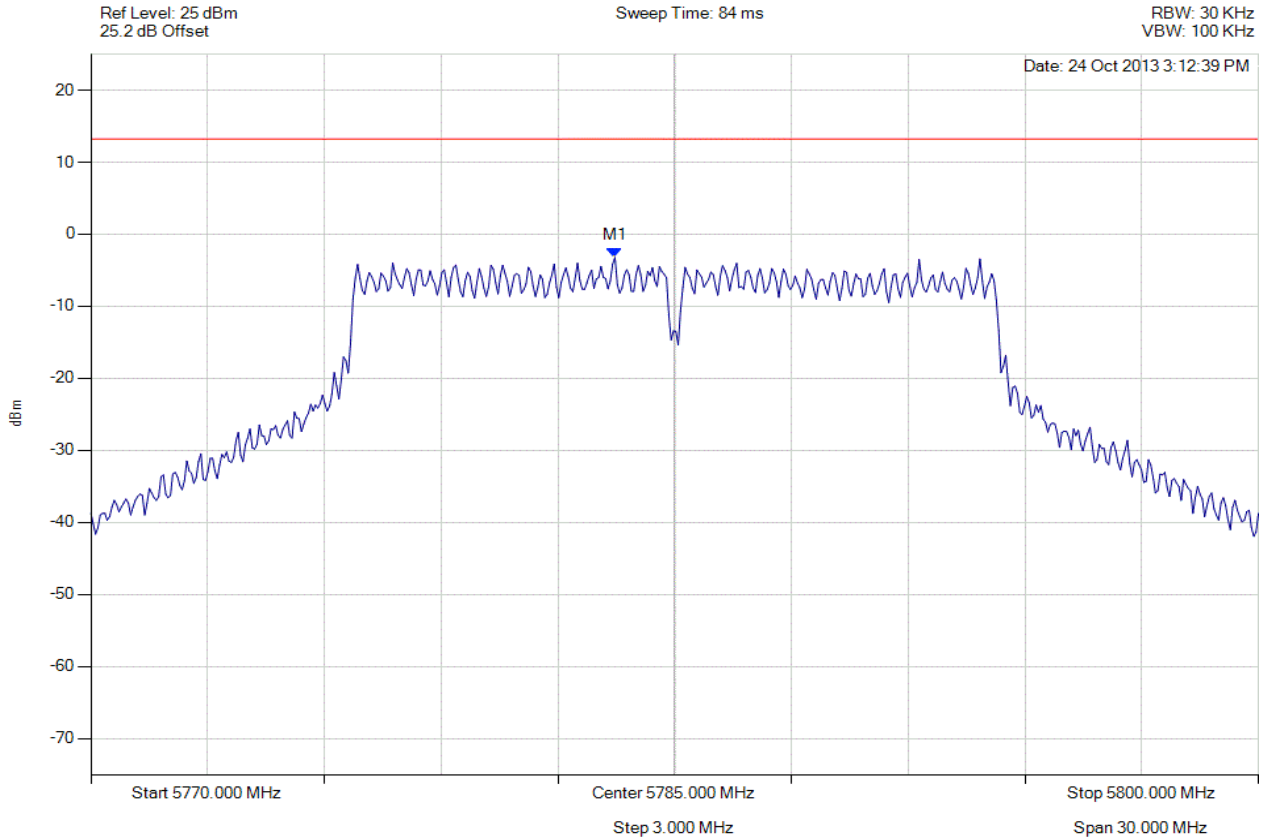

Analyser Setup	Marker : Frequency : Amplitude	Test Results
Detector = AVERAGE Sweep Count = 0 RF Atten (dB) = 20 Trace Mode = VIEW	M1 : 5783.467 MHz : -3.233 dBm	Limit: ≤ 13.229 dBm Margin: -16.46 dB

[Back to the Matrix](#)

This test report may be reproduced in full only. The document may only be updated by MiCOM Labs personnel. Any changes will be noted in the Document History section of the report.



Title: Xirrus Inc. XI-AC1300, XI-AC867
To: FCC 47 CFR Part 15.247 & IC RSS-210
Serial #: XIRR04-U3 Rev A
Issue Date: 29th April 2014
Page: 246 of 572



POWER SPECTRAL DENSITY - AVERAGE

Variant: 802.11a, Channel: 5785.00 MHz, Chain c, Temp: Ambient, Voltage: 56 Vdc

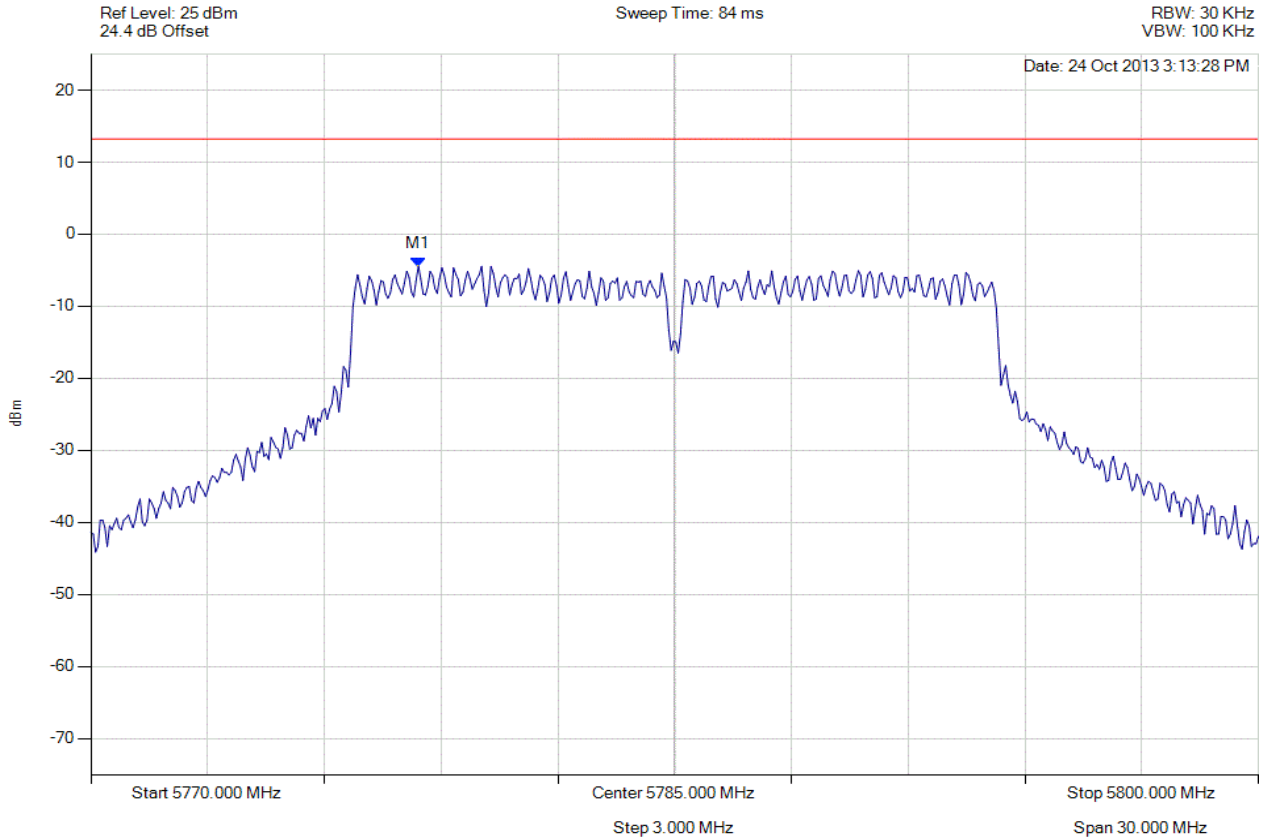

Analyser Setup	Marker : Frequency : Amplitude	Test Results
Detector = AVERAGE Sweep Count = 0 RF Atten (dB) = 20 Trace Mode = VIEW	M1 : 5778.417 MHz : -4.454 dBm	Limit: ≤ 13.229 dBm Margin: -17.68 dB

[Back to the Matrix](#)

This test report may be reproduced in full only. The document may only be updated by MiCOM Labs personnel. Any changes will be noted in the Document History section of the report.



Title: Xirrus Inc. XI-AC1300, XI-AC867
To: FCC 47 CFR Part 15.247 & IC RSS-210
Serial #: XIRR04-U3 Rev A
Issue Date: 29th April 2014
Page: 247 of 572



POWER SPECTRAL DENSITY - AVERAGE

Variant: 802.11a, Channel: 5825.00 MHz, Chain a, Temp: Ambient, Voltage: 56 Vdc

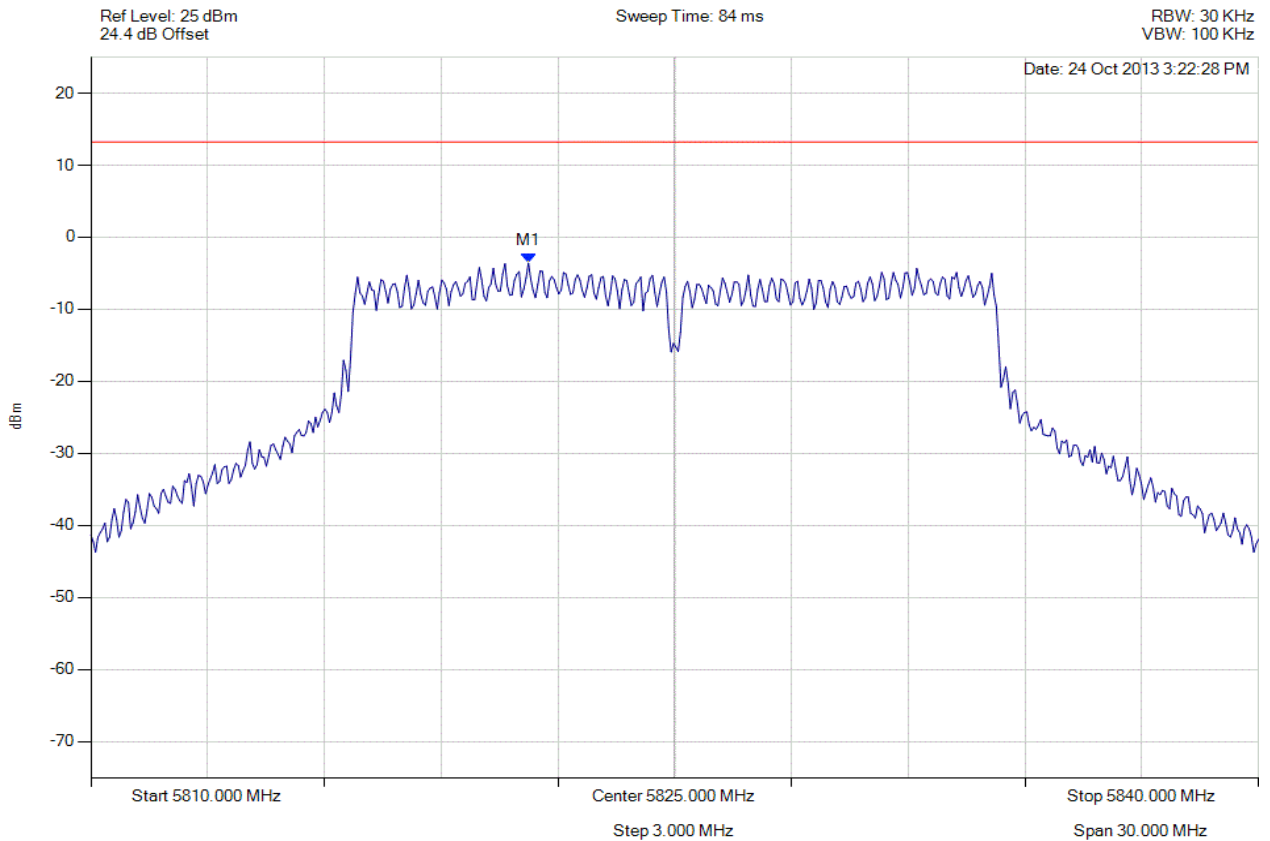

Analyser Setup	Marker : Frequency : Amplitude	Test Results
Detector = AVERAGE Sweep Count = 0 RF Atten (dB) = 20 Trace Mode = VIEW	M1 : 5821.242 MHz : -3.588 dBm	Limit: ≤ 13.229 dBm Margin: -16.82 dB

[Back to the Matrix](#)

This test report may be reproduced in full only. The document may only be updated by MiCOM Labs personnel. Any changes will be noted in the Document History section of the report.



Title: Xirrus Inc. XI-AC1300, XI-AC867
To: FCC 47 CFR Part 15.247 & IC RSS-210
Serial #: XIRR04-U3 Rev A
Issue Date: 29th April 2014
Page: 248 of 572



POWER SPECTRAL DENSITY - AVERAGE

Variant: 802.11a, Channel: 5825.00 MHz, Chain b, Temp: Ambient, Voltage: 56 Vdc

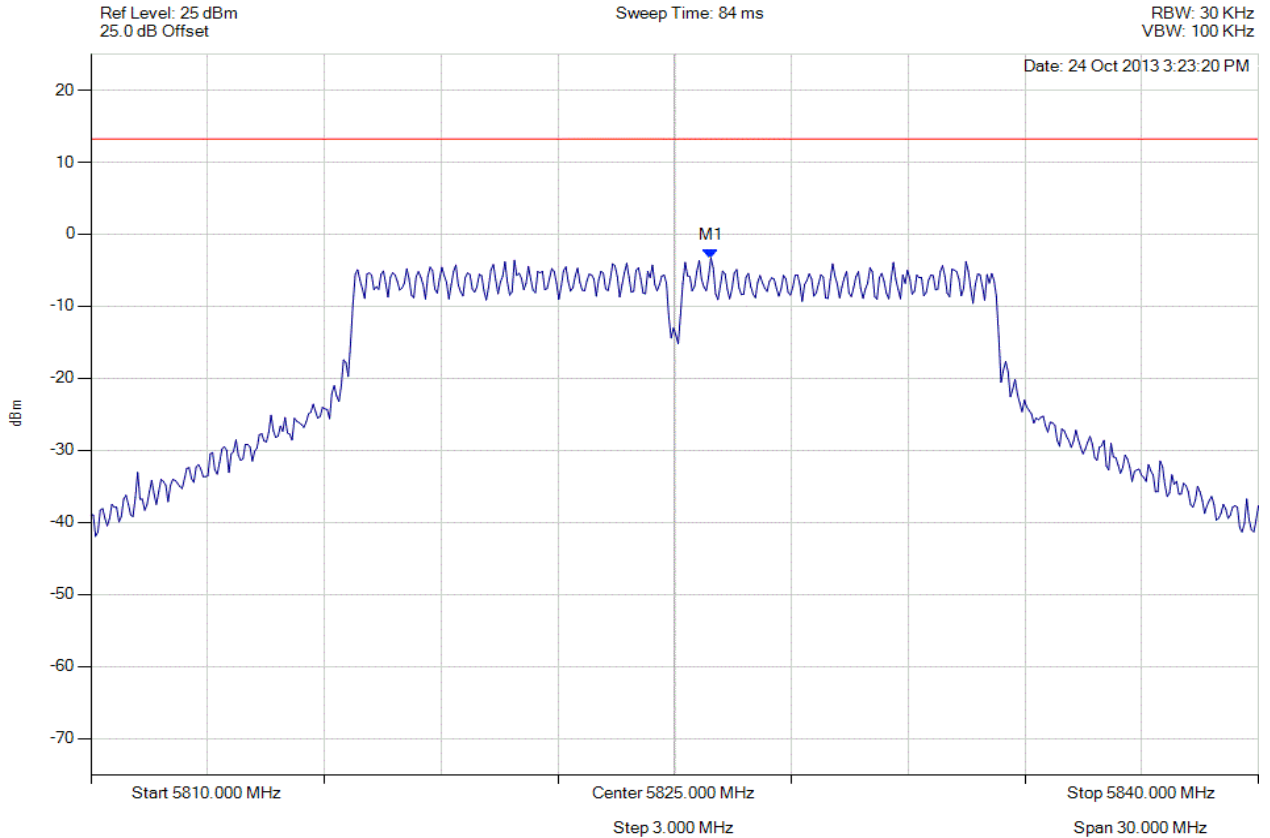

Analyser Setup	Marker : Frequency : Amplitude	Test Results
Detector = AVERAGE Sweep Count = 0 RF Atten (dB) = 20 Trace Mode = VIEW	M1 : 5825.932 MHz : -3.293 dBm	Limit: \leq 13.229 dBm Margin: -16.52 dB

[Back to the Matrix](#)

This test report may be reproduced in full only. The document may only be updated by MiCOM Labs personnel. Any changes will be noted in the Document History section of the report.



Title: Xirrus Inc. XI-AC1300, XI-AC867
To: FCC 47 CFR Part 15.247 & IC RSS-210
Serial #: XIRR04-U3 Rev A
Issue Date: 29th April 2014
Page: 249 of 572



POWER SPECTRAL DENSITY - AVERAGE

Variant: 802.11a, Channel: 5825.00 MHz, Chain c, Temp: Ambient, Voltage: 56 Vdc

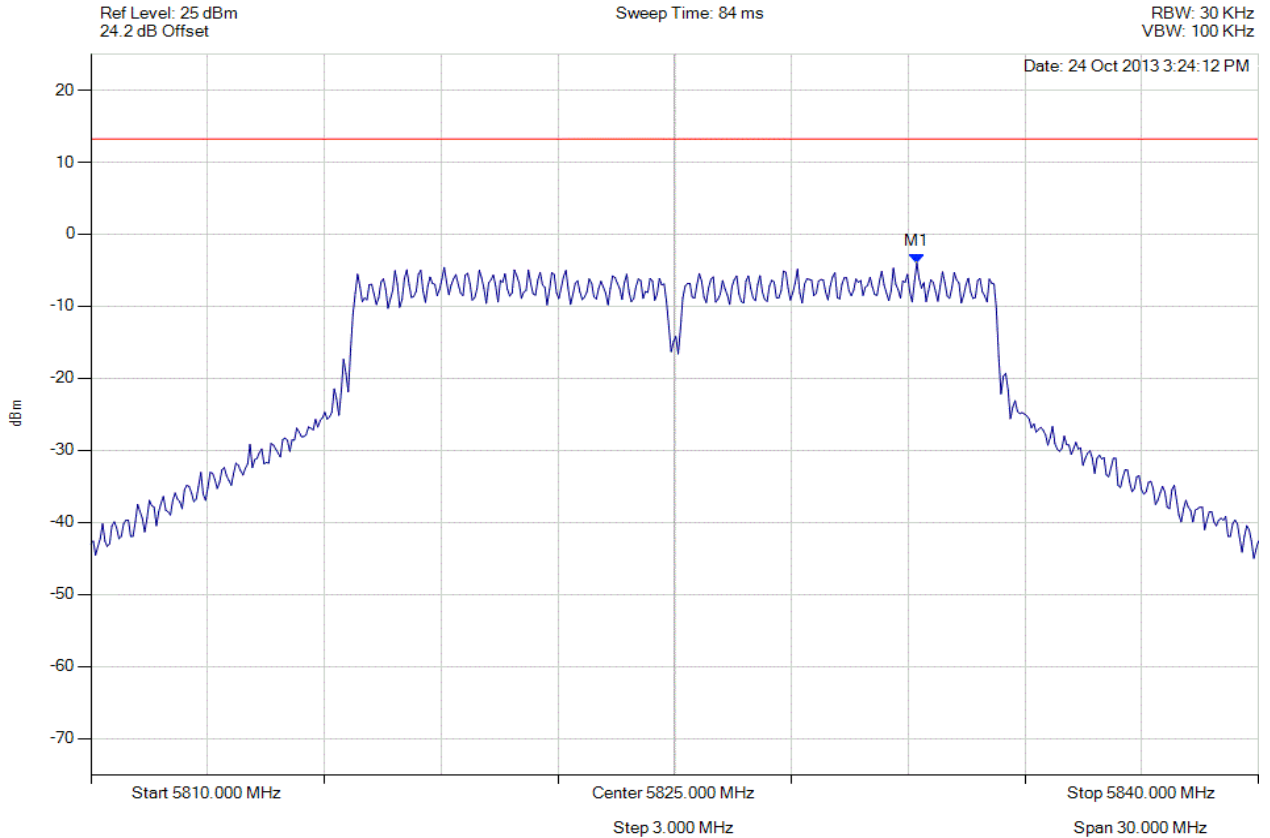

Analyser Setup	Marker : Frequency : Amplitude	Test Results
Detector = AVERAGE Sweep Count = 0 RF Atten (dB) = 20 Trace Mode = VIEW	M1 : 5831.222 MHz : -3.990 dBm	Limit: ≤ 13.229 dBm Margin: -17.22 dB

[Back to the Matrix](#)

This test report may be reproduced in full only. The document may only be updated by MiCOM Labs personnel. Any changes will be noted in the Document History section of the report.



Title: Xirrus Inc. XI-AC1300, XI-AC867
To: FCC 47 CFR Part 15.247 & IC RSS-210
Serial #: XIRR04-U3 Rev A
Issue Date: 29th April 2014
Page: 250 of 572



POWER SPECTRAL DENSITY - AVERAGE

Variant: 802.11ac-40, Channel: 5755.00 MHz, Chain a, Temp: Ambient, Voltage: 56 Vdc

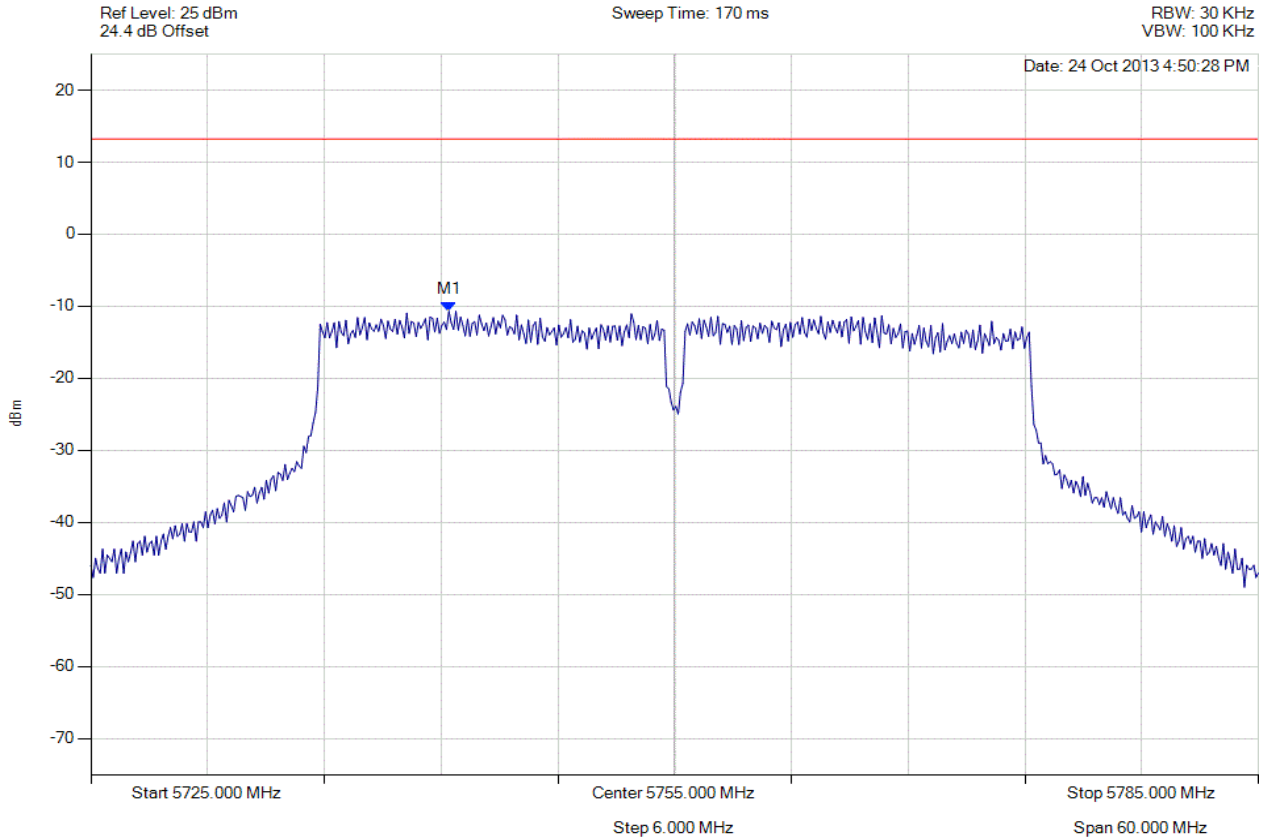

Analyser Setup	Marker : Frequency : Amplitude	Test Results
Detector = AVERAGE Sweep Count = 0 RF Atten (dB) = 20 Trace Mode = VIEW	M1 : 5743.397 MHz : -10.697 dBm	Limit: ≤ 13.229 dBm Margin: -23.93 dB

[Back to the Matrix](#)

This test report may be reproduced in full only. The document may only be updated by MiCOM Labs personnel. Any changes will be noted in the Document History section of the report.



Title: Xirrus Inc. XI-AC1300, XI-AC867
To: FCC 47 CFR Part 15.247 & IC RSS-210
Serial #: XIRR04-U3 Rev A
Issue Date: 29th April 2014
Page: 251 of 572



POWER SPECTRAL DENSITY - AVERAGE

Variant: 802.11ac-40, Channel: 5755.00 MHz, Chain b, Temp: Ambient, Voltage: 56 Vdc

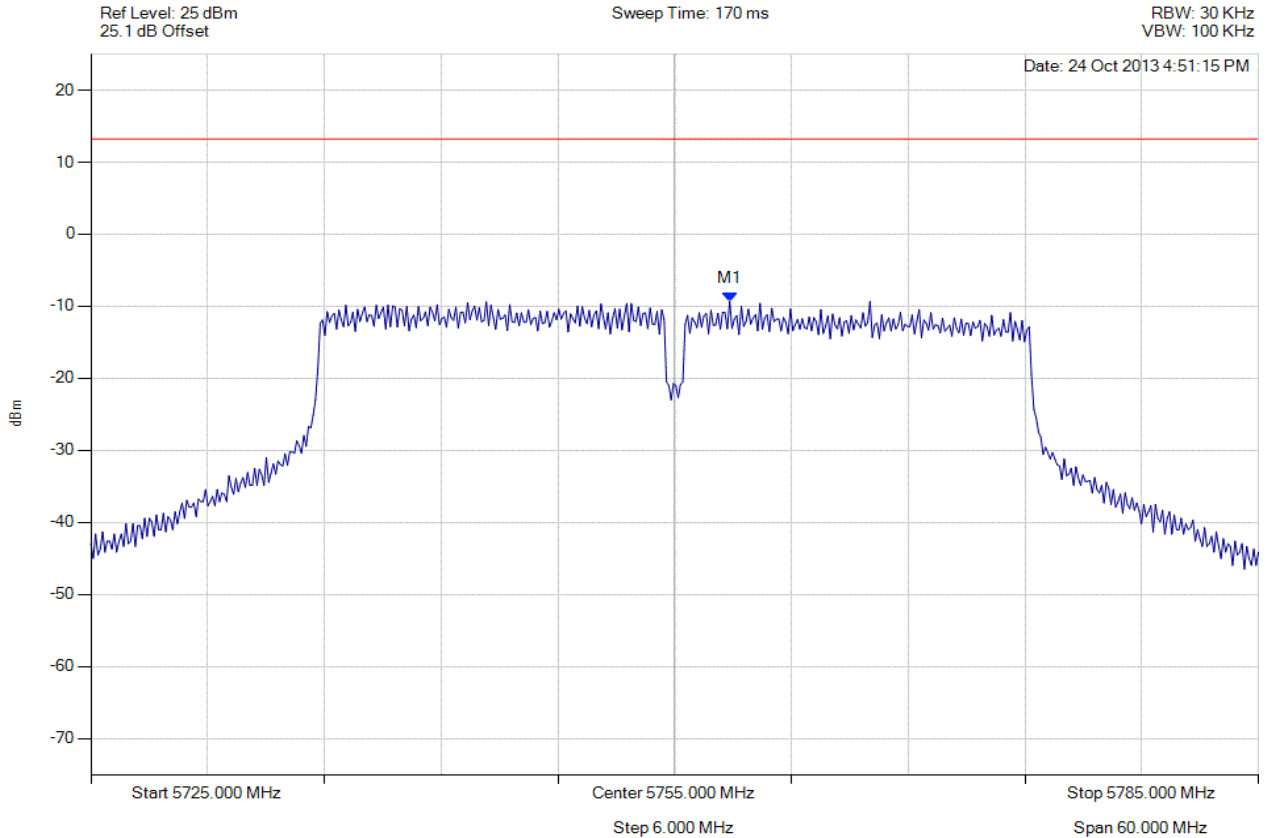

Analyser Setup	Marker : Frequency : Amplitude	Test Results
Detector = AVERAGE Sweep Count = 0 RF Atten (dB) = 20 Trace Mode = VIEW	M1 : 5757.826 MHz : -9.299 dBm	Limit: ≤ 13.229 dBm Margin: -22.53 dB

[Back to the Matrix](#)

This test report may be reproduced in full only. The document may only be updated by MiCOM Labs personnel. Any changes will be noted in the Document History section of the report.



Title: Xirrus Inc. XI-AC1300, XI-AC867
To: FCC 47 CFR Part 15.247 & IC RSS-210
Serial #: XIRR04-U3 Rev A
Issue Date: 29th April 2014
Page: 252 of 572



POWER SPECTRAL DENSITY - AVERAGE

Variant: 802.11ac-40, Channel: 5755.00 MHz, Chain c, Temp: Ambient, Voltage: 56 Vdc

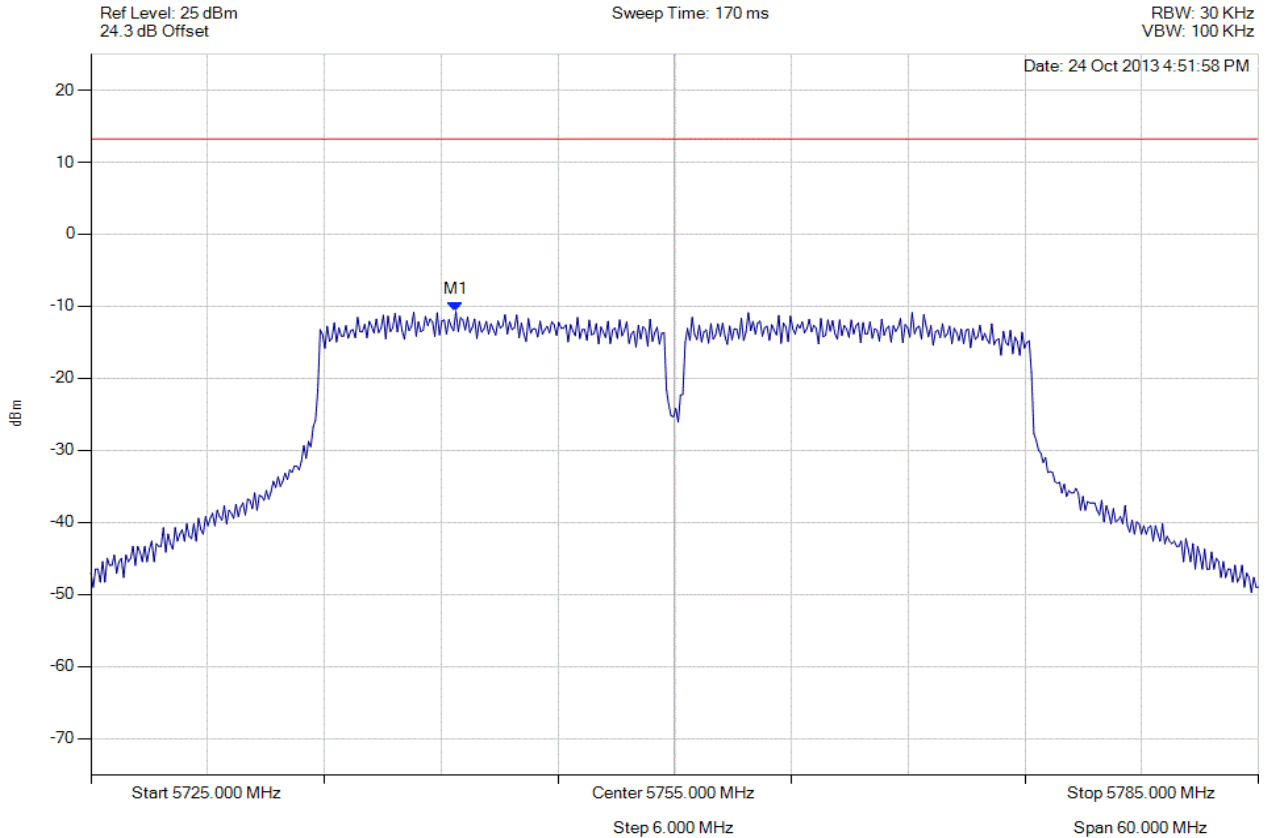

Analyser Setup	Marker : Frequency : Amplitude	Test Results
Detector = AVERAGE Sweep Count = 0 RF Atten (dB) = 20 Trace Mode = VIEW	M1 : 5743.758 MHz : -10.732 dBm	Limit: ≤ 13.229 dBm Margin: -23.96 dB

[Back to the Matrix](#)

This test report may be reproduced in full only. The document may only be updated by MiCOM Labs personnel. Any changes will be noted in the Document History section of the report.



Title: Xirrus Inc. XI-AC1300, XI-AC867
To: FCC 47 CFR Part 15.247 & IC RSS-210
Serial #: XIRR04-U3 Rev A
Issue Date: 29th April 2014
Page: 253 of 572



POWER SPECTRAL DENSITY - AVERAGE

Variant: 802.11ac-40, Channel: 5795.00 MHz, Chain a, Temp: Ambient, Voltage: 56 Vdc

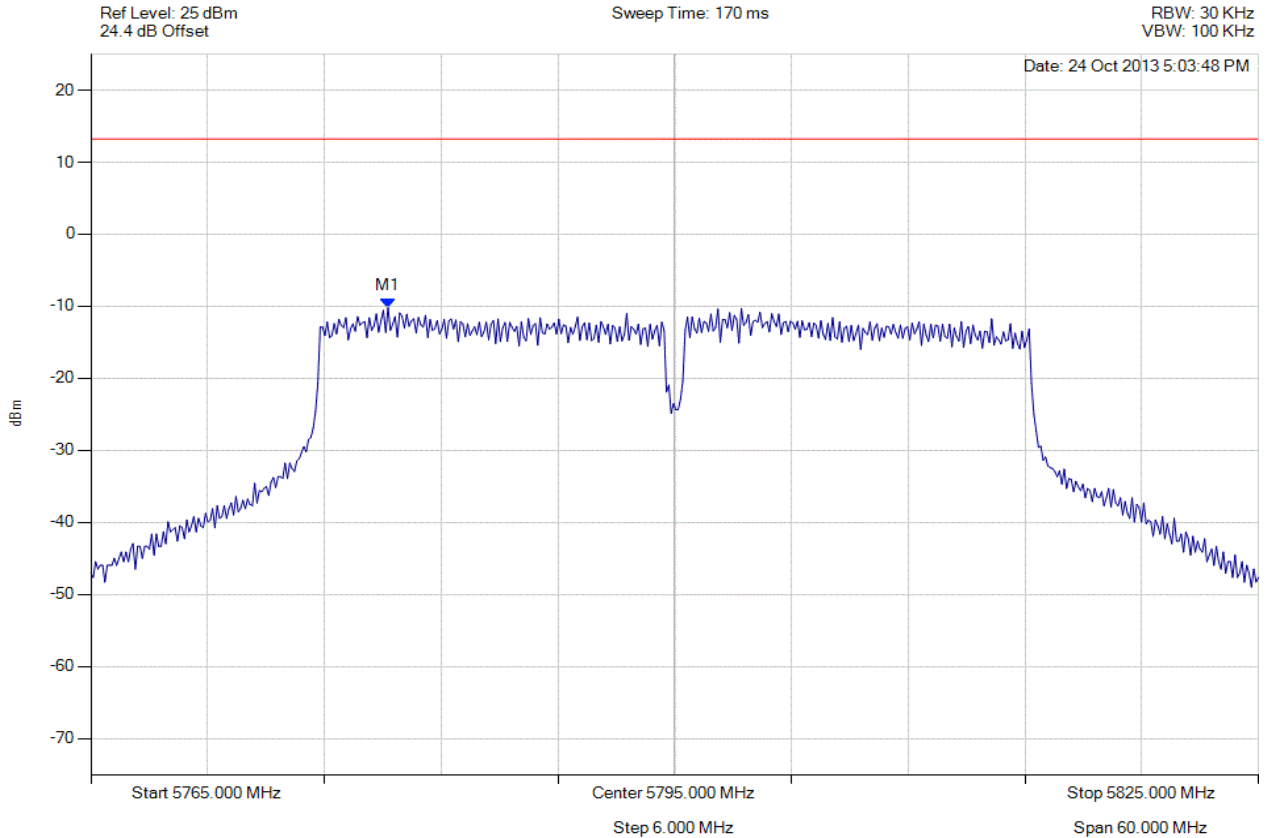

Analyser Setup	Marker : Frequency : Amplitude	Test Results
Detector = AVERAGE Sweep Count = 0 RF Atten (dB) = 20 Trace Mode = VIEW	M1 : 5780.271 MHz : -10.183 dBm	Limit: ≤ 13.229 dBm Margin: -23.41 dB

[Back to the Matrix](#)

This test report may be reproduced in full only. The document may only be updated by MiCOM Labs personnel. Any changes will be noted in the Document History section of the report.



Title: Xirrus Inc. XI-AC1300, XI-AC867
To: FCC 47 CFR Part 15.247 & IC RSS-210
Serial #: XIRR04-U3 Rev A
Issue Date: 29th April 2014
Page: 254 of 572



POWER SPECTRAL DENSITY - AVERAGE

Variant: 802.11ac-40, Channel: 5795.00 MHz, Chain b, Temp: Ambient, Voltage: 56 Vdc

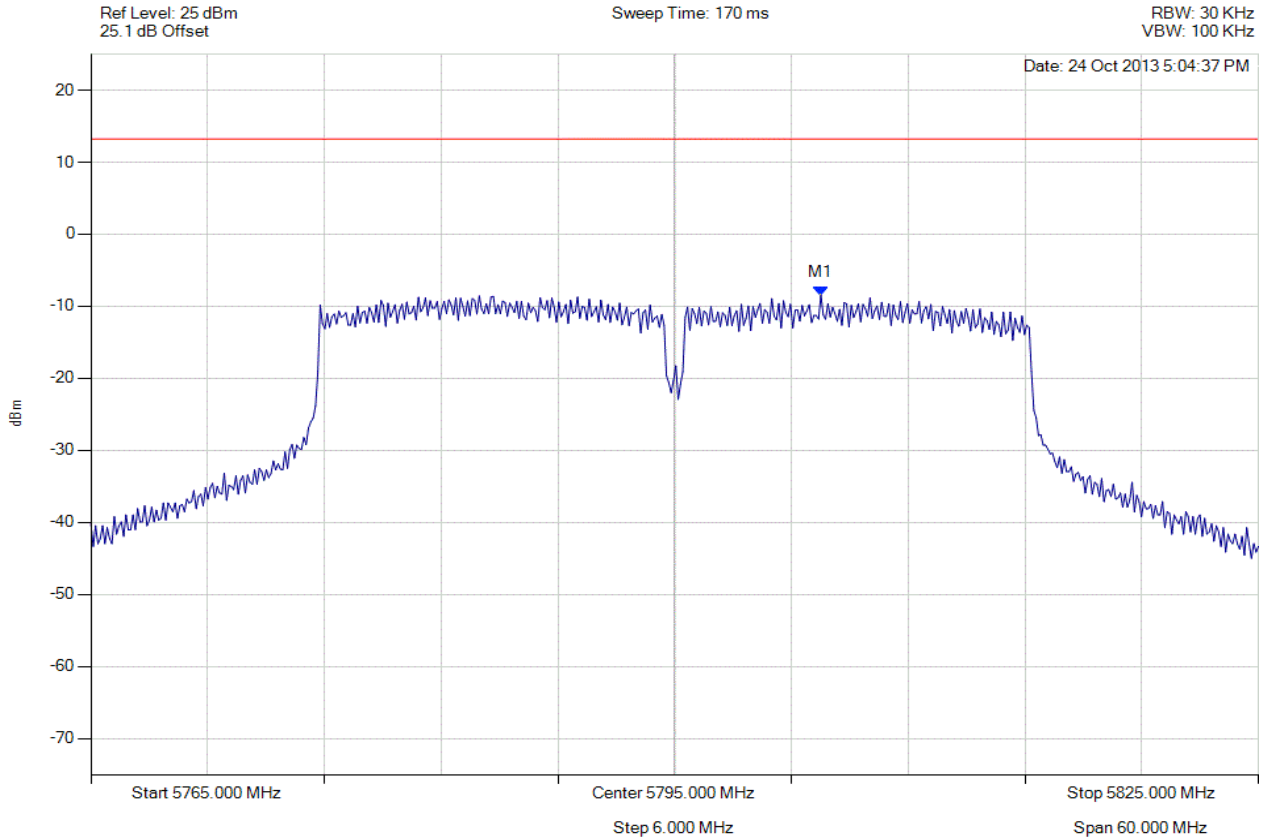

Analyser Setup	Marker : Frequency : Amplitude	Test Results
Detector = AVERAGE Sweep Count = 0 RF Atten (dB) = 20 Trace Mode = VIEW	M1 : 5802.515 MHz : -8.455 dBm	Limit: \leq 13.229 dBm Margin: -21.69 dB

[Back to the Matrix](#)

This test report may be reproduced in full only. The document may only be updated by MiCOM Labs personnel. Any changes will be noted in the Document History section of the report.



Title: Xirrus Inc. XI-AC1300, XI-AC867
To: FCC 47 CFR Part 15.247 & IC RSS-210
Serial #: XIRR04-U3 Rev A
Issue Date: 29th April 2014
Page: 255 of 572



POWER SPECTRAL DENSITY - AVERAGE

Variant: 802.11ac-40, Channel: 5795.00 MHz, Chain c, Temp: Ambient, Voltage: 56 Vdc

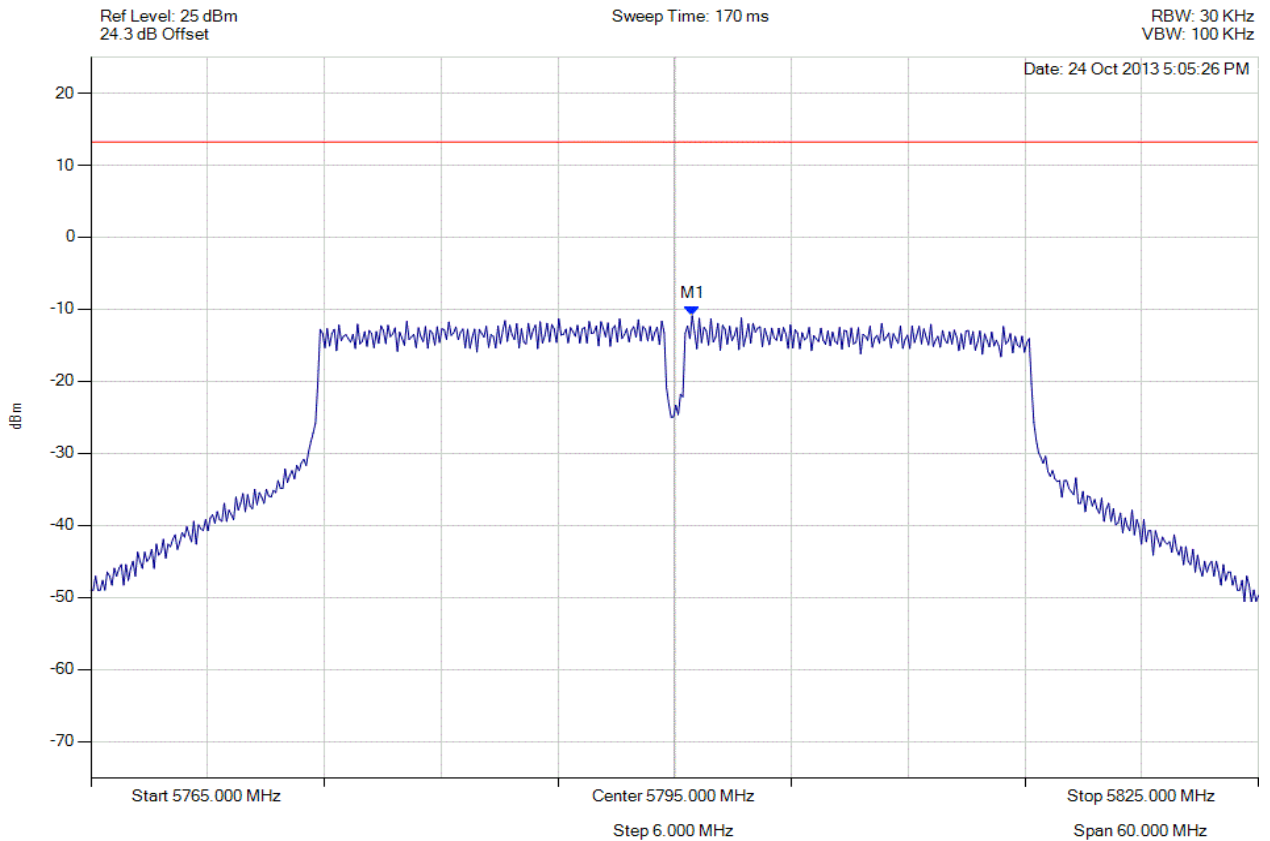

Analyser Setup	Marker : Frequency : Amplitude	Test Results
Detector = AVERAGE Sweep Count = 0 RF Atten (dB) = 20 Trace Mode = VIEW	M1 : 5795.902 MHz : -10.884 dBm	Limit: ≤ 13.229 dBm Margin: -24.11 dB

[Back to the Matrix](#)

This test report may be reproduced in full only. The document may only be updated by MiCOM Labs personnel. Any changes will be noted in the Document History section of the report.



Title: Xirrus Inc. XI-AC1300, XI-AC867
To: FCC 47 CFR Part 15.247 & IC RSS-210
Serial #: XIRR04-U3 Rev A
Issue Date: 29th April 2014
Page: 256 of 572



POWER SPECTRAL DENSITY - AVERAGE

Variant: 802.11ac-80, Channel: 5775.00 MHz, Chain a, Temp: Ambient, Voltage: 56 Vdc

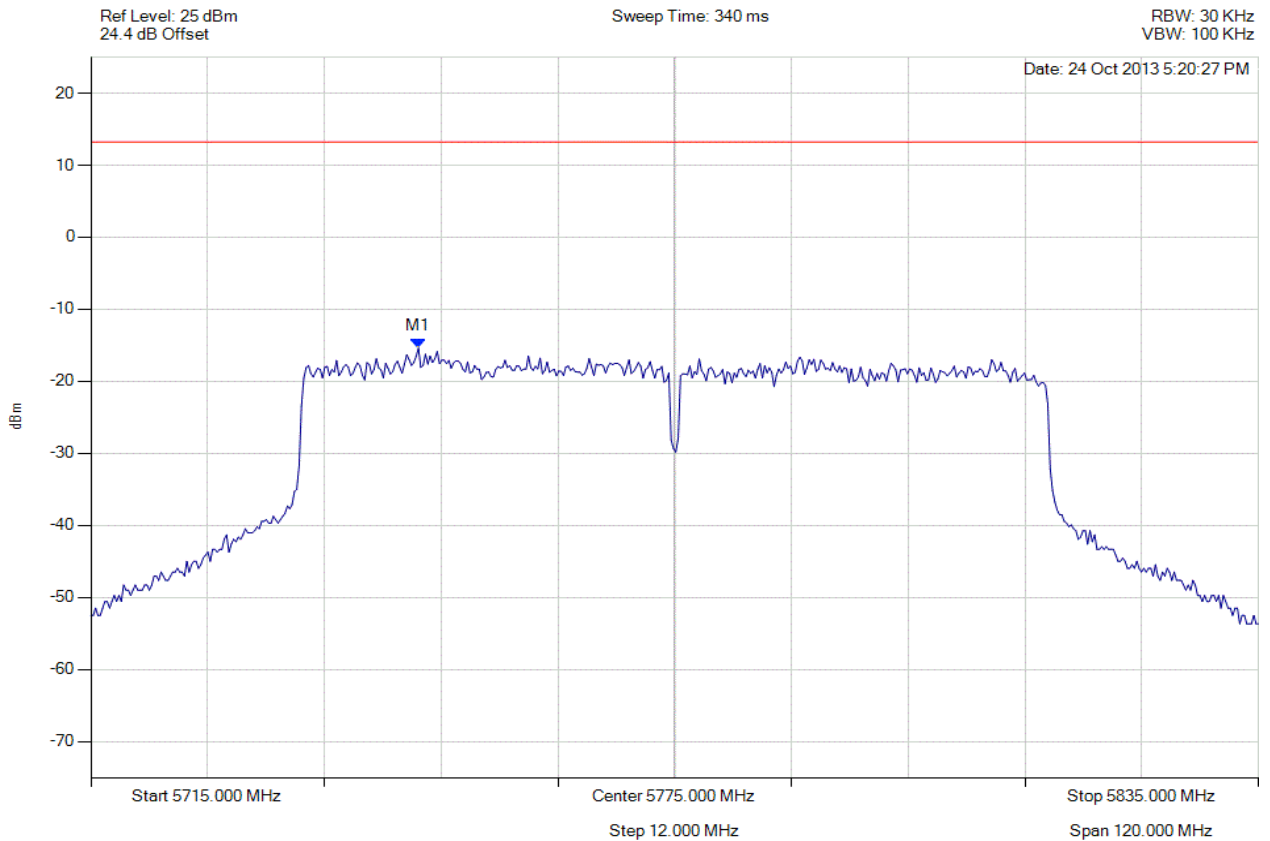

Analyser Setup	Marker : Frequency : Amplitude	Test Results
Detector = AVERAGE Sweep Count = 0 RF Atten (dB) = 20 Trace Mode = VIEW	M1 : 5748.667 MHz : -15.387 dBm	Limit: ≤ 13.229 dBm Margin: -28.62 dB

[Back to the Matrix](#)

This test report may be reproduced in full only. The document may only be updated by MiCOM Labs personnel. Any changes will be noted in the Document History section of the report.



Title: Xirrus Inc. XI-AC1300, XI-AC867
To: FCC 47 CFR Part 15.247 & IC RSS-210
Serial #: XIRR04-U3 Rev A
Issue Date: 29th April 2014
Page: 257 of 572



POWER SPECTRAL DENSITY - AVERAGE

Variant: 802.11ac-80, Channel: 5775.00 MHz, Chain b, Temp: Ambient, Voltage: 56 Vdc

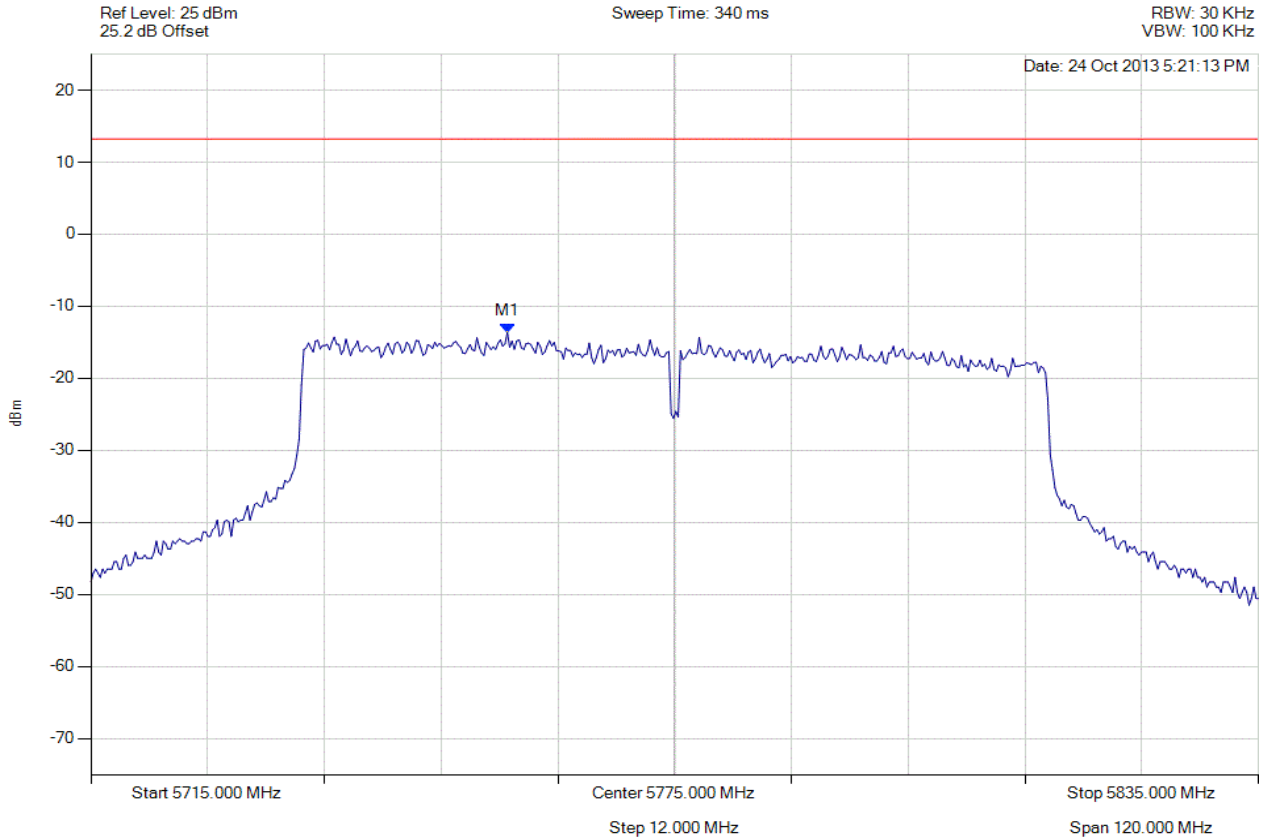

Analyser Setup	Marker : Frequency : Amplitude	Test Results
Detector = AVERAGE Sweep Count = 0 RF Atten (dB) = 20 Trace Mode = VIEW	M1 : 5757.806 MHz : -13.639 dBm	Limit: ≤ 13.229 dBm Margin: -26.87 dB

[Back to the Matrix](#)

This test report may be reproduced in full only. The document may only be updated by MiCOM Labs personnel. Any changes will be noted in the Document History section of the report.



Title: Xirrus Inc. XI-AC1300, XI-AC867
To: FCC 47 CFR Part 15.247 & IC RSS-210
Serial #: XIRR04-U3 Rev A
Issue Date: 29th April 2014
Page: 258 of 572



POWER SPECTRAL DENSITY - AVERAGE

Variant: 802.11ac-80, Channel: 5775.00 MHz, Chain c, Temp: Ambient, Voltage: 56 Vdc

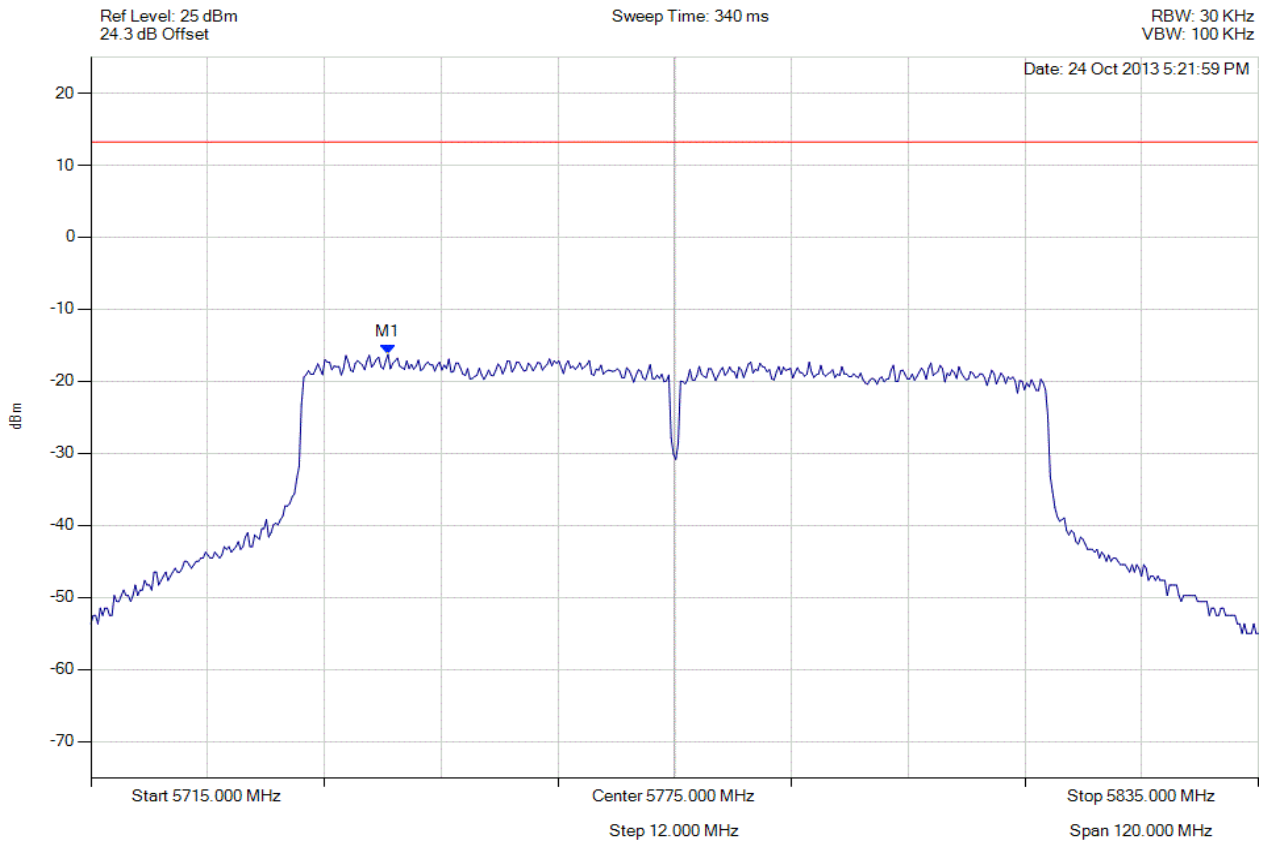

Analyser Setup	Marker : Frequency : Amplitude	Test Results
Detector = AVERAGE Sweep Count = 0 RF Atten (dB) = 20 Trace Mode = VIEW	M1 : 5745.541 MHz : -16.262 dBm	Limit: ≤ 13.229 dBm Margin: -29.49 dB

[Back to the Matrix](#)

This test report may be reproduced in full only. The document may only be updated by MiCOM Labs personnel. Any changes will be noted in the Document History section of the report.



Title: Xirrus Inc. XI-AC1300, XI-AC867
To: FCC 47 CFR Part 15.247 & IC RSS-210
Serial #: XIRR04-U3 Rev A
Issue Date: 29th April 2014
Page: 259 of 572



POWER SPECTRAL DENSITY - AVERAGE

Variant: 802.11n HT-20, Channel: 5745.00 MHz, Chain a, Temp: Ambient, Voltage: 56 Vdc

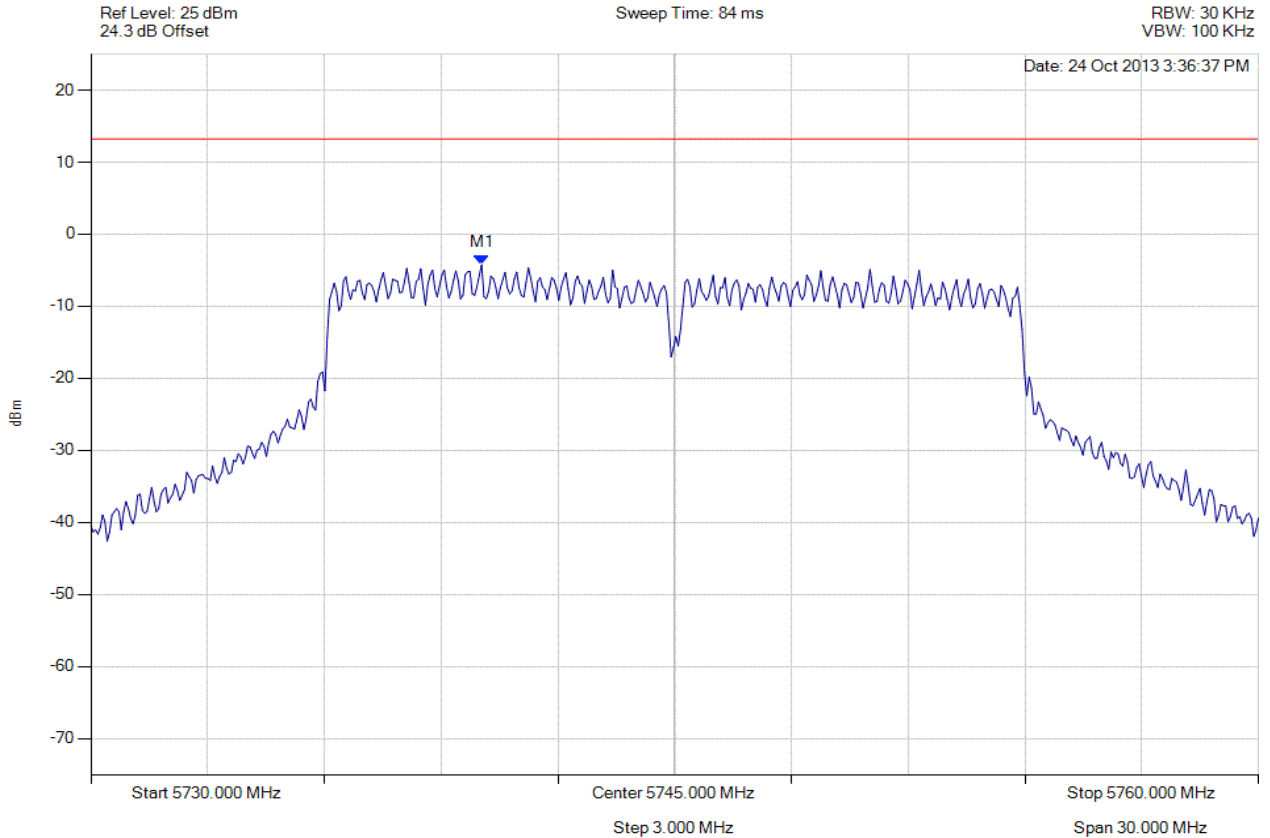

Analyser Setup	Marker : Frequency : Amplitude	Test Results
Detector = AVERAGE Sweep Count = 0 RF Atten (dB) = 20 Trace Mode = VIEW	M1 : 5740.040 MHz : -4.250 dBm	Limit: ≤ 13.229 dBm Margin: -17.48 dB

[Back to the Matrix](#)

This test report may be reproduced in full only. The document may only be updated by MiCOM Labs personnel. Any changes will be noted in the Document History section of the report.



Title: Xirrus Inc. XI-AC1300, XI-AC867
To: FCC 47 CFR Part 15.247 & IC RSS-210
Serial #: XIRR04-U3 Rev A
Issue Date: 29th April 2014
Page: 260 of 572



POWER SPECTRAL DENSITY - AVERAGE

Variant: 802.11n HT-20, Channel: 5745.00 MHz, Chain b, Temp: Ambient, Voltage: 56 Vdc

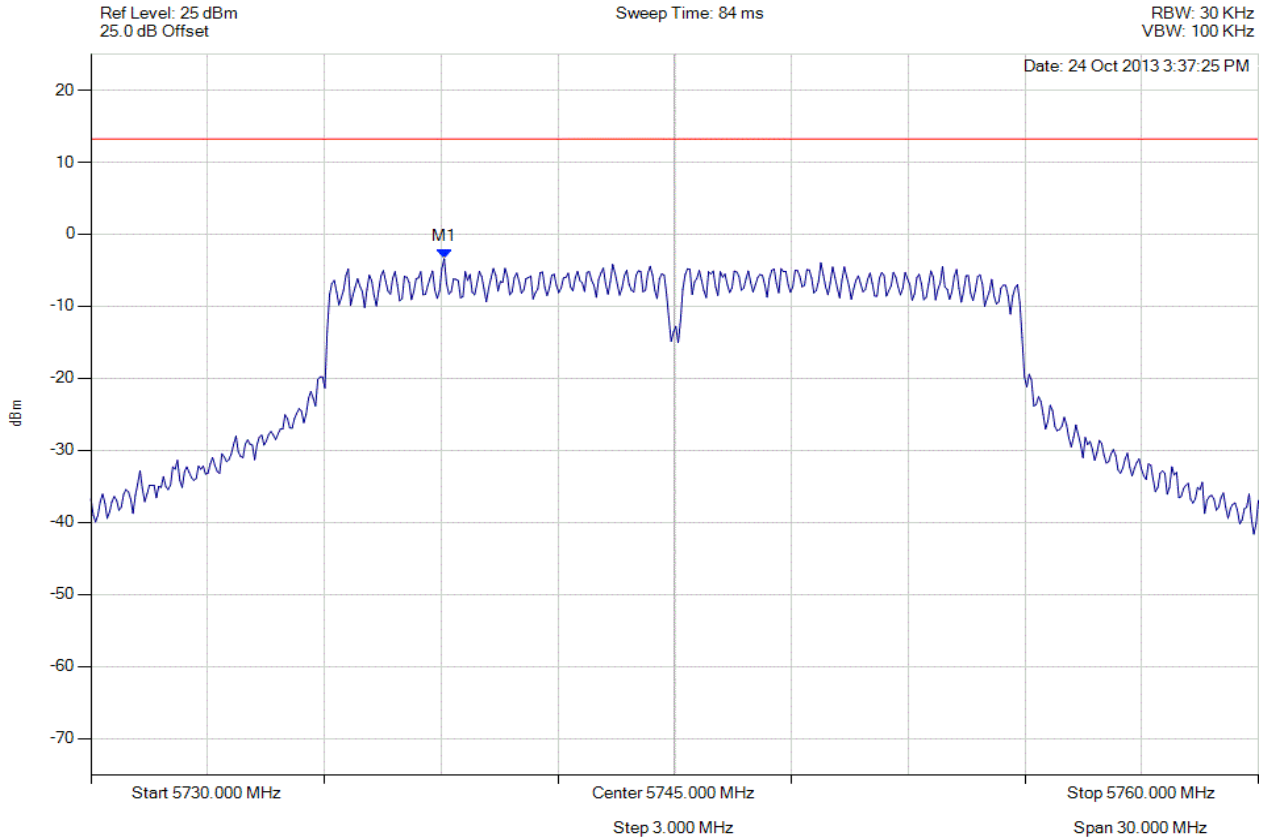

Analyser Setup	Marker : Frequency : Amplitude	Test Results
Detector = AVERAGE Sweep Count = 0 RF Atten (dB) = 20 Trace Mode = VIEW	M1 : 5739.078 MHz : -3.403 dBm	Limit: ≤ 13.229 dBm Margin: -16.63 dB

[Back to the Matrix](#)

This test report may be reproduced in full only. The document may only be updated by MiCOM Labs personnel. Any changes will be noted in the Document History section of the report.



Title: Xirrus Inc. XI-AC1300, XI-AC867
To: FCC 47 CFR Part 15.247 & IC RSS-210
Serial #: XIRR04-U3 Rev A
Issue Date: 29th April 2014
Page: 261 of 572



POWER SPECTRAL DENSITY - AVERAGE

Variant: 802.11n HT-20, Channel: 5745.00 MHz, Chain c, Temp: Ambient, Voltage: 56 Vdc

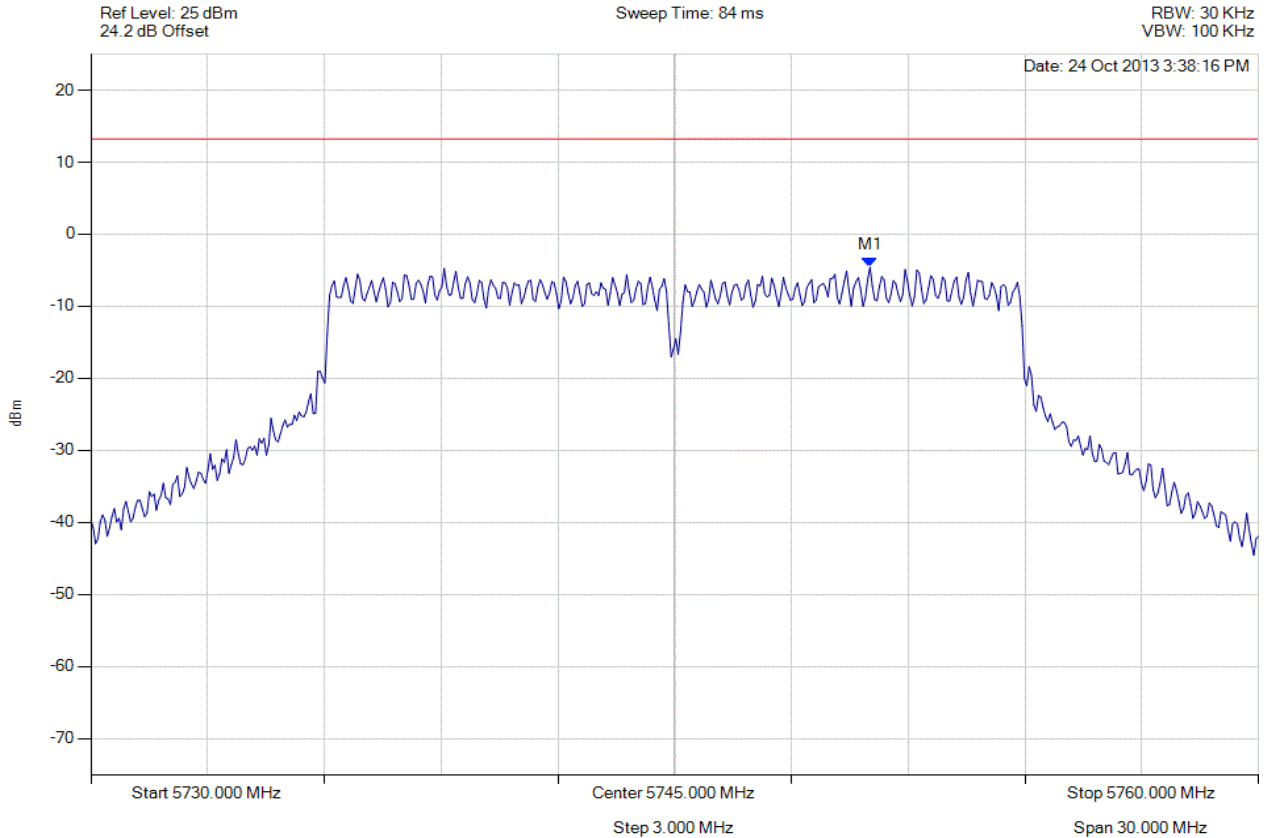

Analyser Setup	Marker : Frequency : Amplitude	Test Results
Detector = AVERAGE Sweep Count = 0 RF Atten (dB) = 20 Trace Mode = VIEW	M1 : 5750.020 MHz : -4.588 dBm	Limit: ≤ 13.229 dBm Margin: -17.82 dB

[Back to the Matrix](#)

This test report may be reproduced in full only. The document may only be updated by MiCOM Labs personnel. Any changes will be noted in the Document History section of the report.



Title: Xirrus Inc. XI-AC1300, XI-AC867
To: FCC 47 CFR Part 15.247 & IC RSS-210
Serial #: XIRR04-U3 Rev A
Issue Date: 29th April 2014
Page: 262 of 572



POWER SPECTRAL DENSITY - AVERAGE

Variant: 802.11n HT-20, Channel: 5785.00 MHz, Chain a, Temp: Ambient, Voltage: 56 Vdc

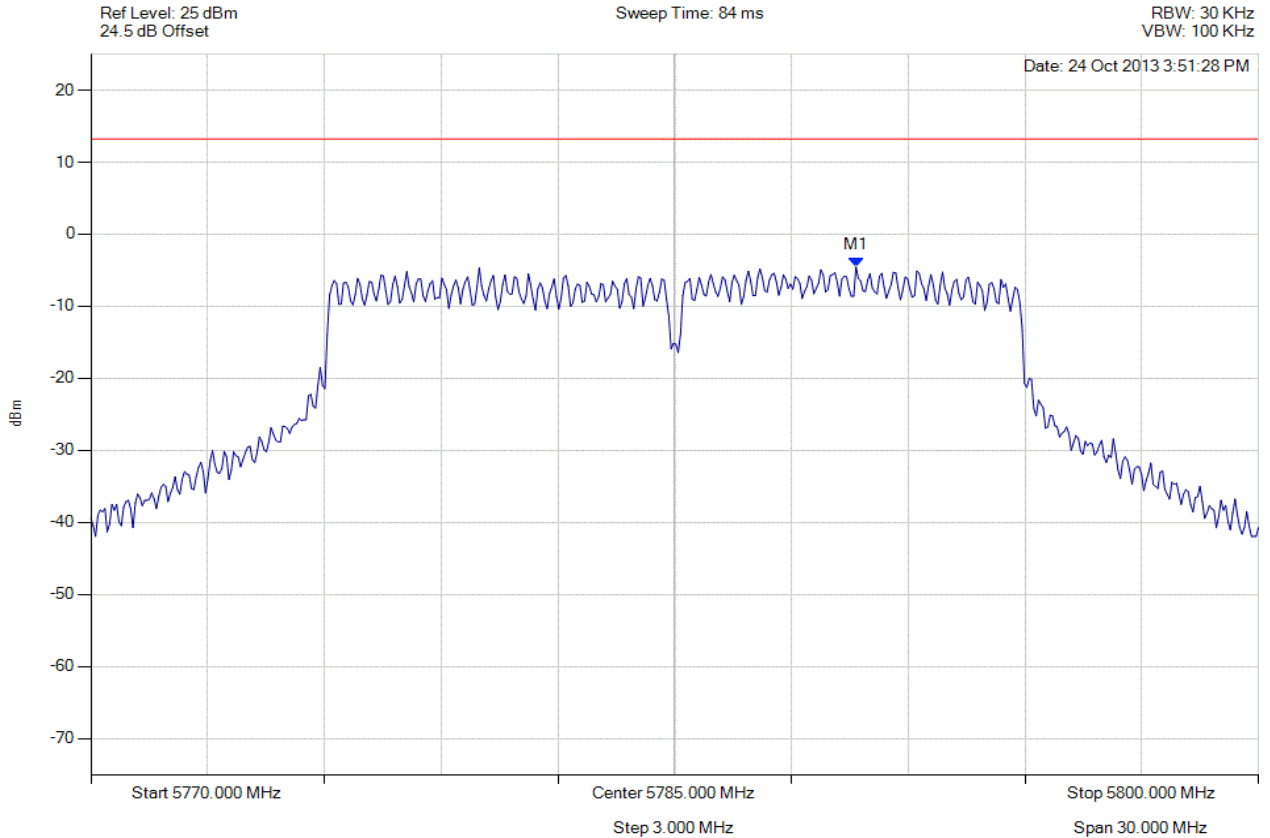

Analyser Setup	Marker : Frequency : Amplitude	Test Results
Detector = AVERAGE Sweep Count = 0 RF Atten (dB) = 20 Trace Mode = VIEW	M1 : 5789.659 MHz : -4.549 dBm	Limit: ≤ 13.229 dBm Margin: -17.78 dB

[Back to the Matrix](#)

This test report may be reproduced in full only. The document may only be updated by MiCOM Labs personnel. Any changes will be noted in the Document History section of the report.



Title: Xirrus Inc. XI-AC1300, XI-AC867
To: FCC 47 CFR Part 15.247 & IC RSS-210
Serial #: XIRR04-U3 Rev A
Issue Date: 29th April 2014
Page: 263 of 572



POWER SPECTRAL DENSITY - AVERAGE

Variant: 802.11n HT-20, Channel: 5785.00 MHz, Chain b, Temp: Ambient, Voltage: 56 Vdc

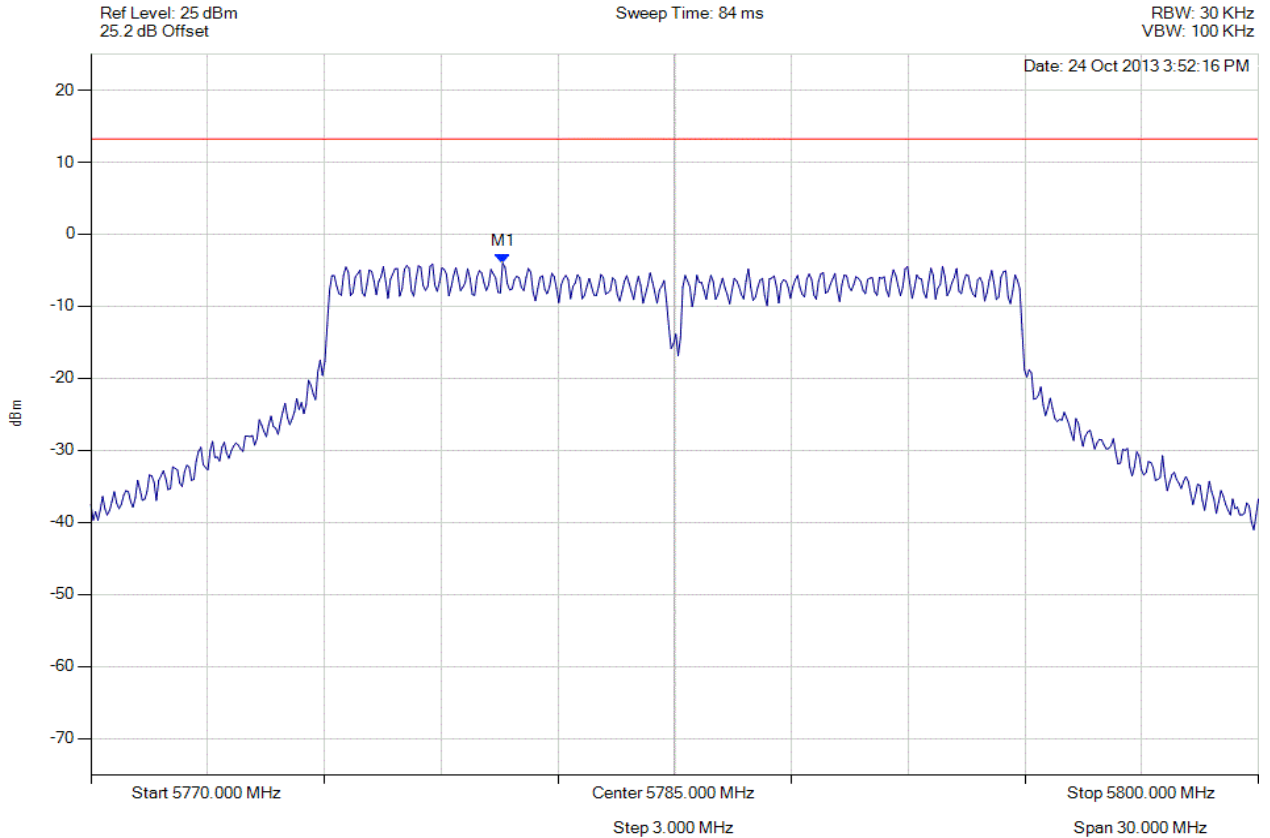

Analyser Setup	Marker : Frequency : Amplitude	Test Results
Detector = AVERAGE Sweep Count = 0 RF Atten (dB) = 20 Trace Mode = VIEW	M1 : 5780.581 MHz : -4.010 dBm	Limit: ≤ 13.229 dBm Margin: -17.24 dB

[Back to the Matrix](#)

This test report may be reproduced in full only. The document may only be updated by MiCOM Labs personnel. Any changes will be noted in the Document History section of the report.



Title: Xirrus Inc. XI-AC1300, XI-AC867
To: FCC 47 CFR Part 15.247 & IC RSS-210
Serial #: XIRR04-U3 Rev A
Issue Date: 29th April 2014
Page: 264 of 572



POWER SPECTRAL DENSITY - AVERAGE

Variant: 802.11n HT-20, Channel: 5785.00 MHz, Chain c, Temp: Ambient, Voltage: 56 Vdc

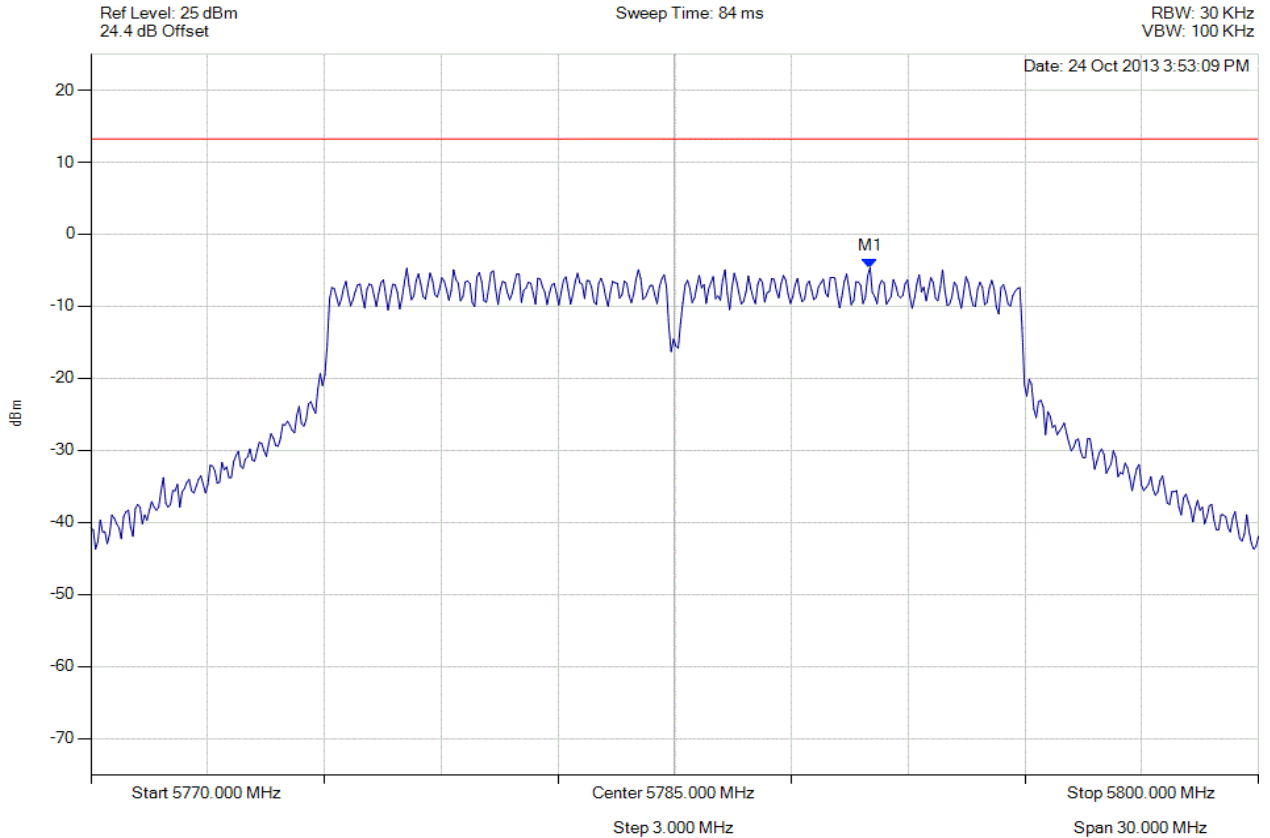

Analyser Setup	Marker : Frequency : Amplitude	Test Results
Detector = AVERAGE Sweep Count = 0 RF Atten (dB) = 20 Trace Mode = VIEW	M1 : 5790.020 MHz : -4.663 dBm	Limit: ≤ 13.229 dBm Margin: -17.89 dB

[Back to the Matrix](#)

This test report may be reproduced in full only. The document may only be updated by MiCOM Labs personnel. Any changes will be noted in the Document History section of the report.



Title: Xirrus Inc. XI-AC1300, XI-AC867
To: FCC 47 CFR Part 15.247 & IC RSS-210
Serial #: XIRR04-U3 Rev A
Issue Date: 29th April 2014
Page: 265 of 572



POWER SPECTRAL DENSITY - AVERAGE

Variant: 802.11n HT-20, Channel: 5825.00 MHz, Chain a, Temp: Ambient, Voltage: 56 Vdc

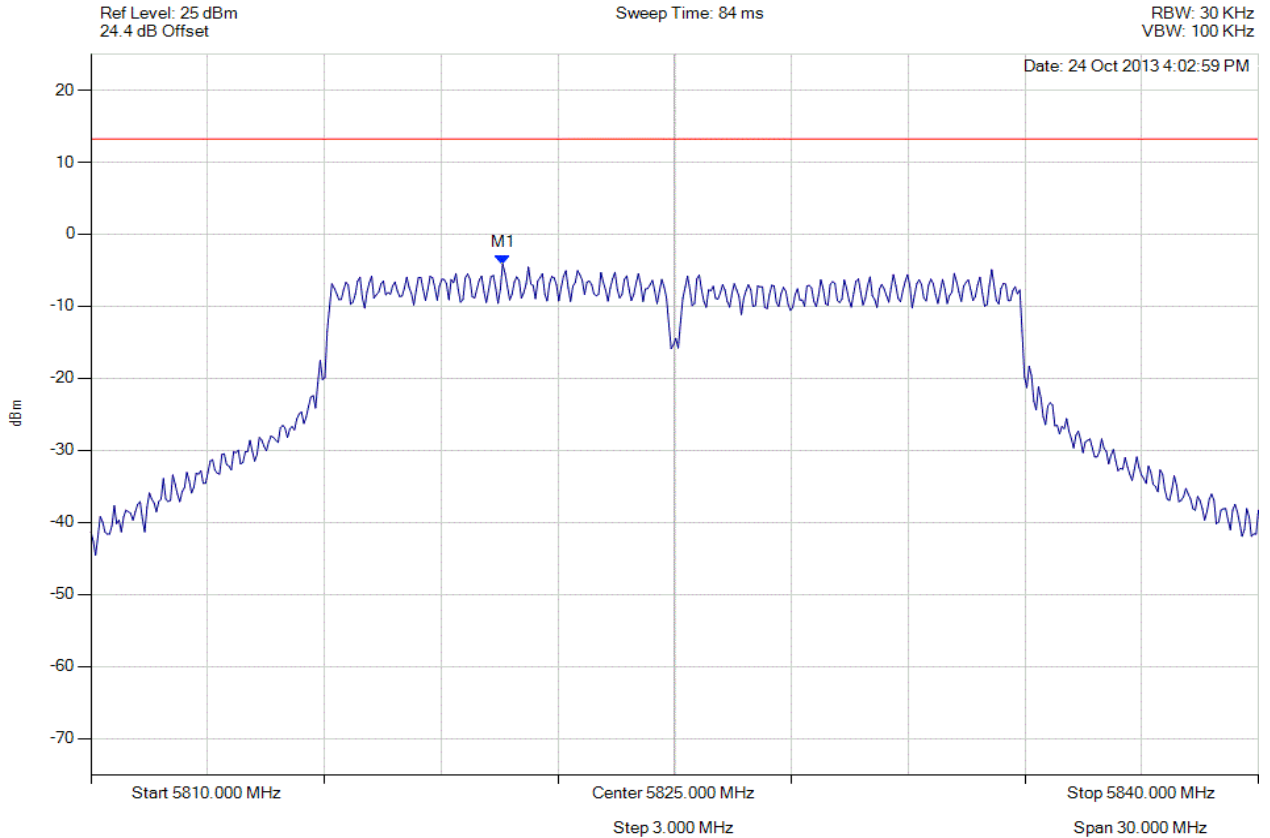

Analyser Setup	Marker : Frequency : Amplitude	Test Results
Detector = AVERAGE Sweep Count = 0 RF Atten (dB) = 20 Trace Mode = VIEW	M1 : 5820.581 MHz : -4.129 dBm	Limit: ≤ 13.229 dBm Margin: -17.36 dB

[Back to the Matrix](#)

This test report may be reproduced in full only. The document may only be updated by MiCOM Labs personnel. Any changes will be noted in the Document History section of the report.



Title: Xirrus Inc. XI-AC1300, XI-AC867
To: FCC 47 CFR Part 15.247 & IC RSS-210
Serial #: XIRR04-U3 Rev A
Issue Date: 29th April 2014
Page: 266 of 572



POWER SPECTRAL DENSITY - AVERAGE

Variant: 802.11n HT-20, Channel: 5825.00 MHz, Chain b, Temp: Ambient, Voltage: 56 Vdc

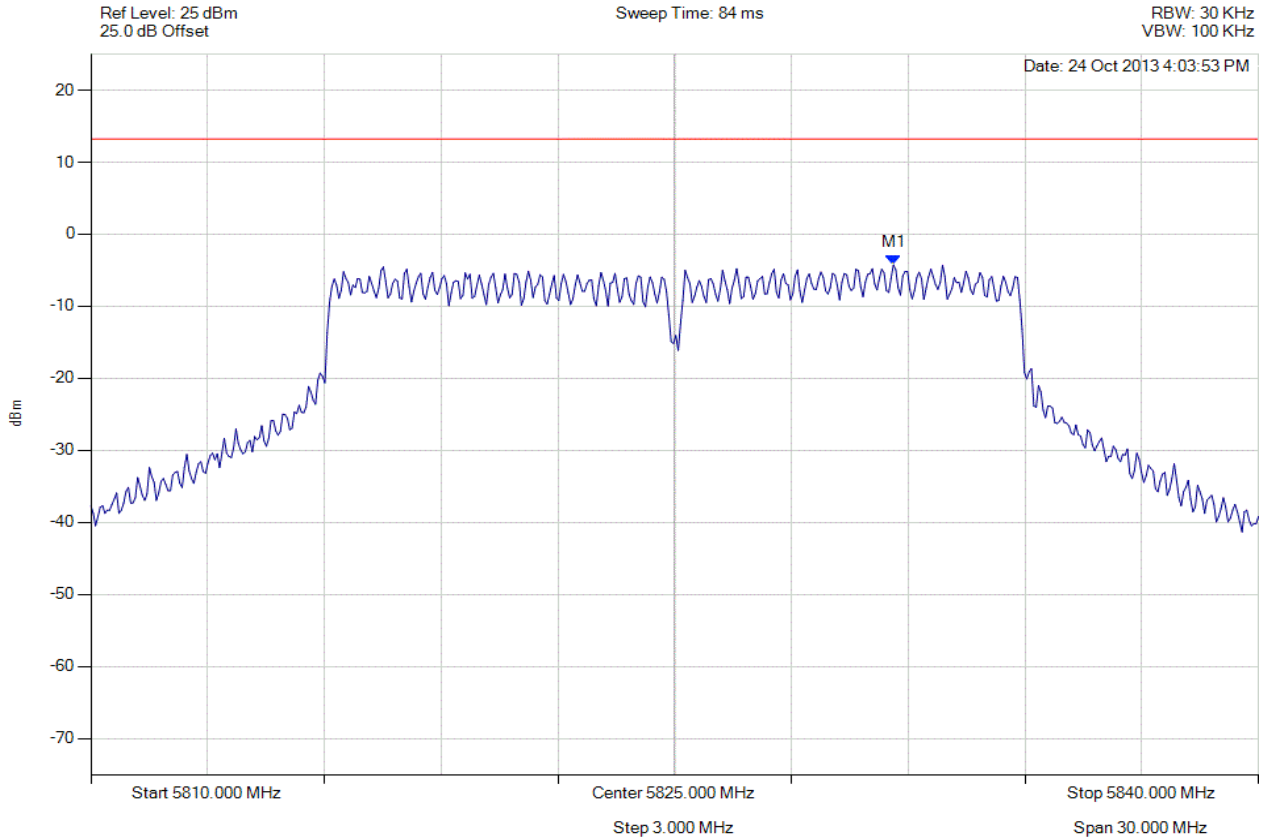

Analyser Setup	Marker : Frequency : Amplitude	Test Results
Detector = AVERAGE Sweep Count = 0 RF Atten (dB) = 20 Trace Mode = VIEW	M1 : 5830.621 MHz : -4.254 dBm	Limit: ≤ 13.229 dBm Margin: -17.48 dB

[Back to the Matrix](#)

This test report may be reproduced in full only. The document may only be updated by MiCOM Labs personnel. Any changes will be noted in the Document History section of the report.



Title: Xirrus Inc. XI-AC1300, XI-AC867
To: FCC 47 CFR Part 15.247 & IC RSS-210
Serial #: XIRR04-U3 Rev A
Issue Date: 29th April 2014
Page: 267 of 572



POWER SPECTRAL DENSITY - AVERAGE

Variant: 802.11n HT-20, Channel: 5825.00 MHz, Chain c, Temp: Ambient, Voltage: 56 Vdc

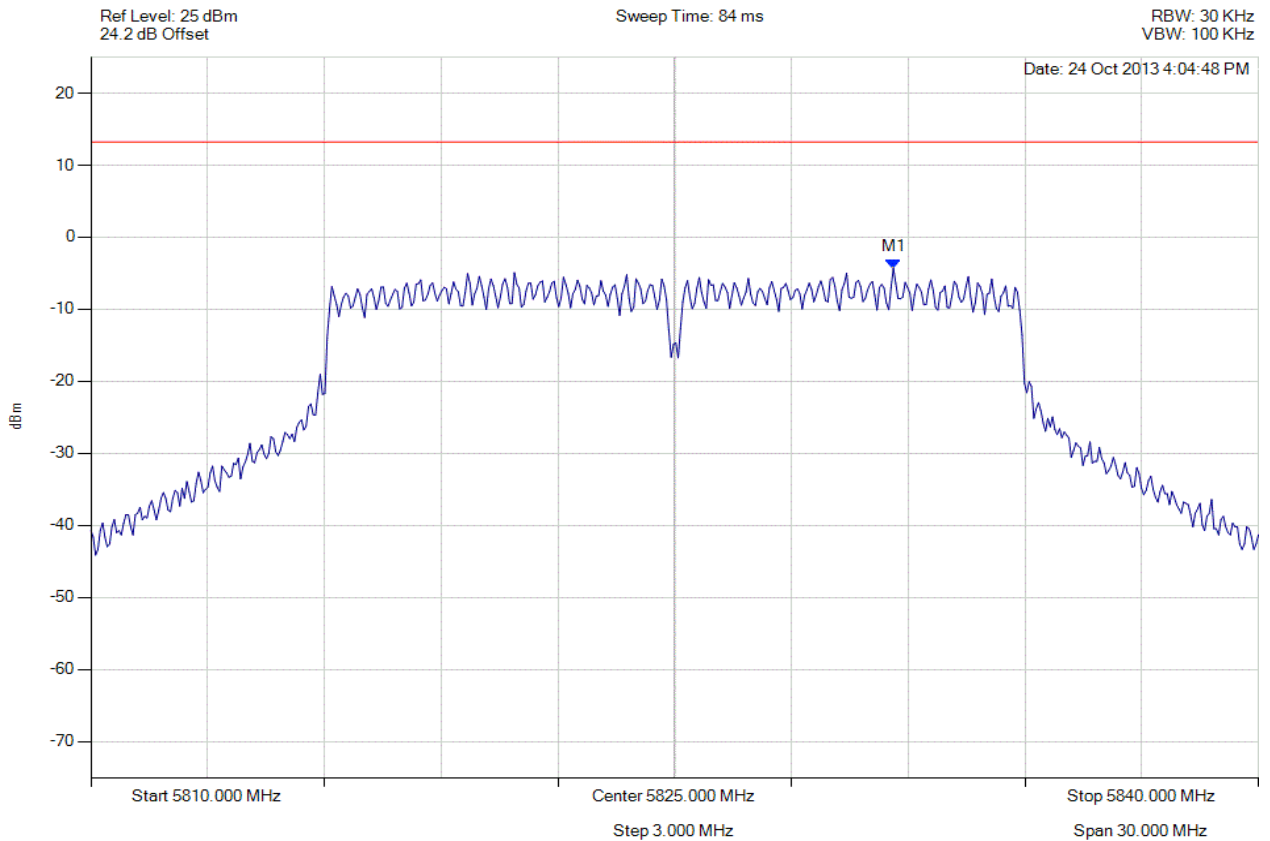

Analyser Setup	Marker : Frequency : Amplitude	Test Results
Detector = AVERAGE Sweep Count = 0 RF Atten (dB) = 20 Trace Mode = VIEW	M1 : 5830.621 MHz : -4.296 dBm	Limit: ≤ 13.229 dBm Margin: -17.53 dB

[Back to the Matrix](#)

This test report may be reproduced in full only. The document may only be updated by MiCOM Labs personnel. Any changes will be noted in the Document History section of the report.



Title: Xirrus Inc. XI-AC1300, XI-AC867
To: FCC 47 CFR Part 15.247 & IC RSS-210
Serial #: XIRR04-U3 Rev A
Issue Date: 29th April 2014
Page: 268 of 572



POWER SPECTRAL DENSITY - AVERAGE

Variant: 802.11n HT-40, Channel: 5755.00 MHz, Chain a, Temp: Ambient, Voltage: 56 Vdc

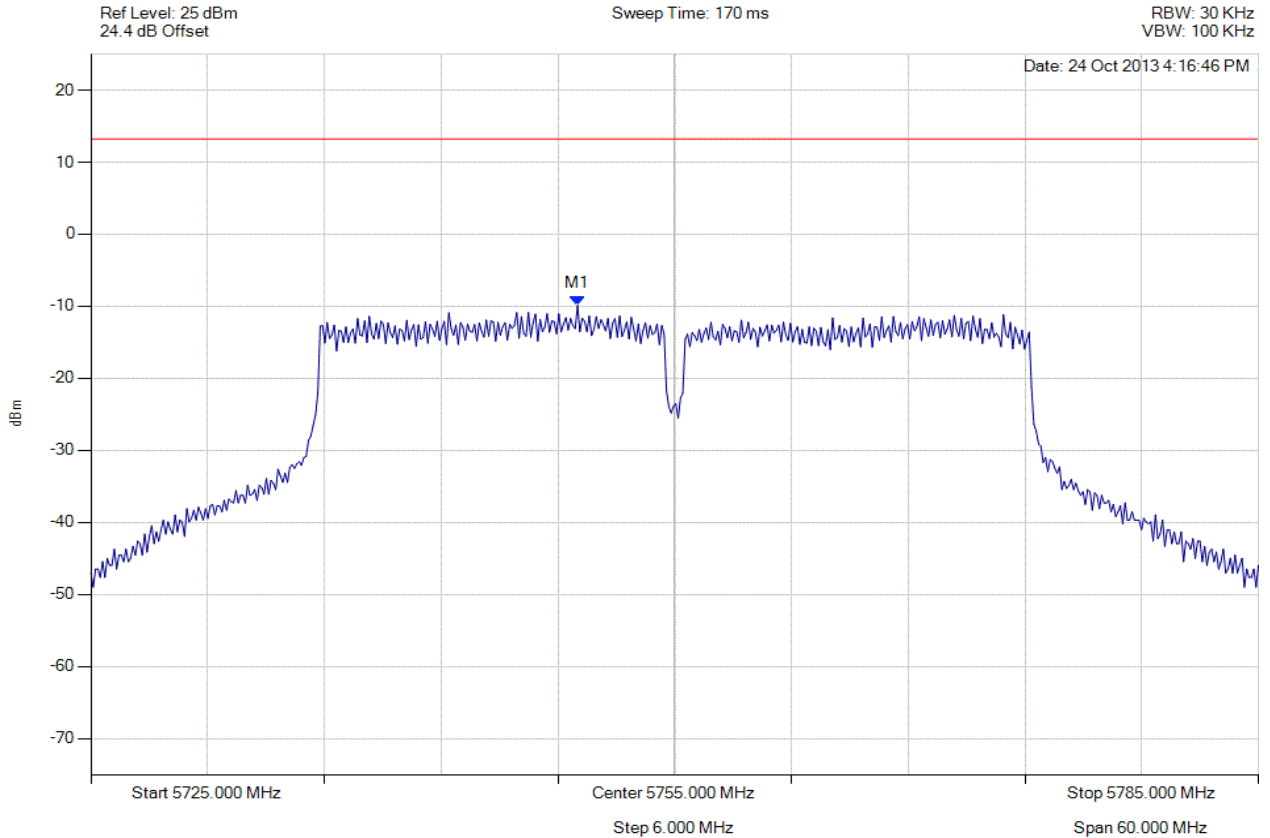

Analyser Setup	Marker : Frequency : Amplitude	Test Results
Detector = AVERAGE Sweep Count = 0 RF Atten (dB) = 20 Trace Mode = VIEW	M1 : 5750.010 MHz : -9.897 dBm	Limit: ≤ 13.229 dBm Margin: -23.13 dB

[Back to the Matrix](#)

This test report may be reproduced in full only. The document may only be updated by MiCOM Labs personnel. Any changes will be noted in the Document History section of the report.



Title: Xirrus Inc. XI-AC1300, XI-AC867
To: FCC 47 CFR Part 15.247 & IC RSS-210
Serial #: XIRR04-U3 Rev A
Issue Date: 29th April 2014
Page: 269 of 572



POWER SPECTRAL DENSITY - AVERAGE

Variant: 802.11n HT-40, Channel: 5755.00 MHz, Chain b, Temp: Ambient, Voltage: 56 Vdc

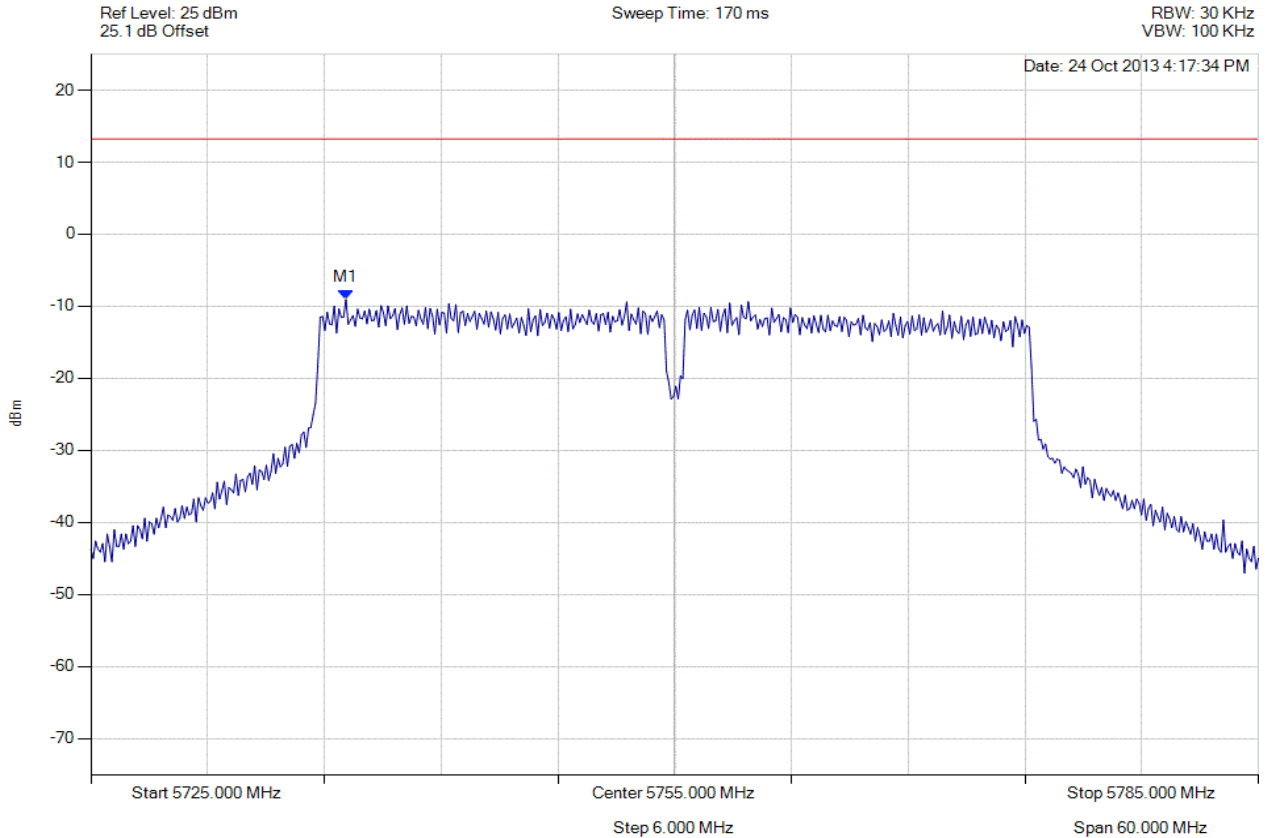

Analyser Setup	Marker : Frequency : Amplitude	Test Results
Detector = AVERAGE Sweep Count = 0 RF Atten (dB) = 20 Trace Mode = VIEW	M1 : 5738.106 MHz : -9.054 dBm	Limit: ≤ 13.229 dBm Margin: -22.28 dB

[Back to the Matrix](#)

This test report may be reproduced in full only. The document may only be updated by MiCOM Labs personnel. Any changes will be noted in the Document History section of the report.



Title: Xirrus Inc. XI-AC1300, XI-AC867
To: FCC 47 CFR Part 15.247 & IC RSS-210
Serial #: XIRR04-U3 Rev A
Issue Date: 29th April 2014
Page: 270 of 572



POWER SPECTRAL DENSITY - AVERAGE

Variant: 802.11n HT-40, Channel: 5755.00 MHz, Chain c, Temp: Ambient, Voltage: 56 Vdc

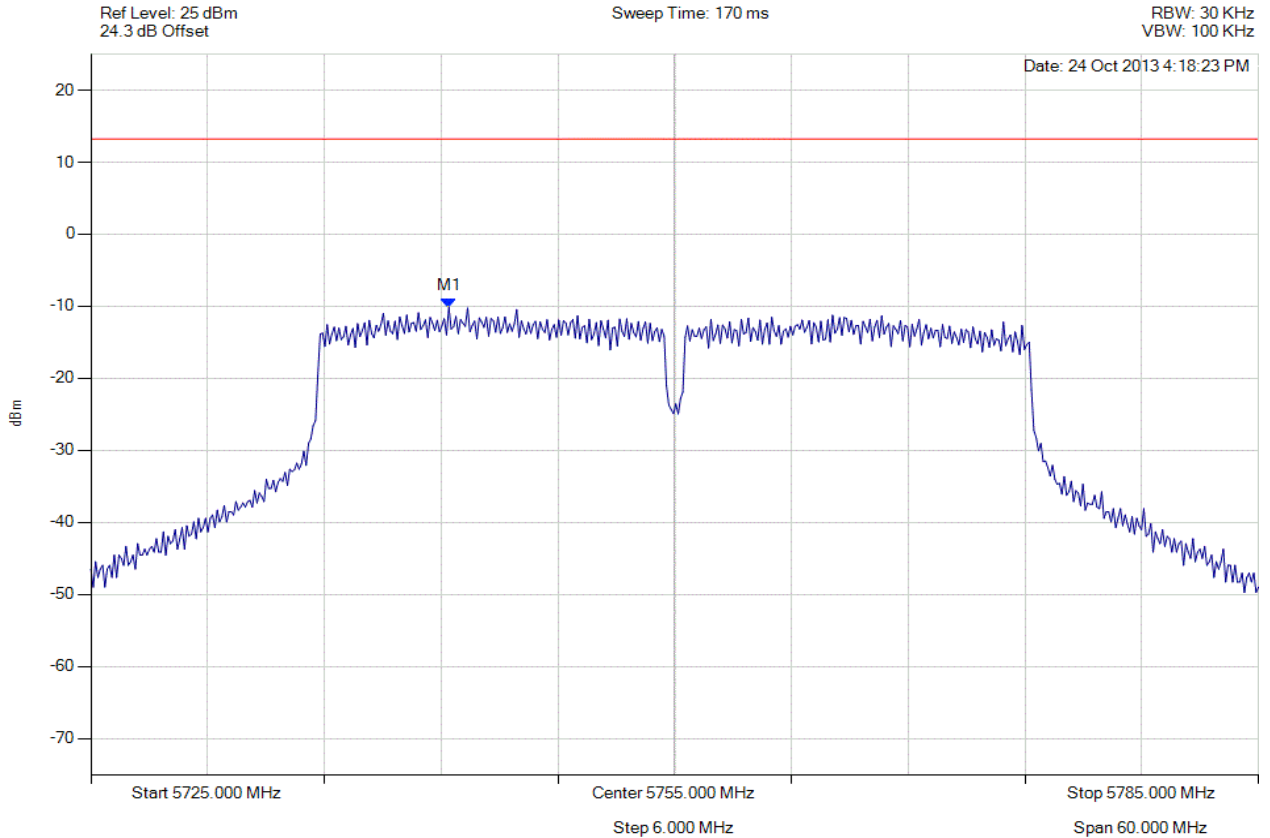

Analyser Setup	Marker : Frequency : Amplitude	Test Results
Detector = AVERAGE Sweep Count = 0 RF Atten (dB) = 20 Trace Mode = VIEW	M1 : 5743.397 MHz : -10.166 dBm	Limit: ≤ 13.229 dBm Margin: -23.40 dB

[Back to the Matrix](#)

This test report may be reproduced in full only. The document may only be updated by MiCOM Labs personnel. Any changes will be noted in the Document History section of the report.



Title: Xirrus Inc. XI-AC1300, XI-AC867
To: FCC 47 CFR Part 15.247 & IC RSS-210
Serial #: XIRR04-U3 Rev A
Issue Date: 29th April 2014
Page: 271 of 572



POWER SPECTRAL DENSITY - AVERAGE

Variant: 802.11n HT-40, Channel: 5795.00 MHz, Chain a, Temp: Ambient, Voltage: 56 Vdc

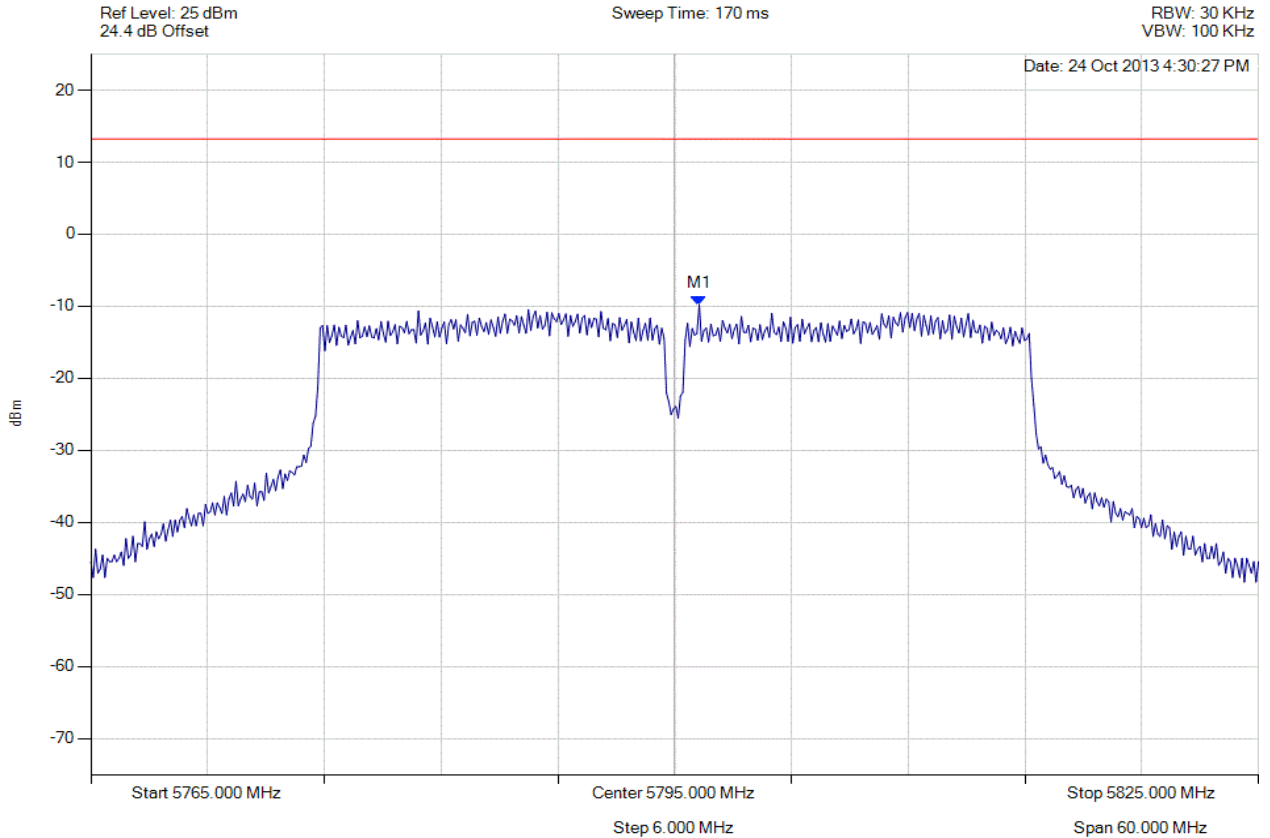

Analyser Setup	Marker : Frequency : Amplitude	Test Results
Detector = AVERAGE Sweep Count = 0 RF Atten (dB) = 20 Trace Mode = VIEW	M1 : 5796.263 MHz : -9.857 dBm	Limit: ≤ 13.229 dBm Margin: -23.09 dB

[Back to the Matrix](#)

This test report may be reproduced in full only. The document may only be updated by MiCOM Labs personnel. Any changes will be noted in the Document History section of the report.



Title: Xirrus Inc. XI-AC1300, XI-AC867
To: FCC 47 CFR Part 15.247 & IC RSS-210
Serial #: XIRR04-U3 Rev A
Issue Date: 29th April 2014
Page: 272 of 572



POWER SPECTRAL DENSITY - AVERAGE

Variant: 802.11n HT-40, Channel: 5795.00 MHz, Chain b, Temp: Ambient, Voltage: 56 Vdc

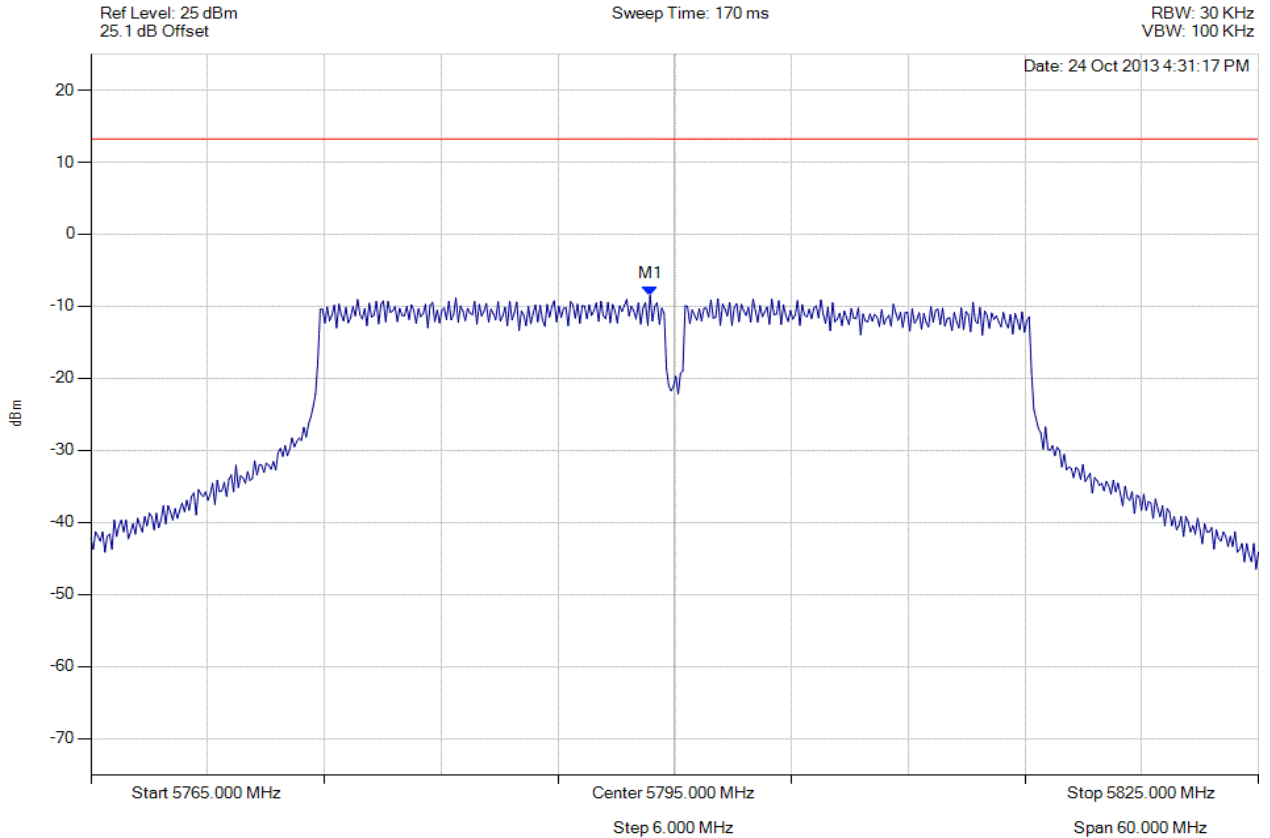

Analyser Setup	Marker : Frequency : Amplitude	Test Results
Detector = AVERAGE Sweep Count = 0 RF Atten (dB) = 20 Trace Mode = VIEW	M1 : 5793.737 MHz : -8.496 dBm	Limit: ≤ 13.229 dBm Margin: -21.73 dB

[Back to the Matrix](#)

This test report may be reproduced in full only. The document may only be updated by MiCOM Labs personnel. Any changes will be noted in the Document History section of the report.



Title: Xirrus Inc. XI-AC1300, XI-AC867
To: FCC 47 CFR Part 15.247 & IC RSS-210
Serial #: XIRR04-U3 Rev A
Issue Date: 29th April 2014
Page: 273 of 572



POWER SPECTRAL DENSITY - AVERAGE

Variant: 802.11n HT-40, Channel: 5795.00 MHz, Chain c, Temp: Ambient, Voltage: 56 Vdc

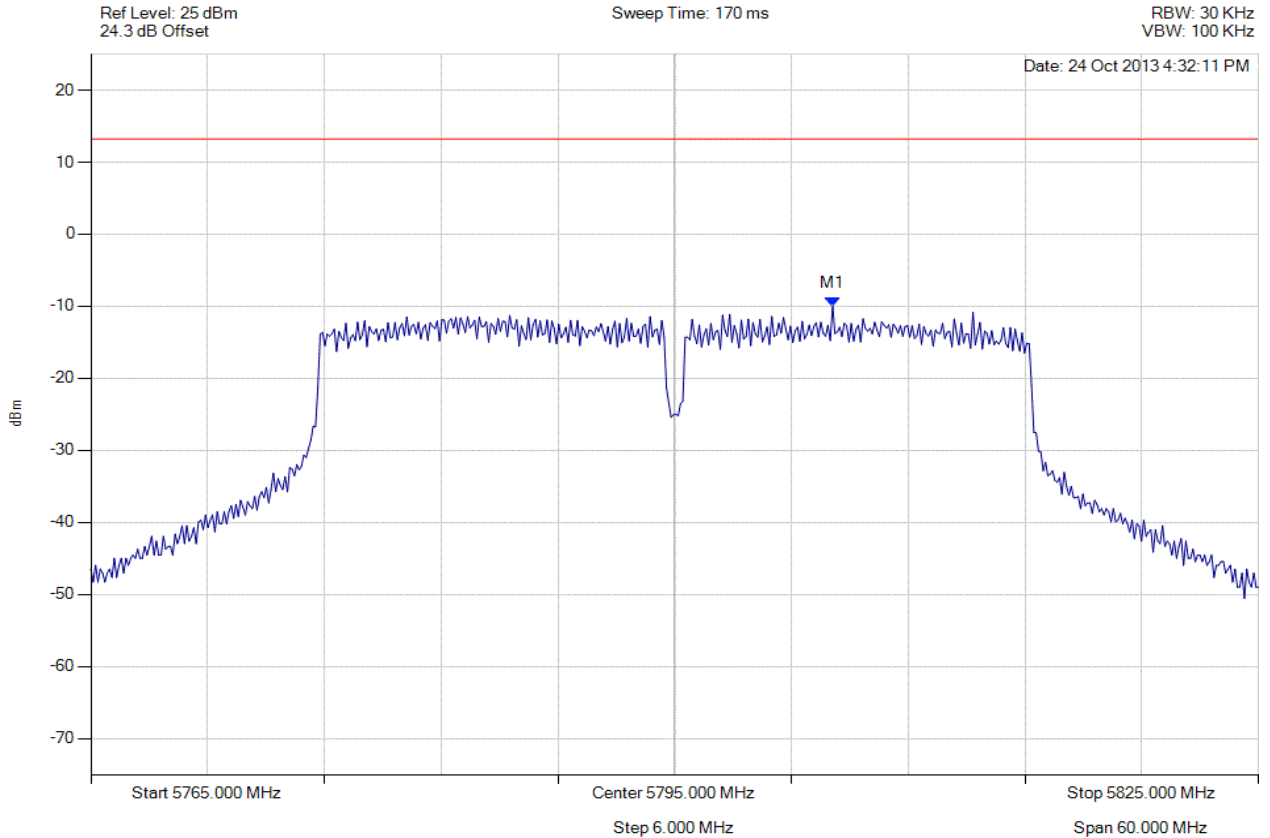

Analyser Setup	Marker : Frequency : Amplitude	Test Results
Detector = AVERAGE Sweep Count = 0 RF Atten (dB) = 20 Trace Mode = VIEW	M1 : 5803.116 MHz : -9.953 dBm	Limit: ≤ 13.229 dBm Margin: -23.18 dB

[Back to the Matrix](#)

This test report may be reproduced in full only. The document may only be updated by MiCOM Labs personnel. Any changes will be noted in the Document History section of the report.