



**Internet Energy Systems  
FCC Part 90, Certification Application  
Model C3I-W Wireless Transmitter**

**UST Project No: 04-0272  
October 18, 2004**

I certify that I am authorized to sign for the manufacturer and that all of the statements in this report and in the Exhibits attached hereto are true and correct to the best of my knowledge and belief:

**UNITED STATES TECHNOLOGIES, INC. (AGENT RESPONSIBLE FOR TEST):**

By: 

Name: Louis A Feudi

Title: Operations Manager

Date: October 18, 2004

**Internet Energy Systems  
23879 455<sup>th</sup> Avenue  
Madison, SD 57042**

By: \_\_\_\_\_

Name: \_\_\_\_\_

Title: \_\_\_\_\_

Date: \_\_\_\_\_

This report shall not be reproduced except in full. This report may be copied in part only with the prior written approval of U.S. Technologies. The results contained in this report are subject to the adequacy and representative character of the sample provided.

Report Number: 04-0272

Customer: Internet Energy Systems

Model: C3I-W Wireless Transmitter

# MEASUREMENT/TECHNICAL REPORT

This report concerns (check one): Original grant X  
Class II change\_\_\_\_\_

Equipment type: Low Powered Transmitter

Deferred grant requested per 47 CFR 0.457(d)(1)(ii)? yes\_\_\_\_\_ No X

If yes, defer until:\_\_\_\_\_  
date

N.A. agrees to notify the Commission by N.A.  
date

of the intended date of announcement of the product so that the grant can be issued on that date.

Report prepared by:

United States Technologies, Inc.  
3505 Francis Circle  
Alpharetta, GA 30004

Phone Number: (770) 740-0717  
Fax Number: (770) 740-1508

Report Number: 04-0272

Customer: Internet Energy Systems

Model: C3I-W Wireless Transmitter

---

## **TABLE OF CONTENTS**

### **SECTION 1**

#### **GENERAL INFORMATION**

Product Description  
Related Submittal(s) Grant(s)

### **SECTION 2**

#### **TESTS AND MEASUREMENTS**

Configuration of Tested System  
Test Facility  
Test Equipment  
Modifications  
Field Strength of Fundamental Emission  
Field Strength of Spurious Emissions  
Radiated Emissions  
Power Line Conducted Emissions

### **SECTION 3**

#### **LABELING INFORMATION**

### **SECTION 4**

#### **BLOCK DIAGRAM/SCHEMATICS**

### **SECTION 5**

#### **PHOTOGRAPHS**

### **SECTION 6**

#### **USER'S MANUAL**

## **LIST OF FIGURES AND TABLES**

### **FIGURES**

Test Configuration  
Photograph(s) for Spurious and Fundamental Emissions

### **TABLES**

EUT And Peripherals  
Test Instruments  
Field Strength of Fundamental Emission  
Field Strength of Spurious Emissions  
Power Line Conducted Emissions

Report Number: 04-0272

Customer: Internet Energy Systems

Model: C3I-W Wireless Transmitter

---

# **SECTION 1**

## **GENERAL INFORMATION**

## GENERAL INFORMATION

### 1.1 Product Description

The Equipment Under Test (EUT) is the Internet Energy Systems' Model C3I-W Wireless Transmitter. The EUT is a wireless version of the C31 family of products which is designed to remotely read electrical, gas, and water meters, as well as perform load management functions. The C3I-W uses telemetry frequencies in the VHF band to accomplish this.

## 1.2 Related Submittal(s)/Grant(s)

The EUT will be used with part of a system to send/receive data. The transmitter presented in this report will be used with other like transceivers.

### a) Certification as a low power transmitter

The information contained in this report is presented for the Certification authorization for the transmitter portion of the EUT.

The EUT is a low power device operating at 154.45625, 154.46375, 154.47125, 154.47875, 173.20375, 173.21, 173.2375, 173.2625, 173.2875, 173.3125, 173.3375, 173.3625, 173.39, 173.39625 in accordance with Part B of FCC part 90. The unit operates at less than 120 mW and the client wishes to exercise the exemption under subpart 90.217, listed below:

### **§ 90.217 Exemption from technical standards.**

Except as noted herein, transmitters used at stations licensed below 800 MHz on any frequency listed in subparts B and C of this part or licensed on a business category channel above 800 MHz which have an output power not exceeding 120 milliwatts are exempt from the technical requirements set out in this subpart, but must instead comply with the following:

- (a) For equipment designed to operate with a 25 kHz channel bandwidth, the sum of the bandwidth occupied by the emitted signal plus the bandwidth required for frequency stability shall be adjusted so that any emission appearing on a frequency 40 kHz or more removed from the assigned frequency is attenuated at least 30 dB below the unmodulated carrier.
- (b) For equipment designed to operate with a 12.5 kHz channel bandwidth, the sum of the bandwidth occupied by the emitted signal plus the bandwidth required for frequency stability shall be adjusted so that any emission appearing on a frequency 25 kHz or more removed from the assigned frequency is attenuated at least 30 dB below the unmodulated carrier.
- (c) For equipment designed to operate with a 6.25 kHz channel bandwidth, the sum of the bandwidth occupied by the emitted signal plus the bandwidth required for frequency stability shall be adjusted so that any emission appearing on a frequency 12.5 kHz or more removed from the assigned frequency is attenuated at least 30 dB below the unmodulated carrier.
- (d) Transmitters may be operated in the continuous carrier transmit mode.



U.S. Technologies, Inc.

**FCC ID: SJMC3IW**

Part 90 Certification

Rev: 101404

Issue Date: October 18, 2004

Report Number: 04-0272

Customer: Internet Energy Systems

Model: C3I-W Wireless Transmitter

---

[60 FR 37267, July 19, 1995, as amended at 62 FR 2041, Jan. 15, 1997; 62 FR 18927, Apr. 17,

## **SECTION 2**

# **TESTS AND MEASUREMENTS**

## TEST AND MEASUREMENTS

### 2.1 Configuration of Tested System

Prepared in accordance with the requirements of the FCC Rules and Regulations Part 90-217. All measurements are peak unless stated otherwise. The video filter associated with the spectrum analyzer was off throughout the evaluation process. Interconnecting cables were manipulated as necessary to maximize emissions. A block diagram of the tested system is shown in Figure 1. Test configuration photographs for spurious emissions are shown in Figure 2.

The sample used for testing was received by U.S. Technologies on September 10, 2004 in good condition.

### 2.2 Test Facility

Unless otherwise stated, testing was performed at US Tech's measurement facility at 3505 Francis Circle, Alpharetta, GA. Conducted and digital device testing was performed at US Tech's measurement facility. This site has been fully described and registered by the FCC under Registration Number 91037. Additionally this site has also been fully described and submitted to Industry Canada (IC), and has been approved under file number IC2982.

### 2.3 Test Equipment

Table 2 describes test equipment used to evaluate this product.

### 2.4 Modifications

No modifications were made by US Tech to bring the EUT into compliance with FCC limits for the transmitter portion of the EUT.

Report Number: 04-0272

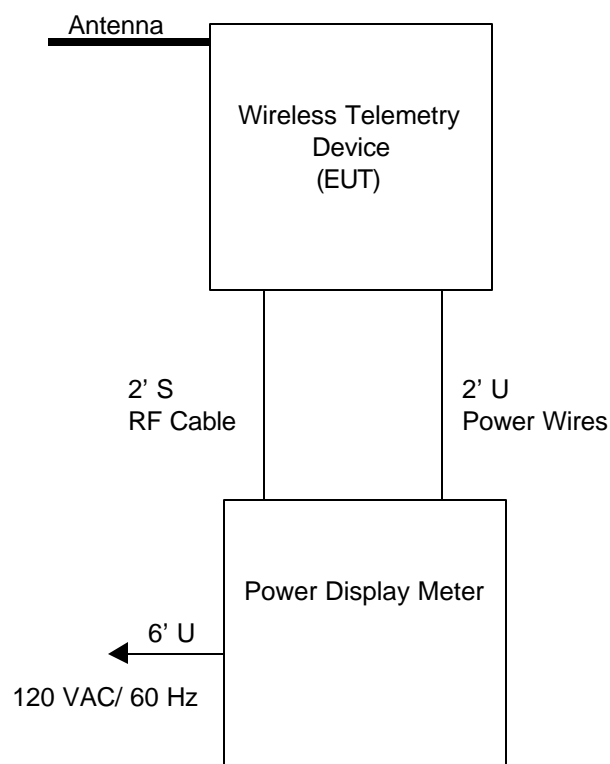
Customer: Internet Energy Systems

Model: C3I-W Wireless Transmitter

---

### FIGURE 1

### TEST CONFIGURATION



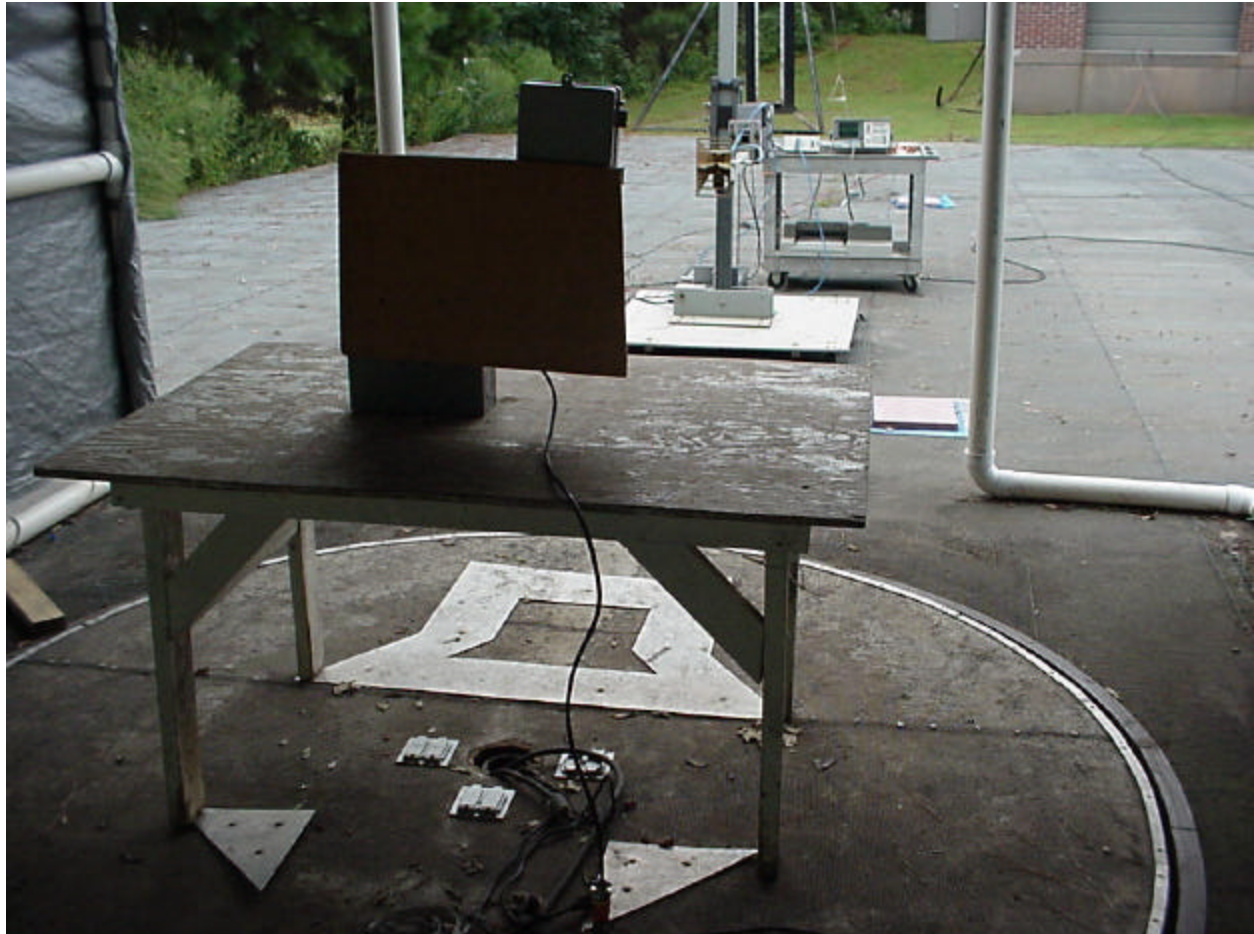
**FIGURE 2a**

**Photograph(s) for Spurious Emissions (Front)**



**FIGURE 2b**

**Photograph(s) for Spurious Emissions**



Report Number: 04-0272

Issue Date: October 18, 2004

Customer: Internet Energy Systems

Model: C3I-W Wireless Transmitter

---

**TABLE 1****EUT and Peripherals**

<b>PERIPHERAL MANUFACTURER</b>	<b>MODEL NUMBER</b>	<b>SERIAL NUMBER</b>	<b>FCC ID:</b>	<b>CABLES P/D</b>
Wireless Telemetry Device (EUT) Internet Energy Systems	C3I-W Wireless Transmitter	Unit 3	FCC ID: SJMC31W (Pending)	None
Power Display Meter ABB	Watt-hour Meter 6C325LA5AA	None	None	None

Report Number: 04-0272

Issue Date: October 18, 2004

Customer: Internet Energy Systems

Model: C3I-W Wireless Transmitter

**TABLE 2  
TEST INSTRUMENTS**

EQUIPMENT	MODEL NUMBER	MANUFACTURER	SERIAL NUMBER	DATE OF LAST CALIBRATION
SPECTRUM ANALYZER	8558B	HEWLETT-PACKARD	2332A10055	2/19/04
SPECTRUM ANALYZER	8593E	HEWLETT-PACKARD	3205A00124	12/30/03
RF PREAMP	8447D	HEWLETT-PACKARD	2944A06291	4/29/04
BICONICAL ANTENNA	3110B	EMCO	9307-1431	5/18/04
LOG PERIODIC ANTENNA	3146	EMCO	9110-3236	6/30/04
PLOTTER	7475A	HEWLETT-PACKARD	2325A65394	N/A
LISN (x 2) 8028-50-TS24-BNC	8028	SOLAR ELE.	910494 & 910495	1/20/04
CALCULATION PROGRAM	N/A	N/A	Ver. 6.0	N/A

**Note: The calibration interval of the above test instruments is 12 months and all calibrations are traceable to NIST/USA.**



Report Number: 04-0272

Customer: Internet Energy Systems

Model: C3I-W Wireless Transmitter

---

## **2.5 Antenna Description**

The unit incorporated a rod antenna, of 1 m length, 0 dBi gain.

## 2.6 RF Power Output (FCC Section 2.1046)

### FCC Minimum Standard

#### FCC Part 90.217

##### **§ 90.217 Exemption from technical standards.**

Except as noted herein, transmitters used at stations licensed below 800 MHz on any frequency listed in subparts B and C of this part or licensed on a business category channel above 800 MHz which have an output power not exceeding 120 milliwatts are exempt from the technical requirements set out in this subpart, but must instead comply with the following:

- (d) For equipment designed to operate with a 25 kHz channel bandwidth, the sum of the bandwidth occupied by the emitted signal plus the bandwidth required for frequency stability shall be adjusted so that any emission appearing on a frequency 40 kHz or more removed from the assigned frequency is attenuated at least 30 dB below the unmodulated carrier.
- (e) For equipment designed to operate with a 12.5 kHz channel bandwidth, the sum of the bandwidth occupied by the emitted signal plus the bandwidth required for frequency stability shall be adjusted so that any emission appearing on a frequency 25 kHz or more removed from the assigned frequency is attenuated at least 30 dB below the unmodulated carrier.
- (f) For equipment designed to operate with a 6.25 kHz channel bandwidth, the sum of the bandwidth occupied by the emitted signal plus the bandwidth required for frequency stability shall be adjusted so that any emission appearing on a frequency 12.5 kHz or more removed from the assigned frequency is attenuated at least 30 dB below the unmodulated carrier.

(d) Transmitters may be operated in the continuous carrier transmit mode.  
[60 FR 37267, July 19, 1995, as amended at 62 FR 2041, Jan. 15, 1997; 62 FR 18927, Apr. 17,

Report Number: 04-0272

Issue Date: October 18, 2004

Customer: Internet Energy Systems

Model: C3I-W Wireless Transmitter

---

**TABLE 3**  
**RF POWER OUTPUT**

Frequency of Fundamental (MHz)	Measurement (dBm)*	Measurement (mW)*	FCC Limit (Watt)
154.390	19.39	86.9	0.120
173.230	14.26	26.7	0.120

**\* Measurement includes 0.1 dB for cable loss**

**Test Date: September 10, 13 & 14, 2004**

**Tester**

**Signature:** 

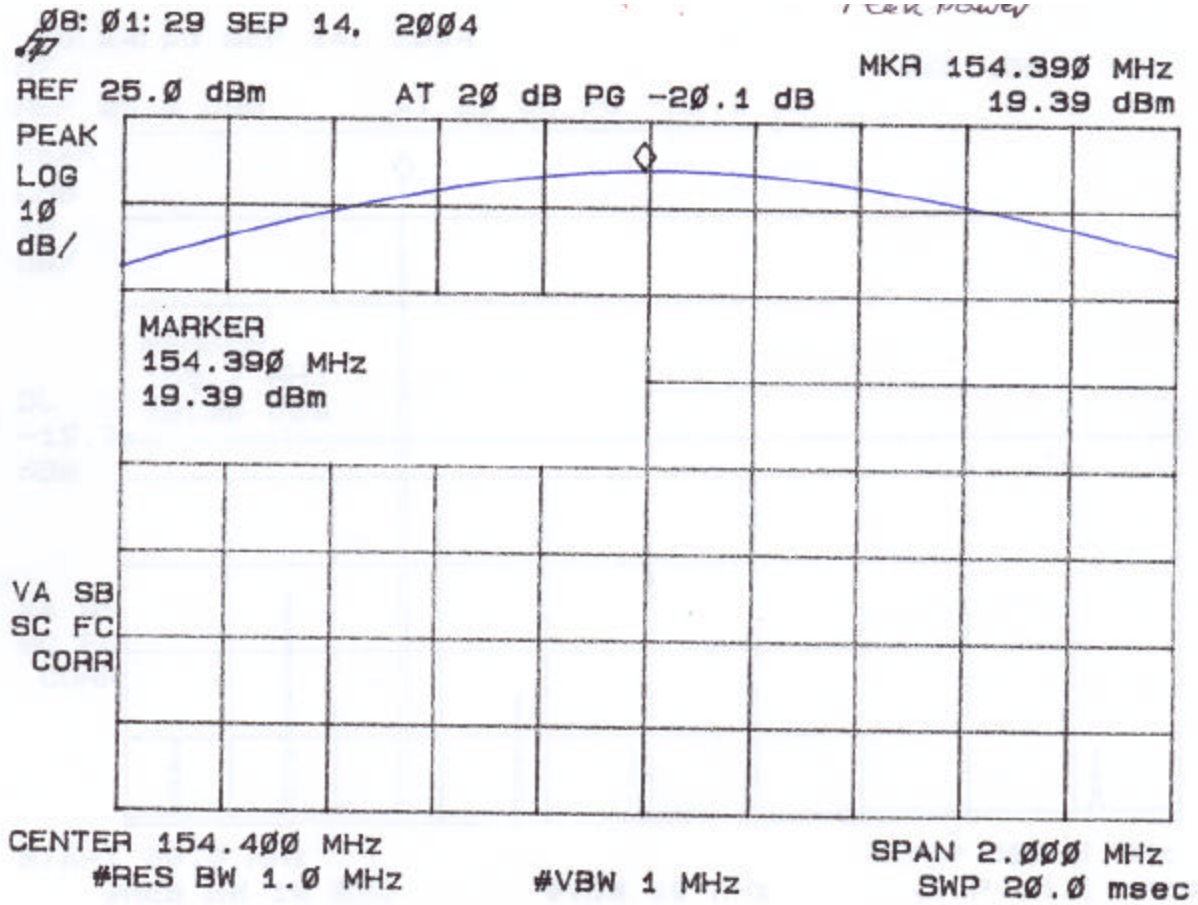
**Name:** David Blethen

Report Number: 04-0272

Customer: Internet Energy Systems

Model: C3I-W Wireless Transmitter

**Figure 3A**  
**154MHz Output Power**

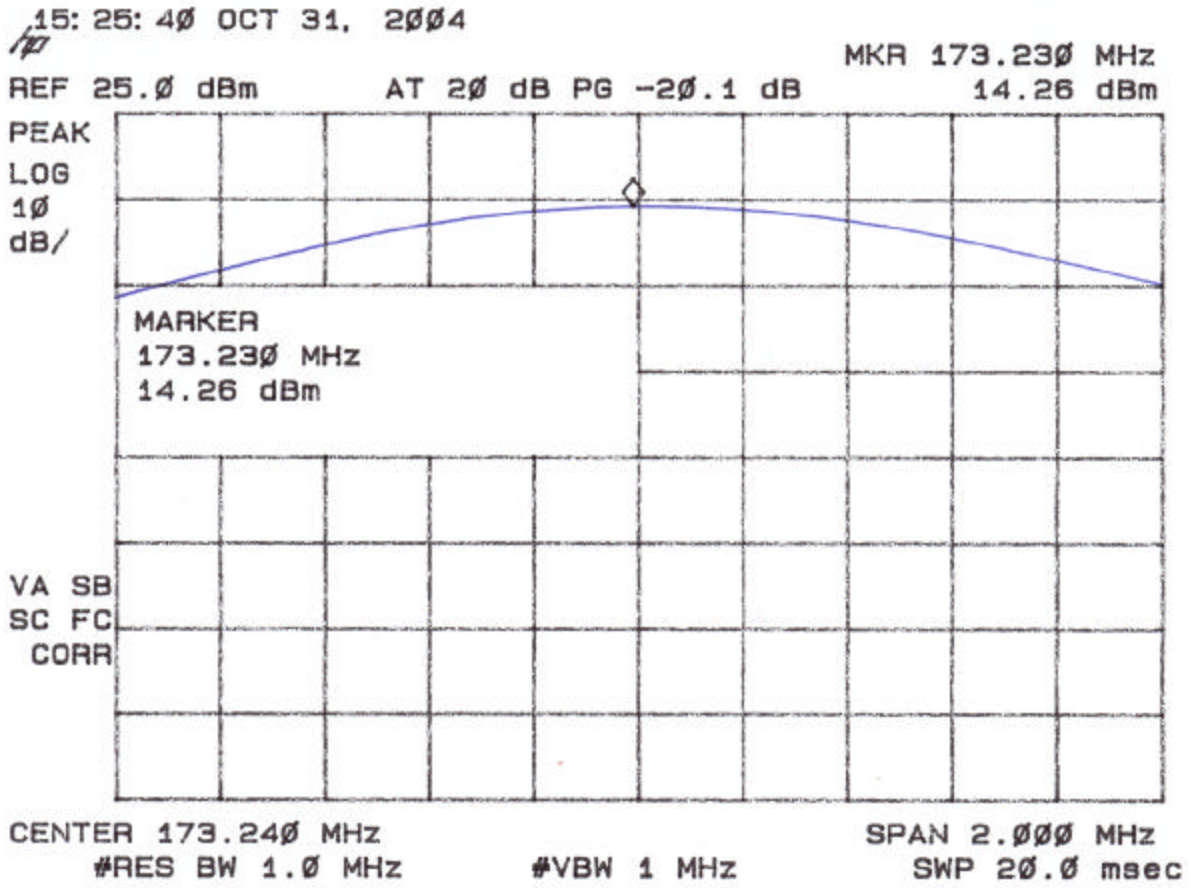


Report Number: 04-0272

Customer: Internet Energy Systems

Model: C3I-W Wireless Transmitter

**Figure 3B**  
**173 MHz Output Power**



Report Number: 04-0272

Customer: Internet Energy Systems

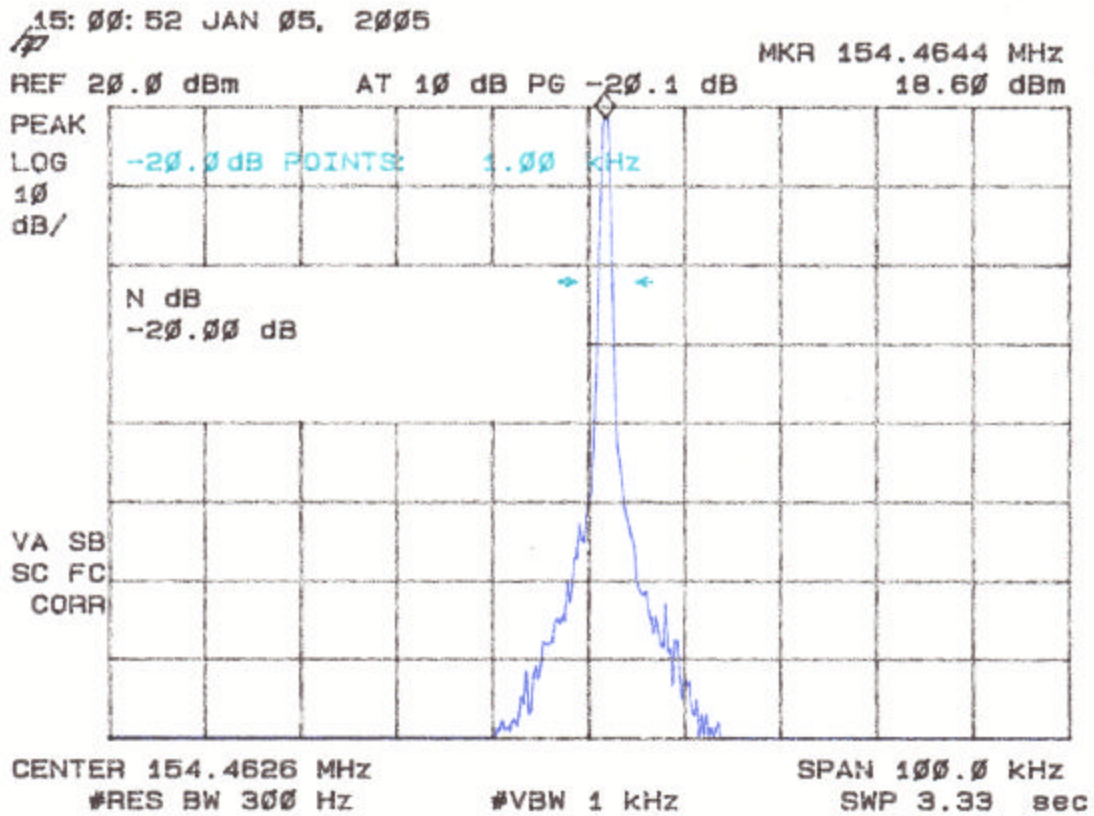
Model: C3I-W Wireless Transmitter

---

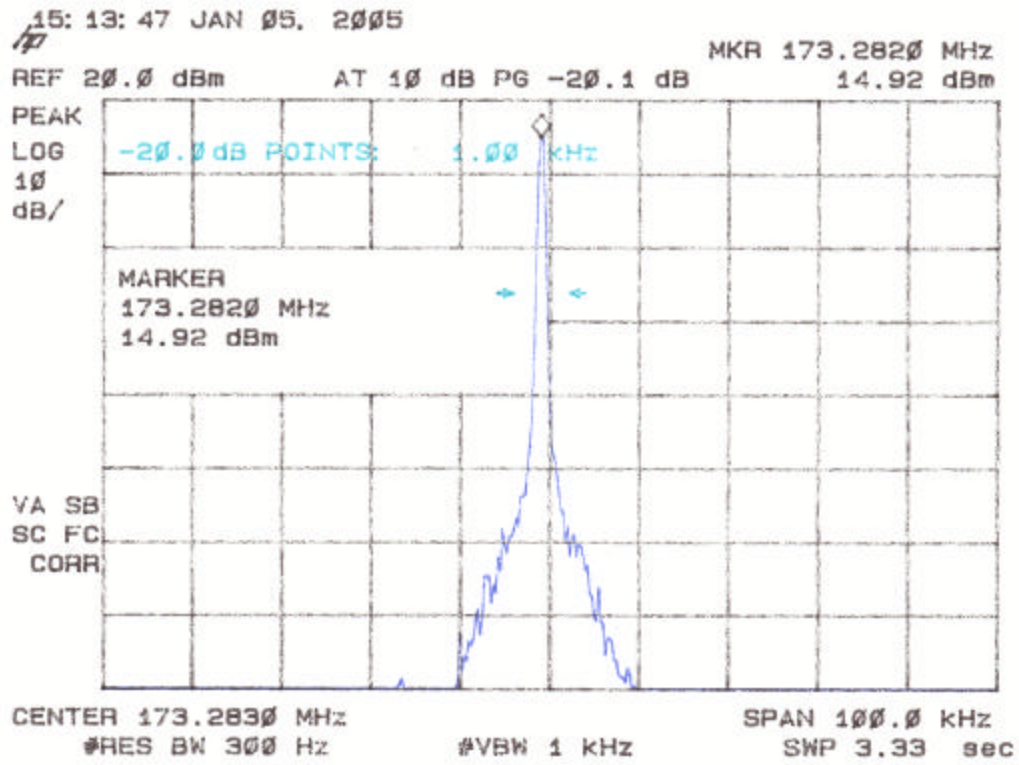
## **2.8 Occupied Bandwidth (FCC Section 2.1049)**

The bandwidth of the fundamental was measured using a spectrum analyzer, as shown in Figure 4a through Figure 4b.

**Figure 4A**  
**Occupied Bandwidth**  
**154 MHz**



**Figure 4B**  
**Occupied Bandwidth**  
**173 MHz**





Report Number: 04-0272

Customer: Internet Energy Systems

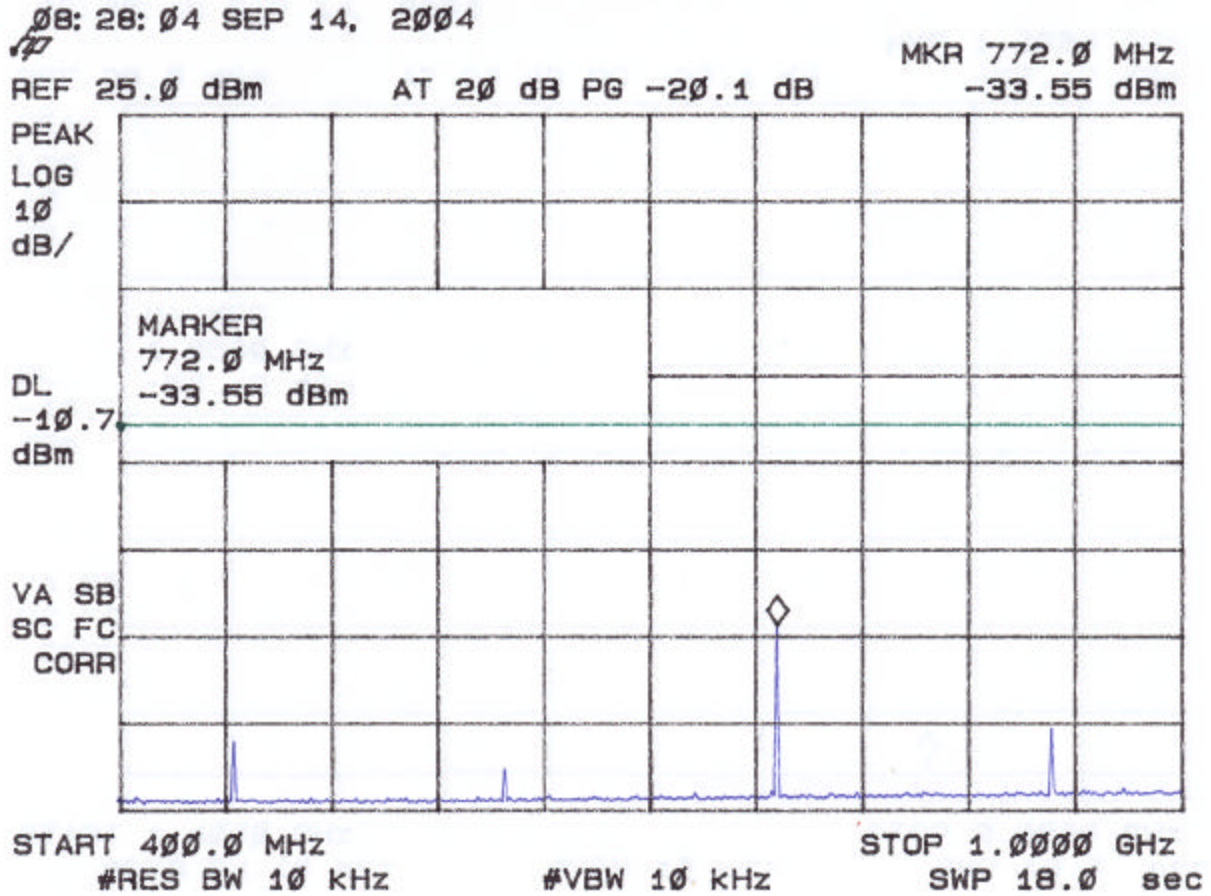
Model: C3I-W Wireless Transmitter

---

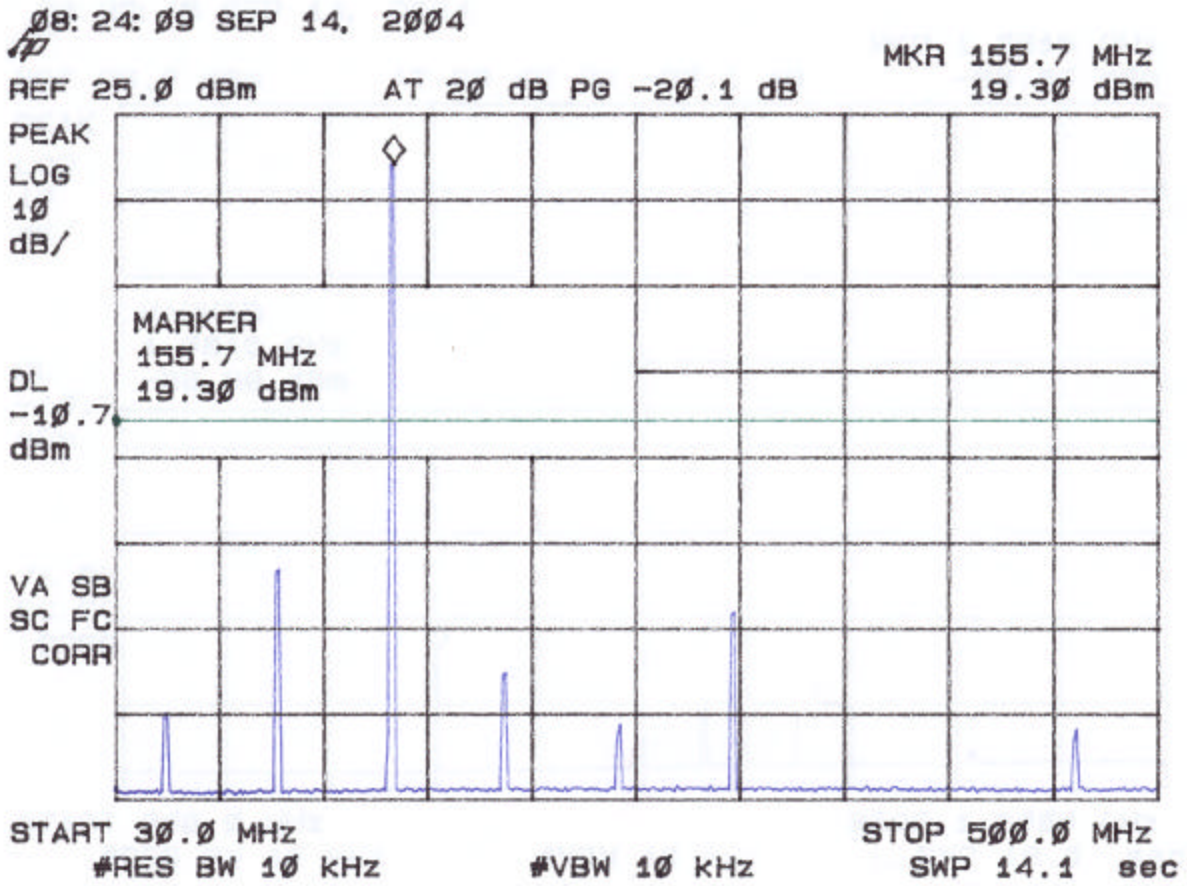
## 2.9 Antenna Conducted Spurious Emission the Frequency Range 30 MHz – 2 GHz

Spurious emissions in the frequency range 30 MHz – 2 GHz have been measured with a spectrum analyzer by connecting the spectrum analyzer directly via a short cable to the antenna output terminals or across the antenna leads on the PCB as specified by the manufacturer. The spectrum analyzer was set for a 50  $\Omega$  impedance with the RBW = 100 kHz & VBW > RBW. All spurious emissions were measured to be greater than 20 dB down from the fundamental. The results of conducted spurious emissions are given in Figure 5A through Figure 5H.

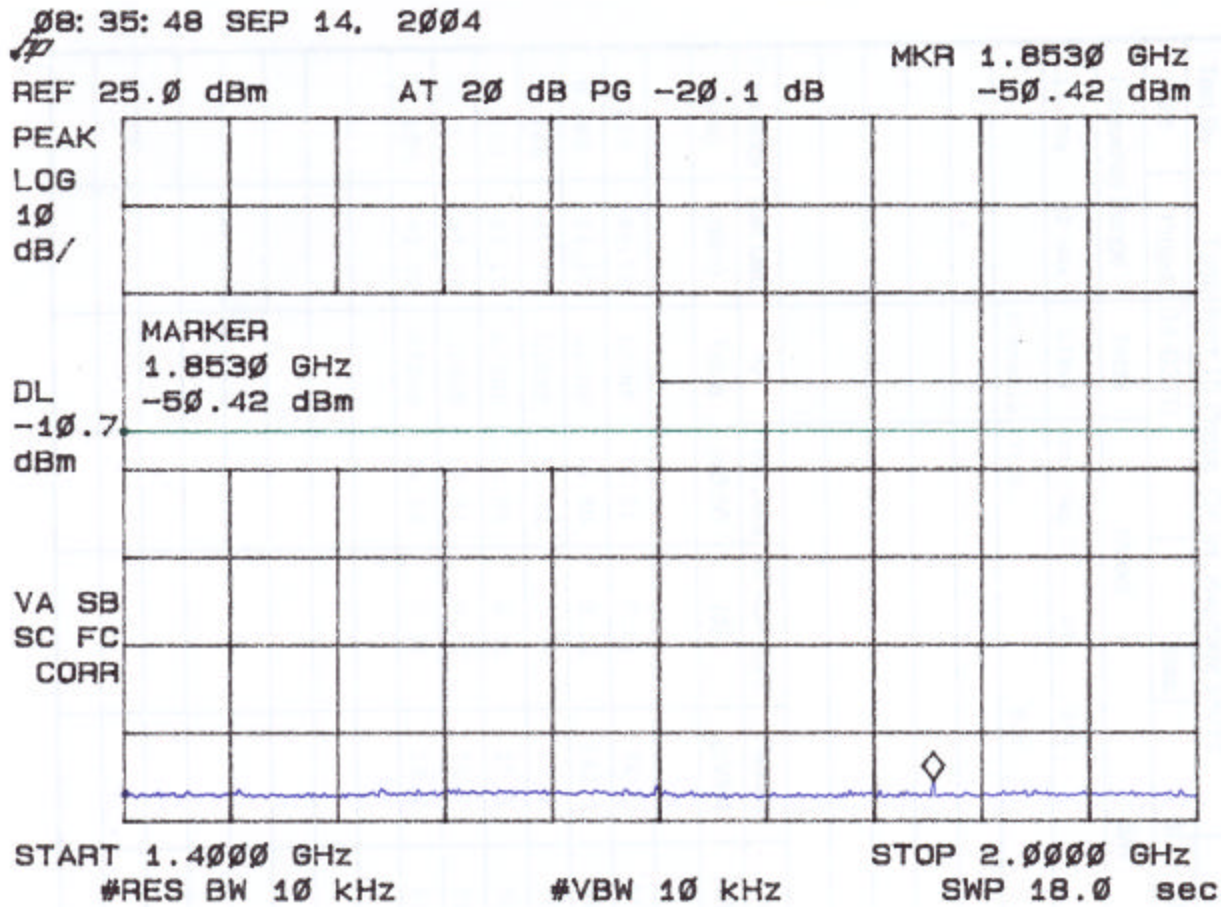
**Figure 5A**  
**Antenna Conducted Spurious Emissions**



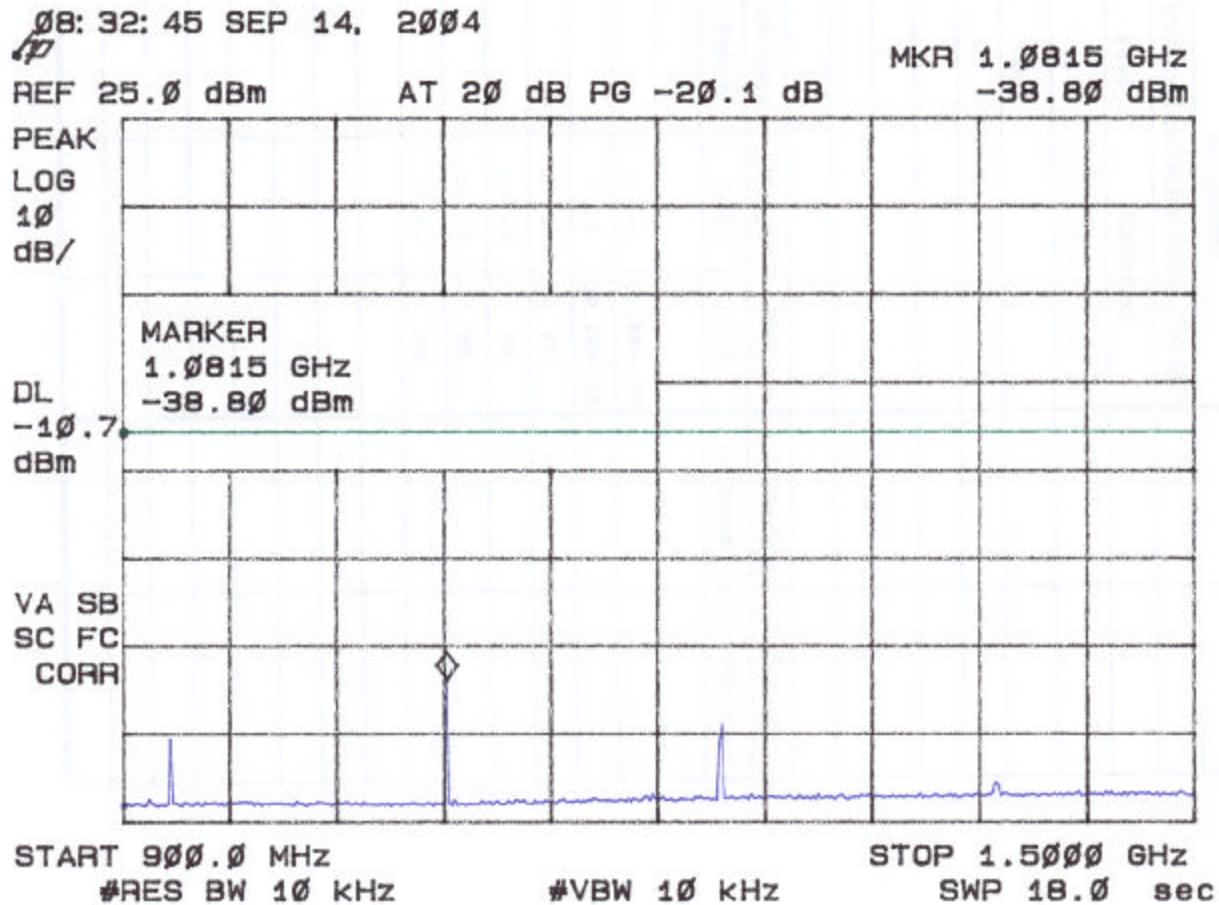
**Figure 5B**  
**Antenna Conducted Spurious Emissions**



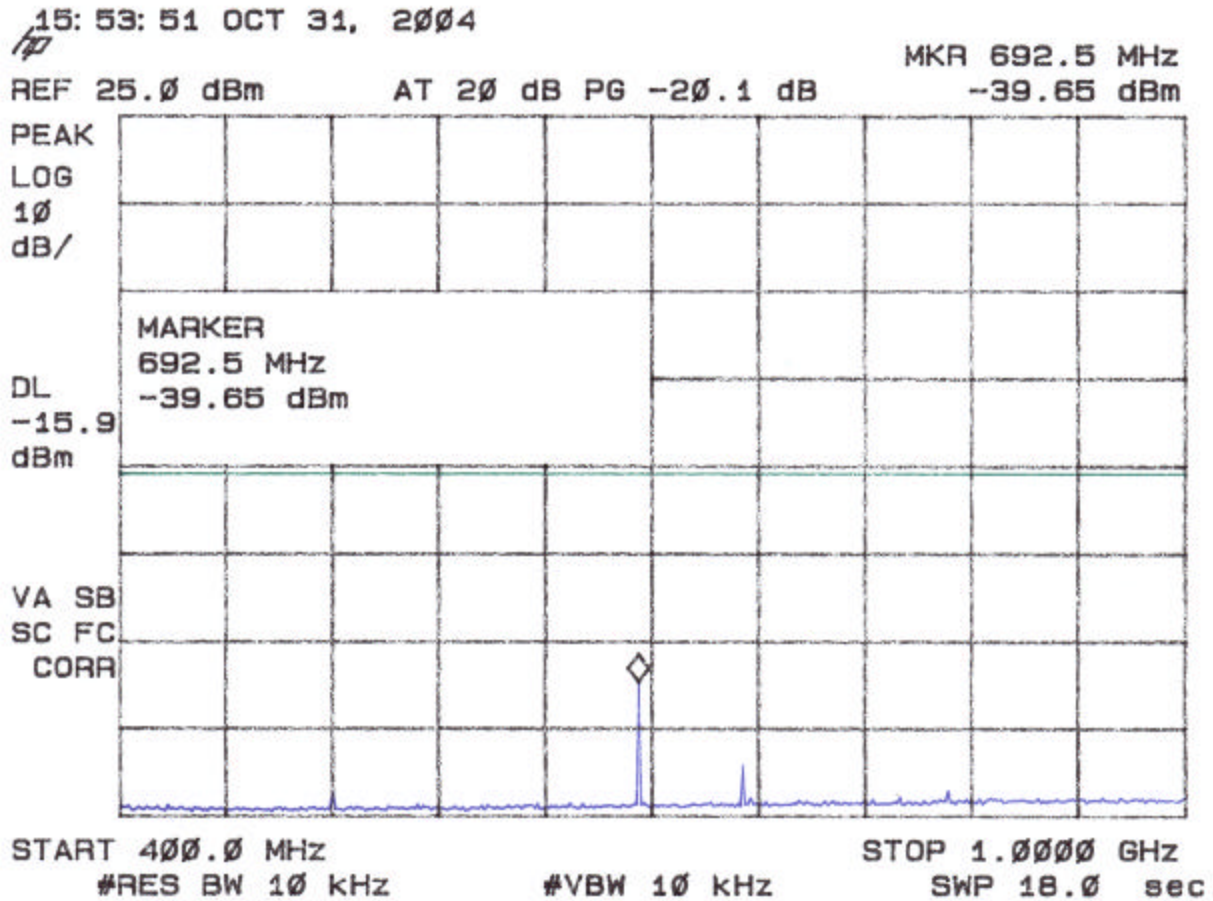
**Figure 5C**  
**Antenna Conducted Spurious Emissions**



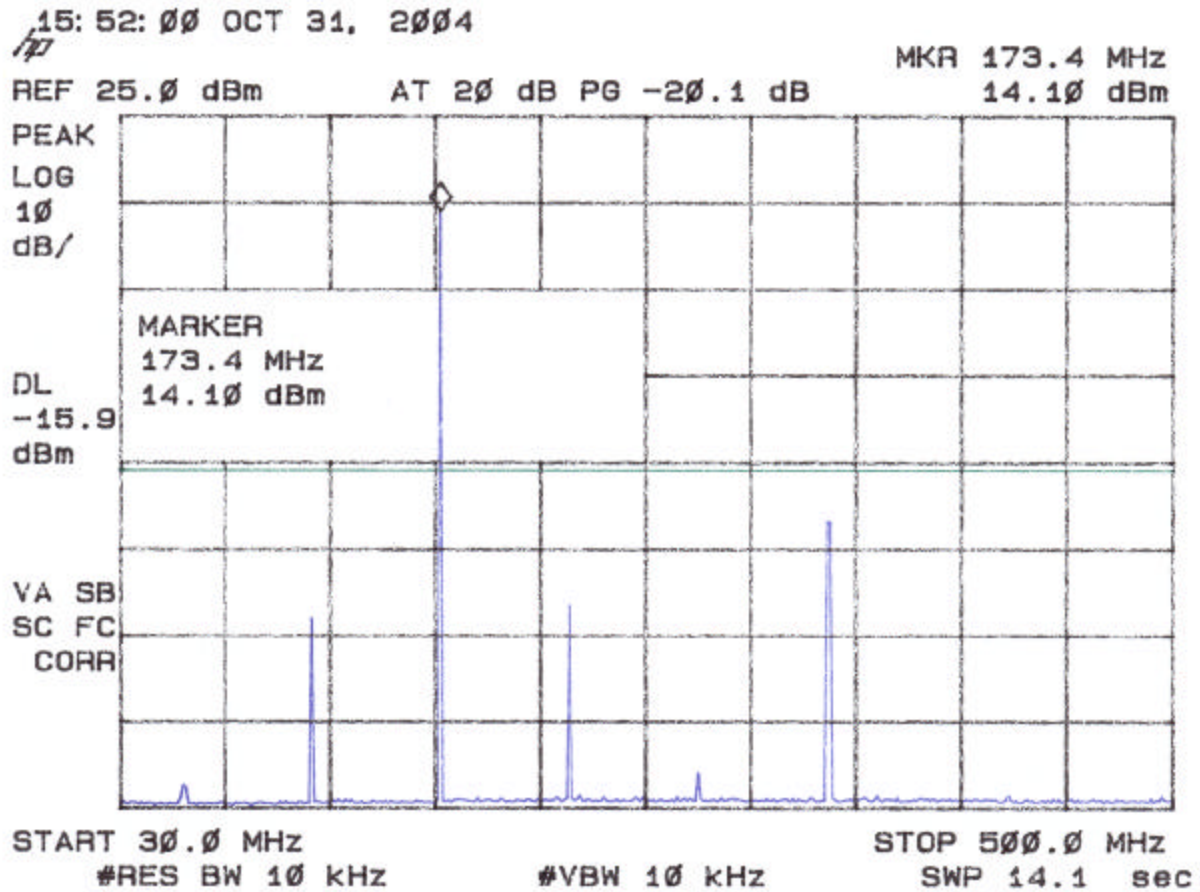
**Figure 5D**  
**Antenna Conducted Spurious Emissions**



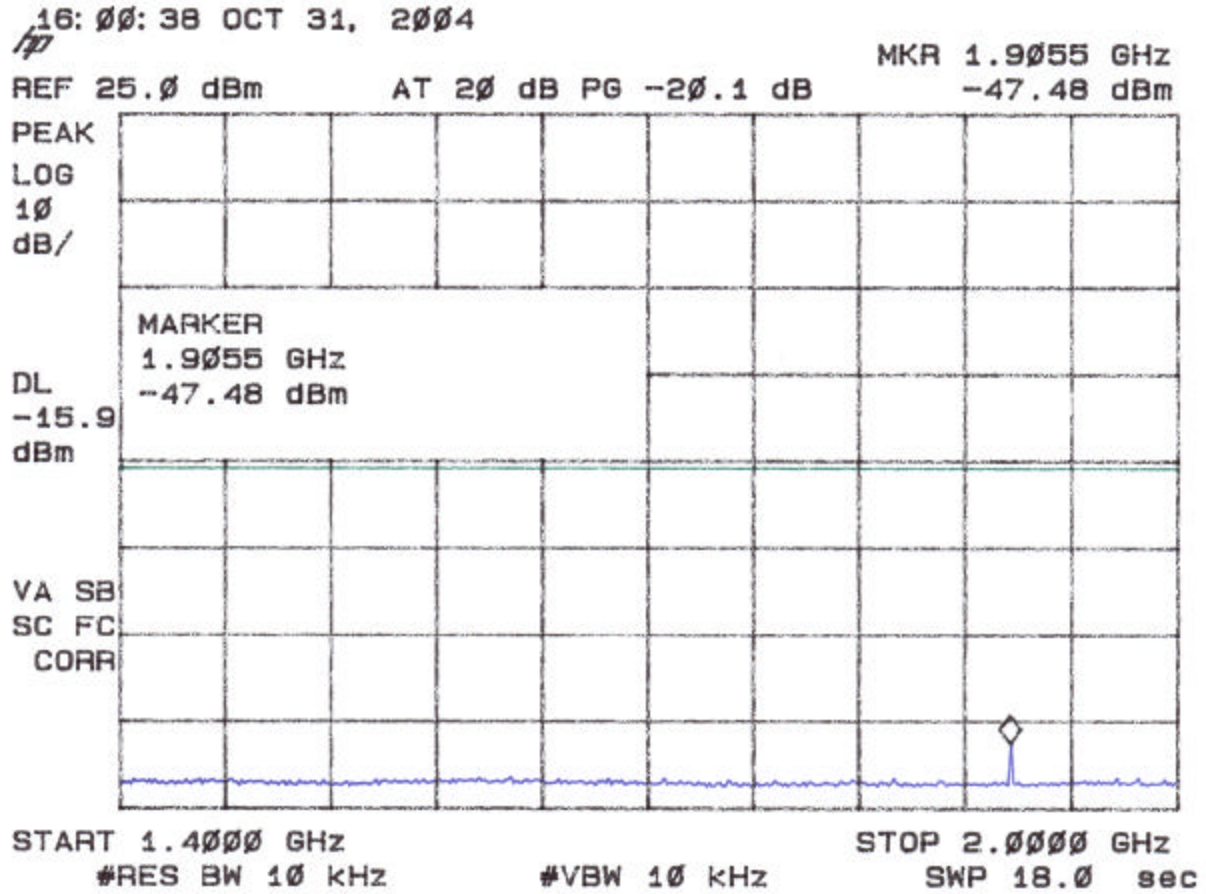
**Figure 5E**  
**Antenna Conducted Spurious Emissions**



**Figure 5F**  
**Antenna Conducted Spurious Emissions**

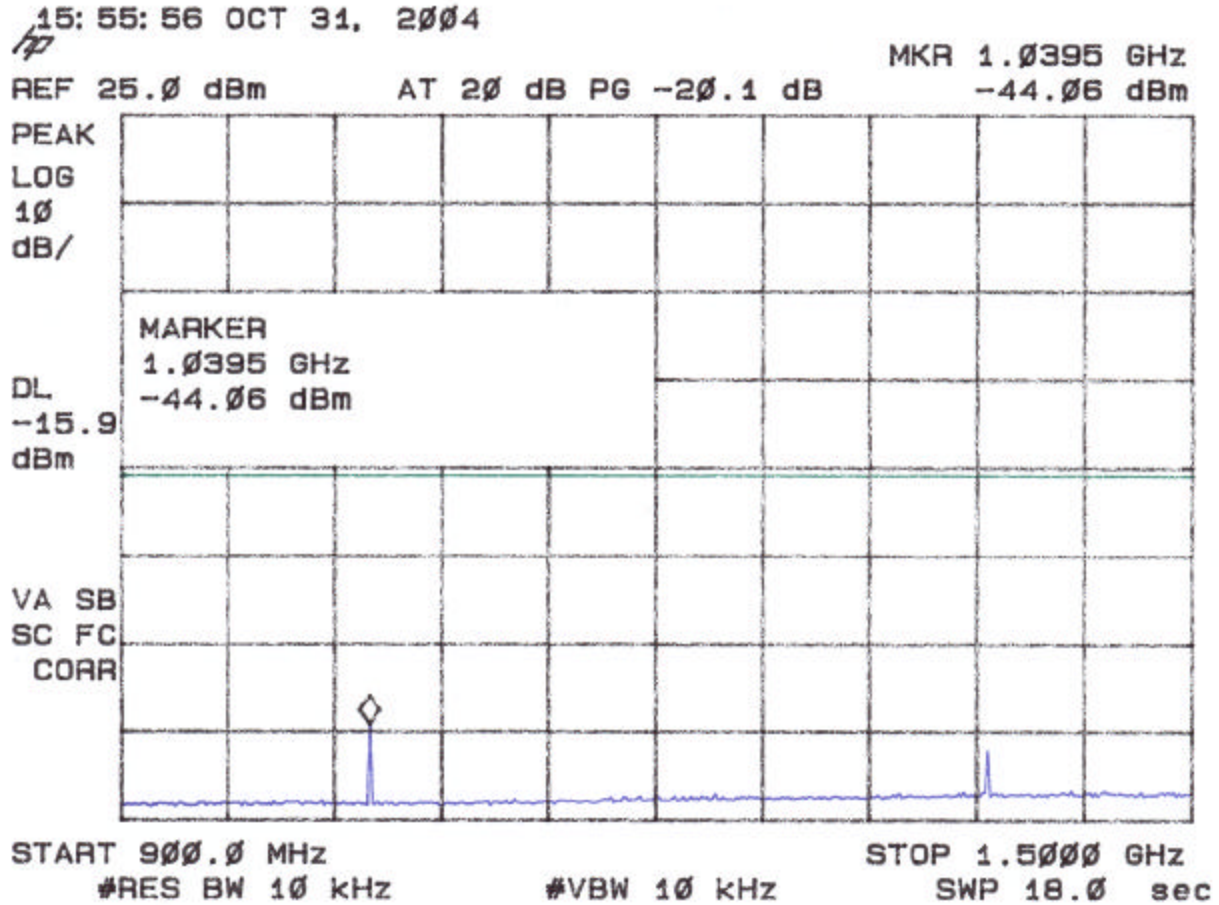


**Figure 5G**  
**Antenna Conducted Spurious Emissions**





**Figure 5H**  
**Antenna Conducted Spurious Emissions**



## 2.10 Field Strength of Spurious Radiation (FCC Section 2.1053)

Spurious emissions were evaluated from 30 MHz to 1.8 GHz at an EUT to antenna distance of 3 meters. The EUT was tested modulated by its own internal sources. The EUT was placed on an open area test site and the spurious emissions tested with the antenna terminated with a 50 Ohm load as stipulated by EIT/TIA-603:2001 section 2.2.12. Measurements for 30 to 1000 MHz were made with the analyzer's bandwidth at 10 kHz and video bandwidth set to 300 kHz. The EUT's emissions were recreated with a signal generator and transmit antenna and the power recorded by the substitution method. Measurements above 1 GHz were made with the analyzer's resolution bandwidth set to 1 MHz.

### FCC Minimum Standard

90.217 states in all cases an attenuation of 30dB below the unmodulated carrier.

**NOTE: In general, the worse case attenuation requirement shown above was applied.**

Report Number: 04-0272

Issue Date: October 18, 2004

Customer: Internet Energy Systems

Model: C3I-W Wireless Transmitter

**FIELD STRENGTH OF SPURIOUS RADIATION****Table 4****30 MHz – 2 GHz (154 MHz Unit)**

Frequency (MHz)	Test Data (dBm) @3m	Ant. Factor + Cable Atten. - Amp Gain	Results (uV/m)	FCC Limits (uV/m) @3m	Margin Below FCC Limit (dB)
154.43	-6.90	16.10	645557.5		
308.89	-82.43	19.57	160.3	20414.3	42.10
463.34	-71.95	22.27	734.7	20414.3	28.88
617.82	-63.30	25.35	2835.6	20414.3	17.5
772.28	-67.47	28.66	2566.5	20414.3	18.01
926.73	-73.94	31.58	1705.6	20414.3	21.56
1081.23	-29.94	-10.53	2234.3	20414.3	19.22
1235.66	-48.31	-10.01	271.7	20414.3	37.52
13980.1	-56.24	-9.49	115.8	20414.3	44.93
1544.56	-56.14	-8.93	124.8	20414.3	44.27

**SAMPLE CALCULATIONS:**RESULTS uV/m @ 3m = Antilog  $((-82.43 + 24.57 + 107)/20) = 160.3$ 

CONVERSION FROM dBm TO dBuV = 107 dB

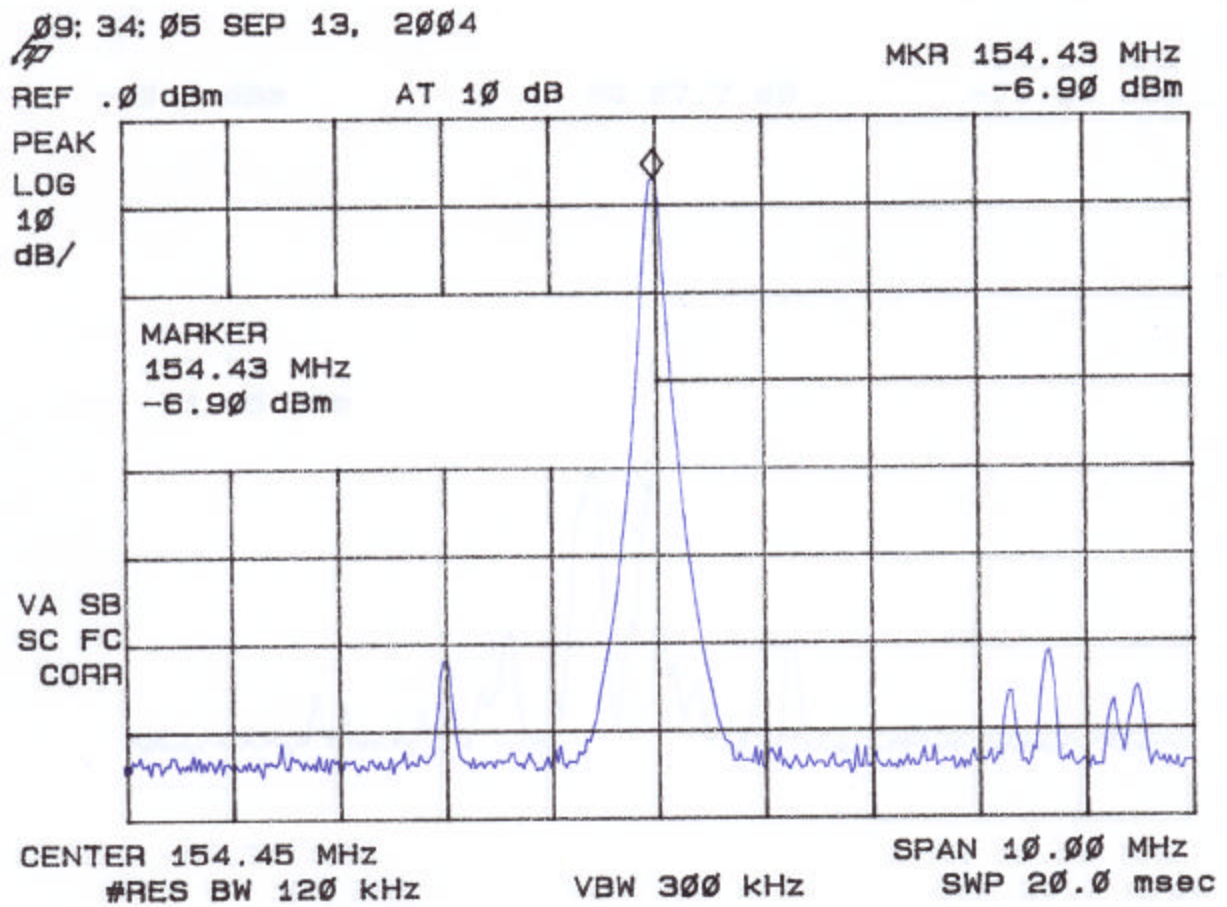
Test Date: September 14, 2004

Tested by

Signature: David P. BlethenName: David Blethen

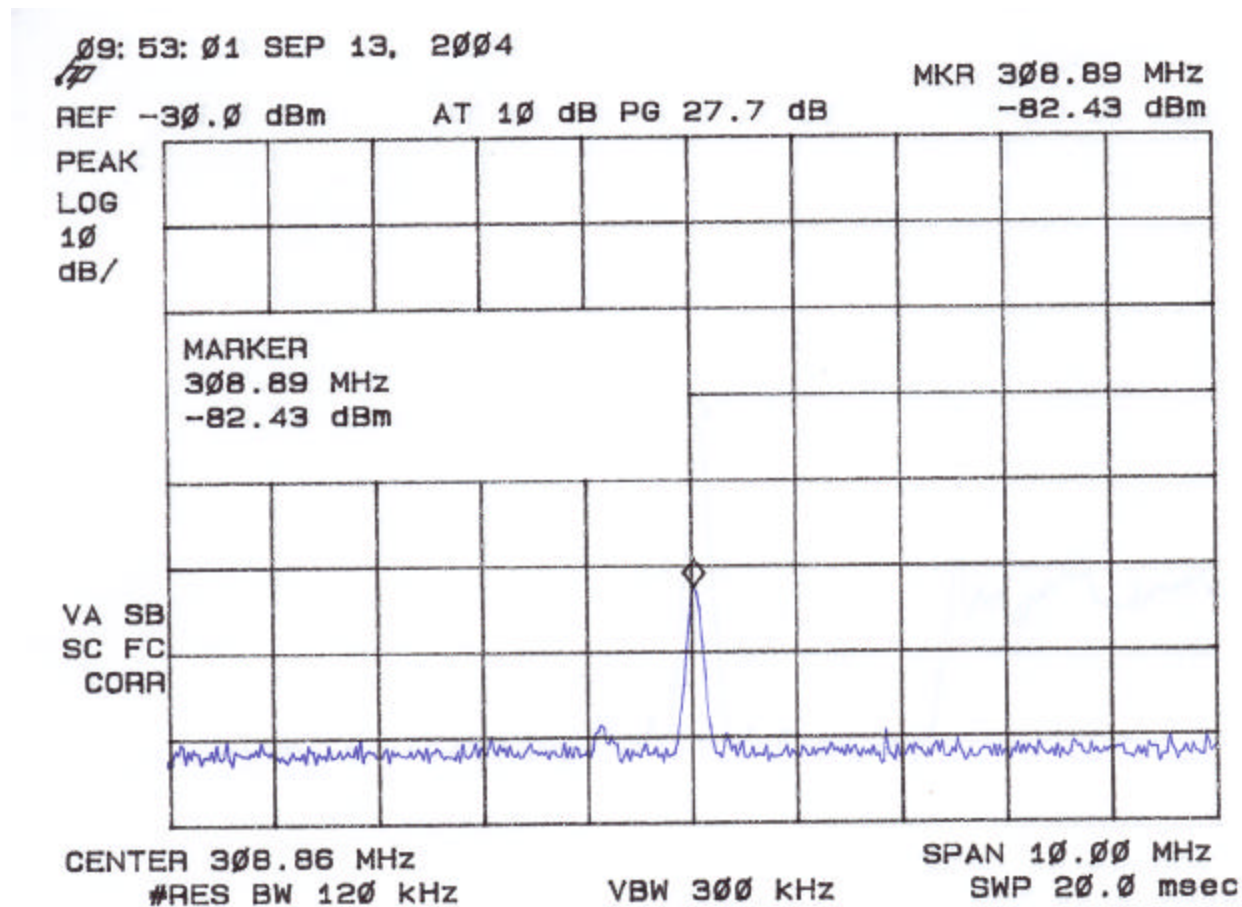
### FIELD STRENGTH OF SPURIOUS RADIATION

Figure 6A



### FIELD STRENGTH OF SPURIOUS RADIATION

Figure 6B



### FIELD STRENGTH OF SPURIOUS RADIATION

Figure 6C

