



# FCC TEST REPORT

**REPORT NO.:** RF970324L12

**MODEL NO.:** MZK-W300NH

**RECEIVED:** Mar. 20, 2008

**TESTED:** Mar. 20 ~ Apr. 05, 2008

**ISSUED:** Apr. 10, 2008

**APPLICANT:** PLANEX COMMUNICATIONS INC.

**ADDRESS:** 9F-1, No.188, Baociao Rd., Sindian City, Taipei  
County 231, Taiwan

**ISSUED BY:** Advance Data Technology Corporation

**LAB ADDRESS:** No.47, 14<sup>th</sup> Ling, Chia Pau Tsuen, Lin Kou  
Hsiang 244, Taipei Hsien, Taiwan, R.O.C.

**TEST LOCATION:** No. 19, Hwa Ya 2<sup>nd</sup> Rd, Wen Hwa Tsuen, Kwei  
Shan Hsiang, Taoyuan Hsien 333, Taiwan,  
R.O.C.

This test report consists of 86 pages in total. It may be duplicated completely for legal use with the approval of the applicant. It should not be reproduced except in full, without the written approval of our laboratory. The client should not use it to claim product endorsement by TAF, A2LA or any government agencies. The test results in the report only apply to the tested sample.





## TABLE OF CONTENTS

1.	CERTIFICATION .....	4
2.	SUMMARY OF TEST RESULTS .....	5
2.1	MEASUREMENT UNCERTAINTY .....	5
3.	GENERAL INFORMATION .....	6
3.1	GENERAL DESCRIPTION OF EUT .....	6
3.2	DESCRIPTION OF TEST MODES .....	7
3.2.1	CONFIGURATION OF SYSTEM UNDER TEST .....	7
3.2.2	TEST MODE APPLICABILITY AND TESTED CHANNEL DETAIL .....	8
3.3	GENERAL DESCRIPTION OF APPLIED STANDARDS .....	10
3.4	DESCRIPTION OF SUPPORT UNITS .....	10
4.	TEST TYPES AND RESULTS .....	11
4.1	RADIATED EMISSION MEASUREMENT .....	11
4.1.1	LIMITS OF RADIATED EMISSION MEASUREMENT .....	11
4.1.2	TEST INSTRUMENTS .....	12
4.1.3	TEST PROCEDURES .....	13
4.1.4	DEVIATION FROM TEST STANDARD .....	13
4.1.5	TEST SETUP .....	14
4.1.6	EUT OPERATING CONDITIONS .....	14
4.1.7	TEST RESULTS .....	15
4.2	CONDUCTED EMISSION MEASUREMENT .....	28
4.2.1	LIMITS OF CONDUCTED EMISSION MEASUREMENT .....	28
4.2.2	TEST INSTRUMENTS .....	28
4.2.3	TEST PROCEDURES .....	29
4.2.4	DEVIATION FROM TEST STANDARD .....	29
4.2.5	TEST SETUP .....	30
4.2.6	EUT OPERATING CONDITIONS .....	30
4.2.7	TEST RESULTS .....	31
4.3	6dB BANDWIDTH MEASUREMENT .....	33
4.3.1	LIMITS OF 6dB BANDWIDTH MEASUREMENT .....	33
4.3.2	TEST INSTRUMENTS .....	33
4.3.3	TEST PROCEDURE .....	33
4.3.4	DEVIATION FROM TEST STANDARD .....	33
4.3.5	TEST SETUP .....	34
4.3.6	EUT OPERATING CONDITIONS .....	34
4.3.7	TEST RESULTS .....	35
4.4	MAXIMUM PEAK OUTPUT POWER .....	47
4.4.1	LIMITS OF MAXIMUM PEAK OUTPUT POWER MEASUREMENT .....	47
4.4.2	INSTRUMENTS .....	47
4.4.3	TEST PROCEDURES .....	47
4.4.4	DEVIATION FROM TEST STANDARD .....	47
4.4.5	TEST SETUP .....	48
4.4.6	EUT OPERATING CONDITIONS .....	48



4.4.7	TEST RESULTS .....	49
4.5	POWER SPECTRAL DENSITY MEASUREMENT .....	51
4.5.1	LIMITS OF POWER SPECTRAL DENSITY MEASUREMENT .....	51
4.5.2	TEST INSTRUMENTS .....	51
4.5.3	TEST PROCEDURE .....	51
4.5.4	DEVIATION FROM TEST STANDARD .....	51
4.5.5	TEST SETUP .....	52
4.5.6	EUT OPERATING CONDITION .....	52
4.5.7	TEST RESULTS .....	53
4.6	BAND EDGES MEASUREMENT .....	65
4.6.1	LIMITS OF BAND EDGES MEASUREMENT .....	65
4.6.2	TEST INSTRUMENTS .....	65
4.6.3	TEST PROCEDURE .....	66
4.6.4	DEVIATION FROM TEST STANDARD .....	66
4.6.5	EUT OPERATING CONDITION .....	67
4.6.6	TEST RESULTS .....	67
4.7	ANTENNA REQUIREMENT .....	83
4.7.1	STANDARD APPLICABLE .....	83
4.7.2	ANTENNA CONNECTED CONSTRUCTION .....	83
5.	PHOTOGRAPHS OF THE TEST CONFIGURATION .....	84
6.	INFORMATION ON THE TESTING LABORATORIES .....	85
7.	APPENDIX A - MODIFICATIONS RECORDERS FOR ENGINEERING CHANGES TO THE EUT BY THE LAB.....	86



# 1. CERTIFICATION

**PRODUCT:** IEEE802.11n Wireless Broadband Router  
**MODEL:** MZK-W300NH  
**BRAND:** PCI  
**APPLICANT:** PLANEX COMMUNICATIONS INC.  
**TESTED:** Mar. 20 ~ Apr. 05, 2008  
**TEST SAMPLE:** ENGINEERING SAMPLE  
**STANDARDS: FCC Part 15, Subpart C (Section 15.247)**  
ANSI C63.4-2003

The above equipment (model: MZK-W300NH) has been tested by **Advance Data Technology Corporation**, and found compliance with the requirement of the above standards. The test record, data evaluation & Equipment Under Test (EUT) configurations represented herein are true and accurate accounts of the measurements of the sample's EMC characteristics under the conditions specified in this report.

**PREPARED BY** : Andrea Hsia , **DATE:** Apr. 10, 2008  
Andrea Hsia / Specialist

**TECHNICAL ACCEPTANCE** : Long Chen , **DATE:** Apr. 10, 2008  
Responsible for RF Long Chen / Senior Engineer

**APPROVED BY** : Gary Chang , **DATE:** Apr. 10, 2008  
Gary Chang / Assistant Manager

## 2. SUMMARY OF TEST RESULTS

The EUT has been tested according to the following specifications:

APPLIED STANDARD: FCC Part 15, Subpart C			
Standard Section	Test Type and Limit	Result	Remark
15.207	AC Power Conducted Emission	PASS	Meet the requirement of limit. Minimum passing margin is -11.69dB at 0.595MHz.
15.247(a)(2)	Spectrum Bandwidth of a Direct Sequence Spread Spectrum System Limit: min. 500kHz	PASS	Meet the requirement of limit.
15.247(b)	Maximum Peak Output Power Limit: max. 30dBm	PASS	Meet the requirement of limit.
15.247(d)	Radiated Emissions Limit: Table 15.209	PASS	Meet the requirement of limit. Minimum passing margin is -1.37dB at 2390.00MHz.
15.247(e)	Power Spectral Density Limit: max. 8dBm	PASS	Meet the requirement of limit.
15.247(d)	Band Edge Measurement Limit: 20dB less than the peak value of fundamental frequency	PASS	Meet the requirement of limit.

### 2.1 MEASUREMENT UNCERTAINTY

Where relevant, the following measurement uncertainty levels have been estimated for tests performed on the EUT as specified in CISPR 16-4-2:

MEASUREMENT	FREQUENCY	UNCERTAINTY
Conducted emissions	9kHz ~ 30MHz	2.44 dB
Radiated emissions	30MHz ~ 200MHz	2.93 dB
	200MHz ~ 1000MHz	2.95 dB
	1GHz ~ 18GHz	2.26 dB
	18GHz ~ 40GHz	1.94 dB

This uncertainty represents an expanded uncertainty expressed at approximately the 95% confidence level using a coverage factor of k=2.

### 3. GENERAL INFORMATION

#### 3.1 GENERAL DESCRIPTION OF EUT

<b>PRODUCT</b>	IEEE802.11n Wireless Broadband Router
<b>MODEL NO.</b>	MZK-W300NH
<b>FCC ID</b>	SJ9-MZKW300NH
<b>POWER SUPPLY</b>	5Vdc from AC Adapter
<b>MODULATION TYPE</b>	CCK, DQPSK, DBPSK for DSSS 64QAM, 16QAM, QPSK, BPSK for OFDM
<b>MODULATION TECHNOLOGY</b>	DSSS, OFDM
<b>TRANSFER RATE</b>	802.11b: 11.0/ 5.5/ 2.0/ 1.0Mbps 802.11g: 54.0/ 48.0/ 36.0/ 24.0/ 18.0/ 12.0/ 9.0/ 6.0Mbps Draft 802.11n: up to 300.0Mbps
<b>FREQUENCY RANGE</b>	2412MHz ~ 2462MHz
<b>NUMBER OF CHANNEL</b>	11 for 802.11b, 802.11g, draft 802.11n (20MHz) 7 for draft 802.11n (40MHz)
<b>MAXIMUM OUTPUT POWER</b>	124.496mW
<b>ANTENNA TYPE</b>	Dipole antenna with 3dBi gain
<b>DATA CABLE</b>	NA
<b>I/O PORTS</b>	RJ45
<b>ACCESSORY DEVICES</b>	Adapter

**NOTE:**

- The EUT was powered by the following adapter:

<b>BRAND:</b>	PCI
<b>MODEL:</b>	AF 1805-B
<b>INPUT:</b>	100-240Vac, 50/60Hz, 0.4A
<b>OUTPUT:</b>	5Vdc, 2.5A
<b>POWER LINE:</b>	DC 1.8m non-shielded cable without core

- The EUT incorporates a MIMO function. Physically, the EUT provides two completed transmitters and two receivers.

	1TX	2TX
<b>802.11b</b>	√	-
<b>802.11g</b>	√	-
<b>Draft 802.11n (20MHz)</b>	-	√
<b>Draft 802.11n (40MHz)</b>	-	√

- The above EUT information was declared by manufacturer and for more detailed features description, please refer to the manufacturer's specifications or user's manual.

### 3.2 DESCRIPTION OF TEST MODES

Eleven channels are provided for 802.11b, 802.11g and draft 802.11n (20MHz):

CHANNEL	FREQUENCY	CHANNEL	FREQUENCY
1	2412MHz	7	2442MHz
2	2417MHz	8	2447MHz
3	2422MHz	9	2452MHz
4	2427MHz	10	2457MHz
5	2432MHz	11	2462MHz
6	2437MHz		

Seven channels are provided for draft 802.11n (40MHz):

CHANNEL	FREQUENCY	CHANNEL	FREQUENCY
1	2422MHz	5	2442MHz
2	2427MHz	6	2447MHz
3	2432MHz	7	2452MHz
4	2437MHz		

#### 3.2.1 CONFIGURATION OF SYSTEM UNDER TEST

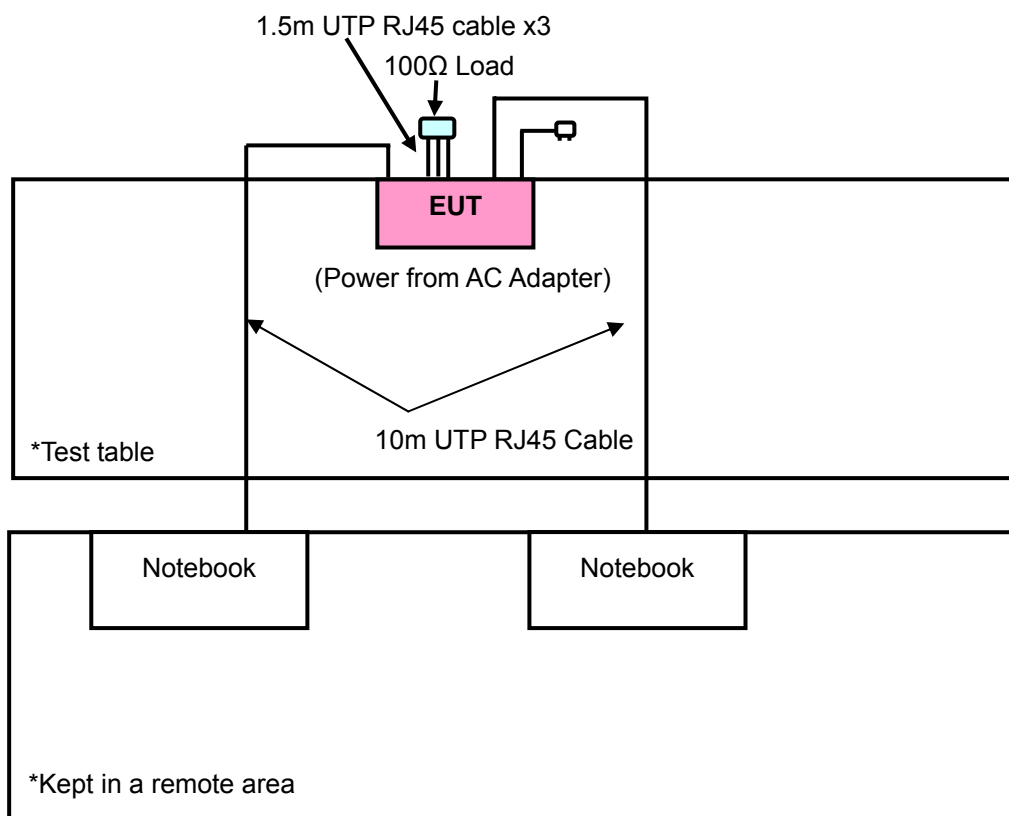

### 3.2.2 TEST MODE APPLICABILITY AND TESTED CHANNEL DETAIL

EUT CONFIGURE MODE	APPLICABLE TO				DESCRIPTION
	RE $\geq$ 1G	RE<1G	PLC	APCM	
-	√	√	√	√	-

Where **PLC**: Power Line Conducted Emission      **RE<1G**: Radiated Emission below 1GHz  
**RE $\geq$ 1G**: Radiated Emission above 1GHz      **APCM**: Antenna Port Conducted Measurement

#### **RADIATED EMISSION TEST (ABOVE 1 GHz):**

- Pre-Scan has been conducted to determine the worst-case mode from all possible combinations between available modulations, data rates, and antenna ports (if EUT with antenna diversity architecture).
- Following channel(s) was (were) selected for the final test as listed below.

MODE	AVAILABLE CHANNEL	TESTED CHANNEL	MODULATION TECHNOLOGY	MODULATION TYPE	DATA RATE (Mbps)
802.11b	1 to 11	1, 6, 11	DSSS	DBPSK	1
802.11g	1 to 11	1, 6, 11	OFDM	BPSK	6
Draft 802.11n (20MHz)	1 to 11	1, 6, 11	OFDM	BPSK	7.2
Draft 802.11n (40MHz)	1 to 7	1, 4, 7	OFDM	BPSK	15

#### **RADIATED EMISSION TEST (BELOW 1 GHz):**

- Pre-Scan has been conducted to determine the worst-case mode from all possible combinations between available modulations, data rates, and antenna ports (if EUT with antenna diversity architecture).
- Following channel(s) was (were) selected for the final test as listed below.

MODE	AVAILABLE CHANNEL	TESTED CHANNEL	MODULATION TECHNOLOGY	MODULATION TYPE	DATA RATE (Mbps)
Draft 802.11n (20MHz)	1 to 11	6	OFDM	BPSK	7.2

#### **POWER LINE CONDUCTED EMISSION TEST:**

- Pre-Scan has been conducted to determine the worst-case mode from all possible combinations between available modulations, data rates, and antenna ports (if EUT with antenna diversity architecture).
- Following channel(s) was (were) selected for the final test as listed below.

MODE	AVAILABLE CHANNEL	TESTED CHANNEL	MODULATION TECHNOLOGY	MODULATION TYPE	DATA RATE (Mbps)
Draft 802.11n (20MHz)	1 to 11	6	OFDM	BPSK	7.2



**BANDEDGE MEASUREMENT:**

- Pre-Scan has been conducted to determine the worst-case mode from all possible combinations between available modulations, data rates, and antenna ports (if EUT with antenna diversity architecture).
- Following channel(s) was (were) selected for the final test as listed below.

MODE	AVAILABLE CHANNEL	TESTED CHANNEL	MODULATION TECHNOLOGY	MODULATION TYPE	DATA RATE (Mbps)
802.11b	1 to 11	1, 11	DSSS	DBPSK	1
802.11g	1 to 11	1, 11	OFDM	BPSK	6
Draft 802.11n (20MHz)	1 to 11	1, 11	OFDM	BPSK	7.2
Draft 802.11n (40MHz)	1 to 7	1, 7	OFDM	BPSK	15

**ANTENNA PORT CONDUCTED MEASUREMENT:**

- Pre-Scan has been conducted to determine the worst-case mode from all possible combinations between available modulations, data rates, and antenna ports (if EUT with antenna diversity architecture).
- Following channel(s) was (were) selected for the final test as listed below.

MODE	AVAILABLE CHANNEL	TESTED CHANNEL	MODULATION TECHNOLOGY	MODULATION TYPE	DATA RATE (Mbps)
802.11b	1 to 11	1, 6, 11	DSSS	DBPSK	1
802.11g	1 to 11	1, 6, 11	OFDM	BPSK	6
Draft 802.11n (20MHz)	1 to 11	1, 6, 11	OFDM	BPSK	7.2
Draft 802.11n (40MHz)	1 to 7	1, 4, 7	OFDM	BPSK	15



### 3.3 GENERAL DESCRIPTION OF APPLIED STANDARDS

The EUT is a RF product. According to the specifications of the manufacturer, it must comply with the requirements of the following standards:

#### FCC Part 15, Subpart C (15.247)

#### ANSI C63.4-2003

All test items have been performed and recorded as per the above standards.

**NOTE:** The EUT is also considered as a kind of computer peripheral, because the connection to computer is necessary for typical use. It has been verified to comply with the requirements of FCC Part 15, Subpart B, Class B (DoC). The test report has been issued separately.

### 3.4 DESCRIPTION OF SUPPORT UNITS

The EUT has been tested as an independent unit together with other necessary accessories or support units. The following support units or accessories were used to form a representative test configuration during the tests.

NO.	PRODUCT	BRAND	MODEL NO.	SERIAL NO.	FCC ID
1	NOTEBOOK	DELL	D600	CN-0G5152-48643-4 7H-7666	NA
2	NOTEBOOK COMPUTER	DELL	PP05L	9954115984	E2K24CLNS

NO.	SIGNAL CABLE DESCRIPTION OF THE ABOVE SUPPORT UNITS
1	10m UTP RJ45 cable
2	10m UTP RJ45 cable

**NOTE 1:** All power cords of the above support units are non shielded (1.8m).

**NOTE 2:** Item 1 ~ 2 acted as communication partners to transfer data.

## 4. TEST TYPES AND RESULTS

### 4.1 RADIATED EMISSION MEASUREMENT

#### 4.1.1 LIMITS OF RADIATED EMISSION MEASUREMENT

Emissions radiated outside of the specified bands, shall be according to the general radiated limits in 15.209 as following:

FREQUENCIES (MHz)	FIELD STRENGTH (microvolts/meter)	MEASUREMENT DISTANCE (meters)
0.009 ~ 0.490	2400 / F(kHz)	300
0.490 ~ 1.705	24000 / F(kHz)	30
1.705 ~ 30.0	30	30
30 ~ 88	100	3
88 ~ 216	150	3
216 ~ 960	200	3
Above 960	500	3

**NOTE:**

1. The lower limit shall apply at the transition frequencies.
2. Emission level (dBuV/m) = 20 log Emission level (uV/m).
3. As shown in 15.35(b), for frequencies above 1000MHz, the field strength limits are based on average detector, however, the peak field strength of any emission shall not exceed the maximum permitted average limits, specified above by more than 20dB under any condition of modulation.



#### 4.1.2 TEST INSTRUMENTS

DESCRIPTION & MANUFACTURER	MODEL NO.	SERIAL NO.	CALIBRATED UNTIL
Test Receiver ROHDE & SCHWARZ	ESCI	100424	Jul. 27, 2008
Spectrum Analyzer ROHDE & SCHWARZ	FSP40	100269	Aug. 05, 2008
BILOG Antenna SCHWARZBECK	VULB9168	9168-153	Jan. 03, 2009
HORN Antenna SCHWARZBECK	BBHA 9120 D	9120D-563	Jul. 30, 2008
HORN Antenna SCHWARZBECK	BBHA 9170	BBHA9170242	Jan. 06, 2009
Preamplifier Agilent	8449B	3008A01910	Sep. 19, 2008
Preamplifier Agilent	8447D	2944A10638	Dec. 19, 2008
RF signal cable HUBER+SUHNNER	SUCOFLEX 104	274039/223650	Nov. 07, 2008
RF signal cable Worken	8D-FB	Cable-HYCH9-01	Aug. 09, 2008
Software	ADT_Radiated_V7.6	NA	NA
Antenna Tower EMCO	2070/2080	512.835.4684	NA
Turn Table EMCO	2087-2.03	NA	NA
Antenna Tower & Turn Table Controller EMCO	2090	NA	NA

- NOTE:**
1. The calibration interval of the above test instruments is 12 months and the calibrations are traceable to NML/ROC and NIST/USA.
  2. The test was performed in HwaYa Chamber 9.
  3. The horn antenna and HP preamplifier (model: 8449B) are used only for the measurement of emission frequency above 1GHz if tested.
  4. The FCC Site Registration No. is 215374.
  5. The IC Site Registration No. is IC3789B-9.

#### 4.1.3 TEST PROCEDURES

- a. The EUT was placed on the top of a rotating table 0.8 meters above the ground at a 3 meters semi-anechoic chamber. The table was rotated 360 degrees to determine the position of the highest radiation.
- b. The EUT was set 3 meters away from the interference-receiving antenna, which was mounted on the top of a variable-height antenna tower.
- c. The antenna is a broadband antenna, and its height is varied from one meter to four meters above the ground to determine the maximum value of the field strength. Both horizontal and vertical polarizations of the antenna are set to make the measurement.
- d. For each suspected emission, the EUT was arranged to its worst case and then the antenna was tuned to heights from 1 meter to 4 meters and the rotatable table was turned from 0 degrees to 360 degrees to find the maximum reading.
- e. The test-receiver system was set to Peak Detect Function and Specified Bandwidth with Maximum Hold Mode.
- f. If the emission level of the EUT in peak mode was lower than the limit specified, then testing could be stopped and the peak values of the EUT would be reported. Otherwise the emissions would be re-tested one by one using peak, quasi-peak or average method as specified and then reported in a data sheet.

**NOTE:**

1. The resolution bandwidth and video bandwidth of test receiver/spectrum analyzer is 120kHz for Peak detection (PK) and Quasi-peak detection (QP) at frequency below 1GHz.
2. The resolution bandwidth of test receiver/spectrum analyzer is 1 MHz and video bandwidth is 3MHz for Peak detection at frequency above 1GHz.
3. The resolution bandwidth of test receiver/spectrum analyzer is 1MHz and the video bandwidth is 10Hz for Average detection (AV) at frequency above 1GHz.
4. All modes of operation were investigated and the worst-case emissions are reported.

#### 4.1.4 DEVIATION FROM TEST STANDARD

No deviation.

#### 4.1.5 TEST SETUP

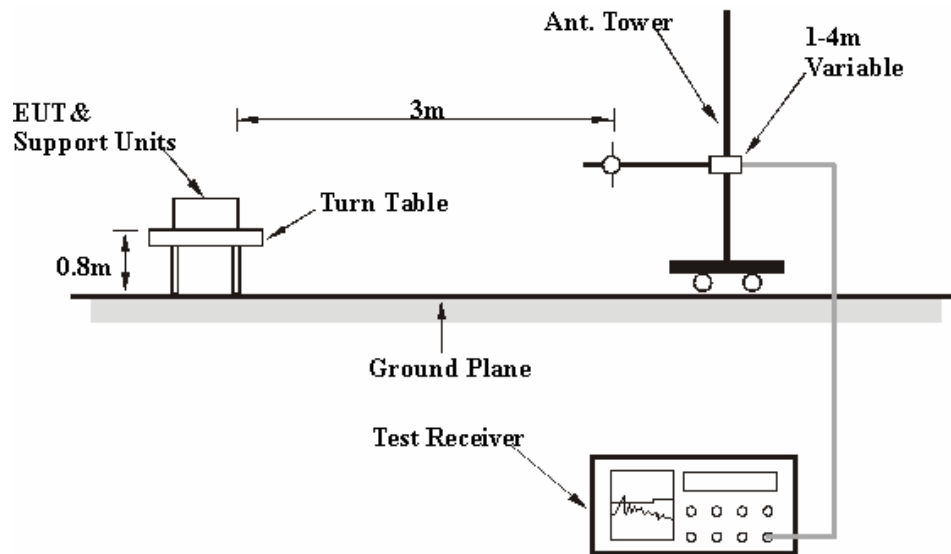

For the actual test configuration, please refer to the attached file (Test Setup Photo)

#### 4.1.6 EUT OPERATING CONDITIONS

- a. Placed the EUT on a testing table.
- b. Prepared notebook computer and placed it outside of testing area to act as communication partner for EUT.
- c. The EUT ran a test program (provided by manufacturer) to enable all functions under transmission condition continuously at specific channel frequency.
- d. The necessary accessories enable the EUT in full functions.

#### 4.1.7 TEST RESULTS

##### 802.11b DSSS MODULATION

EUT TEST CONDITION		MEASUREMENT DETAIL	
CHANNEL	Channel 1	FREQUENCY RANGE	1 ~ 25GHz
INPUT POWER (SYSTEM)	120Vac, 60 Hz	DETECTOR FUNCTION	Peak (PK) Average (AV)
ENVIRONMENTAL CONDITIONS	23deg. C, 70%RH 999hPa	TESTED BY	Lori Chiu

ANTENNA POLARITY & TEST DISTANCE: HORIZONTAL AT 3 M								
NO.	FREQ. (MHz)	EMISSION LEVEL (dBuV/m)	LIMIT (dBuV/m)	MARGIN (dB)	ANTENNA HEIGHT (m)	TABLE ANGLE (Degree)	RAW VALUE (dBuV)	CORRECTION FACTOR (dB/m)
1	2390.00	57.05 PK	74.00	-16.95	1.06 H	20	24.73	32.32
2	2390.00	45.92 AV	54.00	-8.08	1.06 H	20	13.60	32.32
3	*2412.00	100.44 PK			1.06 H	20	68.12	32.32
4	*2412.00	95.92 AV			1.06 H	20	63.60	32.32
5	4824.00	44.68 PK	74.00	-29.32	1.25 H	264	6.68	38.00
6	4824.00	34.77 AV	54.00	-19.23	1.25 H	264	-3.23	38.00
7	#7236.00	57.65 PK	80.44	-22.79	1.46 H	121	12.77	44.88
8	#7236.00	47.92 AV	75.92	-28.00	1.46 H	121	3.04	44.88
ANTENNA POLARITY & TEST DISTANCE: VERTICAL AT 3 M								
NO.	FREQ. (MHz)	EMISSION LEVEL (dBuV/m)	LIMIT (dBuV/m)	MARGIN (dB)	ANTENNA HEIGHT (m)	TABLE ANGLE (Degree)	RAW VALUE (dBuV)	CORRECTION FACTOR (dB/m)
1	2390.00	57.51 PK	74.00	-16.49	1.14 V	4	25.19	32.32
2	2390.00	46.91 AV	54.00	-7.09	1.14 V	4	14.59	32.32
3	*2412.00	107.86 PK			1.14 V	4	75.54	32.32
4	*2412.00	103.18 AV			1.14 V	4	70.86	32.32
5	4824.00	47.20 PK	74.00	-26.80	1.06 V	334	9.20	38.00
6	4824.00	38.18 AV	54.00	-15.82	1.06 V	334	0.18	38.00
7	#7236.00	60.14 PK	87.86	-27.72	1.45 V	228	15.26	44.88
8	#7236.00	52.87 AV	83.18	-30.31	1.45 V	228	7.99	44.88

- REMARKS:**
1. Emission level (dBuV/m) = Raw Value (dBuV) + Correction Factor (dB/m).
  2. Correction Factor (dB/m) = Antenna Factor (dB/m) + Cable Factor (dB).
  3. The other emission levels were very low against the limit.
  4. Margin value = Emission level – Limit value.
  5. “ \* ”: Fundamental frequency.
  6. “ # ”: The radiated frequency is out the restricted band.

EUT TEST CONDITION		MEASUREMENT DETAIL	
CHANNEL	Channel 6	FREQUENCY RANGE	1 ~ 25GHz
INPUT POWER (SYSTEM)	120Vac, 60 Hz	DETECTOR FUNCTION	Peak (PK) Average (AV)
ENVIRONMENTAL CONDITIONS	23deg. C, 70%RH 999hPa	TESTED BY	Lori Chiu

ANTENNA POLARITY & TEST DISTANCE: HORIZONTAL AT 3 M								
NO.	FREQ. (MHz)	EMISSION LEVEL (dBuV/m)	LIMIT (dBuV/m)	MARGIN (dB)	ANTENNA HEIGHT (m)	TABLE ANGLE (Degree)	RAW VALUE (dBuV)	CORRECTION FACTOR (dB/m)
1	*2437.00	100.23 PK			1.10 H	60	67.89	32.34
2	*2437.00	95.68 AV			1.10 H	60	63.34	32.34
3	4874.00	43.38 PK	74.00	-30.62	1.11 H	268	5.26	38.12
4	4874.00	34.29 AV	54.00	-19.71	1.11 H	268	-3.83	38.12
5	7311.00	54.60 PK	74.00	-19.40	1.04 H	217	9.63	44.97
6	7311.00	47.35 AV	54.00	-6.65	1.04 H	217	2.38	44.97
ANTENNA POLARITY & TEST DISTANCE: VERTICAL AT 3 M								
NO.	FREQ. (MHz)	EMISSION LEVEL (dBuV/m)	LIMIT (dBuV/m)	MARGIN (dB)	ANTENNA HEIGHT (m)	TABLE ANGLE (Degree)	RAW VALUE (dBuV)	CORRECTION FACTOR (dB/m)
1	*2437.00	107.24 PK			1.08 V	71	74.90	32.34
2	*2437.00	102.60 AV			1.08 V	71	70.26	32.34
3	4874.00	44.89 PK	74.00	-29.11	1.06 V	325	6.77	38.12
4	4874.00	35.10 AV	54.00	-18.90	1.06 V	325	-3.02	38.12
5	7311.00	57.82 PK	74.00	-16.18	1.05 V	189	12.85	44.97
6	7311.00	50.03 AV	54.00	-3.97	1.05 V	189	5.06	44.97

- REMARKS:**
1. Emission level (dBuV/m) = Raw Value (dBuV) + Correction Factor (dB/m).
  2. Correction Factor (dB/m) = Antenna Factor (dB/m) + Cable Factor (dB).
  3. The other emission levels were very low against the limit.
  4. Margin value = Emission level – Limit value.
  5. “ \* “: Fundamental frequency.
  6. “ # “: The radiated frequency is out the restricted band.



EUT TEST CONDITION		MEASUREMENT DETAIL	
CHANNEL	Channel 11	FREQUENCY RANGE	1 ~ 25GHz
INPUT POWER (SYSTEM)	120Vac, 60 Hz	DETECTOR FUNCTION	Peak (PK) Average (AV)
ENVIRONMENTAL CONDITIONS	23deg. C, 70%RH 999hPa	TESTED BY	Lori Chiu

ANTENNA POLARITY & TEST DISTANCE: HORIZONTAL AT 3 M								
NO.	FREQ. (MHz)	EMISSION LEVEL (dBuV/m)	LIMIT (dBuV/m)	MARGIN (dB)	ANTENNA HEIGHT (m)	TABLE ANGLE (Degree)	RAW VALUE (dBuV)	CORRECTION FACTOR (dB/m)
1	*2462.00	100.10 PK			1.01 H	15	67.73	32.37
2	*2462.00	95.34 AV			1.01 H	15	62.97	32.37
3	2483.50	57.21 PK	74.00	-16.79	1.01 H	15	24.82	32.39
4	2483.50	45.93 AV	54.00	-8.07	1.01 H	15	13.54	32.39
5	4924.00	43.67 PK	74.00	-30.33	1.15 H	213	5.44	38.23
6	4924.00	32.35 AV	54.00	-21.65	1.15 H	213	-5.88	38.23
7	7386.00	55.49 PK	74.00	-18.51	1.00 H	107	10.46	45.03
8	7386.00	47.88 AV	54.00	-6.12	1.00 H	107	2.85	45.03
ANTENNA POLARITY & TEST DISTANCE: VERTICAL AT 3 M								
NO.	FREQ. (MHz)	EMISSION LEVEL (dBuV/m)	LIMIT (dBuV/m)	MARGIN (dB)	ANTENNA HEIGHT (m)	TABLE ANGLE (Degree)	RAW VALUE (dBuV)	CORRECTION FACTOR (dB/m)
1	*2462.00	107.08 PK			1.06 V	87	74.71	32.37
2	*2462.00	102.20 AV			1.06 V	87	69.83	32.37
3	2483.50	58.54 PK	74.00	-15.46	1.06 V	87	26.15	32.39
4	2483.50	46.39 AV	54.00	-7.61	1.06 V	87	14.00	32.39
5	4924.00	44.66 PK	74.00	-29.34	1.30 V	270	6.43	38.23
6	4924.00	33.43 AV	54.00	-20.57	1.30 V	270	-4.80	38.23
7	7386.00	58.70 PK	74.00	-15.30	1.75 V	219	13.67	45.03
8	7386.00	50.72 AV	54.00	-3.28	1.75 V	219	5.69	45.03

- REMARKS:**
1. Emission level (dBuV/m) = Raw Value (dBuV) + Correction Factor (dB/m).
  2. Correction Factor (dB/m) = Antenna Factor (dB/m) + Cable Factor (dB).
  3. The other emission levels were very low against the limit.
  4. Margin value = Emission level – Limit value.
  5. “ \* “: Fundamental frequency.

### 802.11g OFDM MODULATION

EUT TEST CONDITION		MEASUREMENT DETAIL	
CHANNEL	Channel 1	FREQUENCY RANGE	1 ~ 25GHz
INPUT POWER (SYSTEM)	120Vac, 60 Hz	DETECTOR FUNCTION	Peak (PK) Average (AV)
ENVIRONMENTAL CONDITIONS	23deg. C, 70%RH 999hPa	TESTED BY	Lori Chiu

ANTENNA POLARITY & TEST DISTANCE: HORIZONTAL AT 3 M								
NO.	FREQ. (MHz)	EMISSION LEVEL (dBuV/m)	LIMIT (dBuV/m)	MARGIN (dB)	ANTENNA HEIGHT (m)	TABLE ANGLE (Degree)	RAW VALUE (dBuV)	CORRECTION FACTOR (dB/m)
1	2390.00	61.01 PK	74.00	-12.99	1.33 H	30	28.69	32.32
2	2390.00	47.77 AV	54.00	-6.23	1.33 H	30	15.45	32.32
3	*2412.00	101.97 PK			1.33 H	30	69.65	32.32
4	*2412.00	91.55 AV			1.33 H	30	59.23	32.32
5	4824.00	45.61 PK	74.00	-28.39	1.04 H	138	7.61	38.00
6	4824.00	32.34 AV	54.00	-21.66	1.04 H	138	-5.66	38.00
7	#7236.00	57.42 PK	81.97	-24.55	1.34 H	317	12.54	44.88
8	#7236.00	43.36 AV	71.55	-28.19	1.34 H	317	-1.52	44.88
ANTENNA POLARITY & TEST DISTANCE: VERTICAL AT 3 M								
NO.	FREQ. (MHz)	EMISSION LEVEL (dBuV/m)	LIMIT (dBuV/m)	MARGIN (dB)	ANTENNA HEIGHT (m)	TABLE ANGLE (Degree)	RAW VALUE (dBuV)	CORRECTION FACTOR (dB/m)
1	2390.00	66.89 PK	74.00	-7.11	1.15 V	6	34.57	32.32
2	2390.00	50.66 AV	54.00	-3.34	1.15 V	6	18.34	32.32
3	*2412.00	108.89 PK			1.12 V	345	76.57	32.32
4	*2412.00	98.59 AV			1.12 V	345	66.27	32.32
5	4824.00	47.18 PK	74.00	-26.82	1.28 V	35	9.18	38.00
6	4824.00	33.40 AV	54.00	-20.60	1.28 V	35	-4.60	38.00
7	#7236.00	61.57 PK	88.89	-27.32	1.08 V	214	16.69	44.88
8	#7236.00	47.22 AV	78.59	-31.37	1.08 V	214	2.34	44.88

- REMARKS:**
1. Emission level (dBuV/m) = Raw Value (dBuV) + Correction Factor (dB/m).
  2. Correction Factor (dB/m) = Antenna Factor (dB/m) + Cable Factor (dB).
  3. The other emission levels were very low against the limit.
  4. Margin value = Emission level – Limit value.
  5. “ \* “: Fundamental frequency.
  6. “ # “: The radiated frequency is out the restricted band.



EUT TEST CONDITION		MEASUREMENT DETAIL	
CHANNEL	Channel 6	FREQUENCY RANGE	1 ~ 25GHz
INPUT POWER (SYSTEM)	120Vac, 60 Hz	DETECTOR FUNCTION	Peak (PK) Average (AV)
ENVIRONMENTAL CONDITIONS	23deg. C, 70%RH 999hPa	TESTED BY	Lori Chiu

ANTENNA POLARITY & TEST DISTANCE: HORIZONTAL AT 3 M								
NO.	FREQ. (MHz)	EMISSION LEVEL (dBuV/m)	LIMIT (dBuV/m)	MARGIN (dB)	ANTENNA HEIGHT (m)	TABLE ANGLE (Degree)	RAW VALUE (dBuV)	CORRECTION FACTOR (dB/m)
1	*2437.00	102.37 PK			1.24 H	250	70.03	32.34
2	*2437.00	91.80 AV			1.24 H	250	59.46	32.34
3	4874.00	47.02 PK	74.00	-26.98	1.00 H	6	8.90	38.12
4	4874.00	33.25 AV	54.00	-20.75	1.00 H	6	-4.87	38.12
5	7311.00	57.35 PK	74.00	-16.65	1.04 H	128	12.38	44.97
6	7311.00	43.12 AV	54.00	-10.88	1.04 H	128	-1.85	44.97
ANTENNA POLARITY & TEST DISTANCE: VERTICAL AT 3 M								
NO.	FREQ. (MHz)	EMISSION LEVEL (dBuV/m)	LIMIT (dBuV/m)	MARGIN (dB)	ANTENNA HEIGHT (m)	TABLE ANGLE (Degree)	RAW VALUE (dBuV)	CORRECTION FACTOR (dB/m)
1	*2437.00	110.06 PK			1.16 V	3	77.72	32.34
2	*2437.00	99.16 AV			1.16 V	3	66.82	32.34
3	4874.00	47.21 PK	74.00	-26.79	1.29 V	31	9.09	38.12
4	4874.00	33.44 AV	54.00	-20.56	1.29 V	31	-4.68	38.12
5	7311.00	65.21 PK	74.00	-8.79	1.24 V	183	20.25	44.97
6	7311.00	50.50 AV	54.00	-3.50	1.24 V	183	5.54	44.97

- REMARKS:**
1. Emission level (dBuV/m) = Raw Value (dBuV) + Correction Factor (dB/m).
  2. Correction Factor (dB/m) = Antenna Factor (dB/m) + Cable Factor (dB).
  3. The other emission levels were very low against the limit.
  4. Margin value = Emission level – Limit value.
  5. “ \* “: Fundamental frequency.



EUT TEST CONDITION		MEASUREMENT DETAIL	
CHANNEL	Channel 11	FREQUENCY RANGE	1 ~ 25GHz
INPUT POWER (SYSTEM)	120Vac, 60 Hz	DETECTOR FUNCTION	Peak (PK) Average (AV)
ENVIRONMENTAL CONDITIONS	23deg. C, 70%RH 999hPa	TESTED BY	Lori Chiu

ANTENNA POLARITY & TEST DISTANCE: HORIZONTAL AT 3 M								
NO.	FREQ. (MHz)	EMISSION LEVEL (dBuV/m)	LIMIT (dBuV/m)	MARGIN (dB)	ANTENNA HEIGHT (m)	TABLE ANGLE (Degree)	RAW VALUE (dBuV)	CORRECTION FACTOR (dB/m)
1	*2462.00	103.07 PK			1.26 H	324	70.70	32.37
2	*2462.00	92.26 AV			1.26 H	324	59.89	32.37
3	2483.50	62.01 PK	74.00	-11.99	1.26 H	324	29.62	32.39
4	2483.50	48.43 AV	54.00	-5.57	1.26 H	324	16.04	32.39
5	4924.00	46.86 PK	74.00	-27.14	1.01 H	13	8.63	38.23
6	4924.00	33.20 AV	54.00	-20.80	1.01 H	13	-5.03	38.23
7	7386.00	61.37 PK	74.00	-12.63	1.06 H	169	16.34	45.03
8	7386.00	45.58 AV	54.00	-8.42	1.06 H	169	0.55	45.03

ANTENNA POLARITY & TEST DISTANCE: VERTICAL AT 3 M								
NO.	FREQ. (MHz)	EMISSION LEVEL (dBuV/m)	LIMIT (dBuV/m)	MARGIN (dB)	ANTENNA HEIGHT (m)	TABLE ANGLE (Degree)	RAW VALUE (dBuV)	CORRECTION FACTOR (dB/m)
1	*2462.00	110.10 PK			1.12 V	0	77.73	32.37
2	*2462.00	99.87 AV			1.12 V	0	67.50	32.37
3	2483.50	69.60 PK	74.00	-4.40	1.12 V	11	37.21	32.39
4	2483.50	51.84 AV	54.00	-2.16	1.12 V	11	19.45	32.39
5	4924.00	47.10 PK	74.00	-26.90	1.32 V	209	8.87	38.23
6	4924.00	33.46 AV	54.00	-20.54	1.32 V	209	-4.77	38.23
7	7386.00	65.07 PK	74.00	-8.93	1.23 V	182	20.05	45.03
8	7386.00	50.14 AV	54.00	-3.86	1.23 V	182	5.12	45.03

- REMARKS:**
1. Emission level (dBuV/m) = Raw Value (dBuV) + Correction Factor (dB/m).
  2. Correction Factor (dB/m) = Antenna Factor (dB/m) + Cable Factor (dB).
  3. The other emission levels were very low against the limit.
  4. Margin value = Emission level – Limit value.
  5. “ \* “: Fundamental frequency.

### DRAFT 802.11n (20MHz) OFDM MODULATION

EUT TEST CONDITION		MEASUREMENT DETAIL	
CHANNEL	Channel 1	FREQUENCY RANGE	1 ~ 25GHz
INPUT POWER (SYSTEM)	120Vac, 60 Hz	DETECTOR FUNCTION	Peak (PK) Average (AV)
ENVIRONMENTAL CONDITIONS	23deg. C, 70%RH 999hPa	TESTED BY	Lori Chiu

ANTENNA POLARITY & TEST DISTANCE: HORIZONTAL AT 3 M								
NO.	FREQ. (MHz)	EMISSION LEVEL (dBuV/m)	LIMIT (dBuV/m)	MARGIN (dB)	ANTENNA HEIGHT (m)	TABLE ANGLE (Degree)	RAW VALUE (dBuV)	CORRECTION FACTOR (dB/m)
1	2390.00	60.69 PK	74.00	-13.31	1.10 H	9	28.37	32.32
2	2390.00	47.79 AV	54.00	-6.21	1.10 H	9	15.47	32.32
3	*2412.00	105.21 PK			1.10 H	9	72.89	32.32
4	*2412.00	94.83 AV			1.10 H	9	62.51	32.32
5	4824.00	46.72 PK	74.00	-27.28	1.06 H	221	8.72	38.00
6	4824.00	33.71 AV	54.00	-20.29	1.06 H	221	-4.29	38.00
7	#7236.00	60.63 PK	85.21	-24.58	1.16 H	135	15.75	44.88
8	#7236.00	45.89 AV	74.83	-28.94	1.16 H	135	1.01	44.88
ANTENNA POLARITY & TEST DISTANCE: VERTICAL AT 3 M								
NO.	FREQ. (MHz)	EMISSION LEVEL (dBuV/m)	LIMIT (dBuV/m)	MARGIN (dB)	ANTENNA HEIGHT (m)	TABLE ANGLE (Degree)	RAW VALUE (dBuV)	CORRECTION FACTOR (dB/m)
1	2390.00	69.48 PK	74.00	-4.52	1.16 V	18	37.16	32.32
2	2390.00	50.07 AV	54.00	-3.93	1.16 V	18	17.75	32.32
3	*2412.00	111.93 PK			1.11 V	238	79.61	32.32
4	*2412.00	102.01 AV			1.11 V	238	69.69	32.32
5	4824.00	47.06 PK	74.00	-26.94	1.20 V	158	9.06	38.00
6	4824.00	34.70 AV	54.00	-19.30	1.20 V	158	-3.30	38.00
7	#7236.00	65.07 PK	91.93	-26.86	1.08 V	158	20.19	44.88
8	#7236.00	49.10 AV	82.01	-32.91	1.08 V	158	4.22	44.88

- REMARKS:**
1. Emission level (dBuV/m) = Raw Value (dBuV) + Correction Factor (dB/m).
  2. Correction Factor (dB/m) = Antenna Factor (dB/m) + Cable Factor (dB).
  3. The other emission levels were very low against the limit.
  4. Margin value = Emission level – Limit value.
  5. “ \* “: Fundamental frequency.
  6. “ # “: The radiated frequency is out the restricted band.



EUT TEST CONDITION		MEASUREMENT DETAIL	
CHANNEL	Channel 6	FREQUENCY RANGE	1 ~ 25GHz
INPUT POWER (SYSTEM)	120Vac, 60 Hz	DETECTOR FUNCTION	Peak (PK) Average (AV)
ENVIRONMENTAL CONDITIONS	23deg. C, 70%RH 999hPa	TESTED BY	Lori Chiu

ANTENNA POLARITY & TEST DISTANCE: HORIZONTAL AT 3 M								
NO.	FREQ. (MHz)	EMISSION LEVEL (dBuV/m)	LIMIT (dBuV/m)	MARGIN (dB)	ANTENNA HEIGHT (m)	TABLE ANGLE (Degree)	RAW VALUE (dBuV)	CORRECTION FACTOR (dB/m)
1	*2437.00	106.67 PK			1.01 H	264	74.33	32.34
2	*2437.00	96.10 AV			1.01 H	264	63.76	32.34
3	4874.00	47.13 PK	74.00	-26.87	1.00 H	208	9.01	38.12
4	4874.00	34.27 AV	54.00	-19.73	1.00 H	208	-3.85	38.12
5	7311.00	61.23 PK	74.00	-12.77	1.38 H	19	16.26	44.97
6	7311.00	46.80 AV	54.00	-7.20	1.38 H	19	1.83	44.97
ANTENNA POLARITY & TEST DISTANCE: VERTICAL AT 3 M								
NO.	FREQ. (MHz)	EMISSION LEVEL (dBuV/m)	LIMIT (dBuV/m)	MARGIN (dB)	ANTENNA HEIGHT (m)	TABLE ANGLE (Degree)	RAW VALUE (dBuV)	CORRECTION FACTOR (dB/m)
1	*2437.00	113.46 PK			1.12 V	9	81.12	32.34
2	*2437.00	103.11 AV			1.12 V	9	70.77	32.34
3	4874.00	47.29 PK	74.00	-26.71	1.35 V	259	9.17	38.12
4	4874.00	34.41 AV	54.00	-19.59	1.35 V	259	-3.71	38.12
5	7311.00	68.56 PK	74.00	-5.44	1.55 V	156	23.60	44.97
6	7311.00	50.97 AV	54.00	-3.03	1.55 V	156	6.01	44.97

- REMARKS:**
1. Emission level (dBuV/m) = Raw Value (dBuV) + Correction Factor (dB/m).
  2. Correction Factor (dB/m) = Antenna Factor (dB/m) + Cable Factor (dB).
  3. The other emission levels were very low against the limit.
  4. Margin value = Emission level – Limit value.
  5. “ \* “: Fundamental frequency.

EUT TEST CONDITION		MEASUREMENT DETAIL	
CHANNEL	Channel 11	FREQUENCY RANGE	1 ~ 25GHz
INPUT POWER (SYSTEM)	120Vac, 60 Hz	DETECTOR FUNCTION	Peak (PK) Average (AV)
ENVIRONMENTAL CONDITIONS	23deg. C, 70%RH 999hPa	TESTED BY	Lori Chiu

ANTENNA POLARITY & TEST DISTANCE: HORIZONTAL AT 3 M								
NO.	FREQ. (MHz)	EMISSION LEVEL (dBuV/m)	LIMIT (dBuV/m)	MARGIN (dB)	ANTENNA HEIGHT (m)	TABLE ANGLE (Degree)	RAW VALUE (dBuV)	CORRECTION FACTOR (dB/m)
1	*2462.00	105.29 PK			1.11 H	357	72.92	32.37
2	*2462.00	94.80 AV			1.11 H	357	62.43	32.37
3	2483.50	60.89 PK	74.00	-13.11	1.11 H	357	28.50	32.39
4	2483.50	47.07 AV	54.00	-6.93	1.11 H	357	14.68	32.39
5	4924.00	47.21 PK	74.00	-26.79	1.00 H	16	8.98	38.23
6	4924.00	33.87 AV	54.00	-20.13	1.00 H	16	-4.36	38.23
7	7386.00	58.72 PK	74.00	-15.28	1.07 H	225	13.70	45.03
8	7386.00	43.78 AV	54.00	-10.22	1.07 H	225	-1.24	45.03
ANTENNA POLARITY & TEST DISTANCE: VERTICAL AT 3 M								
NO.	FREQ. (MHz)	EMISSION LEVEL (dBuV/m)	LIMIT (dBuV/m)	MARGIN (dB)	ANTENNA HEIGHT (m)	TABLE ANGLE (Degree)	RAW VALUE (dBuV)	CORRECTION FACTOR (dB/m)
1	*2462.00	112.75 PK			1.10 V	239	80.38	32.37
2	*2462.00	102.10 AV			1.10 V	239	69.73	32.37
3	2483.50	66.31 PK	74.00	-7.69	1.06 V	275	33.92	32.39
4	2483.50	49.27 AV	54.00	-4.73	1.06 V	275	16.88	32.39
5	4924.00	47.51 PK	74.00	-26.49	1.01 V	183	9.28	38.23
6	4924.00	34.23 AV	54.00	-19.77	1.01 V	183	-4.00	38.23
7	7386.00	64.67 PK	74.00	-9.33	1.60 V	148	19.65	45.03
8	7386.00	48.58 AV	54.00	-5.42	1.60 V	148	3.56	45.03

- REMARKS:**
1. Emission level (dBuV/m) = Raw Value (dBuV) + Correction Factor (dB/m).
  2. Correction Factor (dB/m) = Antenna Factor (dB/m) + Cable Factor (dB).
  3. The other emission levels were very low against the limit.
  4. Margin value = Emission level – Limit value.
  5. “ \* “: Fundamental frequency.



**DRAFT 802.11n (40MHz) OFDM MODULATION**

EUT TEST CONDITION		MEASUREMENT DETAIL	
CHANNEL	Channel 1	FREQUENCY RANGE	1 ~ 25GHz
INPUT POWER (SYSTEM)	120Vac, 60 Hz	DETECTOR FUNCTION	Peak (PK) Average (AV)
ENVIRONMENTAL CONDITIONS	23deg. C, 70%RH 999hPa	TESTED BY	Lori Chiu

ANTENNA POLARITY & TEST DISTANCE: HORIZONTAL AT 3 M								
NO.	FREQ. (MHz)	EMISSION LEVEL (dBuV/m)	LIMIT (dBuV/m)	MARGIN (dB)	ANTENNA HEIGHT (m)	TABLE ANGLE (Degree)	RAW VALUE (dBuV)	CORRECTION FACTOR (dB/m)
1	2390.00	61.47 PK	74.00	-12.53	1.23 H	212	29.15	32.32
2	2390.00	47.75 AV	54.00	-6.25	1.23 H	212	15.43	32.32
3	*2422.00	100.32 PK			1.23 H	212	67.99	32.33
4	*2422.00	90.17 AV			1.23 H	212	57.84	32.33
5	4804.00	45.88 PK	74.00	-28.12	1.00 H	101	7.93	37.95
6	4804.00	34.00 AV	54.00	-20.00	1.00 H	101	-3.95	37.95
ANTENNA POLARITY & TEST DISTANCE: VERTICAL AT 3 M								
NO.	FREQ. (MHz)	EMISSION LEVEL (dBuV/m)	LIMIT (dBuV/m)	MARGIN (dB)	ANTENNA HEIGHT (m)	TABLE ANGLE (Degree)	RAW VALUE (dBuV)	CORRECTION FACTOR (dB/m)
1	2390.00	72.63 PK	74.00	-1.37	1.09 V	80	40.31	32.32
2	2390.00	52.16 AV	54.00	-1.84	1.09 V	80	19.84	32.32
3	*2422.00	108.77 PK			1.11 V	238	76.44	32.33
4	*2422.00	97.74 AV			1.11 V	238	65.41	32.33
5	4804.00	46.03 PK	74.00	-27.97	1.07 V	81	8.08	37.95
6	4804.00	34.15 AV	54.00	-19.85	1.07 V	81	-3.80	37.95

- REMARKS:**
1. Emission level (dBuV/m) = Raw Value (dBuV) + Correction Factor (dB/m).
  2. Correction Factor (dB/m) = Antenna Factor (dB/m) + Cable Factor (dB).
  3. The other emission levels were very low against the limit.
  4. Margin value = Emission level – Limit value.
  5. “ \* “: Fundamental frequency.





EUT TEST CONDITION		MEASUREMENT DETAIL	
CHANNEL	Channel 4	FREQUENCY RANGE	1 ~ 25GHz
INPUT POWER (SYSTEM)	120Vac, 60 Hz	DETECTOR FUNCTION	Peak (PK) Average (AV)
ENVIRONMENTAL CONDITIONS	23deg. C, 70%RH 999hPa	TESTED BY	Lori Chiu

ANTENNA POLARITY & TEST DISTANCE: HORIZONTAL AT 3 M								
NO.	FREQ. (MHz)	EMISSION LEVEL (dBuV/m)	LIMIT (dBuV/m)	MARGIN (dB)	ANTENNA HEIGHT (m)	TABLE ANGLE (Degree)	RAW VALUE (dBuV)	CORRECTION FACTOR (dB/m)
1	2390.00	61.22 PK	74.00	-12.78	1.10 H	136	28.90	32.32
2	2390.00	48.18 AV	54.00	-5.82	1.10 H	136	15.86	32.32
3	*2437.00	101.89 PK			1.10 H	136	69.55	32.34
4	*2437.00	91.76 AV			1.10 H	136	59.42	32.34
5	4874.00	47.28 PK	74.00	-26.72	1.00 H	215	9.16	38.12
6	4874.00	34.34 AV	54.00	-19.66	1.00 H	215	-3.78	38.12
ANTENNA POLARITY & TEST DISTANCE: VERTICAL AT 3 M								
NO.	FREQ. (MHz)	EMISSION LEVEL (dBuV/m)	LIMIT (dBuV/m)	MARGIN (dB)	ANTENNA HEIGHT (m)	TABLE ANGLE (Degree)	RAW VALUE (dBuV)	CORRECTION FACTOR (dB/m)
1	2390.00	66.84 PK	74.00	-7.16	1.08 V	291	34.52	32.32
2	2390.00	51.57 AV	54.00	-2.43	1.08 V	291	19.25	32.32
3	*2437.00	110.57 PK			1.06 V	287	78.23	32.34
4	*2437.00	100.47 AV			1.06 V	287	68.13	32.34
5	4874.00	47.65 PK	74.00	-26.35	1.20 V	133	9.53	38.12
6	4874.00	34.58 AV	54.00	-19.42	1.20 V	133	-3.54	38.12

- REMARKS:**
1. Emission level (dBuV/m) = Raw Value (dBuV) + Correction Factor (dB/m).
  2. Correction Factor (dB/m) = Antenna Factor (dB/m) + Cable Factor (dB).
  3. The other emission levels were very low against the limit.
  4. Margin value = Emission level – Limit value.
  5. “ \* “: Fundamental frequency.



EUT TEST CONDITION		MEASUREMENT DETAIL	
CHANNEL	Channel 7	FREQUENCY RANGE	1 ~ 25GHz
INPUT POWER (SYSTEM)	120Vac, 60 Hz	DETECTOR FUNCTION	Peak (PK) Average (AV)
ENVIRONMENTAL CONDITIONS	23deg. C, 70%RH 999hPa	TESTED BY	Lori Chiu

ANTENNA POLARITY & TEST DISTANCE: HORIZONTAL AT 3 M								
NO.	FREQ. (MHz)	EMISSION LEVEL (dBuV/m)	LIMIT (dBuV/m)	MARGIN (dB)	ANTENNA HEIGHT (m)	TABLE ANGLE (Degree)	RAW VALUE (dBuV)	CORRECTION FACTOR (dB/m)
1	*2452.00	100.78 PK			1.23 H	212	68.42	32.36
2	*2452.00	90.57 AV			1.23 H	212	58.21	32.36
3	2483.50	62.96 PK	74.00	-11.04	1.23 H	212	30.57	32.39
4	2483.50	48.35 AV	54.00	-5.65	1.23 H	212	15.96	32.39
5	4904.00	46.35 PK	74.00	-27.65	1.23 H	29	8.16	38.19
6	4904.00	33.51 AV	54.00	-20.49	1.23 H	29	-4.68	38.19
ANTENNA POLARITY & TEST DISTANCE: VERTICAL AT 3 M								
NO.	FREQ. (MHz)	EMISSION LEVEL (dBuV/m)	LIMIT (dBuV/m)	MARGIN (dB)	ANTENNA HEIGHT (m)	TABLE ANGLE (Degree)	RAW VALUE (dBuV)	CORRECTION FACTOR (dB/m)
1	*2452.00	109.18 PK			1.10 V	235	76.82	32.36
2	*2452.00	99.11 AV			1.10 V	235	66.75	32.36
3	2483.50	72.05 PK	74.00	-1.95	1.07 V	271	39.66	32.39
4	2483.50	52.31 AV	54.00	-1.69	1.07 V	271	19.92	32.39
5	4904.00	46.64 PK	74.00	-27.36	1.12 V	246	8.45	38.19
6	4904.00	34.07 AV	54.00	-19.93	1.12 V	246	-4.12	38.19

- REMARKS:**
1. Emission level (dBuV/m) = Raw Value (dBuV) + Correction Factor (dB/m).
  2. Correction Factor (dB/m) = Antenna Factor (dB/m) + Cable Factor (dB).
  3. The other emission levels were very low against the limit.
  4. Margin value = Emission level – Limit value.
  5. “ \* “: Fundamental frequency.



**BELOW 1GHz WORST-CASE DATA : DRAFT 802.11n (20MHz) OFDM MODULATION**

EUT TEST CONDITION		MEASUREMENT DETAIL	
CHANNEL	Channel 6	FREQUENCY RANGE	Below 1000MHz
INPUT POWER (SYSTEM)	120Vac, 60 Hz	DETECTOR FUNCTION	Quasi-Peak
ENVIRONMENTAL CONDITIONS	23deg. C, 70%RH 999hPa	TESTED BY	Lori Chiu

ANTENNA POLARITY & TEST DISTANCE: HORIZONTAL AT 3 M								
NO.	FREQ. (MHz)	EMISSION LEVEL (dBuV/m)	LIMIT (dBuV/m)	MARGIN (dB)	ANTENNA HEIGHT (m)	TABLE ANGLE (Degree)	RAW VALUE (dBuV)	CORRECTION FACTOR (dB/m)
1	115.45	35.42 QP	43.50	-8.08	1.50 H	226	24.22	11.20
2	830.95	33.19 QP	46.00	-12.81	1.50 H	226	7.97	25.21
3	869.83	35.05 QP	46.00	-10.95	1.50 H	232	9.48	25.57
4	891.22	35.08 QP	46.00	-10.92	1.50 H	217	9.32	25.76
5	930.11	37.34 QP	46.00	-8.66	1.50 H	283	11.21	26.14
6	951.49	38.49 QP	46.00	-7.51	1.50 H	274	12.16	26.34
ANTENNA POLARITY & TEST DISTANCE: VERTICAL AT 3 M								
NO.	FREQ. (MHz)	EMISSION LEVEL (dBuV/m)	LIMIT (dBuV/m)	MARGIN (dB)	ANTENNA HEIGHT (m)	TABLE ANGLE (Degree)	RAW VALUE (dBuV)	CORRECTION FACTOR (dB/m)
1	49.34	31.79 QP	40.00	-8.21	1.00 V	319	18.20	13.59
2	94.06	32.08 QP	43.50	-11.42	1.00 V	226	22.85	9.24
3	103.78	32.79 QP	43.50	-10.71	1.00 V	307	23.01	9.77
4	129.06	32.37 QP	43.50	-11.13	1.00 V	208	20.28	12.09
5	500.42	34.03 QP	46.00	-11.97	1.00 V	166	14.92	19.12
6	862.06	35.44 QP	46.00	-10.56	1.00 V	172	9.94	25.50
7	881.50	38.11 QP	46.00	-7.89	1.00 V	211	12.44	25.67
8	910.66	35.29 QP	46.00	-10.71	1.00 V	169	9.35	25.95
9	951.49	34.51 QP	46.00	-11.49	1.00 V	136	8.18	26.34

- REMARKS:**
1. Emission level (dBuV/m) = Raw Value (dBuV) + Correction Factor (dB/m).
  2. Correction Factor (dB/m) = Antenna Factor (dB/m) + Cable Factor (dB).
  3. The other emission levels were very low against the limit.
  4. Margin value = Emission level – Limit value.



## 4.2 CONDUCTED EMISSION MEASUREMENT

### 4.2.1 LIMITS OF CONDUCTED EMISSION MEASUREMENT

FREQUENCY OF EMISSION (MHz)	CONDUCTED LIMIT (dB $\mu$ V)	
	Quasi-peak	Average
0.15-0.5	66 to 56	56 to 46
0.5-5	56	46
5-30	60	50

- NOTE:**
1. The lower limit shall apply at the transition frequencies.
  2. The limit decreases in line with the logarithm of the frequency in the range of 0.15 to 0.50 MHz.
  3. All emanations from a class A/B digital device or system, including any network of conductors and apparatus connected thereto, shall not exceed the level of field strengths specified above.

### 4.2.2 TEST INSTRUMENTS

DESCRIPTION & MANUFACTURER	MODEL NO.	SERIAL NO.	CALIBRATED UNTIL
Test Receiver ROHDE & SCHWARZ	ESCS30	100288	Sep. 21, 2008
RF signal cable Woken	5D-FB	Cable-HYCO3-01	Jan. 06, 2009
LISN ROHDE & SCHWARZ	ESH2-Z5	100100	Jan. 09, 2009
LISN SCHWARZBECK	NNBL 8226-2	8226-142	May 07, 2008
Software ADT	ADT_Cond_V3	NA	NA

- NOTE:**
1. The calibration interval of the above test instruments is 12 months and the calibrations are traceable to NML/ROC and NIST/USA.
  2. The test was performed in HwaYa Shielded Room 2.
  3. The VCCI Site Registration No. is C-2047.

#### 4.2.3 TEST PROCEDURES

- a. The EUT was placed 0.4 meters from the conducting wall of the shielded room with EUT being connected to the power mains through a line impedance stabilization network (LISN). Other support units were connected to the power mains through another LISN. The two LISNs provide 50 ohm/ 50uH of coupling impedance for the measuring instrument.
- b. Both lines of the power mains connected to the EUT were checked for maximum conducted interference.
- c. The frequency range from 150kHz to 30MHz was searched. Emission levels under (Limit - 20dB) was not recorded.

**NOTE:** All modes of operation were investigated and the worst-case emissions are reported.

#### 4.2.4 DEVIATION FROM TEST STANDARD

No deviation.

#### 4.2.5 TEST SETUP

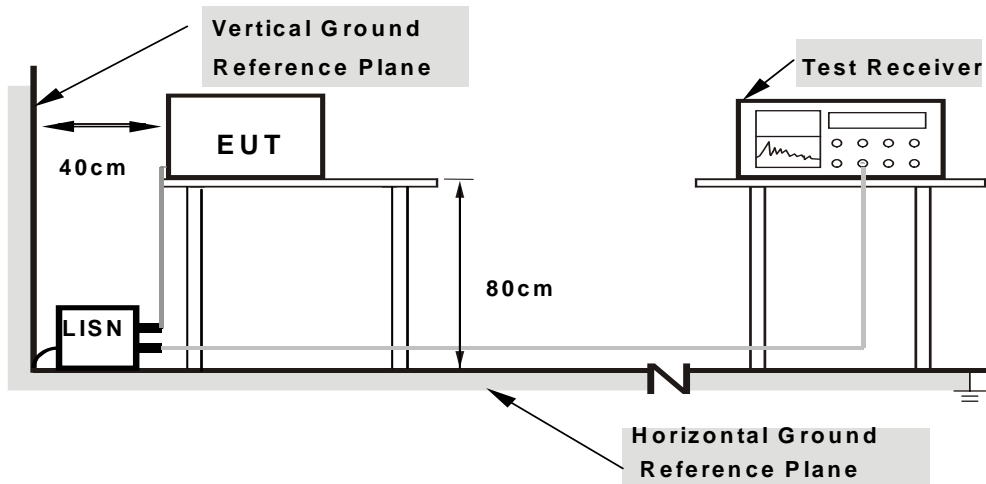

- Note:**
1. Support units were connected to second LISN.
  2. Both of LISNs (AMN) are 80 cm from EUT and at least 80 cm from other units and other metal planes

For the actual test configuration, please refer to the attached file (Test Setup Photo).

#### 4.2.6 EUT OPERATING CONDITIONS

Same as 4.1.6.

## 4.2.7 TEST RESULTS

### CONDUCTED WORST-CASE DATA: 802.11n (20MHz) OFDM MODULATION

EUT TEST CONDITION		MEASUREMENT DETAIL	
CHANNEL	Channel 6	PHASE	Line 1
MODULATION TYPE	BPSK	6dB BANDWIDTH	9 kHz
INPUT POWER (SYSTEM)	120Vac, 60 Hz	ENVIRONMENTAL CONDITIONS	20deg. C, 60%RH, 1016hPa
TESTED BY	Match Tsui		

No	Freq. [MHz]	Corr. Factor (dB)	Reading Value [dB (uV)]		Emission Level [dB (uV)]		Limit [dB (uV)]		Margin (dB)	
			Q.P.	AV.	Q.P.	AV.	Q.P.	AV.	Q.P.	AV.
1	0.197	0.10	49.83	-	49.93	-	63.74	53.74	-13.81	-
2	0.330	0.10	43.03	-	43.13	-	59.46	49.46	-16.33	-
<b>3</b>	<b>0.595</b>	<b>0.10</b>	<b>44.21</b>	-	<b>44.31</b>	-	<b>56.00</b>	<b>46.00</b>	<b>-11.69</b>	-
4	0.861	0.11	40.02	-	40.13	-	56.00	46.00	-15.87	-
5	1.922	0.21	40.29	-	40.50	-	56.00	46.00	-15.50	-
6	10.133	0.33	39.09	-	39.42	-	60.00	50.00	-20.58	-

- REMARKS:**
1. Q.P. and AV. are abbreviations of quasi-peak and average individually.
  2. "-": The Quasi-peak reading value also meets average limit and measurement with the average detector is unnecessary.
  3. The emission levels of other frequencies were very low against the limit.
  4. Margin value = Emission level - Limit value
  5. Correction factor = Insertion loss + Cable loss
  6. Emission Level = Correction Factor + Reading Value.

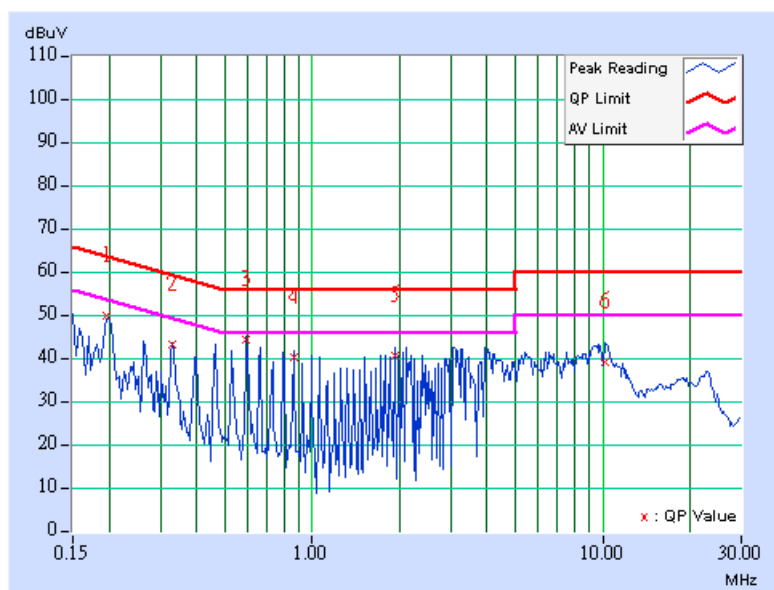

EUT TEST CONDITION		MEASUREMENT DETAIL	
CHANNEL	Channel 6	PHASE	Line 2
MODULATION TYPE	BPSK	6dB BANDWIDTH	9 kHz
INPUT POWER (SYSTEM)	120Vac, 60 Hz	ENVIRONMENTAL CONDITIONS	20deg. C, 60%RH, 1016hPa
TESTED BY	Match Tsui		

No	Freq. [MHz]	Corr. Factor (dB)	Reading Value [dB (uV)]		Emission Level [dB (uV)]		Limit [dB (uV)]		Margin (dB)	
			Q.P.	AV.	Q.P.	AV.	Q.P.	AV.	Q.P.	AV.
1	0.197	0.10	48.59	-	48.69	-	63.74	53.74	-15.05	-
2	0.330	0.10	38.72	-	38.82	-	59.46	49.46	-20.64	-
3	0.595	0.14	42.03	-	42.17	-	56.00	46.00	-13.83	-
4	2.188	0.23	40.01	-	40.24	-	56.00	46.00	-15.76	-
5	4.039	0.28	40.03	-	40.31	-	56.00	46.00	-15.69	-
6	9.871	0.43	42.99	-	43.42	-	60.00	50.00	-16.58	-

- REMARKS:**
1. Q.P. and AV. are abbreviations of quasi-peak and average individually.
  2. "-": The Quasi-peak reading value also meets average limit and measurement with the average detector is unnecessary.
  3. The emission levels of other frequencies were very low against the limit.
  4. Margin value = Emission level - Limit value
  5. Correction factor = Insertion loss + Cable loss
  6. Emission Level = Correction Factor + Reading Value.

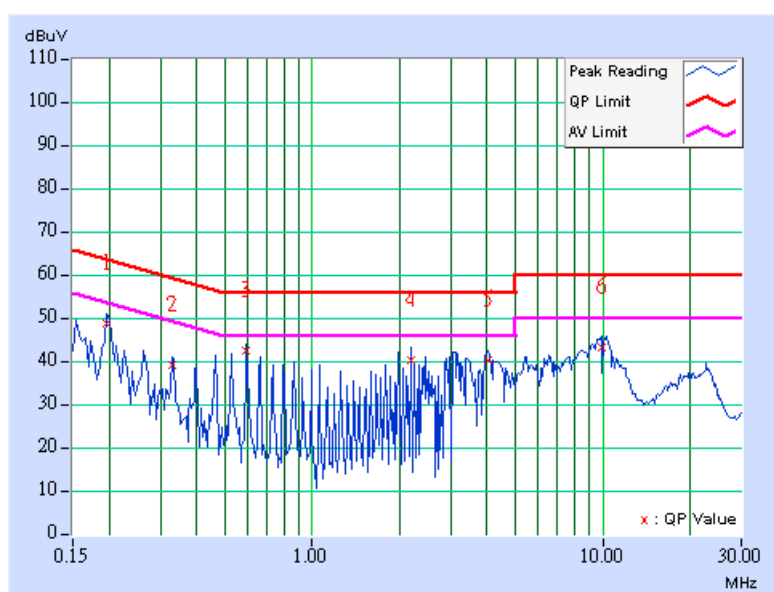





### 4.3 6dB BANDWIDTH MEASUREMENT

#### 4.3.1 LIMITS OF 6dB BANDWIDTH MEASUREMENT

The minimum of 6dB Bandwidth Measurement is 0.5 MHz.

#### 4.3.2 TEST INSTRUMENTS

DESCRIPTION & MANUFACTURER	MODEL NO.	SERIAL NO.	CALIBRATED UNTIL
SPECTRUM ANALYZER	FSP 40	100040	Jun. 28, 2008

**NOTE:** The calibration interval of the above test instruments is 12 months and the calibrations are traceable to NML/ROC and NIST/USA.

#### 4.3.3 TEST PROCEDURE

The transmitter output was connected to the spectrum analyzer through an attenuator. The bandwidth of the fundamental frequency was measured by spectrum analyzer with 100kHz RBW and 100kHz VBW. The 6dB bandwidth is defined as the total spectrum the power of which is higher than peak power minus 6dB.

#### 4.3.4 DEVIATION FROM TEST STANDARD

No deviation.

#### 4.3.5 TEST SETUP

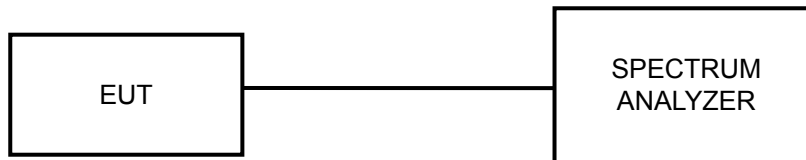

#### 4.3.6 EUT OPERATING CONDITIONS

The software provided by client to enable the EUT under transmission condition continuously at lowest, middle and highest channel frequencies individually.

### 4.3.7 TEST RESULTS

#### 802.11b DSSS MODULATION

<b>MODULATION TYPE</b>	DBPSK	<b>TRANSFER RATE</b>	1.0Mbps
<b>INPUT POWER (SYSTEM)</b>	120Vac, 60 Hz	<b>ENVIRONMENTAL CONDITIONS</b>	23deg.C, 61%RH, 991hPa
<b>TESTED BY</b>	Long Chen		

CHANNEL	CHANNEL FREQUENCY (MHz)	6dB BANDWIDTH (MHz)	MINIMUM LIMIT (MHz)	PASS / FAIL
1	2412	10.14	0.5	PASS
6	2437	11.12	0.5	PASS
11	2462	11.10	0.5	PASS

#### CH 1

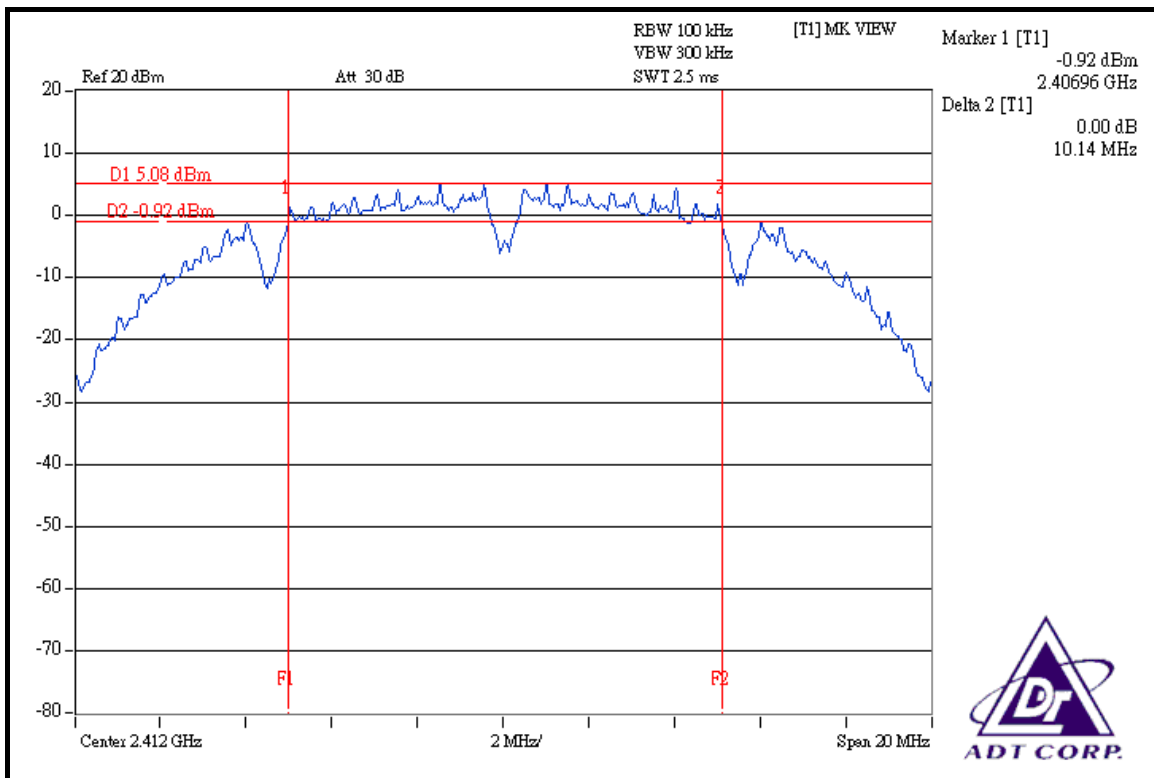

### CH 6

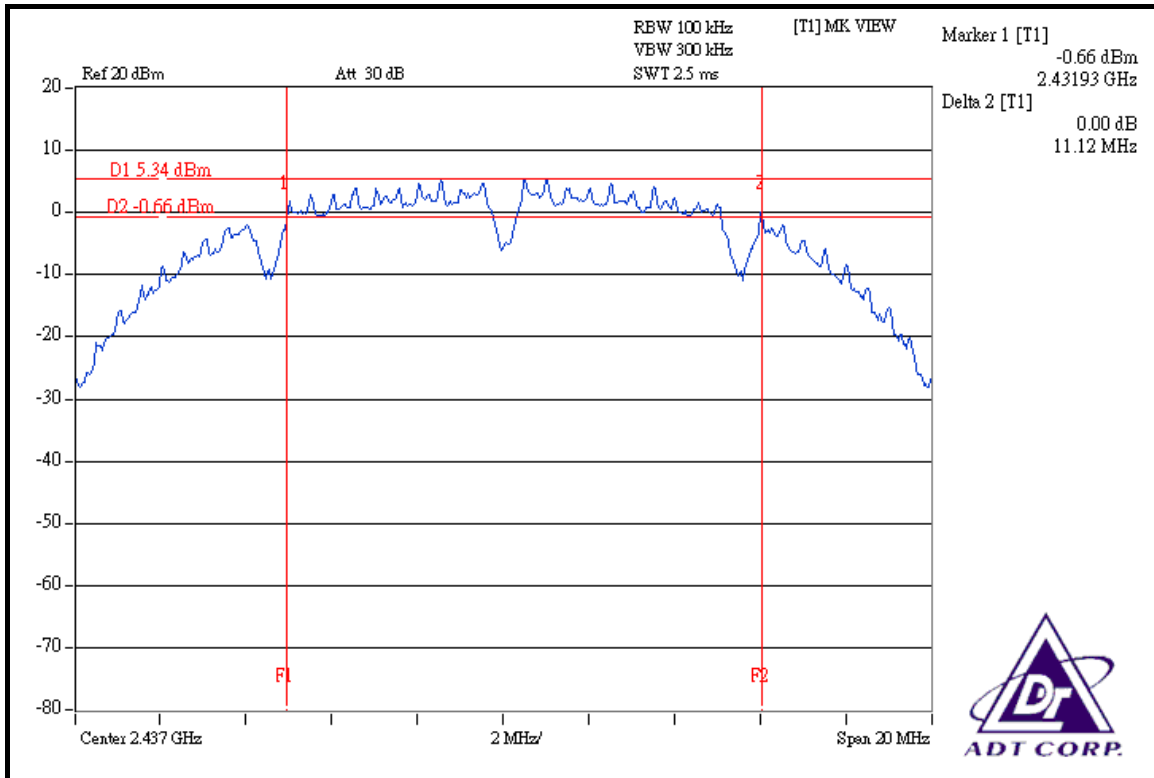

### CH 11

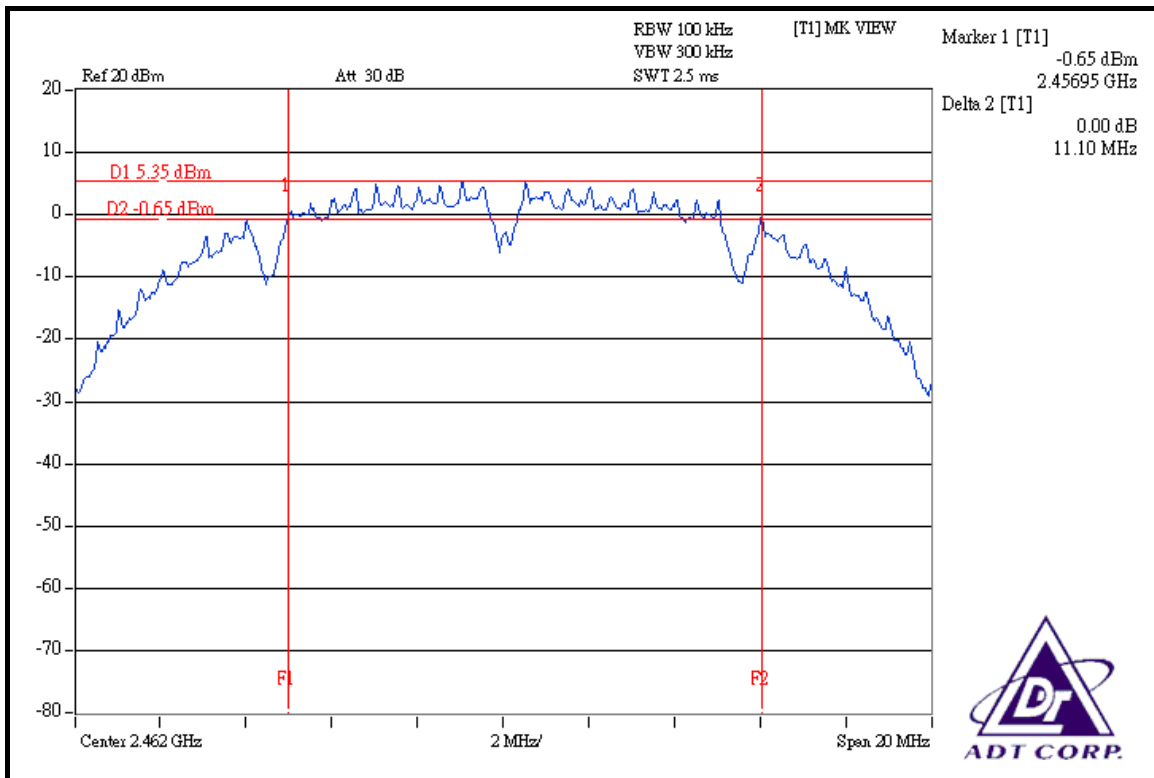



### 802.11g OFDM MODULATION

<b>MODULATION TYPE</b>	BPSK	<b>TRANSFER RATE</b>	6.0Mbps
<b>INPUT POWER (SYSTEM)</b>	120Vac, 60 Hz	<b>ENVIRONMENTAL CONDITIONS</b>	23deg.C, 61%RH, 991hPa
<b>TESTED BY</b>	Long Chen		

CHANNEL	CHANNEL FREQUENCY (MHz)	6dB BANDWIDTH (MHz)	MINIMUM LIMIT (MHz)	PASS / FAIL
1	2412	16.42	0.5	PASS
6	2437	16.40	0.5	PASS
11	2462	16.43	0.5	PASS

### CH 1

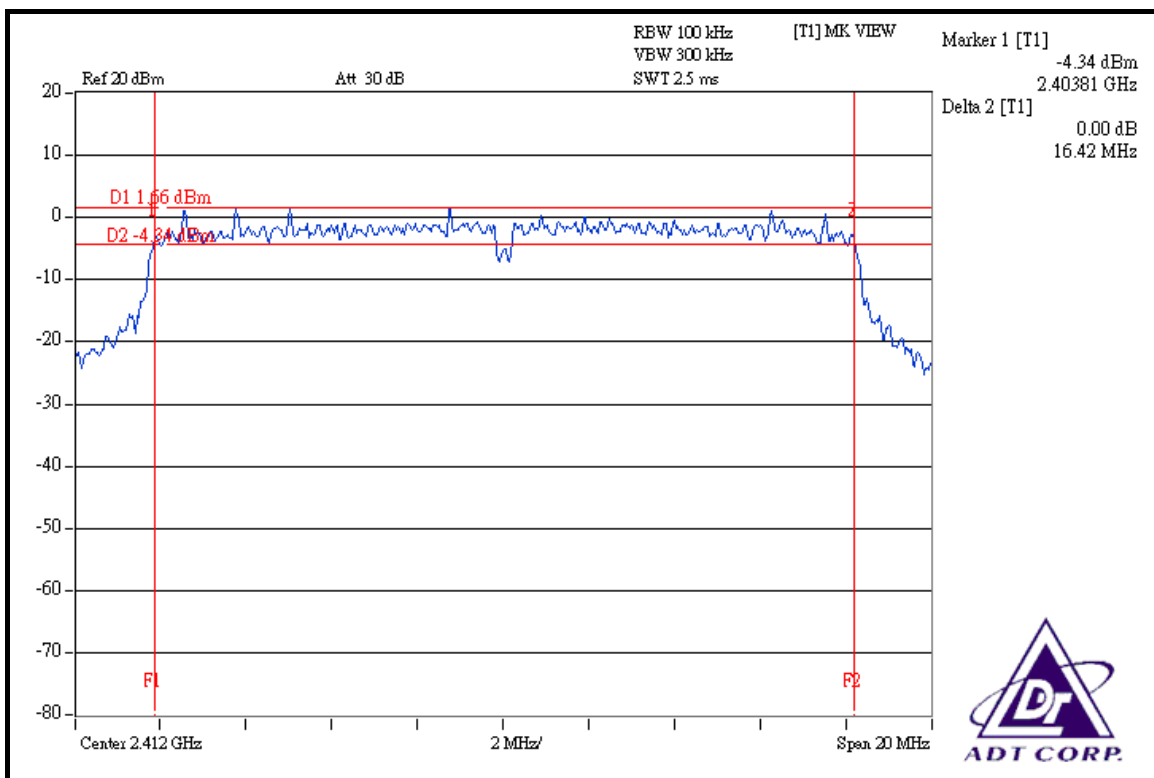

### CH 6

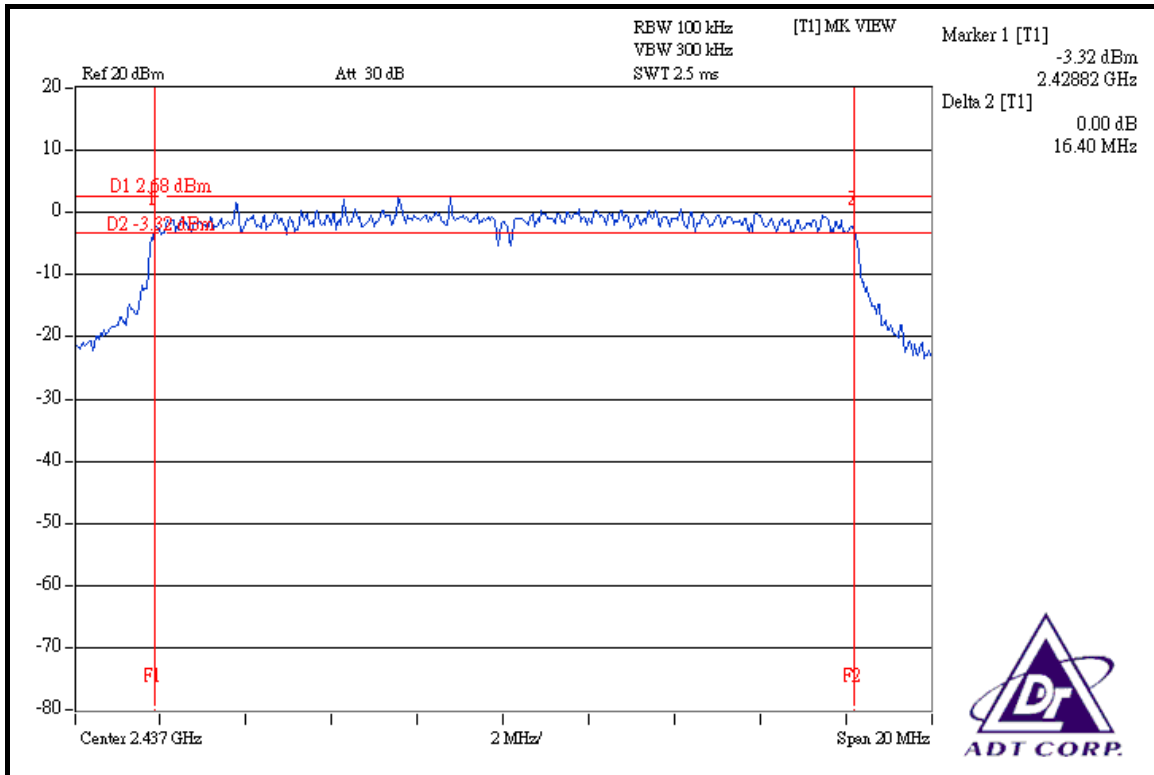

### CH 11

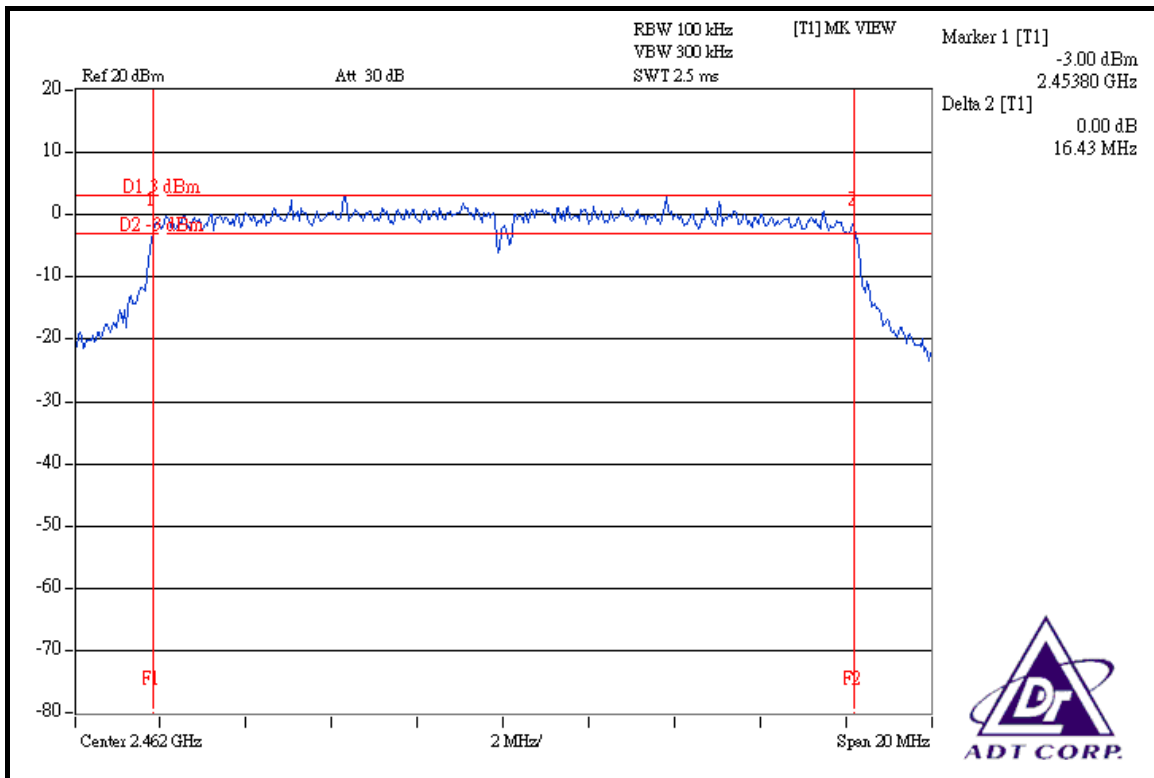



### DRAFT 802.11n (20MHz) OFDM MODULATION

<b>MODULATION TYPE</b>	BPSK	<b>TRANSFER RATE</b>	7.2Mbps
<b>INPUT POWER (SYSTEM)</b>	120Vac, 60 Hz	<b>ENVIRONMENTAL CONDITIONS</b>	23deg.C, 61%RH, 991hPa
<b>TESTED BY</b>	Long Chen		

CHANNEL	CHANNEL FREQUENCY (MHz)	6dB BANDWIDTH (MHz)		MINIMUM LIMIT (MHz)	PASS / FAIL
		CHAIN 0	CHAIN 1		
1	2412	17.65	17.59	0.5	PASS
6	2437	17.60	17.62	0.5	PASS
11	2462	17.65	17.66	0.5	PASS



### FOR CHAIN 0: CH 1

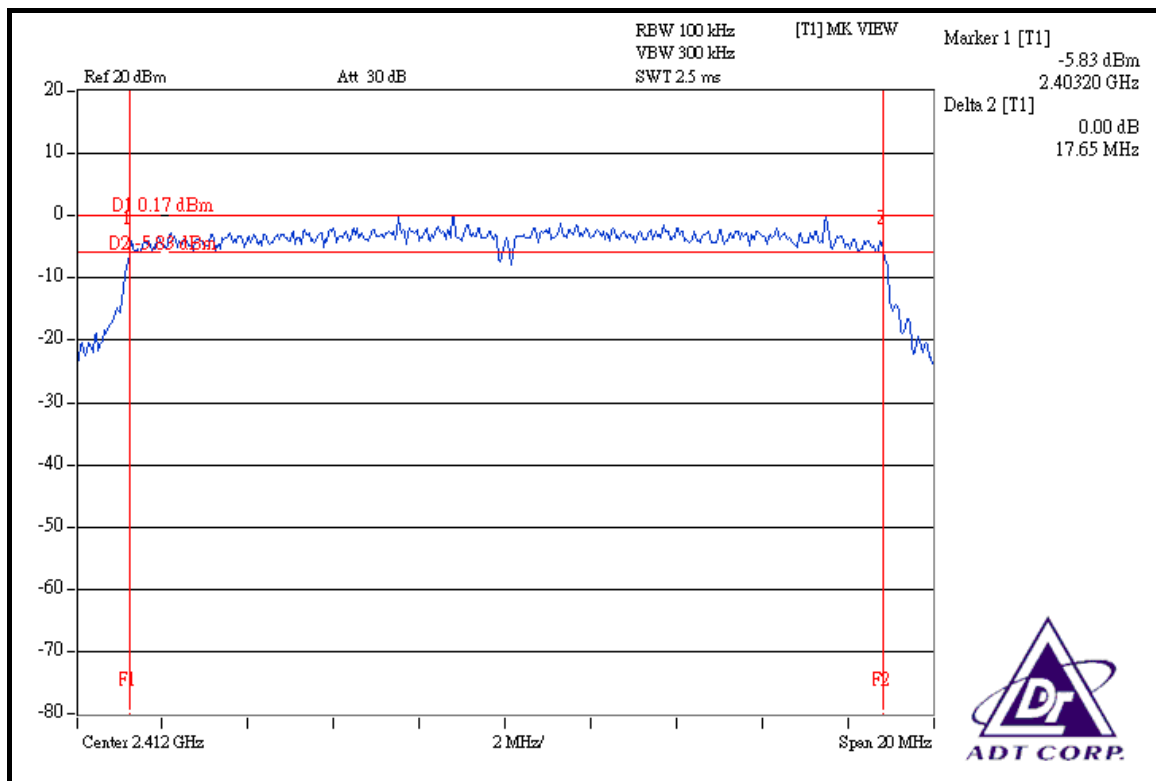

### CH 6

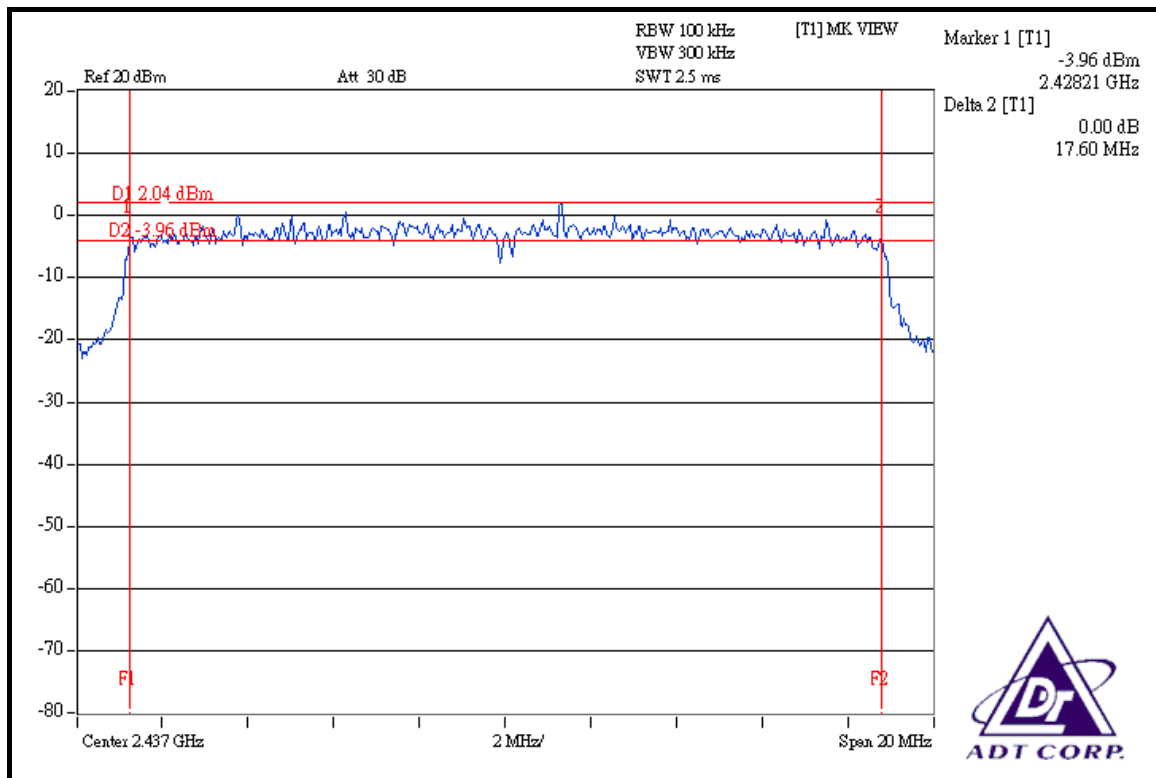



### CH 11

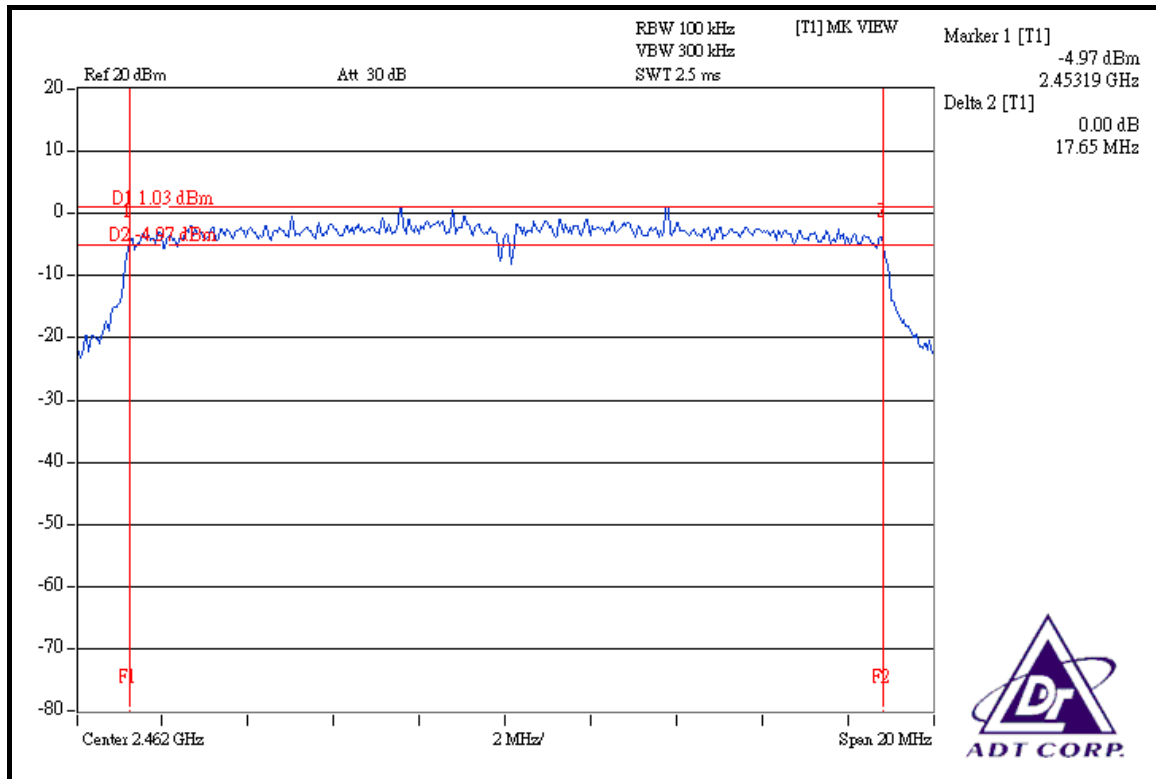

### FOR CHAIN 1: CH 1

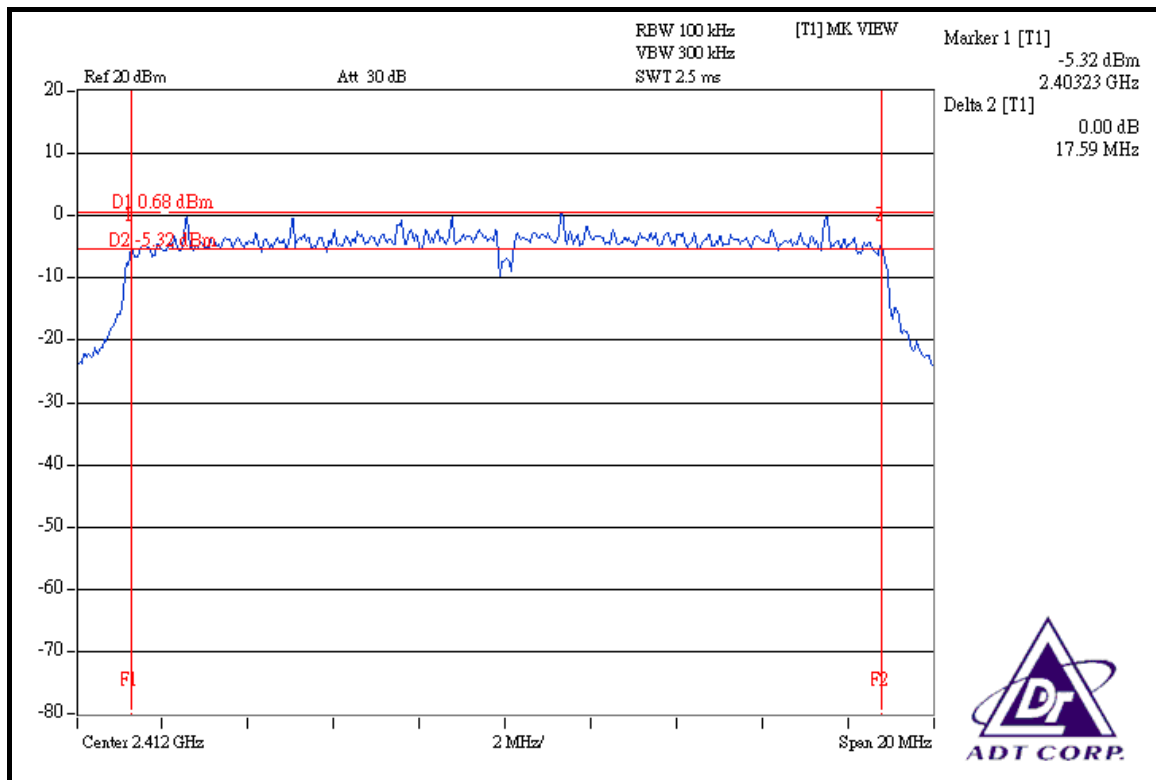

### CH 6

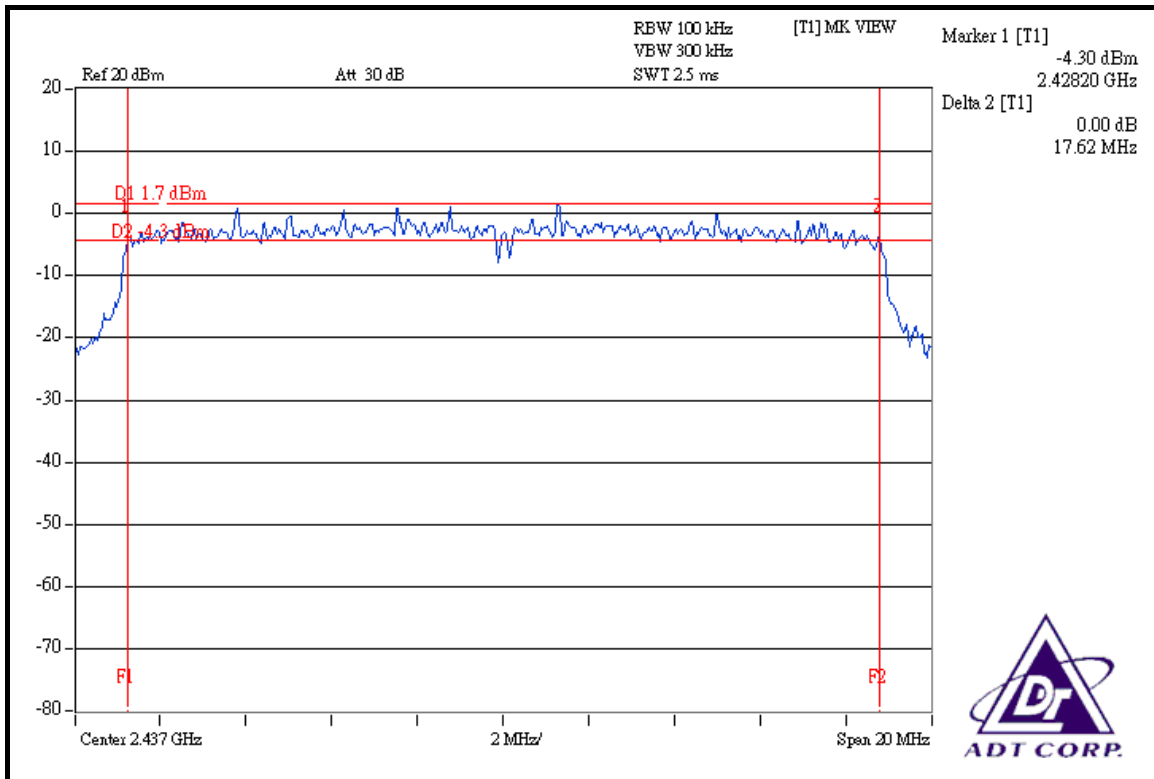

### CH 11

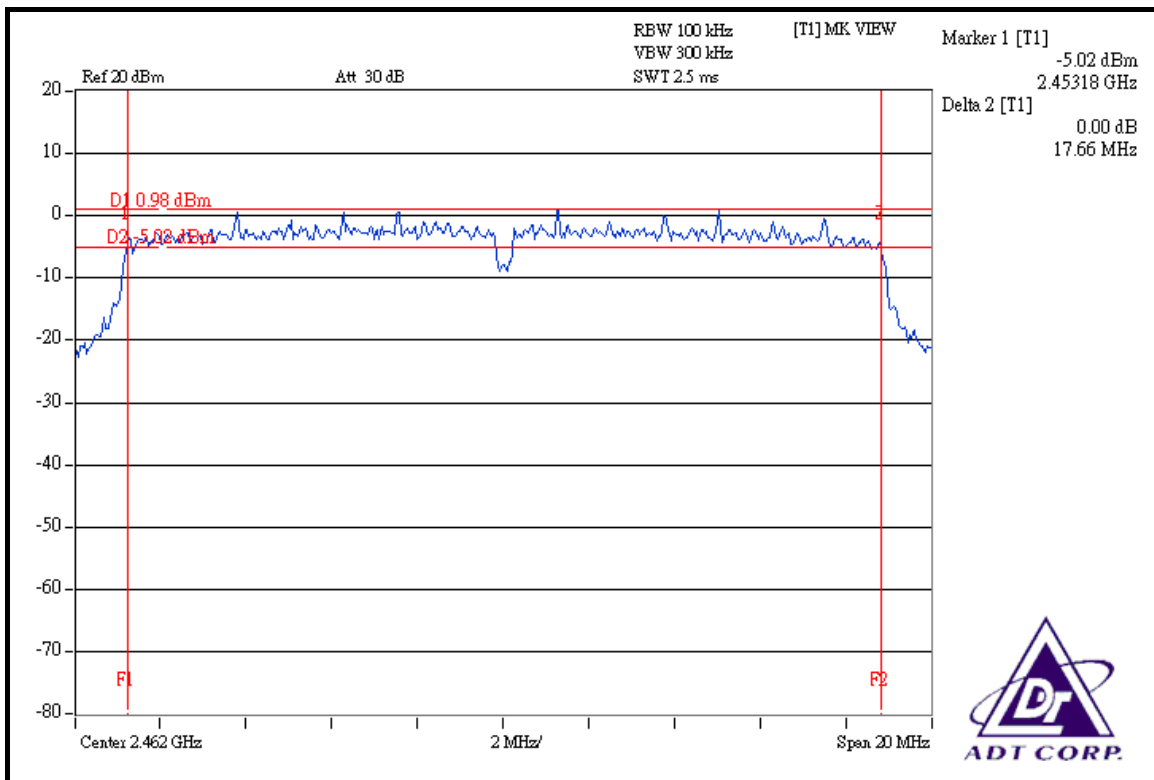



**DRAFT 802.11n (40MHz) OFDM MODULATION**

<b>MODULATION TYPE</b>	BPSK	<b>TRANSFER RATE</b>	15.0Mbps
<b>INPUT POWER (SYSTEM)</b>	120Vac, 60 Hz	<b>ENVIRONMENTAL CONDITIONS</b>	23deg.C, 61%RH, 991hPa
<b>TESTED BY</b>	Long Chen		

CHANNEL	CHANNEL FREQUENCY (MHz)	6dB BANDWIDTH (MHz)		MINIMUM LIMIT (MHz)	PASS / FAIL
		CHAIN 0	CHAIN 1		
1	2422	36.44	36.46	0.5	PASS
4	2437	36.51	36.52	0.5	PASS
7	2452	36.52	36.50	0.5	PASS



### FOR CHAIN 0: CH 1

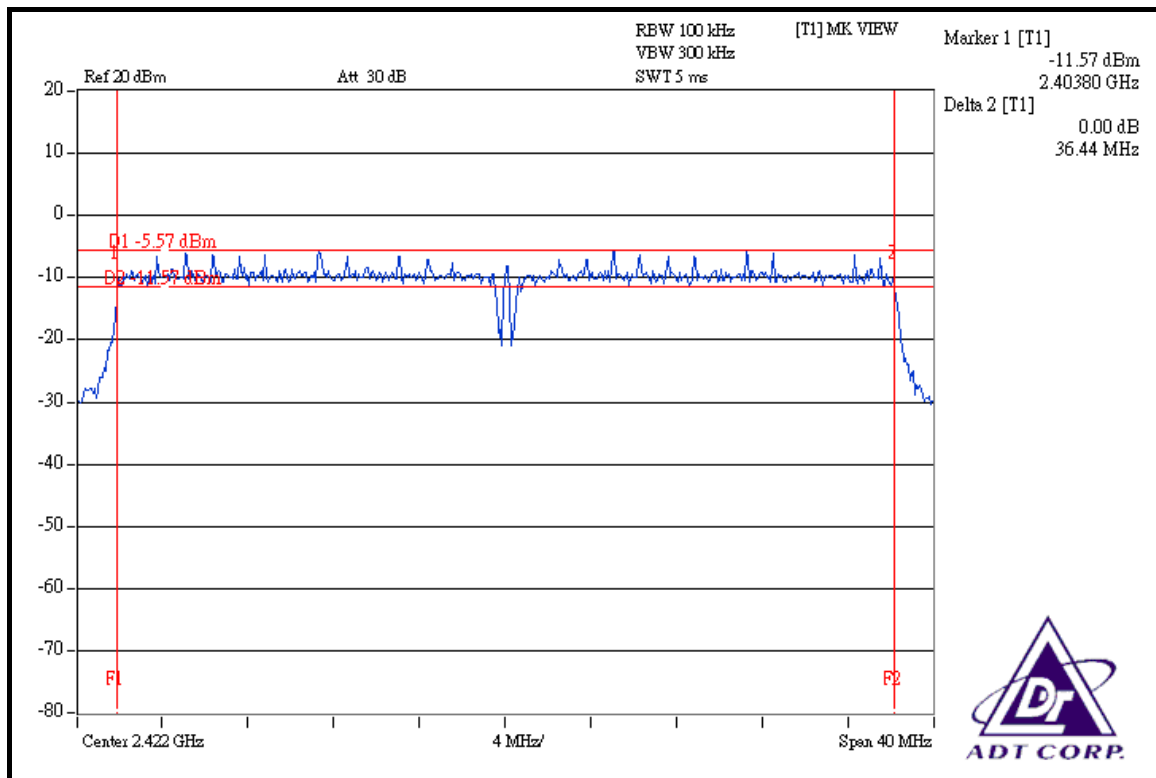

### CH 4

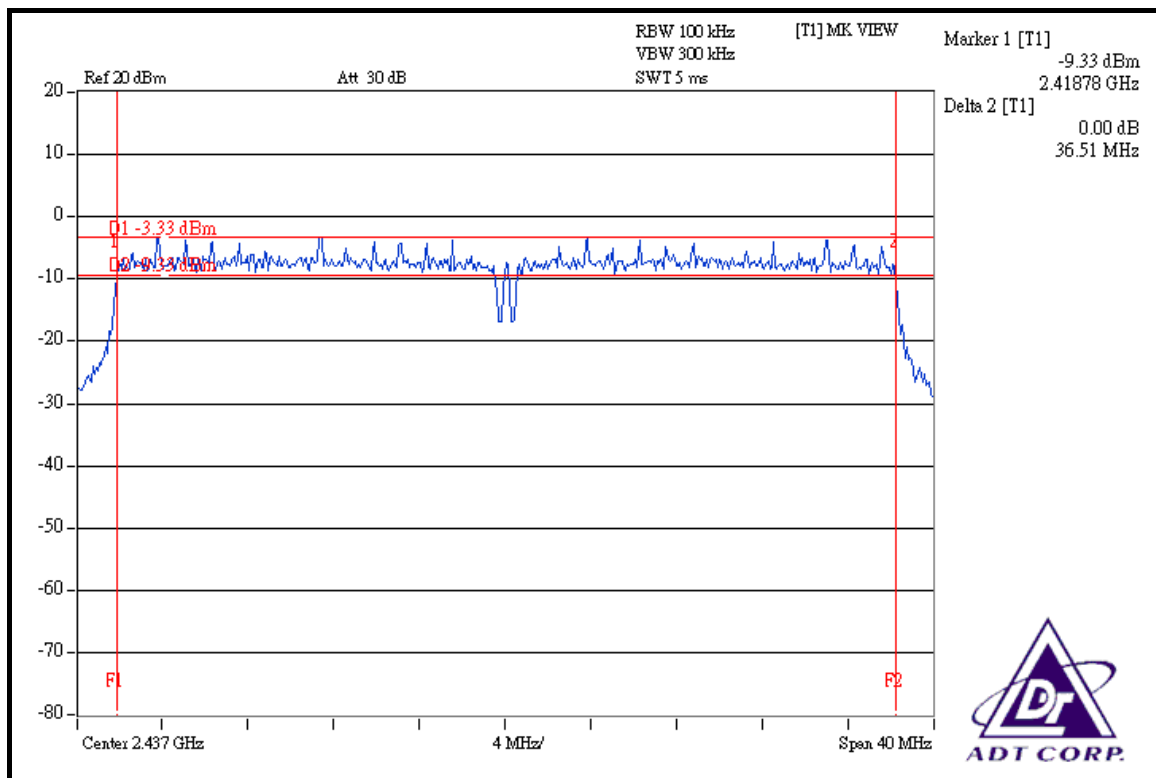

### CH 7

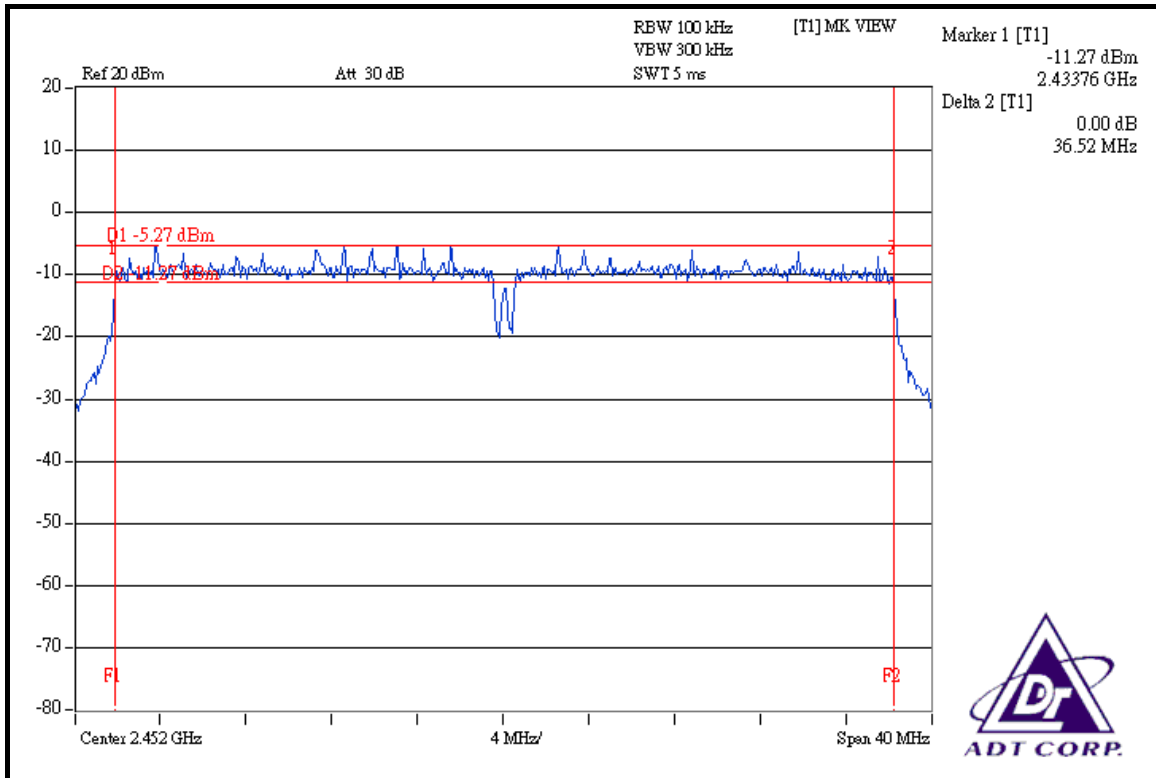

### FOR CHAIN 1: CH 1

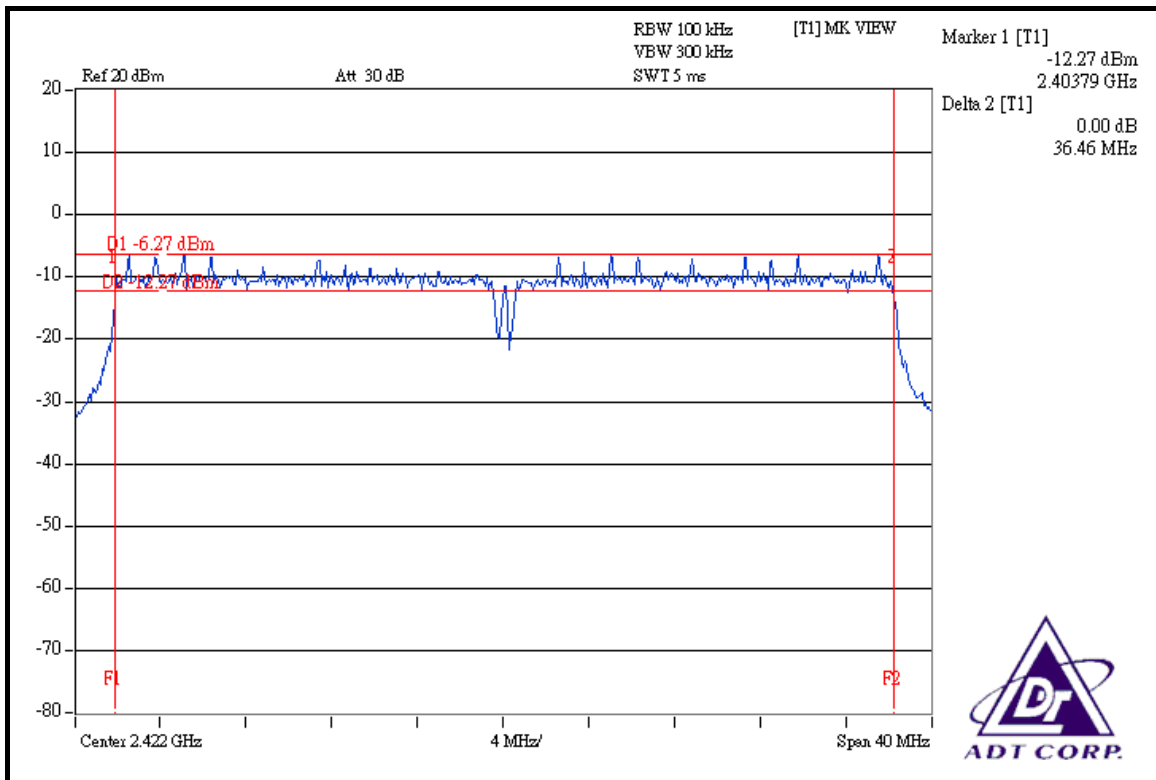

### CH 4

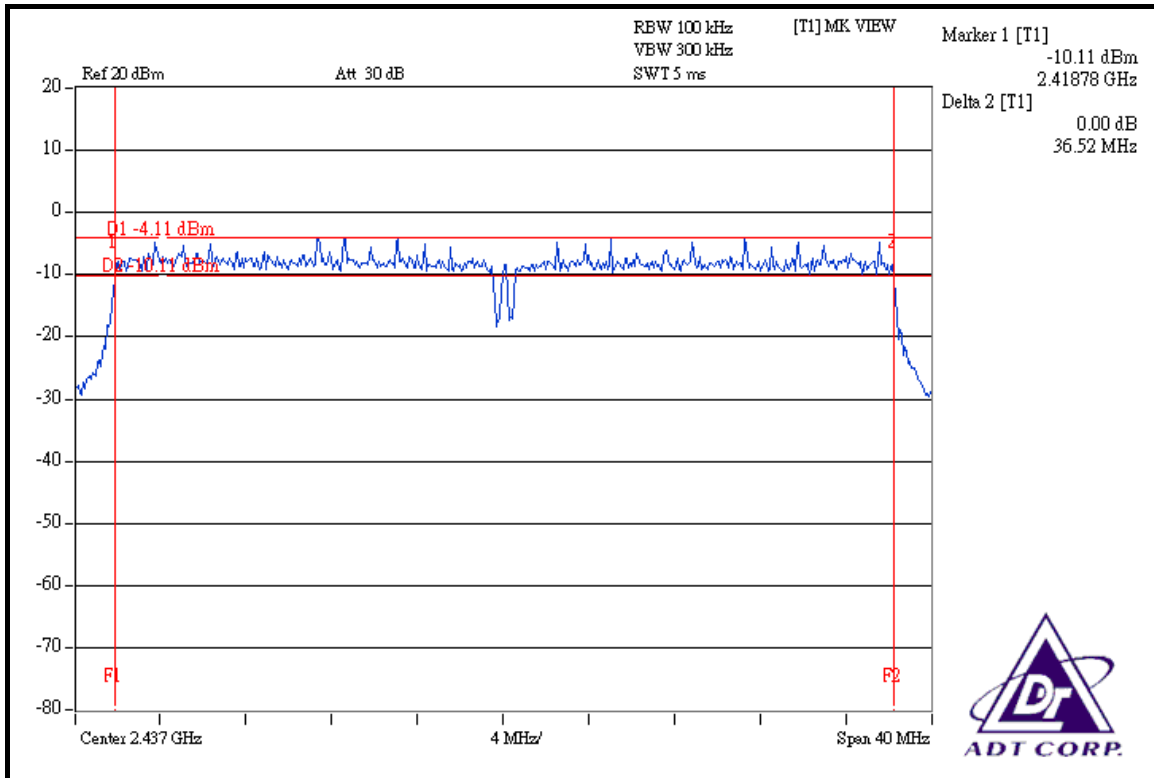

### CH 7

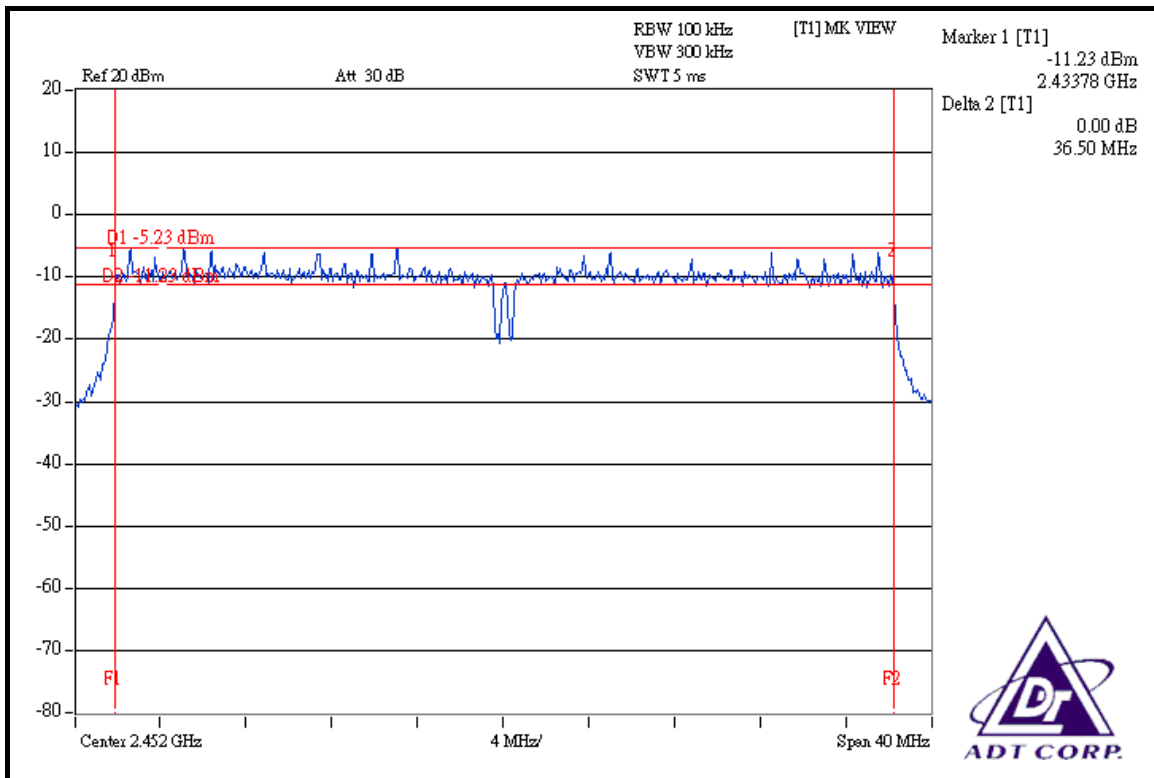



#### 4.4 MAXIMUM PEAK OUTPUT POWER

##### 4.4.1 LIMITS OF MAXIMUM PEAK OUTPUT POWER MEASUREMENT

The Maximum Peak Output Power Measurement is 30dBm.

##### 4.4.2 INSTRUMENTS

DESCRIPTION & MANUFACTURER	MODEL NO.	SERIAL NO.	CALIBRATED UNTIL
SPECTRUM ANALYZER	FSP40	100040	Jun. 28, 2008
AGILENT SYNTHESIZED SIGNAL GENERATOR	E8257C	MY43320668	Dec. 25, 2008
DIGITAL RT OSCILLOSCOPE	TDS1012	C037299	Nov. 21, 2008
NARDA DETECTOR	4503A	FSCM99899	NA

**NOTE:** The calibration interval of the above test instruments is 12 months and the calibrations are traceable to NML/ROC and NIST/USA.

##### 4.4.3 TEST PROCEDURES

- a. A detector was used on the output port of the EUT. An oscilloscope was used to read the response of the detector.
- b. Replaced the EUT by the signal generator. The center frequency of the S.G was adjusted to the center frequency of the measured channel.
- c. Adjusted the power to have the same reading on oscilloscope. Record the power level.

##### 4.4.4 DEVIATION FROM TEST STANDARD

No deviation.

#### 4.4.5 TEST SETUP



#### 4.4.6 EUT OPERATING CONDITIONS

Same as Item 4.3.6.



#### 4.4.7 TEST RESULTS

##### 802.11b DSSS MODULATION

<b>MODULATION TYPE</b>	DBPSK	<b>TRANSFER RATE</b>	1.0Mbps
<b>INPUT POWER (SYSTEM)</b>	120Vac, 60 Hz	<b>ENVIRONMENTAL CONDITIONS</b>	23deg.C, 61%RH, 991hPa
<b>TESTED BY</b>	Long Chen		

CHAN	CHANNEL FREQUENCY (MHz)	PEAK POWER OUTPUT (mW)	PEAK POWER OUTPUT (dBm)	PEAK POWER LIMIT (dBm)	PASS/FAIL
1	2412	50.816	17.06	30	PASS
6	2437	50.582	17.04	30	PASS
11	2462	50.933	17.07	30	PASS

##### 802.11g OFDM MODULATION

<b>MODULATION TYPE</b>	BPSK	<b>TRANSFER RATE</b>	6.0Mbps
<b>INPUT POWER (SYSTEM)</b>	120Vac, 60 Hz	<b>ENVIRONMENTAL CONDITIONS</b>	23deg.C, 61%RH, 991hPa
<b>TESTED BY</b>	Long Chen		

CHAN	CHANNEL FREQUENCY (MHz)	PEAK POWER OUTPUT (mW)	PEAK POWER OUTPUT (dBm)	PEAK POWER LIMIT (dBm)	PASS/FAIL
1	2412	71.121	18.52	30	PASS
6	2437	90.782	19.58	30	PASS
11	2462	102.094	20.09	30	PASS



### DRAFT 802.11n (20MHz) OFDM MODULATION

<b>MODULATION TYPE</b>	BPSK	<b>TRANSFER RATE</b>	7.2Mbps
<b>INPUT POWER (SYSTEM)</b>	120Vac, 60 Hz	<b>ENVIRONMENTAL CONDITIONS</b>	23deg.C, 61%RH, 991hPa
<b>TESTED BY</b>	Long Chen		

CHANNEL	CHANNEL FREQUENCY (MHz)	PEAK POWER OUTPUT (dBm)		TOTAL PEAK POWER (mW)	TOTAL PEAK POWER (dBm)	PEAK POWER LIMIT (dBm)	PASS / FAIL
		CHAIN 0	CHAIN 1				
1	2412	17.46	16.39	99.270	19.97	30	PASS
6	2437	18.53	17.26	124.496	20.95	30	PASS
11	2462	18.25	17.08	117.885	20.71	30	PASS

### DRAFT 802.11n (40MHz) OFDM MODULATION

<b>MODULATION TYPE</b>	BPSK	<b>TRANSFER RATE</b>	15.0Mbps
<b>INPUT POWER (SYSTEM)</b>	120Vac, 60 Hz	<b>ENVIRONMENTAL CONDITIONS</b>	23deg.C, 61%RH, 991hPa
<b>TESTED BY</b>	Long Chen		

CHANNEL	CHANNEL FREQUENCY (MHz)	PEAK POWER OUTPUT (dBm)		TOTAL PEAK POWER (mW)	TOTAL PEAK POWER (dBm)	PEAK POWER LIMIT (dBm)	PASS / FAIL
		CHAIN 0	CHAIN 1				
1	2422	15.31	15.20	67.076	18.27	30	PASS
4	2437	17.26	17.04	103.793	20.16	30	PASS
7	2452	15.65	15.59	72.953	18.63	30	PASS



## 4.5 POWER SPECTRAL DENSITY MEASUREMENT

### 4.5.1 LIMITS OF POWER SPECTRAL DENSITY MEASUREMENT

The Maximum of Power Spectral Density Measurement is 8dBm.

### 4.5.2 TEST INSTRUMENTS

DESCRIPTION & MANUFACTURER	MODEL NO.	SERIAL NO.	CALIBRATED UNTIL
R&S SPECTRUM ANALYZER	FSP 40	100040	Jun. 28, 2008

**NOTE:** The calibration interval of the above test instruments is 12 months and the calibrations are traceable to NML/ROC and NIST/USA.

### 4.5.3 TEST PROCEDURE

The transmitter output was connected to the spectrum analyzer through an attenuator, the bandwidth of the fundamental frequency was measured with the spectrum analyzer using 3kHz RBW and 30kHz VBW, set sweep time = span/3kHz. The power spectral density was measured and recorded.

The sweep time is allowed to be longer than span/3kHz for a full response of the mixer in the spectrum analyzer.

### 4.5.4 DEVIATION FROM TEST STANDARD

No deviation.

#### 4.5.5 TEST SETUP

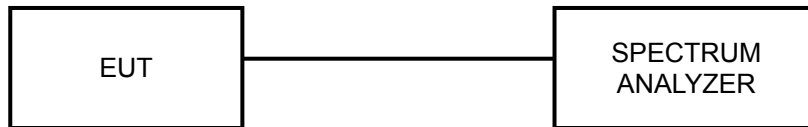

#### 4.5.6 EUT OPERATING CONDITION

Same as Item 4.3.6.



## 4.5.7 TEST RESULTS

### 802.11b DSSS MODULATION

<b>MODULATION TYPE</b>	DBPSK	<b>TRANSFER RATE</b>	1.0Mbps
<b>INPUT POWER (SYSTEM)</b>	120Vac, 60 Hz	<b>ENVIRONMENTAL CONDITIONS</b>	23deg.C, 61%RH, 991hPa
<b>TESTED BY</b>	Long Chen		

CHANNEL	CHANNEL FREQUENCY (MHz)	RF POWER LEVEL IN 3 kHz BW (dBm)	MAXIMUM LIMIT (dBm)	PASS/FAIL
1	2412	-8.94	8	PASS
6	2437	-8.87	8	PASS
11	2462	-8.74	8	PASS

### CH 1

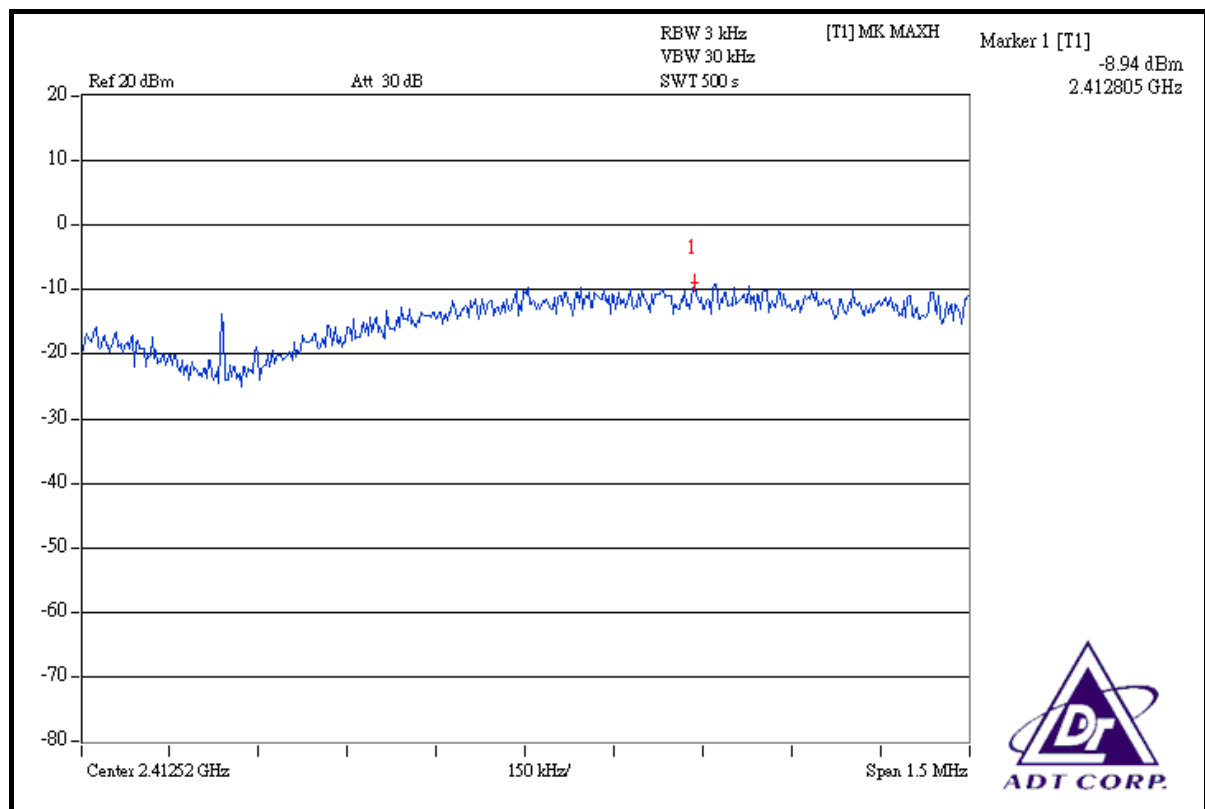

### CH 6

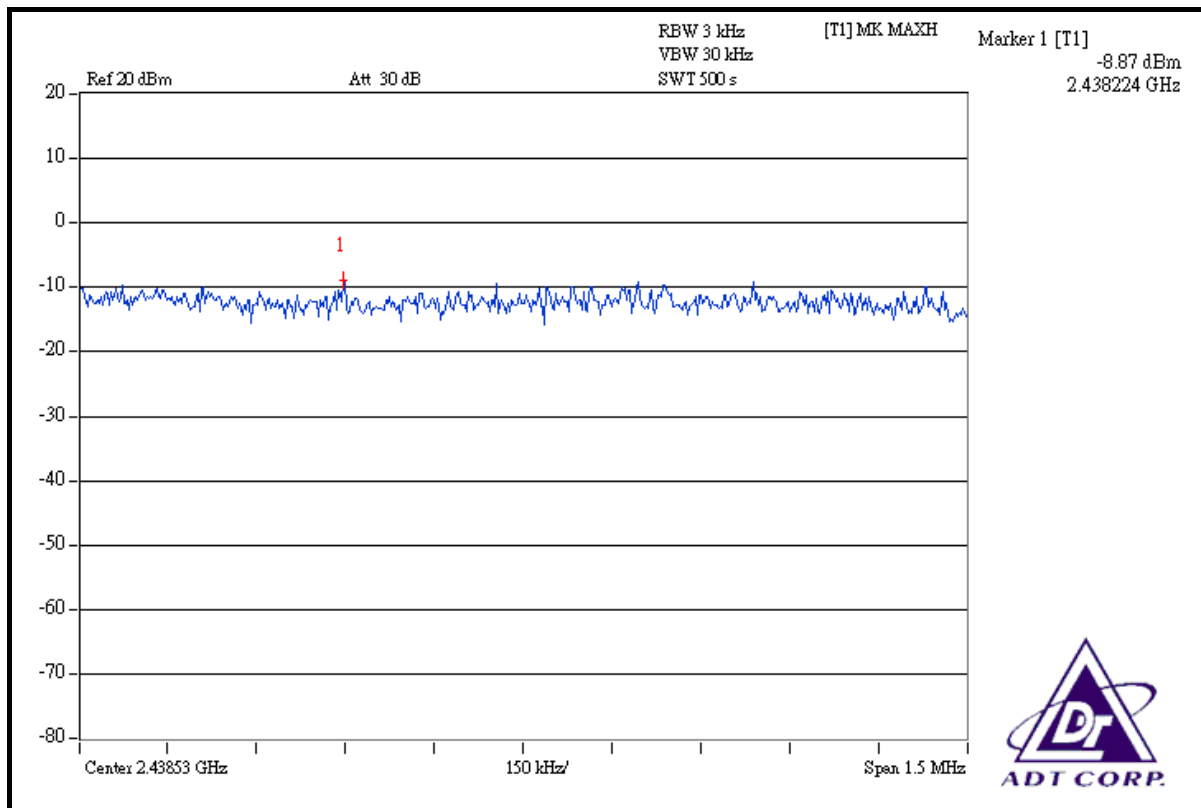

### CH 11

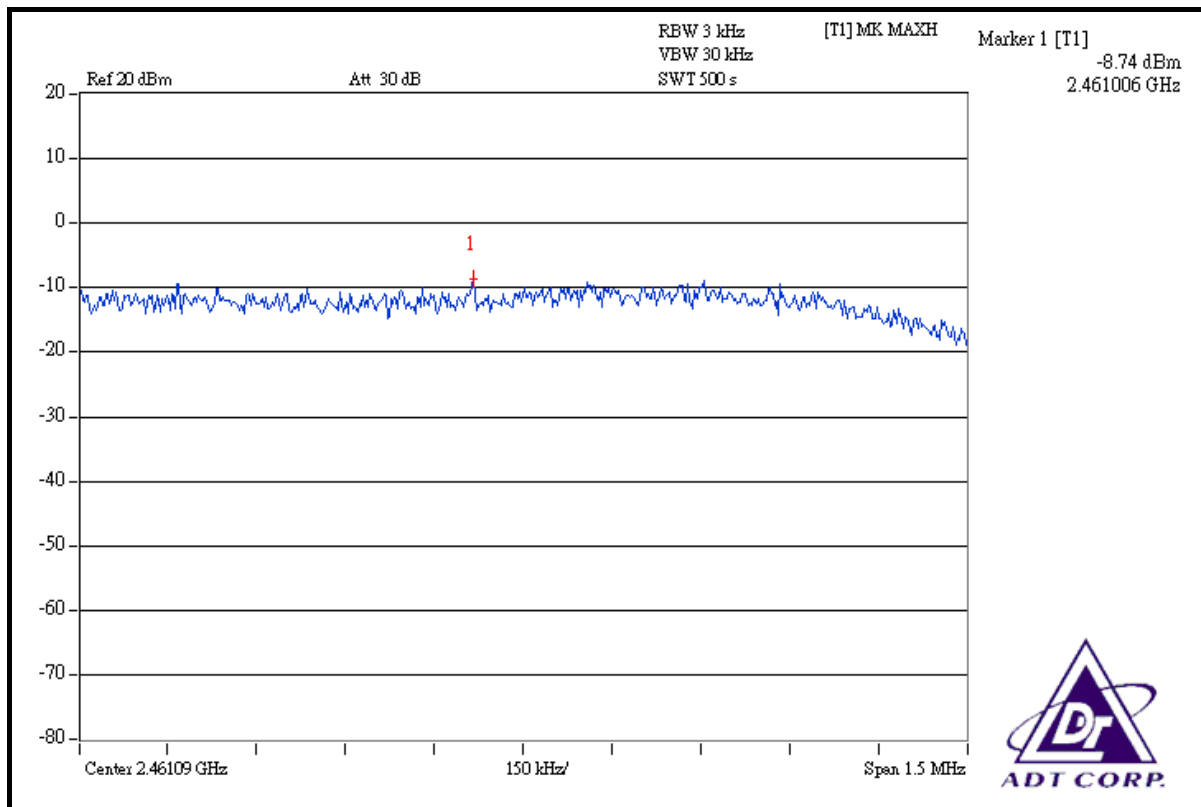

### 802.11g OFDM MODULATION

<b>MODULATION TYPE</b>	BPSK	<b>TRANSFER RATE</b>	6.0Mbps
<b>INPUT POWER (SYSTEM)</b>	120Vac, 60 Hz	<b>ENVIRONMENTAL CONDITIONS</b>	23deg.C, 61%RH, 991hPa
<b>TESTED BY</b>	Long Chen		

CHANNEL	CHANNEL FREQUENCY (MHz)	RF POWER LEVEL IN 3 kHz BW (dBm)	MAXIMUM LIMIT (dBm)	PASS/FAIL
1	2412	-10.38	8	PASS
6	2437	-4.99	8	PASS
11	2462	-6.76	8	PASS

### CH 1

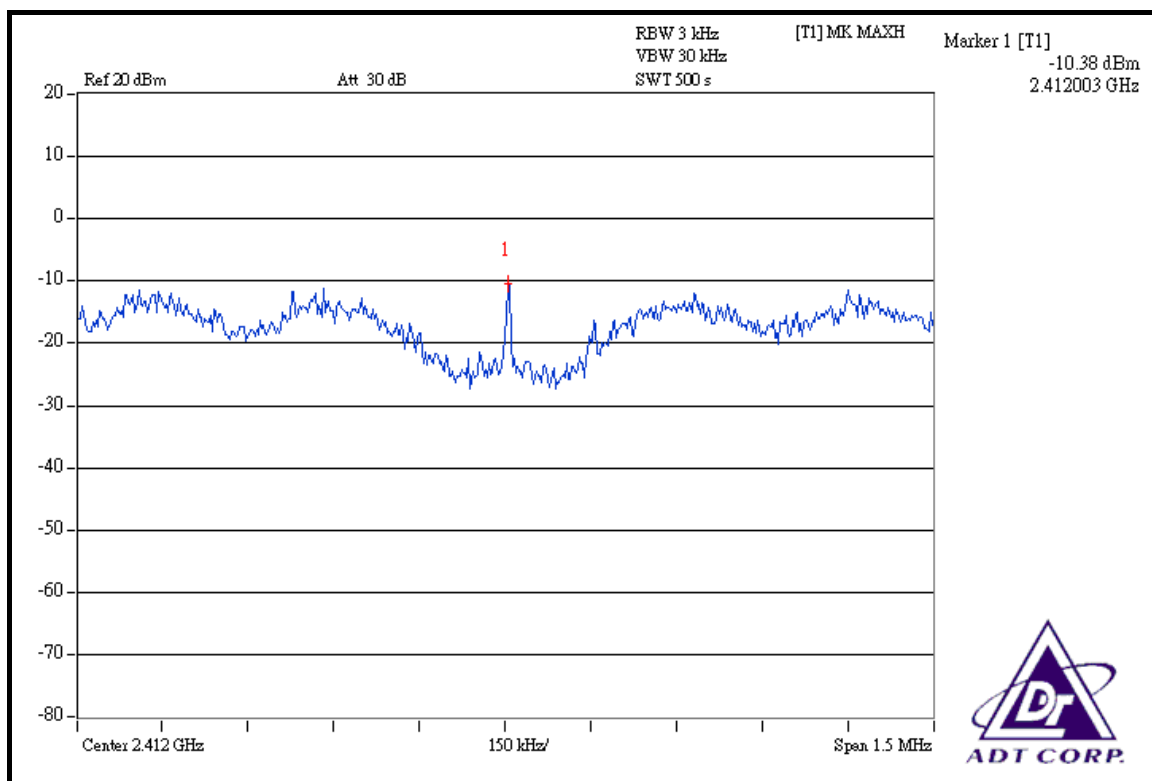







**DRAFT 802.11n (20MHz) OFDM MODULATION**

<b>MODULATION TYPE</b>	BPSK	<b>TRANSFER RATE</b>	7.2Mbps
<b>INPUT POWER (SYSTEM)</b>	120Vac, 60 Hz	<b>ENVIRONMENTAL CONDITIONS</b>	23deg.C, 61%RH, 991hPa
<b>TESTED BY</b>	Long Chen		

CHANNEL	CHANNEL FREQUENCY (MHz)	RF POWER LEVEL IN 3kHz BW (dBm)		TOTAL POWER DENSITY (mW)	TOTAL POWER DENSITY (dBm)	MAX. LIMIT (dBm)	PASS / FAIL
		CHAIN 0	CHAIN 1				
1	2412	-8.56	-10.64	0.226	-6.466	8	PASS
6	2437	-7.49	-7.26	0.366	-4.363	8	PASS
11	2462	-7.94	-12.95	0.211	-6.749	8	PASS



### FOR CHAIN 0: CH 1

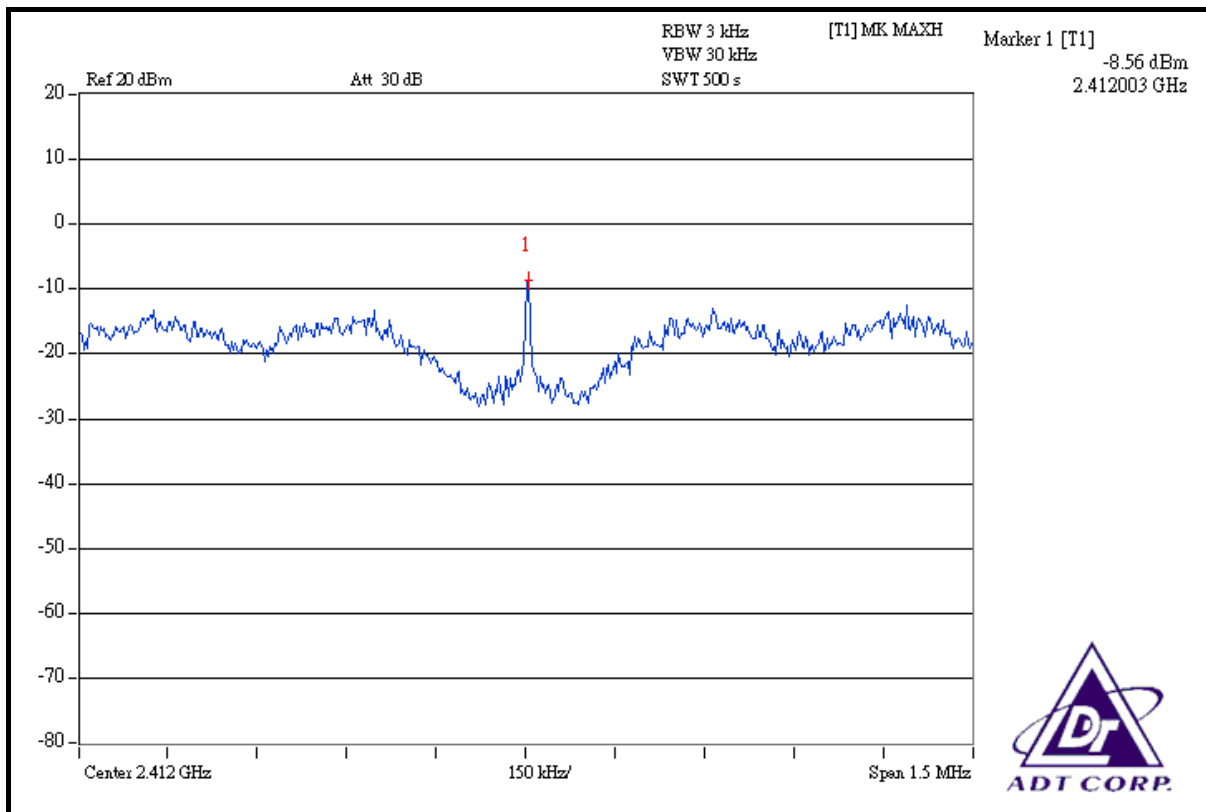

### CH 6

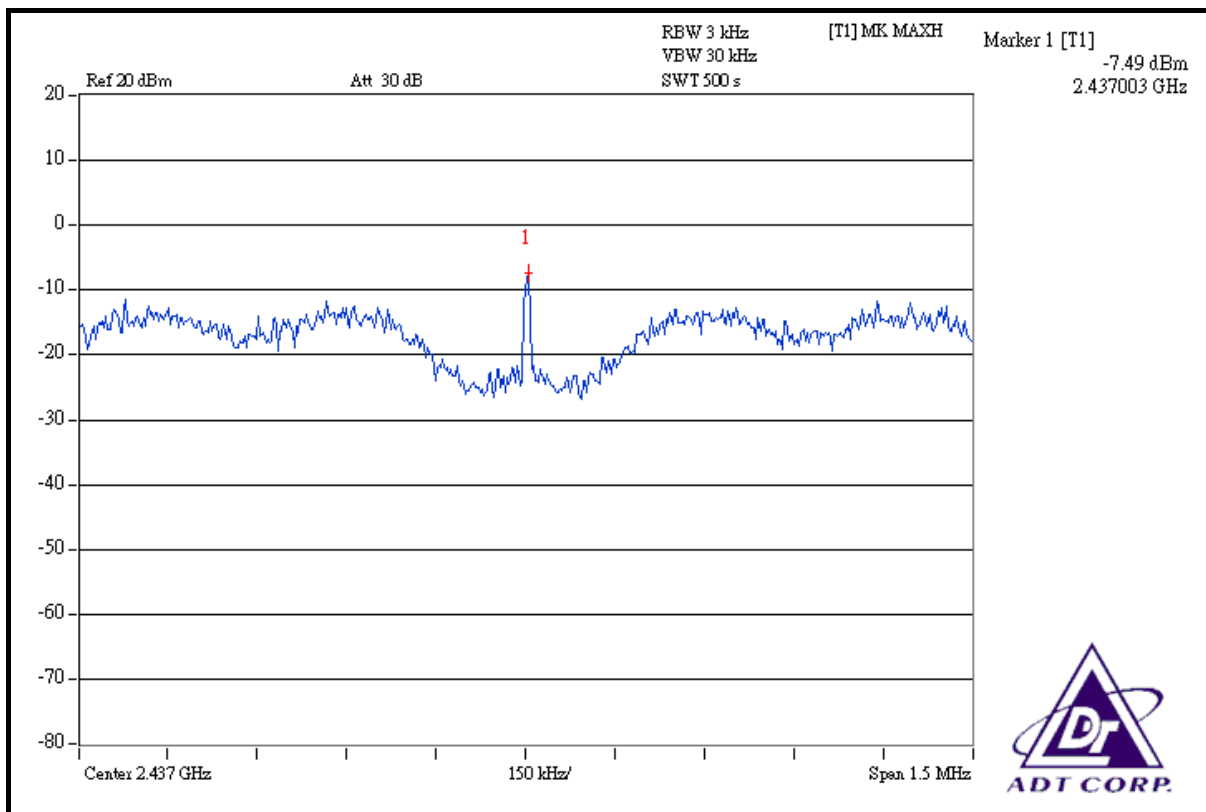



CH 11

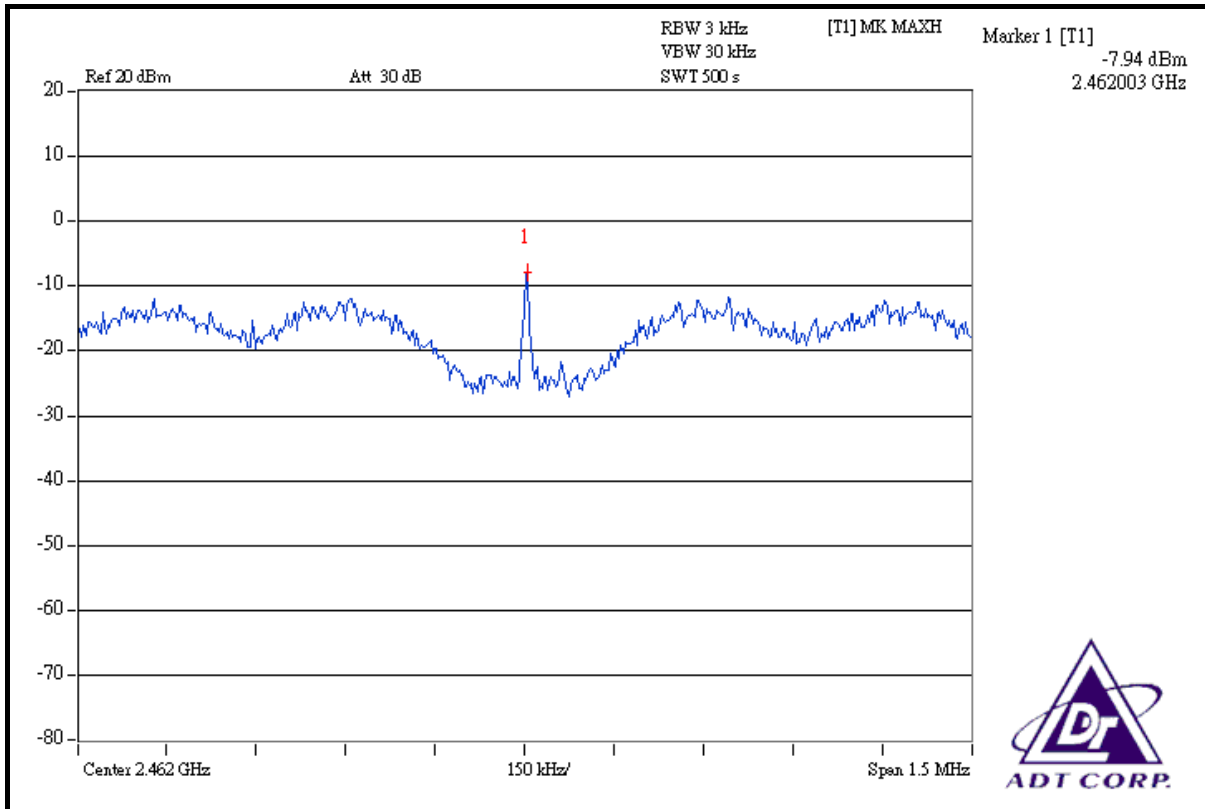

FOR CHAIN 1: CH 1

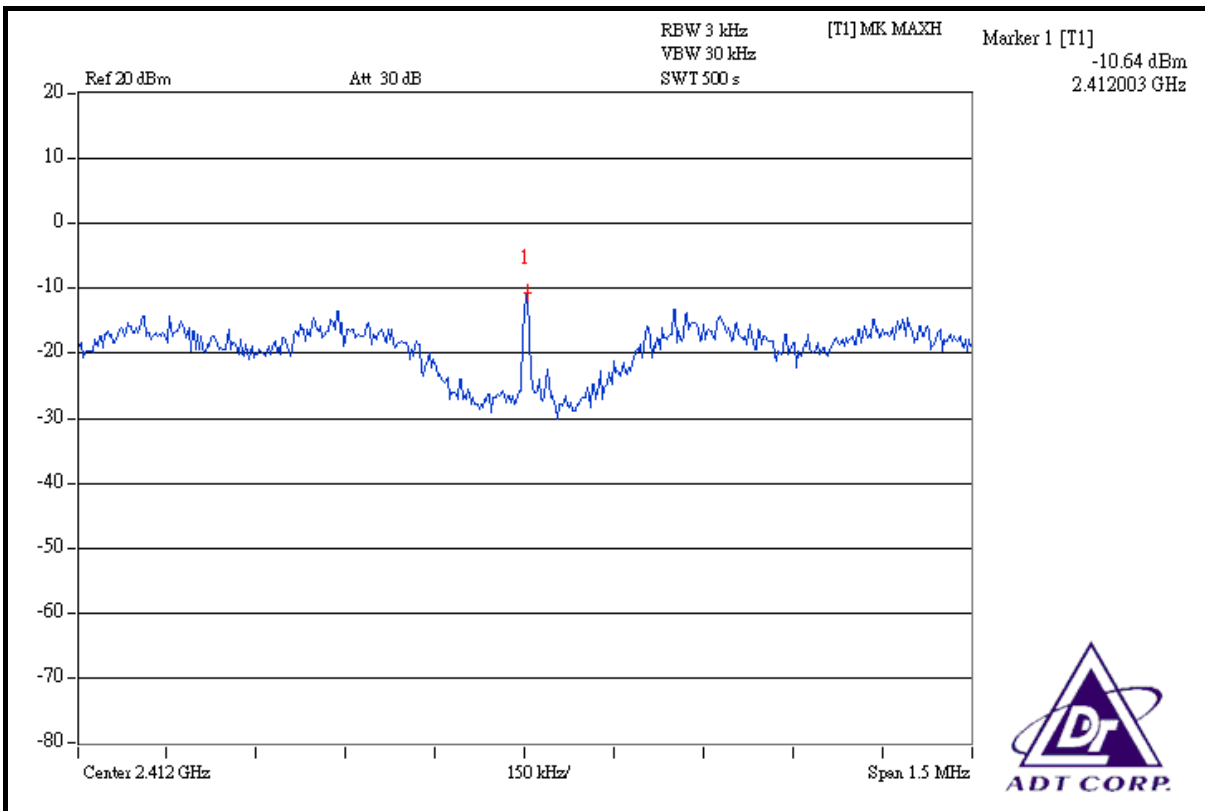



### CH 6

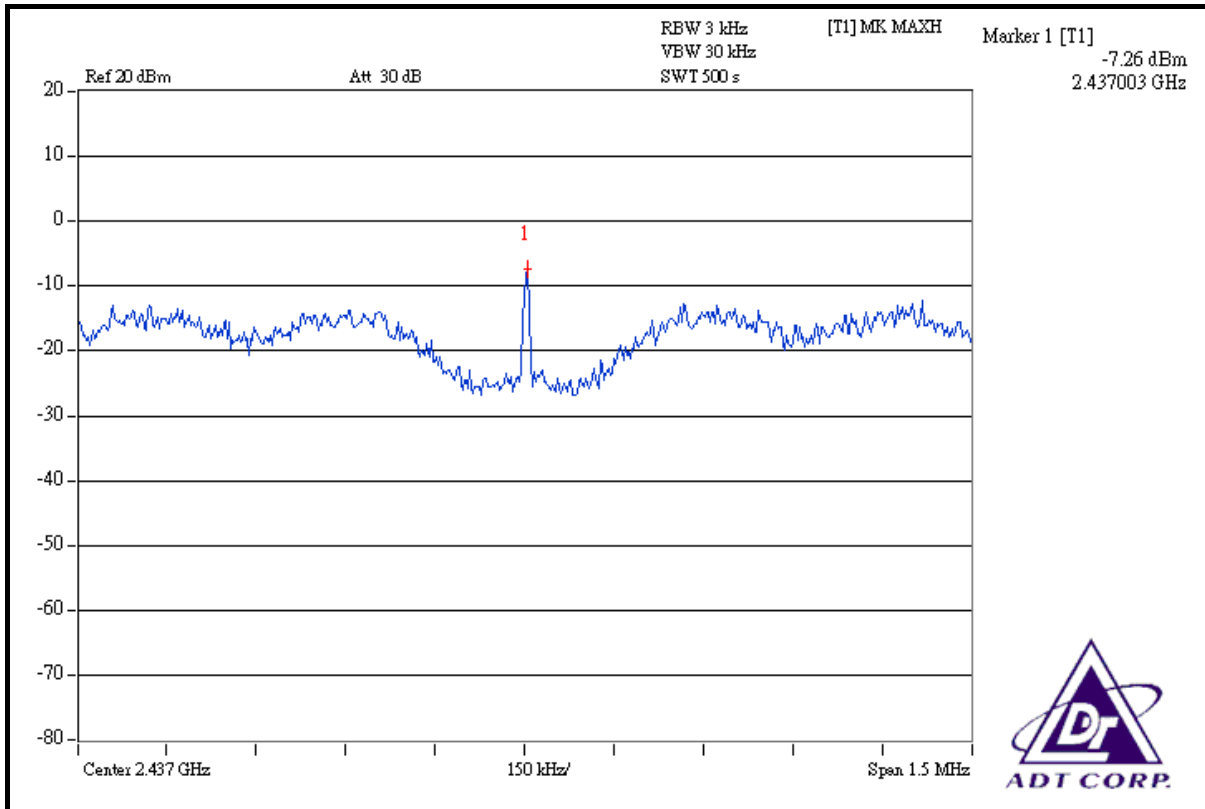

### CH 11

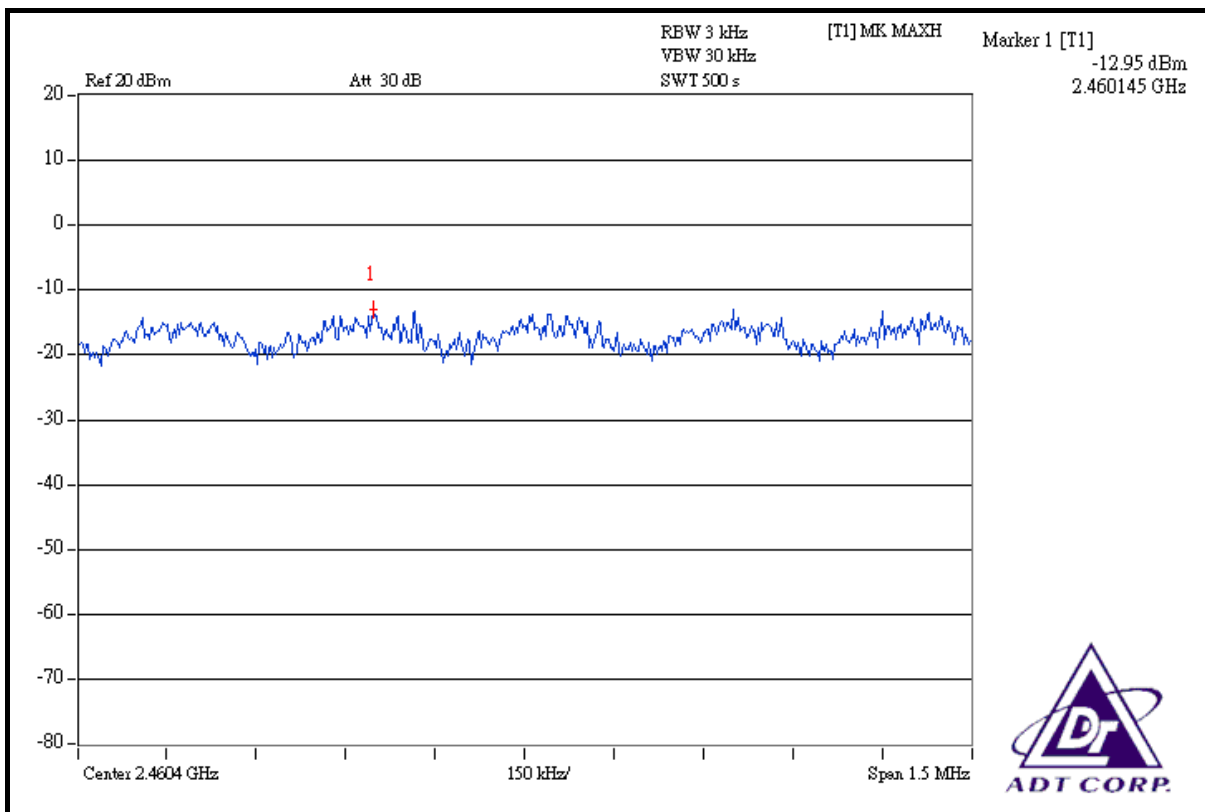



### DRAFT 802.11n (40MHz) OFDM MODULATION

<b>MODULATION TYPE</b>	BPSK	<b>TRANSFER RATE</b>	15Mbps
<b>INPUT POWER (SYSTEM)</b>	120Vac, 60 Hz	<b>ENVIRONMENTAL CONDITIONS</b>	23deg.C, 61%RH, 991hPa
<b>TESTED BY</b>	Long Chen		

CHANNEL	CHANNEL FREQUENCY (MHz)	RF POWER LEVEL IN 3kHz BW (dBm)		TOTAL POWER DENSITY (mW)	TOTAL POWER DENSITY (dBm)	MAX. LIMIT (dBm)	PASS / FAIL
		CHAIN 0	CHAIN 1				
1	2422	-9.53	-12.96	0.162	-7.905	8	PASS
4	2437	-6.86	-9.66	0.314	-5.028	8	PASS
7	2452	-14.18	-12.53	0.094	-10.267	8	PASS



### FOR CHAIN 0: CH 1

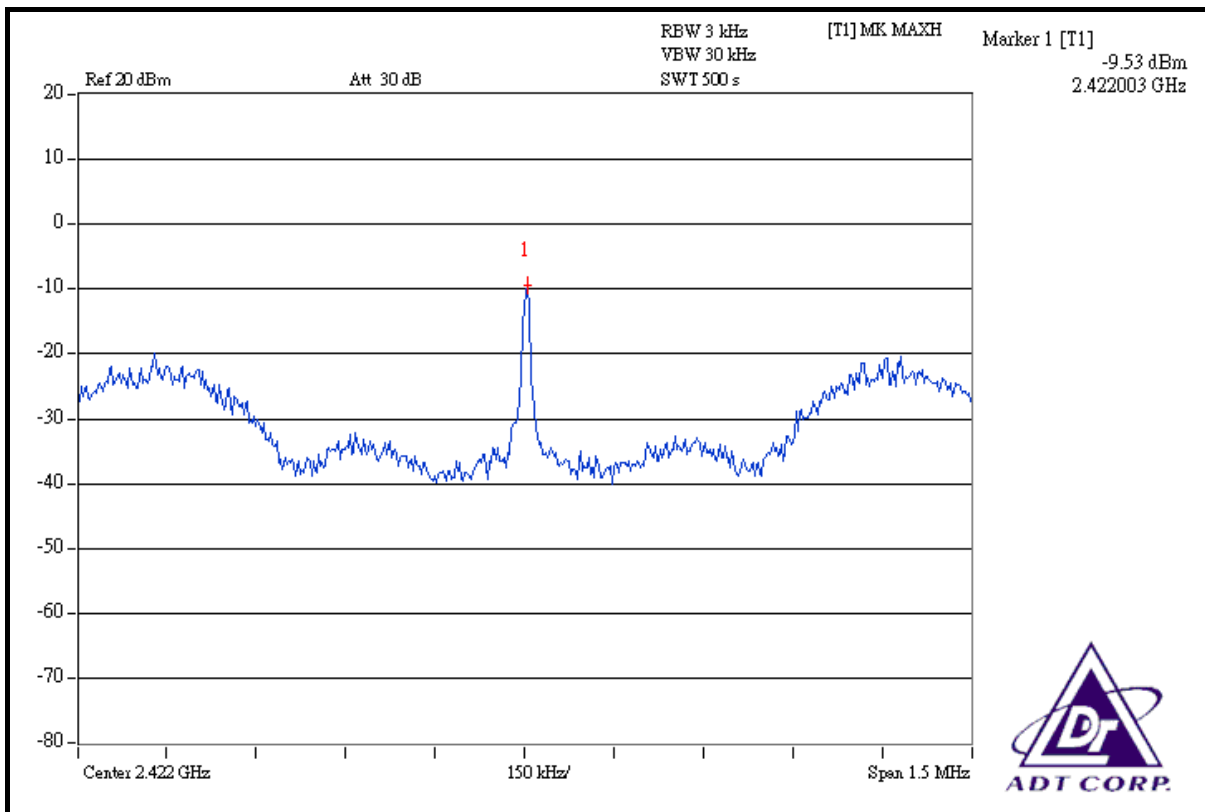

### CH 4

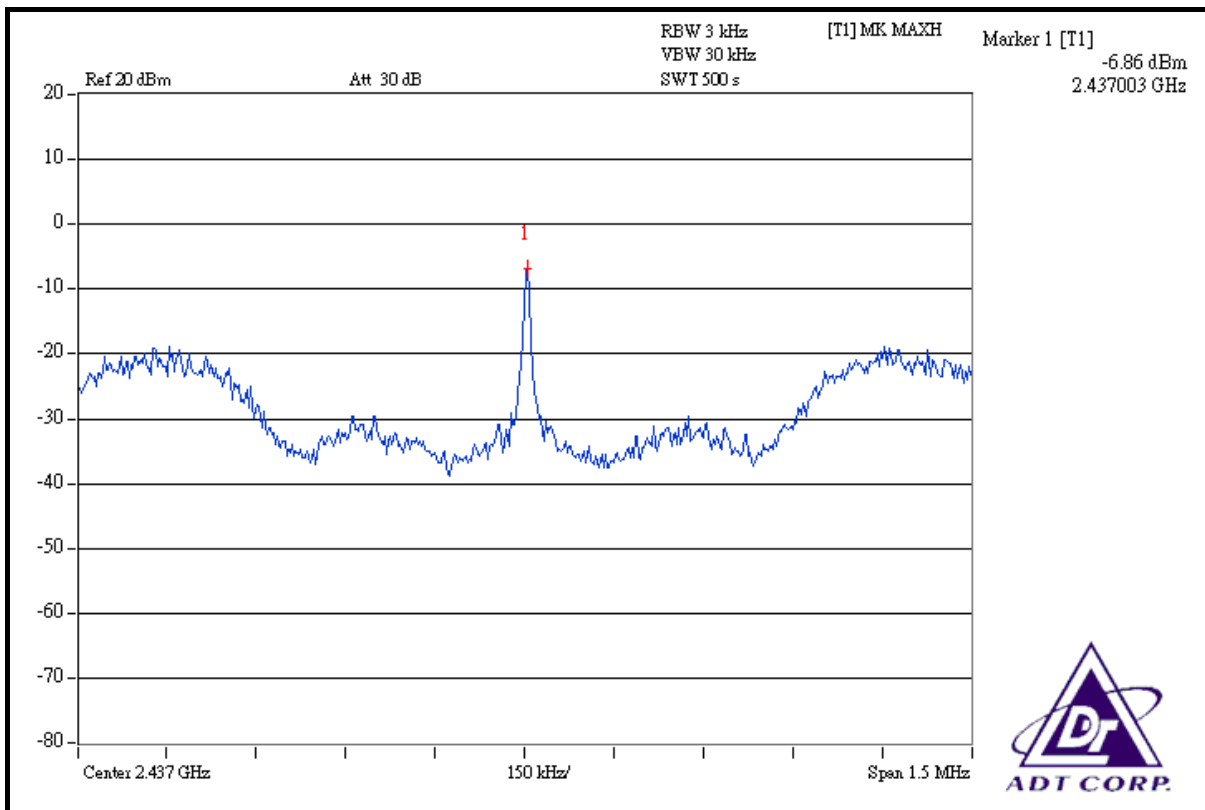



### CH 7

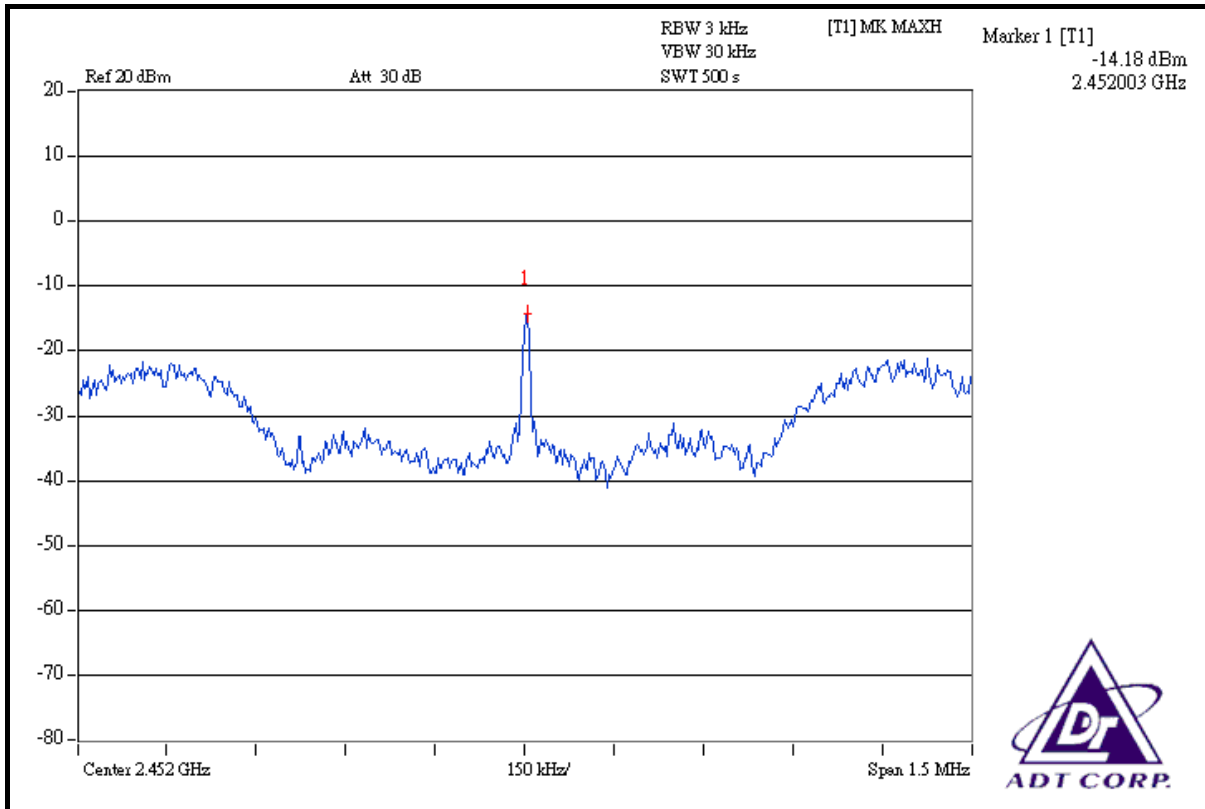

### FOR CHAIN 1: CH 1

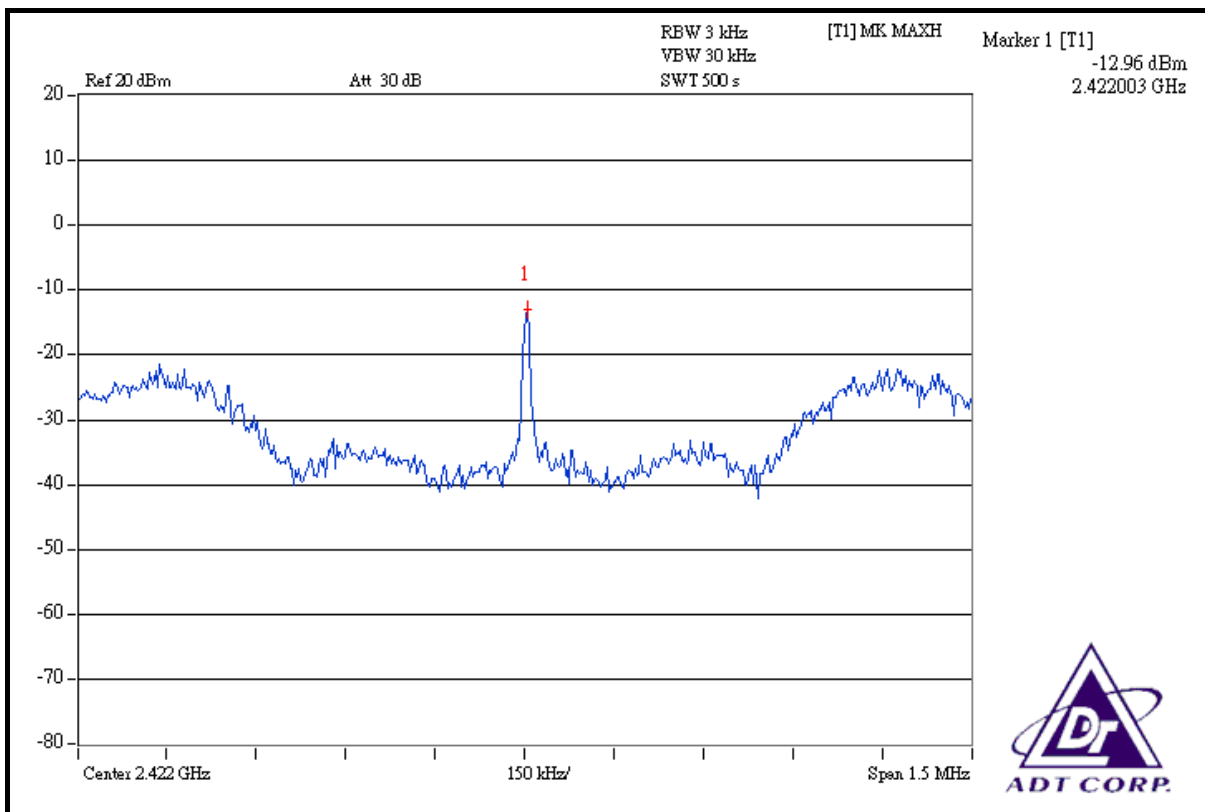



### CH 4

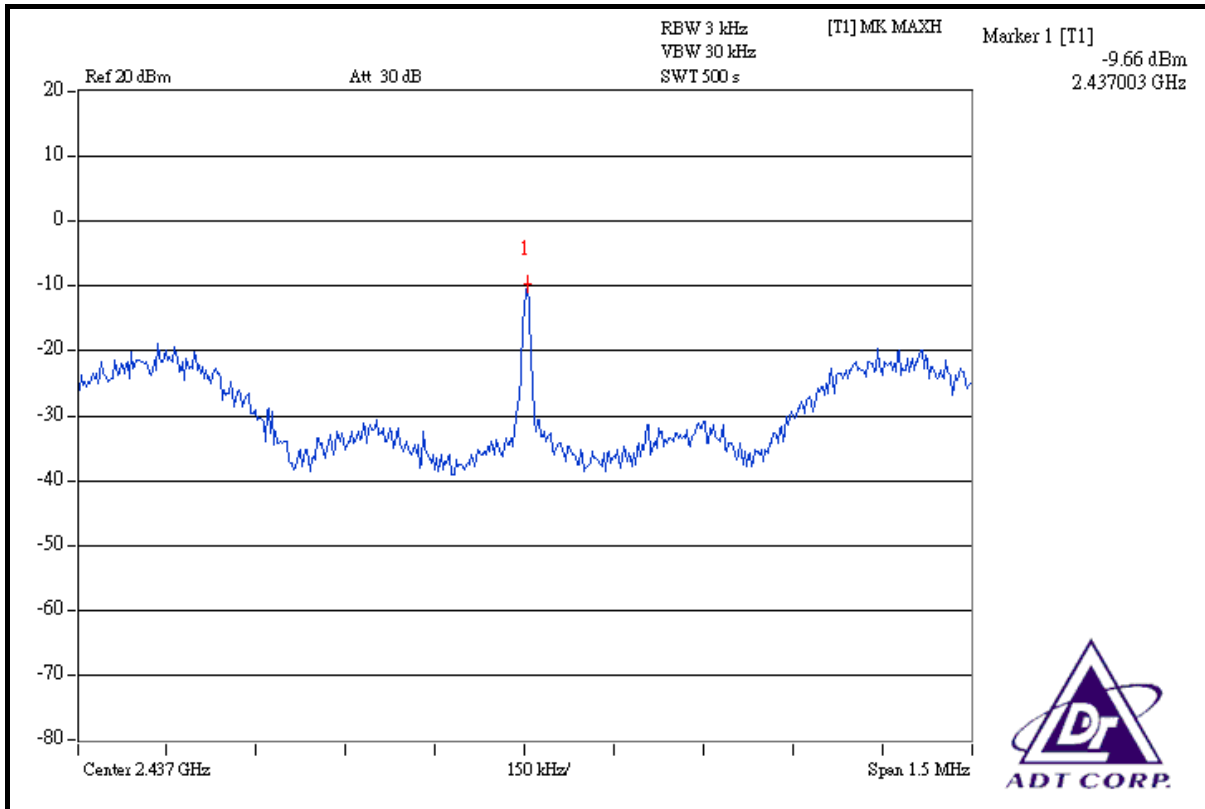

### CH 7

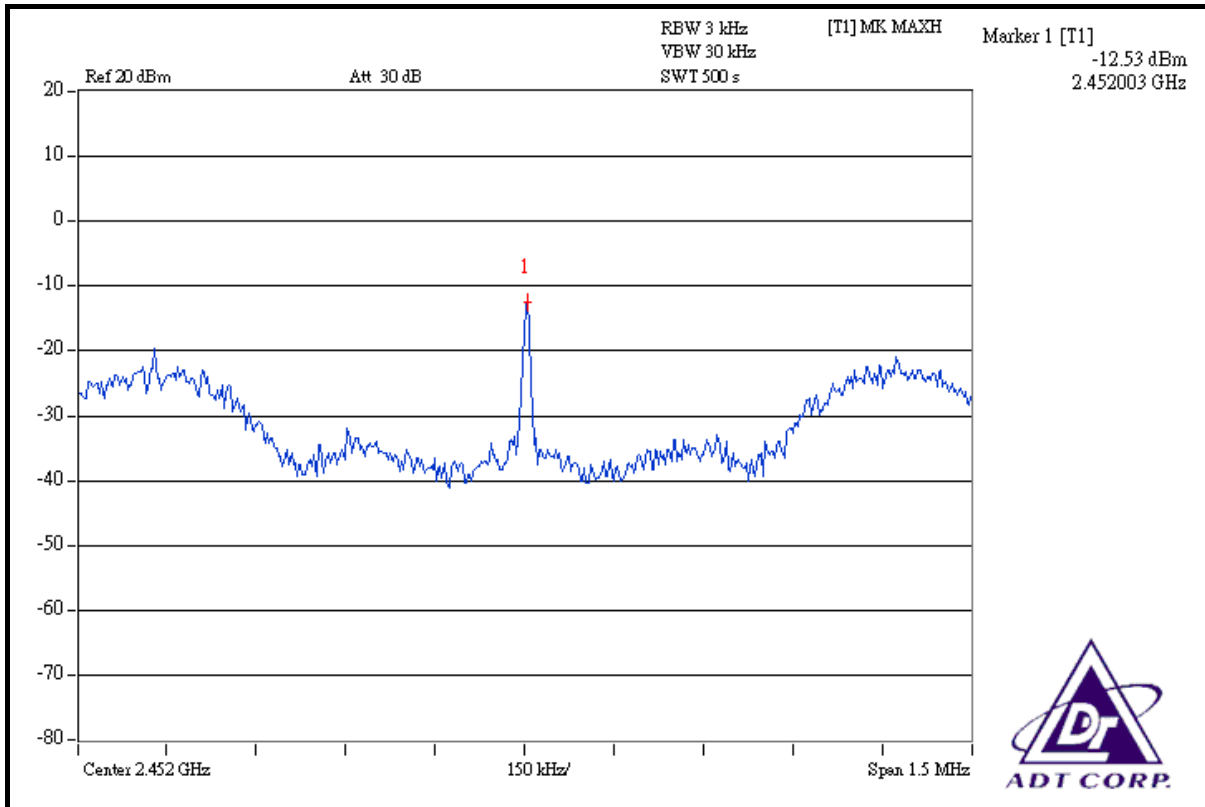





## 4.6 BAND EDGES MEASUREMENT

### 4.6.1 LIMITS OF BAND EDGES MEASUREMENT

Below –20dB of the highest emission level of operating band (in 100kHz Resolution Bandwidth).

### 4.6.2 TEST INSTRUMENTS

DESCRIPTION & MANUFACTURER	MODEL NO.	SERIAL NO.	CALIBRATED UNTIL
<b>FOR CONDUCTED MEASUREMENT</b>			
R&S SPECTRUM ANALYZER	FSP40	100040	Jun. 28, 2008
<b>FOR RADIATED MEASUREMENT</b>			
Test Receiver ROHDE & SCHWARZ	ESCI	100424	Jul. 27, 2008
Spectrum Analyzer ROHDE & SCHWARZ	FSP40	100269	Aug. 05, 2008
BILOG Antenna SCHWARZBECK	VULB9168	9168-153	Jan. 03, 2009
HORN Antenna SCHWARZBECK	BBHA 9120 D	9120D-563	Jul. 30, 2008
HORN Antenna SCHWARZBECK	BBHA 9170	BBHA9170242	Jan. 06, 2009
Preamplifier Agilent	8449B	3008A01910	Sep. 19, 2008
Preamplifier Agilent	8447D	2944A10638	Dec. 19, 2008
RF signal cable HUBER+SUHNNER	SUCOFLEX 104	274039/223650	Nov. 07, 2008
RF signal cable Worken	8D-FB	Cable-HYCH9-01	Aug. 09, 2008
Software	ADT Radiated V7.6	NA	NA
Antenna Tower EMCO	2070/2080	512.835.4684	NA
Turn Table EMCO	2087-2.03	NA	NA
Antenna Tower & Turn Table Controller EMCO	2090	NA	NA
Turn Table Controller ADT.	SC100.	SC93021704	NA

**NOTE:** The calibration interval of the above test instruments is 12 months and the calibrations are traceable to NML/ROC and NIST/USA.

#### 4.6.3 TEST PROCEDURE

##### FOR CONDUCTED MEASUREMENT

The transmitter output was connected to the spectrum analyzer via a low lose cable. Set both RBW and VBW of spectrum analyzer to 100kHz and 300kHz with suitable frequency span including 100MHz bandwidth from band edge. The band edges was measured and recorded.

The spectrum plots (Peak RBW = 100kHz, VBW = 300kHz; Average RBW = 1MHz, VBW = 10Hz) are attached on the following pages.

##### FOR RADIATED MEASUREMENT

- a. The EUT was placed on the top of a rotating table 0.8 meters above the ground at a 3 meter semi-anechoic chamber. The table was rotated 360 degrees to determine the position of the highest radiation.
- b. The EUT was set 3 meters away from the interference-receiving antenna, which was mounted on the top of a variable-height antenna tower.
- c. The antenna is a broadband antenna, and its height is varied from one meter to four meters above the ground to determine the maximum value of the field strength. Both horizontal and vertical polarizations of the antenna are set to make the measurement.
- d. For each suspected emission, the EUT was arranged to its worst case and then the antenna was tuned to heights from 1 meter to 4 meters and the rotatable table was turned from 0 degrees to 360 degrees to find the maximum reading.
- e. Set both RBW and VBW of spectrum analyzer to 100kHz with suitable frequency span including 100MHz bandwidth from band edge. The band edges was measured and recorded.

The spectrum plots (Peak RBW = 100kHz, VBW = 300kHz; Average RBW = 1MHz, VBW = 10Hz)

#### 4.6.4 DEVIATION FROM TEST STANDARD

No deviation.

#### 4.6.5 EUT OPERATING CONDITION

Same as Item 4.3.6.

#### 4.6.6 TEST RESULTS

The spectrum plots are attached on the following 24 images. D1 line indicates the highest level, and D2 line indicates the 20dB offset below D1. It shows compliance with the requirement in part 15.247(d).

#### 802.11b DSSS MODULATION

**NOTE 1:** The band edge emission plot on the next page shows 52.24dBc between carrier maximum power and local maximum emission in restrict band (2.3270GHz). The emission of carrier strength list in the test result of channel 1 at the item 4.2.7 is 107.86dBuV/m (Peak), so the maximum field strength in restrict band is  $107.86 - 52.24 = 55.62$ dBuV/m which is under 74dBuV/m limit.

The band edge emission plot on the next page shows 62.18dBc between carrier maximum power and local maximum emission in restrict band (2.3894GHz). The emission of carrier strength list in the test result of channel 1 at the item 4.2.7 is 103.18dBuV/m (Peak), so the maximum field strength in restrict band is  $103.18 - 62.18 = 41.00$ dBuV/m which is under 54dBuV/m limit.

**NOTE 2:** The band edge emission plot on the next second page shows 52.50dBc between carrier maximum power and local maximum emission in restrict band (2.4910GHz). The emission of carrier strength list in the test result of channel 11 at the item 4.2.7 is 107.08dBuV/m (Peak), so the maximum field strength in restrict band is  $107.08 - 52.50 = 54.58$ dBuV/m which is under 74dBuV/m limit.

The band edge emission plot on the next third page shows 62.26dBc between carrier maximum power and local maximum emission in restrict band (2.4835GHz). The emission of carrier strength list in the test result of channel 11 at the item 4.2.7 is 102.20dBuV/m (Peak), so the maximum field strength in restrict band is  $102.20 - 62.26 = 39.94$ dBuV/m which is under 54dBuV/m limit.

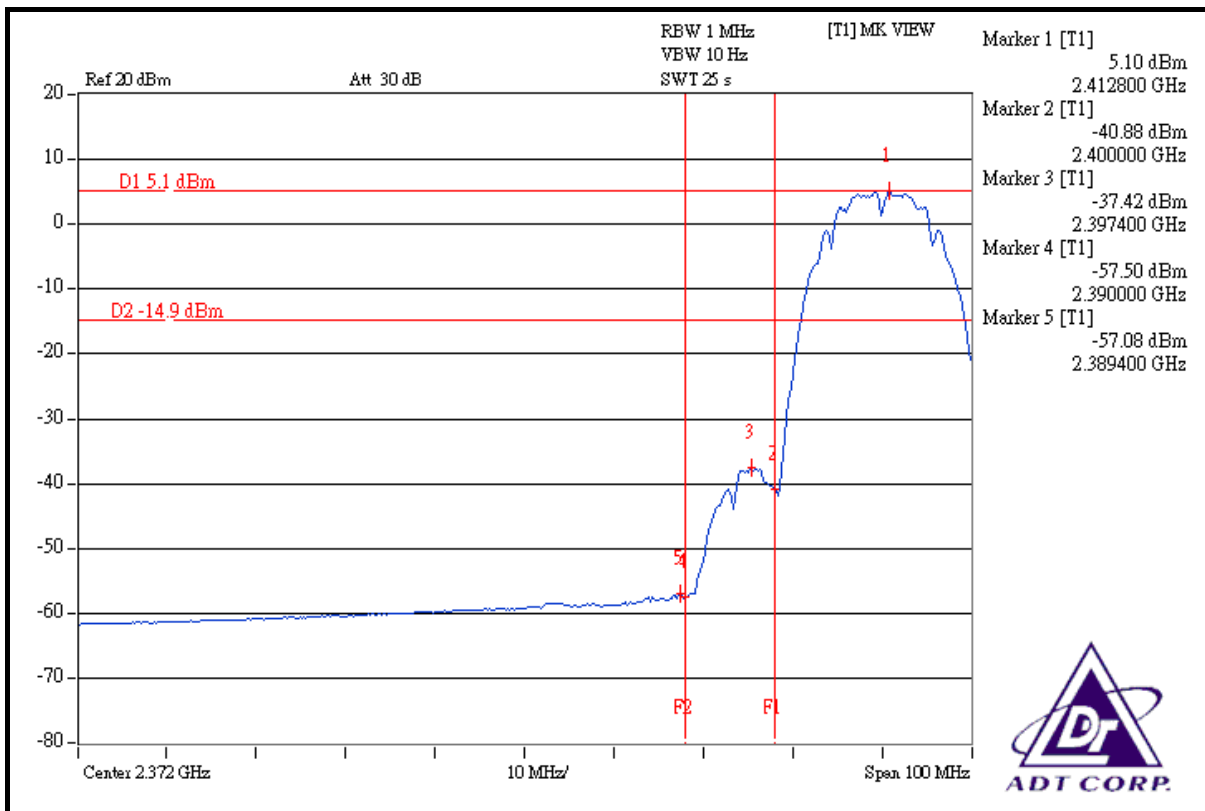
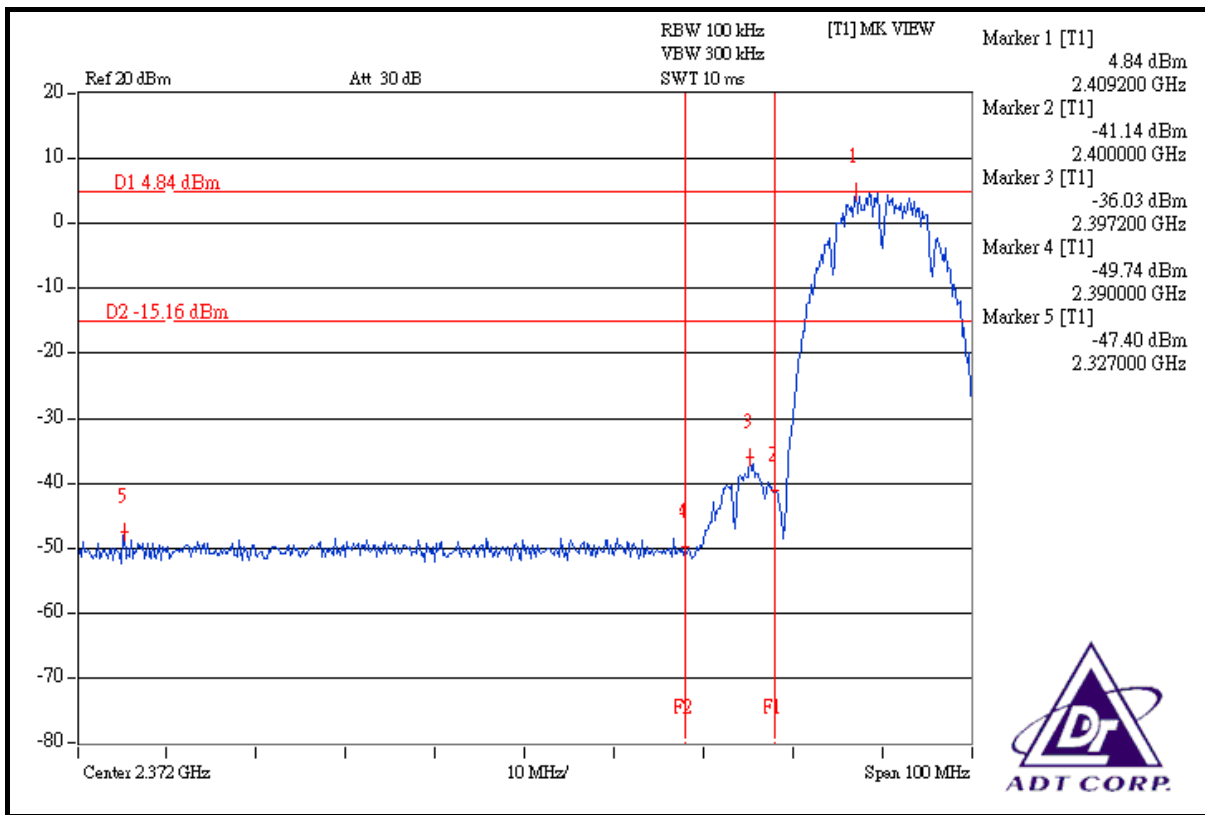

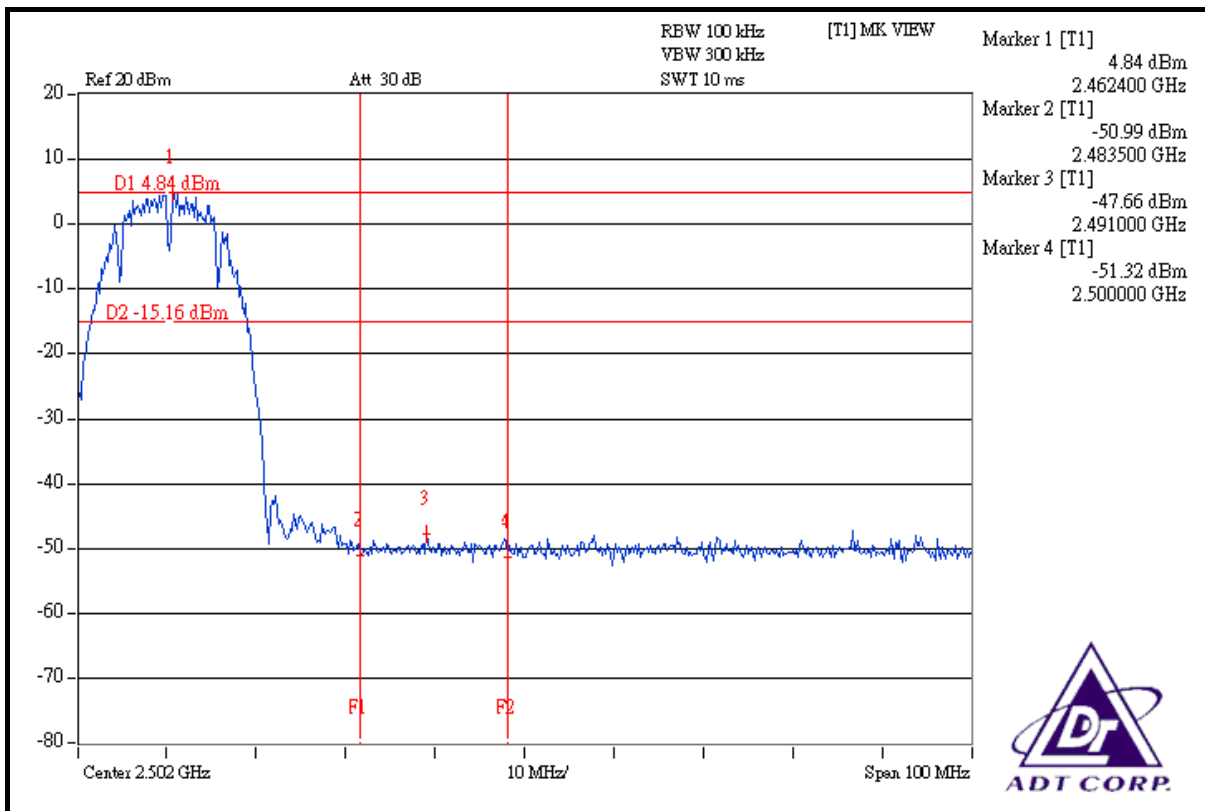
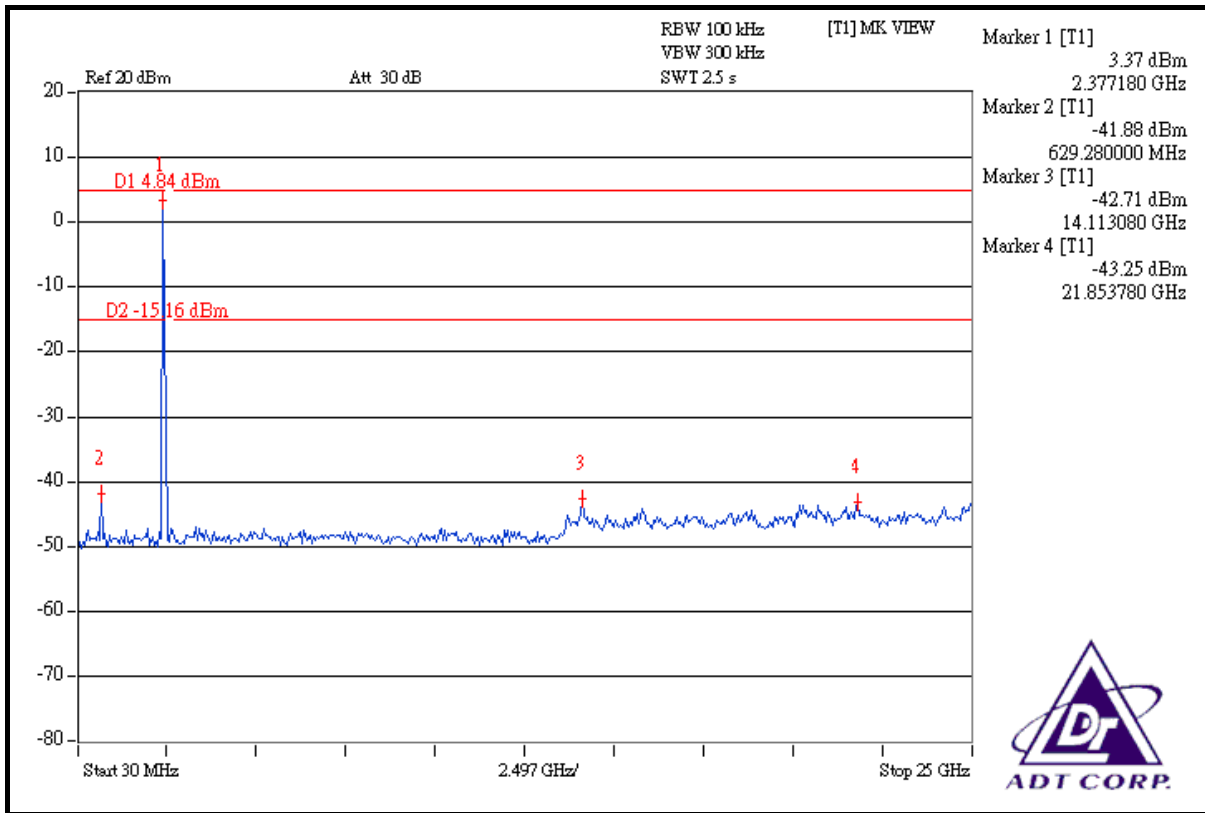

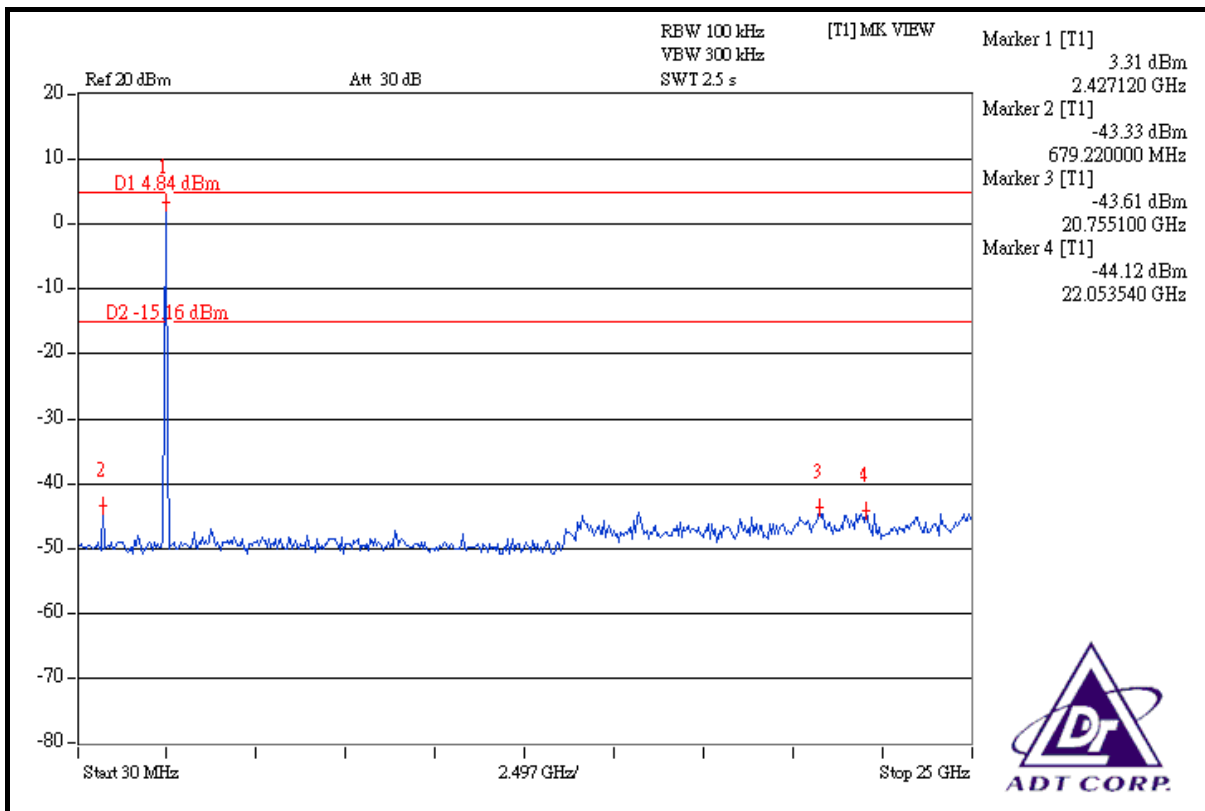
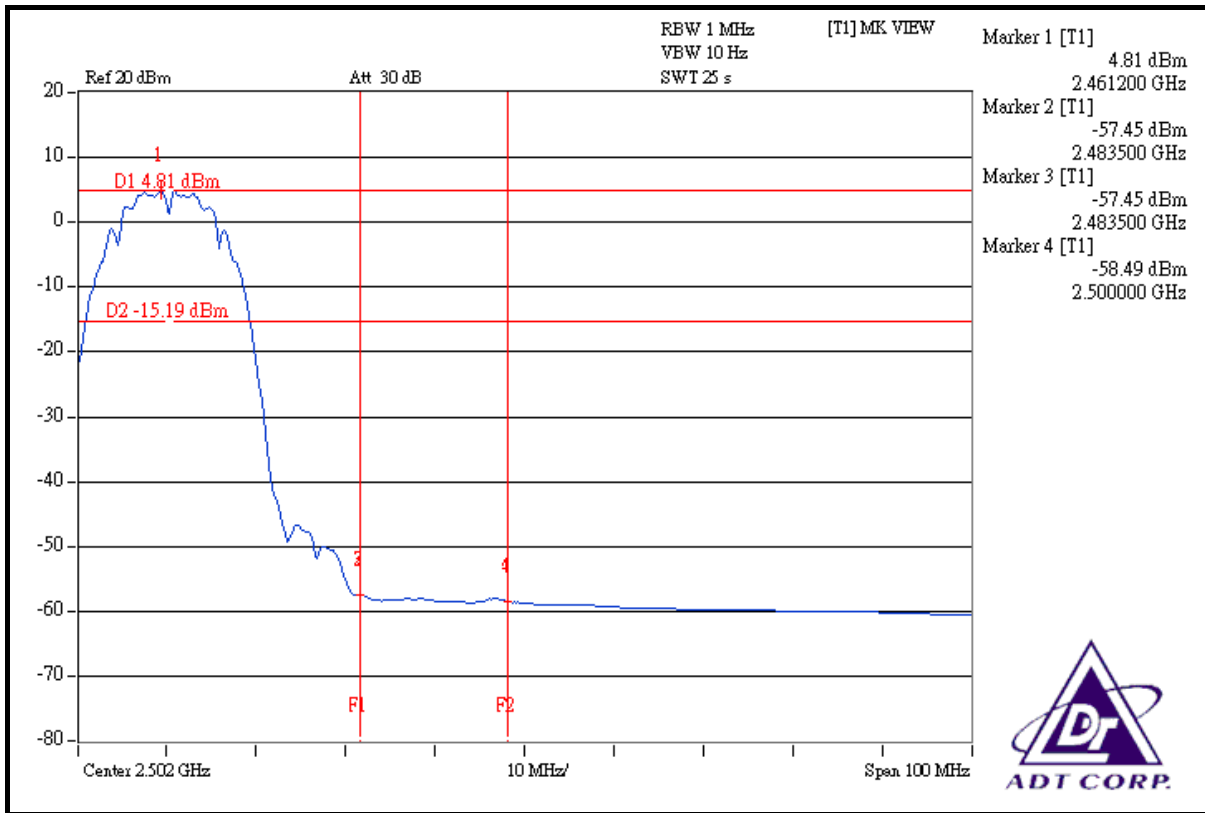

### 802.11g OFDM MODULATION

**NOTE 1:** The band edge emission plot on the next page shows 45.44dBc between carrier maximum power and local maximum emission in restrict band (2.3900GHz). The emission of carrier strength list in the test result of channel 1 at the item 4.2.7 is 108.89dBuV/m (Peak), so the maximum field strength in restrict band is  $108.89 - 45.44 = 63.45$ dBuV/m which is under 74dBuV/m limit.

The band edge emission plot on the next page shows 47.65dBc between carrier maximum power and local maximum emission in restrict band (2.3900GHz). The emission of carrier strength list in the test result of channel 1 at the item 4.2.7 is 98.59dBuV/m (Peak), so the maximum field strength in restrict band is  $98.59 - 47.65 = 50.94$ dBuV/m which is under 54dBuV/m limit.

**NOTE 2:** The band edge emission plot on the next second page shows 45.02dBc between carrier maximum power and local maximum emission in restrict band (2.4842GHz). The emission of carrier strength list in the test result of channel 11 at the item 4.2.7 is 110.10dBuV/m (Peak), so the maximum field strength in restrict band is  $110.10 - 45.02 = 65.08$ dBuV/m which is under 74dBuV/m limit.

The band edge emission plot on the next third page shows 47.59dBc between carrier maximum power and local maximum emission in restrict band (2.4836GHz). The emission of carrier strength list in the test result of channel 11 at the item 4.2.7 is 99.87dBuV/m (Peak), so the maximum field strength in restrict band is  $99.87 - 47.59 = 52.28$ dBuV/m which is under 54dBuV/m limit.

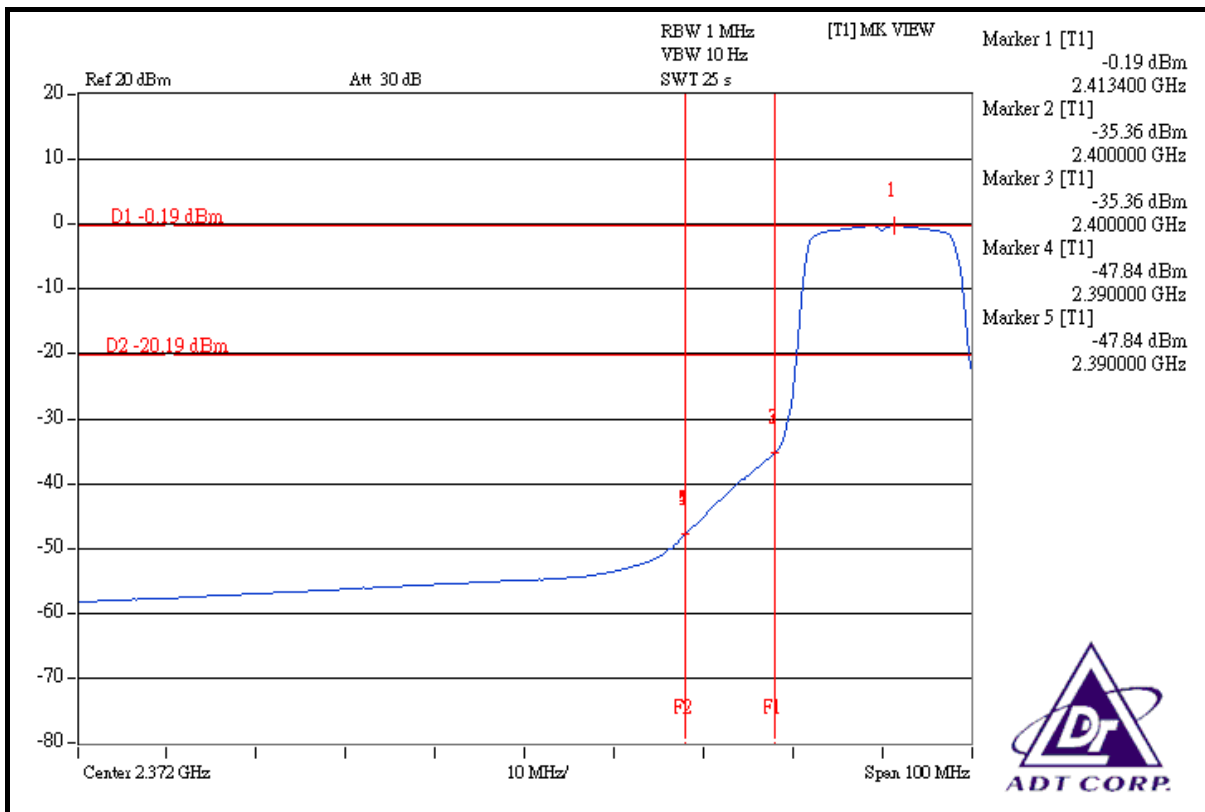
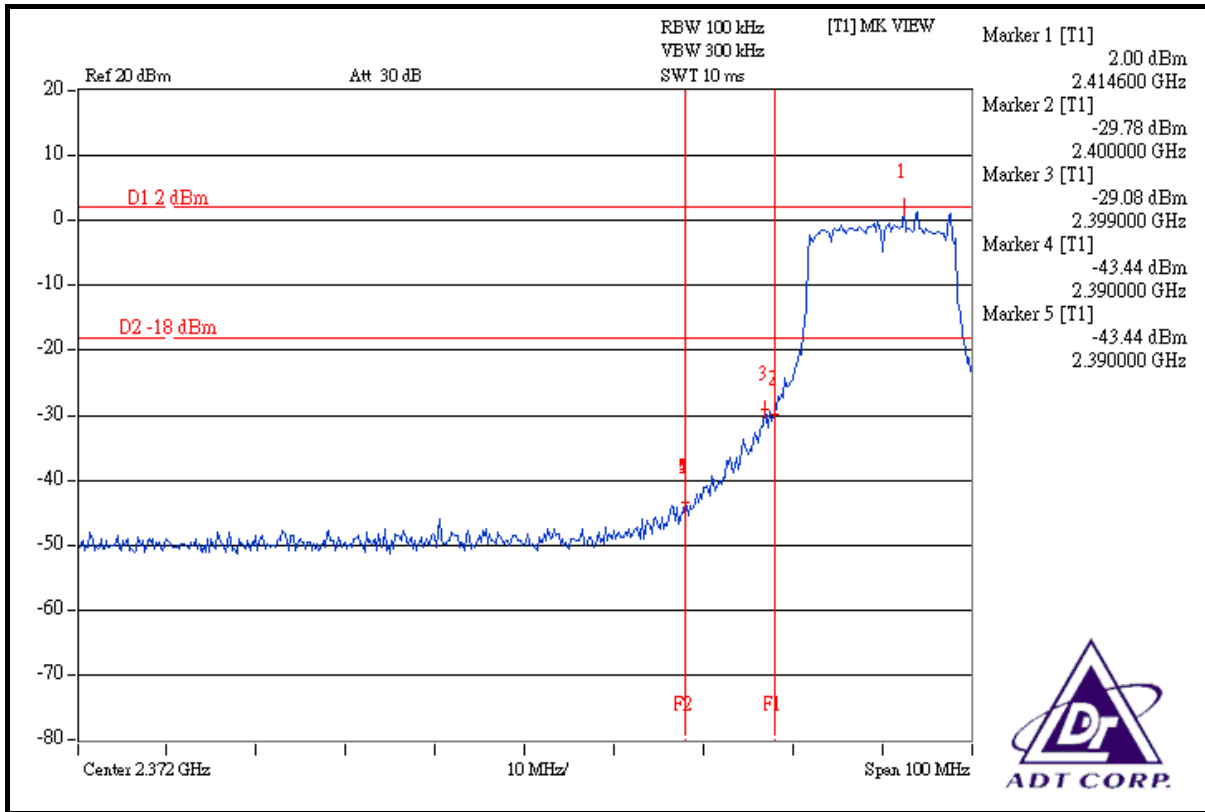



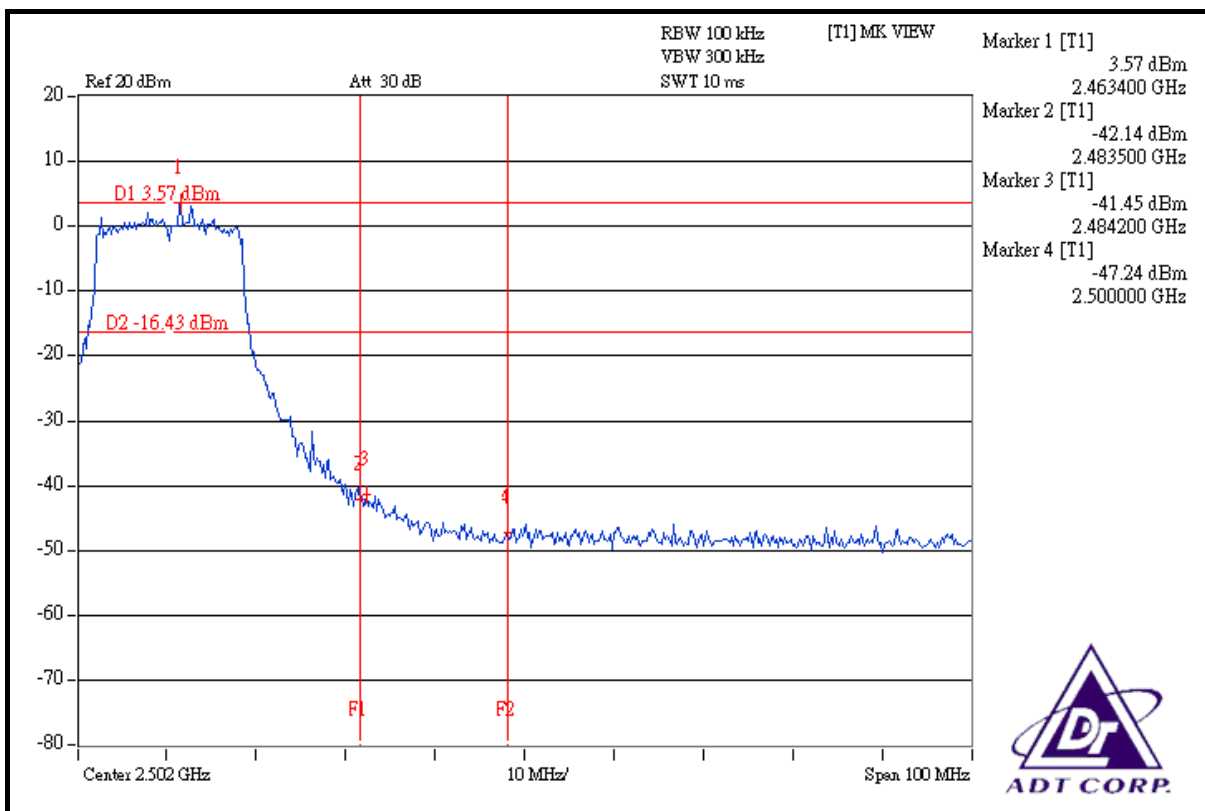
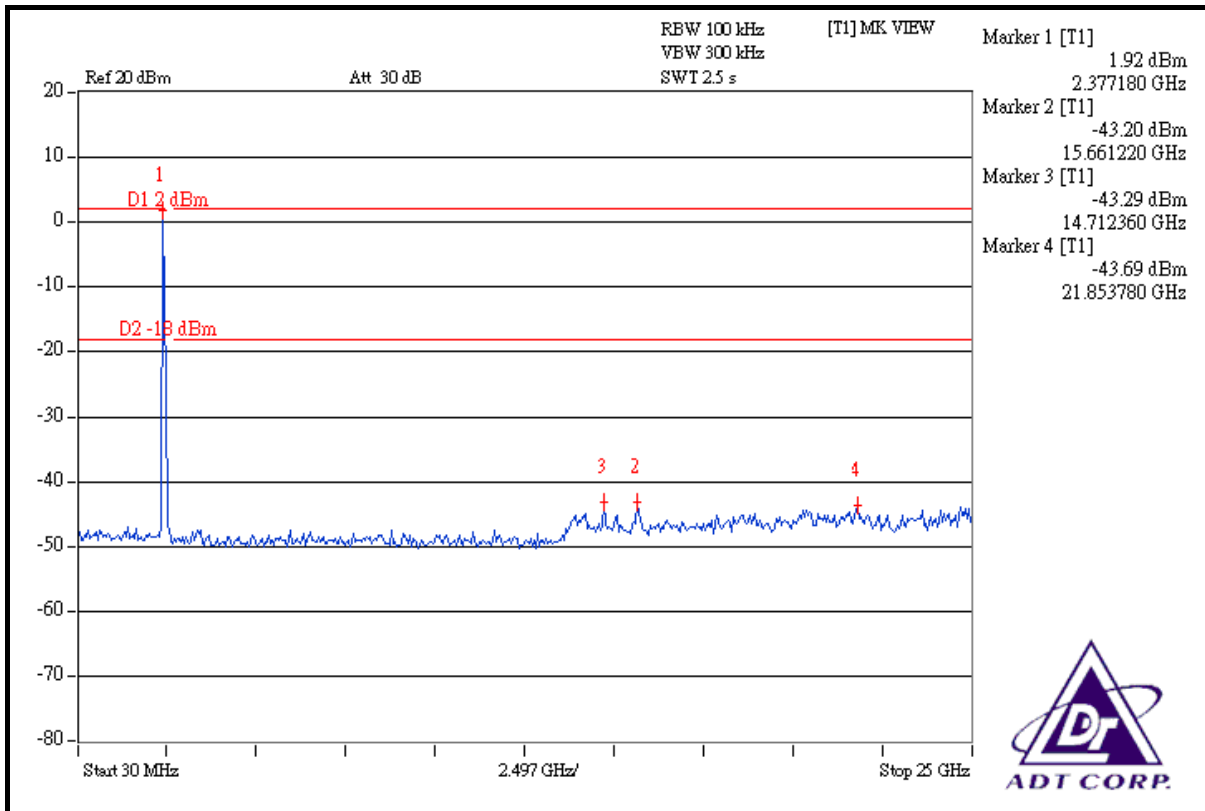

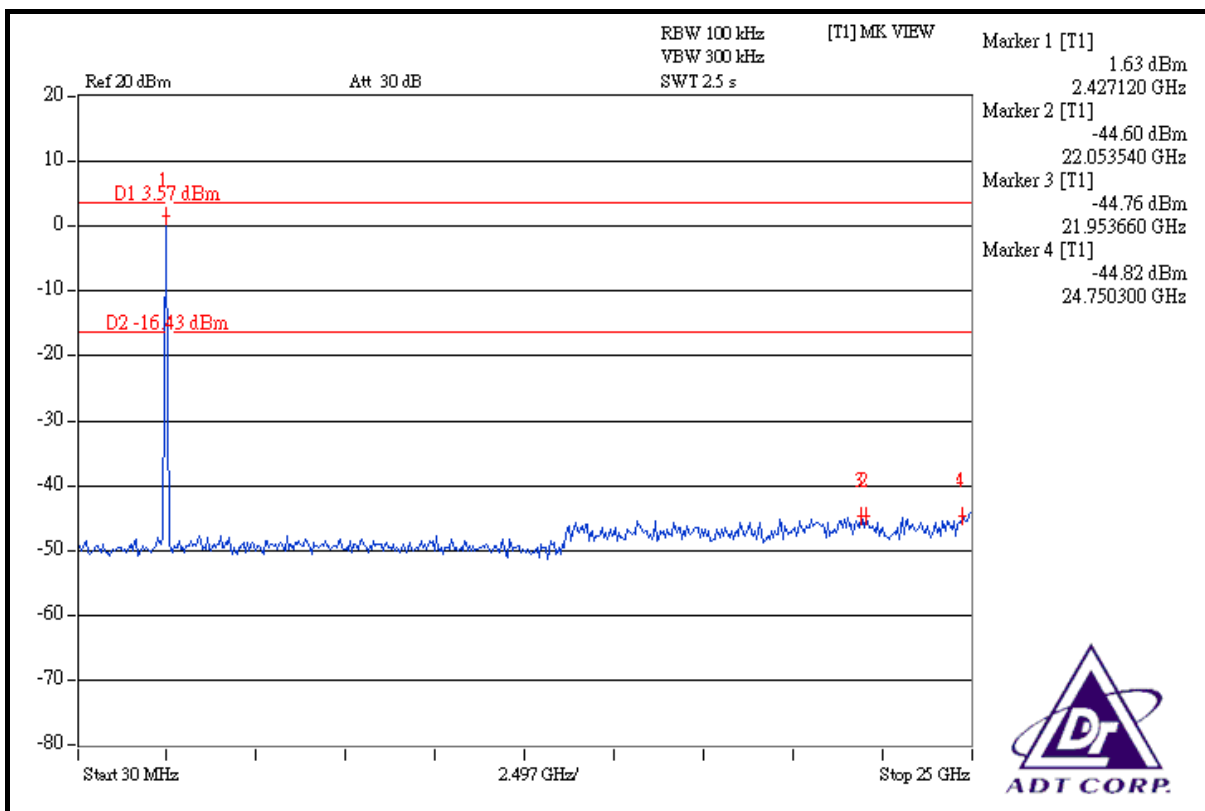
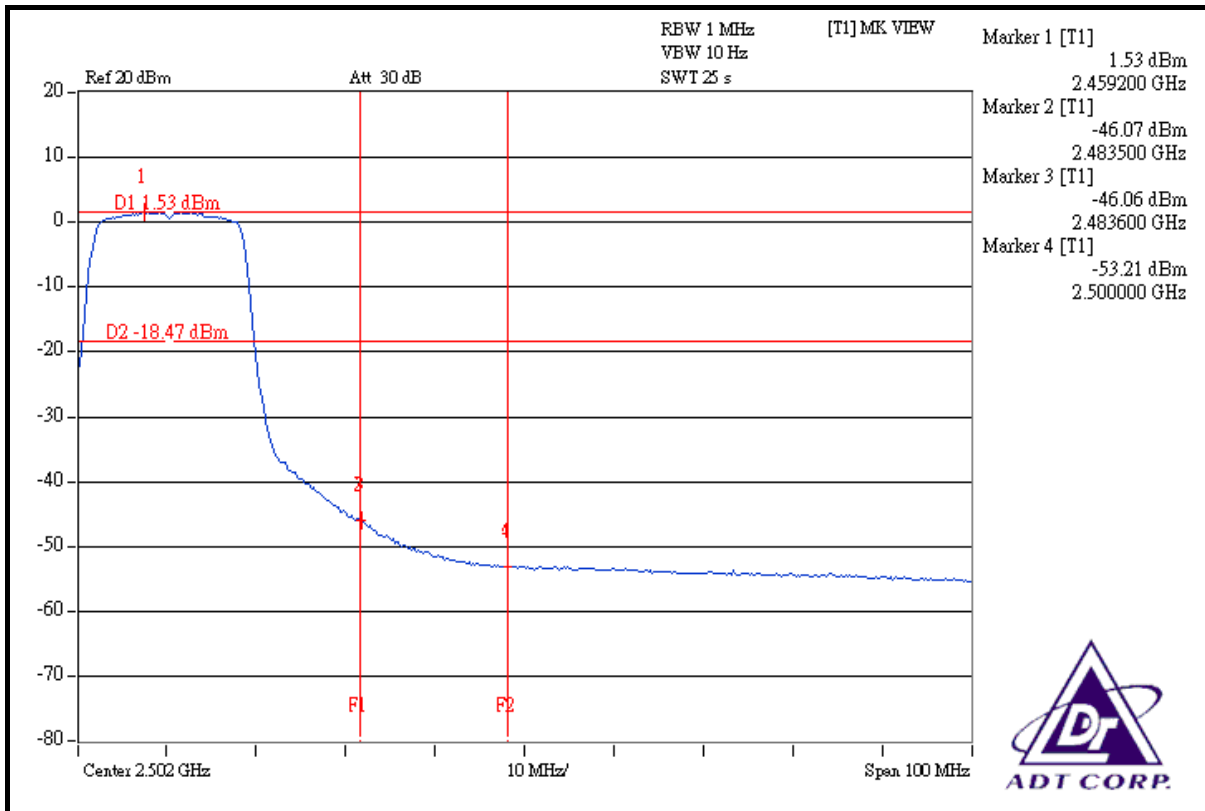

### DRAFT 802.11n (20MHz) OFDM MODULATION

**NOTE 1:** The band edge emission plot on the next page shows 44.47dBc between carrier maximum power and local maximum emission in restrict band (2.3890GHz). The emission of carrier strength list in the test result of channel 1 at the item 4.2.7 is 111.93dBuV/m (Peak), so the maximum field strength in restrict band is  $111.93 - 44.47 = 67.46$ dBuV/m which is under 74dBuV/m limit.

The band edge emission plot on the next page shows 51.37dBc between carrier maximum power and local maximum emission in restrict band (2.3892GHz). The emission of carrier strength list in the test result of channel 1 at the item 4.2.7 is 102.01dBuV/m (Peak), so the maximum field strength in restrict band is  $102.01 - 51.37 = 50.64$ dBuV/m which is under 54dBuV/m limit.

**NOTE 2:** The band edge emission plot on the next second page shows 49.37dBc between carrier maximum power and local maximum emission in restrict band (2.4838GHz). The emission of carrier strength list in the test result of channel 11 at the item 4.2.7 is 112.75dBuV/m (Peak), so the maximum field strength in restrict band is  $112.75 - 49.37 = 63.38$ dBuV/m which is under 74dBuV/m limit.

The band edge emission plot on the next third page shows 51.25dBc between carrier maximum power and local maximum emission in restrict band (2.4835GHz). The emission of carrier strength list in the test result of channel 11 at the item 4.2.7 is 102.10dBuV/m (Peak), so the maximum field strength in restrict band is  $102.10 - 51.25 = 50.85$ dBuV/m which is under 54dBuV/m limit.

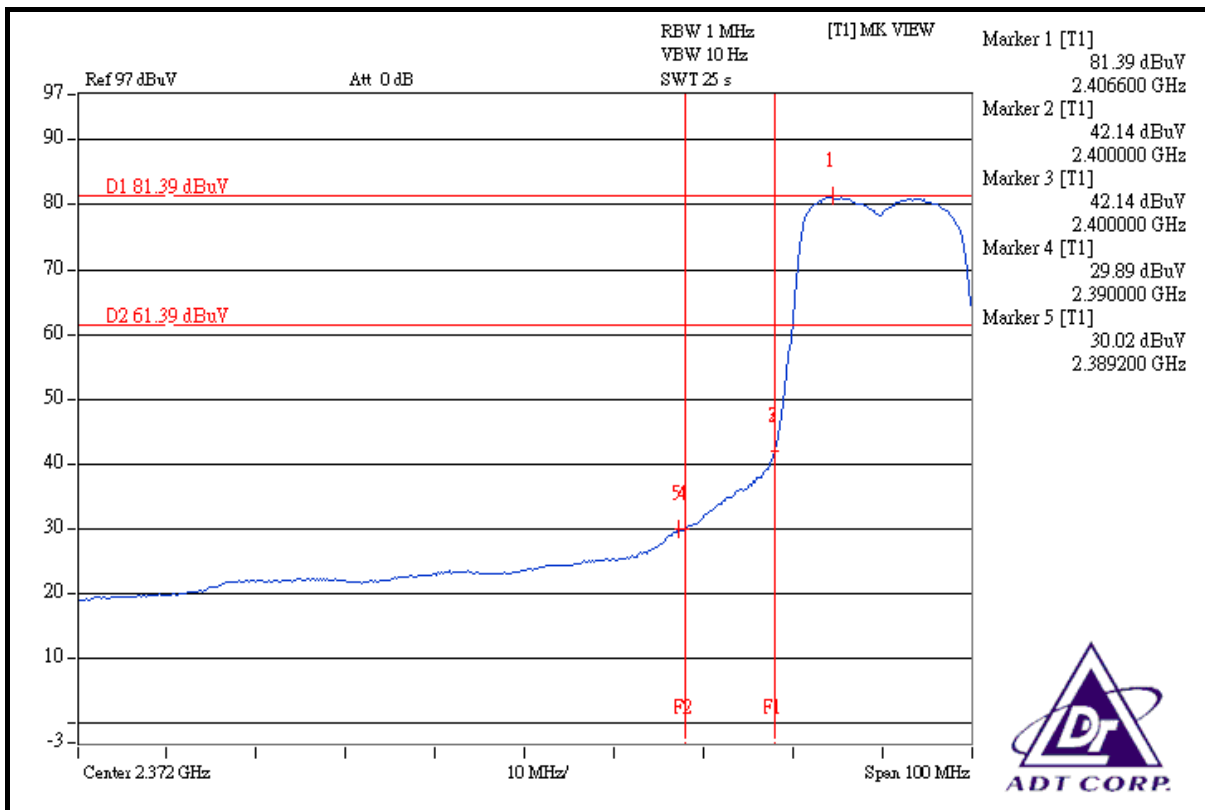
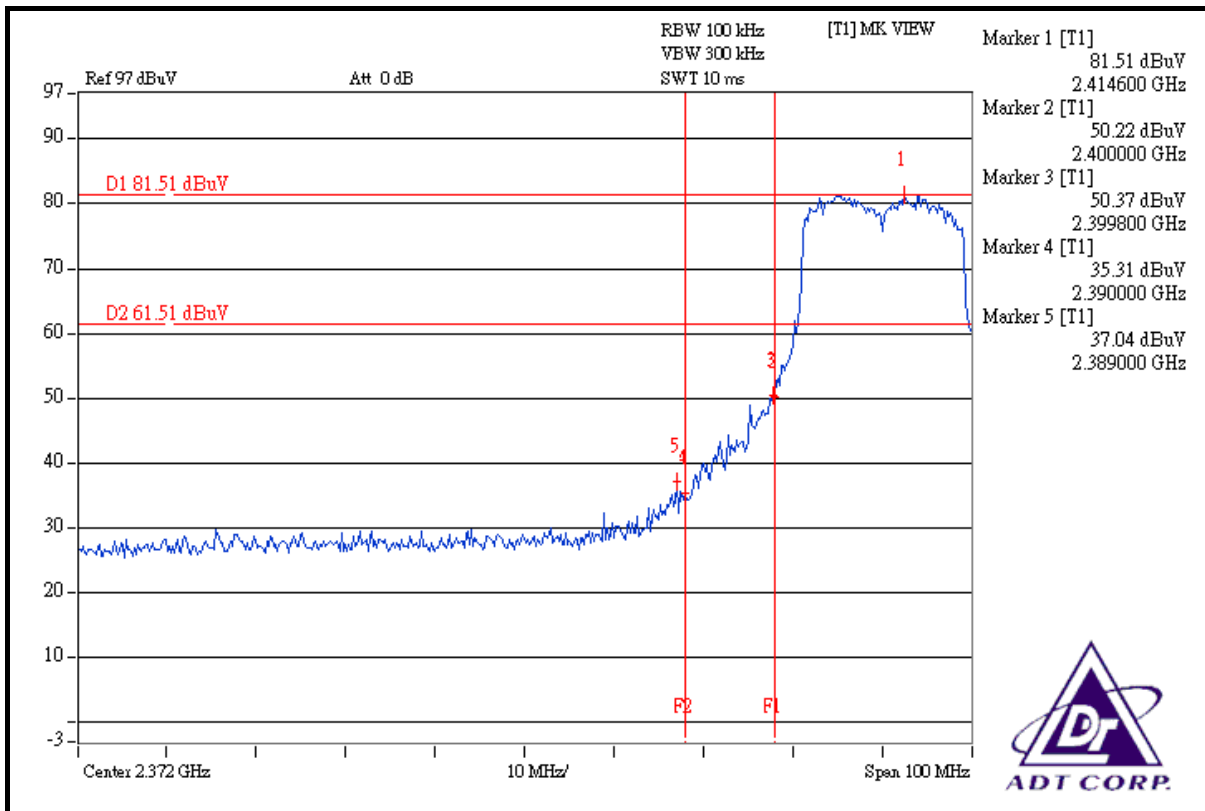

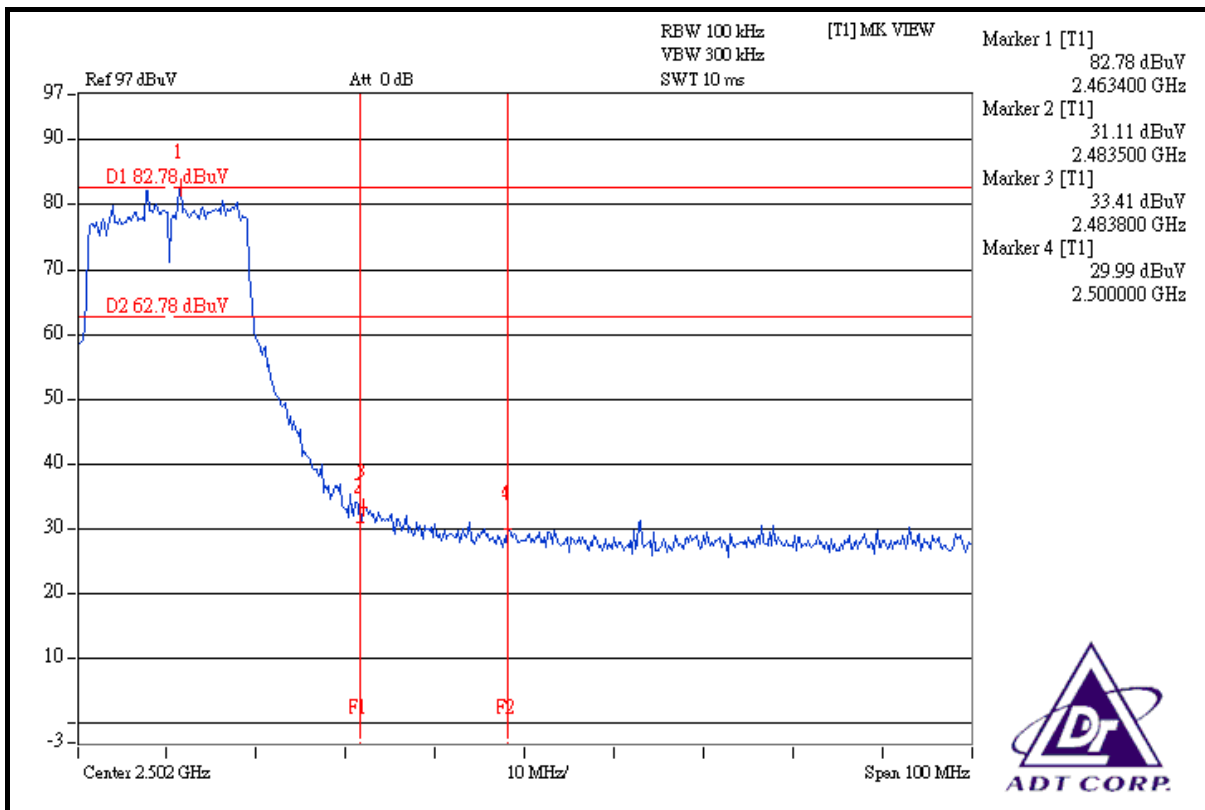
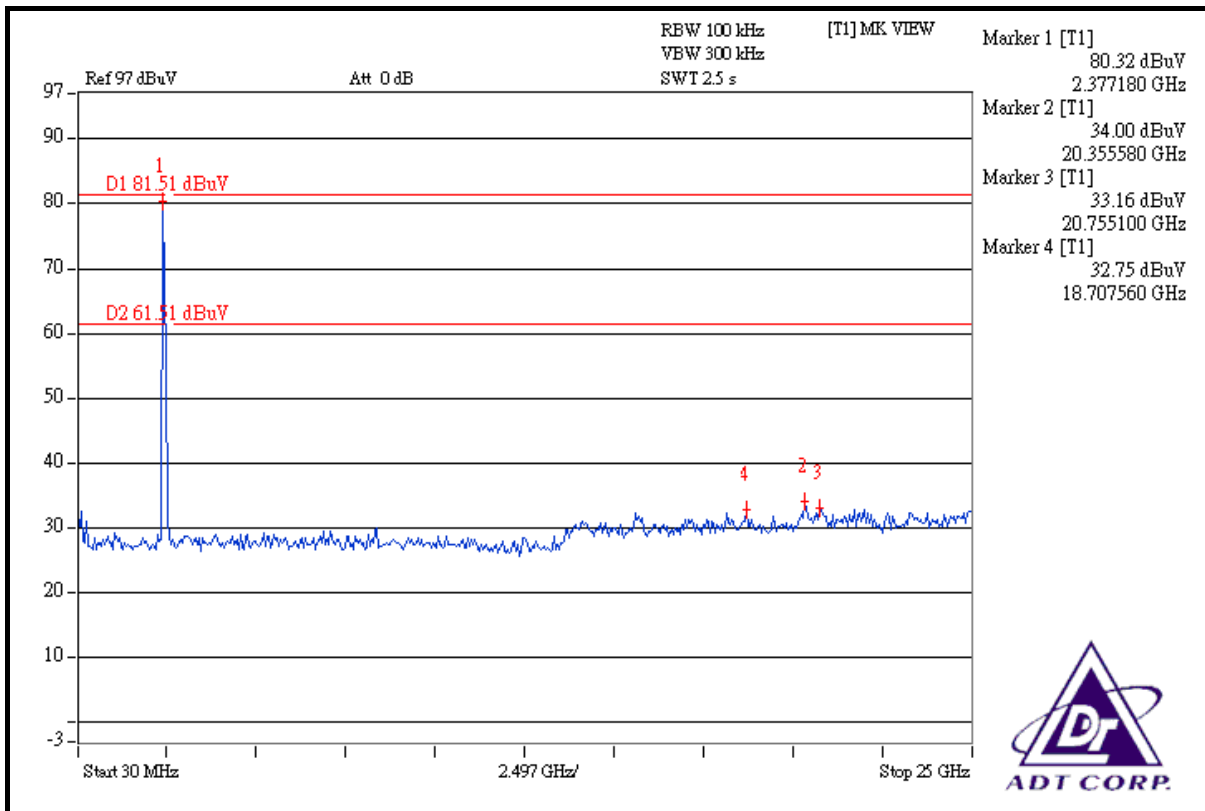

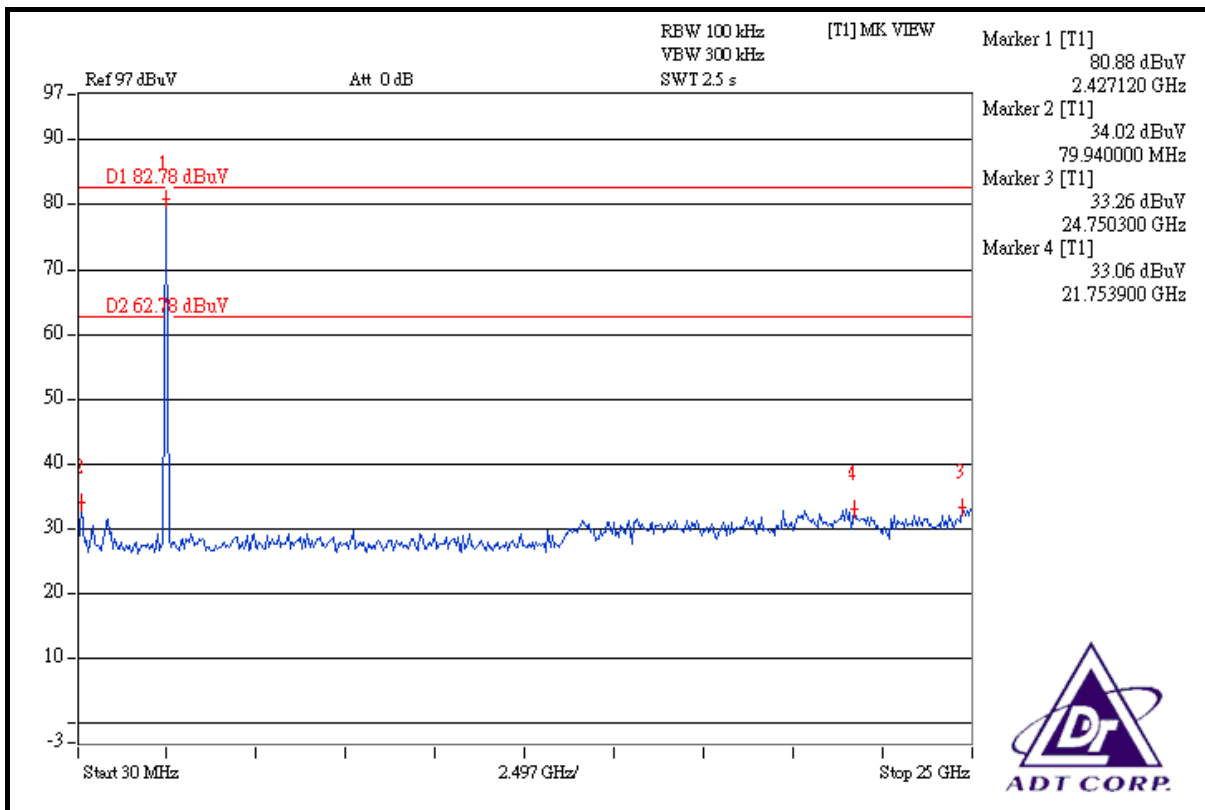
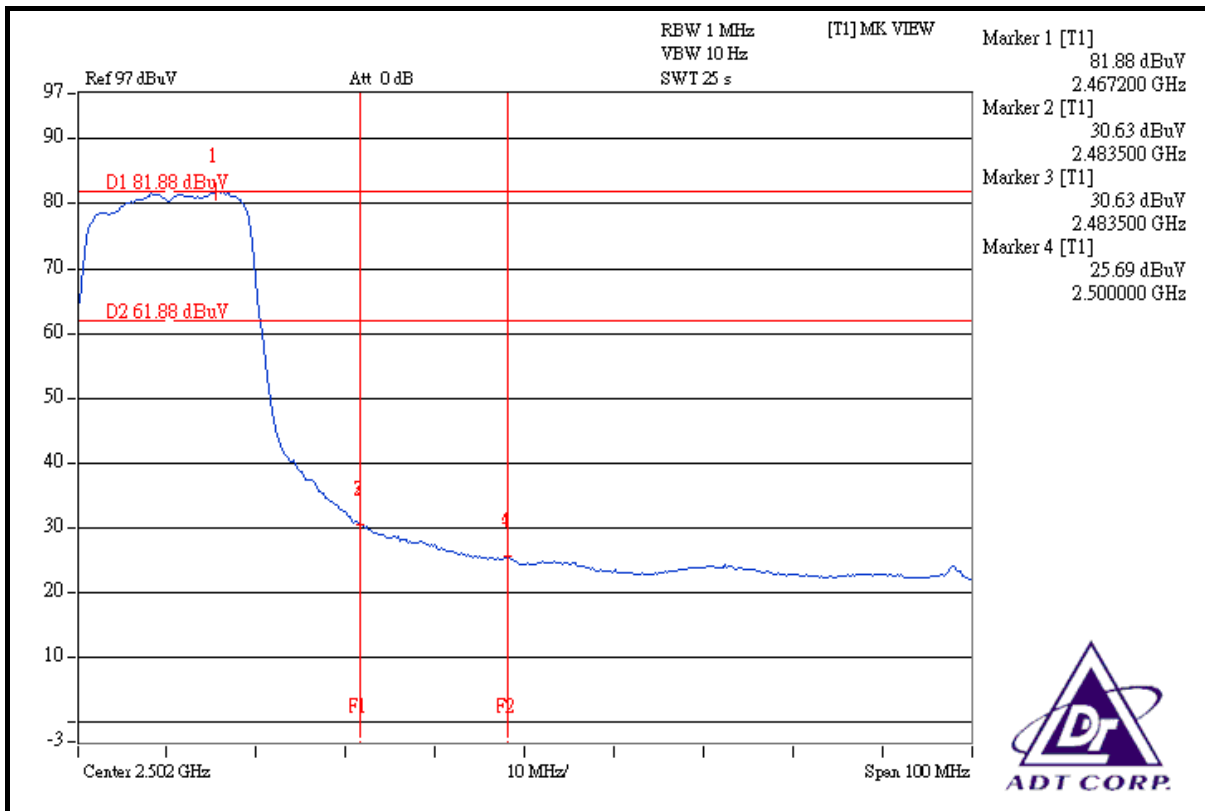

### DRAFT 802.11n (40MHz) OFDM MODULATION

**NOTE 1:** The band edge emission plot on the next page shows 43.74dBc between carrier maximum power and local maximum emission in restrict band (2.3884GHz). The emission of carrier strength list in the test result of channel 1 at the item 4.2.7 is 108.77dBuV/m (Peak), so the maximum field strength in restrict band is  $108.77 - 43.74 = 65.03$ dBuV/m which is under 74dBuV/m limit.

The band edge emission plot on the next page shows 45.55dBc between carrier maximum power and local maximum emission in restrict band (2.3900GHz). The emission of carrier strength list in the test result of channel 1 at the item 4.2.7 is 97.74dBuV/m (Peak), so the maximum field strength in restrict band is  $97.74 - 45.55 = 52.19$ dBuV/m which is under 54dBuV/m limit.

**NOTE 2:** The band edge emission plot on the next second page shows 43.90dBc between carrier maximum power and local maximum emission in restrict band (2.4870GHz). The emission of carrier strength list in the test result of channel 11 at the item 4.2.7 is 109.18dBuV/m (Peak), so the maximum field strength in restrict band is  $109.18 - 43.90 = 65.28$ dBuV/m which is under 74dBuV/m limit.

The band edge emission plot on the next third page shows 47.21dBc between carrier maximum power and local maximum emission in restrict band (2.4840GHz). The emission of carrier strength list in the test result of channel 11 at the item 4.2.7 is 99.11dBuV/m (Peak), so the maximum field strength in restrict band is  $99.11 - 47.21 = 51.90$ dBuV/m which is under 54dBuV/m limit.

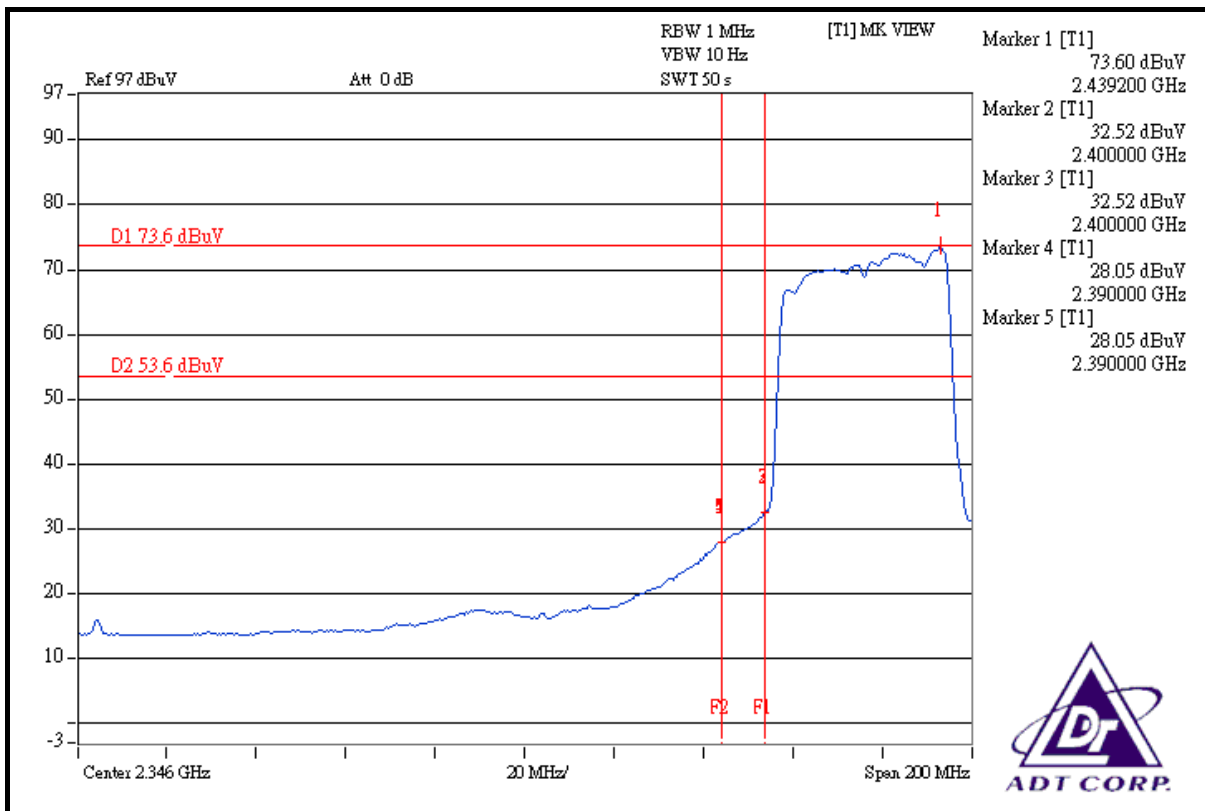
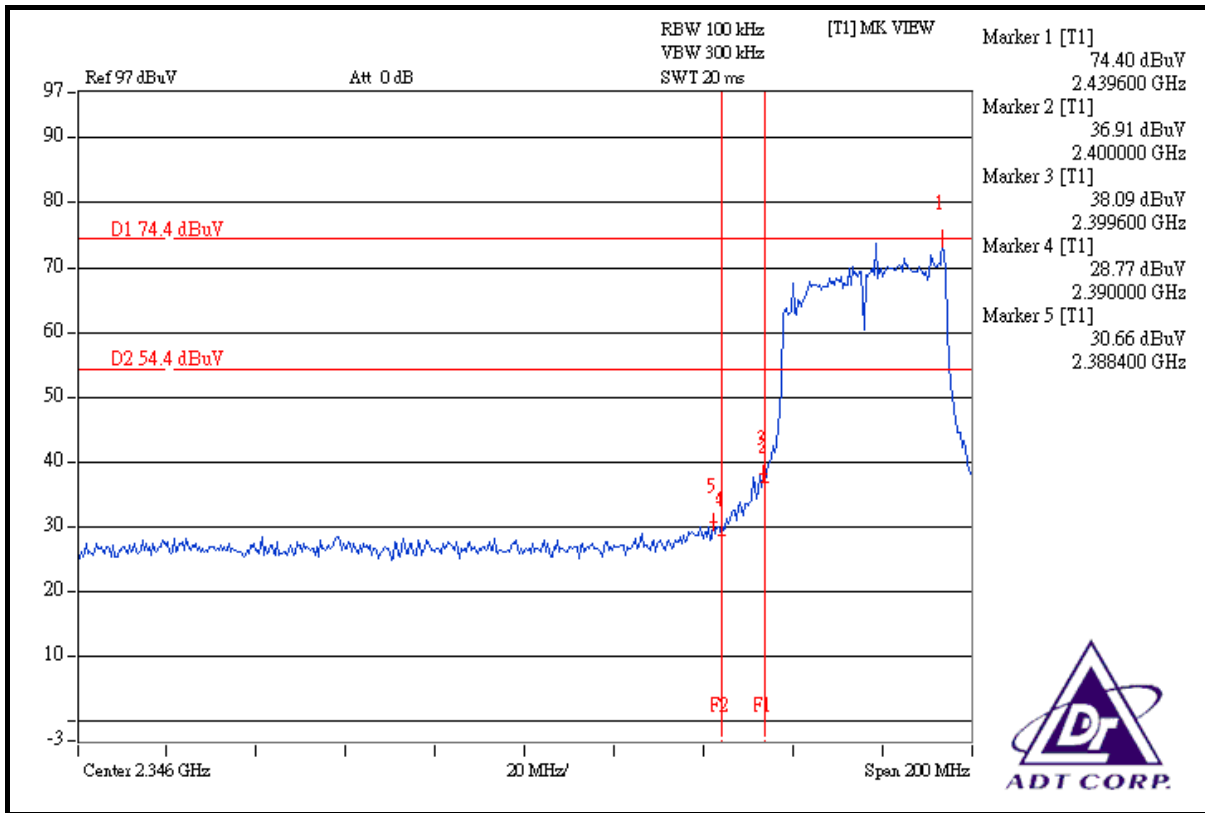



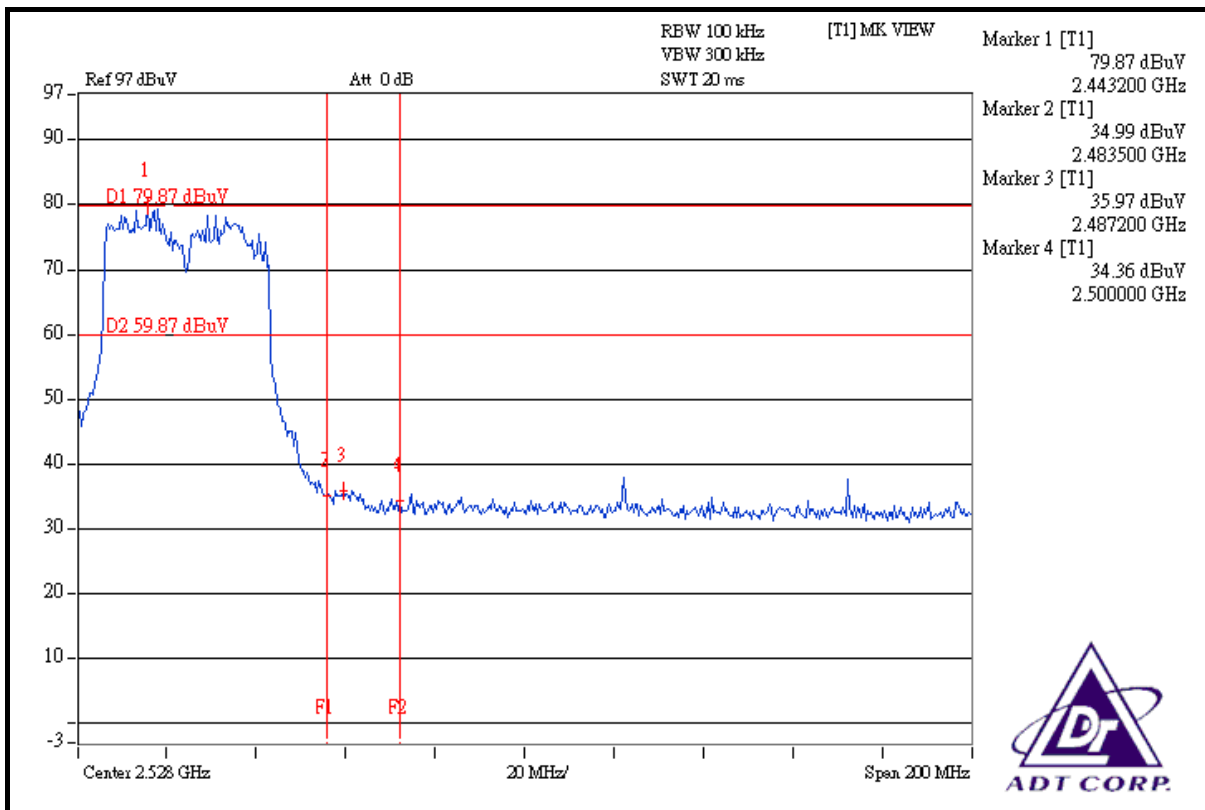
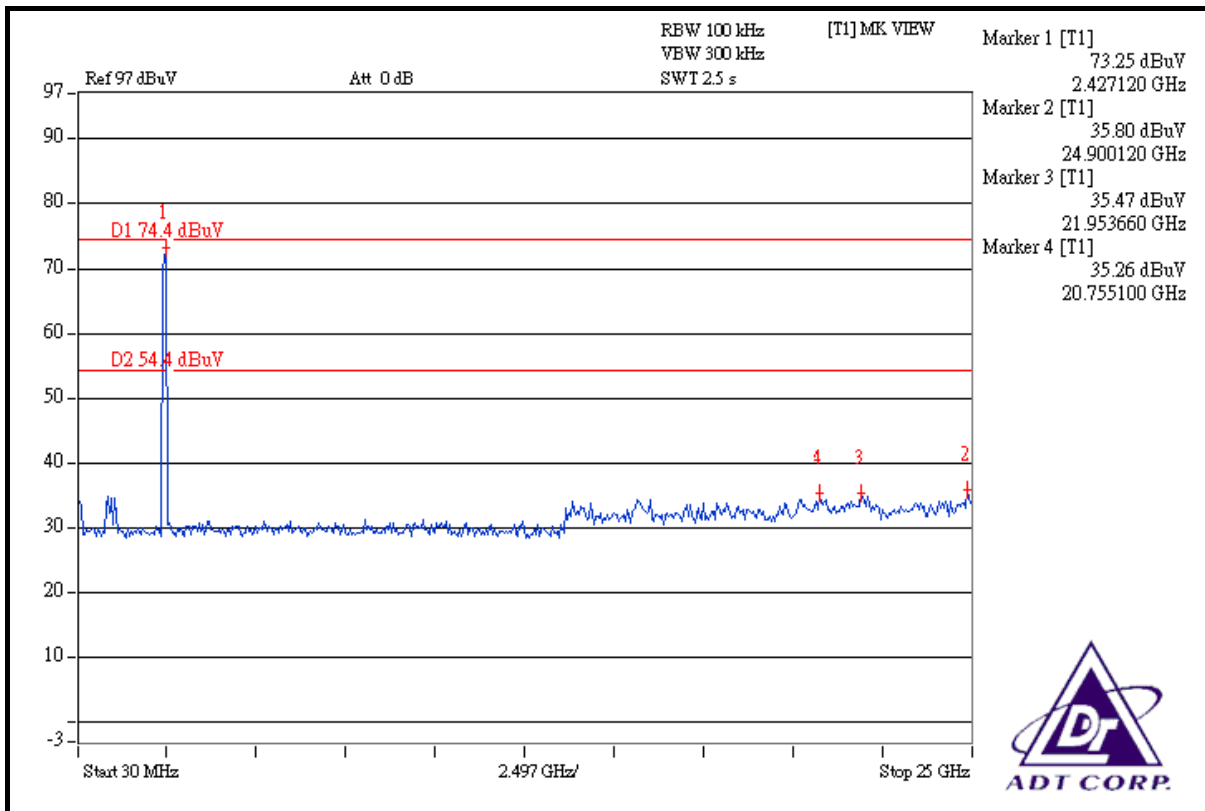

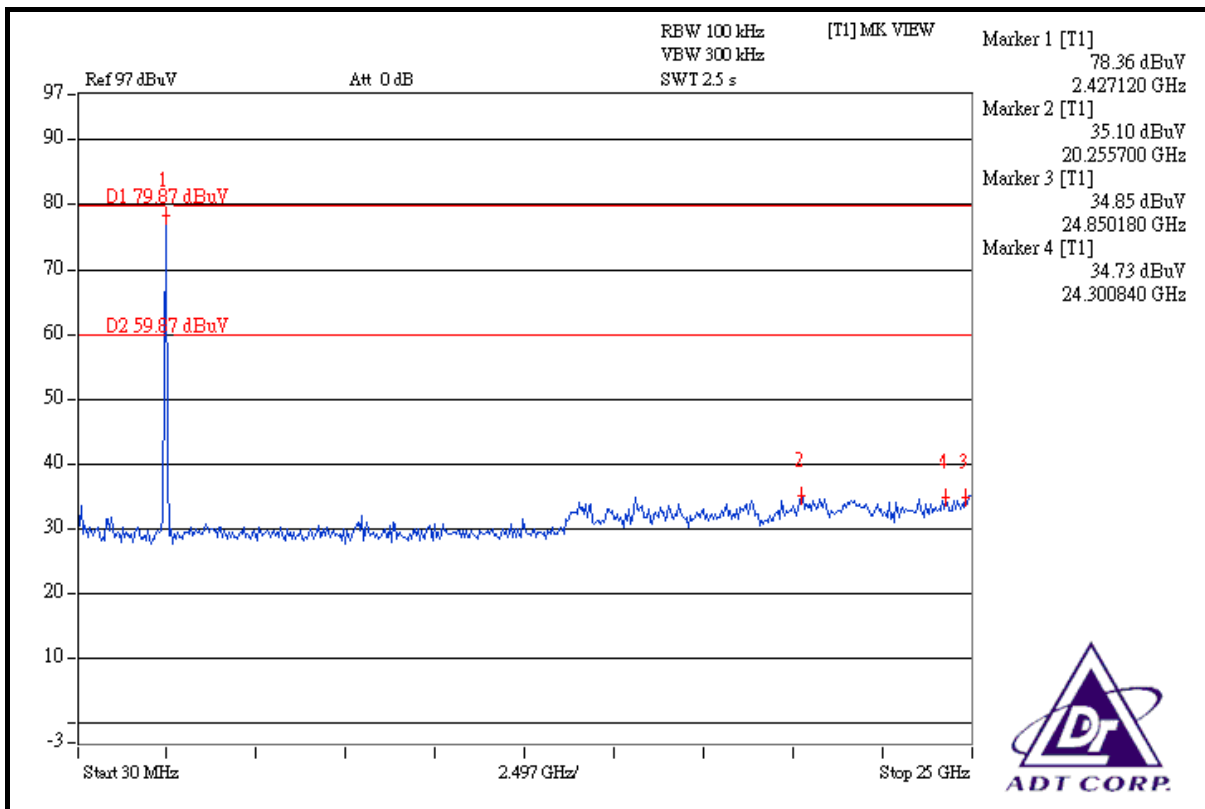
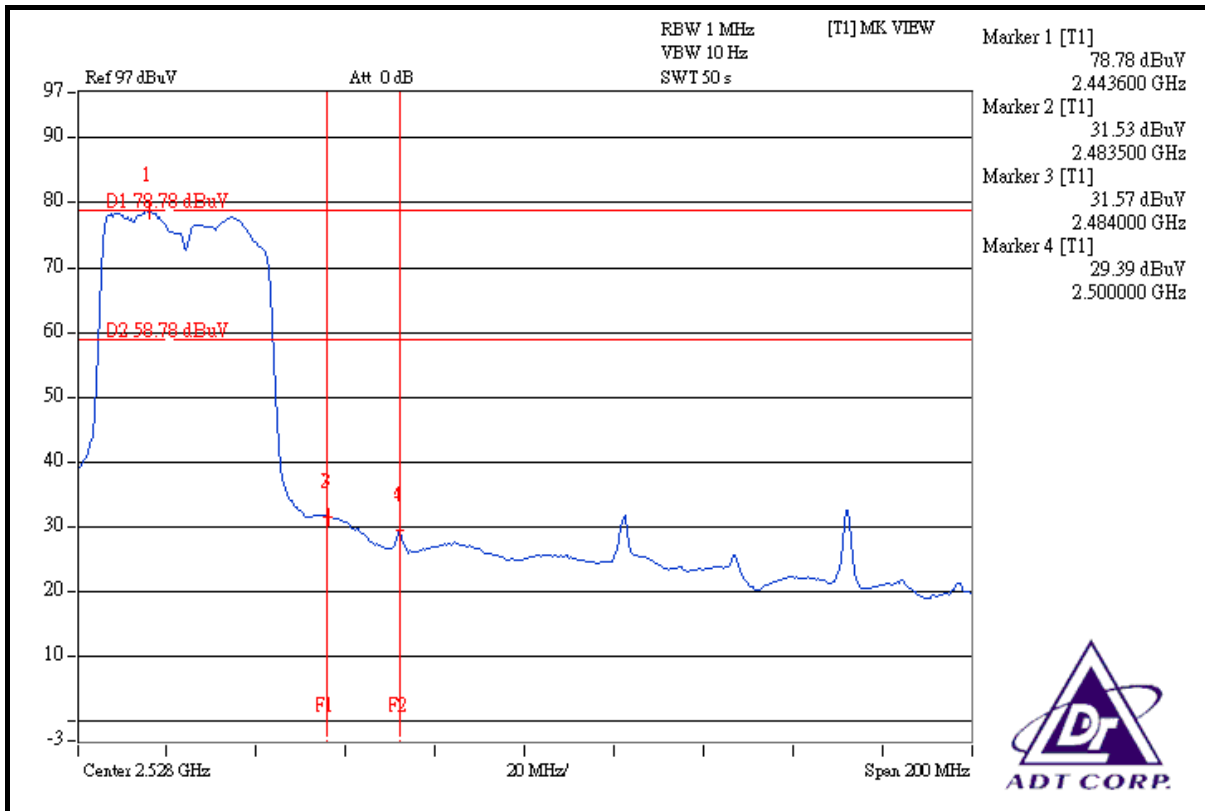



## **4.7 ANTENNA REQUIREMENT**

### **4.7.1 STANDARD APPLICABLE**

For intentional device, according to FCC 47 CFR Section 15.203, an intentional radiator shall be designed to ensure that no antenna other than that furnished by the responsible party shall be used with the device. And according to FCC 47 CFR Section 15.247 (b), if transmitting antennas of directional gain greater than 6dBi are used, the power shall be reduced by the amount in dB that the directional gain of the antenna exceeds 6dBi.

### **4.7.2 ANTENNA CONNECTED CONSTRUCTION**

The antenna used in this product is Dipole antenna with UFL antenna connector. The maximum Gain of the antenna is 3dBi.



## 5. PHOTOGRAPHS OF THE TEST CONFIGURATION

Please refer to the attached file (Test Setup Photo).



## 6. INFORMATION ON THE TESTING LABORATORIES

We, ADT Corp., were founded in 1988 to provide our best service in EMC, Radio, Telecom and Safety consultation. Our laboratories are accredited and approved by the following approval agencies according to ISO/IEC 17025.

<b>USA</b>	FCC, UL, A2LA
<b>Germany</b>	TUV Rheinland
<b>Japan</b>	VCCI
<b>Norway</b>	NEMKO
<b>Canada</b>	INDUSTRY CANADA , CSA
<b>R.O.C.</b>	TAF, BSMI, NCC
<b>Netherlands</b>	Telefication
<b>Singapore</b>	GOST-ASIA(MOU)
<b>Russia</b>	CERTIS(MOU)

Copies of accreditation certificates of our laboratories obtained from approval agencies can be downloaded from our web site:

[www.adt.com.tw/index.5/phtml](http://www.adt.com.tw/index.5/phtml). If you have any comments, please feel free to contact us at the following:

**Linko EMC/RF Lab:**

Tel: 886-2-26052180

Fax: 886-2-26051924

**Hsin Chu EMC/RF Lab:**

Tel: 886-3-5935343

Fax: 886-3-5935342

**Hwa Ya EMC/RF/Safety Telecom Lab:**

Tel: 886-3-3183232

Fax: 886-3-3185050

**Web Site:** [www.adt.com.tw](http://www.adt.com.tw)

The address and road map of all our labs can be found in our web site also.



## **7. APPENDIX A - MODIFICATIONS RECORDERS FOR ENGINEERING CHANGES TO THE EUT BY THE LAB**

No any modifications are made to the EUT by the lab during the test.