



## **EMI TEST REPORT**

JQA APPLICATION NO. : 400-40471

Model No. : CCA-1200U / GCA-1200U

Type of Equipment : Bluetooth module

Regulations Applied : CFR 47 FCC Rules and Regulations Part 15  
: Industry Canada RSS-210 Issue 5 (inc. Amendment)

FCC ID : SJ21200U  
IC : 5427A-1200U

Applicant : Xanavi Informatics Corporation

Address : 6-35 Hironodai 2-chome, Zama-shi,  
Kanagawa 228-0012 Japan

Manufacturer : Xanavi Informatics Corporation

Address : 6-35 Hironodai 2-chome, Zama-shi,  
Kanagawa 228-0012 Japan

Received date of EUT : August 30, 2004

**Final Judgment : Passed**

Test results in this report are obtained in use of equipment that is traceable to National Institute of Advanced Industrial Science and Technology (AIST) of Japan and National Institute of Information and Communications Technology (NICT) of Japan.

The test results only respond to the tested sample. This report should not be reproduced except in full, without the written approval of JQA EMC Engineering Dept. Testing Div.

## TABLE OF CONTENTS

	Page
<b>1 Documentation</b>	
1.1 Test Regulation	<u>4</u>
1.2 General Information	<u>4</u>
1.3 Test Condition	<u>5 - 11</u>
1.4 EUT Modifications / Deviation from Standard	<u>12</u>
1.5 Test results	<u>13 - 14</u>
1.6 Summary	<u>15</u>
1.7 Test Configuration / Operation of EUT	<u>16</u>
1.8 EUT Arrangement (Drawing)	<u>17 - 18</u>
1.9 Preliminary Test and Test-setup (Drawings)	<u>19 - 27</u>
1.10 EUT Arrangement (Photographs)	<u>28 - 29</u>

## 2 Test Data

2.1 Channel Separation	<u>30</u>
2.2 Minimum Hopping Channel	<u>31 - 32</u>
2.3 Occupied Bandwidth	<u>33 - 35</u>
2.4 Average Time of Occupancy	<u>36 - 38</u>
2.5 Peak Output Power (Conduction)	<u>39</u>
2.6 Peak Output Power (Radiation)	<u>40</u>
2.7 Peak Power Density (Conduction)	<u>41 - 43</u>
2.8 Peak Power Density (Radiation)	<u>N/A</u>
2.9 Spurious Emissions (Conduction)	<u>44 - 46</u>
2.10 Spurious Emissions (Radiation)	<u>47 - 52</u>
2.11 AC Power Line Conducted Emissions	<u>N/A</u>
2.12 RF Exposure Compliance	<u>53</u>
2.13 Spurious Emissions for Receiver (Radiation)	<u>54 - 55</u>
2.14 AC Power Line Conducted Emissions for Receiver	<u>N/A</u>

## 3 Appendix

Test instruments List	<u>56 - 59</u>
-----------------------	----------------

---

**1 DOCUMENTATION****1.1 TEST REGULATION**

FCC Rules and Regulations Part 15 Subpart B and C Radiated Spurious Emissions and Industry Canada IC RSS-210 (inc. amendment)

**Test procedure :**

The tests were performed with reference to the FCC Public Notice DA 00-705, released March 30, 2000. The test set-up was made in accordance to the general provisions of ANSIC63.4-2003.

**1.2 GENERAL INFORMATION****1.2.1 Test facility :**

- 1) Test Facility located at EMC Engineering Dept. Testing Div. :
  - No.2 and 3 Anechoic Chambers(3 meters Site).
  - Shielded Enclosure.Expiration date of FCC test facility filing : May 27, 2005

Open Area Test Site Industry Canada No.: IC4126-4

- 2) EMC Engineering Dept. Testing Div. is recognized under the National Voluntary Laboratory accreditation Program for satisfactory compliance established in title 15, Part 285 Code of Federal Regulations.

NVLAP Lab Code : 200189-0 (Effective through : June 30, 2005)

**1.2.2 Description of the Equipment Under Test (EUT) :**

- |                                      |                                     |
|--------------------------------------|-------------------------------------|
| 1) Type of Equipment                 | : Bluetooth module                  |
| 2) Product Type                      | : Production                        |
| 3) Category                          | : Spread Spectrum Transmitter(FHSS) |
| 4) EUT Authorization                 | : Certification                     |
| 5) FCC ID                            | : SJ21200U                          |
| IC                                   | : 5427A-1200U                       |
| 6) Trade Name                        | : Xanavi Informatics Corporation    |
| 7) Model No.                         | : CCA-1200U / GCA-1200U             |
| 8) Operating Frequency Range         | : 2402 MHz - 2480 MHz               |
| 9) Highest Frequency Used in the EUT | : 2480 MHz                          |
| 10) RF Output Power                  | : 0.74 mW (measured value)          |
| 11) Serial No.                       | : None                              |
| 12) Date of Manufacture              | : -                                 |
| 13) Power Rating                     | : DC 3.3V via main unit             |
| 14) EUT Grounding                    | : None                              |

**1.2.3 Definitions for symbols used in this test report :**

- x** - indicates that the listed condition, standard or equipment is applicable for this report.
- indicates that the listed condition, standard or equipment is not applicable for this report.

---

### 1.3 TEST CONDITION

#### 1.3.1 The measurement of Channel Separation

  x   - was performed.

     - was not applicable.

##### Used test instruments :

Type	Number of test instruments (Refer to Appendix)
Test Receiver	TR07
Spectrum Analyzer	N/A
Cable	CA11
Attenuator	AU18
Antenna	N/A

#### 1.3.2 The measurement of Minimum Hopping Channel

  x   - was performed.

     - was not applicable.

##### Used test instruments :

Type	Number of test instruments (Refer to Appendix)
Test Receiver	TR07
Spectrum Analyzer	N/A
Cable	CA11
Attenuator	AU18
Antenna	N/A

#### 1.3.3 The measurement of Occupied Bandwidth

  x   - was performed.

     - was not applicable.

##### Used test instruments :

Type	Number of test instruments (Refer to Appendix)
Test Receiver	TR07
Spectrum Analyzer	N/A
Cable	CA11
Attenuator	AU18
Antenna	N/A

**1.3.4 The measurement of Average Time of Occupancy**

  x   - was performed.

     - was not applicable.

**Used test instruments :**

<b>Type</b>	<b>Number of test instruments (Refer to Appendix)</b>
Test Receiver	TR07
Spectrum Analyzer	N/A
Cable	CA11
Attenuator	AU18
Antenna	N/A

**1.3.5 The measurement of Peak Output Power and Density (Conduction)**

  x   - was performed.

     - was not applicable.

**Used test instruments :**

<b>Type</b>	<b>Number of test instruments (Refer to Appendix)</b>
Test Receiver	TR07
Spectrum Analyzer	N/A
Cable	CA11
Attenuator	AU18
Antenna	N/A
Power Meter	AU03
Power Sensor	AU04
Signal Generator	SG03

**1.3.6 The measurement of Peak Output Power and Density (Radiation)**

  x   - was performed in the following test site.

       - was not applicable.

**Test location :**

Safety & EMC Center EMC Engineering Dept. Testing Div.  
21-25, Kinuta 1-chome, Setagaya-ku, Tokyo 157-8573, Japan

  x   - No. 2 site (3 meters)

       - No. 3 site (3 meters)

**Validation of Site Attenuation :**

1) Last Confirmed Date : N/A

2) Interval : N/A

**Used test instruments :**

<b>Type</b>	<b>Number of test instruments (Refer to Appendix)</b>
Test Receiver	TR07
Spectrum Analyzer	N/A
Cable	CA12, CA13
Attenuator	N/A
Antenna	AN10, AN11
Power Meter	AU03
Power Sensor	AU04
Signal Generator	SG03

**1.3.7 The measurement of Spurious Emissions (Conduction)**

  x   - was performed.

       - was not applicable.

**Used test instruments :**

Type	Number of test instruments (Refer to Appendix)
Test Receiver	TR07
Spectrum Analyzer	N/A
Cable	CA11
Attenuator	N/A

**1.3.8 The measurement of Spurious Emissions (Radiation)(9 kHz - 30 MHz)**

  x   - was performed in the following test site.

       - was not applicable.

**Test location :**

Safety & EMC Center EMC Engineering Dept. Testing Div.  
21-25, Kinuta 1-chome, Setagaya-ku, Tokyo 157-8573, Japan

  x   - Anechoic Chamber No. 2 (3 meters)

       - Anechoic Chamber No. 3 (3 meters)

**Validation of Site Attenuation :**

1) Last Confirmed Date : N/A

2) Interval : N/A

**Used test instruments :**

Type	Number of test instruments (Refer to Appendix)
Test Receiver	TR07
Cable	CA06
Antenna	AN01



---

**1.3.9 The measurement of Spurious Emissions (Radiation) (30 MHz - 1000 MHz)**

  x   - was performed in the following test site.

       - was not applicable.

**Test location :**

Safety & EMC Center EMC Engineering Dept. Testing Div.  
21-25, Kinuta 1-chome, Setagaya-ku, Tokyo 157-8573, Japan

  x   - Anechoic Chamber No. 2 (3 meters)

       - Anechoic Chamber No. 3 (3 meters)

**Validation of Site Attenuation :**

1) Last Confirmed Date :March, 2004

2) Interval :1 year

**Used test instruments :**

Type	Number of test instruments (Refer to Appendix)
Test Receiver	TR05
Cable	CA01
Antenna	AN06, AN08
RF Amplifier	N/A

**1.3.10 The measurement of Spurious Emissions (Radiation) (Above 1000 MHz)**

  x   - was performed in the following test site.

       - was not applicable.

**Test location :**

Safety & EMC Center EMC Engineering Dept. Testing Div.  
21-25, Kinuta 1-chome, Setagaya-ku, Tokyo 157-8573, Japan

  x   - No. 2 site (3 meters)

       - No. 3 site (3 meters)

**Validation of Site Attenuation :**

1) Last Confirmed Date :March, 2004

2) Interval :1 year

**Used test instruments :**

<b>Type</b>	<b>Number of test instruments (Refer to Appendix)</b>
Test Receiver	TR07
Spectrum Analyzer	N/A
Cable	CA11, CA12, CA13
Antenna	AN10, AN12
RF Amplifier	AM09
Band Reject Filter	AU16
High Pass Filter	AU17

**1.3.11 The measurement of AC Power Line Conducted Emissions**

    - was performed in the following test site.

  x   - was not applicable.

**Test location :**

Safety & EMC Center EMC Engineering Dept. Testing Div.  
21-25, Kinuta 1-chome, Setagaya-ku, Tokyo 157-8573, Japan

    - Shielded Enclosure

    - Anechoic Chamber No. 2 (portable Type)

**Used test instruments :**

<b>Type</b>	<b>Number of test instruments (Refer to Appendix)</b>
Test Receiver	N/A
Spectrum Analyzer	N/A
Cable	N/A
AMN(for EUT)	N/A
AMN(for Peripheral)	N/A
Termination	N/A



**1.4 EUT MODIFICATION / Deviation from Standard**

**1.4.1 EUT MODIFICATION**

- No modifications were conducted by JQA to achieve compliance to Class B levels.
- To achieve compliance to Class B levels, the following changes were made by JQA during the compliance test.

The modifications will be implemented in all production models of this equipment.

Applicant : Date :

Typed Name : Position :

**1.4.2 Deviation from Standard:**

- No deviations from the standard described in clause 1.1.
- The following deviations were employed from the standard described in clause 1.1:

\_\_\_\_\_  
\_\_\_\_\_

**1.5 TEST RESULTS**

<b>Channel Separation</b> [§15.247(a)(1)], [§6.2.2(o)(a1)]	<u>  x  </u> - Applicable	___ - NOT Applicable
The requirements are	<u>  x  </u> - PASSED	___ - NOT PASSED
Remarks :		
<b>Minimum Hopping Channel</b> [§15.247(a)(1)(iii)], [§6.2.2(o)(a3)]	<u>  x  </u> - Applicable	___ - NOT Applicable
The requirements are	<u>  x  </u> - PASSED	___ - NOT PASSED
Remarks:		
<b>Occupied Bandwidth</b> [§15.247(a)(2)], [§5.9.1]	<u>  x  </u> - Applicable	___ - NOT Applicable
The requirements are	<u>  x  </u> - PASSED	___ - NOT PASSED
Remarks:		
<b>Average Time of Occupancy</b> [§15.247(a)(1)(iii)/(g)], [§6.2.2(o)(a3)/(c2)]	<u>  x  </u> - Applicable	___ - NOT Applicable
The requirements are	<u>  x  </u> - PASSED	___ - NOT PASSED
Remarks:		
<b>Peak Output Power (Conduction)</b> [§15.247(b)(3)], [§6.2.2(o)(b)]	<u>  x  </u> - Applicable	___ - NOT Applicable
The requirements are	<u>  x  </u> - PASSED	___ - NOT PASSED
Remarks:		
<b>Peak Output Power (Radiation)</b> [§15.247(b)(1)], [§6.2.2(o)(b)]	<u>  x  </u> - Applicable	___ - NOT Applicable
The requirements are	<u>  x  </u> - PASSED	___ - NOT PASSED
Remarks:		
<b>Peak Power Density (Conduction)</b> [§15.247(d)], [§6.2.2(o)(b)]	<u>  x  </u> - Applicable	___ - NOT Applicable
The requirements are	<u>  x  </u> - PASSED	___ - NOT PASSED
Remarks:		
<b>Peak Power Density (Radiation)</b> [§15.247(d)], [§6.2.2(o)(b)]	___ - Applicable	<u>  x  </u> - NOT Applicable
The requirements are	___ - PASSED	___ - NOT PASSED
Remarks:		



---

<b>Spurious Emissions (Conduction)</b> [§15.247(c)], [§6.2.2(o)(e1)]	<u> x </u> - <b>Applicable</b>	<u> </u> - <b>NOT Applicable</b>
The requirements are	<u> x </u> - <b>PASSED</b>	<u> </u> - <b>NOT PASSED</b>
<b>Remarks:</b>		
<b>Spurious Emissions (Radiation)</b> [§15.247(c), §15.35(b), §15.209(a)], [§6.2.2(o)(e1)]	<u> x </u> - <b>Applicable</b>	<u> </u> - <b>NOT Applicable</b>
The requirements are	<u> x </u> - <b>PASSED</b>	<u> </u> - <b>NOT PASSED</b>
<b>Remarks:</b>		
<b>AC Power Line Conducted Emissions</b> [§15.207(a)], [§6.6]	<u> </u> - <b>Applicable</b>	<u> x </u> - <b>NOT Applicable</b>
The requirements are	<u> </u> - <b>PASSED</b>	<u> </u> - <b>NOT PASSED</b>
<b>Remarks:</b>		
<b>RF Exposure Compliance</b> [§15.247(b)(5)], [§14]	<u> x </u> - <b>Applicable</b>	<u> </u> - <b>NOT Applicable</b>
The requirements are	<u> x </u> - <b>PASSED</b>	<u> </u> - <b>NOT PASSED</b>
<b>Remarks:</b>		
<b>Spurious Emissions for Receiver</b> (Radiation)[§15.109(a)], [§7.3]	<u> x </u> - <b>Applicable</b>	<u> </u> - <b>NOT Applicable</b>
The requirements are	<u> x </u> - <b>PASSED</b>	<u> </u> - <b>NOT PASSED</b>
<b>Remarks:</b>		
<b>AC Power Line Conducted Emissions</b> <b>for Receiver</b> [§15.107(a)], [§7.4]	<u> </u> - <b>Applicable</b>	<u> x </u> - <b>NOT Applicable</b>
The requirements are	<u> </u> - <b>PASSED</b>	<u> </u> - <b>NOT PASSED</b>
<b>Remarks:</b>		

---

**1.6 SUMMARY****General Remarks :**

The EUT was tested according to the requirements of FCC Rules and Regulations Part 15 Subpart B, Subpart C and IC RSS-210 issue 5 (including Amendment) under the test configuration, as shown in clause 1.7 to 1.10.

The conclusion for the test items which are required by the applied regulation is indicated under the final judgment.

**Final Judgment :**

The "as received" sample;

  x   - fulfill the test requirements of the regulation mentioned on clause 1.1.

     - fulfill the test requirements of the regulation mentioned on clause 1.1, but with certain qualifications.

     - doesn't fulfill the test regulation mentioned on clause 1.1.

Begin of testing : September 13, 2004

End of testing : September 28, 2004

**- JAPAN QUALITY ASSURANCE ORGANIZATION -**

Approved by:

Issued by:



Masaaki Takahashi  
Senior Manager  
JQA EMC Engineering Dept.



Shigeru Osawa  
Assistant Manager  
JQA EMC Engineering Dept.

## 1.7 TEST CONFIGURATION / OPERATION OF EUT

### 1.7.1 Test Configuration

The equipment under test (EUT) consists of :

Symbol	Item	Manufacturer	Model No.	FCC ID	Serial No.
A(*)	Car Navigation	Xanavi Informatics Corporation	CCA-1200U GCA-1200U	SJ21200U	-

(\*)Note: The unit under test is the CCA-1200U and GCU1200U which contains a Bluetooth module. These two units are similar on all aspect excepted the DVD reader that can be found on the CCA-1200U and not on the GCU-1200. The device, under certification, has been tested with the Bluetooth radio located outside the unit. This configuration represents the worst case configuration.

Please note that the car navigation system have been tested based on part 15 B.

The measurement was carried out with the following support equipment connected :

Symbol	Item	Manufacturer	Model No.	FCC ID	Serial No.
B	Personal Computer	EPSON DIRECT CORPORATION	NT2600	N/A (DoC)	210008072
C	AC Adaptor	DELTA ELECTRONICS, INC.	ADP-65DB	N/A	Q1W0353039122
D	Serial I/O Card	Socket Communication Inc.	Serial-Card	N/A (DoC)	0311000139
E	Temporary Circuit	Xanavi Informatics Corporation	-	-	-
F	DC Power Supply	KIKUSUI ELECTRONICS CORP.	PAN35-20A	N/A	GJ000984

Type of Cable :

Symbol	Description	Identification (Manufacturer etc.)	Connector Shielded YES / NO	Cable Shielded YES / NO	Ferrite Core	Length (m)
1	DC Power Cable	-	NO	NO	NO	0.8
2	DC Power Cable	-	NO	NO	YES	1.8
3	AC Power Cable	-	NO	NO	NO	1.8
4	RS-232C Cable	-	YES	YES	NO	1.5
5	USB Cable	-	YES	YES	NO	2.0
6	AC Power Cable	-	NO	NO	NO	2.0

### 1.7.2 Operating condition

Power supply Voltage : 3.3 VDC from DC power supply

The tests have been carried out the following mode.

- 1) TX mode (2402 MHz)
- 2) TX mode (2441 MHz)
- 3) TX mode (2480 MHz)
- 4) Hopping ON mode
- 5) Hopping OFF mode
- 6) RX mode

### 1.7.3 Generating and Operating frequency of EUT

16 MHz and 2402 MHz to 2480 MHz



**1.8 EUT ARRANGEMENT (DRAWINGS)**

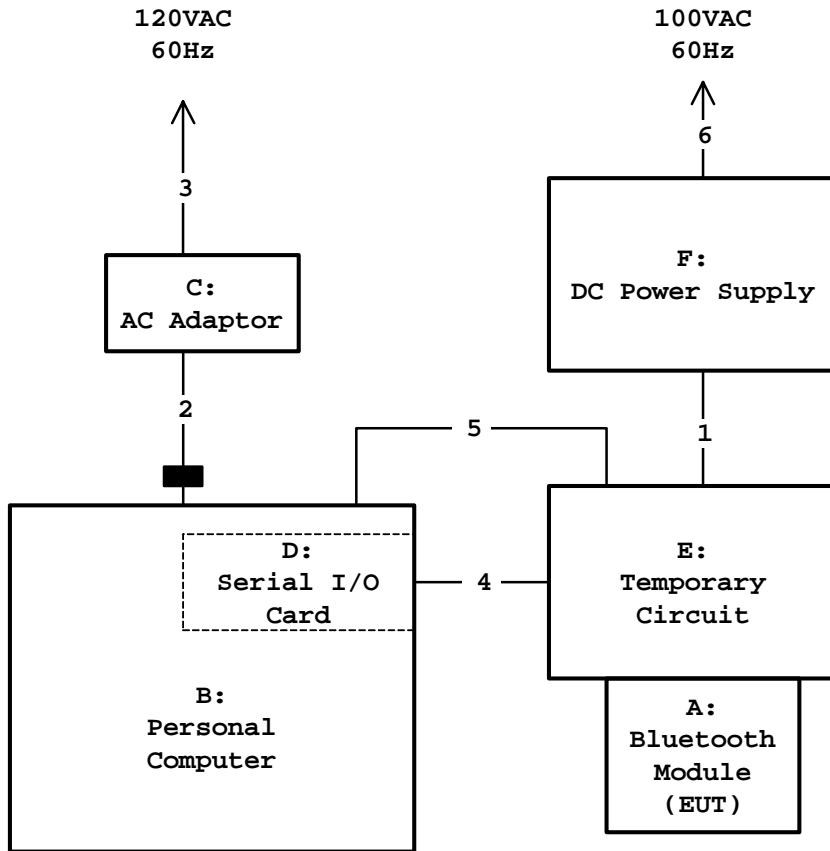

■ : Ferrite Core

### CCA-1200U Test configuration

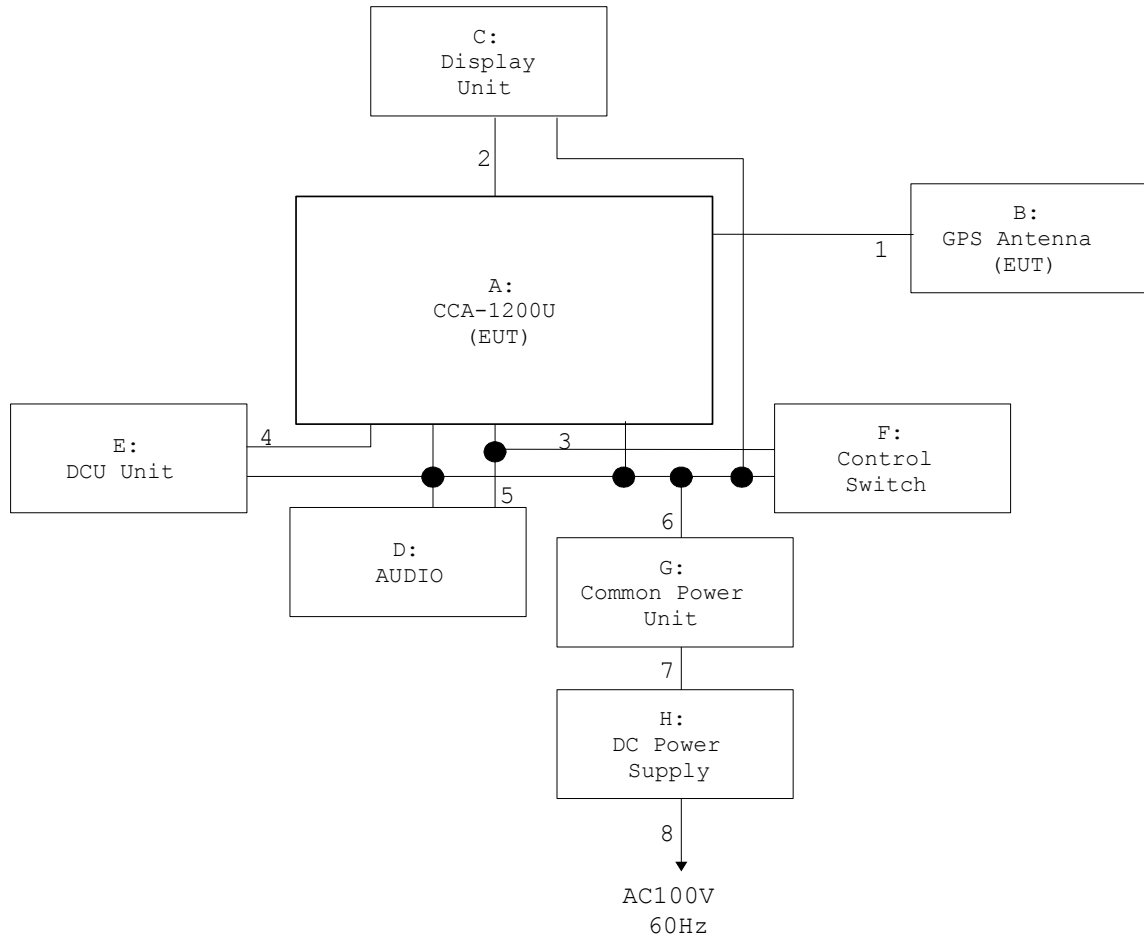

## 1.9 PRELIMINARY TEST AND TEST-SETUP (DRAWINGS)

### 1.9.1 Channel Separation

The EUT have its hopping function enabled.

Use the following spectrum analyzer settings:

Span = wide enough to capture the peaks of two adjacent channels

Resolution (or IF) Bandwidth (RBW)  $\geq$  1% of the span

Video (or Average) Bandwidth (VBW)  $\geq$  RBW

Sweep = auto

Detector function = peak

Trace = max hold

Allow the trace to stabilize. Use the marker-delta function to determine the separation between the peaks of the adjacent channels.

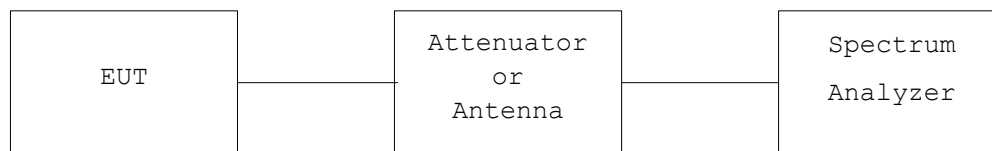

### 1.9.2 Minimum Hopping Channel

The EUT have its hopping function enabled.

Use the following spectrum analyzer settings:

Span = the frequency band of operation

RBW  $\geq$  1% of the span

VBW  $\geq$  RBW

Sweep = auto

Detector function = peak

Trace = max hold

Allow the trace to stabilize. It may prove necessary to break the span up to sections, in order to clearly show all of the hopping frequencies.

Measurement setup is same as sub-clause 1.9.1.

### 1.9.3 Occupied Bandwidth

Use the following spectrum analyzer settings:

Span = approximately 2 to 3 times the 6 dB or 20 dB bandwidth, centered on a channel

RBW  $\geq$  1% of the 6 dB or 20 dB bandwidth

VBW  $\geq$  RBW

Sweep = auto

Detector function = peak

Trace = max hold

The EUT should be transmitting at its maximum data rate. Allow the trace to stabilize. Use the marker-to-peak function to set the marker to the peak of the emission. Use the marker-delta function to measure 6 dB or 20 dB down one side of the emission. Reset the marker-delta function, and move the marker to the other side of the emission, until it is (as close as possible to) even with the reference marker level. The marker-delta reading at this point is the 6 dB or 20 dB bandwidth of the emission. If this value varies with different modes of operation (e.g., data rate, modulation format, etc.), repeat this test for each variation.

Measurement setup is same as sub-clause 1.9.1.

### 1.9.4 Average Time of Occupancy

The EUT must have its hopping function enabled.

Use the following spectrum analyzer settings:

Span = zero span, centered on a hopping channel

RBW  $\leq$  Channel Separation

VBW  $\geq$  RBW

Sweep = as necessary to capture the entire dwell time per hopping channel

Detector function = peak

Trace = max hold

If possible, use the marker-delta function to determine the dwell time. If this value varies with different modes of operation (e.g., data rate, modulation format, etc.), repeat this test for each variation.

Measurement setup is same as sub-clause 1.9.1.

**1.9.5 Peak Output Power (Conduction)**

(Step 1) Use the following spectrum analyzer settings:  
 Span = approximately 5 times the 20 dB bandwidth, centered on a channel  
 RBW > the 20 dB bandwidth of the emission being measured  
 VBW ≥ RBW  
 Sweep = auto  
 Detector function = peak  
 Trace = max hold

Allow the trace to stabilize. Use the marker-to-peak function to set the marker to the peak of the emission. Record the reading P1.

(Step 2) Replace the EUT with the signal generator. Adjust the level of the signal generator output until the reading P1.

(Step 3) Replace the spectrum analyzer with the power meter. Record the reading of power meter P2. The peak output power of the EUT is P2.

Step 1

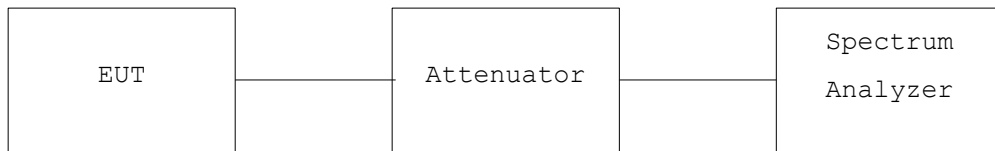

Step 2

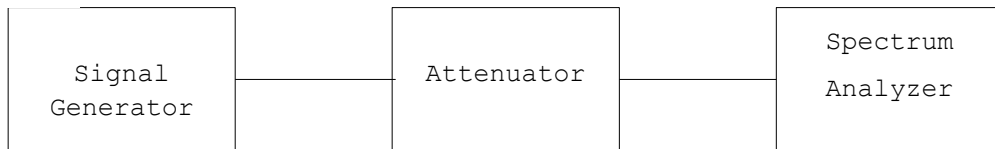

Step 3

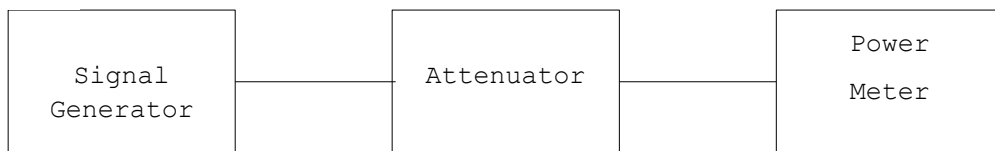

**1.9.6 Peak Power Density (Conduction)**

Use the following spectrum analyzer settings:

Span = approximately 5 times the 20 dB bandwidth, centered on a channel

RBW = Specified Value

VBW ≥ RBW

Sweep = auto

Detector function = peak

Trace = max hold

Allow the trace to stabilize. Use the marker-to-peak function to set the marker to the peak of the emission.

Measurement setup is same as sub-clause 1.9.1.

**1.9.7 Peak Output Power and Peak Power Density (Radiation)**

The radiated power output and the field strength of the transmitter radiation were measured at the distance at 3 meters away from the transmitter under test which was placed on a turntable 0.8 meter in height. The receiving antenna was oriented for vertical polarization and raised or lowered through 1 to 4 meters until the maximum signal level was detected on the measuring instrument. The transmitter under test was rotated through 360° until the maximum signal was received. The measurement was repeated with the receiving antenna in the horizontal polarization.

The transmitter was removed and replaced with the antenna. The center of the antenna was placed approximately at the same location as the center of the transmitter. The antenna was fed with a signal generator, and the output level of the signal generator was adjusted to obtain the previously recorded maximum reading at the particular frequency and recorded. This procedure was repeated with the receiving antenna and the antenna in the orthogonal polarization.

The input power into the antenna was measured using the power meter. The level of the emissions in dBm(EIRP) were calculated from the following formula:

$$\text{Transmitter Power[dBm] (EIRP)} = (\text{Meter Reading of Power Meter}) + (\text{Antenna Gain[dBi]})$$

Use the following spectrum analyzer settings:

Span = approximately 5 times the 20 dB bandwidth, centered on a channel

RBW : Greater than the 20 dB bandwidth of the emission being measured  
or Specified Value

VBW ≥ RBW

Sweep = auto

Detector function = peak

Trace = max hold

Allow the trace to stabilize. Use the marker-to-peak function to set the marker to the peak of the emission.

### 1.9.8 Spurious Emission (Conduction)

#### Band-edge Compliance of RF Conducted Emissions

Use the following spectrum analyzer settings:

Span = wide enough to capture the peak level of the emission operating on the channel closest to the bandedge, as well as any modulation products which fall outside of the authorized band of operation

RBW  $\geq$  1% of the span

VBW  $\geq$  RBW

Sweep = auto

Detector function = peak

Trace = max hold

Allow the trace to stabilize. Set the marker on the emission at the bandedge, or on the highest modulation product outside of the band, if this level is greater than that at the bandedge. Enable the marker-delta function, then use the marker-to-peak function to move the marker to the peak of the in-band emission.

Now, using the same instrument settings, enable the hopping function of the EUT. Allow the trace to stabilize. Follow the same procedure listed above to determine if any spurious emissions caused by the hopping function also comply with the specified limit.

#### Spurious RF Conducted Emissions

Use the following spectrum analyzer settings:

Span = wide enough to capture the peak level of the in-band emission and all spurious emissions (e.g., harmonics) from the lowest frequency generated in the EUT up through the 10th harmonic. Typically, several plots are required to cover this entire span.

RBW = 100 kHz

VBW  $\geq$  RBW

Sweep = auto

Detector function = peak

Trace = max hold

Allow the trace to stabilize. Set the marker on the peak of any spurious emission recorded. The level displayed must comply with the limit specified in this Section.

Measurement setup is same as sub-clause 1.9.1.

**1.9.9 Radiated Emission ( 9 kHz - 30 MHz ) :**

According to description of ANSI C63.4-2001 sec.13.1.4, the preliminary radiated emissions measurement were carried out. The preliminary radiated measurements were performed at the measurement distance that specified for compliance to determine the emission characteristics of the EUT.

The EUT configuration, cable configuration and mode of operation were determined for producing the maximum level of emissions. These configurations were used for the final radiated emissions measurements.

- Side View -

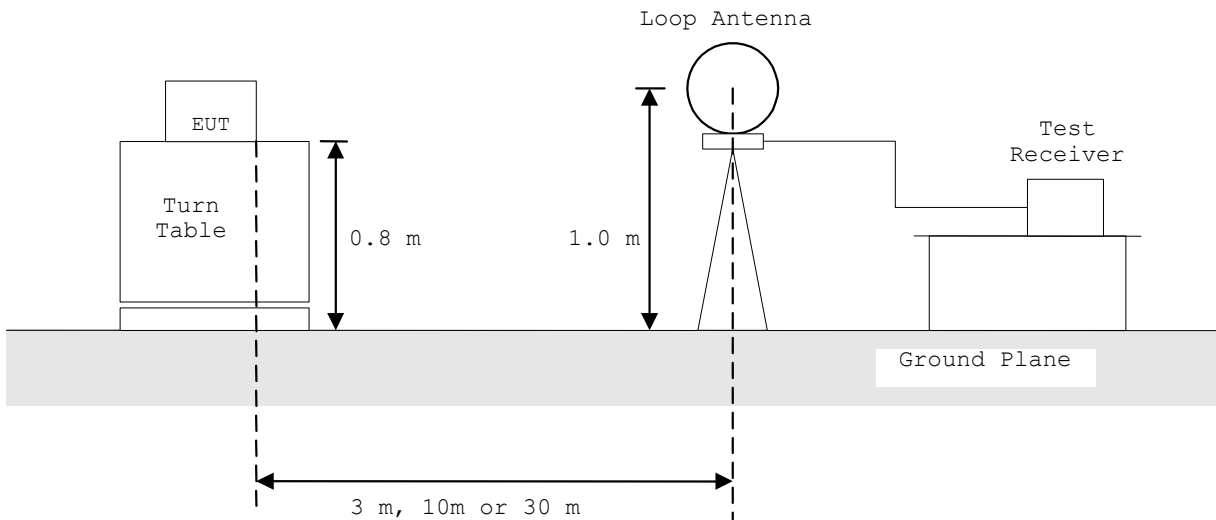



**1.9.10 Radiated Emission ( 30 MHz - 1000 MHz ) :**

According to description of ANSI C63.4-2001 sec.13.1.4, the preliminary radiated emissions measurement were carried out. The preliminary radiated measurements were performed at the measurement distance that specified for compliance to determine the emission characteristics of the EUT.

The EUT configuration, cable configuration and mode of operation were determined for producing the maximum level of emissions. These configurations were used for the final radiated emissions measurements.

**Anechoic Chamber**

- Side View -

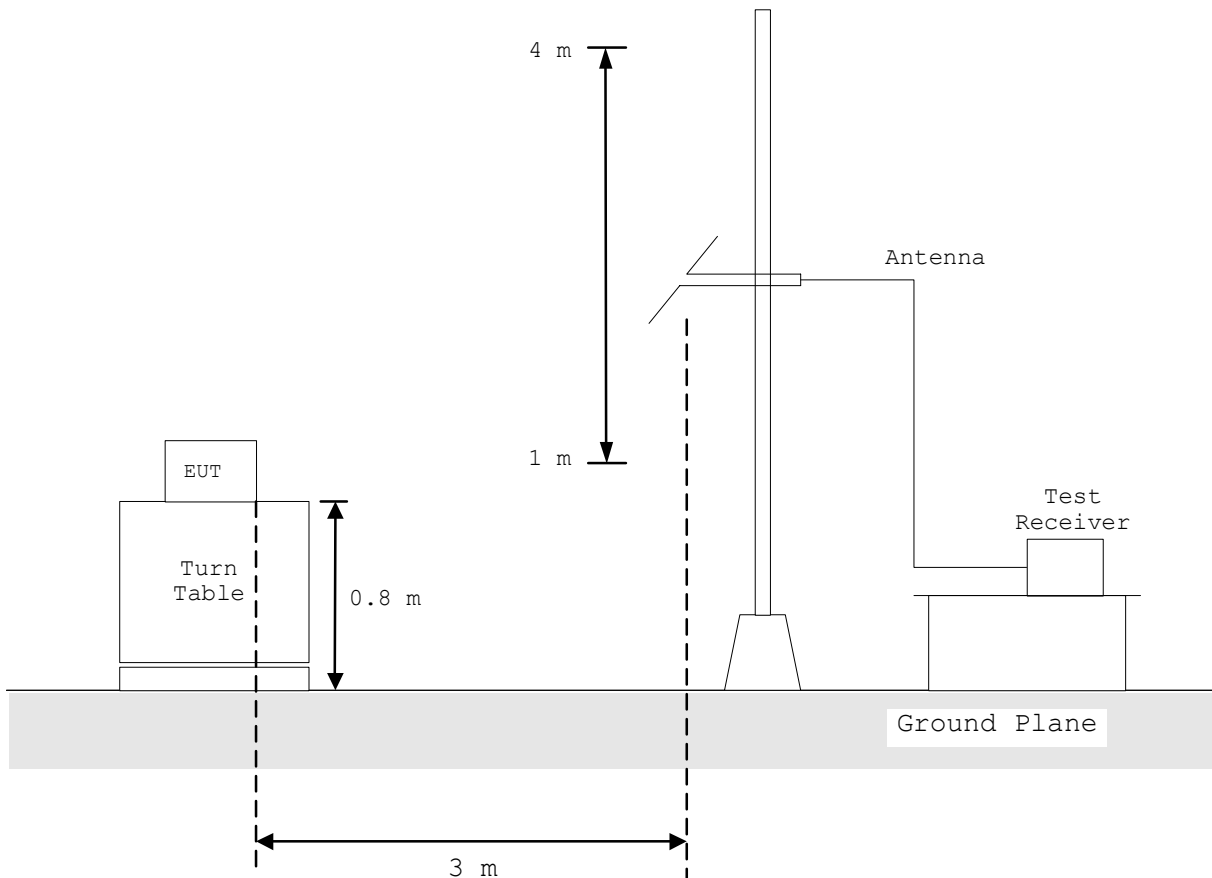

**1.9.11 Radiated Emission (Above 1 GHz) :**

According to description of ANSI C63.4-2001 sec.13.1.4, the preliminary radiated emissions measurements were carried out. The preliminary radiated measurements were performed at the measurement distance that specified for compliance to determine the emission characteristics of the EUT.

The EUT configuration, cable configuration and mode of operation were determined for producing the maximum level of emissions. These configurations were used for the final radiated emissions measurements.

**Anechoic Chamber**

- Side View -

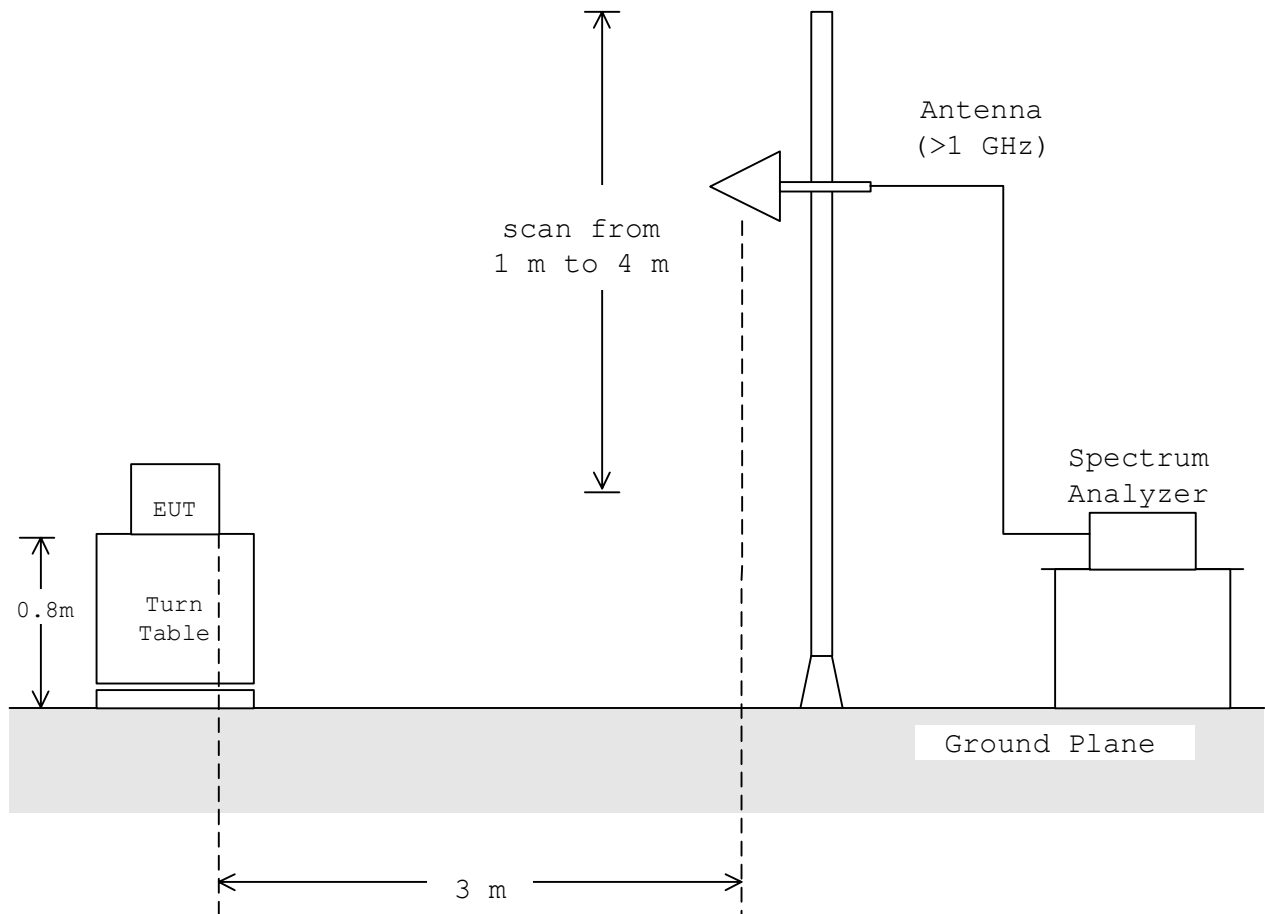

**1.9.12 AC Power Line Conducted Emission ( 150 kHz - 30 MHz ) :**

According to description of ANSI C63.4-2001 sec.13.1.3, the AC power line preliminary conducted emissions measurements were carried out.

The preliminary conducted measurements were performed using the spectrum analyzer to observe the emission characteristics of the EUT.

The EUT configuration, cable configuration and mode of operation were determined for producing the maximum level of emissions. These configurations were used for final AC power line conducted emissions measurements.

**Shielded Enclosure**

**- Side View -**

Vertical  
Ground  
Plane

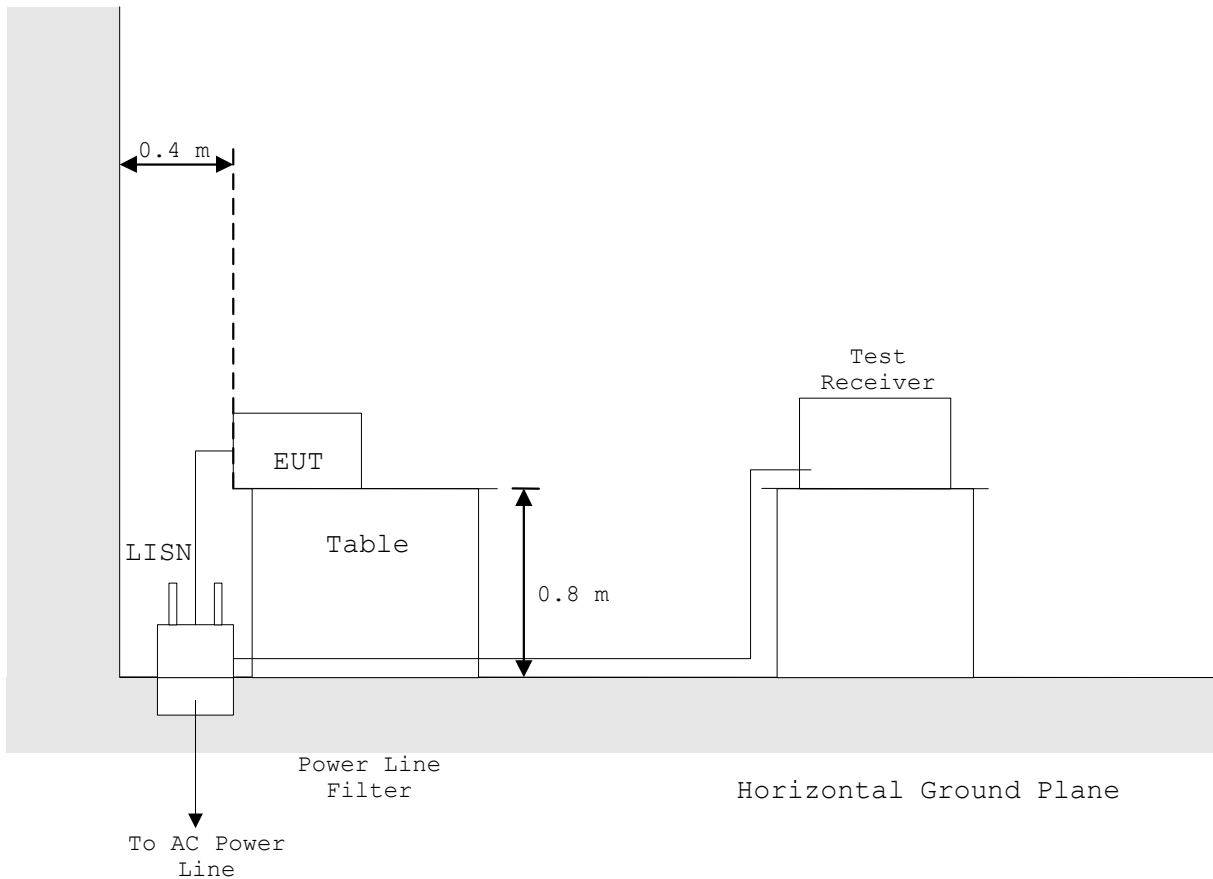

**1.10 TEST ARRANGEMENT (PHOTOGRAPHS)****PHOTOGRAPHS OF EUT CONFIGURATION FOR RADIATED EMISSIONS MEASUREMENT**

Photograph present configuration with maximum emission

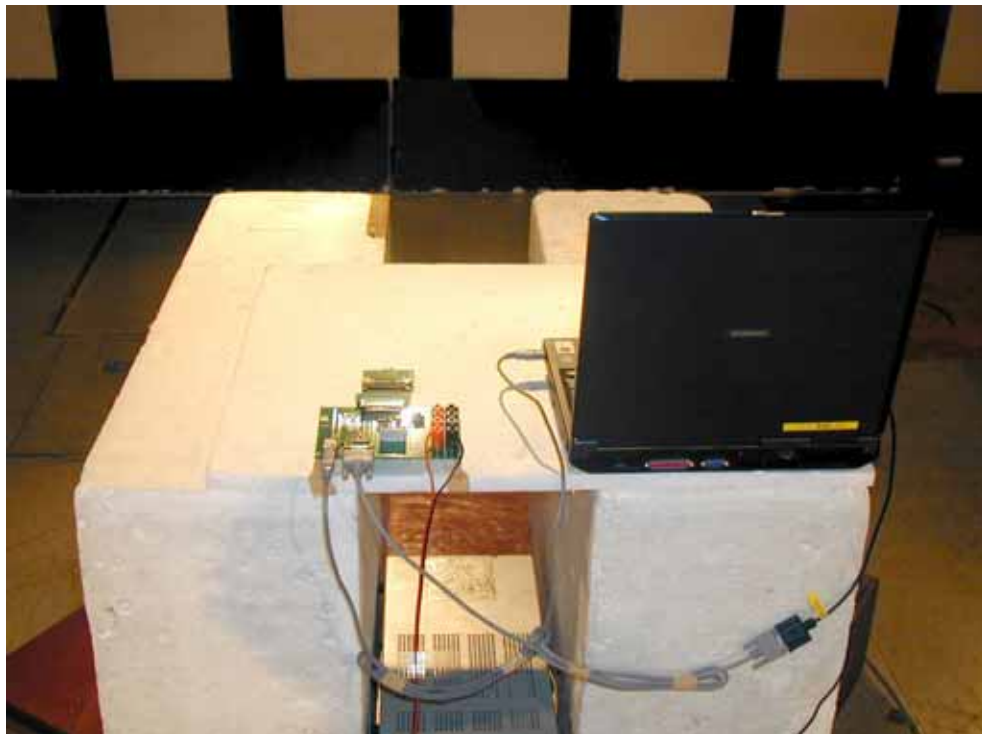

**PHOTOGRAPHS OF EUT CONFIGURATION FOR RADIATED EMISSIONS MEASUREMENT**

Photograph present configuration with maximum emission(**CCA-1200U configuration**)

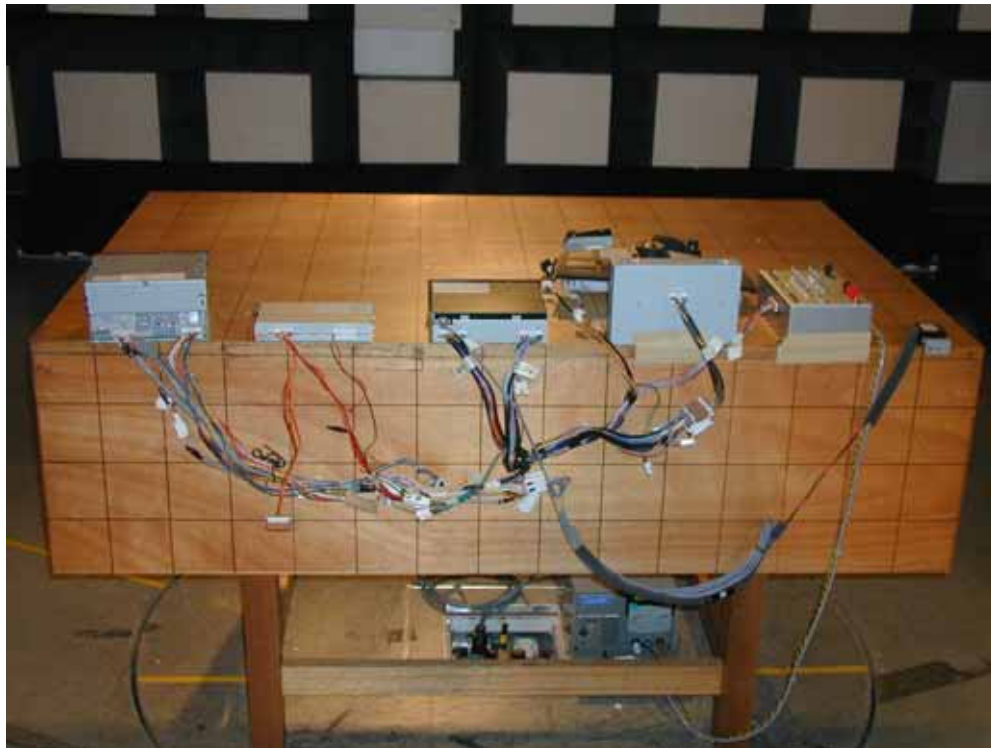

## 2. TEST DATA

### 2.1 Channel Separation

Date : September 13, 2004

Temp.: 22 °C Humi.: 54 %

Mode of EUT : Hopping (Max. power setting)

Test Port : Temporary antenna connector

Channel Separation	Limit
(kHz)	
1016.032	>25 kHz or 20 dB bandwidth of hopping channel

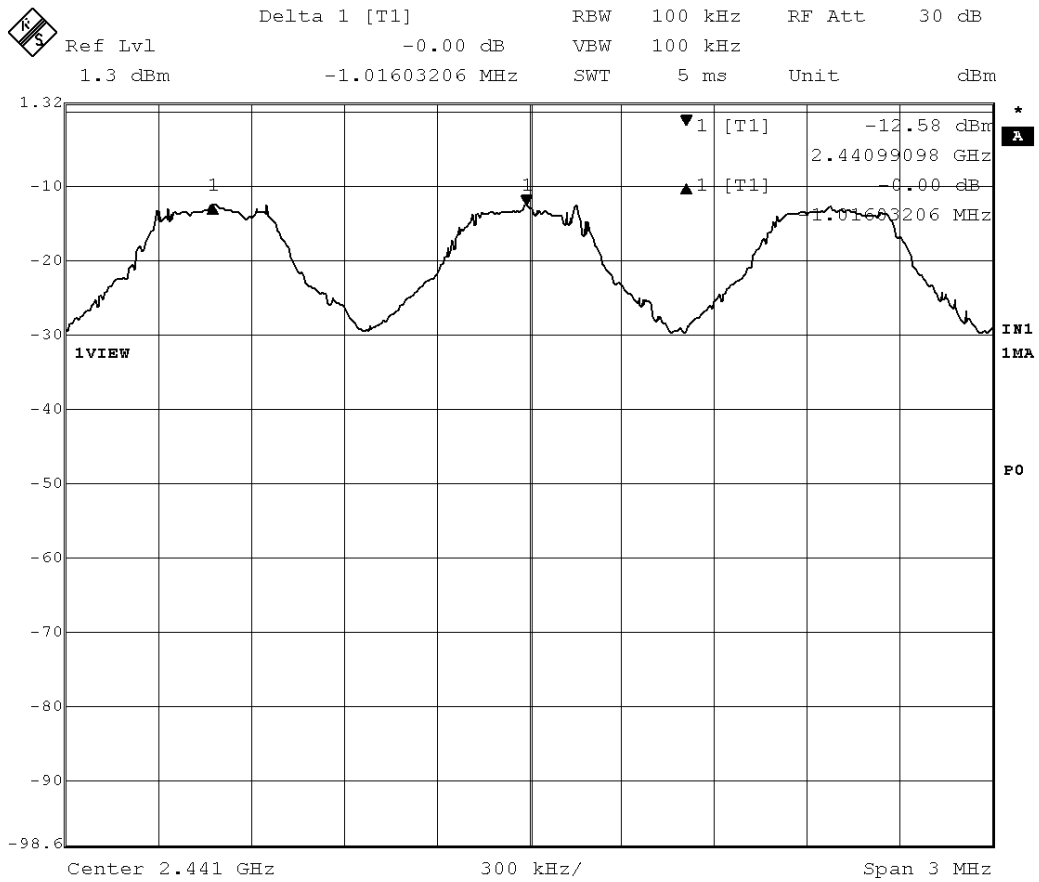

Tested by : M. Takahashi  
 Masanori Takahashi  
 Testing Engineer

## 2.2 Minimum Hopping Channel

Date : September 13, 2004  
 Temp.: 22 °C Humi.: 54 %

Mode of EUT : Hopping (Max. power setting)  
 Test Port : Temporary antenna connector

Hopping Channel	Limit
79	>15

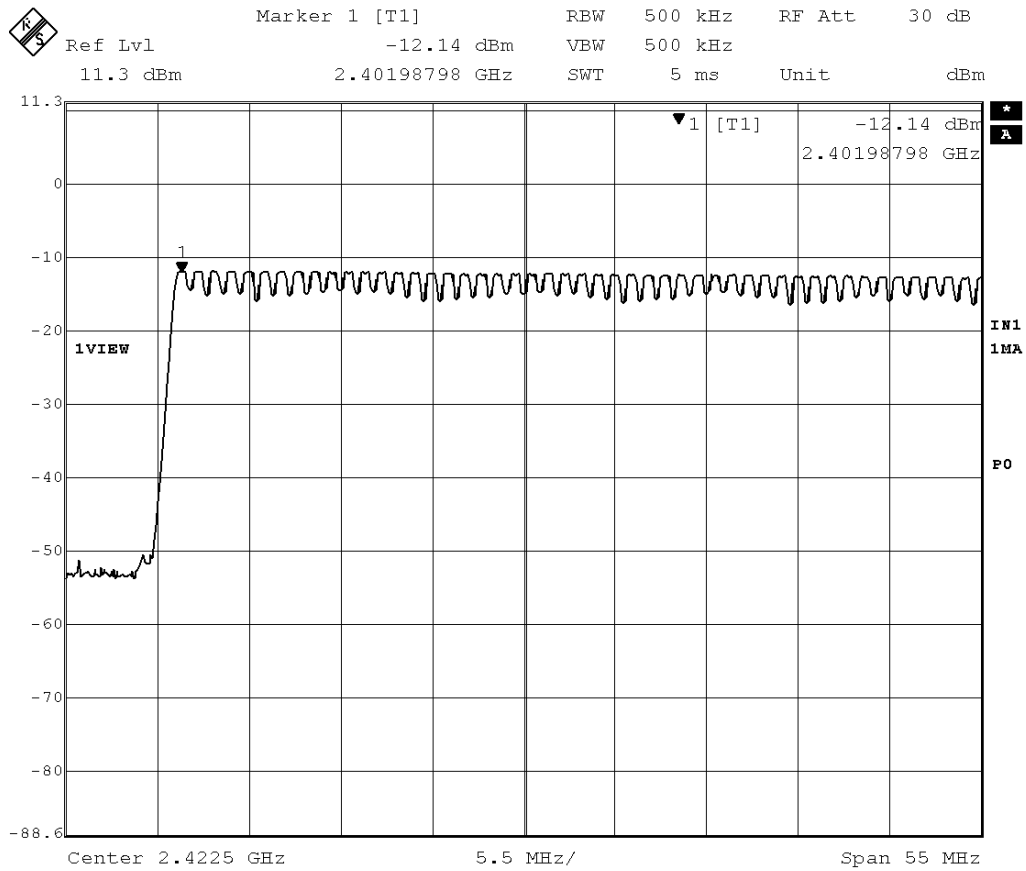

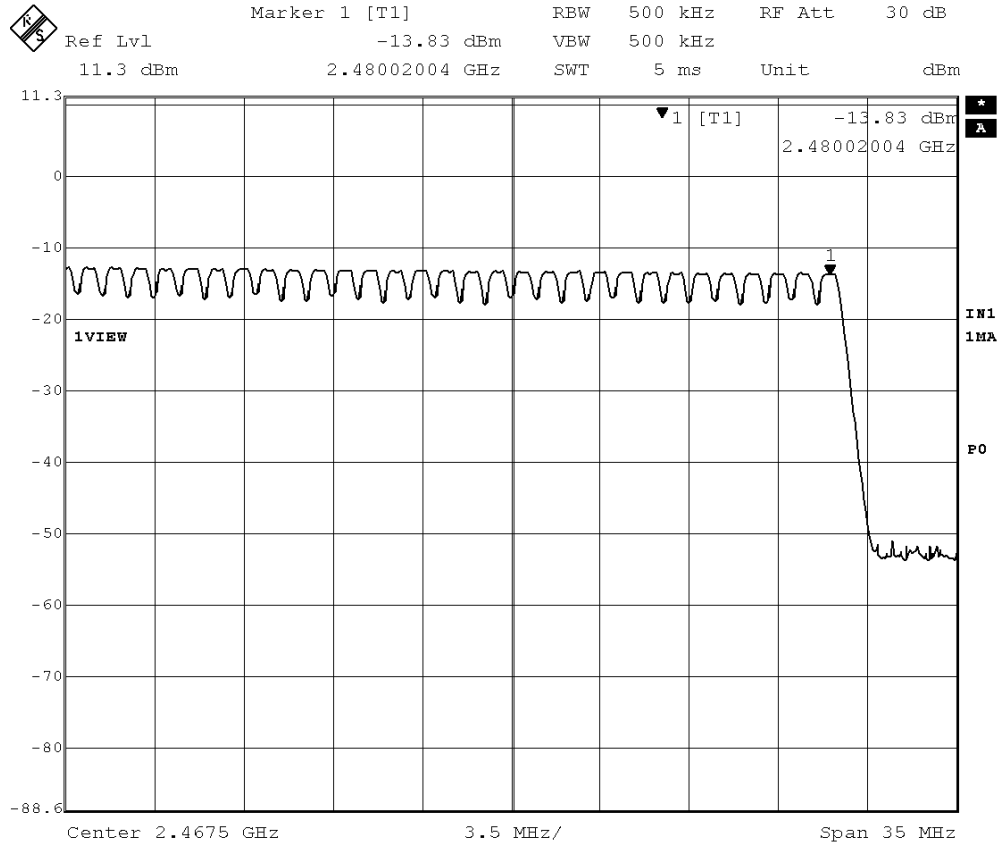

Tested by : M. Takahashi  
 Masanori Takahashi  
 Testing Engineer



### 2.3 Occupied Bandwidth

Date : September 13, 2004  
 Temp.: 22 °C Humi.: 54 %

Mode of EUT : TX 2402 MHz (Max. power setting)  
 Test Port : Temporary antenna connector

Bandwidth (kHz)	Limit (kHz)
797.6	>500

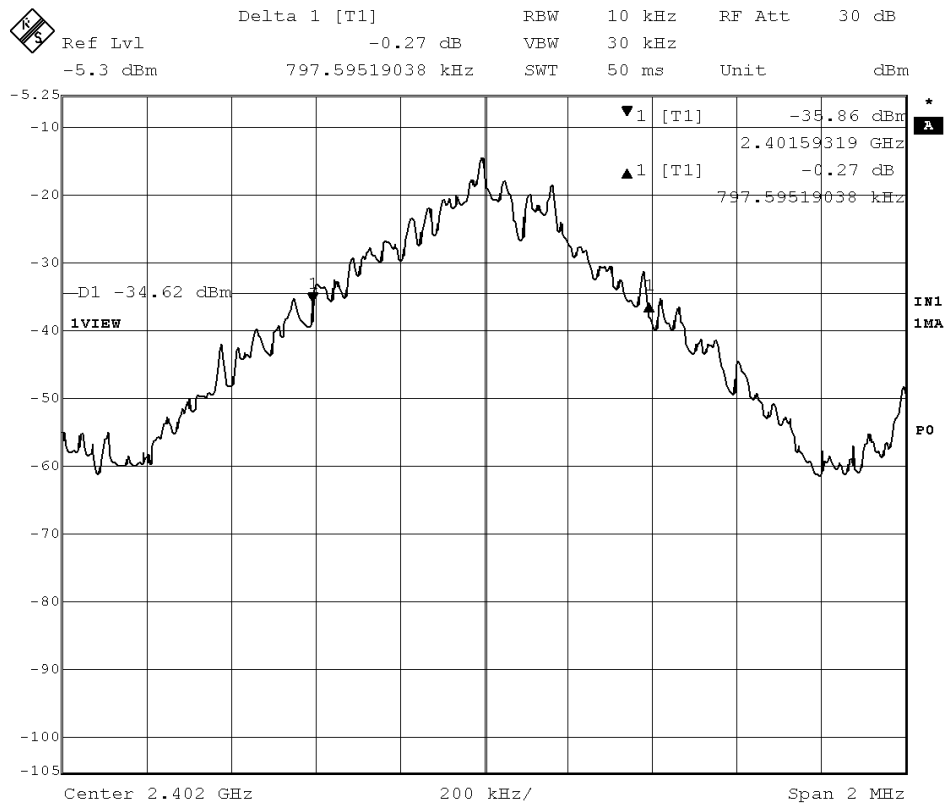

Mode of EUT : TX 2441 MHz (Max. power setting)

Test Port : Temporary antenna connector

Bandwidth (kHz)	Limit (kHz)
797.6	>500

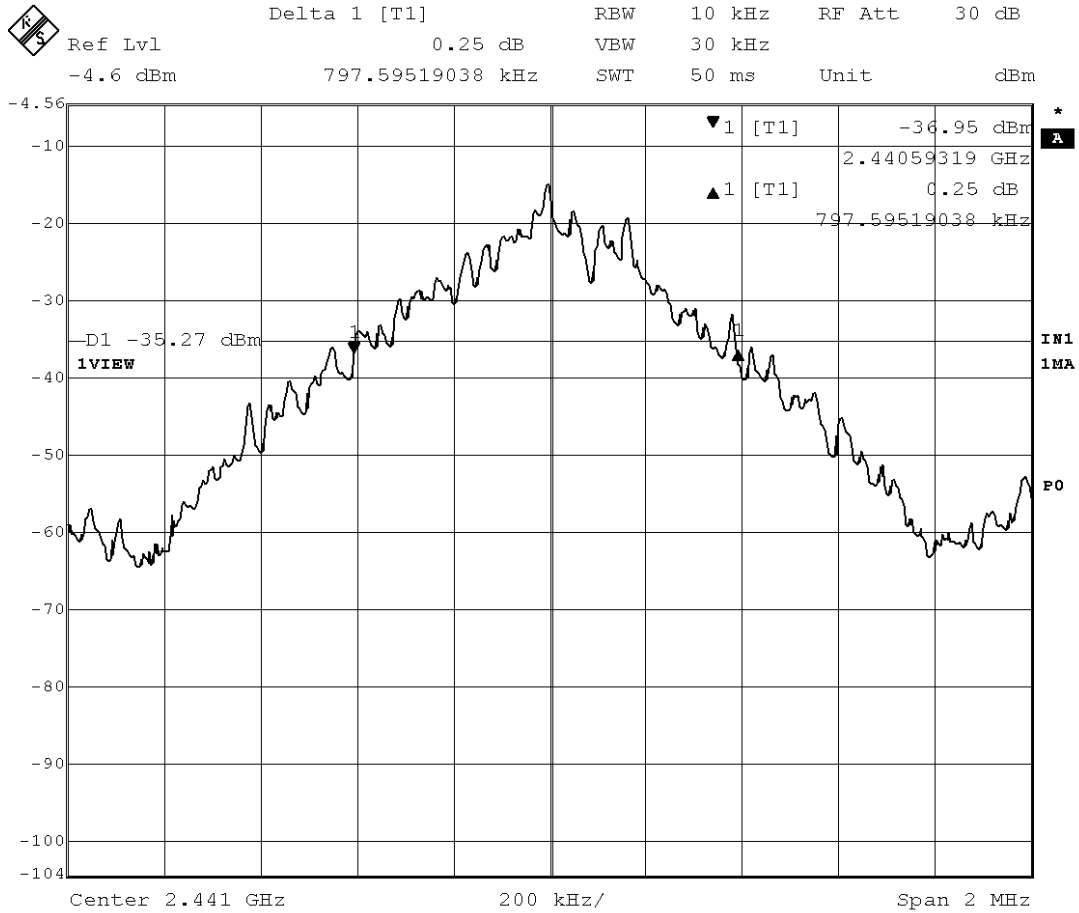

Mode of EUT : TX 2480 MHz (Max. power setting)

Test Port : Temporary antenna connector

Bandwidth	Limit
(kHz)	(kHz)
797.6	>500

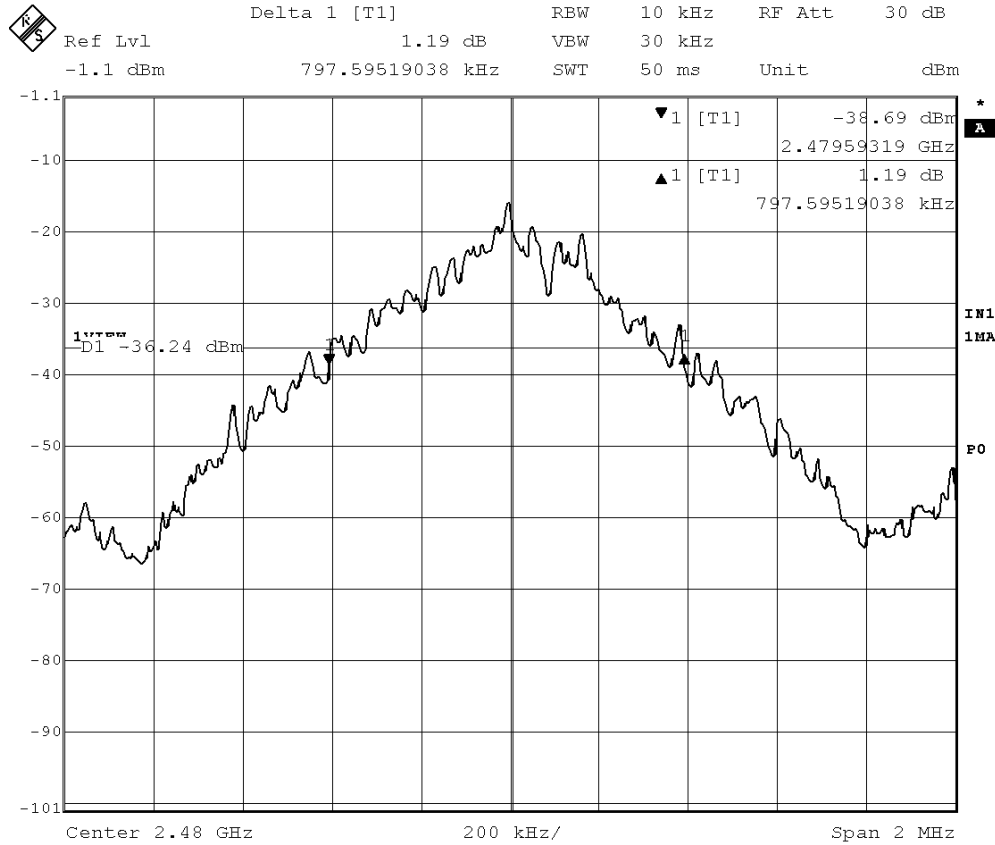

Tested by : M. Takahashi  
 Masanori Takahashi  
 Testing Engineer

**2.4 Average Time of Occupancy**

Date : September 13, 2004

Temp.: 22 °C Humi.: 54 %

Mode of EUT : Hopping(DH1 packet) Max. power setting

Test Port : Temporary antenna connector

Dwell Time (ms)	Limit
141.1	400 ms per 31.6 s

Note : The system makes worst case 1600 hops per second or 1 time slot has a length of 625  $\mu$ s with 79 channels. A DH1 Packet need 1 time slot for transmitting and 1 time slot for receiving. Then the system makes worst case 800 hops per second with 79 channels. So the system has each channel 10.1266 times per second and so for 31.6 seconds the system have 320.0 times of appearance. Each tx-time per appearance is 0.4409 ms.  
 Dwell time = 320.0 \* 0.4409 = 141.1 ms

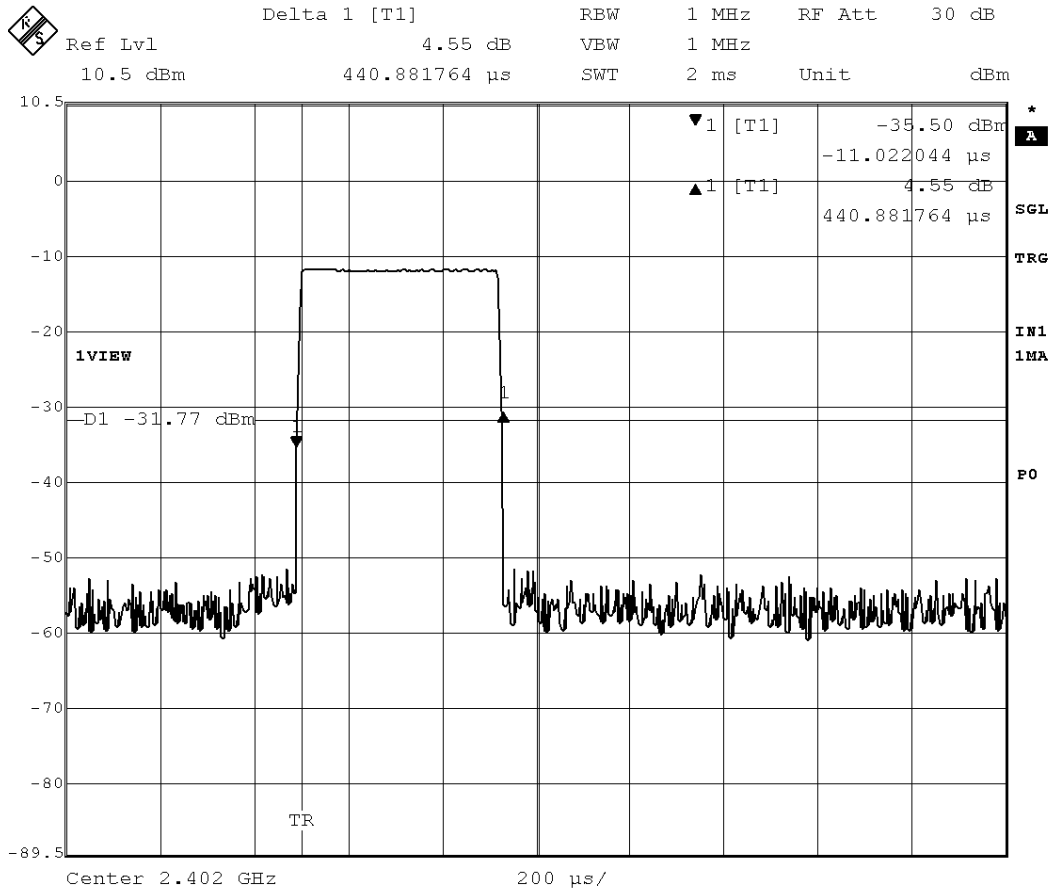

Mode of EUT : Hopping(DH3 packet) Max. power setting

Test Port : Temporary antenna connector

Dwell Time (ms)	Limit
274.1	400 ms per 31.6 s

Note : A DH3 Packet need 3 time slot for transmitting and 1 time slot for receiving. Then the system makes worst case 400 hops per second with 79 channels. So the system have each channel 5.063 times per second and so for 31.6 seconds the system have 160.0 times of appearance. Each tx-time per appearance is 1.713 ms. Dwell time = 160.0 \* 1.713 = 274.1 ms

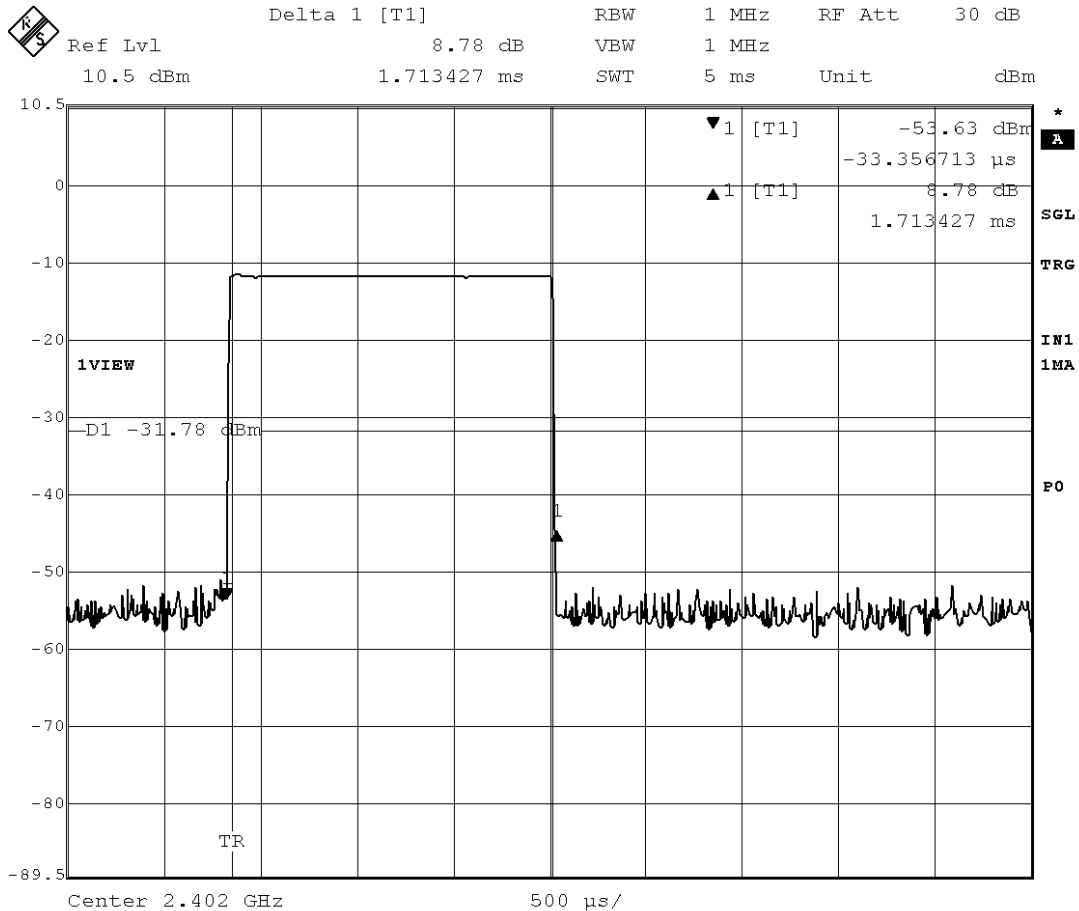

Mode of EUT : Hopping(DH5 packet) Max. power setting

Test Port : Temporary antenna connector

Dwell Time (ms)	Limit
315.4	400 ms per 31.6 s

Note : A DH5 Packet need 5 time slot for transmitting and 1 time slot for receiving. Then the system makes worst case 266.667 hops per second with 79 channels. So the system have each channel 3.3755 times per second and so for 31.6 seconds the system have 106.7 times of appearance. Each tx-time per appearance is 2.956 ms. Dwell time = 106.7 \* 2.956 = 315.4 ms

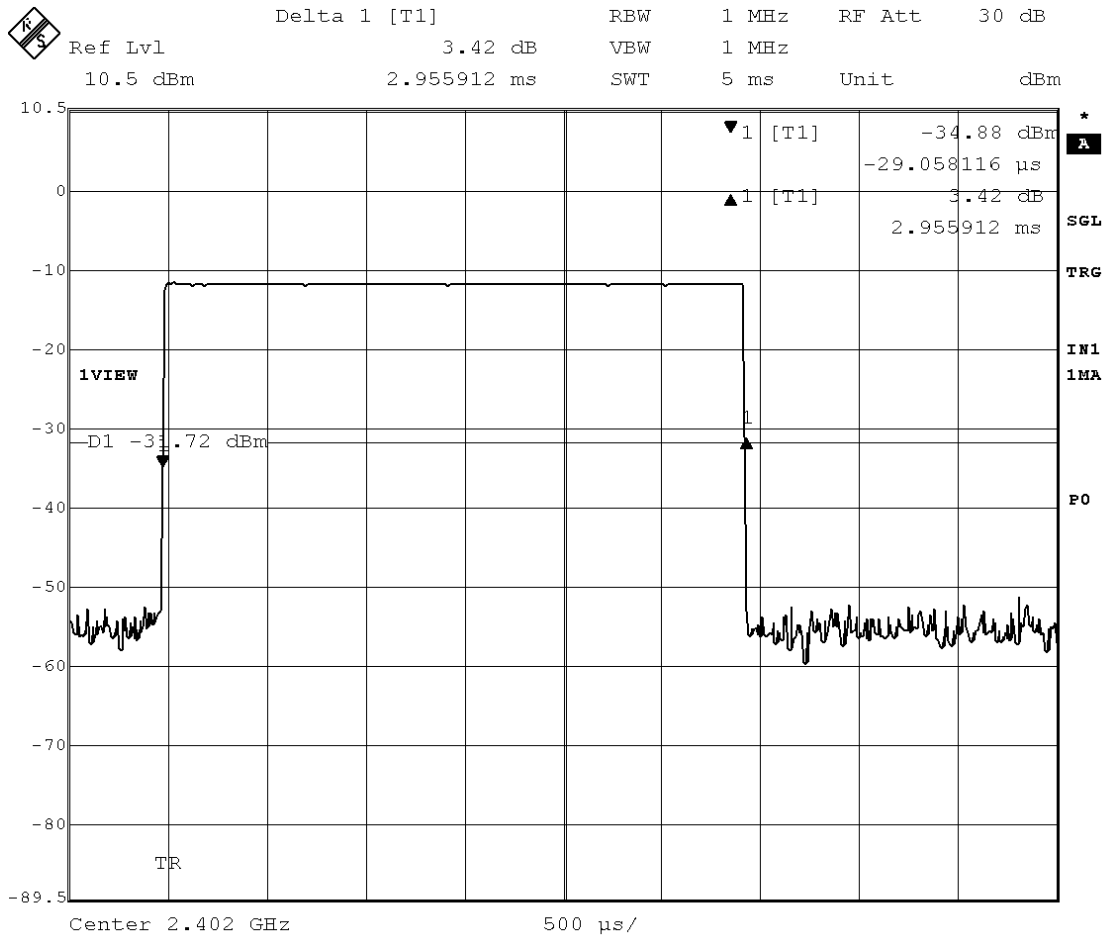

Tested by : M. Takahashi  
 Masanori Takahashi  
 Testing Engineer

**2.5 Peak Output Power (Conduction)**Date : September 13, 2004Temp.: 22 °C Humi.: 54 %

Test Port : Temporary antenna connector (Max. power setting)

Mode of EUT	Cable Loss (dB)	Meter Reading (dBm)	Peak Power (dBm)	Limit (dBm)
TX (2402 MHz)	10.48	-11.78	-1.30	30
TX (2441 MHz)	10.48	-12.48	-1.93	30
TX (2480 MHz)	10.48	-13.44	-2.96	30

Note : 1) Rated Supply Voltage : Flash Battery was used

2) A sample calculation was made at 2402 MHz.

CL + MR = 10.48 + (-11.78) = -1.30 (dBm)

CL : Cable Loss and Attenuation Loss

MR : Meter Reading

3) Measuring Instruments Setting :

Detector Function	Resolution Bandwidth
Peak	1 MHz

Tested by :

Masanori Takahashi

Testing Engineer

**2.6 Peak Output Power (Radiation):EIRP**Date : September 28, 2004Temp.: 21 °C Humi.: 52 %

Test Port : Enclosure (Max. power setting)

Mode of EUT	Receiving Antenna Gain (dBi)	Meter Reading (dBm)		Peak Power (dBm)		Limit (dBm)
		Horiz.	Vert.	Horiz.	Vert.	
TX (2402 MHz)	9.30	-18.54	-18.24	-9.24	-8.94	30
TX (2441 MHz)	9.46	-18.61	-20.11	-9.15	-10.65	30
TX (2480 MHz)	9.53	-19.22	-21.72	-9.69	-12.19	30

Note : 1) Rated Supply Voltage : Fresh battery was used

2) A sample calculation was made at 2402 MHz.

$$AG + MR = 9.30 + (-18.54) = -9.24 \text{ (dBm)}$$

AG : Antenna Gain

MR : Meter Reading

3) Measuring Instruments Setting :

Detector Function	Resolution Bandwidth
Peak	1 MHz

Tested by : M. Takahashi  
 Masanori Takahashi  
 Testing Engineer





Mode of EUT : TX (2441 MHz) Max. power setting  
 Test Port : Temporary antenna connector

Cable Loss (dB)	Meter Reading (dBm)	Peak Power (dBm)	Limit (dBm)
10.48	-24.00	-13.52	8

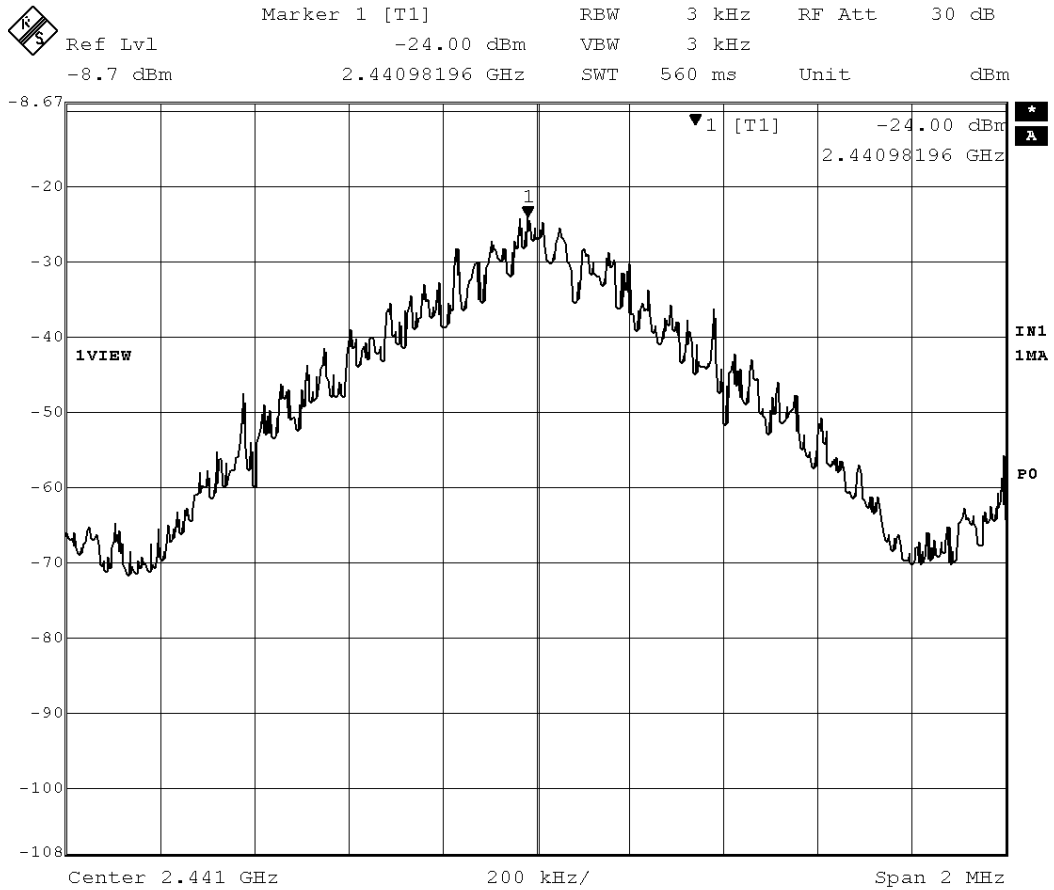

Mode of EUT : TX (2480 MHz) Max. power setting  
 Test Port : Temporary antenna connector

Cable Loss (dB)	Meter Reading (dBm)	Peak Power (dBm)	Limit (dBm)
10.48	-24.93	-14.45	8

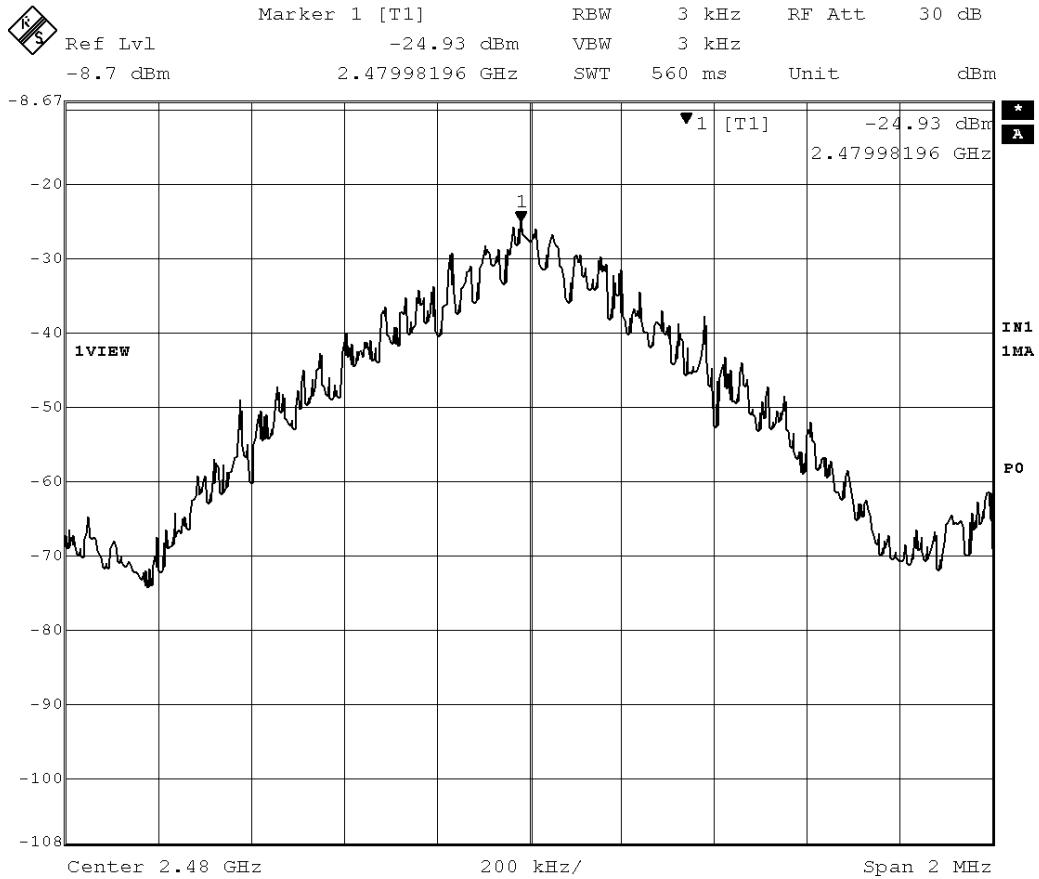

Tested by : M. Takahashi  
 Masanori Takahashi  
 Testing Engineer

### 2.8 Peak Power Density (Radiation)

Note : This test was not applicable.

### 2.9 Spurious Emissions (Conduction)

Date : September 13, 2004  
 Temp.: 22 °C Humi.: 54 %

#### 2.9.1 Band Edge Compliance

Mode of EUT : Hopping (Max. power setting)  
 Test Port : Temporary antenna connector

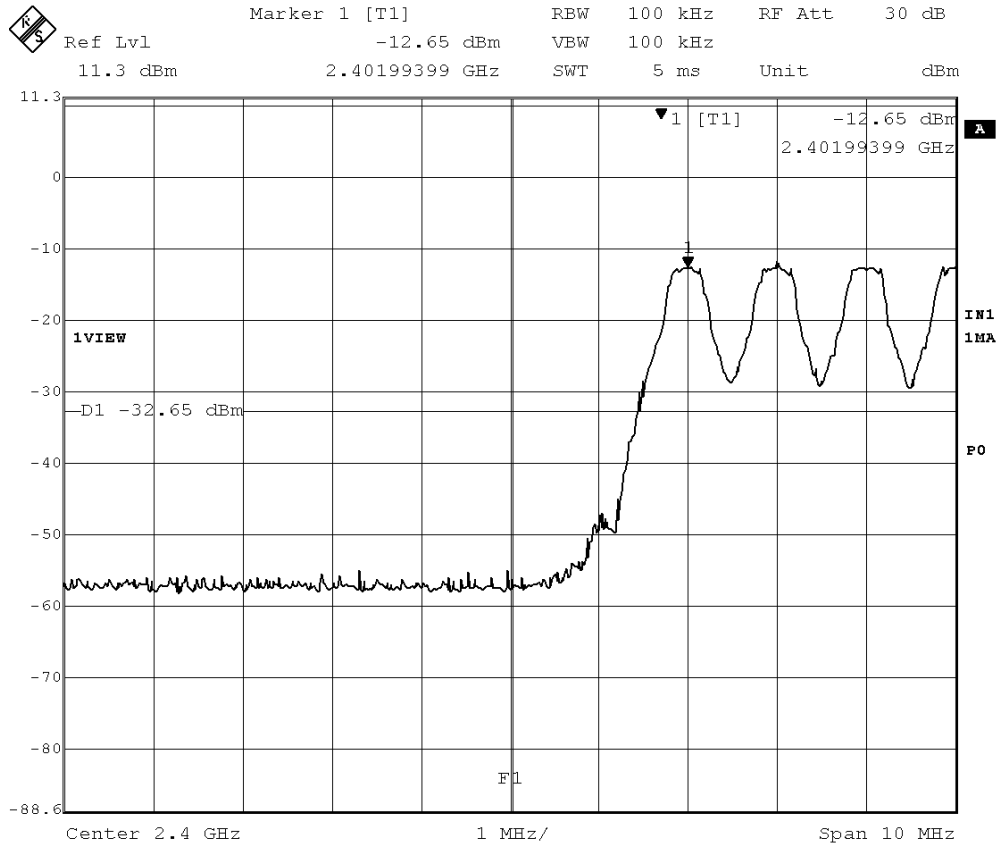

Mode of EUT : Hopping (Max. power setting)

Test Port : Temporary antenna connector

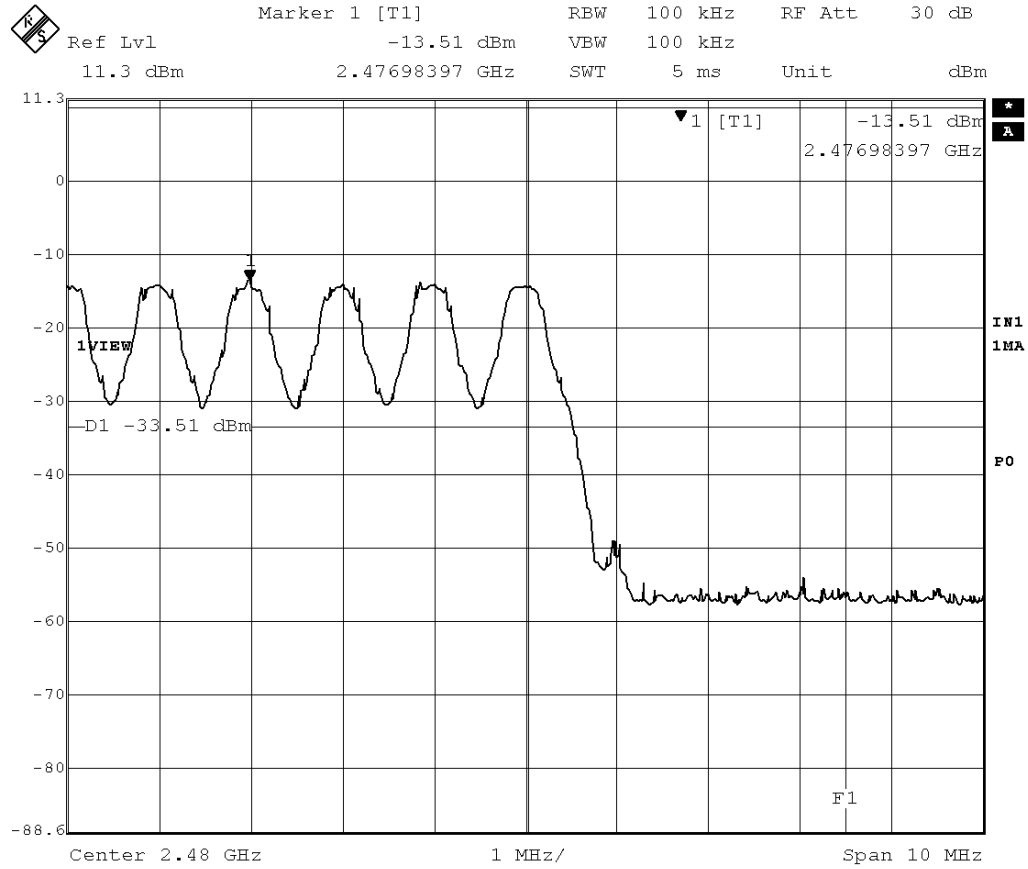

### 2.9.2 Other Spurious Emissions

Mode of EUT : TX (2402 MHz) Max. power setting  
Test Port : Temporary antenna connector

Frequency (MHz)	CableLoss (dB)	Att.Loss (dB)	Meter Reading (dBm)	Emission Levels (dBm)	Reference Level(*1) (dBm)	Limit (dBm)
					-2.96	-22.96

No spurious emissions in the range 20 dB below the limit.

Mode of EUT : TX (2441 MHz) Max. power setting  
Test Port : Temporary antenna connector

Frequency (MHz)	CableLoss (dB)	Att.Loss (dB)	Meter Reading (dBm)	Emission Levels (dBm)	Reference Level(*1) (dBm)	Limit (dBm)
					-2.96	-22.96

No spurious emissions in the range 20 dB below the limit.

Mode of EUT : TX (2480 MHz) Max. power setting  
Test Port : Temporary antenna connector

Frequency (MHz)	CableLoss (dB)	Att.Loss (dB)	Meter Reading (dBm)	Emission Levels (dBm)	Reference Level(*1) (dBm)	Limit (dBm)
					-2.96	-22.96

No spurious emissions in the range 20 dB below the limit.

Note : 1) Reference level is minimum value of all channels.

2) Measuring Instruments Setting :

Detector Function      Resolution Bandwidth  
Peak                      100 kHz

Tested by : M. Takahashi  
Masanori Takahashi  
Testing Engineer

## 2.10 Spurious Emissions (Radiation)

Date : September 28, 2004  
 Temp.: 21 °C Humi.: 52 %

### 2.10.1 Band Edge Compliance

Mode of EUT : Hopping (Max. power setting)  
 Test Port : Enclosure  
 Antenna Polarization : Horizontal

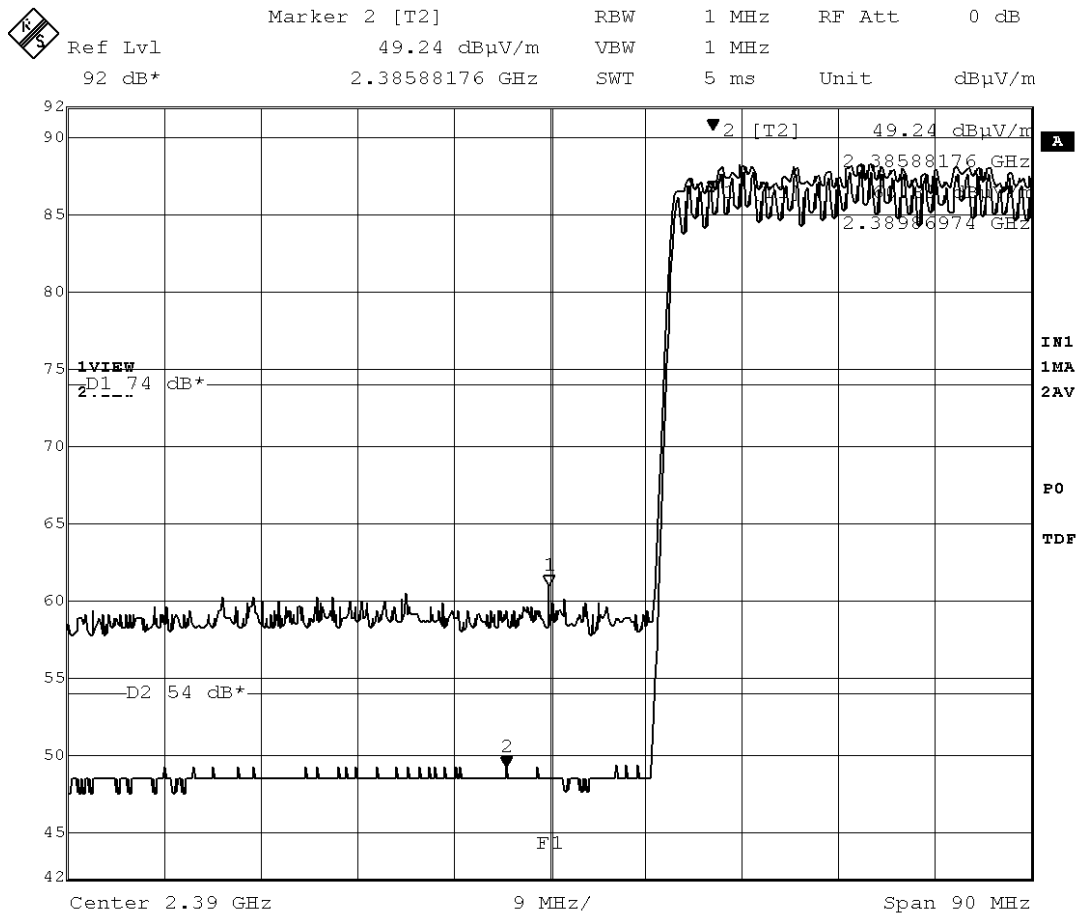

Mode of EUT : Hopping (Max. power setting)

Antenna Polarization : Vertical

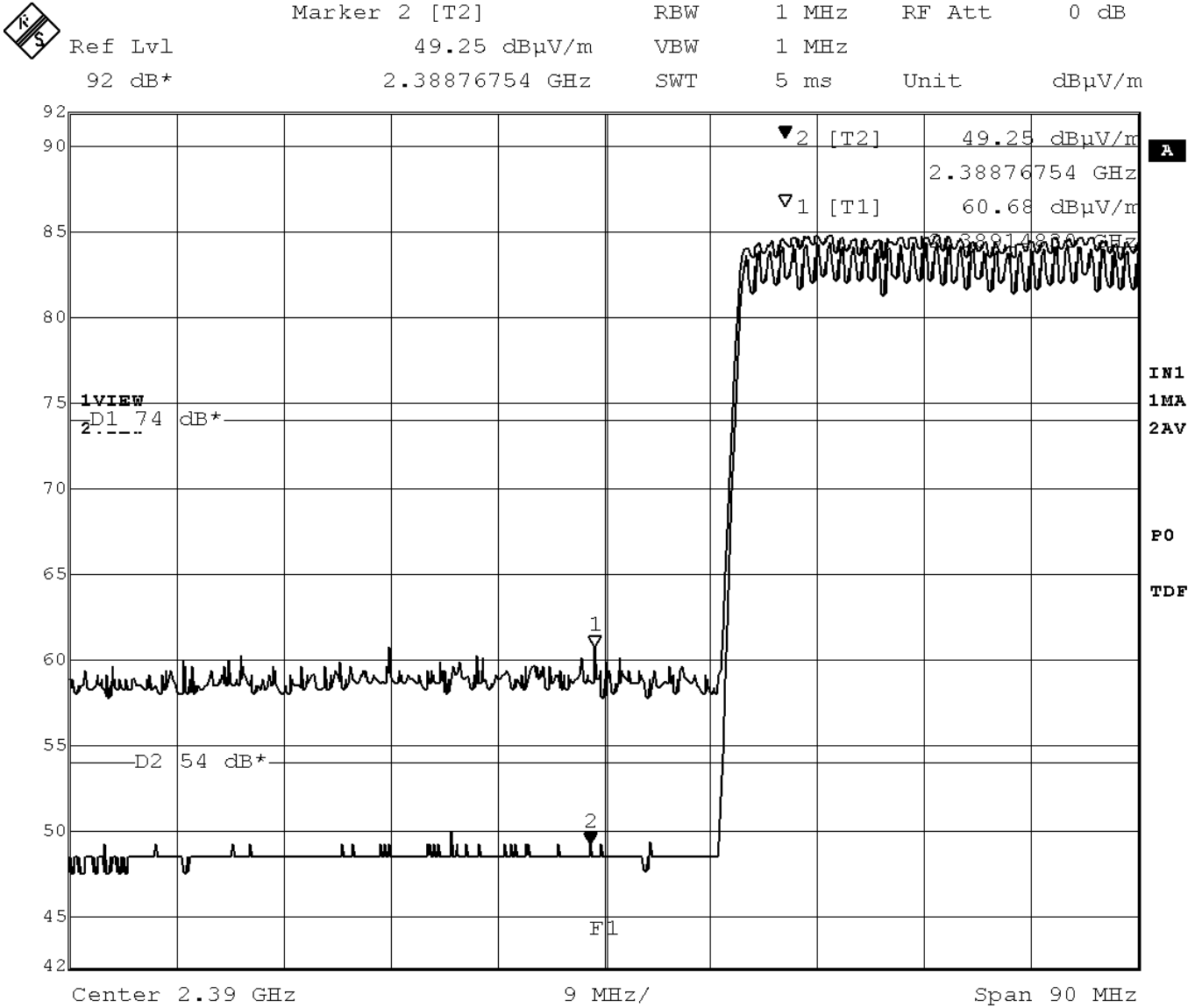



Mode of EUT : Hopping (Max. power setting)

Antenna Polarization : Horizontal

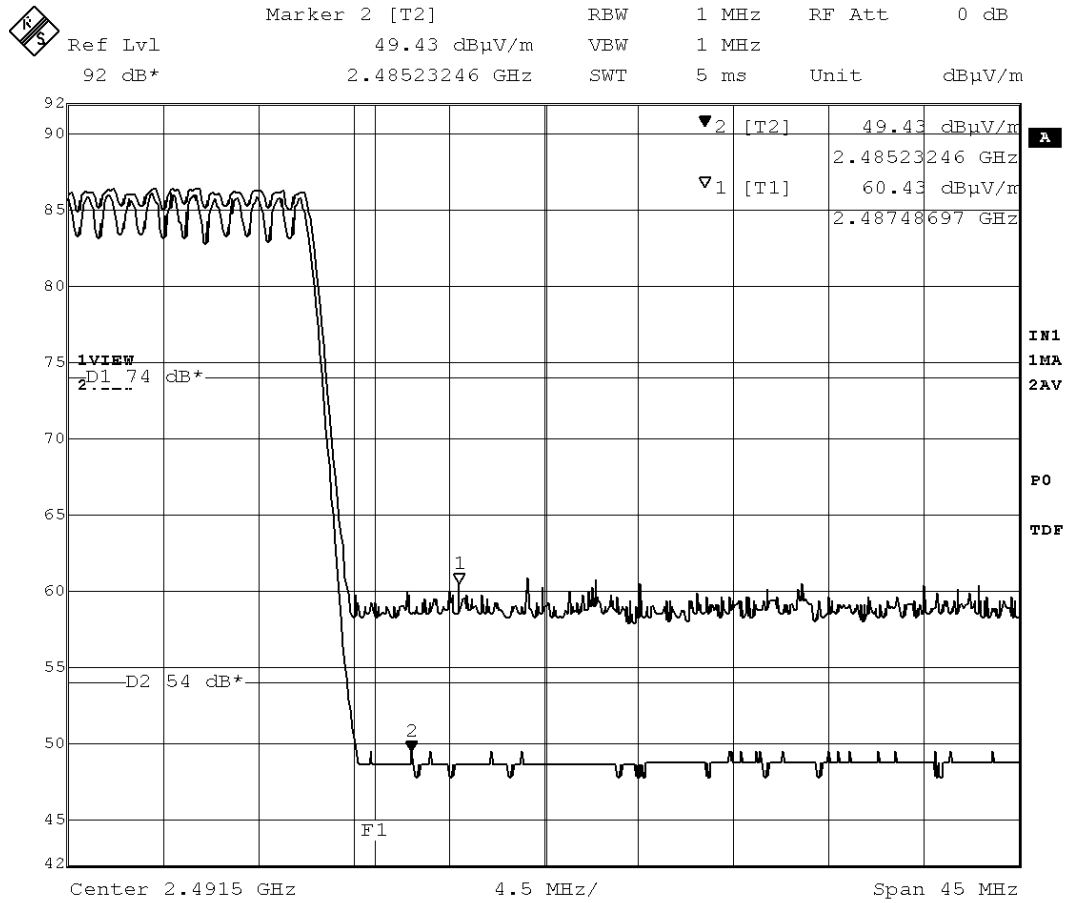

Mode of EUT : Hopping (Max. power setting)

Antenna Polarization : Vertical

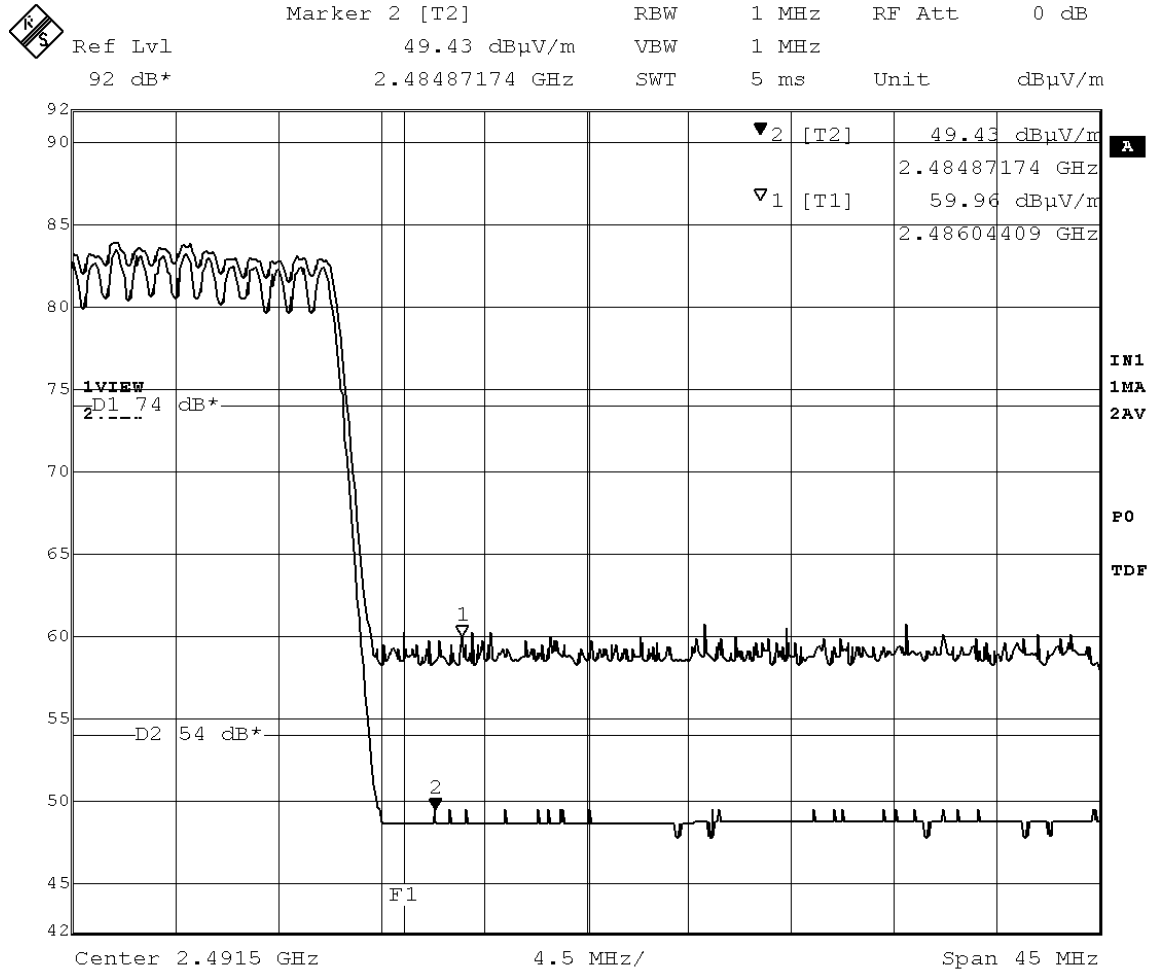



## 2.10.2 Other Spurious Emissions

Test Port : Enclosure

Spurious Emissions in the frequency range from 9 kHz to 30 MHz

Mode of EUT : TX Hopping OFF(2402 MHz/ 2441 MHz/ 2480 MHz Setting)  
(Max. power setting)

"No spurious emissions in the range 20 dB below the limit."

Spurious Emissions in the frequency range from 30 MHz to 1000 MHz

Mode of EUT : TX Hopping OFF(All mode have been investigated and the worst case.)  
(Max. power setting)

"No spurious emissions in the range 20 dB below the limit."

Spurious Emissions in the frequency above 1000 MHz

Mode of EUT : TX Hopping OFF(2402 MHz Setting) Max. power setting

Frequency (GHz)	P-A Factor (dB)	Correction Factor (dB)	Polarization	Meter Reading (dBuV)		Limits (dBuV/m)		Emission Levels (dBuV/m)		Margins (dB)	
				AV	Peak	AV	Peak	AV	Peak	AV	Peak
4.8040	0.0	8.8	H	38.6	45.7	54.0	74.0	47.4	54.5	6.6	19.5
7.2060	0.0	13.3	V	< 28.0	< 41.0	54.0	74.0	< 41.3	< 54.3	> 12.7	> 19.7
9.6080	0.0	16.5	V	< 28.0	< 41.0	54.0	74.0	< 44.5	< 57.5	> 9.5	> 16.5
12.0100	0.0	18.1	V	< 28.0	< 41.0	54.0	74.0	< 46.1	< 59.1	> 7.9	> 14.9

Mode of EUT : TX Hopping OFF(2441 MHz Setting) Max. power setting

Frequency (GHz)	P-A Factor (dB)	Correction Factor (dB)	Polarization	Meter Reading (dBuV)		Limits (dBuV/m)		Emission Levels (dBuV/m)		Margins (dB)	
				AV	Peak	AV	Peak	AV	Peak	AV	Peak
4.8820	0.0	8.9	H	33.4	42.4	54.0	74.0	42.3	51.3	11.7	22.7
7.3230	0.0	13.5	V	< 28.0	< 41.0	54.0	74.0	< 41.5	< 54.5	> 12.5	> 19.5
9.7640	0.0	16.6	V	< 28.0	< 41.0	54.0	74.0	< 44.6	< 57.6	> 9.4	> 16.4
12.2050	0.0	18.3	V	< 28.0	< 41.0	54.0	74.0	< 46.3	< 59.3	> 7.7	> 14.7

Mode of EUT : TX Hopping OFF(2480 MHz Setting) Max. power setting

Frequency (GHz)	P-A Factor (dB)	Correction Factor (dB)	Polarization	Meter Reading (dBuV)		Limits (dBuV/m)		Emission Levels (dBuV/m)		Margins (dB)	
				AV	Peak	AV	Peak	AV	Peak	AV	Peak
4.9600	0.0	9.0	H	34.7	43.2	54.0	74.0	43.7	52.2	10.3	21.8
7.4400	0.0	13.7	V	< 28.0	< 41.0	54.0	74.0	< 41.7	< 54.7	> 12.3	> 19.3
9.9200	0.0	16.7	V	< 28.0	< 41.0	54.0	74.0	< 44.7	< 57.7	> 9.3	> 16.3
12.4000	0.0	18.5	V	< 28.0	< 41.0	54.0	74.0	< 46.5	< 59.5	> 7.5	> 14.5

- Notes :
- 1) The spectrum was checked from 1.0 GHz to 26.5 GHz.
  - 2) The cable loss, amp. gain and antenna factor are included in the correction factor.
  - 3) The symbol of "<" means "or less".
  - 4) The symbol of ">" means "or greater".
  - 5) A sample calculation (Peak) was made at 4.804 (GHz).  
 $PA + Cf + Mr = 0 + 8.8 + 45.7 = 54.5$  (dBuV/m)  
 PA = Peak to Average Factor (P-A Factor)  
 Cf = Correction Factor  
 Mr = Meter Reading
  - 6) Measuring Instrument Setting :

<u>Detector function</u>	<u>Resolution Bandwidth</u>	<u>Video Bandwidth</u>
Average (AV)	1 MHz	10 Hz
Peak	1 MHz	1 MHz

Tested by : 

Masanori Takahashi  
Testing Engineer



### **2.11 AC Power Line Conducted Emissions**

This test is not applicable.

### **2.12 RF Exposure Compliance**

See attached information.



### 2.13 Spurious Emissions for Receiver (Radiation)

Date : September 28, 2004

Temp.: 21 °C Humi.: 52 %

Mode of EUT : RX(Worst Case)

Test Port : Enclosure

Spurious Emissions in the frequency range from 30 MHz to 1000 MHz

Mode of EUT : RX Hopping OFF(All mode have been investigated and the worst case.)

"No spurious emissions in the range 20 dB below the limit."

Spurious Emissions in the frequency above 1000 MHz

Mode of EUT : RX Hopping OFF(2402 MHz Setting)

Frequency (GHz)	P-A Factor (dB)	Correction Factor (dB)	Polarization	Meter Reading (dBuV)		Limits (dBuV/m)		Emission Levels (dBuV/m)		Margins (dB)	
				AV	Peak	AV	Peak	AV	Peak	AV	Peak
1.2002	0.0	-4.8	H	43.8	48.6	54.0	74.0	39.0	43.8	15.0	30.2
2.4004	0.0	2.2	H	46.5	49.2	54.0	74.0	48.7	51.4	5.3	22.6
3.6006	0.0	6.1	H	< 28.0	< 41.0	54.0	74.0	< 34.1	< 47.1	> 19.9	> 26.9

Mode of EUT : RX Hopping OFF(2441 MHz Setting)

Frequency (GHz)	P-A Factor (dB)	Correction Factor (dB)	Polarization	Meter Reading (dBuV)		Limits (dBuV/m)		Emission Levels (dBuV/m)		Margins (dB)	
				AV	Peak	AV	Peak	AV	Peak	AV	Peak
1.2198	0.0	-4.6	H	45.1	48.1	54.0	74.0	40.5	43.5	13.5	30.5
2.4396	0.0	2.3	H	45.6	48.3	54.0	74.0	47.9	50.6	6.1	23.4
3.6594	0.0	6.2	H	< 28.0	< 41.0	54.0	74.0	< 34.2	< 47.2	> 19.8	> 26.8

Mode of EUT : RX Hopping OFF(2480 MHz Setting)

Frequency (GHz)	P-A Factor (dB)	Correction Factor (dB)	Polarization	Meter Reading (dBuV)		Limits (dBuV/m)		Emission Levels (dBuV/m)		Margins (dB)	
				AV	Peak	AV	Peak	AV	Peak	AV	Peak
1.2392	0.0	-4.5	H	44.1	48.1	54.0	74.0	39.6	43.6	14.4	30.4
2.4784	0.0	2.3	H	43.4	47.1	54.0	74.0	45.7	49.4	8.3	24.6
3.7176	0.0	6.3	H	< 28.0	< 41.0	54.0	74.0	< 34.3	< 47.3	> 19.7	> 26.7

- Notes : 1) The spectrum was checked from 1.0 GHz to 12.5 GHz.  
 2) The cable loss, amp. gain and antenna factor are included

in the correction factor.

3) The symbol of "<"means "or less".

4) The symbol of ">"means "or greater".

5) A sample calculation(Peak) was made at 1.2002 (GHz).

$$PA + Cf + Mr = 0 + -4.8 + 48.6 = 43.8 \text{ (dBuV/m)}$$

PA = Peak to Average Factor(P-A Factor)

Cf = Correction Factor

Mr = Meter Reading

6) Measuring Instrument Setting :

	<u>Detector function</u>	<u>Resolution Bandwidth</u>	<u>Video Bandwidth</u>
Average (AV)		1 MHz	10 Hz
Peak		1 MHz	1 MHz

Tested by : M. Takahashi  
 Masanori Takahashi  
 Testing Engineer



JQA Application No. :400-40471

FCC ID: SJ21200U IC: 5427A-1200U

Model No. :CCA-1200U / GCA-1200U

Issue Date :November 16, 2004

Standard

:CFR 47 FCC Rules Part 15

Page 56 of 59

---

# Appendix

## Test Instruments List

September 7, 2004





### Test Receivers

No.	Type	Model	Manufacturer	Serial	ID	Last Cal.	Interval
TR01	Test Receiver	ESH2	Rohde & Schwarz	880370/016	119-01-503E0	May 2004	1 Year
TR02	Test Receiver	ESH3	Rohde & Schwarz	881460/030	119-01-023E0	May 2004	1 Year
TR03	Test Receiver	ESHS10	Rohde & Schwarz	835871/004	119-01-505E0	May 2004	1 Year
TR04	Test Receiver	ESV	Rohde & Schwarz	872148/039	119-03-008E0	May 2004	1 Year
TR05	Test Receiver	ESVS10	Rohde & Schwarz	826148/002	119-03-504E0	May 2004	1 Year
TR06	Test Receiver	ESVS10	Rohde & Schwarz	832699/001	119-03-506E0	May 2004	1 Year
TR07	Test Receiver	ESI26	Rohde & Schwarz	100043	119-04-511E0	Aug. 2004	1 Year

### Spectrum Analyzers

No.	Type	Model	Manufacturer	Serial	ID	Last Cal.	Interval
SA01	Spectrum Analyzer	8560E	Hewlett Packard	3240A00189	122-02-504E0	Oct. 2003	1 Year
SA02	Spectrum Analyzer	8566B	Hewlett Packard	2140A01091	122-02-501E0	Oct. 2003	1 Year
SA03	RF Pre-selector	85685A	Hewlett Packard	2648A00522	122-02-503E0	Oct. 2003	1 Year
SA04	Spectrum Analyzer	8566B	Hewlett Packard	2747A05855	122-02-517E0	Apr. 2004	1 Year
SA05	RF Pre-selector	85685A	Hewlett Packard	2901A00933	122-02-519E0	Apr. 2004	1 Year
SA06	Spectrum Analyzer	R3132	ADVANTEST	120500072	122-02-520E0	Sep. 2004	1 Year
SA07	Spectrum Analyzer	R3182	ADVANTEST	120600581	122-02-521E0	Mar. 2004	1 Year

### Antennas

No.	Type	Model	Manufacturer	Serial	ID	Last Cal.	Interval
AN01	Loop Antenna	HFH2-Z2	Rohde & Schwarz	881058/61	119-05-036E0	May. 2004	1 Year
AN02	Dipole Antenna	KBA-511	Kyoritsu	0-170-1	119-05-506E0	Nov. 2003	1 Year
AN03	Dipole Antenna	KBA-511A	Kyoritsu	0-201-13	119-05-504E0	Nov. 2003	1 Year
AN04	Dipole Antenna	KBA-611	Kyoritsu	0-147-14	119-05-507E0	Nov. 2003	1 Year
AN05	Dipole Antenna	KBA-611	Kyoritsu	0-210-5	119-05-505E0	Nov. 2003	1 Year
AN06	Biconical Antenna	BBA9106	Schwarzbeck	VHA91031150	119-05-111E0	Nov. 2003	1 Year
AN07	Biconical Antenna	BBA9106	Schwarzbeck	-	119-05-078E0	Nov. 2003	1 Year
AN08	Log-peri. Antenna	UHALP9107	Schwarzbeck	-	119-05-079E0	Nov. 2003	1 Year
AN09	Log-peri. Antenna	UHALP9107	Schwarzbeck	-	119-05-110E0	Nov. 2003	1 Year
AN10	Log-peri. Antenna	HL025	Rohde & Schwarz	340182/015	119-05-100E0	Jan. 2004	1 Year
AN11	Horn Antenna	3115	EMC Test Systems	6442	119-05-514E0	Jan. 2004	1 Year
AN12	Horn Antenna	3116	EMC Test Systems	2547	119-05-515E0	May 2003	2 Year

### Networks

No.	Type	Model	Manufacturer	Serial	ID	Last Cal.	Interval
NE01	LISN	KNW-407	Kyoritsu	8-833-6	149-04-052E0	Apr. 2004	1 Year
NE02	LISN	KNW-407	Kyoritsu	8-855-2	149-04-055E0	Apr. 2004	1 Year
NE03	LISN	KNW-407	Kyoritsu	8-1130-6	149-04-062E0	Apr. 2004	1 Year
NE04	LISN	KNW-242C	Kyoritsu	8-837-13	149-04-054E0	Apr. 2004	1 Year
NE05	Absorbing Clamp	MDS21	Luthi	03293	119-06-506E0	Aug. 2004	1 Year

### Cables

No.	Type	Model	Manufacturer	Serial	ID	Last Cal.	Interval
CA01	RF Cable	5D-2W	Fujikura	-	155-21-001E0	Feb. 2004	1 Year
CA02	RF Cable	5D-2W	Fujikura	-	155-21-002E0	Feb. 2004	1 Year
CA03	RF Cable	3D-2W	Fujikura	-	155-21-005E0	Apr. 2004	1 Year
CA04	RF Cable	3D-2W	Fujikura	-	155-21-006E0	Apr. 2004	1 Year
CA05	RF Cable	3D-2W	Fujikura	-	155-21-007E0	Apr. 2004	1 Year
CA06	RF Cable	RG213/U	Rohde & Schwarz	-	155-21-010E0	Apr. 2004	1 Year
CA07	RF Cable (10m)	S 04272B	Suhner	-	155-21-011E0	May 2004	1 Year
CA08	RF Cable (2m 18GHz)	SUCOFLEX 104	Suhner	-	155-21-012E0	May 2004	1 Year
CA09	RF Cable (1m 18GHz)	SUCOFLEX 104	Suhner	-	155-21-013E0	May 2004	1 Year
CA10	RF Cable (1m N)	S 04272B	Suhner	-	155-21-015E0	May 2004	1 Year
CA11	RF Cable (1m 26GHz)	SUCOFLEX 104	Suhner	182811/4	155-21-016E0	Dec. 2003	1 Year
CA12	RF Cable (4m 26GHz)	SUCOFLEX 104	Suhner	190630	155-21-017E0	Dec. 2003	1 Year
CA13	RF Cable (10m)	F130-S1S1-394	MEGA PHASE	10510	155-21-018E0	Dec. 2003	1 Year
CA14	RF Cable (7m)	3D-2W	Fujikura	-	155-21-009E0	Apr. 2004	1 Year
CA15	RF Cable (7m)	RG223/U	Suhner	-	155-21-021E0	May 2004	1 Year

### Amplifiers

No.	Type	Model	Manufacturer	Serial	ID	Last Cal.	Interval
AM01	AF Amplifier	P-500L	Accuphase	BOY806	127-01-501E0	Feb. 2004	1 Year
AM02	RF Amplifier	8447D	Hewlett Packard	1937A02168	127-01-065E0	May 2004	1 Year
AM03	RF Amplifier	8447D	Hewlett Packard	2944A07289	127-01-509E0	May 2004	1 Year
AM05	RF Amplifier	DBP-0102N533	DBS Microwave	012	127-02-504E0	Jun. 2004	1 Year
AM06	RF Amplifier	WJ-6882-814	Watkins-Johnson	0414	127-04-017E0	Jun. 2004	1 Year
AM07	RF Amplifier	WJ-5315-556	Watkins-Johnson	106	127-04-006E0	Jun. 2004	1 Year
AM08	RF Amplifier	WJ-5320-307	Watkins-Johnson	645	127-04-005E0	Jun. 2004	1 Year
AM09	RF Amplifier	JS4-00102600 -28-5A	MITEQ	669167	127-04-502E0	Apr. 2004	1 Year



### Signal Generators

No.	Type	Model	Manufacturer	Serial	ID	Last Cal.	Interval
SG01	Function Generator	3325B	Hewlett Packard	2847A03284	118-08-124E0	Jul. 2004	1 Year
SG02	Function Generator	VP-7422A	Matsushita Communication	050351E122	118-08-503E0	Jul. 2004	1 Year
SG03	Signal Generator	8664A	Hewlett Packard	3035A00140	118-03-014E0	Jun. 2004	1 Year
SG04	Signal Generator	8664A	Hewlett Packard	3438A00756	118-04-502E0	Jun. 2004	1 Year
SG05	Signal Generator	6061A	Gigatronics	5130593	118-04-024E0	Mar. 2004	1 Year

### Auxiliary Equipment

No.	Type	Model	Manufacturer	Serial	ID	Last Cal.	Interval
AU01	Termination(50)	-	Suhner	-	154-06-501E0	Jan. 2004	1 Year
AU02	Termination(50)	-	Suhner	-	154-06-502E0	Jan. 2004	1 Year
AU03	Power Meter	436A	Hewlett Packard	1725A01930	100-02-501E0	Apr. 2004	1 Year
AU04	Power Sensor	8482A	Hewlett Packard	1551A01013	100-02-501E0	Apr. 2004	1 Year
AU05	Power Sensor	8485A	Hewlett Packard	2942A08969	100-04-021E0	Apr. 2004	1 Year
AU06	FM Linear Detector	MS61A	Anritsu	M77486	123-02-008E0	Oct. 2003	1 Year
AU07	Level Meter	ML422C	Anritsu	M87571	114-02-501E0	Jun. 2004	1 Year
AU08	Measuring Amplifier	2636	B & K	1614851	082-01-502E0	May 2004	1 Year
AU09	Microphone	4134	B & K	1269477	147-01-503E0	May 2004	1 Year
AU10	Preamplifier	2639	B & K	1268763	127-01-504E0	May 2004	1 Year
AU11	Pistonphone	4220	B & K	1165008	147-02-501E0	Mar. 2004	1 Year
AU12	Artificial Mouth	4227	B & K	1274869	-	N/A	N/A
AU13	Frequency Counter	53131A	Hewlett Packard	3546A11807	102-02-075E0	May 2004	1 Year
AU14	Oven	-	Ohnishi	-	023-02-018E0	May 2004	1 Year
AU15	DC Power Supply	6628A	Hewlett Packard	3224A00284	072-05-503E0	Jun. 2004	1 Year
AU16	Band Reject Filter	BRM12294	Micro-tronics	003	149-01-501E0	Jan. 2004	1 Year
AU17	High Pass Filter	F-100-4000-5-R	RLC Electronics	0149	149-01-502E0	Feb. 2004	1 Year
AU18	Attenuator	43KC-10	Anritsu	-	148-03-506E0	Feb. 2004	1 Year
AU19	Attenuator	43KC-20	Anritsu	-	148-03-507E0	Feb. 2004	1 Year
AU20	Attenuator	355D	Hewlett Packard	219-10782	148-03-065E0	Apr. 2004	1 Year
AU21	FFT Analyzer	R9211C	Advantest	02020253	122-02-506E0	Jun. 2004	1 Year
AU22	Noise Meter	MN-446	Meguro	53030478	082-01-144E0	Apr. 2004	1 Year