

## FCC REPORT

**Applicant:** MegaGain International Ltd.

**Address of Applicant:** Rm 1908, Greenfield Tower, Concordia Plaza, 1 Science Museum Road, T.S.T. East. Kowloon Hong Kong China

**Equipment Under Test (EUT)**

Product Name: CARS 6" MCQUEEN RC-ALT

Model No.: 1501-COL00907

**FCC ID:** SIP-3239-W

**Applicable standards:** FCC CFR Title 47 Part 15 Subpart C Section 15.227:2014

**Date of sample receipt:** June 10, 2015

**Date of Test:** June 10-16, 2015

**Date of report issued:** June 16, 2015

**Test Result :** PASS \*

\* In the configuration tested, the EUT complied with the standards specified above.

Authorized Signature:

A circular blue stamp with the text "GLOBAL UNITED TECHNOLOGY SERVICES CO." around the perimeter and "GTS" in the center. Overlaid on the stamp is a handwritten signature in black ink.

**Robinson Lo**

**Laboratory Manager**

This report details the results of the testing carried out on one sample. The results contained in this test report do not relate to other samples of the same product and does not permit the use of the GTS product certification mark. The manufacturer should ensure that all products in series production are in conformity with the product sample detailed in this report.

This report may only be reproduced and distributed in full. If the product in this report is used in any configuration other than that detailed in the report, the manufacturer must ensure the new system complies with all relevant standards. Any mention of GTS or testing done by GTS in connection with, distribution or use of the product described in this report must be approved by GTS in writing.

This document cannot be reproduced except in full, without prior written approval of the Company. Any unauthorized alteration, forgery or falsification of the content or appearance of this document is unlawful and offenders may be prosecuted to the fullest extent of the law. Unless otherwise stated the results shown in this test report refer only to the sample(s) tested and such sample(s) are retained for 90 days only.

## 2 Version

Version No.	Date	Description
00	June 16, 2015	Original

**Prepared By:** Sam. Gao **Date:** June 16, 2015  
**Project Engineer**

**Check By:** hank. yan **Date:** June 16, 2015  
**Reviewer**

## 3 Contents

	Page
1 COVER PAGE.....	1
2 VERSION.....	2
3 CONTENTS.....	3
4 TEST SUMMARY.....	4
4.1 MEASUREMENT UNCERTAINTY.....	4
5 GENERAL INFORMATION.....	5
5.1 CLIENT INFORMATION.....	5
5.2 GENERAL DESCRIPTION OF EUT.....	5
5.3 TEST MODE.....	6
5.4 DESCRIPTION OF SUPPORT UNITS.....	6
5.5 TEST FACILITY.....	6
5.6 TEST LOCATION.....	6
5.7 OTHER INFORMATION REQUESTED BY THE CUSTOMER.....	6
6 TEST INSTRUMENTS LIST.....	7
7 TEST RESULTS AND MEASUREMENT DATA.....	8
7.1 ANTENNA REQUIREMENT.....	8
7.2 RADIATED EMISSION.....	9
7.3 20dB OCCUPY BANDWIDTH.....	13
8 TEST SETUP PHOTO.....	14
9 EUT CONSTRUCTIONAL DETAILS.....	15

## 4 Test Summary

Test Item	Section in CFR 47	Result
Antenna requirement	15.203	Pass
AC Power Line Conducted Emission	15.207	N/A
Radiated emission	15.227 & 15.209	Pass
20dB Occupied Bandwidth	15.215 (c)	Pass

*Pass: The EUT complies with the essential requirements in the standard.*

*N/A: Not applicable*

### 4.1 Measurement Uncertainty

Test Item	Frequency Range	Measurement Uncertainty	Notes
Radiated Emission	9kHz ~ 30MHz	± 4.34dB	(1)
Radiated Emission	30MHz ~ 1000MHz	± 4.24dB	(1)
Radiated Emission	1GHz ~ 26.5GHz	± 4.68dB	(1)
AC Power Line Conducted Emission	0.15MHz ~ 30MHz	± 3.45dB	(1)

Note (1): The measurement uncertainty is for coverage factor of k=2 and a level of confidence of 95%.

## 5 General Information

### 5.1 Client Information

Applicant:	MegaGain International Ltd.
Address of Applicant:	Rm 1908, Greenfield Tower, Concordia Plaza, 1 Science Museum Road, T.S.T. East. Kowloon Hong Kong China
Manufacturer/Factory:	Yiu Yi Plastic & Mould (Shenzhen) Co., Ltd.
Address of Manufacturer/Factory:	No.22, Xitou Road, Second Industrial Zone, Xitou, Songgang Town, Bao'an District, Shenzhen

### 5.2 General Description of EUT

Product Name:	CARS 6" MCQUEEN RC-ALT
Model No.:	1501-COL00907
Operation Frequency:	27.145MHz
Modulation type:	AM
Antenna Type:	Integral antenna
Antenna gain:	0dBi (declare by Applicant)
Power supply:	DC 9V

### 5.3 Test mode

Transmitting mode	Keep the EUT in continuously transmitting mode
<i>Remark: During the test, the new battery was used.</i>	

#### Per-test mode.

We have verified the construction and function in typical operation, The EUT was placed on three different polar directions; i.e. X axis, Y axis, Z axis. which was shown in this test report and defined as follows:

Axis	X	Y	Z
Field Strength(dBuV/m)	52.13	58.62	54.67

#### Final Test Mode:

According to ANSI C63.4 standards, the test results is at "worst setup":

Y axis (see the test setup photo)

### 5.4 Description of Support Units

None

### 5.5 Test Facility

The test facility is recognized, certified, or accredited by the following organizations:

- **CNAS —Registration No.: CNAS L5775**

CNAS has accredited Global United Technology Services Co., Ltd. To ISO/IEC 17025 General Requirements for the competence of testing and calibration laboratories (CNAS-CL01 Accreditation Criteria for the Competence of Testing and Calibration Laboratories) for the competence in the field of testing.

- **FCC —Registration No.: 600491**

Global United Technology Services Co., Ltd., Shenzhen EMC Laboratory has been registered and fully described in a report filed with the (FCC) Federal Communications Commission. The acceptance letter from the FCC is maintained in files. Registration 600491, June 28, 2013.

- **Industry Canada (IC) —Registration No.: 9079A-2**

The 3m Semi-anechoic chamber of Global United Technology Services Co., Ltd. has been registered by Certification and Engineering Bureau of Industry Canada for radio equipment testing with Registration No.: 9079A-2, June 26, 2013.

### 5.6 Test Location

All tests were performed at:

Global United Technology Services Co., Ltd.

Room 301-309, 3th Floor, Block A, Huafeng Jinyuan Business Building, No. 300 Laodong Industrial Zone, Xixiang Road, Baoan District, Shenzhen, China

Tel: 0755-27798480

Fax: 0755-27798960

### 5.7 Other Information Requested by the Customer

None.

## 6 Test Instruments list

Radiated Emission:						
Item	Test Equipment	Manufacturer	Model No.	Inventory No.	Cal.Date (mm-dd-yy)	Cal.Due date (mm-dd-yy)
1	3m Semi- Anechoic Chamber	ZhongYu Electron	9.2(L)*6.2(W)* 6.4(H)	GTS250	Mar. 28 2015	Mar. 27 2016
2	Control Room	ZhongYu Electron	6.2(L)*2.5(W)* 2.4(H)	GTS251	N/A	N/A
3	Spectrum Analyzer	Agilent	E4440A	GTS533	Jul. 01 2014	Jun 30 2015
4	EMI Test Receiver	Rohde & Schwarz	ESU26	GTS203	Jul. 01 2014	Jun 30 2015
5	Loop Antenna	ZHINAN	ZN30900A	GTS534	Feb. 22 2015	Feb. 21 2016
6	BiConiLog Antenna	SCHWARZBECK MESS- ELEKTRONIK	VULB9163	GTS214	Jul. 01 2014	Jun 30 2015
7	Double -ridged waveguide horn	SCHWARZBECK MESS- ELEKTRONIK	9120D-829	GTS208	June 27 2014	June 26 2015
8	Horn Antenna	ETS-LINDGREN	3160	GTS217	Mar. 27 2015	Mar. 26 2016
9	EMI Test Software	AUDIX	E3	N/A	N/A	N/A
10	Coaxial Cable	GTS	N/A	GTS213	Mar. 28 2015	Mar. 27 2016
11	Coaxial Cable	GTS	N/A	GTS211	Mar. 28 2015	Mar. 27 2016
12	Coaxial cable	GTS	N/A	GTS210	Mar. 28 2015	Mar. 27 2016
13	Coaxial Cable	GTS	N/A	GTS212	Mar. 28 2015	Mar. 27 2016
14	Amplifier(100kHz-3GHz)	HP	8347A	GTS204	Jul. 01 2014	Jun. 30, 2015
15	Amplifier(2GHz-20GHz)	HP	8349B	GTS206	Jul. 01 2014	Jun. 30, 2015
16	Amplifier (18-26GHz)	Rohde & Schwarz	AFS33-18002 650-30-8P-44	GTS218	June 27 2014	June 26 2015
17	Band filter	Amindeon	82346	GTS219	Mar. 28 2015	Mar. 27 2016

General used equipment:						
Item	Test Equipment	Manufacturer	Model No.	Inventory No.	Cal.Date (mm-dd-yy)	Cal.Due date (mm-dd-yy)
1	Barometer	ChangChun	DYM3	GTS257	July 08 2014	July 07 2015

## 7 Test results and Measurement Data

### 7.1 Antenna requirement

<b>Standard requirement:</b>	FCC Part15 C Section 15.203
<p><b>15.203 requirement:</b></p> <p>An intentional radiator shall be designed to ensure that no antenna other than that furnished by the responsible party shall be used with the device. The use of a permanently attached antenna or of an antenna that uses a unique coupling to the intentional radiator, the manufacturer may design the unit so that a broken antenna can be replaced by the user, but the use of a standard antenna jack or electrical connector is prohibited.</p>	
<b>EUT Antenna:</b>	
<p><i>The antenna is integral antenna, the best case gain of the antenna is 0dBi.</i></p> 	

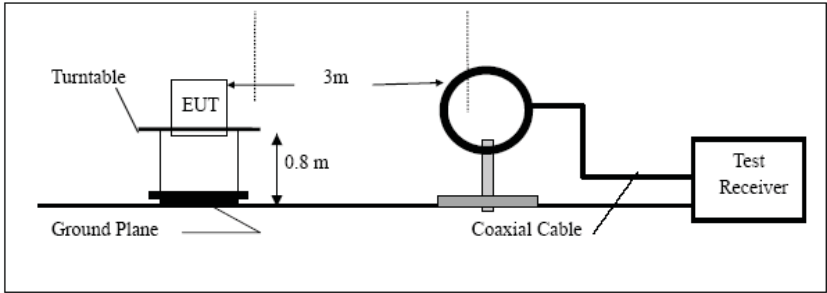

## 7.2 Radiated Emission

Test Requirement:	FCC Part15 C Section 15.209				
Test Method:	ANSI C63.4:2009				
Test Frequency Range:	9kHz to 1GHz				
Test site:	Measurement Distance: 3m				
Receiver setup:	Frequency	Detector	RBW	VBW	Value
	9KHz-150KHz	Quasi-peak	200Hz	600Hz	Quasi-peak
	150KHz-30MHz	Quasi-peak	9KHz	30KHz	Quasi-peak
	30MHz-1GHz	Quasi-peak	100KHz	300KHz	Quasi-peak
	Above 1GHz	Peak	1MHz	3MHz	Peak
Peak		1MHz	10Hz	Average	
Limit: (Field strength of the fundamental signal)	Frequency	Limit (dBuV/m @3m)		Remark	
	26.96MHz ~ 27.28MHz	80.00		Average Value	
		100.00		Peak Value	
Limit: (Spurious Emissions)	Frequency	Limit (uV/m)	Value	Measurement Distance	
	0.009MHz-1.705MHz	2400/F(KHz)	QP	300m	
	0.490MHz-1.705MHz	24000/F(KHz)	QP	300m	
	1.705MHz-30MHz	30	QP	30m	
	30MHz-88MHz	100	QP	3m	
	88MHz-216MHz	150	QP		
	216MHz-960MHz	200	QP		
	960MHz-1GHz	500	QP		
	Above 1GHz	500	Average		
		5000	Peak		
Limit: (band edge)	Emissions radiated outside of the specified frequency bands, except for harmonics, shall be attenuated by at least 50 dB below the level of the fundamental or to the general radiated emission limits in Section 15.209, whichever is the lesser attenuation.				
Test setup:	<p>Below 30MHz</p>  <p>Below 1GHz</p>				

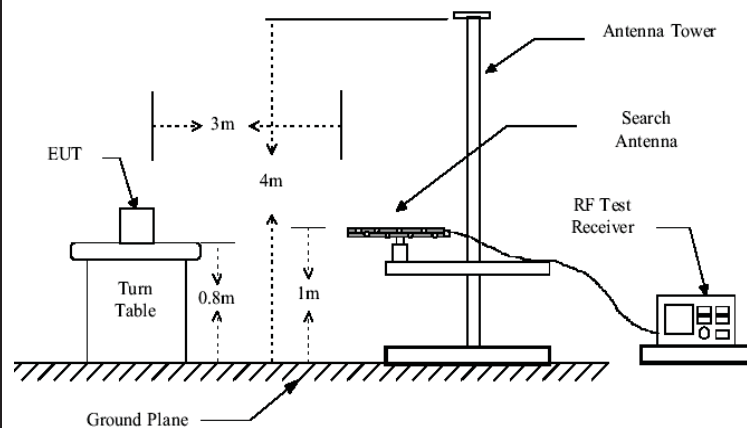

Above 1GHz

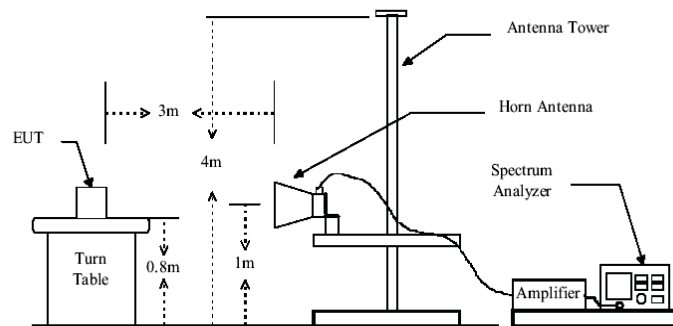

**Test Procedure:**

1. The EUT was placed on the top of a rotating table 0.8 meters above the ground at a 3 meter camber. The table was rotated 360 degrees to determine the position of the highest radiation.
2. The EUT was set 3 meters away from the interference-receiving antenna, which was mounted on the top of a variable-height antenna tower.
3. The antenna height is varied from one meter to four meters above the ground to determine the maximum value of the field strength. Both horizontal and vertical polarizations of the antenna are set to make the measurement.
4. For each suspected emission, the EUT was arranged to its worst case and then the antenna was tuned to heights from 1 meter to 4 meters and the rota table was turned from 0 degrees to 360 degrees to find the maximum reading.
5. The test-receiver system was set to Peak Detect Function and Specified Bandwidth with Maximum Hold Mode.
6. If the emission level of the EUT in peak mode was 10dB lower than the limit specified, then testing could be stopped and the peak values of the EUT would be reported. Otherwise the emissions that did not have 10dB margin would be re-tested one by one using peak, quasi-peak or average method as specified and then reported in a data sheet.
7. For the radiated emission test above 1GHz:  
Place the measurement antenna away from each area of the EUT determined to be a source of emissions at the specified measurement distance, while keeping the measurement antenna aimed at the source of emissions at each frequency of significant emissions, with

	<p>polarization oriented for maximum response. The measurement antenna may have to be higher or lower than the EUT, depending on the radiation pattern of the emission and staying aimed at the emission source for receiving the maximum signal. The final measurement antenna elevation shall be that which maximizes the emissions. The measurement antenna elevation for maximum emissions shall be restricted to a range of heights of from 1 m to 4 m above the ground or reference ground plane.</p> <p>For the test above 1GHz, when radiated measurements are made at the measurement distance and the measurement antenna does not completely encompass a large EUT at that distance, additional measurements at a greater distance may be necessary to demonstrate that emissions were at maximum at the limit distance.</p>
Test Instruments:	Refer to section 6.0 for details
Test mode:	Refer to section 5.3 for details
Test results:	Pass

**Measurement data:**

**Note: Limit dBuV/m @3m = Limit dBuV/m @300m+ 80**

**Limit dBuV/m @3m = Limit dBuV/m @30m + 40**

**Below 30MHz**

Frequency (MHz)	Read Level (dBuV)	Antenna Factor (dB/m)	Cable Loss (dB)	Preamplifier Factor (dB)	Level (dBuV/m)	Limit @3m (dBuV/m)	Over Limit (dB)	ANT. Polarization	Detector
26.96	6.94	27.12	0.55	0.00	34.61	69.50	-34.89	Vertical	QP
27.145	30.88	27.12	0.55	0.00	58.55	80.00	-21.45	Vertical	Ave.
27.145	30.95	27.12	0.55	0.00	58.62	100.00	-41.38	Vertical	Peak
27.28	5.42	27.12	0.55	0.00	33.09	69.50	-36.41	Vertical	QP
26.96	-1.16	27.12	0.55	0.00	26.51	69.50	-42.99	Horizontal	QP
27.145	28.30	27.12	0.55	0.00	55.97	80.00	-24.03	Horizontal	Ave.
27.145	28.44	27.12	0.55	0.00	56.11	100.00	-43.89	Horizontal	Peak
27.28	-5.23	27.12	0.55	0.00	22.44	69.50	-47.06	Horizontal	QP

*Remark:*

1. *Final Level = Receiver Read level + Antenna Factor + Cable Loss – Preamplifier Factor*
2. *The emission levels of other frequencies are very lower than the limit and not show in test report.*

**30MHz ~ 1000MHz (Quasi-peak value):**

Frequency (MHz)	Read Level (dBuV)	Antenna Factor (dB/m)	Cable Loss (dB)	Preamplifier Factor (dB)	Level (dBuV/m)	Limit Line (dBuV/m)	Over Limit (dB)	polarization
51.52	30.52	15.19	0.79	29.99	16.51	40.00	-23.49	Vertical
54.25	39.58	15.05	0.81	29.97	25.47	40.00	-14.53	Vertical
96.45	32.05	14.94	1.16	29.72	18.43	43.50	-25.07	Vertical
104.22	29.48	14.78	1.23	29.67	15.82	43.50	-27.68	Vertical
127.19	31.87	11.32	1.41	29.53	15.07	43.50	-28.43	Vertical
143.65	38.66	10.22	1.53	29.44	20.97	43.50	-22.53	Vertical
41.59	25.78	15.57	0.68	30.04	11.99	40.00	-28.01	Horizontal
54.25	33.33	15.05	0.81	29.97	19.22	40.00	-20.78	Horizontal
98.61	25.47	15.06	1.18	29.71	12.00	43.50	-31.50	Horizontal
190.14	26.88	12.56	1.79	29.24	11.99	43.50	-31.51	Horizontal
465.99	25.16	17.71	3.16	29.36	16.67	46.00	-29.33	Horizontal
928.88	25.44	23.28	4.96	29.10	24.58	46.00	-21.42	Horizontal

### 7.3 20dB Occupy Bandwidth

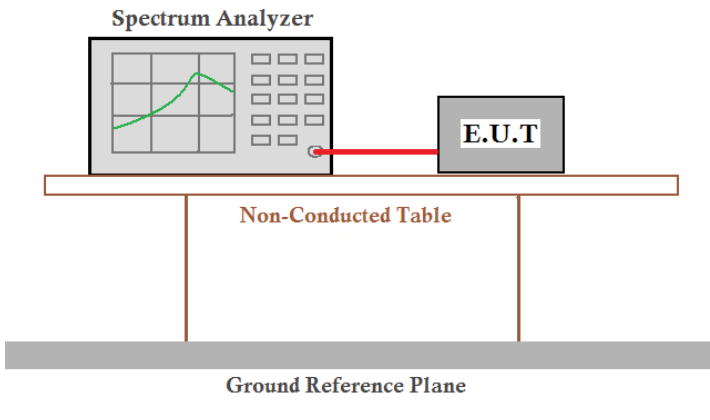
Test Requirement:	FCC Part15 C Section 15.227/15.215
Test Method:	ANSI C63.4:2009
Limit:	Operation Frequency range 26.96MHz ~ 27.28MHz
Test setup:	 <p>The diagram illustrates the test setup. A Spectrum Analyzer is connected via a red cable to an E.U.T. (Equipment Under Test). Both are placed on a Non-Conducted Table. Below the table is a Ground Reference Plane.</p>
Test Instruments:	Refer to section 6.0 for details
Test mode:	Refer to section 5.3 for details
Test results:	Pass

### Measurement Data

20dB bandwidth(MHz)	Result
0.015	Pass

Test plot as follows:

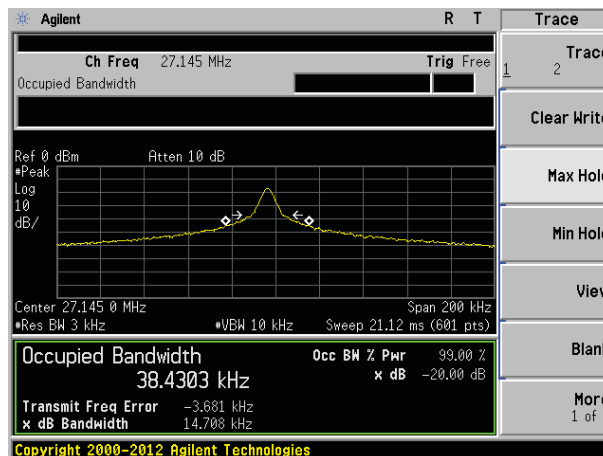

## 8 Test Setup Photo

Radiated Emission

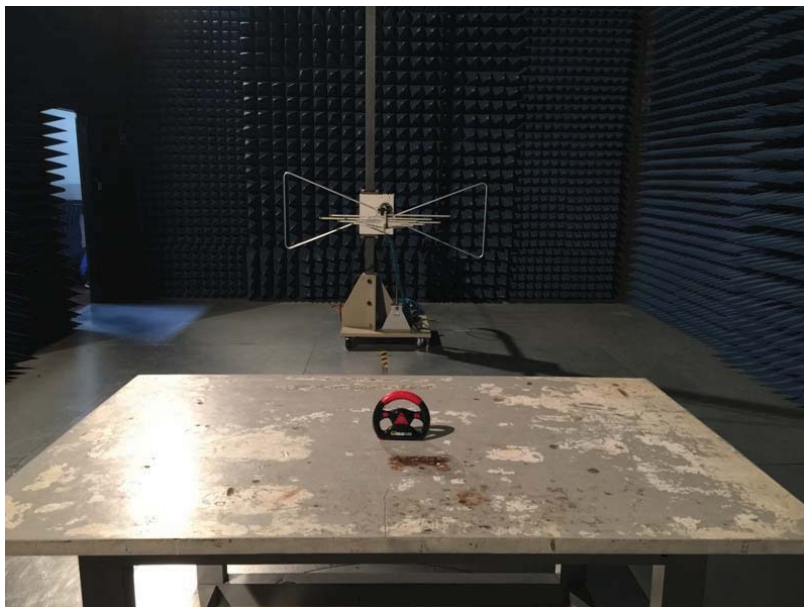



## 9 EUT Constructional Details









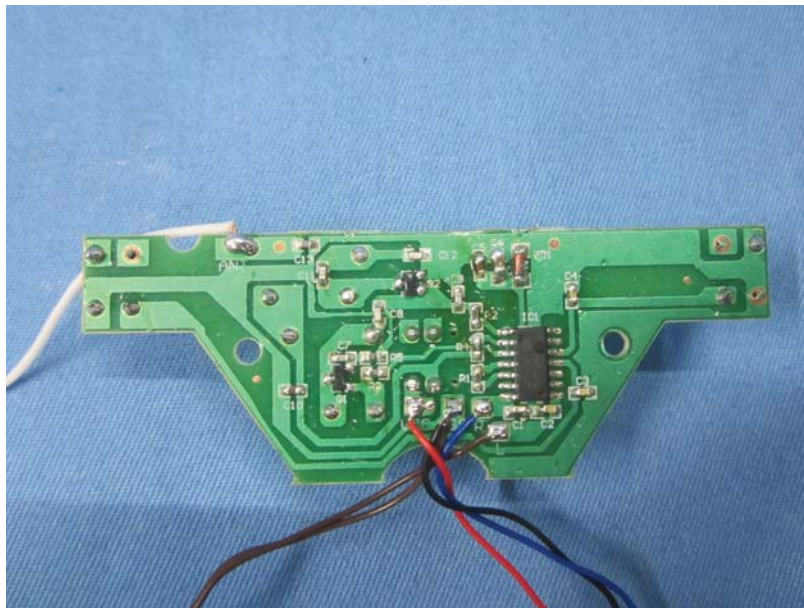

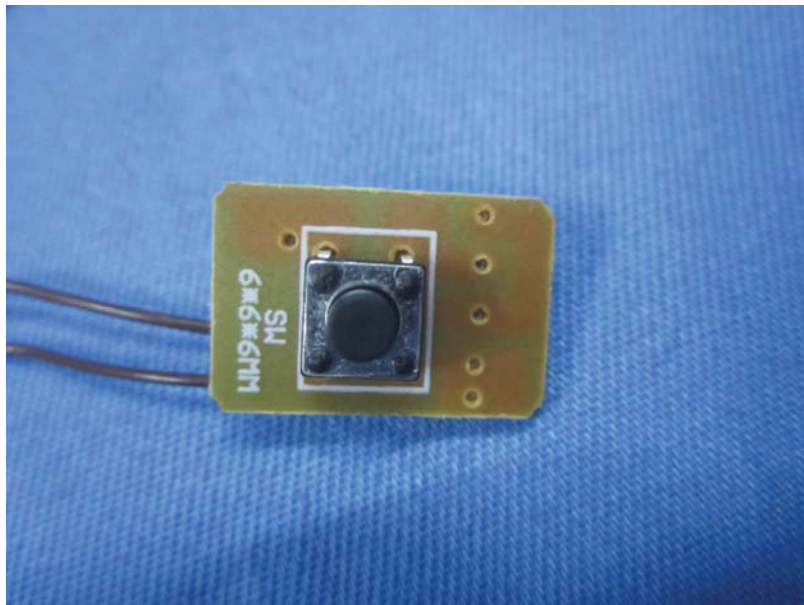
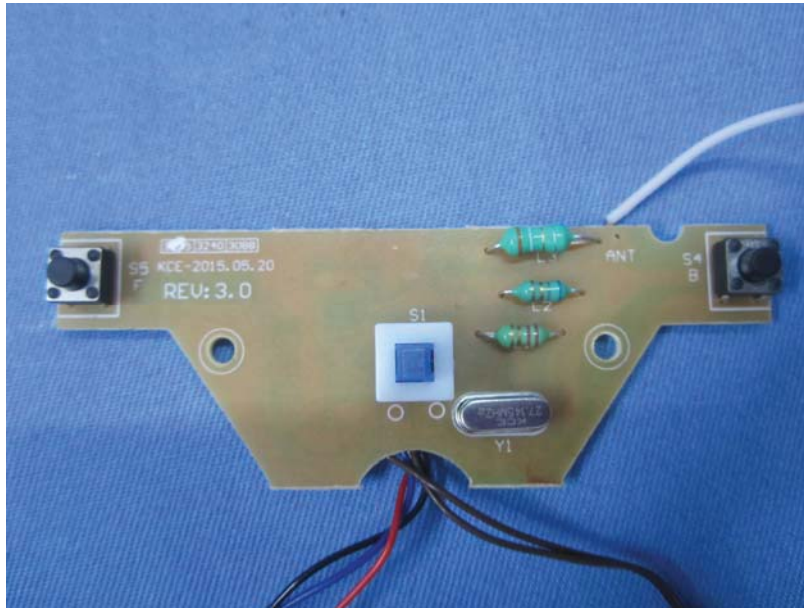



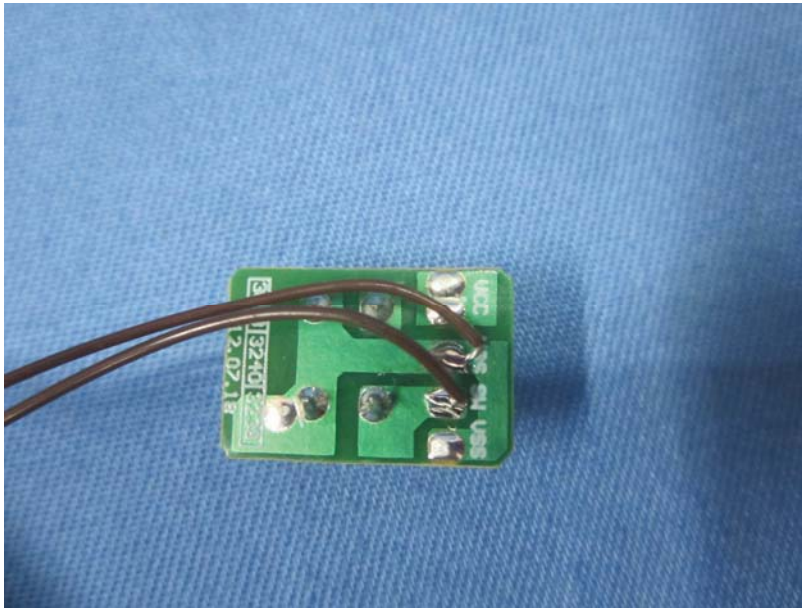

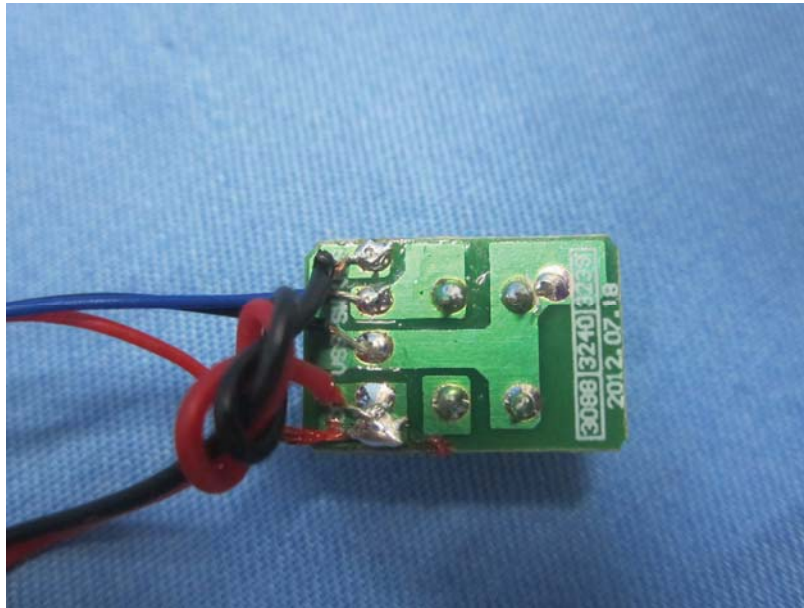

-----End-----