

## Remote Control Vehicle with Glove Controller Véhicule télécommandé avec gant de commande

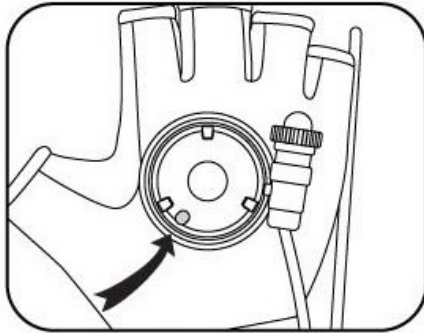

**On / Off**

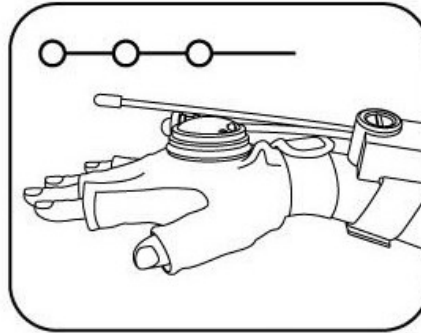

**Forward**

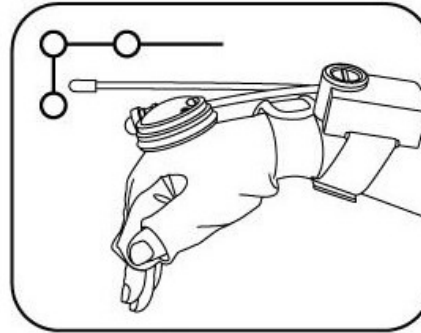

**Reverse**

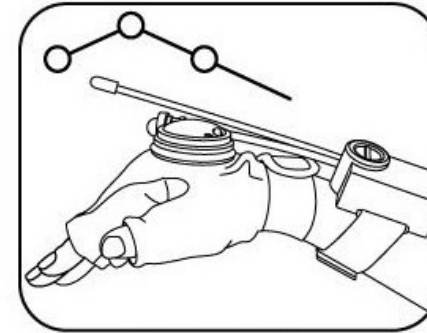

**Stop Position**

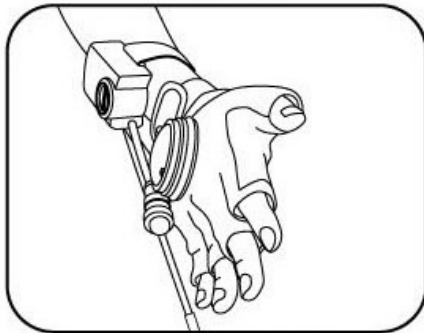

**Forward & Right Turn**

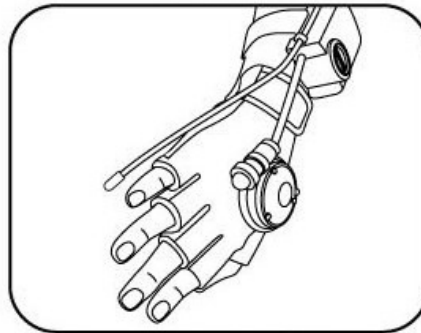

**Forward & Left Turn**

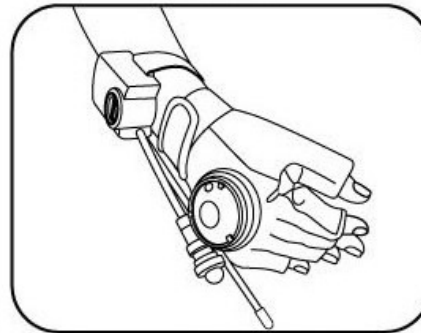

**Reverse & Right Turn**

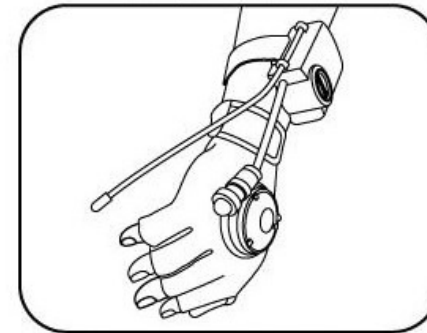

**Reverse & left Turn**

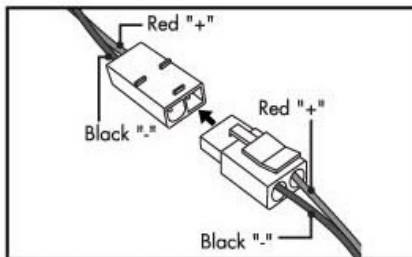

(normally Red for "+" and Black for "-")

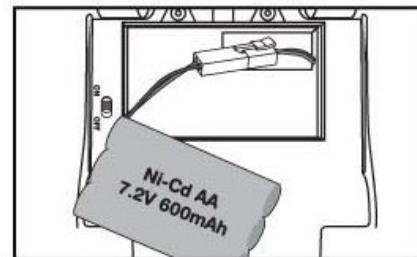

Requires 1 x 7.2V 600mAh,  
AA NiCd batteries (included)  
Fonctionne avec 7.2V 600mAh piles  
AA NiCd (fournies)

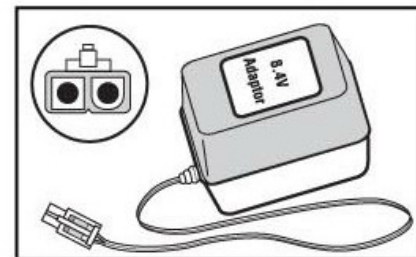

Charger : Input 120V AC ~ 60 Hz 35mA  
Output 8.4V, DC 300mA

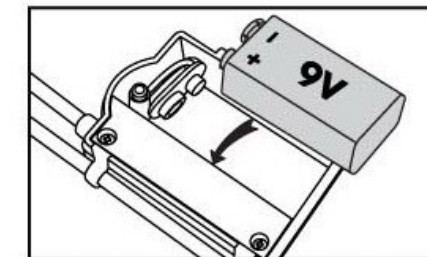

Requires 1 x 9V battery (included)  
Fonctionne avec 1 pile 9V (fournies)



Warning: Changes or modifications not expressly approved by the party responsible for compliance could void the user's authority to operate the equipment.