



MEASUREMENT REPORT

FCC PART15.245 / RSS-210 Issue 9

FCC ID: SIB-PN-CD701
IC: 6719D-PN-CD701
APPLICANT: Foxconn International Inc.

Application Type: Certification
Product: LCD MONITOR
Model No.: PN-CD701
Brand Name: SHARP
FCC Classification: Part 15 Field Disturbance Sensor (FDS)
FCC Rule Part(s): FCC PART15.245
IC Rule(s): RSS-210 Issue 9, RSS-Gen Issue 5
Test Procedure(s): ANSI C63.10-2013
Test Date: January 15 ~ February 02, 2019

Reviewed By



(Kevin Guo)

Approved By

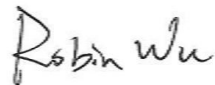

(Robin Wu)



The test results relate only to the samples tested.

This equipment has been shown to be capable of compliance with the applicable technical standards as indicated in the measurement report and was tested in accordance with the measurement procedures specified in ANSI C63.10-2013. Test results reported herein relate only to the item(s) tested.

The test report shall not be reproduced except in full without the written approval of MRT Technology (Suzhou) Co., Ltd.

Revision History

Report No.	Version	Description	Issue Date	Note
1901RSU004-U1	Rev. 01	Initial Report	08-29-2019	Valid

CONTENTS

Description	Page
1. INTRODUCTION	6
1.1. Scope	6
1.2. MRT Test Location	6
2. PRODUCT INFORMATION	7
2.1. Equipment Description.....	7
2.2. Test Configuration	7
2.3. EMI Suppression Device(s)/Modifications	7
2.4. Labeling Requirements.....	7
3. DESCRIPTION of TEST.....	8
3.1. Evaluation Procedure	8
3.2. AC Line Conducted Emissions	8
3.3. Radiated Emissions.....	9
4. ANTENNA REQUIREMENTS.....	10
5. TEST EQUIPMENT CALIBRATION DATE	11
6. MEASUREMENT UNCERTAINTY.....	12
7. TEST RESULT	13
7.1. Summary	13
7.2. Emission Bandwidth Measurement.....	14
7.2.1. Test Limit	14
7.2.2. Test Procedure used	14
7.2.3. Test Setting.....	14
7.2.4. Test Setup.....	14
7.2.5. Test Result.....	15
7.3. Radiated Emission Measurement	16
7.3.1. Test Limit	16
7.3.2. Test Procedure used	17
7.3.3. Test Procedure.....	17
7.3.4. Test Setup.....	19
7.3.5. Test Results	20
7.4. Radiated Band Edge Measurement	23
7.4.1. Test Limit	23
7.4.2. Test Procedure used	24

7.4.3.	Test Procedure.....	24
7.4.4.	Test Setup.....	25
7.4.5.	Test Result.....	26
7.5.	AC Conducted Emissions Measurement.....	30
7.5.1.	Test Limit	30
7.5.2.	Test Setup.....	30
7.5.3.	Test Result.....	31
7.1.	Frequency Stability Measurement.....	33
7.1.1.	Test Limit	33
7.1.2.	Test Procedure used	33
7.1.3.	Test Setup.....	33
7.1.4.	Test Result.....	34
8.	CONCLUSION.....	35
	Appendix A - Test Setup Photograph	36
	Appendix B - EUT Photograph.....	37

§2.1033 General Information

Applicant:	Foxconn International Inc.
Applicant Address:	No. 2, Ziyou St., Tucheng Dist., New Taipei City 236 ,Taiwan.
Manufacturer:	Foxconn International Inc.
Manufacturer Address:	No. 2, Ziyou St., Tucheng Dist., New Taipei City 236 ,Taiwan.
Test Site:	MRT Technology (Suzhou) Co., Ltd
Test Site Address:	D8 Building, No.2 Tian'edang Rd., Wuzhong Economic Development Zone, Suzhou, China
Test Device Serial No.:	WCD 70 DVT2-04 <input type="checkbox"/> Production <input checked="" type="checkbox"/> Pre-Production <input type="checkbox"/> Engineering

Test Facility / Accreditations

Measurements were performed at MRT Laboratory located in Tian'edang Rd., Suzhou, China.

- MRT facility is a FCC registered (MRT Reg. No. 893164) test facility with the site description report on file and has met all the requirements specified in ANSI C63.4-2014.
- MRT facility is an IC registered (MRT Reg. No. 11384A-1) test laboratory with the site description on file at Industry Canada.
- MRT facility is a VCCI registered (R-20025, G-20034, C-20020, T-20020) test laboratory with the site description on file at VCCI Council.
- MRT Lab is accredited to ISO 17025 by the American Association for Laboratory Accreditation (A2LA) under the American Association for Laboratory Accreditation Program (A2LA Cert. No. 3628.01) in EMC, Telecommunications, Radio and SAR testing.



1. INTRODUCTION

1.1. Scope

Measurement and determination of electromagnetic emissions (EMC) of radio frequency devices including intentional and/or unintentional radiators for compliance with the technical rules and regulations of the Federal Communications Commission and the Industry Canada Certification and Engineering Bureau.

1.2. MRT Test Location

The map below shows the location of the MRT LABORATORY, its proximity to the Taihu Lake. These measurement tests were conducted at the MRT Technology (Suzhou) Co., Ltd. Facility located at D8 Building, No.2 Tian'edang Rd., Wuzhong Economic Development Zone, Suzhou, China. The measurement facility compliant with the test site requirements specified in ANSI C63.4-2014.



2. PRODUCT INFORMATION

2.1. Equipment Description

Product Name	LCD MONITOR
Model No.	PN-CD701
Transmitting Frequency	24.15 GHz
Operation Voltage	AC 100 ~ 240V
Modulation Type	Unmodulated Continuous Wave

2.2. Test Configuration

The device was tested per the guidance of FCC Part 15.245 & RSS-210 and ANSI 63.10-2013 was used to reference the appropriate EUT setup for radiated spurious emissions testing and AC line conducted testing.

2.3. EMI Suppression Device(s)/Modifications

No EMI suppression device(s) were added and/or no modifications were made during testing.

2.4. Labeling Requirements

Per 2.1074 & 15.19; Docket 95-19

The label shall be permanently affixed at a conspicuous location on the device; instruction manual or pamphlet supplied to the user and be readily visible to the purchaser at the time of purchase.

However, when the device is so small wherein placement of the label with specified statement is not practical, only the FCC ID must be displayed on the device per Section 15.19(a)(5). Please see attachment for FCC ID label and label location.

RSP-100 Issue 11 Section 3

The manufacturer, importer or distributor shall meet the labelling requirements set out in this section for every unit:

- (i) prior to marketing in Canada, for products manufactured in Canada
- (ii) prior to importation into Canada, for imported products

For information regarding the e-labelling option, see Notice 2014–DRS1003. The label for the certified product represents the manufacturer's or importer's compliance with Innovation, Science and Economic Development Canada's (ISED) regulatory requirements.

Please see attachment for IC label and label location.

3. DESCRIPTION of TEST

3.1. Evaluation Procedure

The measurement procedures described in the American National Standard for Testing Unlicensed Wireless Devices (ANSI C63.10-2013), and the requirement provided in FCC Part 15.245 were used in the measurement of the EUT.

Deviation from measurement procedure.....None

3.2. AC Line Conducted Emissions

The line-conducted facility is located inside an 8'x4'x4' shielded enclosure. A 1m x 2m wooden table 80cm high is placed 40cm away from the vertical wall and 80cm away from the sidewall of the shielded room. Two 10kHz-30MHz, 50Ω/50uH Line-Impedance Stabilization Networks (LISNs) are bonded to the shielded room floor. Power to the LISNs is filtered by external high-current high-insertion loss power line filters. These filters attenuate ambient signal noise from entering the measurement lines. These filters are also bonded to the shielded enclosure.

The EUT is powered from one LISN and the support equipment is powered from the second LISN. All interconnecting cables more than 1 meter were shortened to a 1 meter length by non-inductive bundling (serpentine fashion) and draped over the back edge of the test table. All cables were at least 40cm above the horizontal reference ground-plane. Power cables for support equipment were routed down to the second LISN while ensuring that that cables were not draped over the second LISN.

Sufficient time for the EUT, support equipment, and test equipment was allowed in order for them to warm up to their normal operating condition. The RF output of the LISN was connected to the receiver and exploratory measurements were made to determine the frequencies producing the maximum emission from the EUT. The receiver was scanned from 150kHz to 30MHz. The detector function was set to peak mode for exploratory measurements while the bandwidth of the analyzer was set to 9kHz. The EUT, support equipment, and interconnecting cables were arranged and manipulated to maximize each emission. Each emission was also maximized by varying: power lines, the mode of operation or data exchange speed, or support equipment whichever determined the worst-case emission. Once the worst case emissions have been identified, the one EUT cable configuration/arrangement and mode of operation that produced these emissions are used for final measurements on the same test site. The analyzer is set to CISPR quasi-peak and average detectors with a 9kHz resolution bandwidth for final measurements.

An extension cord was used to connect to a single LISN which powered by EUT. The extension cord was calibrated with LISN, the impedance and insertion loss are compliance with the requirements as stated in ANSI C63.10-2013.

3.3. Radiated Emissions

The radiated test facilities consisted of an indoor 3 meter semi-anechoic chamber used for final measurements and exploratory measurements, when necessary. The measurement area is contained within the semi-anechoic chamber which is shielded from any ambient interference. For measurements above 1GHz absorbers are arranged on the floor between the turn table and the antenna mast in such a way so as to maximize the reduction of reflections. For measurements below 1GHz, the absorbers are removed. A MF Model 210SS turntable is used for radiated measurement. It is a continuously rotatable, remote controlled, metallic turntable and 2 meters (6.56 ft.) in diameter. The turn table is flush with the raised floor of the chamber in order to maintain its function as a ground plane. An 80cm high PVC support structure is placed on top of the turntable.

For all measurements, the spectrum was scanned through all EUT azimuths and from 1 to 4 meter receive antenna height using a broadband antenna from 30MHz up to the upper frequency shown in 15.33(b)(1) depending on the highest frequency generated or used in the device or on which the device operates or tunes. For frequencies above 1GHz, linearly polarized double ridge horn antennas were used. For frequencies below 30MHz, a calibrated loop antenna was used. When exploratory measurements were necessary, they were performed at 1 meter test distance inside the semi-anechoic chamber using broadband antennas, broadband amplifiers, and spectrum analyzers to determine the frequencies and modes producing the maximum emissions. Sufficient time for the EUT, support equipment, and test equipment was allowed in order for them to warm up to their normal operating condition. The test set-up for frequencies below 1GHz was placed on top of the 0.8 meter high, 1 x 1.5 meter table; and test set-up for frequencies 1-40GHz was placed on top of the 1.5 meter high, 1 x 1.5 meter table. The EUT, support equipment, and interconnecting cables were arranged and manipulated to maximize each emission. Appropriate precaution was taken to ensure that all emissions from the EUT were maximized and investigated. The system configuration, clock speed, mode of operation or video resolution, if applicable, turntable azimuth, and receive antenna height was noted for each frequency found.

Final measurements were made in the semi-anechoic chamber using calibrated, linearly polarized broadband and horn antennas. The test setup was configured to the setup that produced the worst case emissions. The spectrum analyzer was set to investigate all frequencies required for testing to compare the highest radiated disturbances with respect to the specified limits. The turntable containing the EUT was rotated through 360 degrees and the height of the receive antenna was varied 1 to 4 meters and stopped at the azimuth and height producing the maximum emission. Each emission was maximized by changing the orientation of the EUT through three orthogonal planes and changing the polarity of the receive antenna, whichever produced the worst-case emissions. According to 3dB Beam-Width of horn antenna, the horn antenna should be always directed to the EUT when rising height.

4. ANTENNA REQUIREMENTS

Excerpt from §15.203 of the FCC Rules/Regulations:

“An intentional radiator antenna shall be designed to ensure that no antenna other than that furnished by the responsible party can be used with the device. The use of a permanently attached antenna or of an antenna that uses a unique coupling to the intentional radiator shall be considered sufficient to comply with the provisions of this section.”

- The antenna of the **LCD MONITOR** is **permanently attached**.
- There are no provisions for connection to an external antenna.

Conclusion:

The unit complies with the requirement of §15.203.

5. TEST EQUIPMENT CALIBRATION DATE

Radiated Emission - AC2

Instrument	Manufacturer	Type No.	Asset No.	Cali. Interval	Cali. Due Date
EMI Test Receiver	R&S	ESR7	MRTSUE06001	1 year	2019/08/14
Signal Analyzer	R&S	FSV40	MRTSUE06218	1 year	2020/04/15
EXA Signal Analyzer	Agilent	N9020A	MRTSUE06106	1 year	2020/04/15
EXA Signal Analyzer	Keysight	N9010B	MRTSUE06452	1 year	2019/07/20
Loop Antenna	Schwarzbeck	FMZB 1519	MRTSUE06025	1 year	2019/11/09
Bilog Period Antenna	Schwarzbeck	VULB 9162	MRTSUE06022	1 year	2019/10/20
Broad Band Horn Antenna	Schwarzbeck	BBHA 9120D	MRTSUE06171	1 year	2019/11/09
Broad Band Horn Antenna	Schwarzbeck	BBHA 9170	MRTSUE06024	1 year	2019/12/17
Micro-Wave Antenna	MI-WWAVE	261U-25	MRTSUE06273	5 year	2021/12/26
Micro-Wave Antenna	MI-WWAVE	261E-25	MRTSUE06276	5 year	2021/12/26
Micro-Wave Antenna	MI-WWAVE	261F-25	MRTSUE06275	5 year	2021/12/26
Waveguide Harmonic Mixer	Keysight	M1970V	MRTSUE06271	5 year	2022/01/17
Waveguide Harmonic Mixer	Keysight	M1970W	MRTSUE06272	5 year	2021/12/07
Microwave System Amplifier	Agilent	83017A	MRTSUE06076	1 year	2019/11/16
Amplifier	Schwarzbeck	BBV 9721	MRTSUE06121	1 year	2019/06/13
DC Power Supply	GWINSTEK	DPS-99306D	MRTSUE06063	N/A	N/A
Digital Thermometer & Hygrometer	Minggao	ETH529	MRTSUE06170	1 year	2019/12/13
Anechoic Chamber	RIKEN	Chamber-AC2	MRTSUE06213	1 year	2020/04/30
Coaxial transmission line	Times Microwave Systems	SLU18-SMSM-01 .00M (Serial #94197(TMC))	N/A	5 year	2022/01/17
Coaxial transmission line	Times Microwave Systems	SLU18-SMSM-01 .00M (Serial #94198(TMC))	N/A	5 year	2021/12/07
Coaxial transmission line	UCWAVE	SPT67-1.85M1.8 5M-1.0M	N/A	5 year	2021/12/26

6. MEASUREMENT UNCERTAINTY

Where relevant, the following test uncertainty levels have been estimated for tests performed on the EUT as specified in CISPR 16-4-2. This uncertainty represents an expanded uncertainty expressed at approximately the 95% confidence level using a coverage factor of $k = 2$.

Conducted Emission - SR2

The maximum measurement uncertainty is evaluated as:

9kHz~150kHz: 3.84dB

150kHz~30MHz: 3.46dB

Radiated Emission Measurement - AC2

Measuring Uncertainty for a Level of Confidence of 95% ($U=2Uc(y)$):

9kHz ~ 1GHz: 4.18dB

1GHz ~ 18GHz: 4.76dB

7. TEST RESULT

7.1. Summary

FCC Part Section(s)	Test Description	Test Limit	Test Condition	Test Result	Reference
15.215(c)	Emission Bandwidth	20 dB bandwidth of the emission is contained within 24.075~24.175GHz	Radiated	Pass	Section 7.2
15.209 15.245	Fundamental Field Strength Harmonic Field Strength Restricted Bands Emission	FCC Part 15.245(b), FCC Part 15.209		Pass	Section 7.3 & 7.4
15.207	AC Conducted Emissions 150kHz - 30MHz	< FCC 15.207 limits	Line Conducted	Pass	Section 7.5

RSS Section(s)	Test Description	Test Limit	Test Condition	Test Result	Reference
RSS-Gen Clause 6.7	Occupied Bandwidth	N/A	Radiated	Pass	Section 7.2
RSS-Gen Clause 8.9, RSS-210 Annex F.1	Fundamental Field Strength Harmonic Field Strength Restricted Bands Emission	Emissions in restricted bands must meet the radiated limits detailed in clause 8.10		Pass	Section 7.3 & 7.4
RSS-Gen Clause 8.11	Frequency Stability	Fall within at least the central 80% of its permitted operating frequency band		Pass	Section 7.6
RSS-Gen Clause 8.8	AC Conducted Emissions 150kHz - 30MHz	< RSS-Gen Clause 8.8 limits	Line Conducted	Pass	Section 7.5

Notes:

The analyzer plots shown in this section were all taken with a correction factor loaded into the analyzer. The correction factor was used to account for the losses of the cables and attenuators used as part of the system to connect the EUT to the analyzer at all frequencies of interest.

7.2. Emission Bandwidth Measurement

7.2.1. Test Limit

For FCC (20dB Emission Bandwidth)

20 dB bandwidth of the emission shall be contained within the frequency band 24.075 ~ 24.175 GHz.

For IC (99% Occupied Bandwidth)

N/A

7.2.2. Test Procedure used

ANSI C63.10 Section 6.9.2 and Section 6.9.3

7.2.3. Test Setting

1. The analyzers' automatic bandwidth measurement capability was used to perform the 99% or 20dB bandwidth measurement. The bandwidth measurement was not influenced by any intermediated power nulls in the fundamental emission.
2. RBW = approximately 1% to 5% of the OBW.
3. VBW $\geq 3 \times$ RBW.
4. Detector = Peak.
5. Trace mode = max hold.

7.2.4. Test Setup

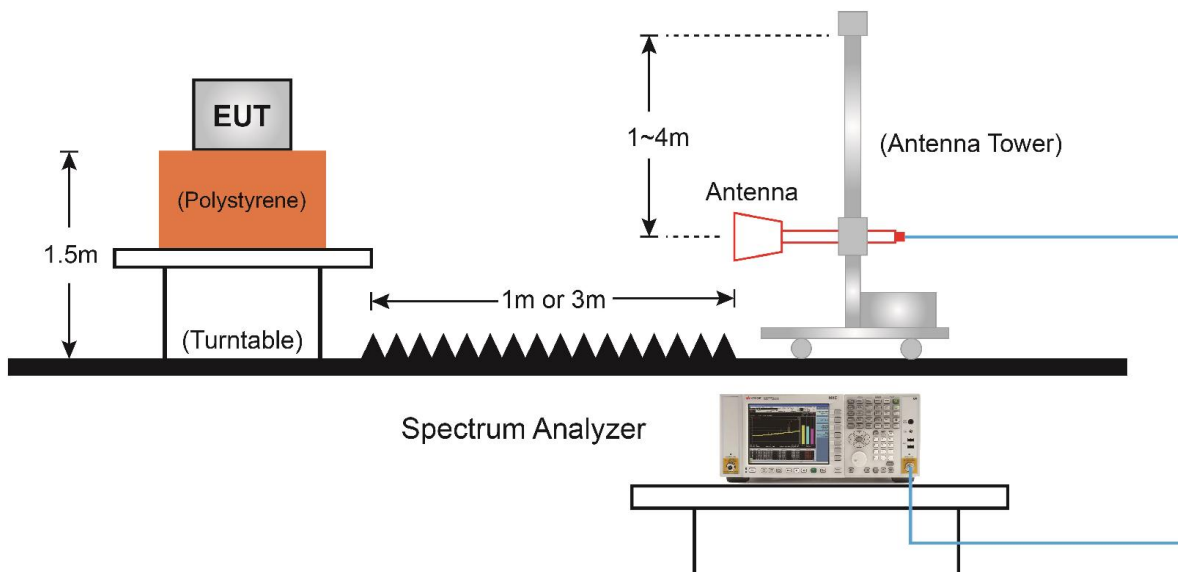

7.2.5. Test Result

Product	LCD MONITOR	Temperature	25°C
Test Engineer	Milo Li	Relative Humidity	56%
Test Site	AC2	Test Date	2019/02/01

20dB Bandwidth Range (MHz)	Range Limit (MHz)	Result
$F_L = 24108.804$	24075	Pass
$F_H = 24115.764$	24175	Pass
99% Occupied Bandwidth		Result
6.865		N/A

Note: $F_L = 24110 \text{ MHz} - 1.1964 \text{ MHz} = 24108.804 \text{ MHz}$;

$F_H = 24110 \text{ MHz} + 5.7643 \text{ MHz} = 24115.764 \text{ MHz}$;

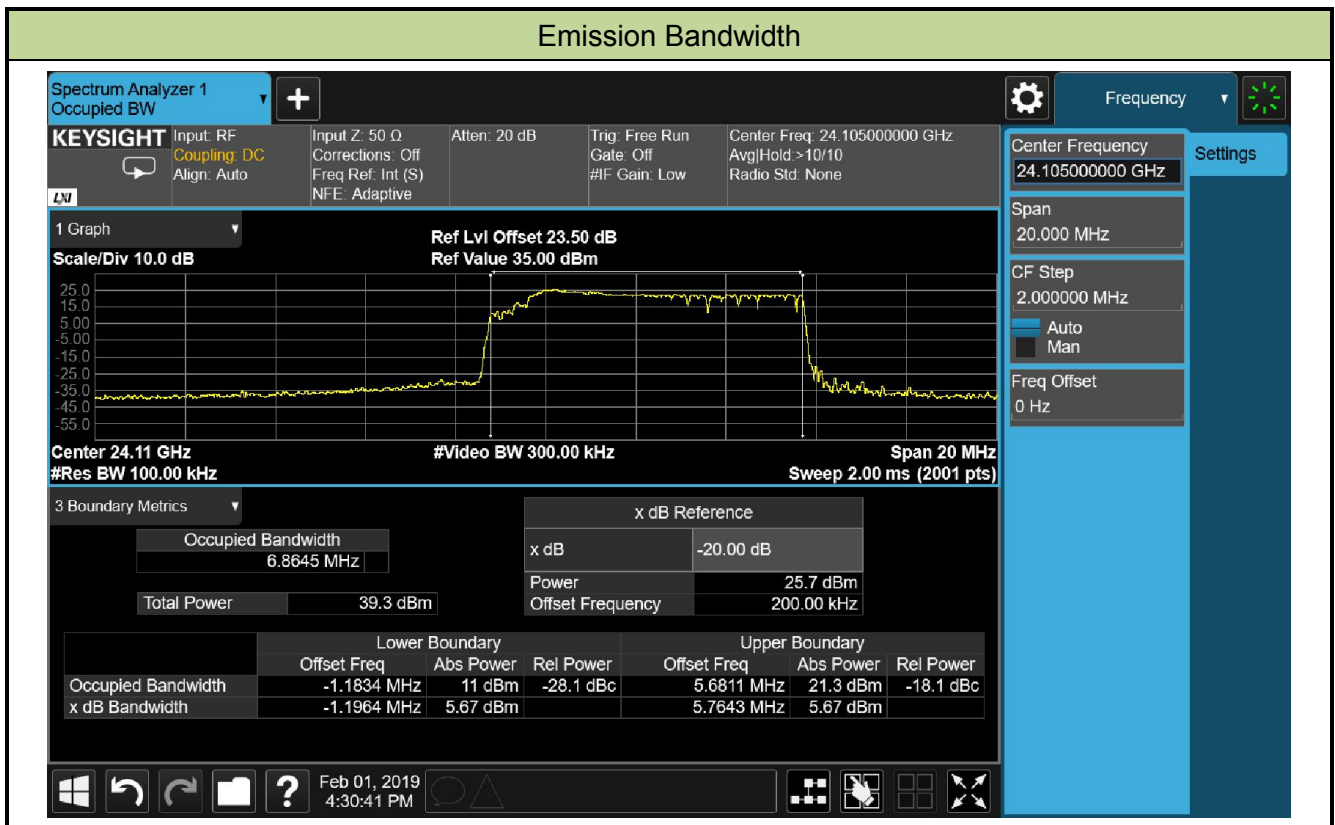

7.3. Radiated Emission Measurement

7.3.1. Test Limit

FCC Part 15 Subpart C Paragraph 15.245 & RSS 210 Table F1		
Fundamental frequency (MHz)	Field strength of fundamental (millivolts/meter)	Field strength of harmonics (millivolts/meter)
902 ~ 928	500	1.6
2435 ~ 2465	500	1.6
5785 ~ 5815	500	1.6
10500 ~ 10550	2500	25.0
24075 ~ 24175	2500	25.0

Note 1: Regardless of the limits shown in the above table, harmonic emissions in the restricted bands below 17.7 GHz, as specified in §15.205, shall not exceed the field strength limits shown in § 15.209. Harmonic emissions in the restricted bands at and above 17.7GHz shall not exceed the following field strength limits:

- (i) For the second and third harmonics of field disturbance sensors operating in the 24075-24175 MHz band and for other field disturbance sensors designed for use only within a building or to open building doors, 25.0 mV/m.
- (ii) For all other field disturbance sensors, 7.5 mV/m.
- (iii) Field disturbance sensors designed to be used in motor vehicles or aircraft must include features to prevent continuous operation unless their emissions in the restricted bands, other than the second and third harmonics from devices operating in the 24075-24175 MHz band, fully comply with the limits given in § 15.209. Continuous operation of field disturbance sensors designed to be used in farm equipment, vehicles such as fork lifts that are intended primarily for use indoors or for very specialized operations, or railroad locomotives, railroad cars and other equipment which travels on fixed tracks is permitted. A field disturbance sensor will be considered not to be operating in a continuous mode if its operation is limited to specific activities of limited duration (e.g., putting a vehicle into reverse gear, activating a turn signal, etc.).

Note 2: Emissions radiated outside of the specified frequency bands, except for harmonics, shall be attenuated by at least 50 dB below the level of the fundamental or to the general radiated emission limits in §15.209, whichever is the lesser attenuation.

Note 3: Field strength limits are specified at a distance of 3 meters.

Note 4: The emission limits shown above are based on measurement instrumentation employing an average detector. The provisions in §15.35 for limiting peak emissions apply.

FCC Part 15 Subpart C Paragraph 15.209 & RSS-Gen Table 5		
Frequency (MHz)	Field Strength (uV/m)	Measurement Distance (m)
0.009 ~ 0.490	2400/F(kHz)	300
0.490 ~ 1.705	24000/F(kHz)	30
1.705 ~ 30.0	30	30
30 ~ 80	100**	3
80 ~ 216	150**	3
216 ~ 960	200**	3
Above 960	500	3

Note 1: The lower limit shall apply at the transition frequency.
 Note 2: Distance refers to the distance in meters between the measuring instrument antenna and the closed point of any part of the device or system.
 Note 3: E field strength (dBuV/m) = 20 log E field strength (uV/m).

7.3.2. Test Procedure used

ANSI C63.10 Section 6.3 & Section 6.4 & Section 6.5 & Section 6.6

7.3.3. Test Procedure

Quasi-Peak Measurements below 1GHz

1. Analyzer center frequency was set to the frequency of the radiated spurious emission of interest
2. Span was set greater than 1MHz
3. RBW = as specified in Table 1
4. Detector = CISPR quasi-peak or average
5. Sweep time = auto couple
6. Trace was allowed to stabilize

Table 1 - RBW as a function of frequency

Frequency	RBW
9 ~ 150 kHz	200 ~ 300 Hz
0.15 ~ 30 MHz	9 ~ 10 kHz
30 ~ 1000 MHz	100 ~ 120 kHz
> 1000 MHz	1 MHz

Peak Measurements above 1GHz

1. Analyzer center frequency was set to the frequency of the radiated spurious emission of interest
2. RBW = 1MHz
3. VBW = 3MHz
4. Detector = peak
5. Sweep time = auto couple
6. Trace mode = max hold
7. Trace was allowed to stabilize

Average Measurements above 1GHz

1. Analyzer center frequency was set to the frequency of the radiated spurious emission of interest
2. RBW = 1MHz
3. $VBW \geq [1 / (\text{Minimum transmitter on time})]$ and no less than 1 Hz.
4. The instrument may be set to linear detector mode. Ensure that video filtering is applied in linear voltage domain (rather than in a log or dB domain). Some instruments require linear display mode in order to accomplish this. Others have a setting for Average-VBW Type, which can be set to "Voltage" regardless of the display mode
5. Detector = Peak
6. Sweep time = auto
7. Trace mode = max hold

7.3.4. Test Setup

Below 1GHz Test Setup:

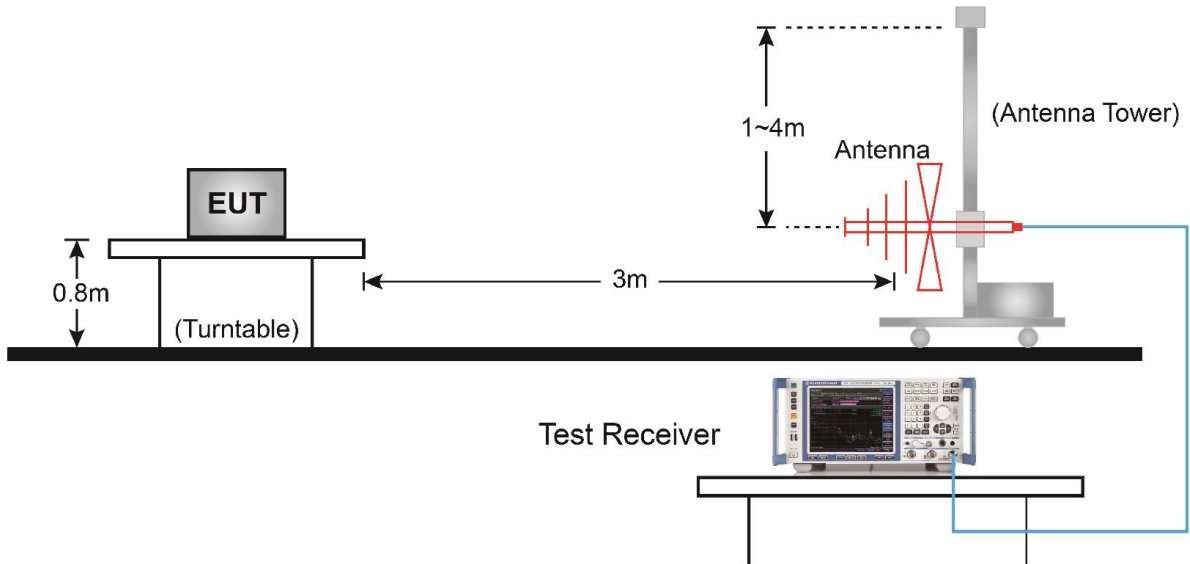

Above 1GHz Test Setup:

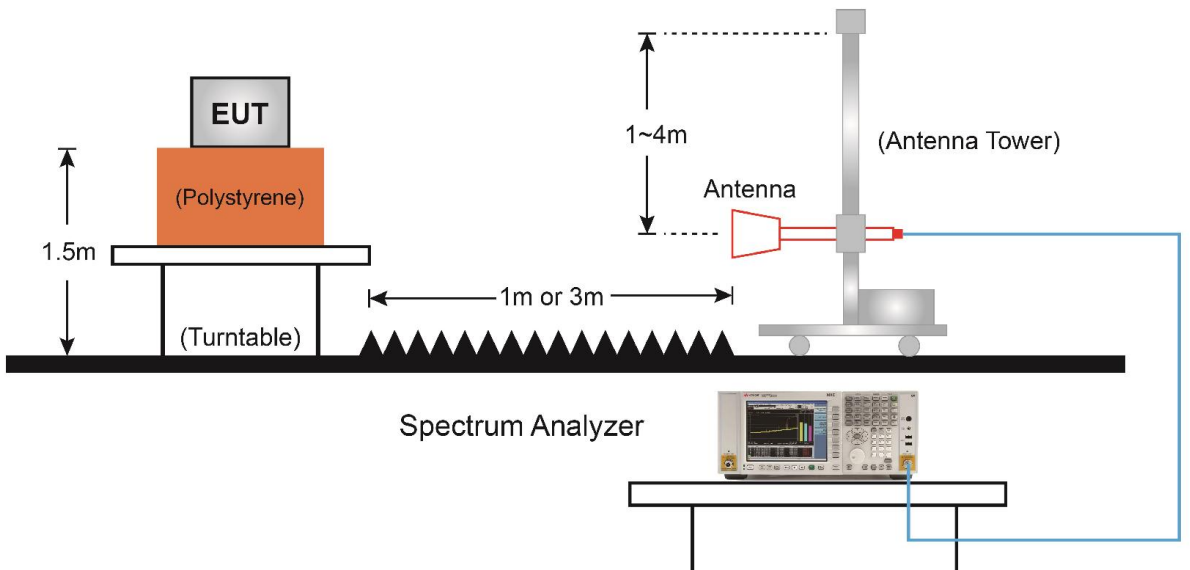

7.3.5. Test Results

Product	LCD MONITOR	Temperature	25°C
Test Engineer	Milo Li	Relative Humidity	56%
Test Site	AC2	Test Date	2019/02/01
Remark:	Fundamental Radiated Emission		

Frequency (GHz)	Reading Level (dB μ V)	Factor (dB)	Measure Level (dB μ V/m)	Limit (dB μ V/m)	Margin (dB)	Detector	Polarization
24.15	107.6	10.6	118.2	157.5	-39.3	Peak	Horizontal
	107.3	10.6	117.9	137.5	-19.6	Average	Horizontal
	104.2	10.6	114.8	157.5	-42.7	Peak	Vertical
	90.0	10.6	100.6	137.5	-36.9	Average	Vertical

Note 1: Peak Measure Level (dB μ V/m) = Reading Level (dB μ V) + Factor (dB)

Factor (dB) = Cable Loss (dB) + Antenna Factor (dB/m) - Pre_Amplifier Gain (dB)

Note 2: Limit@1m = 20*Log(2500uV/m) + 60 + 20*Log(3m/1m) = 137.5dB μ v/m (Average detector), and 157.5dB μ v/m (Peak detector).

Product	LCD MONITOR	Temperature	25°C
Test Engineer	Milo Li	Relative Humidity	56%
Test Site	AC2	Test Date	2019/01/19
Remark:	Harmonics Radiated Emission		

Mark	Frequency (MHz)	Reading Level (dB μ V)	Factor (dB)	Measure Level (dB μ V/m)	Limit (dB μ V/m)	Margin (dB)	Detector	Polarization
Measurement Distance = 3m (30 MHz ~ 18 GHz)								
	206.1	26.6	12.6	39.2	43.5	-4.3	QP	Horizontal
	604.7	20.9	20.5	41.4	46.0	-4.6	QP	Horizontal
	170.7	29.3	10.5	39.8	43.5	-3.7	QP	Vertical
	239.0	27.9	13.6	41.5	46.0	-4.5	QP	Vertical
	1314.5	61.4	-5.1	56.3	74.0	-17.7	Peak	Horizontal
	1314.5	40.1	-5.1	35.0	54.0	-19.0	Average	Horizontal
	1833.0	55.8	-5.2	50.6	74.0	-23.4	Peak	Horizontal
	1833.0	35.9	-5.2	30.7	54.0	-23.3	Average	Horizontal
	1306.0	62.4	-5.1	57.3	74.0	-16.7	Peak	Vertical
	1306.0	43.8	-5.1	38.7	54.0	-15.3	Average	Vertical
	2674.5	53.2	-2.2	51.0	74.0	-23.0	Peak	Vertical
	2674.5	33.7	-2.2	31.5	54.0	-22.5	Average	Vertical
Measurement Distance = 1m (18 GHz ~ 121 GHz)								
	31936.0	39.0	13.4	52.4	83.5(Note 2)	-31.1	Peak	Horizontal
	38832.0	40.5	22.3	62.8	83.5(Note 2)	-20.7	Peak	Horizontal
	38832.0	21.5	22.3	43.8	63.5(Note 2)	-19.7	Average	Horizontal
	31168.0	40.8	13.9	54.7	83.5(Note 2)	-28.8	Peak	Vertical
	39584.0	41.4	23.6	65.0	83.5(Note 2)	-18.5	Peak	Vertical
	39584.0	22.6	23.6	46.2	63.5(Note 2)	-17.3	Average	Vertical
*	48205.0	34.4	46.0	80.4	117.5(Note 3)	-37.1	Peak	Horizontal
*	72519.0	32.3	58.3	90.6	117.5(Note 3)	-26.9	Peak	Horizontal
*	96652.0	36.6	63.5	100.1	117.5(Note 3)	-17.4	Peak	Horizontal
*	48205.0	41.6	46.0	87.6	117.5(Note 3)	-29.9	Peak	Vertical
*	72334.0	34.2	58.5	92.7	117.5(Note 3)	-24.8	Peak	Vertical
*	96543.0	37.3	63.6	100.9	117.5(Note 3)	-16.6	Peak	Vertical

Note 1: Measure Level (dB μ V/m) = Reading Level (dB μ V) + Factor (dB)

Factor (dB) = Cable Loss (dB) + Antenna Factor (dB/m) - Pre_Amplifier Gain (dB)

Note 2: Limit@1m = 20*Log(500uV/m) + 20*Log(3m/1m) = 63.5dB μ v/m (Average detector), and 83.5dB μ v/m (Peak detector).

Note 3: "*" it represents Harmonic emissions in the restricted bands, and its limit is 25 mV/m.

Limit@1m = {[20*log[(25/1000)] + 120] + 20log(3m/1m)} dBuV/m = 97.5 dBuV/m (Average detector), and 117.5 dBuV/m (Peak detector).

Note 4: Average measurement was not performed when the peak level lower than average limit.

Note 5: The test trace is same as the ambient noise (the test frequency range: 9 kHz ~ 30 MHz, therefore no data appear in the report.

7.4. Radiated Band Edge Measurement

7.4.1. Test Limit

For 15.205 requirement:

Radiated emissions which fall in the restricted bands, as defined in Section 15.205(a) of FCC part 15, must also comply with the radiated emission limits specified in Section 15.209(a).

Frequency (MHz)	Frequency (MHz)	Frequency (MHz)	Frequency (GHz)
0.090 - 0.110	16.42 - 16.423	399.9 - 410	4.5 - 5.15
¹ 0.495 - 0.505	16.69475 - 16.69525	608 - 614	5.35 - 5.46
2.1735 - 2.1905	16.80425 - 16.80475	960 - 1240	7.25 - 7.75
4.125 - 4.128	25.5 - 25.67	1300 - 1427	8.025 - 8.5
4.17725 - 4.17775	37.5 - 38.25	1435 - 1626.5	9.0 - 9.2
4.20725 - 4.20775	73 - 74.6	1645.5 - 1646.5	9.3 - 9.5
6.215 - 6.218	74.8 - 75.2	1660 - 1710	10.6 - 12.7
6.26775 - 6.26825	108 - 121.94	1718.8 - 1722.2	13.25 - 13.4
6.31175 - 6.31225	123 - 138	2200 - 2300	14.47 - 14.5
8.291 - 8.294	149.9 - 150.05	2310 - 2390	15.35 - 16.2
8.362 - 8.366	156.52475 - 156.525	2483.5 - 2500	17.7 - 21.4
8.37625 - 8.38675	156.7 - 156.9	2690 - 2900	22.01 - 23.12
8.41425 - 8.41475	162.0125 - 167.17	3260 - 3267	23.6 - 24.0
12.29 - 12.293	167.72 - 173.2	3332 - 3339	31.2 - 31.8
12.51975 - 12.52025	240 - 285	3345.8 - 3358	36.43 - 36.5
12.57675 - 12.57725	322 - 335.4	3600 - 4400	(²)
13.36 - 13.41	--	--	--

All out of band emissions appearing in a restricted band as specified in Section 15.205 of the Title 47 CFR must not exceed the limits shown in Table per Section 15.209.

FCC Part 15 Subpart C Paragraph 15.209		
Frequency [MHz]	Field Strength [$\mu\text{V}/\text{m}$]	Measured Distance [Meters]
0.009 ~ 0.490	2400/F (kHz)	300
0.490 ~ 1.705	24000/F (kHz)	30
1.705 ~ 30	30	30
30 ~ 88	100	3
88 ~ 216	150	3
216 ~ 960	200	3
Above 960	500	3

For RSS-Gen Section 8.10 Requirement:

Radiated emissions which fall in the restricted bands, as defined in Section 8.10 of RSS-Gen, must also comply with the radiated emission limits specified in Section 8.9.

Frequency (MHz)	Frequency (MHz)	Frequency (MHz)	Frequency (GHz)
0.090 - 0.110	16.42 - 16.423	1645.5 - 1646.5	9.0 - 9.2
0.495 - 0.505	16.69475 - 16.69525	1660 - 1710	9.3 - 9.5
2.1735 - 2.1905	16.80425 - 16.80475	1718.8-1722.2	10.6 - 12.7
3.020 - 3.026	25.5 - 25.67	2200 - 2300	13.25 - 13.4
4.125 - 4.128	37.5 - 38.25	2310-2390	14.47 - 14.5
4.17725 - 4.17775	73 - 74.6	2483.5 - 2500	15.35 - 16.2
4.20725 - 4.20775	74.8 - 75.2	2655 - 2900	17.7 - 21.4
5.677 - 5.683	108 - 138	3260 - 3267	22.01 - 23.12
6.215 - 6.218	149.9 - 150.05	3332 - 3339	23.6 - 24.0
6.26775 - 6.26825	156.52475 - 156.52525	3345.8 - 3358	31.2 - 31.8
6.31175 - 6.31225	156.7 - 156.9	3500 - 4400	36.43 - 36.5
8.291 - 8.294	162.0125 - 167.17	4500 - 5150	Above 38.6
8.362 - 8.366	167.72 - 173.2	5350 - 5460	--
8.37625 - 8.38675	240 - 285	7250 - 7750	--
8.41425 - 8.41475	322 - 335.4	8025 - 8500	--
12.29 - 12.293	399.9 - 410	--	--
12.51975 - 12.52025	608 - 614	--	--
12.57675 - 12.57725	960 - 1427	--	--
13.36 -13.41	1435 - 1626.5	--	--

7.4.2. Test Procedure used

ANSI C63.10 Section 6.10

7.4.3. Test Procedure

Peak Measurements

1. Analyzer center frequency was set to the frequency of the radiated spurious emission of interest
2. RBW = 1MHz
3. VBW = 3MHz
4. Detector = peak
5. Sweep time = auto couple

6. Trace mode = max hold
7. Trace was allowed to stabilize

Average Measurements

1. Analyzer center frequency was set to the frequency of the radiated spurious emission of interest
2. RBW = 1MHz
3. VBW $\geq [1 / (\text{Minimum transmitter on time})]$ and no less than 1 Hz.
4. The instrument may be set to linear detector mode. Ensure that video filtering is applied in linear voltage domain (rather than in a log or dB domain). Some instruments require linear display mode in order to accomplish this. Others have a setting for Average-VBW Type, which can be set to “Voltage” regardless of the display mode
5. Detector = Peak
6. Sweep time = auto
7. Trace mode = max hold

7.4.4. Test Setup

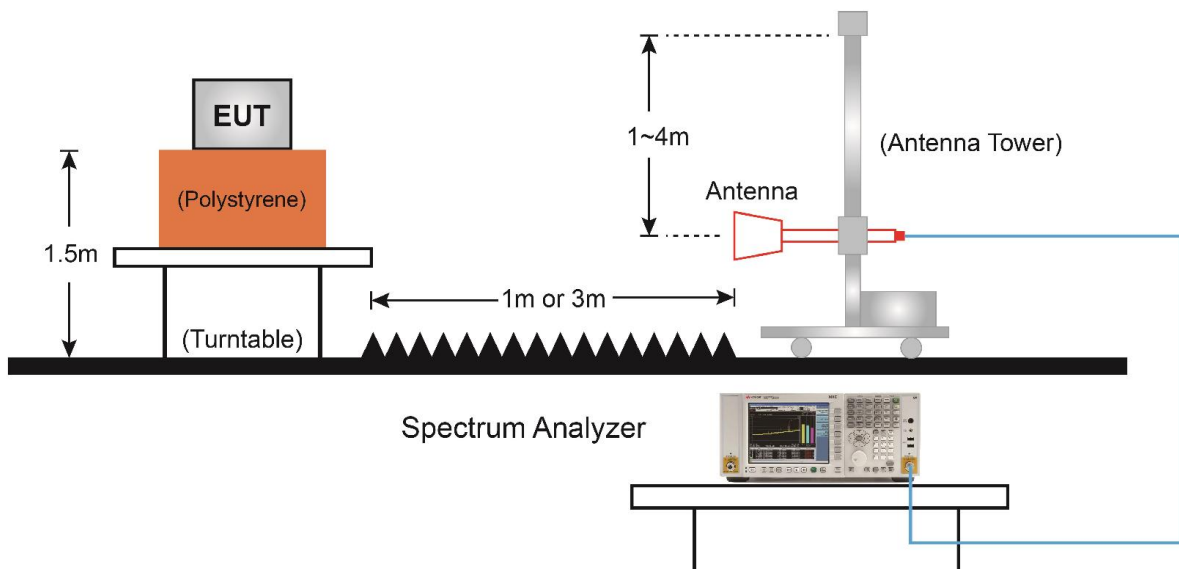

7.4.5. Test Result

Site: AC2	Time: 2019/02/01 - 15:45
Limit: FCC 109 CLASS B (1M)	Engineer: Milo Li
Probe: BBHA9170_18-40GHz	Polarity: Horizontal
EUT: LCD Monitor	Power: AC 120V/60Hz
Test Mode: Transmit at 24.1GHz	

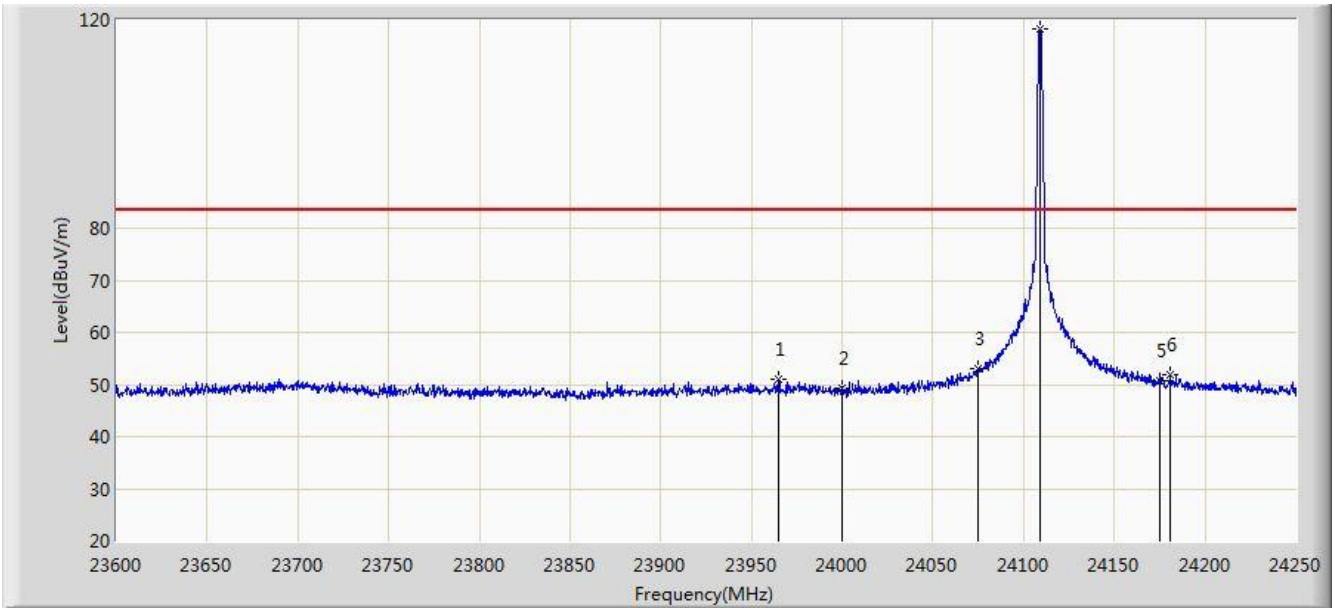

No	Flag	Mark	Frequency (MHz)	Measure Level (dBuV/m)	Reading Level (dBuV)	Over Limit (dB)	Limit (dBuV/m)	Factor (dB)	Type
1			23964.975	51.150	40.718	-32.390	83.540	10.431	PK
2			24000.000	49.246	38.943	-34.294	83.540	10.302	PK
3			24075.000	53.049	43.011	-30.491	83.540	10.038	PK
4		*	24108.949	118.226	107.586	N/A	N/A	10.641	PK
5			24175.000	50.583	40.169	-32.957	83.540	10.413	PK
6			24181.100	51.772	41.414	-31.768	83.540	10.358	PK

Note 1: Peak Measure Level (dBuV/m) = Reading Level (dBuV) + Factor (dB)

Factor (dB) = Cable Loss (dB) + Antenna Factor (dB/m) - Pre_Amplifier Gain (dB)

Note 2: Limit@1m = $20 \cdot \log(500 \mu\text{V/m}) + 20 \cdot \log(3\text{m}/1\text{m}) = 63.540 \text{ dBuV/m}$ (Average detector), and 83.540 dBuV/m (Peak detector).

Site: AC2	Time: 2019/02/01 - 15:48
Limit: FCC 109 CLASS B (1M)	Engineer: Milo Li
Probe: BBHA9170_18-40GHz	Polarity: Horizontal
EUT: LCD Monitor	Power: AC 120V/60Hz
Test Mode: Transmit at 24.1GHz	

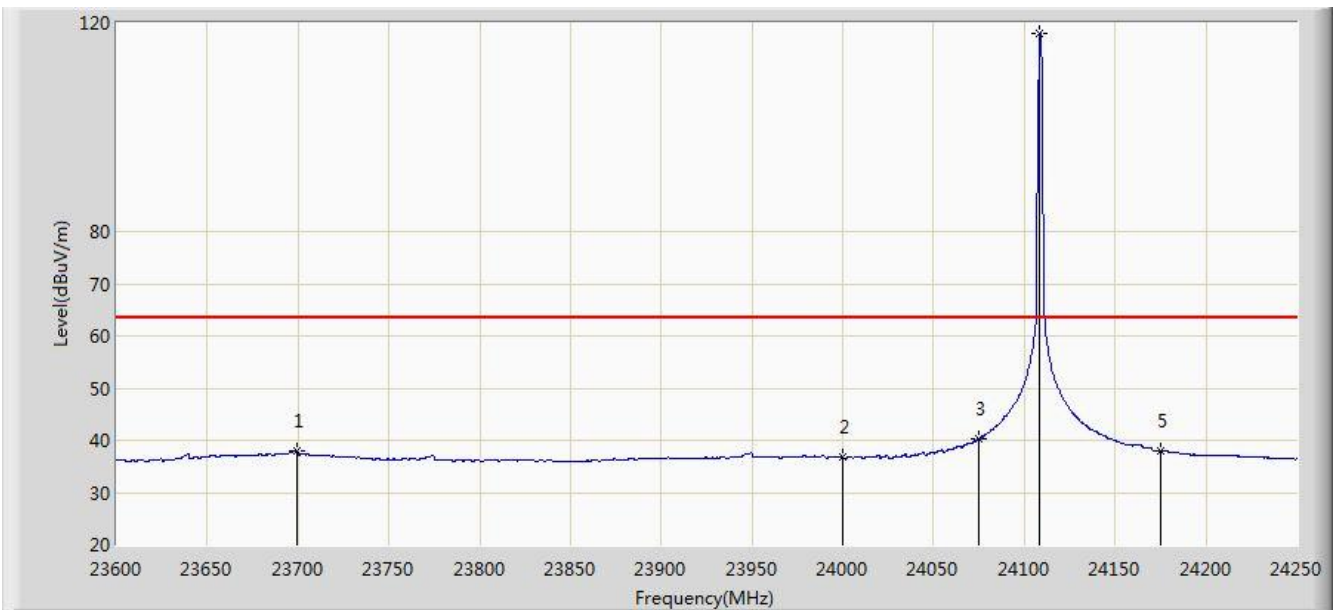

No	Flag	Mark	Frequency (MHz)	Measure Level (dBuV/m)	Reading Level (dBuV)	Over Limit (dB)	Limit (dBuV/m)	Factor (dB)	Type
1			23699.775	37.987	27.279	-25.553	63.540	10.708	AV
2			24000.000	36.793	26.490	-26.747	63.540	10.302	AV
3			24075.000	40.311	30.273	-23.229	63.540	10.038	AV
4		*	24108.625	117.935	107.294	N/A	N/A	10.642	AV
5			24175.000	37.933	27.519	-25.607	63.540	10.413	AV

Note 1: Peak Measure Level (dB μ V/m) = Reading Level (dB μ V) + Factor (dB)

Factor (dB) = Cable Loss (dB) + Antenna Factor (dB/m) - Pre_Amplifier Gain (dB)

Note 2: Limit@1m = 20*Log(500uV/m) + 20*Log(3m/1m) = 63.540dB μ V/m (Average detector), and 83.540dB μ V/m (Peak detector).

Site: AC2	Time: 2019/02/01 - 15:27
Limit: FCC 109 CLASS B (1M)	Engineer: Milo Li
Probe: BBHA9170_18-40GHz	Polarity: Vertical
EUT: LCD Monitor	Power: AC 120V/60Hz
Test Mode: Transmit at 24.1GHz	

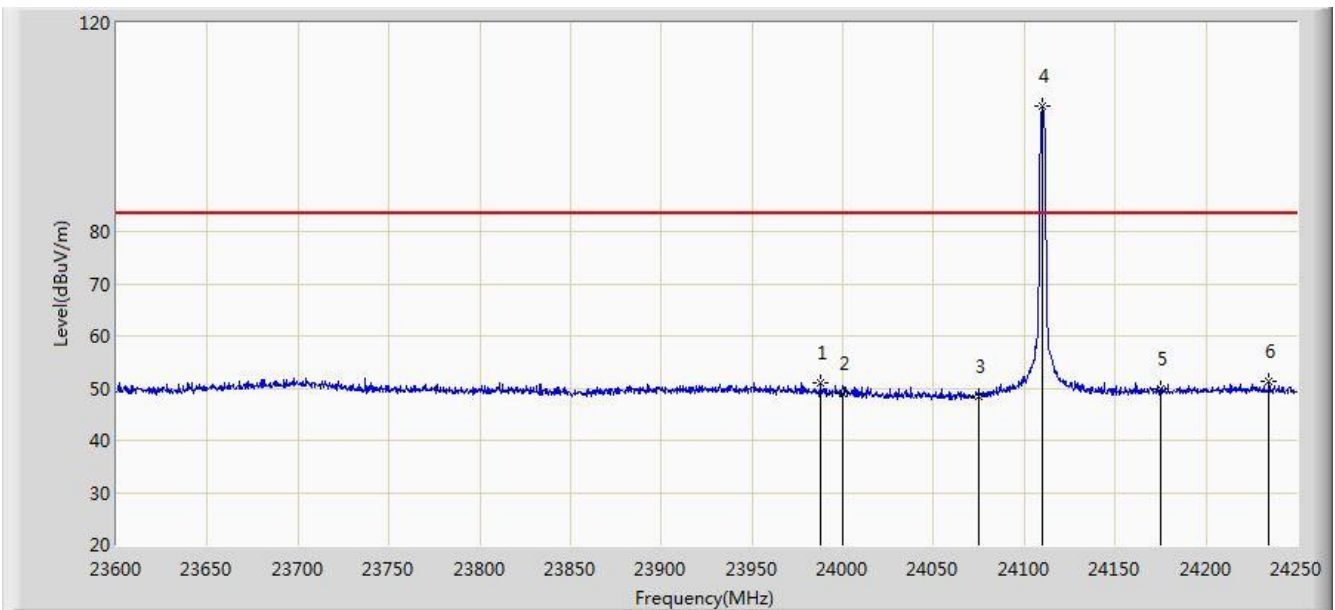

No	Flag	Mark	Frequency (MHz)	Measure Level (dBuV/m)	Reading Level (dBuV)	Over Limit (dB)	Limit (dBuV/m)	Factor (dB)	Type
1			23987.400	50.954	40.484	-32.586	83.540	10.470	PK
2			24000.000	48.867	38.564	-34.673	83.540	10.302	PK
3			24075.000	48.510	38.472	-35.030	83.540	10.038	PK
4		*	24109.926	104.164	93.527	N/A	N/A	10.637	PK
5			24175.000	49.878	39.464	-33.662	83.540	10.413	PK
6			24234.725	51.395	41.081	-32.145	83.540	10.314	PK

Note 1: Peak Measure Level (dBuV/m) = Reading Level (dBuV) + Factor (dB)

Factor (dB) = Cable Loss (dB) + Antenna Factor (dB/m) - Pre_Amplifier Gain (dB)

Note 2: Limit@1m = $20 \cdot \log(500 \mu\text{V/m}) + 20 \cdot \log(3\text{m}/1\text{m}) = 63.540 \text{ dB}\mu\text{V/m}$ (Average detector), and $83.540 \text{ dB}\mu\text{V/m}$ (Peak detector).

Site: AC2	Time: 2019/02/01 - 15:43
Limit: FCC 109 CLASS B (1M)	Engineer: Milo Li
Probe: BBHA9170_18-40GHz	Polarity: Vertical
EUT: LCD Monitor	Power: AC 120V/60Hz
Test Mode: Transmit at 24.1GHz	

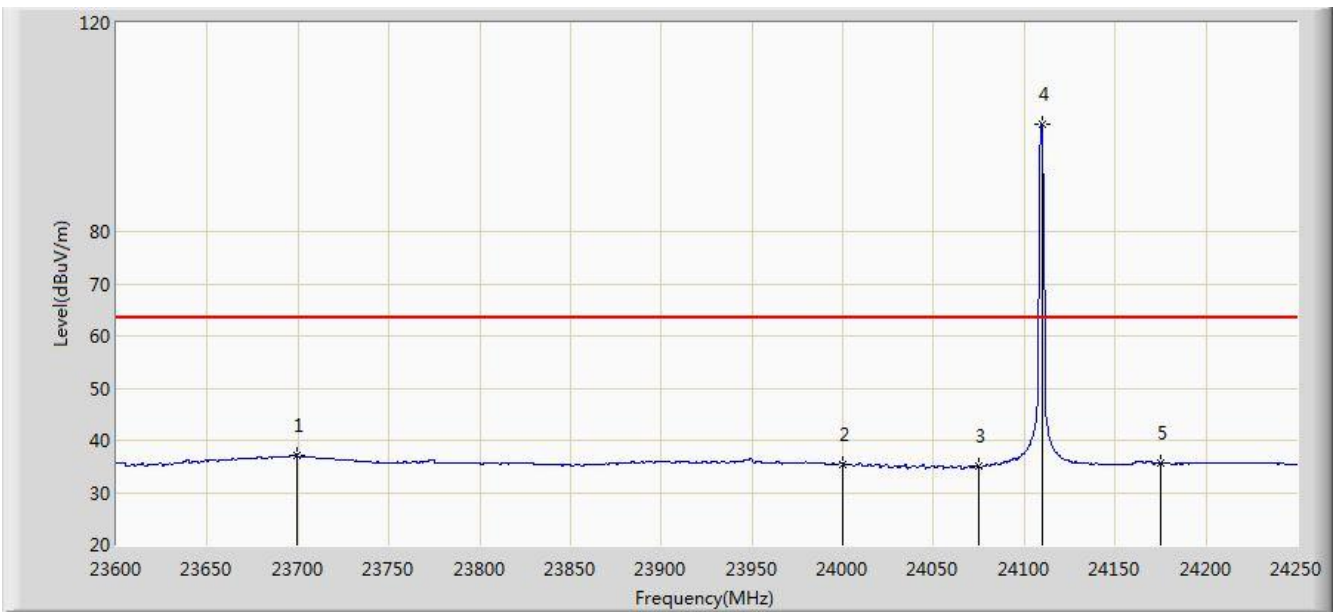

No	Flag	Mark	Frequency (MHz)	Measure Level (dBuV/m)	Reading Level (dBuV)	Over Limit (dB)	Limit (dBuV/m)	Factor (dB)	Type
1			23699.125	37.241	26.523	-26.299	63.540	10.718	AV
2			24000.000	35.458	25.155	-28.082	63.540	10.302	AV
3			24075.000	35.021	24.983	-28.519	63.540	10.038	AV
4		*	24109.600	100.594	89.956	N/A	N/A	10.638	AV
5			24175.000	35.544	25.130	-27.996	63.540	10.413	AV

Note 1: Peak Measure Level (dBuV/m) = Reading Level (dBuV) + Factor (dB)

Factor (dB) = Cable Loss (dB) + Antenna Factor (dB/m) - Pre_Amplifier Gain (dB)

Note 2: Limit@1m = 20*Log(500uV/m) + 20*Log(3m/1m) = 63.540dBuV/m (Average detector), and 83.540dBuV/m (Peak detector).

7.5. AC Conducted Emissions Measurement

7.5.1. Test Limit

FCC 15.207 & RSS-Gen Clause 8.8 Limits		
Frequency (MHz)	QP (dBuV)	AV (dBuV)
0.15 ~ 0.50	66 ~ 56	56 ~ 46
0.50 ~ 5.0	56	46
5.0 ~ 30	60	50

Note 1: The lower limit shall apply at the transition frequencies.

Note 2: The limit decreases linearly with the logarithm of the frequency in the range 0.15MHz to 0.5MHz.

7.5.2. Test Setup

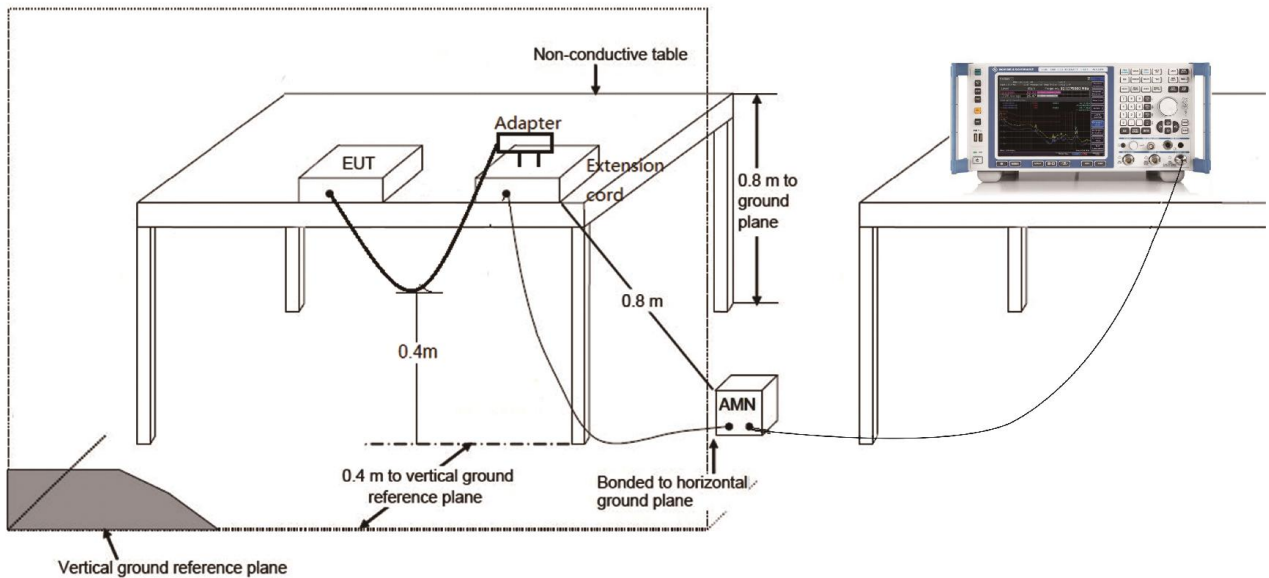

7.5.3. Test Result

Site: SR2	Time: 2019/01/14 - 10:45
Limit: FCC_Part15.207_CE_AC Power	Engineer: Liz Yuan
Probe: ENV216_101683_Filter On	Polarity: Line
EUT: LCD MONITOR	Power: AC 120V/60Hz
Test Mode 1	

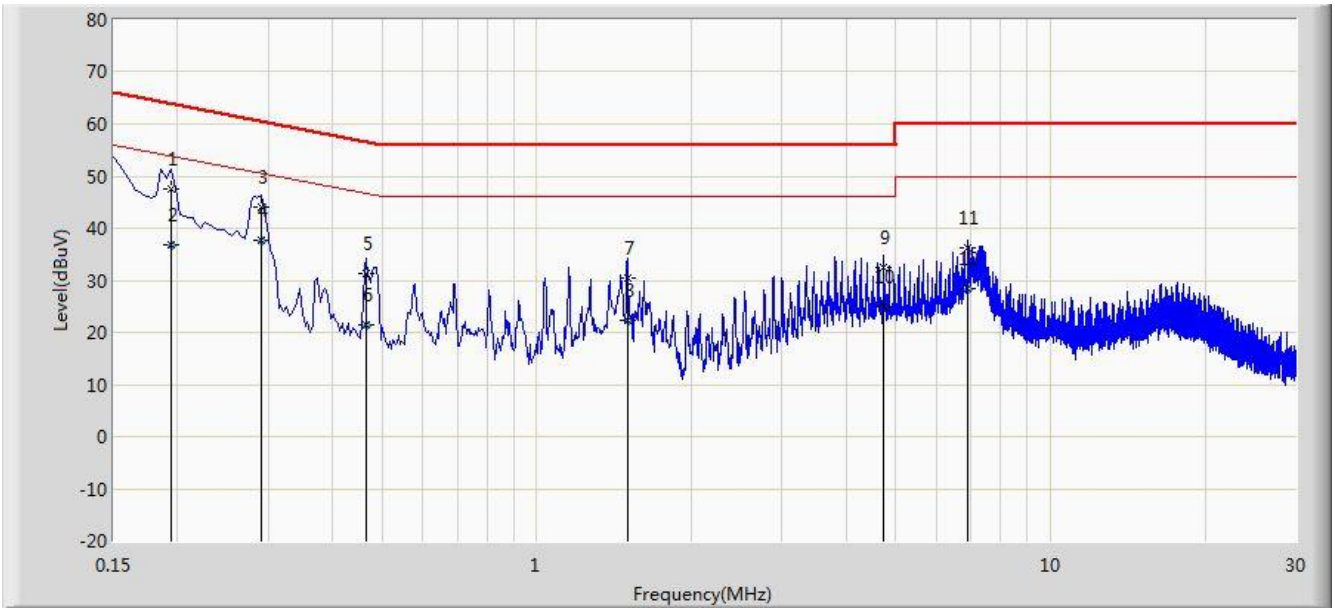

No	Flag	Mark	Frequency (MHz)	Measure Level (dBuV)	Reading Level (dBuV)	Over Limit (dB)	Limit (dBuV)	Factor (dB)	Type
1			0.194	47.625	37.608	-16.239	63.864	10.017	QP
2			0.194	36.701	26.684	-17.162	53.864	10.017	AV
3			0.290	44.043	34.047	-16.481	60.524	9.996	QP
4		*	0.290	37.629	27.633	-12.896	50.524	9.996	AV
5			0.466	31.214	21.075	-25.371	56.585	10.139	QP
6			0.466	21.528	11.389	-25.057	46.585	10.139	AV
7			1.502	30.318	20.429	-25.682	56.000	9.889	QP
8			1.502	22.347	12.459	-23.653	46.000	9.889	AV
9			4.734	32.369	22.355	-23.631	56.000	10.014	QP
10			4.734	25.036	15.022	-20.964	46.000	10.014	AV
11			6.904	36.154	26.000	-23.846	60.000	10.154	QP
12			6.904	28.454	18.300	-21.546	50.000	10.154	AV

Note: Measure Level (dBμV) = Reading Level (dBμV) + Factor (dB)

Factor (dB) = Cable Loss (dB) + LISN Factor (dB).

Site: SR2	Time: 2019/01/14 - 10:54
Limit: FCC_Part15.207_CE_AC Power	Engineer: Liz Yuan
Probe: ENV216_101683_Filter On	Polarity: Neutral
EUT: LCD MONITOR	Power: AC 120V/60Hz
Test Mode 1	

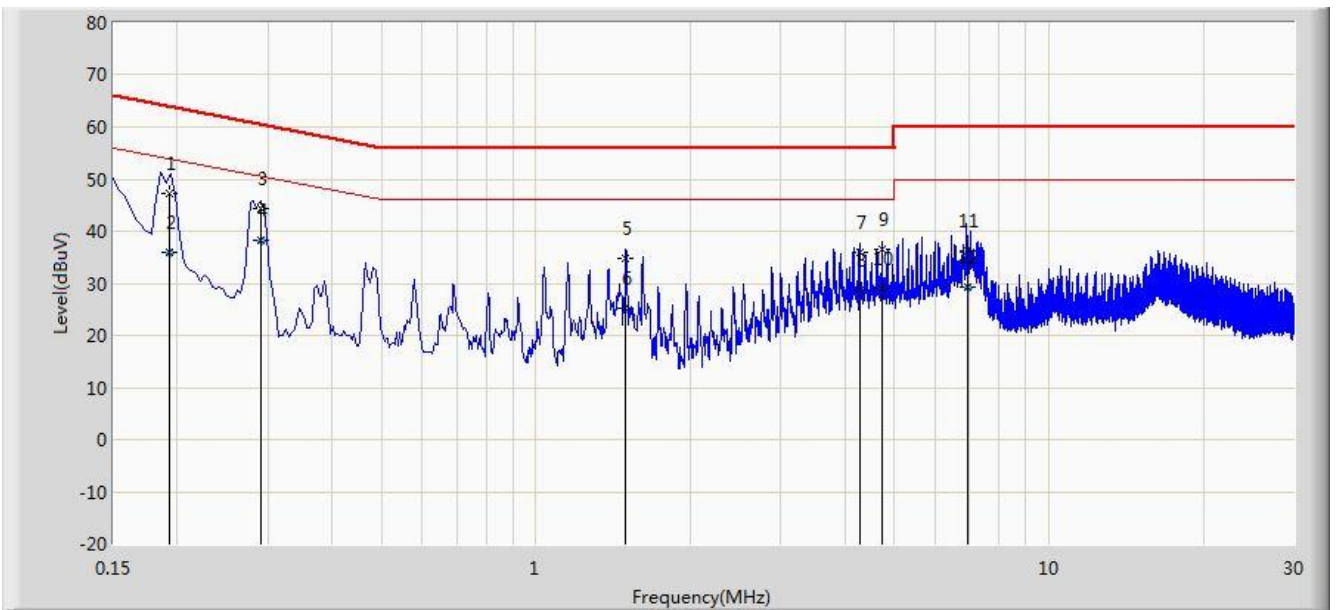

No	Flag	Mark	Frequency (MHz)	Measure Level (dBuV)	Reading Level (dBuV)	Over Limit (dB)	Limit (dBuV)	Factor (dB)	Type
1			0.193	47.323	37.300	-16.584	63.906	10.023	QP
2			0.193	35.823	25.800	-18.084	53.906	10.023	AV
3			0.291	44.231	34.200	-16.265	60.496	10.031	QP
4		*	0.291	38.231	28.200	-12.265	50.496	10.031	AV
5			1.498	34.813	24.922	-21.187	56.000	9.890	QP
6			1.498	25.146	15.255	-20.854	46.000	9.890	AV
7			4.274	35.971	25.984	-20.029	56.000	9.986	QP
8			4.274	28.800	18.814	-17.200	46.000	9.986	AV
9			4.734	36.456	26.433	-19.544	56.000	10.023	QP
10			4.734	29.023	18.999	-16.977	46.000	10.023	AV
11			6.929	36.368	26.200	-23.632	60.000	10.168	QP
12			6.929	29.168	19.000	-20.832	50.000	10.168	AV

Note: Measure Level (dBμV) = Reading Level (dBμV) + Factor (dB)

Factor (dB) = Cable Loss (dB) + LISN Factor (dB).

7.1. Frequency Stability Measurement

7.1.1. Test Limit

RSS-Gen Clause 8.11

If the frequency stability of the licence-exempt radio apparatus is not specified in the applicable RSS, the fundamental emissions of the radio apparatus should be kept within at least the central 80% of its permitted operating frequency band in order to minimize the possibility of out-of-band operation. In addition, its occupied bandwidth shall be entirely outside the restricted bands and the prohibited TV bands of 54-72 MHz, 76-88 MHz, 174-216 MHz, and 470-602 MHz, unless otherwise indicated.

Conclusion:

So there is no requirement for frequency stability, but emission bandwidth should satisfy this requirement.

7.1.2. Test Procedure used

ANSI C63.10 Section 6.9

7.1.3. Test Setup

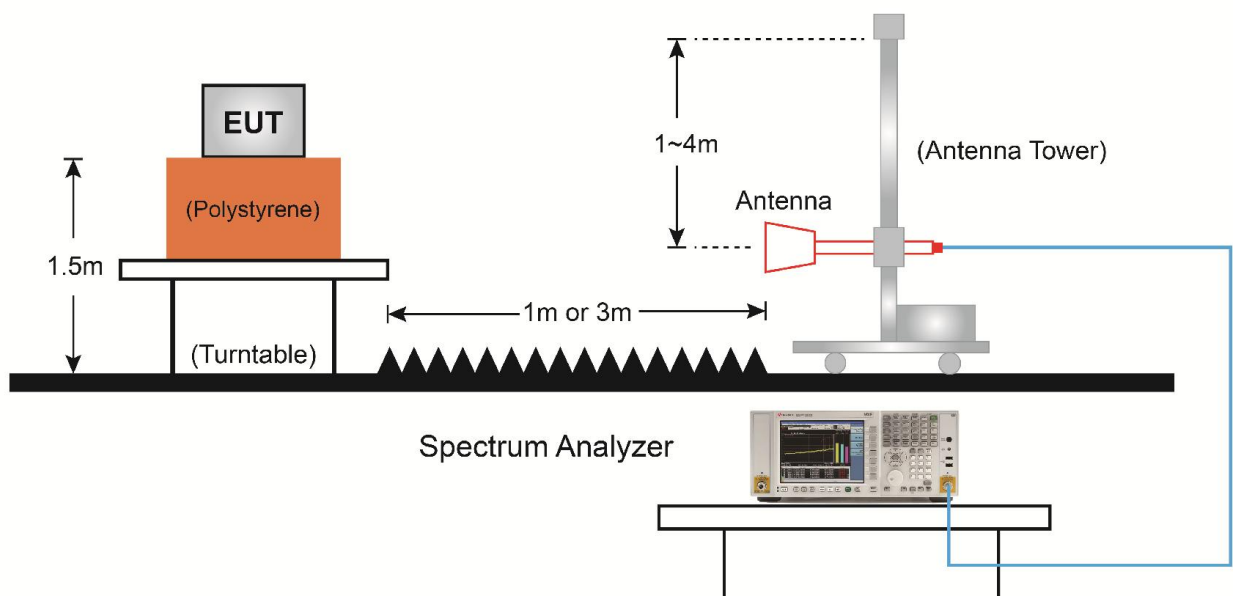

7.1.4. Test Result

Product	LCD MONITOR	Temperature	25°C
Test Engineer	Milo Li	Relative Humidity	56%
Test Site	AC2	Test Date	2019/02/01

99% Bandwidth Range (MHz)	Range Limit (MHz)	Result
$F_L = 24103.817$	$< (\text{LIMIT}_L = 24085)$	Pass
$F_H = 24110.681$	$> (\text{LIMIT}_H = 24165)$	Pass

Note 1: $\text{LIMIT}_L = 24075 \text{ MHz} + (24175 \text{ MHz} - 24075 \text{ MHz}) * 0.1 = 24085 \text{ MHz}$;

$\text{LIMIT}_H = 24175 \text{ MHz} + (24175 \text{ MHz} - 24075 \text{ MHz}) * 0.1 = 24165 \text{ MHz}$;

Note 2: $F_L = 24110 \text{ MHz} - 1.1834 \text{ MHz} = 24108.817 \text{ MHz}$;

$F_H = 24110 \text{ MHz} + 5.6811 \text{ MHz} = 24115.681 \text{ MHz}$;

Note 3: Its occupied bandwidth is outside the restricted bands and the prohibited TV bands of 54-72 MHz, 76-88 MHz, 174-216 MHz, and 470-602 MHz.

8. CONCLUSION

The data collected relate only the item(s) tested and show that the **LCD MONITOR** is in compliance with Part 15C of the FCC Rules and ISED Rules.

————— The End —————

Appendix A - Test Setup Photograph

Refer to "1901RSU004-UT" file.

Appendix B - EUT Photograph

Refer to "1901RSU004-UE" file.