

RADIO TEST REPORT

FCC 47 CFR PART 15 SUBPART C

INDUSTRY CANADA RSS-247

Test Standard	FCC Part 15.247 and IC RSS-247 issue 2
FCC ID	SIB-ICG100NAR-2
ISED ID	6719D-ICG100NAR
Product name	ICG
Brand Name	Intwine connect
Model	ICG-100-NA-R, ICG-100-NA-C
Test Result	Pass

The test Result was tested by Compliance Certification Services Inc. The test data, data evaluation, test procedures, and equipment configurations shown in this report were given in ANSI C63.10: 2013 and compliance standards.

The test results of this report relate only to the tested sample (EUT) identified in this report.

The test Report of full or partial shall not copy. Without written approval of CCS. Inc.

The sample selected for test was production product and was provided by manufacturer.



Approved by:

A handwritten signature in black ink, appearing to read "Sam Chuang".

Sam Chuang
Manager

Tested by:

A handwritten signature in black ink, appearing to read "Ed Chiang".

Ed Chiang
Engineer

Revision History

Rev.	Issue Date	Revisions	Revised By
00	March 30, 2017	Initial Issue	Doris Chu

Table of contents

1. GENERAL INFORMATION	4
1.1 EUT INFORMATION	4
1.2 EUT CHANNEL INFORMATION	5
1.3 ANTENNA INFORMATION	5
1.4 MEASUREMENT UNCERTAINTY	6
1.5 FACILITIES AND TEST LOCATION	7
1.6 INSTRUMENT CALIBRATION	7
1.7 SUPPORT AND EUT ACCESSORIES EQUIPMENT	8
1.9 TABLE OF ACCREDITATIONS AND LISTINGS	8
2. TEST SUMMERY	9
3. DESCRIPTION OF TEST MODES	10
3.1 THE WORST MODE OF OPERATING CONDITION	10
3.2 THE WORST MODE OF MEASUREMENT	11
3.3 EUT DUTY CYCLE	12
4. TEST RESULT	13
4.1 AC POWER LINE CONDUCTED EMISSION	13
4.2 6DB BANDWIDTH AND OCCUPIED BANDWIDTH(99%)	16
4.3 OUTPUT POWER MEASUREMENT	19
4.4 POWER SPECTRAL DENSITY	21
4.5 CONDUCTED BANEDGE AND SPURIOUS EMISSION	24
4.6 RADIATION BANEDGE AND SPURIOUS EMISSION	28
APPENDIX 1 - PHOTOGRAPHS OF EUT	

1. GENERAL INFORMATION

1.1 EUT INFORMATION

Applicant	Foxconn International Inc NO 2 ZIYOU ST TUCHENG DISTRICT NEW TAIPEI 236
Manufacturer	Foxconn International Inc NO 2 ZIYOU ST TUCHENG DISTRICT NEW TAIPEI 236
Equipment	ICG
Model No.	ICG-100-NA-R, ICG-100-NA-C
Model Discrepancy	ICG-100-NA-R: Plastic ICG-100-NA-C: Metal
Trade Name	Intwine connect
Received Date	January 13, 2017
Date of Test	March 24 ~ 27, 2017
Output Power(W)	Zigbee: 0.0406
Power Operation	VDC from Power Adapter For ICG-100-NA-R 1. DVE / DSA-18PFM-12FUS I/P: 100-240Vac, 0.6A, 50-60Hz O/P: 12Vdc, 1.5A 2. MEAN WELL / GST18U12 I/P: 100-240Vac, 0.5A, 50-60Hz O/P: 12Vdc, 1.5A For ICG-100-NA-C 1. DVE / DSA-18PFM-12FUS I/P: 100-240Vac, 0.6A, 50-60Hz O/P: 12Vdc, 1.5A

1.2 EUT CHANNEL INFORMATION

Frequency Range	Zigbee: 2405~2480MHz
Modulation Type	Zigbee: OQPSK (Offset Quadrature Phase Shift Keyed)
Bandwidth	Zigbee: 14 Channels

Remark:

Refer as ANSI 63.10:2013 clause 5.6.1 Table 4 and RSS-GEN Table A1 for test channels

Number of frequencies to be tested		
Frequency range in which device operates	Number of frequencies	Location in frequency range of operation
<input type="checkbox"/> 1 MHz or less	1	Middle
<input type="checkbox"/> 1 MHz to 10 MHz	2	1 near top and 1 near bottom
<input checked="" type="checkbox"/> More than 10 MHz	3	1 near top, 1 near middle, and 1 near bottom

1.3 ANTENNA INFORMATION

Antenna Type	<input type="checkbox"/> PIFA <input type="checkbox"/> PCB <input checked="" type="checkbox"/> Dipole <input type="checkbox"/> Coils
Antenna Gain	1) FIT: 5 dBi 2) Luxshare: 5 dBi

1.4 MEASUREMENT UNCERTAINTY

PARAMETER	UNCERTAINTY
AC Powerline Conducted Emission	+/- 1.2575
Emission bandwidth, 20dB bandwidth	+/- 1.4003
RF output power, conducted	+/- 1.1372
Power density, conducted	+/- 1.4003
3M Semi Anechoic Chamber / 30M~200M	+/- 4.0138
3M Semi Anechoic Chamber / 200M~1000M	+/- 3.9483
3M Semi Anechoic Chamber / 1G~8G	+/- 2.5975
3M Semi Anechoic Chamber / 8G~18G	+/- 2.6112
3M Semi Anechoic Chamber / 18G~26G	+/- 2.7389
3M Semi Anechoic Chamber / 26G~40G	+/- 2.9683
3M Semi Anechoic Chamber / 40G~60G	+/- 1.8509
3M Semi Anechoic Chamber / 60G~75G	+/- 1.9869
3M Semi Anechoic Chamber / 75G~110G	+/- 2.9651
3M Semi Anechoic Chamber / 110G~170G	+/- 2.7807
3M Semi Anechoic Chamber / 170G~220G	+/- 3.6437
3M Semi Anechoic Chamber / 220G~325G	+/- 4.2982

Remark:

1. This uncertainty represents an expanded uncertainty expressed at approximately the 95% confidence level using a coverage factor of $k=2$
2. ISO/IEC 17025 requires that an estimate of the measurement uncertainties associated with the emissions test results be included in the report.

1.5 FACILITIES AND TEST LOCATION

All measurement facilities used to collect the measurement data are located at No. 11, Wugong 6th Rd., Wugu Dist., New Taipei City 24891, Taiwan. (R.O.C.)

Test site	Test Engineer	Remark
AC Conduction Room	Eric Lee	-
Radiation	Ed Chiang	-
RF Conducted	Eric Lee	-

Remark: The sites are constructed in conformance with the requirements of ANSI C63.7, ANSI C63.4 and CISPR Publication 22.

1.6 INSTRUMENT CALIBRATION

RF Conducted Test Site					
Name of Equipment	Manufacturer	Model	Serial Number	Calibration Date	Calibration Due
Power Meter	Anritsu	ML2495A	1012009	07/04/2016	07/03/2017
Power Sensor	Anritsu	MA2411B	917072	07/04/2016	07/03/2017
Spectrum Analyzer	R&S	FSV 40	101073	10/05/2016	10/04/2017

Wugu 966 Chamber A					
Name of Equipment	Manufacturer	Model	Serial Number	Calibration Date	Calibration Due
Bilog Antenna	Sunol Sciences	JB3	A030105	07/03/2016	07/02/2017
Horn Antenna	EMCO	3117	00055165	02/20/2017	02/19/2018
Pre-Amplifier	EMCI	EMC 012635	980151	06/23/2016	06/22/2017
Pre-Amplifier	EMEC	EM330	060609	06/08/2016	06/07/2017
Spectrum Analyzer	Agilent	E4446A	US42510252	12/05/2016	12/04/2017
Antenna Tower	CCS	CC-A-1F	N/A	N.C.R	N.C.R
Controller	CCS	CC-C-1F	N/A	N.C.R	N.C.R
Turn Table	CCS	CC-T-1F	N/A	N.C.R	N.C.R
Software	EZ-EMC (CCS-3A1RE)				

Conducted Emission Room # B					
Name of Equipment	Manufacturer	Model	Serial Number	Calibration Date	Calibration Due
LISN	R&S	ENV216	101054	05/11/2016	05/10/2017
LISN	SCHWARZBECK	NSLK 8127	8127-541	11/22/2016	11/21/2017
Receiver	R&S	ESCI	101073	08/20/2016	08/19/2017

Remark: Each piece of equipment is scheduled for calibration once a year.

1.7 SUPPORT AND EUT ACCESSORIES EQUIPMENT



EUT Accessories Equipment					
No.	Equipment	Brand	Model	Series No.	FCC ID
	N/A				

Support Equipment					
No.	Equipment	Brand	Model	Series No.	FCC ID
1	Notebook	Acer	Aspire 4320 series	N/A	QDS-BRCM1018

1.8 TEST METHODOLOGY AND APPLIED STANDARDS

The test methodology, setups and results comply with all requirements in accordance with ANSI C63.10:2013, FCC Part 2, FCC Part 15.247, KDB 558074 D01 v03r05, RSS-247 Issue 2 and RSS-GEN Issue 4

1.9 TABLE OF ACCREDITATIONS AND LISTINGS

Country	Agency	Scope of Accreditation	Logo
USA	FCC	3M Semi Anechoic Chamber (FCC MRA: TW1039) to perform FCC Part 15 measurements	 FCC MRA: TW1039
Canada	Industry Canada	3M Semi Anechoic Chamber (IC 2324G-1 / IC 2324G-2) to perform	 IC 2324G-1 IC 2324G-2

2. TEST SUMMERY

FCC Standard Section	ISED Standard Section	Chapter	Test Item	Result
15.203	-	1.3	Antenna Requirement	Pass
15.207	RSS-GEN 8.8	4.1	AC Conducted Emission	Pass
15.247(a)(2)	RSS-247(5.2)(a)	4.2	6 dB Bandwidth	Pass
-	RSS-GEN 6.6	4.2	Occupied Bandwidth (99%)	-
15.247(b)	RSS-247(5.4)(d)	4.3	Output Power Measurement	Pass
15.247(e)	RSS-247(5.2)(b)	4.4	Power Spectral Density	Pass
15.247(d)	RSS-247(5.5)	4.5	Conducted Band Edge	Pass
15.247(d)	RSS-247(5.5)	4.5	Conducted Emission	Pass
15.247(d)	RSS-247(5.5)	4.6	Radiation Band Edge	Pass
15.247(d)	RSS-247(5.5)	4.6	Radiation Spurious Emission	Pass

3. DESCRIPTION OF TEST MODES

3.1 THE WORST MODE OF OPERATING CONDITION

Operation mode	Zigbee
Test Channel Frequencies	Zigbee: 1. Lowest Channel : 2405MHz 2. Middle Channel : 2440MHz 3. Highest Channel : 2480MHz

Remark:

1. EUT pre-scanned data rate of output power for each mode, the worst data rate were recorded in this report.

3.2 THE WORST MODE OF MEASUREMENT

Zigbee

AC Power Line Conducted Emission	
Test Condition	AC Power line conducted emission for line and neutral
Voltage/Hz	120V/60Hz
Test Mode	Mode 1:EUT power by AC adapter via power cable.
Worst Mode	<input checked="" type="checkbox"/> Mode 1 <input type="checkbox"/> Mode 2 <input type="checkbox"/> Mode 3 <input type="checkbox"/> Mode 4

Radiated Emission Measurement Below 1G	
Test Condition	Radiated Emission Below 1G
Voltage/Hz	120V/60Hz
Test Mode	Mode 1:EUT power by AC adapter via power cable.
Worst Mode	<input checked="" type="checkbox"/> Mode 1 <input type="checkbox"/> Mode 2 <input type="checkbox"/> Mode 3 <input type="checkbox"/> Mode 4

Radiated Emission Measurement Above 1G	
Test Condition	Band edge, Emission for Unwanted and Fundamental
Voltage/Hz	120V/60Hz
Test Mode	Mode 1:EUT power by AC adapter via power cable.
Worst Mode	<input checked="" type="checkbox"/> Mode 1 <input type="checkbox"/> Mode 2 <input type="checkbox"/> Mode 3 <input type="checkbox"/> Mode 4
Worst Position	<input type="checkbox"/> Placed in fixed position. <input checked="" type="checkbox"/> Placed in fixed position at X-Plane (E2-Plane) <input type="checkbox"/> Placed in fixed position at Y-Plane (E1-Plane) <input type="checkbox"/> Placed in fixed position at Z-Plane (H-Plane)
Worst Polarity	<input checked="" type="checkbox"/> Horizontal <input type="checkbox"/> Vertical

Remark:

1. The worst mode was record in this test report.
2. EUT pre-scanned in three axis ,X,Y, Z and two polarity, Horizontal and Vertical for radiated measurement. The worst case(X-Plane and Horizontal) were recorded in this report
3. For AC power line conducted emission and below 1G radiation emission were performed the EUT transmit at the highest output power channel as worse case.
4. EUT pre-scanned in ICG-100-NA-Cand ICG-100-NA-R for below 1GHz radiated measurement. The worst case ICG-100-NA-R were recorded in this report.

3.3 EUT DUTY CYCLE

Duty Cycle				
Configuration	TX ON (ms)	TX ALL (ms)	Duty Cycle (%)	Duty Factor(dB)
Zigbee	100.0000	100.0000	100.00%	0.00

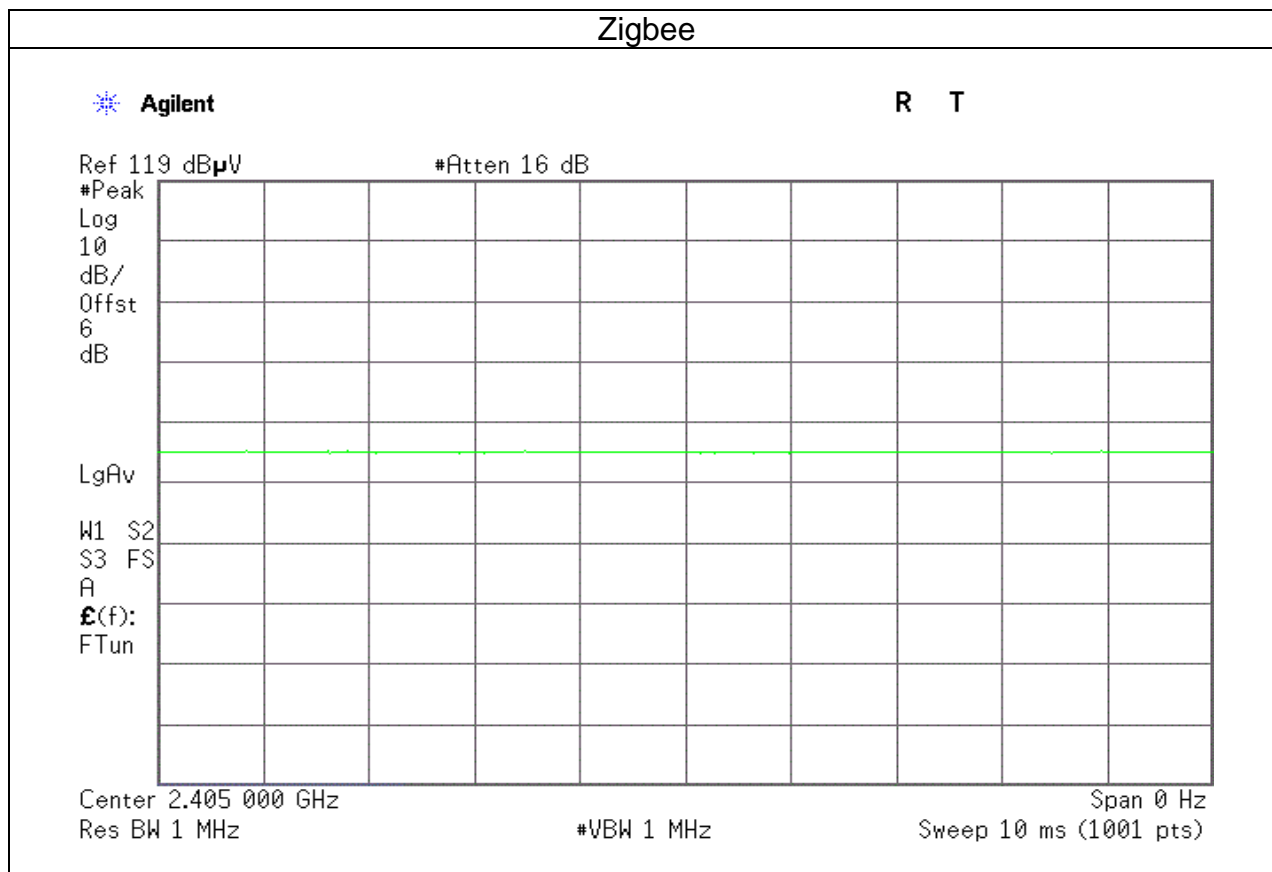

4. TEST RESULT

4.1 AC POWER LINE CONDUCTED EMISSION

4.1.1 Test Limit

According to §15.207(a)(2) and RSS-GEN section 8.8,

Frequency Range (MHz)	Limits(dBµV)	
	Quasi-peak	Average
0.15 to 0.50	66 to 56*	56 to 46*
0.50 to 5	56	46
5 to 30	60	50

* Decreases with the logarithm of the frequency.

4.1.2 Test Procedure

Test method Refer as ANSI 63.10:2013 clause 6.2,

1. The EUT was placed on a non-conducted table, which is 0.8m above horizontal ground plane and 0.4m above vertical ground plane.
2. EUT connected to the line impedance stabilization network (LISN)
3. Receiver set RBW of 9kHz and Detector Peak, and note as quasi-peak and average.
4. Maximum procedure was performed on the six highest emissions to ensure EUT compliance.
5. Recorded Line for Neutral and Line.

4.1.3 Test Setup

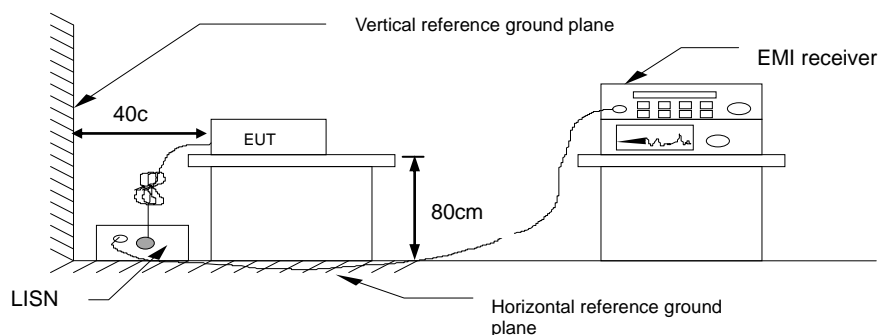

4.1.4 Test Result

Pass.

Test Data

Test Mode:	Mode 1	Temp/Hum	24(°C)/ 50%RH
Test Voltage:	120Vac / 60Hz	Test Date	March 29, 2017
Phase:	Line	Test Engineer	Eric Lee

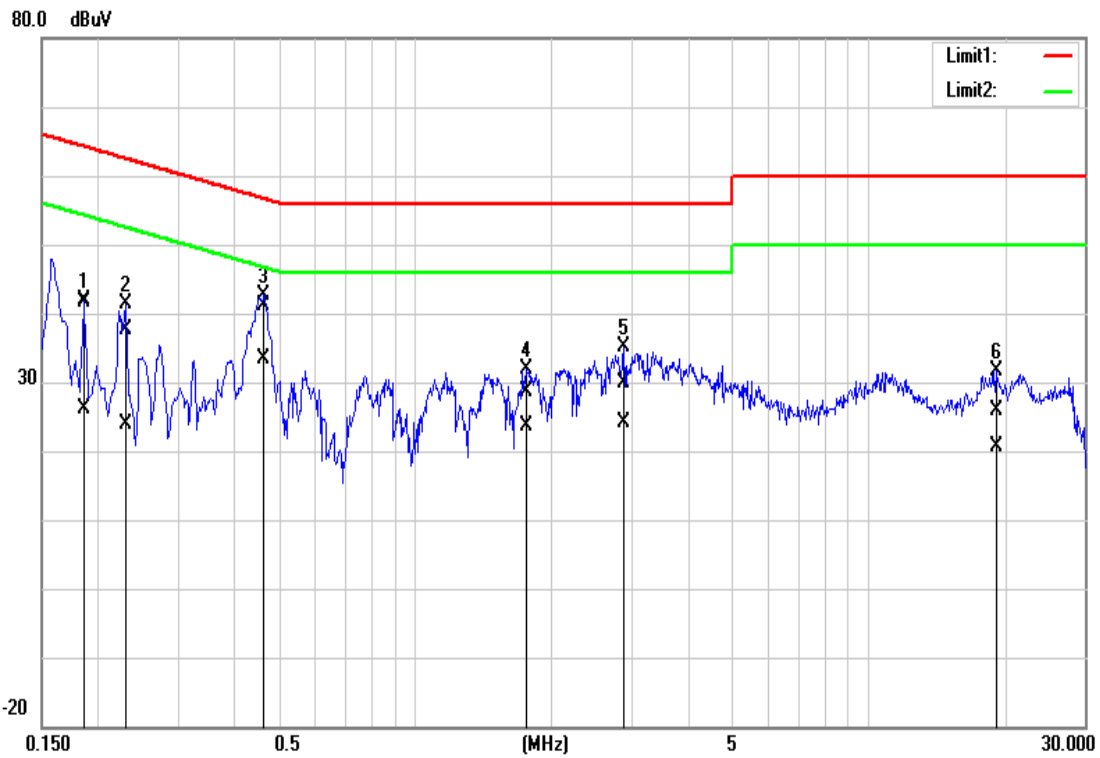

Frequency (MHz)	QuasiPeak reading (dBuV)	Average reading (dBuV)	Correction factor (dB)	QuasiPeak result (dBuV)	Average result (dBuV)	QuasiPeak limit (dBuV)	Average limit (dBuV)	QuasiPeak margin (dB)	Average margin (dB)
0.1860	32.04	16.42	9.69	41.73	26.11	64.21	54.21	-22.48	-28.10
0.2300	27.83	14.17	9.69	37.52	23.86	62.45	52.45	-24.93	-28.59
0.4660	31.48	23.76	9.68	41.16	33.44	56.58	46.58	-15.42	-13.14
1.7700	19.02	13.84	9.70	28.72	23.54	56.00	46.00	-27.28	-22.46
2.8940	20.07	14.53	9.70	29.77	24.23	56.00	46.00	-26.23	-21.77
19.1620	16.07	10.84	9.85	25.92	20.69	60.00	50.00	-34.08	-29.31

Test Mode:	Mode 1	Temp/Hum	27(°C)/ 53%RH
Test Voltage:	120Vac / 60Hz	Test Date	March 29, 2017
Phase:	Neutral	Test Engineer	Eric Lee

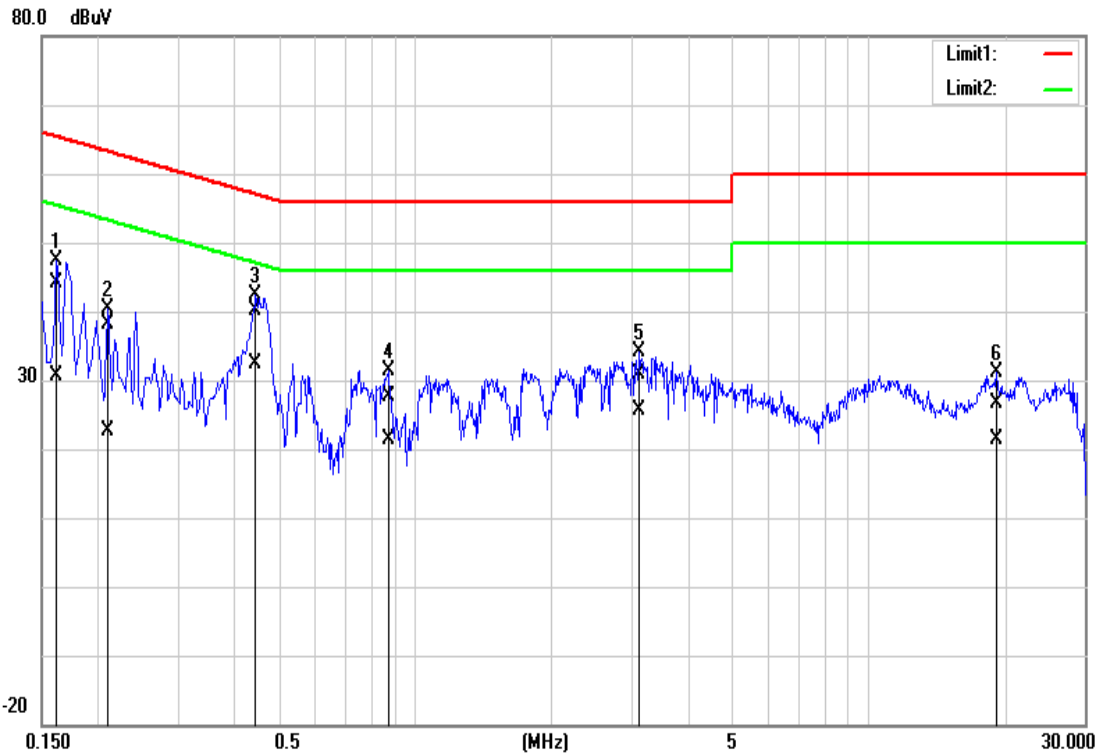

Frequency (MHz)	QuasiPeak reading (dBuV)	Average reading (dBuV)	Correction factor (dB)	QuasiPeak result (dBuV)	Average result (dBuV)	QuasiPeak limit (dBuV)	Average limit (dBuV)	QuasiPeak margin (dB)	Average margin (dB)
0.1620	34.48	20.82	9.71	44.19	30.53	65.36	55.36	-21.17	-24.83
0.2100	28.33	12.96	9.70	38.03	22.66	63.21	53.21	-25.18	-30.55
0.4460	30.39	22.74	9.69	40.08	32.43	56.95	46.95	-16.87	-14.52
0.8740	17.98	11.74	9.69	27.67	21.43	56.00	46.00	-28.33	-24.57
3.1300	21.11	16.01	9.71	30.82	25.72	56.00	46.00	-25.18	-20.28
19.1420	16.66	11.50	9.92	26.58	21.42	60.00	50.00	-33.42	-28.58

4.2 6DB BANDWIDTH AND OCCUPIED BANDWIDTH(99%)

4.2.1 Test Limit

According to §15.247(a)(2) and RSS-247 section 5.2(a),

6 dB Bandwidth :

Limit	Shall be at least 500kHz
-------	--------------------------

Occupied Bandwidth(99%) : For reporting purposes only.

4.2.2 Test Procedure

Test method Refer as KDB 558074 D01 v03r05, Section 8.1 and ANSI 63.10:2013 clause 11.8.1

1. The EUT RF output connected to the spectrum analyzer by RF cable.
2. Setting maximum power transmit of EUT
3. SA set RBW = 100kHz, VBW = 300kHz and Detector = Peak, to measurement 6 dB Bandwidth and 99% Bandwidth.
4. Measure and record the result of 6 dB Bandwidth and 99% Bandwidth in the test report.

4.2.3 Test Setup

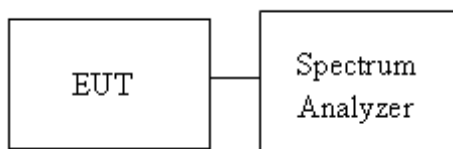

4.2.4 Test Result

Test mode: Zigbee / 2405-2480 MHz				
Channel	Frequency (MHz)	OBW(99%) (MHz)	6dB BW (MHz)	6dB limit (kHz)
Low	2405	2.5904	1.6210	≥500
Mid	2440	2.5904	1.6060	
High	2480	2.5904	1.6210	

Test Data

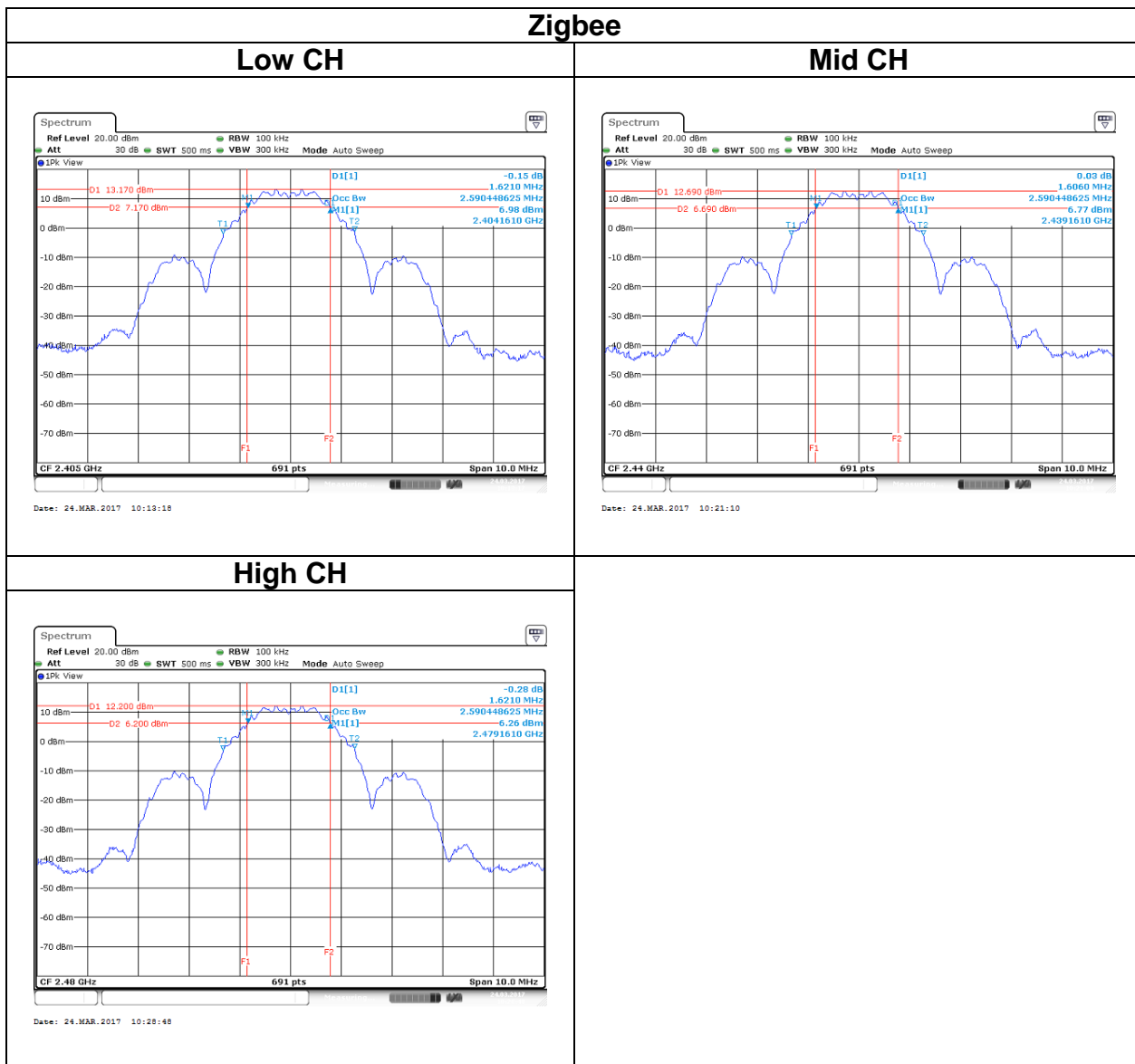

4.3 OUTPUT POWER MEASUREMENT

4.3.1 Test Limit

According to §15.247(b) and RSS-247 section 5.4(d),

Peak output power :

For systems using digital modulation in the 2400-2483.5 MHz, and 5725-5850 MHz bands: 1 Watt(30 dBm), base on the use of antennas with directional gain not exceed 6 dBi If transmitting antennas of directional gain greater than 6dBi are used the peak output power the conducted output power from the intentional radiator shall be reduced by the amount in dB that the directional gain of the antenna exceeds 6 dBi. In case of point-to-point operation, the limit has to be reduced by 1dB for every 3 dB that the directional gain of the antenna exceeds 6 dBi.

Limit	<input checked="" type="checkbox"/> Antenna not exceed 6 dBi : 30dBm <input type="checkbox"/> Antenna with DG greater than 6 dBi : [Limit = 30 – (DG – 6)] <input type="checkbox"/> Point-to-point operation :
-------	---

Average output power : For reporting purposes only.

4.3.2 Test Procedure

Test method Refer as KDB 558074 D01 v03r05, Section 9.1.2.

1. The EUT RF output connected to the power meter by RF cable.
2. Setting maximum power transmit of EUT.
3. The path loss was compensated to the results for each measurement.
4. Measure and record the result of Peak output power and Average output power in the test report.

4.3.3 Test Setup

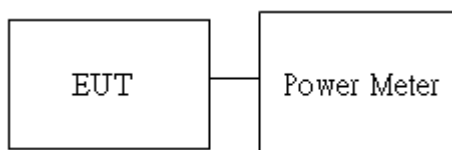

4.3.4 Test Result

Peak output power :

Channel	Frequency (MHz)	Output Power (dBm)	Output Power (W)	Limit (W)	Test Result
Low	2405	*16.09	0.0406	1	PASS
Mid	2440	15.78	0.0378		PASS
High	2480	15.60	0.0363		PASS

Average output power :

Channel	Frequency (MHz)	Output Power (dBm)	Output Power (W)
Low	2405	15.78	0.0378
Mid	2440	15.46	0.0352
High	2480	15.26	0.0336

4.4 POWER SPECTRAL DENSITY

4.4.1 Test Limit

According to §15.247(e) and RSS-247 section 5.2(b),

For digitally modulated systems, the power spectral density conducted from the intentional radiator to the antenna shall not be greater than 8 dBm in any 3 kHz band during any time interval of continuous transmission.

Limit	<input checked="" type="checkbox"/> Antenna not exceed 6 dBi : 8dBm <input type="checkbox"/> Antenna with DG greater than 6 dBi [Limit = 8 – (DG – 6)] <input type="checkbox"/> Point-to-point operation :
-------	--

4.4.2 Test Procedure

Test method Refer as KDB 558074 D01 v03r05, Section 10.2

1. The EUT RF output connected to the spectrum analyzer by RF cable.
2. Setting maximum power transmit of EUT
3. SA set RBW = 3kHz, VBW = 30kHz, Span = 1.5 times DTS Bandwidth (6 dB BW), Detector = Peak, Sweep Time = Auto and Trace = Max hold.
4. The path loss and Duty Factor were compensated to the results for each measurement by SA.
5. Mark the maximum level.
6. Measure and record the result of power spectral density. in the test report.

4.4.3 Test Setup

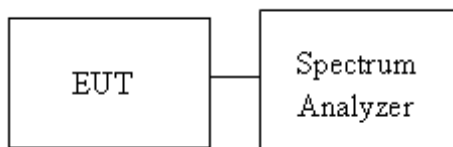

4.4.4 Test Result

Test mode: Zigbee / 2405-2480 MHz			
Channel	Frequency (MHz)	PPSD (dBm)	Limit (dBm)
Low	2405	1.94	8
Mid	2440	1.87	
High	2480	2.17	

Test Data

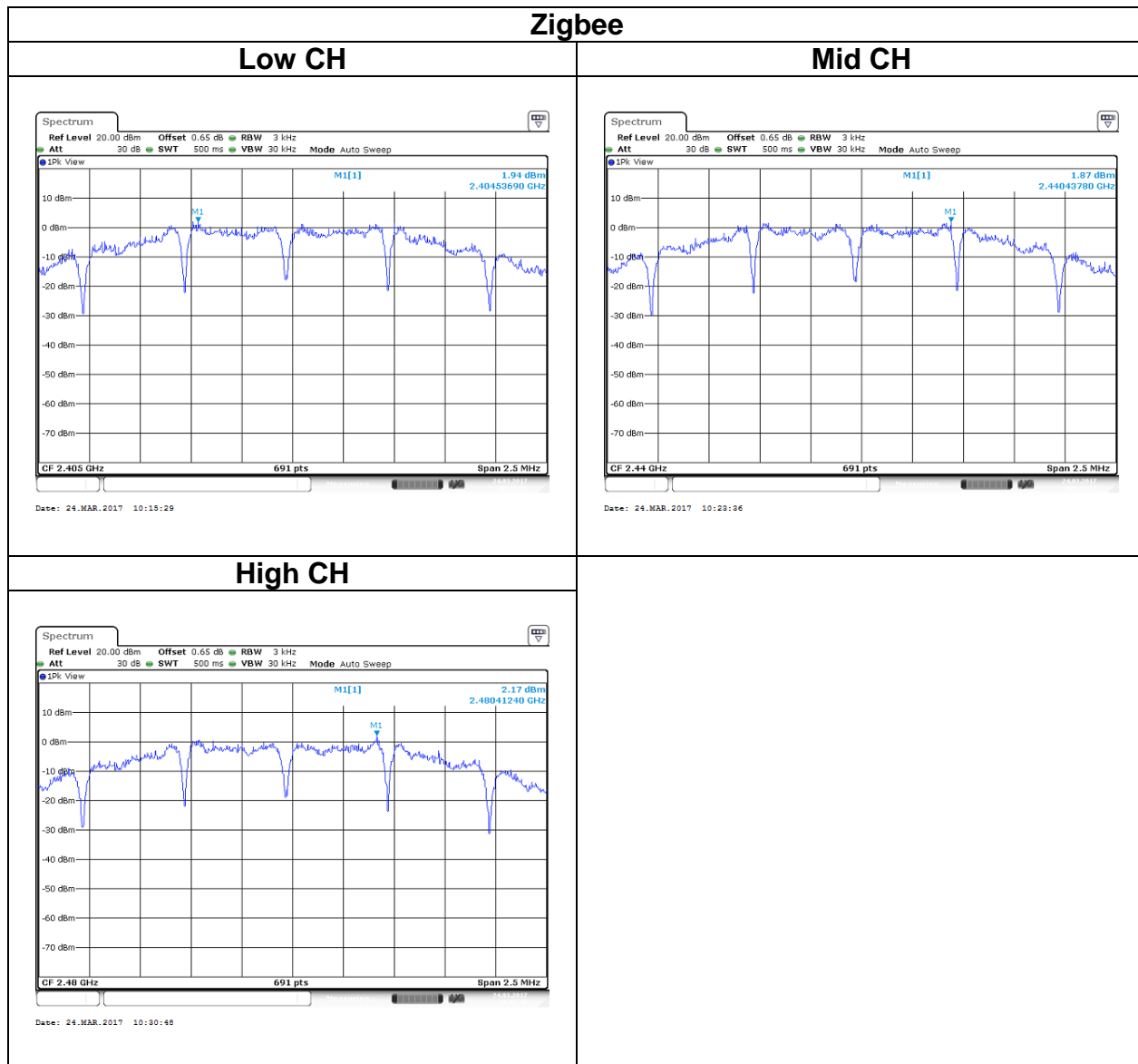

4.5 CONDUCTED BANDEDGE AND SPURIOUS EMISSION

4.5.1 Test Limit

According to §15.247(d) and RSS-247 section 5.5,

In any 100 kHz bandwidth outside the authorized frequency band,

Non-restricted bands shall be attenuated at least 20 dB/30 dB relative to the maximum PSD level in 100 kHz by RF conducted or a radiated measurement which fall in the restricted bands, as defined in §15.205(a), must also comply with the radiated emission limits specified in §15.209(a).

4.5.2 Test Procedure

Test method Refer as KDB 558074 D01 v03r05, Section 11.

1. EUT RF output port connected to the SA by RF cable, and the path loss was compensated to result.
2. SA setting, RBW=100kHz, VBW=300kHz, Detector=Peak, Trace mode = max hold, SWT = Auto.
3. In any 100 kHz bandwidth outside the authorized frequency band, shall be attenuated at least 20 dB relative to the maximum in-band peak PSD level in 100 kHz when conducted power procedure is used. If the transmitter complies with the conducted power limits based on the use of RMS averaging over a time interval, the attenuation required under this paragraph shall be 30 dB instead of 20 dB.

4.5.3 Test Setup

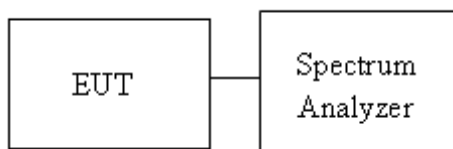

4.5.4 Test Result

Test Data

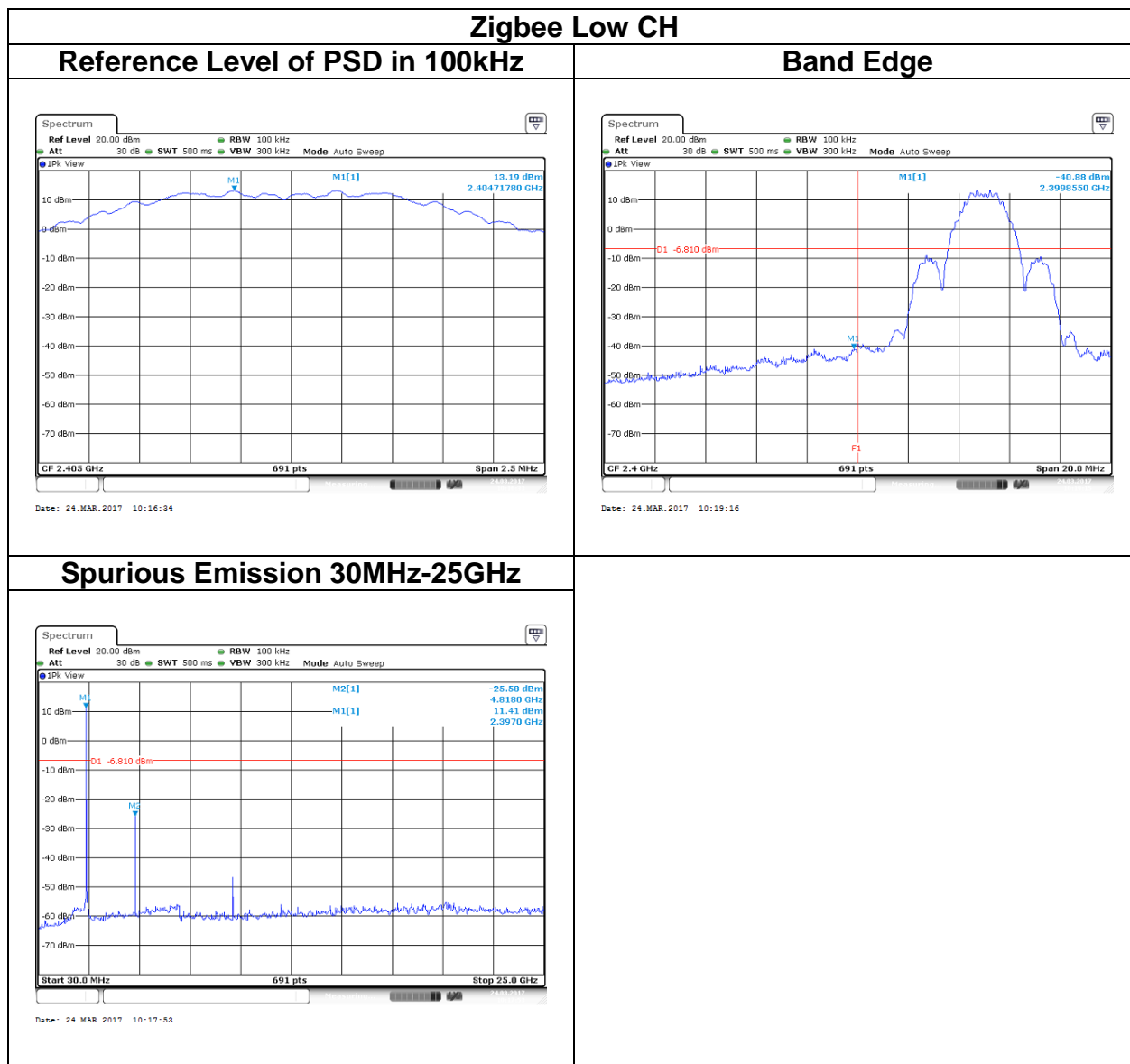

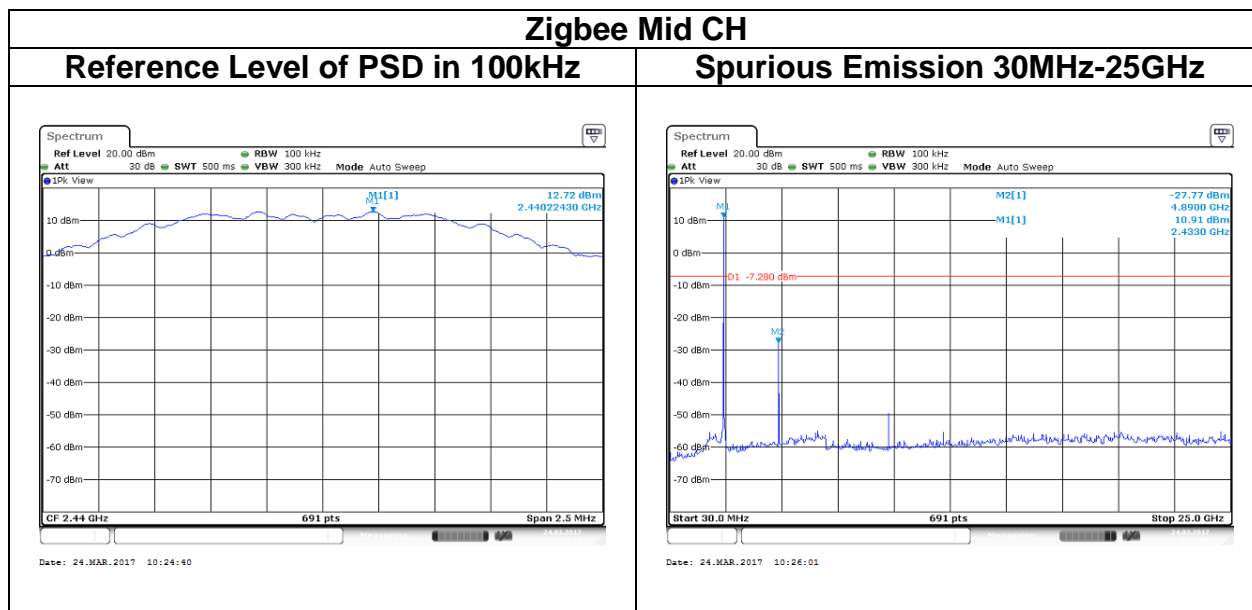

Zigbee High CH

Reference Level of PSD in 100kHz

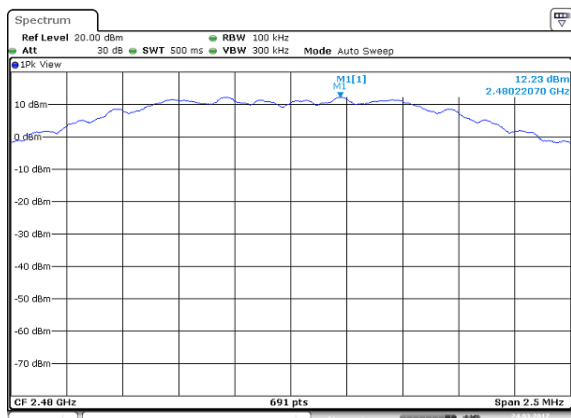

Date: 24.MAR.2017 10:31:48

Band Edge

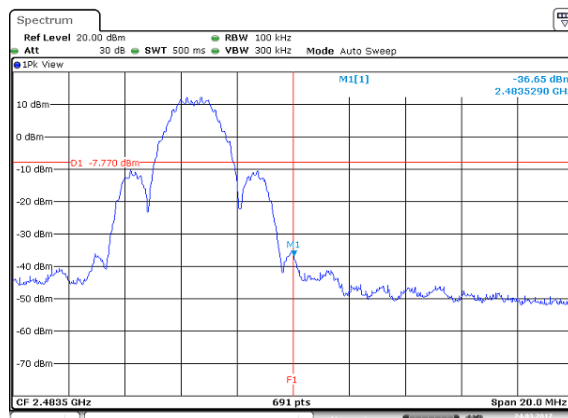

Date: 24.MAR.2017 10:33:44

Spurious Emission 30MHz-25GHz

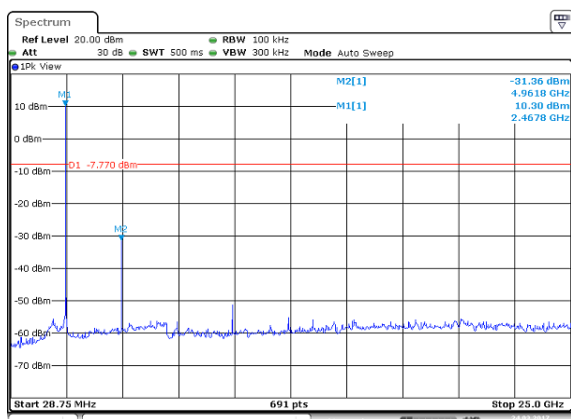

Date: 24.MAR.2017 10:32:41

4.6 RADIATION BANDEGE AND SPURIOUS EMISSION

4.6.1 Test Limit

FCC according to §15.247(d), §15.209 and §15.205

IC according to RSS-247 section 5.5, RSS-Gen, Section 8.9 and 8.10,

In any 100 kHz bandwidth outside the authorized frequency band, all harmonic and spurious must be least 20 dB below the highest emission level with the authorized frequency band. Radiation emission which fall in the restricted bands must also follow the FCC section 15.209 as below limit in table.

Below 30 MHz

Frequency	Field Strength (microvolts/m)	Magnetic H-Field (microamperes/m)	Measurement Distance (metres)
9-490 kHz	2,400/F (F in kHz)	2,400/F (F in kHz)	300
490-1,705 kHz	24,000/F (F in kHz)	24,000/F (F in kHz)	30
1.705-30 MHz	30	N/A	30

Above 30 MHz

Frequency (MHz)	Field Strength microvolts/m at 3 metres (watts, e.i.r.p.)	
	Transmitters	Receivers
30-88	100 (3 nW)	100 (3 nW)
88-216	150 (6.8 nW)	150 (6.8 nW)
216-960	200 (12 nW)	200 (12 nW)
Above 960	500 (75 nW)	500 (75 nW)

Remark:

Although these tests were performed other than open area test site, adequate comparison measurements were confirmed against 30 m open are test site. Therefore sufficient tests were made to demonstrate that the alternative site produces results that correlate with the ones of tests made in an open field based on KDB 937606.

4.6.2 Test Procedure

Test method Refer as KDB 558074 D01 v03r05, Section 12.1.

1. The EUT is placed on a turntable, Above 1 GHz is 1.5m and below 1 GHz is 0.8m above ground plane. The EUT Configured un accordance with ANSI C63.10, and the EUT set in a continuous mode.
2. The turntable shall be rotated for 360 degrees to determine the position of maximum emission level. And EUT is set 3m away from the receiving antenna, which is scanned from 1m to 4m above the ground plane to find out the highest emissions. Measurement are made polarized in both the vertical and the horizontal positions with antenna.
3. Span shall wide enough to full capture the emission measured. The SA from 30MHz to 26.5GHz set to the low, Mid and High channels with the EUT transmit.
5. The SA setting following :
 - (1) Below 1G : RBW = 100kHz, VBW \geq 3 RBW, Sweep = Auto, Detector = Peak, Trace = Max hold.
 - (2) Above 1G :
 - (2.1) For Peak measurement : RBW = 1MHz, VBW \geq 3 RBW, Sweep = Auto, Detector = Peak, Trace = Max hold.
 - (2.2) For Average measurement : RBW = 1MHz, VBW
 - If Duty Cycle \geq 98%, VBW=10Hz.
 - If Duty Cycle < 98%, VBW \geq 1/T.

Configuration	Duty Cycle (%)	T(ms)	1/T (kHz)	VBW Setting
Zigbee	100.00%	100.0000	-	10Hz

4.6.3 Test Setup

9kHz ~ 30MHz

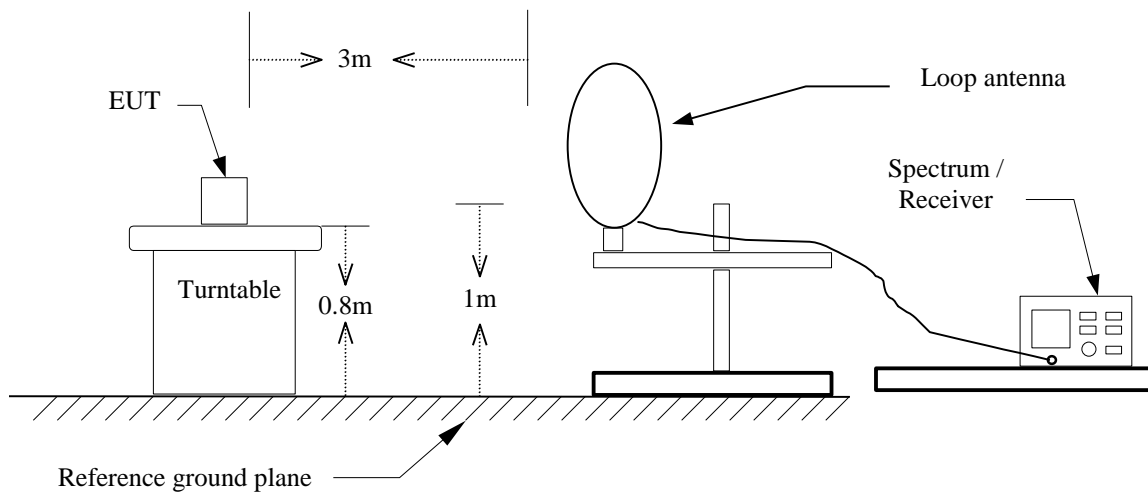

30MHz ~ 1GHz

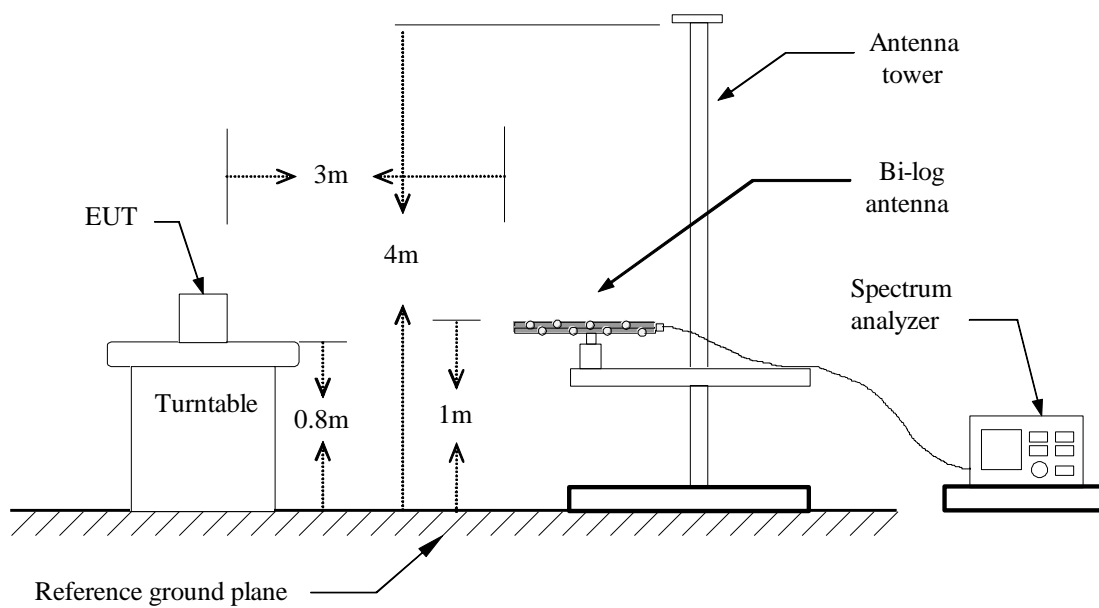

Above 1 GHz

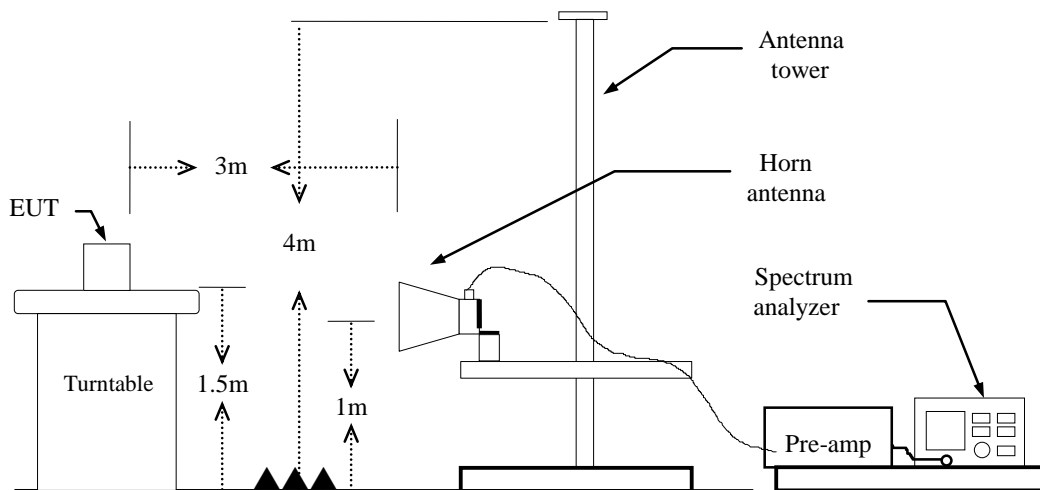

4.6.4 Test Result

Band Edge Test Data

Test Mode	Zigbee Low CH	Temp/Hum	27(°C)/ 53%RH
Test Item	Band Edge	Test Date	March 26, 2017
Polarize	Horizontal	Test Engineer	Ed Chiang
Detector	Peak		

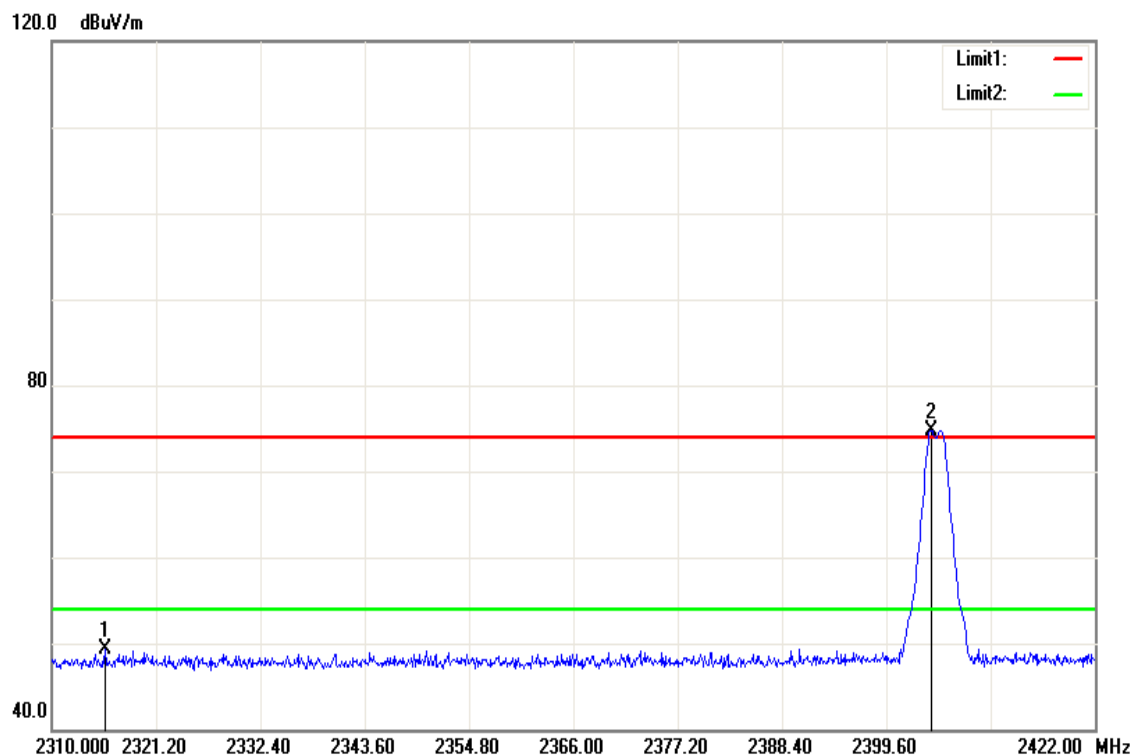

Frequency (MHz)	Reading (dBuV)	Correct Factor(dB/m)	Result (dBuV/m)	Limit (dBuV/m)	Margin (dB)	Remark
2315.712	52.84	-3.58	49.26	74.00	-24.74	peak
2404.416	78.05	-3.25	74.80	-	-	peak

Test Mode	Zigbee Low CH	Temperature:	27(°C)/ 53%RH
Test Item	Band Edge	Test Date	March 26, 2017
Polarize	Horizontal	Test Engineer	Ed Chiang
Detector	Average		

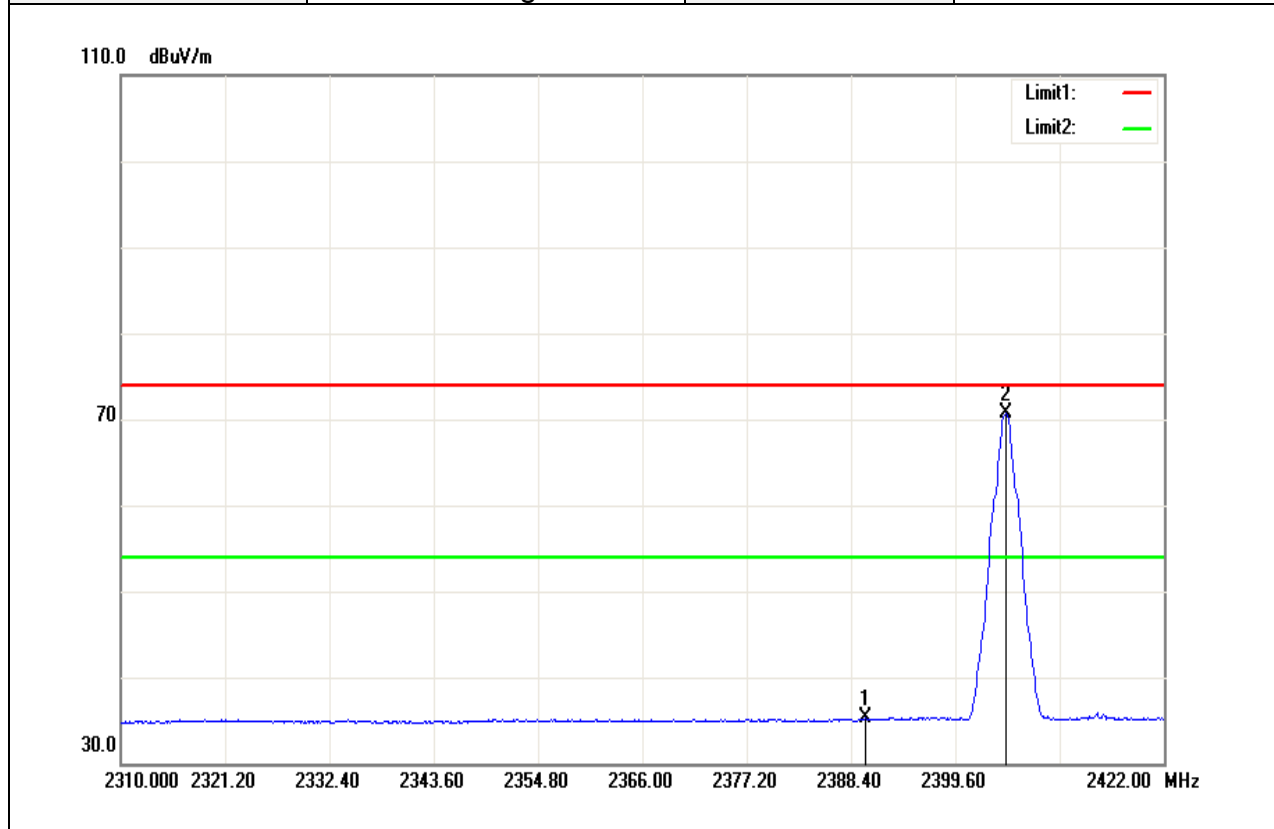

Frequency (MHz)	Reading (dBuV)	Correct Factor(dB/m)	Result (dBuV/m)	Limit (dBuV/m)	Margin (dB)	Remark
2389.968	38.51	-3.28	35.23	54.00	-18.77	AVG
2404.976	73.93	-3.25	70.68	-	-	AVG

Test Mode	Zigbee High CH	Temp/Hum	27(°C)/ 53%RH
Test Item	Band Edge	Test Date	March 26, 2017
Polarize	Horizontal	Test Engineer	Ed Chiang
Detector	Peak		

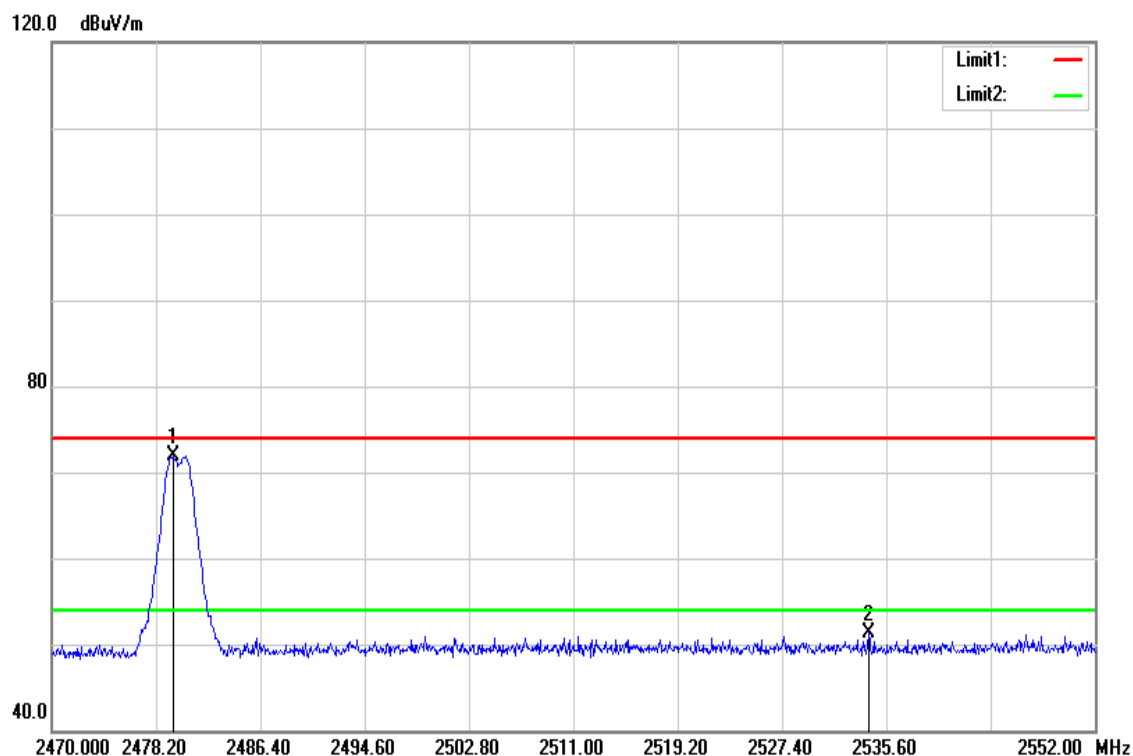

Frequency (MHz)	Reading (dBuV)	Correct Factor(dB/m)	Result (dBuV/m)	Limit (dBuV/m)	Margin (dB)	Remark
2479.512	73.90	-2.03	71.87	-	-	peak
2534.206	53.17	-1.77	51.40	74.00	-22.60	peak

Test Mode	Zigbee High CH	Temperature:	27(°C)/ 53%RH
Test Item	Band Edge	Test Date	March 26, 2017
Polarize	Horizontal	Test Engineer	Ed Chiang
Detector	Average		

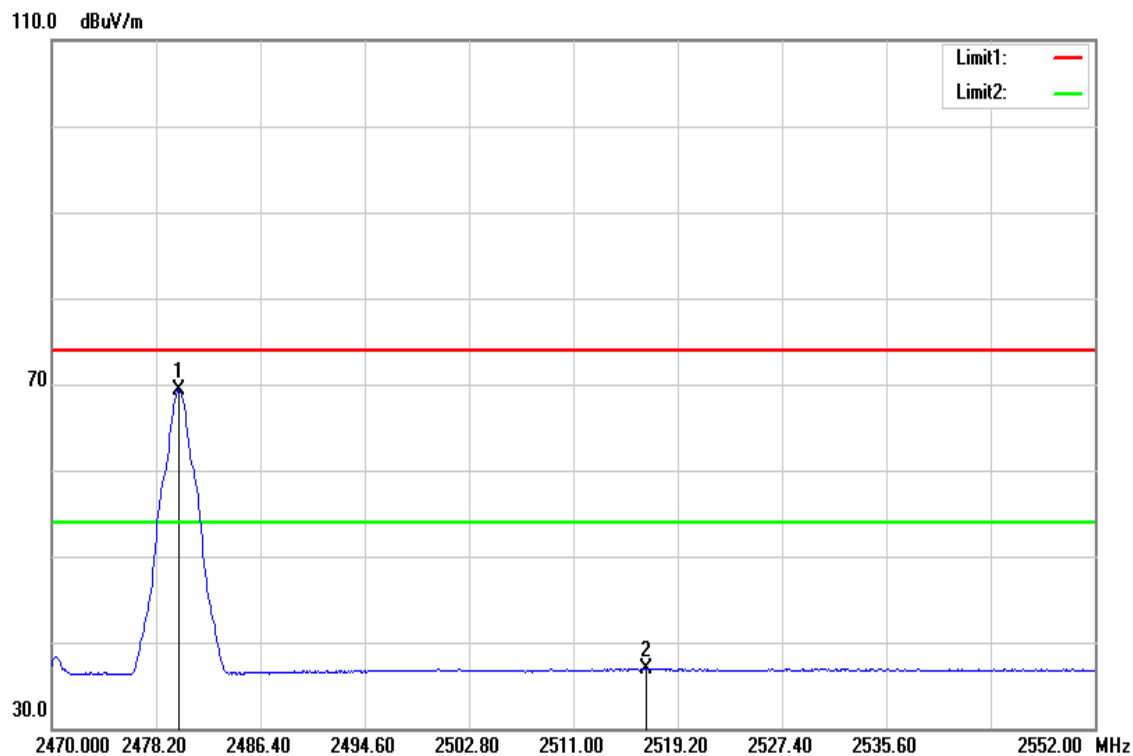

Frequency (MHz)	Reading (dBuV)	Correct Factor(dB/m)	Result (dBuV/m)	Limit (dBuV/m)	Margin (dB)	Remark
2480.004	71.25	-2.03	69.22	-	-	AVG
2516.740	38.76	-1.82	36.94	54.00	-17.06	AVG

Below 1GHz

Test Mode	Mode 1	Temp/Hum	27(°C)/ 53%RH
Test Item	30MHz-1GHz	Test Date	March 27, 2017
Polarize	Vertical	Test Engineer	Ed Chiang
Detector	Peak and Qusi-peak		

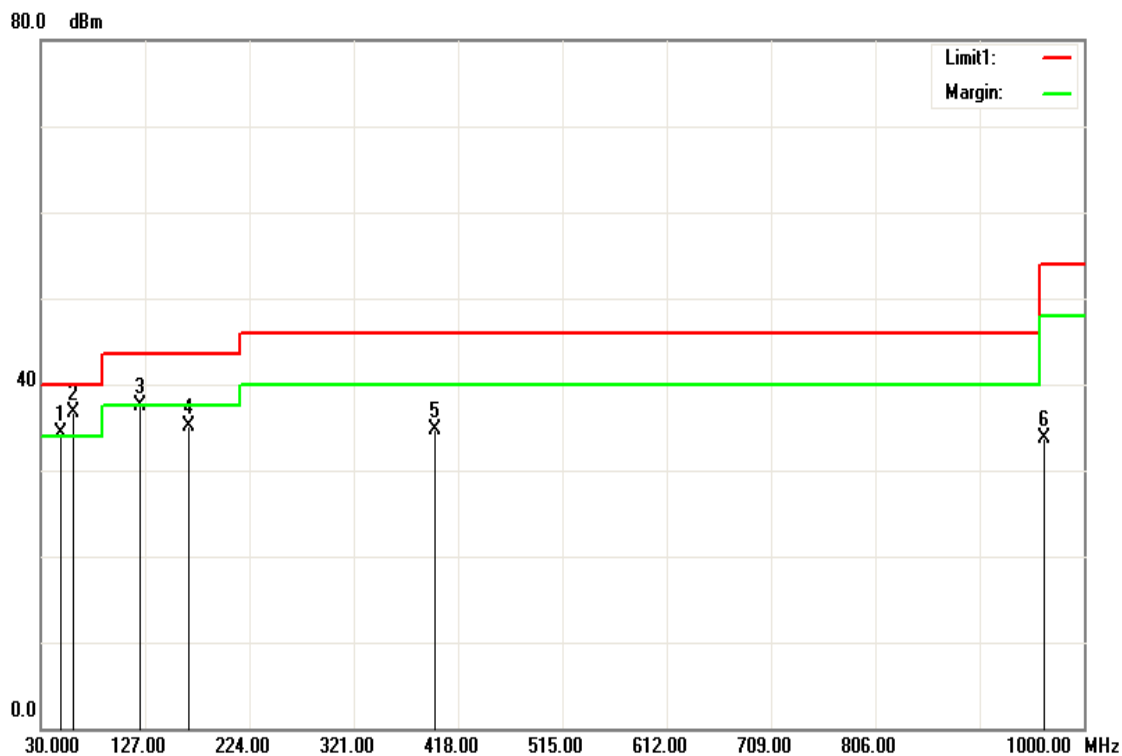

Frequency (MHz)	Reading (dBuV)	Correct Factor(dB/m)	Result (dBuV/m)	Limit (dBuV/m)	Margin (dB)	Remark
48.4300	37.19	-2.98	34.21	40.00	-5.79	QP
60.0700	38.05	-1.29	36.76	40.00	-3.24	QP
122.1500	36.57	0.93	37.50	43.50	-6.00	QP
167.7400	33.87	1.22	35.09	43.50	-8.41	peak
396.6600	27.47	7.29	34.76	46.00	-11.24	peak
963.1400	31.07	2.70	33.77	54.00	-20.23	peak

Test Mode	Mode 1	Temp/Hum	27(°C)/ 53%RH
Test Item	30MHz-1GHz	Test Date	March 27, 2017
Polarize	Horizontal	Test Engineer	Ed Chiang
Detector	Peak and Qusi-peak		

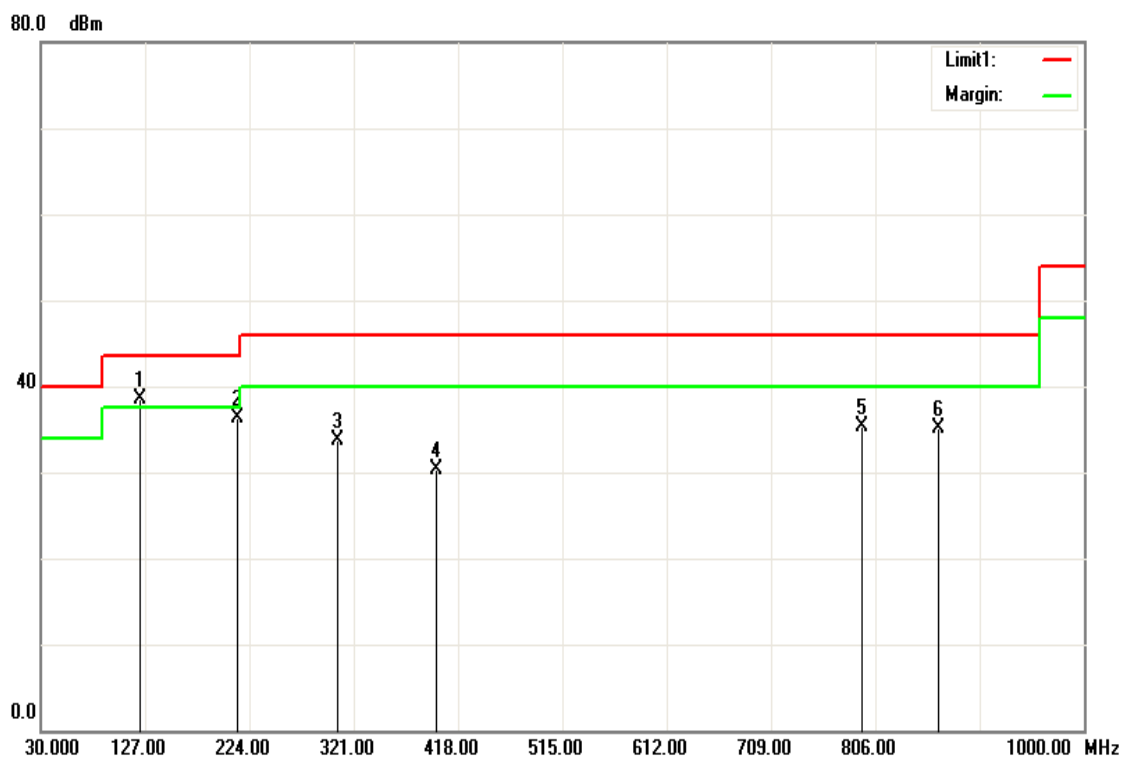

Frequency (MHz)	Reading (dBuV)	Correct Factor(dB/m)	Result (dBuV/m)	Limit (dBuV/m)	Margin (dB)	Remark
122.1500	37.67	0.93	38.60	43.50	-4.90	QP
213.3300	31.32	4.98	36.30	43.50	-7.20	peak
305.4800	26.75	6.92	33.67	46.00	-12.33	peak
397.6300	22.92	7.29	30.21	46.00	-15.79	peak
793.3900	33.90	1.34	35.24	46.00	-10.76	peak
865.1700	33.76	1.25	35.01	46.00	-10.99	peak

Above 1 GHz

Test Mode	Zigbee Low CH	Temp/Hum	27(°C)/ 53%RH
Test Item	Harmonic	Test Date	March 26, 2017
Polarize	Horizontal	Test Engineer	Ed Chiang
Detector	Peak and Average		

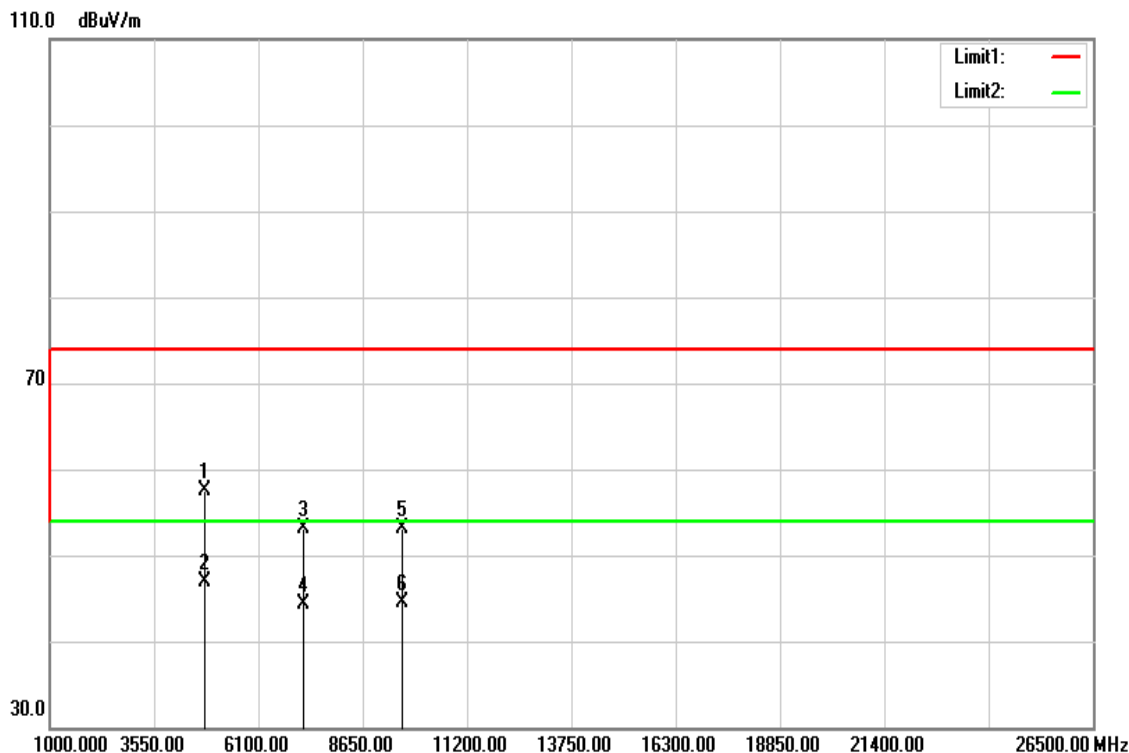

Frequency (MHz)	Reading (dBuV)	Correct Factor(dB/m)	Result (dBuV/m)	Limit (dBuV/m)	Margin (dB)	Remark
4806.000	52.40	5.05	57.45	74.00	-16.55	peak
4806.000	41.93	5.05	46.98	54.00	-7.02	AVG
7214.000	40.51	12.65	53.16	74.00	-20.84	peak
7214.000	31.71	12.65	44.36	54.00	-9.64	AVG
9622.000	35.42	17.60	53.02	74.00	-20.98	peak
9622.000	26.91	17.60	44.51	54.00	-9.49	AVG

Remark:

1. Measuring frequencies from 1 GHz to the 10th harmonic of highest fundamental frequency.
2. For above 1GHz, the EUT peak value was under average limit, therefore the Average value compliance with the average limit

Test Mode	Zigbee Low CH	Temp/Hum	27(°C)/ 53%RH
Test Item	Harmonic	Test Date	March 26, 2017
Polarize	Vertical	Test Engineer	Ed Chiang
Detector	Peak and Average		

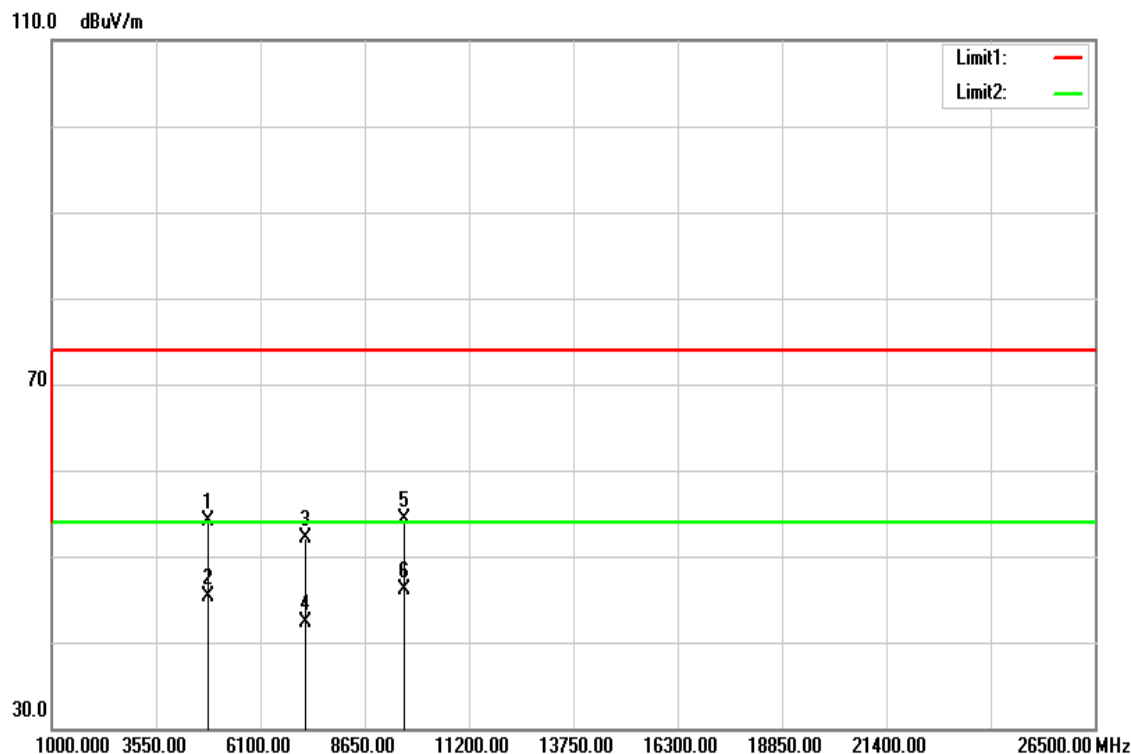

Frequency (MHz)	Reading (dBuV)	Correct Factor(dB/m)	Result (dBuV/m)	Limit (dBuV/m)	Margin (dB)	Remark
4813.000	49.06	5.07	54.13	74.00	-19.87	peak
4813.000	40.29	5.07	45.36	54.00	-8.64	AVG
7214.000	39.54	12.65	52.19	74.00	-21.81	peak
7214.000	29.71	12.65	42.36	54.00	-11.64	AVG
9622.000	36.61	17.60	54.21	74.00	-19.79	peak
9622.000	28.51	17.60	46.11	54.00	-7.89	AVG

Remark:

1. Measuring frequencies from 1 GHz to the 10th harmonic of highest fundamental frequency.
2. For above 1GHz, the EUT peak value was under average limit, therefore the Average value compliance with the average limit

Test Mode	Zigbee Mid CH	Temp/Hum	27(°C)/ 53%RH
Test Item	Harmonic	Test Date	March 26, 2017
Polarize	Horizontal	Test Engineer	Ed Chiang
Detector	Peak and Average		

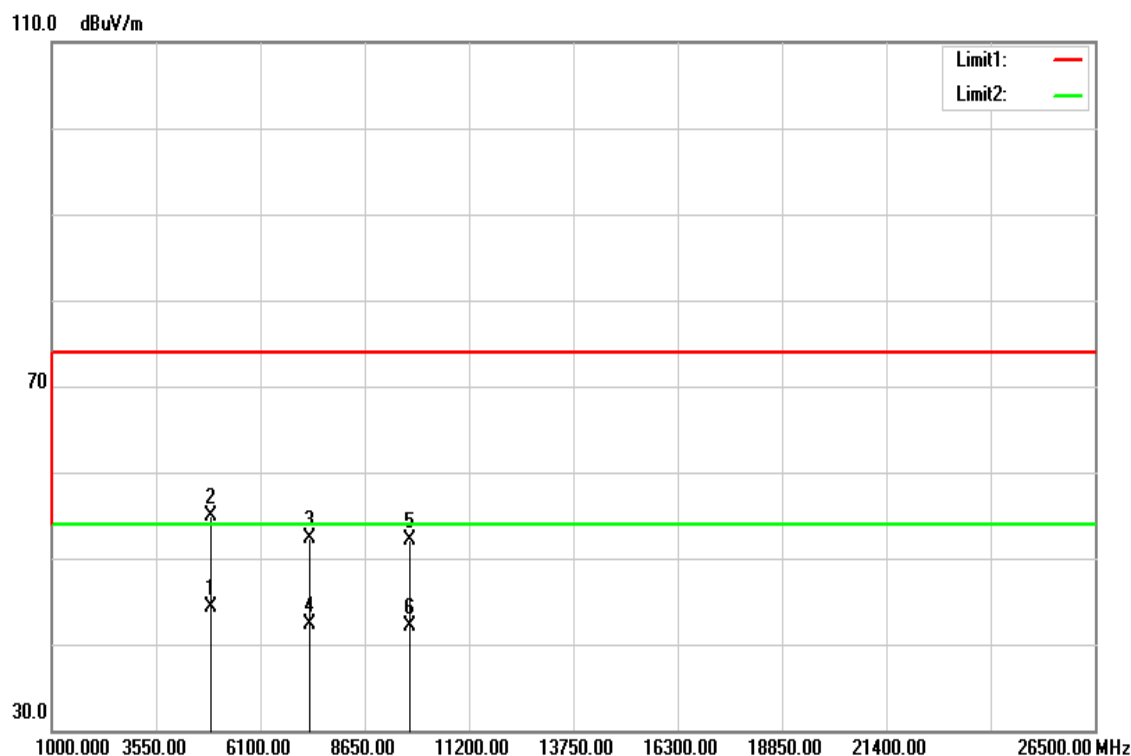

Frequency (MHz)	Reading (dBuV)	Correct Factor(dB/m)	Result (dBuV/m)	Limit (dBuV/m)	Margin (dB)	Remark
4876.000	39.12	5.24	44.36	54.00	-9.64	AVG
4883.000	49.62	5.26	54.88	74.00	-19.12	peak
7319.000	39.35	12.96	52.31	74.00	-21.69	peak
7319.000	29.40	12.96	42.36	54.00	-11.64	AVG
9760.000	34.53	17.60	52.13	74.00	-21.87	peak
9760.000	24.57	17.60	42.17	54.00	-11.83	AVG

Remark:

1. Measuring frequencies from 1 GHz to the 10th harmonic of highest fundamental frequency.
2. For above 1GHz, the EUT peak value was under average limit, therefore the Average value compliance with the average limit

Test Mode	Zigbee Mid CH	Temp/Hum	27(°C)/ 53%RH
Test Item	Harmonic	Test Date	March 26, 2017
Polarize	Vertical	Test Engineer	Ed Chiang
Detector	Peak and Average		

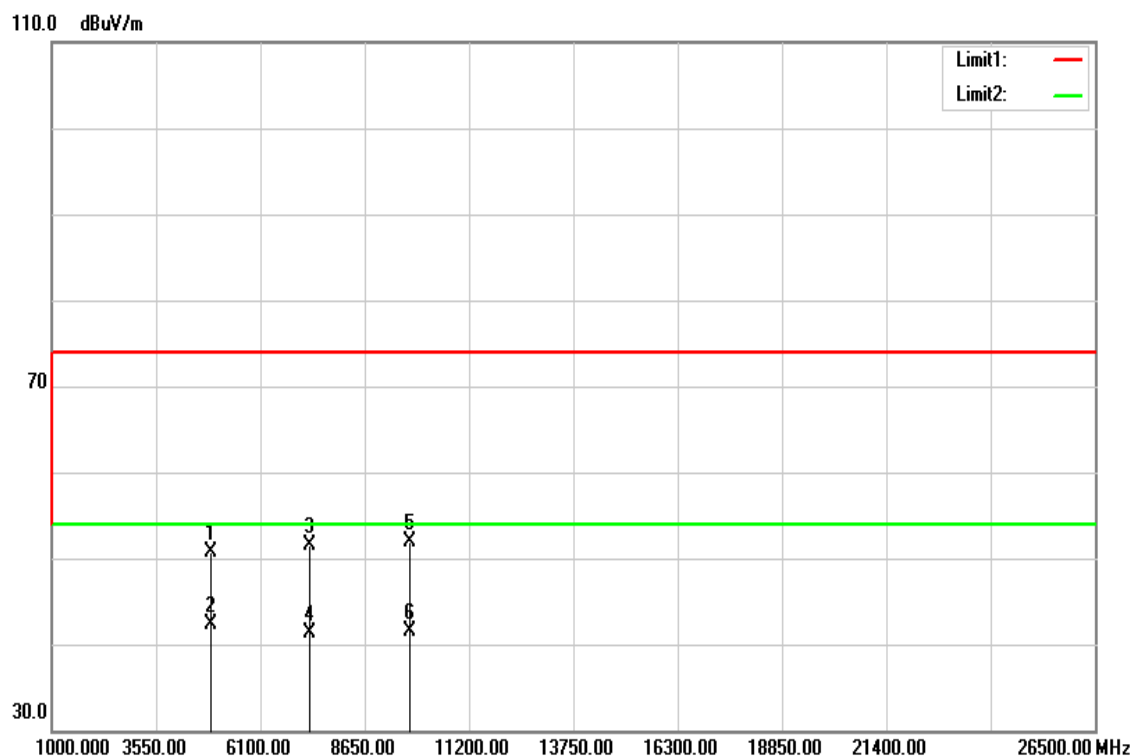

Frequency (MHz)	Reading (dBuV)	Correct Factor(dB/m)	Result (dBuV/m)	Limit (dBuV/m)	Margin (dB)	Remark
4883.000	45.45	5.26	50.71	74.00	-23.29	peak
4883.000	37.05	5.26	42.31	54.00	-11.69	AVG
7319.000	38.49	12.96	51.45	74.00	-22.55	peak
7319.000	28.37	12.96	41.33	54.00	-12.67	AVG
9760.000	34.27	17.60	51.87	74.00	-22.13	peak
9760.000	23.98	17.60	41.58	54.00	-12.42	AVG

Remark:

1. Measuring frequencies from 1 GHz to the 10th harmonic of highest fundamental frequency.
2. For above 1GHz, the EUT peak value was under average limit, therefore the Average value compliance with the average limit

Test Mode	Zigbee High CH	Temp/Hum	27(°C)/ 53%RH
Test Item	Harmonic	Test Date	March 26, 2017
Polarize	Horizontal	Test Engineer	Ed Chiang
Detector	Peak and Average		

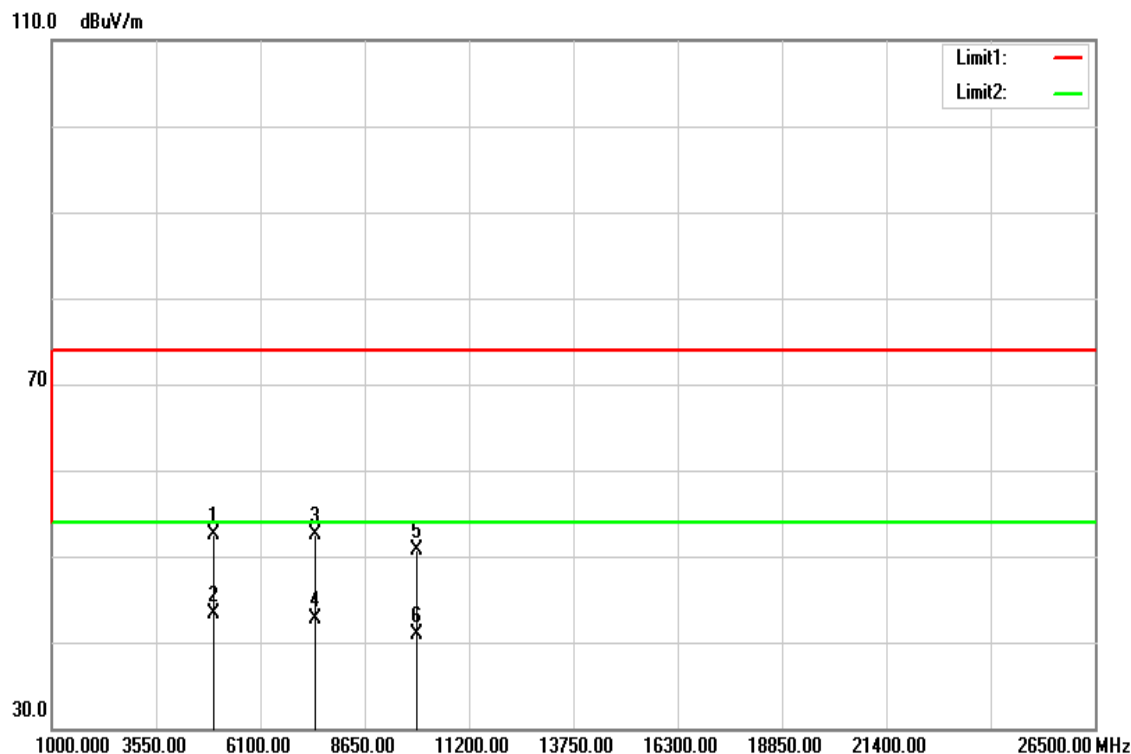

Frequency (MHz)	Reading (dBuV)	Correct Factor(dB/m)	Result (dBuV/m)	Limit (dBuV/m)	Margin (dB)	Remark
4960.000	46.95	5.46	52.41	74.00	-21.59	peak
4960.000	37.86	5.46	43.32	54.00	-10.68	AVG
7438.000	39.14	13.32	52.46	74.00	-21.54	peak
7438.000	29.33	13.32	42.65	54.00	-11.35	AVG
9920.000	33.18	17.60	50.78	74.00	-23.22	peak
9920.000	23.36	17.60	40.96	54.00	-13.04	AVG

Remark:

1. Measuring frequencies from 1 GHz to the 10th harmonic of highest fundamental frequency.
2. For above 1GHz, the EUT peak value was under average limit, therefore the Average value compliance with the average limit

Test Mode	Zigbee High CH	Temp/Hum	27(°C)/ 53%RH
Test Item	Harmonic	Test Date	March 26, 2017
Polarize	Vertical	Test Engineer	Ed Chiang
Detector	Peak and Average		

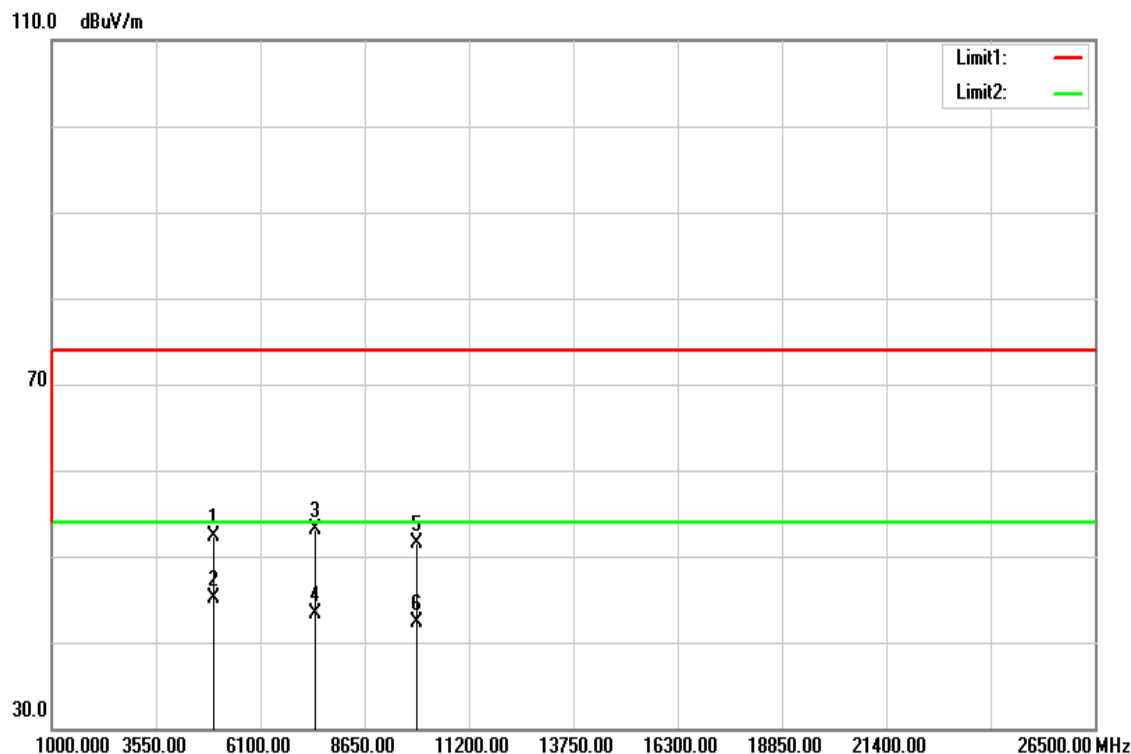

Frequency (MHz)	Reading (dBuV)	Correct Factor(dB/m)	Result (dBuV/m)	Limit (dBuV/m)	Margin (dB)	Remark
4960.000	46.90	5.46	52.36	74.00	-21.64	peak
4960.000	39.66	5.46	45.12	54.00	-8.88	AVG
7438.000	39.80	13.32	53.12	74.00	-20.88	peak
7438.000	30.04	13.32	43.36	54.00	-10.64	AVG
9920.000	33.97	17.60	51.57	74.00	-22.43	peak
9920.000	24.76	17.60	42.36	54.00	-11.64	AVG

Remark:

1. Measuring frequencies from 1 GHz to the 10th harmonic of highest fundamental frequency.
2. For above 1GHz, the EUT peak value was under average limit, therefore the Average value compliance with the average limit