



**FCC 47 CFR PART 15 SUBPART C AND ANSI C63.4:2009
TEST REPORT**

For

DreamTab HD8

Model : DMTAB-IN08A

Trade Name : nabi

Issued for

Foxconn International Inc.

No.2,Ziyou St.,Tucheng Dist., New Taipei City 236,Taiwan

Issued by

**Compliance Certification Services Inc.
Hsinchu Lab.**

**NO. 989-1 Wen Shan Rd., Shang Shan Village,
Qionglin Shiang Hsinchu County 30741, Taiwan, R.O.C**

TEL: +886-3-5921698

FAX: +886-3-5921108

<http://www.ccsrf.com>

E-Mail : service@ccsrf.com

Issued Date: March 31, 2014



Note: *This report shall not be reproduced except in full, without the written approval of Compliance Certification Services Inc. This document may be altered or revised by Compliance Certification Services Inc. personnel only, and shall be noted in the revision section of the document. The client should not use it to claim product endorsement by TAF or any government agencies. The test results of this report relate only to the tested sample identified in this report.*



Revision History

Rev.	Issue Date	Revisions	Effect Page	Revised By
00	03/31/2014	Initial Issue	All Page 141	Gloria Chang



TABLE OF CONTENTS

TITLE	PAGE NO.
1. TEST REPORT CERTIFICATION	4
2. EUT DESCRIPTION	5-6
3. DESCRIPTION OF TEST MODES	7-9
4. TEST METHODOLOGY	10
5. FACILITIES AND ACCREDITATION	10
5.1 FACILITIES	10
5.2 ACCREDITATIONS.....	10
5.3 MEASUREMENT UNCERTAINTY	11
6. SETUP OF EQUIPMENT UNDER TEST.....	12-13
7. FCC PART 15.247 REQUIREMENTS	14
7.1 6dB BANDWIDTH	14-32
7.2 MAXIMUM PEAK OUTPUT POWER	33-36
7.3 AVERAGE POWER	37-40
7.4 POWER SPECTRAL DENSITY	41-59
7.5 CONDUCTED SPURIOUS EMISSION	60-83
7.6 RADIATED EMISSION.....	84-132
7.7 CONDUCTED EMISSION.....	133-137
APPENDIX SETUP PHOTOS	138-141



1. TEST REPORT CERTIFICATION

Applicant : Foxconn International Inc.
Address : No.2,Ziyou St.,Tucheng Dist., New Taipei City 236,Taiwan
Equipment Under Test : DreamTab HD8
Model : DMTAB-IN08A
Trade Name : nabi
Tested Date : March 12 ~ 28, 2014

APPLICABLE STANDARD	
Standard	Test Result
FCC Part 15 Subpart C AND ANSI C63.4:2009	PASS

WE HEREBY CERTIFY THAT: The above equipment has been tested by Compliance Certification Services Inc., and found compliance with the requirements set forth in the technical standards mentioned above. The results of testing in this report apply only to the product/system, which was tested. Other similar equipment will not necessarily produce the same results due to production tolerance and measurement uncertainties.

Approved by:

Rex Liao
Deputy Manager

Reviewed by:

Jacky Chen
Section Manager



2. EUT DESCRIPTION

Product Name	DreamTab HD8
Model Number	DMTAB-IN08A
Identify Number	T140312D11
Received Date	March 12, 2014
Frequency Range	IEEE 802.11a, 802.11an HT20 : 5745MHz ~ 5825Hz IEEE 802.11an HT40 : 5755MHz~5795MHz IEEE 802.11b/g, 802.11n HT20 : 2412MHz ~ 2462MHz IEEE 802.11n HT40 : 2422MHz ~ 2452MHz Bluetooth 4.0 : 2402MHz ~ 2480MHz
Transmit Power	5GHz : IEEE 802.11a : 18.13 dBm (0.0650W) IEEE 802.11an HT20 : 18.41 dBm (0.0693W) IEEE 802.11an HT40 : 18.06 dBm (0.0640W) 2.4GHz : IEEE 802.11b : 18.36 dBm (0.0685W) IEEE 802.11g : 21.18 dBm (0.1312W) IEEE 802.11n HT20 : 20.74 dBm (0.1186W) IEEE 802.11n HT40 : 20.37 dBm (0.1089 W) Bluetooth 4.0: 7.70 dBm (0.0059W)
Channel Spacing	IEEE 802.11a, 802.11an/n HT20 : 20MHz IEEE 802.11an HT40 : 40MHz IEEE 802.11b/g, 802.11n HT20/HT40 : 5MHz Bluetooth 4.0: 2MHz
Channel Number	IEEE 802.11a, IEEE 802.11an HT20: 5 Channels IEEE 802.11an HT40 : 2 Channels IEEE 802.11b/g, IEEE 802.11n HT20: 11 Channels IEEE 802.11n HT40 : 7 Channels Bluetooth 4.0: 40 Channels
Transmit Data Rate	IEEE 802.11b : 11, 5.5, 2, 1 Mbps IEEE 802.11a/g : 54, 48, 36, 24, 18, 12, 9, 6 Mbps IEEE 802.11n/an HT20 : 72.2, 65, 58.5, 57.8, 52, 43.3, 39, 28.9, 26, 21.7, 19.5, 14.4, 13, 7.2, 6.5Mbps IEEE 802.11n/an HT40 : 150, 135, 121.5, 120, 108, 90, 81, 60, 54, 45, 40.5, 30, 27, 15, 13.5Mbps Bluetooth 4.0 : Additional GFSK



Type of Modulation	IEEE 802.11b : DSSS (CCK, DQPSK, DBPSK) IEEE 802.11a/g : OFDM (64QAM, 16QAM, QPSK, BPSK) IEEE 802.11an/n HT20/40 : OFDM (64QAM, 16QAM, QPSK, BPSK) Bluetooth 4.0 : Frequency Hopping Spread Spectrum
Antenna Type	PIFA Antenna, Antenna Gain 3.3dBi
Power Rating	3.7Vdc, 4500mAh, 16.65Wh (For Battery) 5Vdc (For Charging)
Test Voltage	120Vac, 60Hz
I/O Port	USB Port × 1, Micro SD Port × 1, Audio Port × 1
Signal Cable	Shielded USB Cable 1m × 1

Power Adapter :

No.	Manufacturer	Model No.	Power Input	Power Output
1	Chicony	W12-010N3A	100-240Vac, 50/60Hz, 0.3A	5Vdc, 2A

Remark :

1. The sample selected for test was engineering sample that approximated to production product and was provided by manufacturer.
2. For more details, please refer to the User's manual of the EUT.
3. This submittal(s) (test report) is intended for FCC ID:SIB-DMTAB-IN08A filing to comply with Section 15.207, 15.209 and 15.247 of the FCC Part 15, Subpart C Rules.



3. DESCRIPTION OF TEST MODES

The EUT (DreamTab HD8) had been tested under operating condition.

Conducted Emission / Radiated Emission Test (Below 1 GHz)

1. The following test modes were scanned during the preliminary test:

No.	Pre-Test Mode
1	Charge Mode + Play Video
2	Charge Mode + REC (with Front Camera)
3	Charge Mode + REC (with Back Camera)
4	Normal Operating + Link Notebook PC Read
5	Normal Operating + Link Notebook PC Write

2. After the preliminary scan, the following test mode was found to produce the highest emission level.

Final Test Mode		
Emission	Radiated Emission	Normal Operating + Link Notebook PC Write
	Conducted Emission	Charge Mode + Play Video

Remark : Then, the above highest emission mode of the configuration of the EUT and cable was chosen for all final test items.



Conducted / Radiated Emission Test (Above 1 GHz)

IEEE ,802.11a ,802.11an HT20 mode

The EUT had been tested under operating condition.

There are three channels have been tested as following :

Channel	Frequency (MHz)
Low	5745
Middle	5785
High	5825

IEEE 802.11a mode : 6Mbps data rate (worst case) were chosen for full testing.

IEEE 802.11an HT20 mode : 6.5Mbps data rate (worst case) were chosen for full testing.

IEEE 802.11an HT40 mode

The EUT had been tested under operating condition.

There are three channels have been tested as following :

Channel	Frequency (MHz)
Low	5755
High	5795

IEEE 802.11n HT40 mode : 13.5Mbps data rate (worst case) were chosen for full testing.

IEEE 802.11b, 802.11g, 802.11n HT20 mode

The EUT had been tested under operating condition.

There are three channels have been tested as following :

Channel	Frequency (MHz)
Low	2412
Middle	2437
High	2462

IEEE 802.11b mode : 1Mbps data rate (worst case) were chosen for full testing.

IEEE 802.11g mode : 6Mbps data rate (worst case) were chosen for full testing.

IEEE 802.11n HT20 mode : 6.5Mbps data rate (worst case) were chosen for full testing.

IEEE 802.11n HT40 mode

The EUT had been tested under operating condition.

There are three channels have been tested as following :

Channel	Frequency (MHz)
Low	2422
Middle	2437
High	2452

IEEE 802.11n HT40 mode : 13.5Mbps data rate (worst case) were chosen for full testing.



Bluetooth 4.0 mode

The EUT had been tested under operating condition.

There are three channels have been tested as following :

Channel	Frequency (MHz)
Low	2402
Middle	2440
High	2480



4. TEST METHODOLOGY

The tests documented in this report were performed in accordance with ANSI C63.4: 2009 and FCC CFR 47, 15.207, 15.209 and 15.247.

5. FACILITIES AND ACCREDITATION

5.1 FACILITIES

All measurement facilities used to collect the measurement data are located at

NO. 989-1 Wen Shan Rd., Shang Shan Village,
Qionglin Shiang Hsinchu County 30741, Taiwan, R.O.C

The sites are constructed in conformance with the requirements of ANSI C63.4:2009 and CISPR 22. All receiving equipment conforms to CISPR 16-1-1, CISPR 16-1-2, CISPR 16-1-3, CISPR 16-1-4, CISPR 16-1-5.

5.2 ACCREDITATIONS

Our laboratories are accredited and approved by the following approval agencies according to ISO/IEC 17025.

Taiwan	TAF
---------------	-----

The measuring facility of laboratories has been authorized or registered by the following approval agencies.

Canada	INDUSTRY CANADA
Japan	VCCI
Taiwan	BSMI
USA	FCC MRA

Copies of granted accreditation certificates are available for downloading from our web site, <http://www.ccsrf.com>



5.3 MEASUREMENT UNCERTAINTY

The following table is for the measurement uncertainty, which is calculated as per the document CISPR 16-4-2.

PARAMETER	UNCERTAINTY
Semi Anechoic Chamber (966 Chamber_A) / Radiated Emission, 30 to 1000 MHz	+/- 3.59
Semi Anechoic Chamber (966 Chamber_A) / Radiated Emission, 1 to 18GHz	+/- 3.59
Semi Anechoic Chamber (966 Chamber_A) / Radiated Emission, 18 to 26 GHz	+/- 3.59
Semi Anechoic Chamber (966 Chamber_A) / Radiated Emission, 26 to 40 GHz	+/- 3.82
Semi Anechoic Chamber (966 Chamber_B) / Radiated Emission, 30 to 1000 MHz	+/- 3.97
Semi Anechoic Chamber (966 Chamber_B) / Radiated Emission, 1 to 18GHz	+/- 3.58
Semi Anechoic Chamber (966 Chamber_B) / Radiated Emission, 18 to 26 GHz	+/- 3.59
Semi Anechoic Chamber (966 Chamber_B) / Radiated Emission, 26 to 40 GHz	+/- 3.81
Conducted Emission (Mains Terminals), 9kHz to 30MHz	+/- 2.48

This uncertainty represents an expanded uncertainty expressed at approximately the 95% confidence level using a coverage factor of k=2.

Consistent with industry standard (e.g. CISPR 22, clause 11, Measurement Uncertainty) determining compliance with the limits shall be base on the results of the compliance measurement. Consequently the measure emissions being less than the maximum allowed emission result in this be a compliant test or passing test.

The acceptable measurement uncertainty value without requiring revision of the compliance statement is base on conducted and radiated emissions being less than U_{CISPR} which is 3.6dB and 5.2dB respectively. CCS values (called U_{Lab} in CISPR 16-4-2) is less than U_{CISPR} as shown in the table above. Therefore, MU need not be considered for compliance.



6. SETUP OF EQUIPMENT UNDER TEST

SUPPORT EQUIPMENT

No.	Product	Manufacturer	Model No.	Serial No.	FCC ID
1	Notebook PC	TOSHIBA	M840	9C104267C	DoC
2	LCD Monitor	DELL	2407WFPb	CN-0FC255-4663 3-6CP-06JS	DoC
3	Keyboard	HP	KU-0316	35563-AB1	DoC
4	Mouse	HP	M-UAE96	265986-011	DoC
5	Headset	Acon	CW-010.V	---	---

SETUP DIAGRAM FOR TESTS

EUT & peripherals setup diagram is shown in appendix setup photos.

EUT OPERATING CONDITION

WiFi :

1. EUT & peripherals setup diagram is shown in appendix setup photos.

2. TX Mode:

- ⇒ **Tx Data Rate:** 1Mbps Bandwidth 20 (IEEE 802.11b mode)
6Mbps Bandwidth 20 (IEEE 802.11a/g mode)
6.5Mbps Bandwidth 20 (IEEE 802.11an/n HT20 mode)
13.5Mbps Bandwidth 40 (IEEE 802.11an/n HT40 mode)

⇒ **Power control**

- IEEE 802.11b Channel Low (2412MHz) Target Power 15
- IEEE 802.11b Channel Mid (2437MHz) Target Power 17
- IEEE 802.11b Channel High (2462MHz) Target Power 15.5
- IEEE 802.11g Channel Low (2412MHz) Target Power 14
- IEEE 802.11g Channel Mid (2437MHz) Target Power 14
- IEEE 802.11g Channel High (2462MHz) Target Power 12.5
- IEEE 802.11n HT20 Channel Low (2412MHz) Target Power 13.5
- IEEE 802.11n HT20 Channel Mid (2437MHz) Target Power 14
- IEEE 802.11n HT20 Channel High(2462MHz) Target Power 12
- IEEE 802.11n HT40 Channel Low (2422MHz) Target Power 12
- IEEE 802.11n HT40 Channel Mid (2437MHz) Target Power 13.5
- IEEE 802.11n HT40 Channel High(2452MHz) Target Power 12
- IEEE 802.11a Channel Low (5745MHz) Target Power 17
- IEEE 802.11a Channel Mid (5785MHz) Target Power 16.5
- IEEE 802.11a Channel High (5825MHz) Target Power 16.5



IEEE 802.11an HT20 Cannel Low (5745MHz) Target Power 17
IEEE 802.11an HT20 Channel Mid(5785MHz)Target Power 16.5
IEEE 802.11an HT20 Channel High(5825MHz)Target Power 16.5
IEEE 802.11an HT40 Channel Low(5755MHz)Target Power 16.5
IEEE 802.11an HT40 Channel High(5795MHz)Target Power 16.5

8. All of the functions are under run.
9. Start test.

Bluetooth 4.0 :

1. EUT & peripherals setup diagram is shown in appendix setup photos.
2. Select the following settings.
3. TX mode
 Freq: 2402, 2440, 2480
5. All of the functions are under run.
6. Start test.

Normal Mode :

1. EUT & peripherals setup diagram is shown in appendix setup photos.
2. a. Notebook PC software to write with EUT.
 b. Charge Mode and play video.
3. All of the functions are under run.
4. Start test.



7. FCC PART 15.247 REQUIREMENTS

7.1 6dB BANDWIDTH

LIMITS

§ 15.247(a) (2) For direct sequence systems, the minimum 6dB bandwidth shall be at least 500kHz.

TEST EQUIPMENT

Name of Equipment	Manufacturer	Model	Serial Number	Calibration Due
Spectrum Analyzer	Agilent	E4446A	MY43360132	06/10/2014

Remark: Each piece of equipment is scheduled for calibration once a year.

TEST SETUP



TEST PROCEDURE

1. The transmitter output was connected to a spectrum analyzer.
2. Set RBW = 100 kHz.
3. Set the video bandwidth (VBW) $\geq 3 \times$ RBW.
4. Detector = Peak.
5. Trace mode = max hold.
6. Sweep = auto couple.
7. Allow the trace to stabilize.
8. Measure the maximum width of the emission that is constrained by the frequencies associated with the two outermost amplitude points (upper and lower frequencies) that are attenuated by 6 dB relative to the maximum level measured in the fundamental emission.



TEST RESULTS

IEEE 802.11a Mode

Channel	Channel Frequency (MHz)	6dB Bandwidth (MHz)	Minimum Limit (kHz)	Pass / Fail
Low	5745	15.175	500	PASS
Middle	5785	15.350	500	PASS
High	5825	15.325	500	PASS

IEEE 802.11an HT20 Mode

Channel	Channel Frequency (MHz)	6dB Bandwidth (MHz)	Minimum Limit (kHz)	Pass / Fail
Low	5745	15.120	500	PASS
Middle	5785	15.140	500	PASS
High	5825	15.065	500	PASS

IEEE 802.11an HT40 Mode

Channel	Channel Frequency (MHz)	6dB Bandwidth (MHz)	Minimum Limit (kHz)	Pass / Fail
Low	5755	36.150	500	PASS
High	5795	36.270	500	PASS



IEEE 802.11b Mode

Channel	Channel Frequency (MHz)	6dB Bandwidth (MHz)	Minimum Limit (kHz)	Pass / Fail
Low	2412	8.080	500	PASS
Middle	2437	8.030	500	PASS
High	2462	8.085	500	PASS

IEEE 802.11g Mode

Channel	Channel Frequency (MHz)	6dB Bandwidth (MHz)	Minimum Limit (kHz)	Pass / Fail
Low	2412	15.320	500	PASS
Middle	2437	15.080	500	PASS
High	2462	15.375	500	PASS

IEEE 802.11n HT20 Mode

Channel	Channel Frequency (MHz)	6dB Bandwidth (MHz)	Minimum Limit (kHz)	Pass / Fail
Low	2412	15.025	500	PASS
Middle	2437	15.110	500	PASS
High	2462	15.110	500	PASS

IEEE 802.11n HT40 Mode

Channel	Channel Frequency (MHz)	6dB Bandwidth (MHz)	Minimum Limit (kHz)	Pass / Fail
Low	2422	35.305	500	PASS
Middle	2437	35.070	500	PASS
High	2452	35.265	500	PASS



Bluetooth 4.0 Mode

Channel	Channel Frequency (MHz)	6dB Bandwidth (kHz)	Minimum Limit (kHz)	Pass / Fail
Low	2402	679	500	PASS
Middle	2440	684	500	PASS
High	2480	669	500	PASS



6dB BANDWIDTH

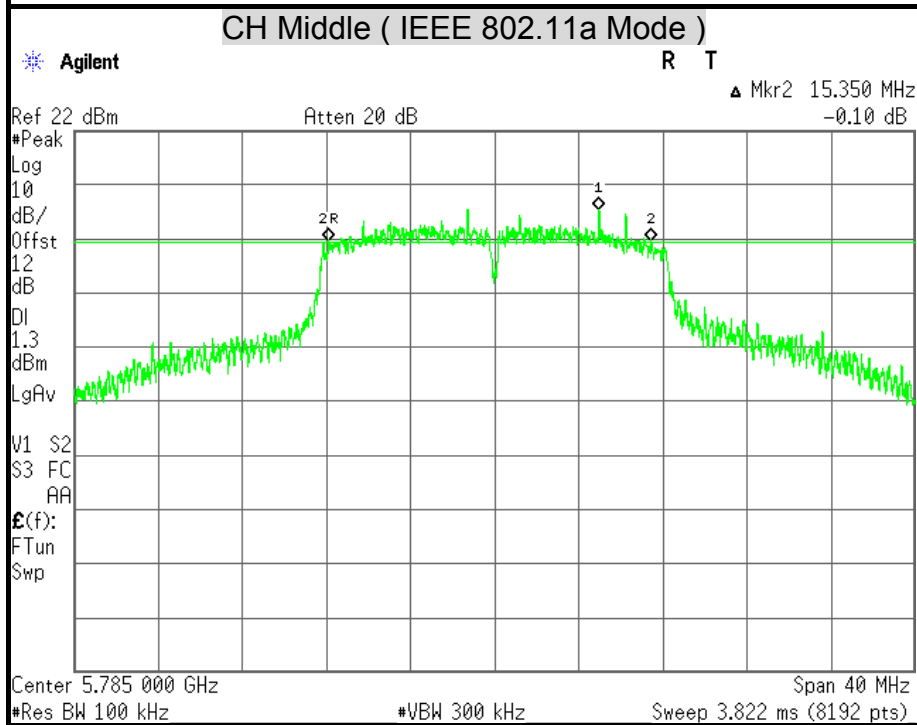
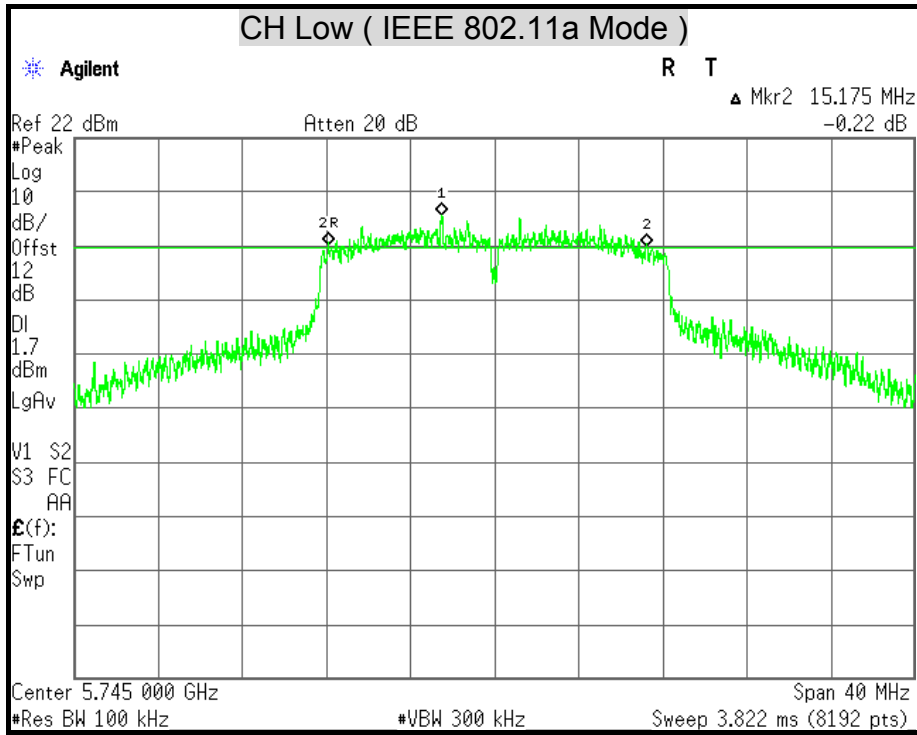

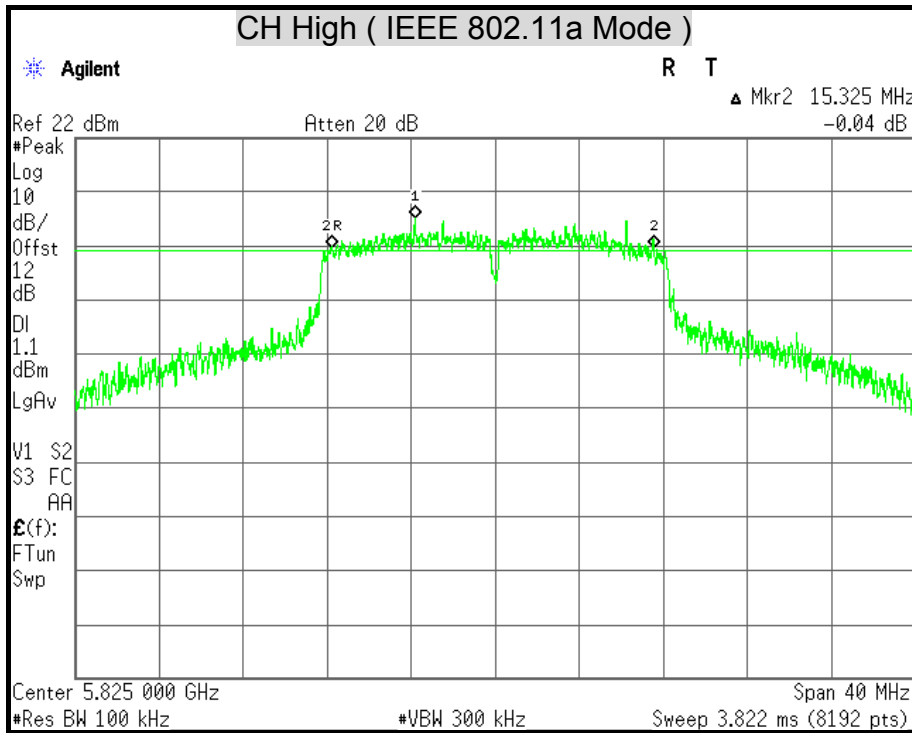

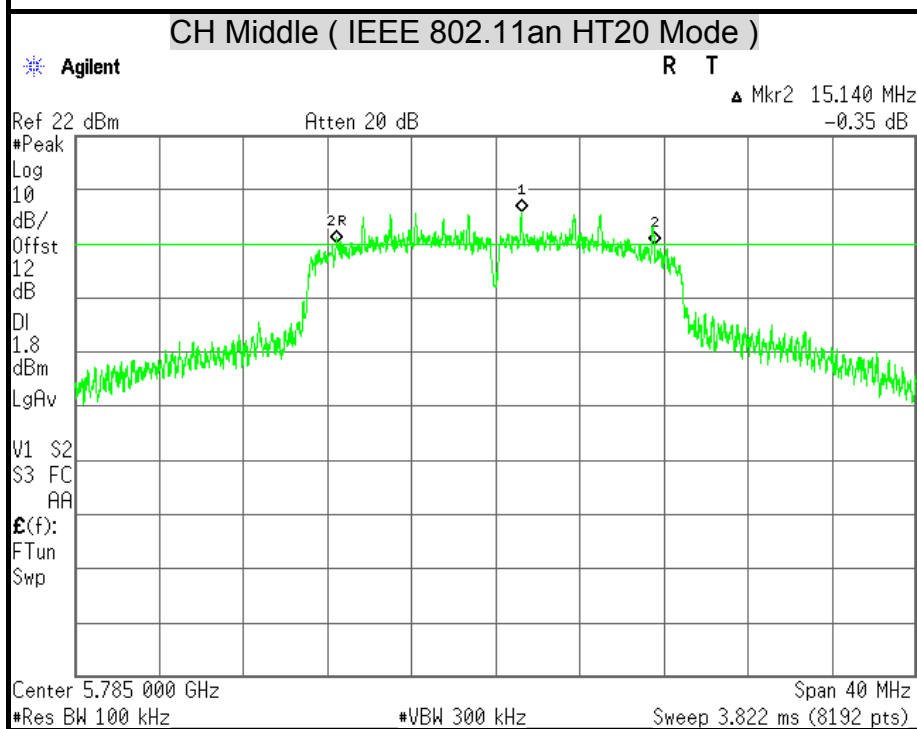
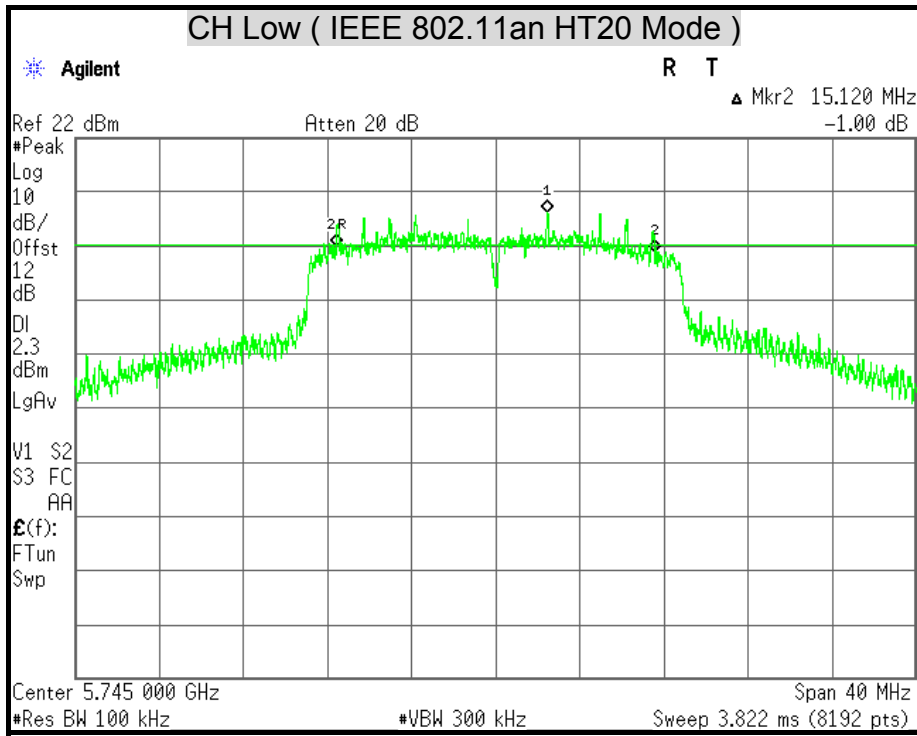

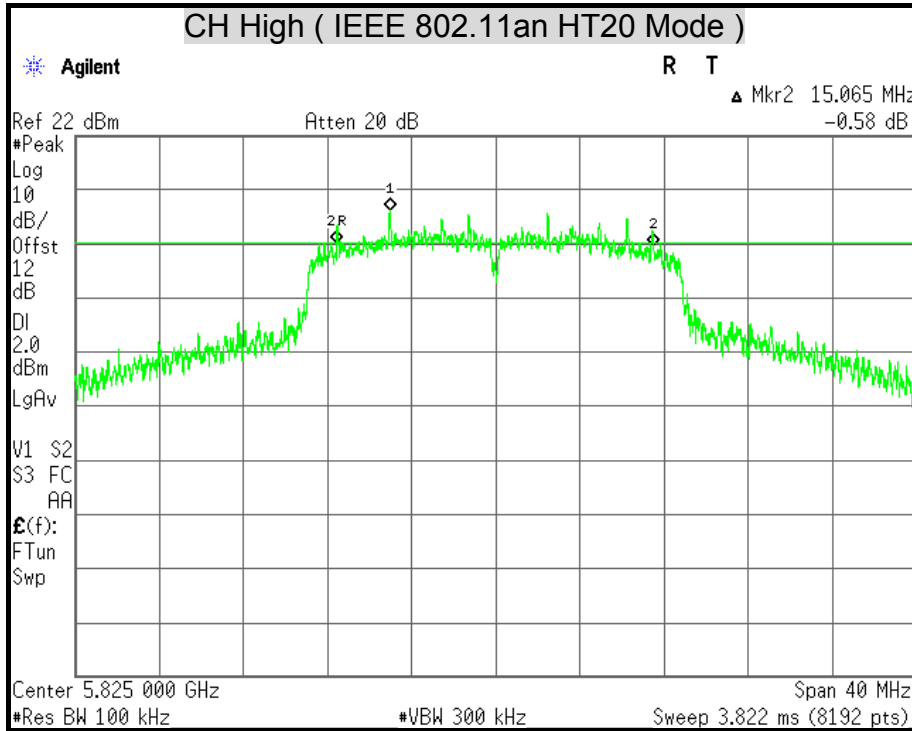

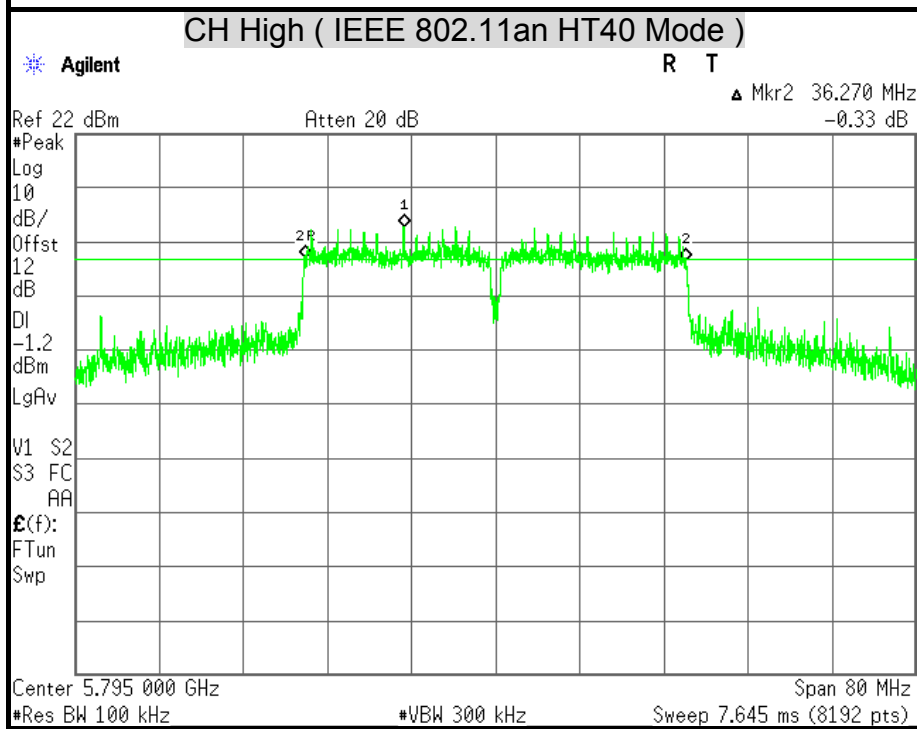
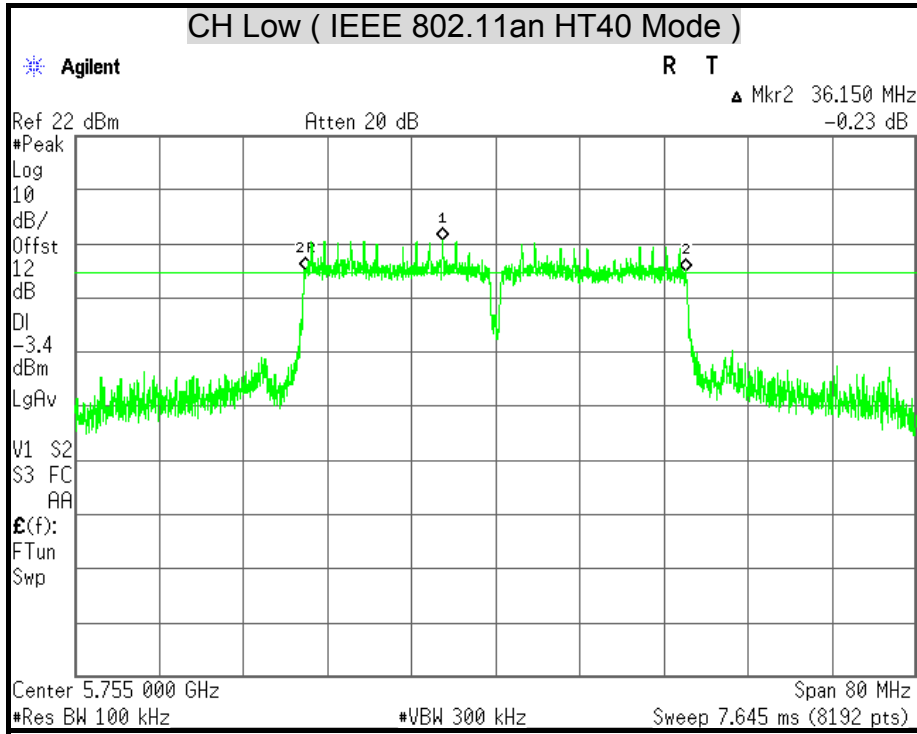

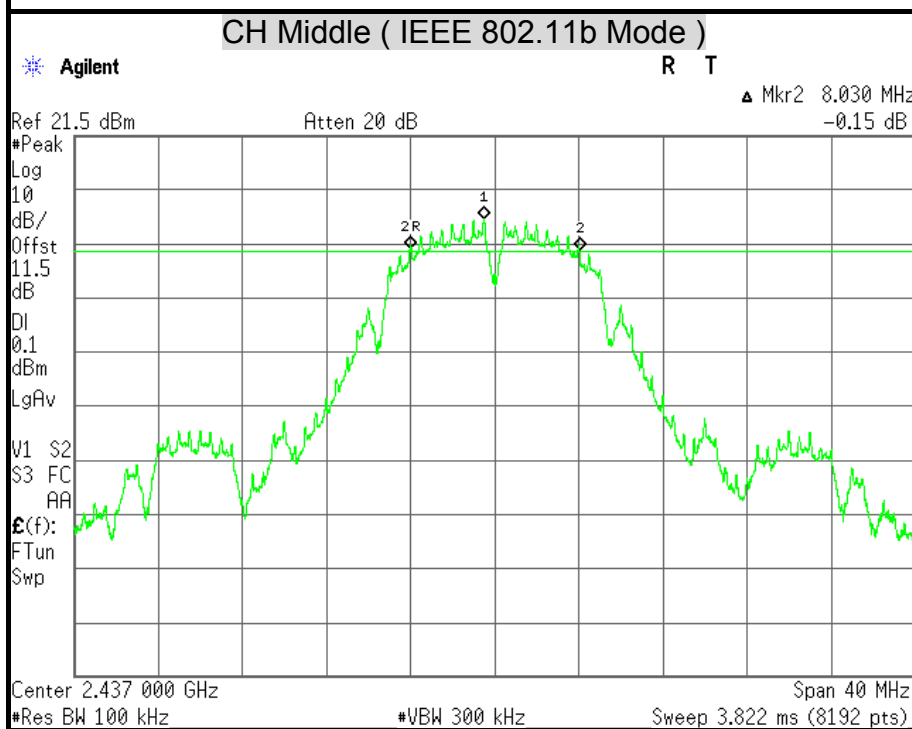
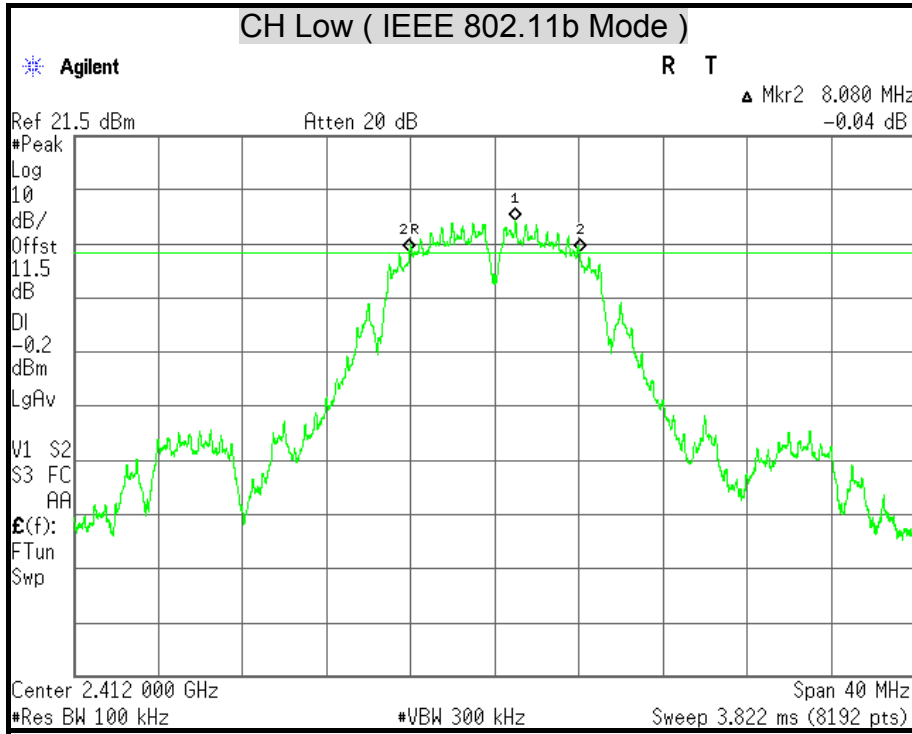

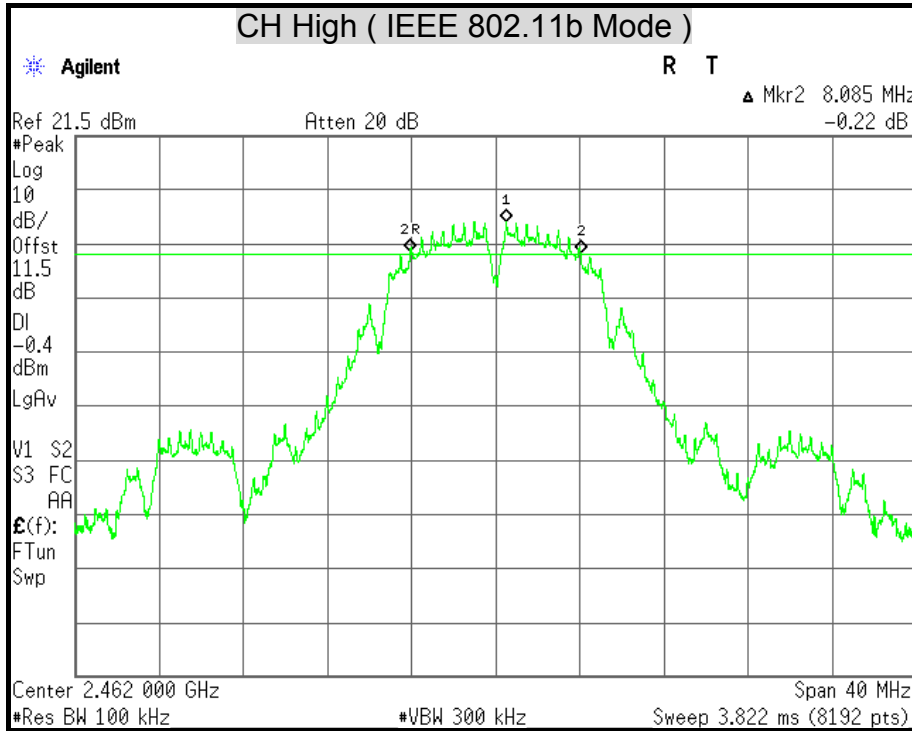

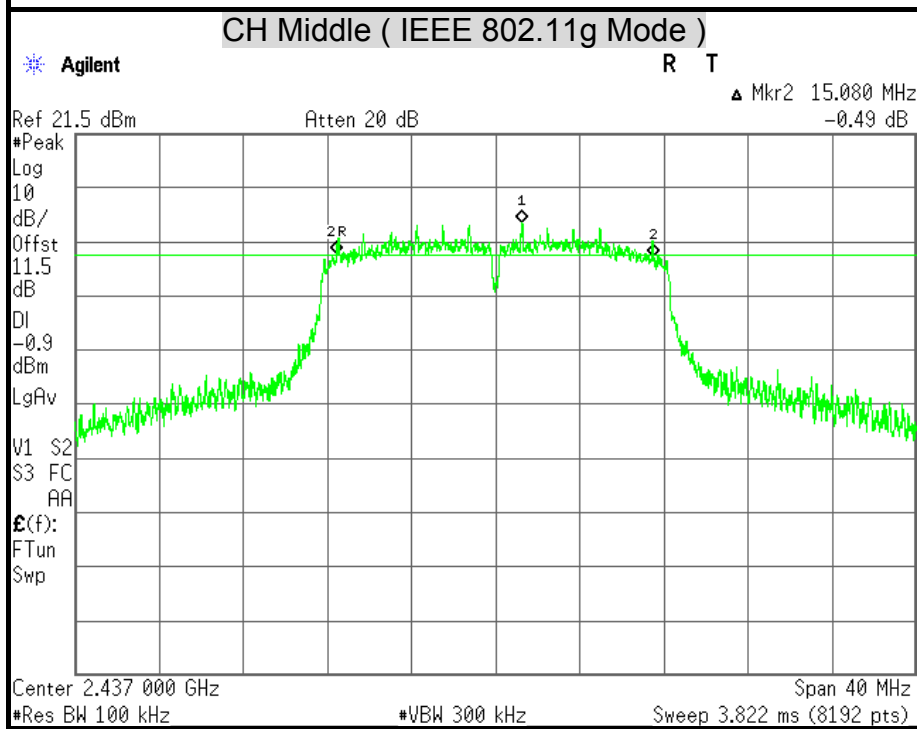
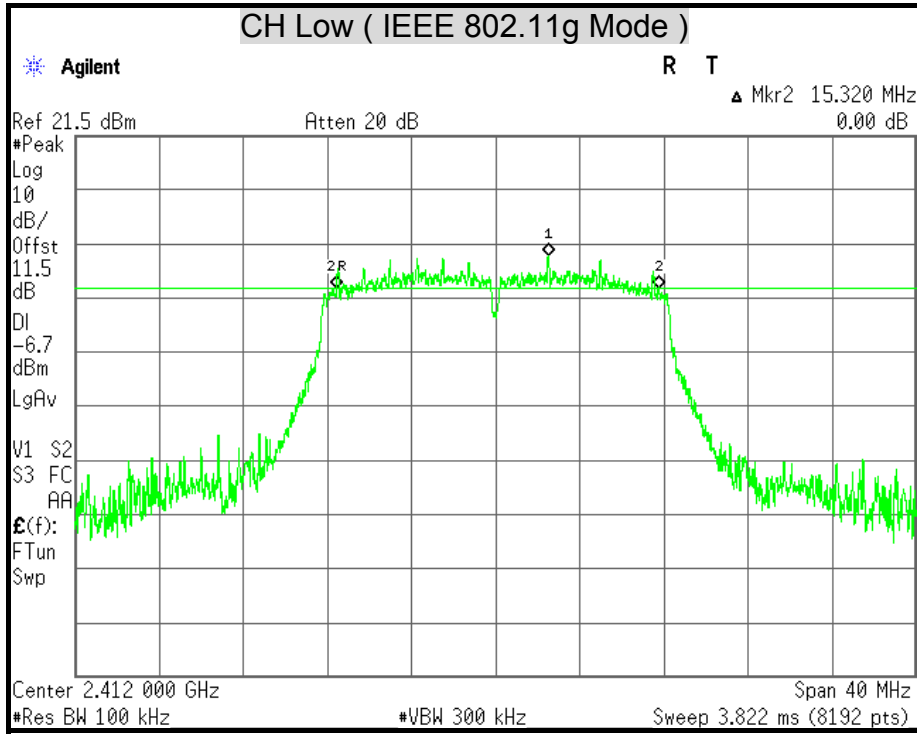

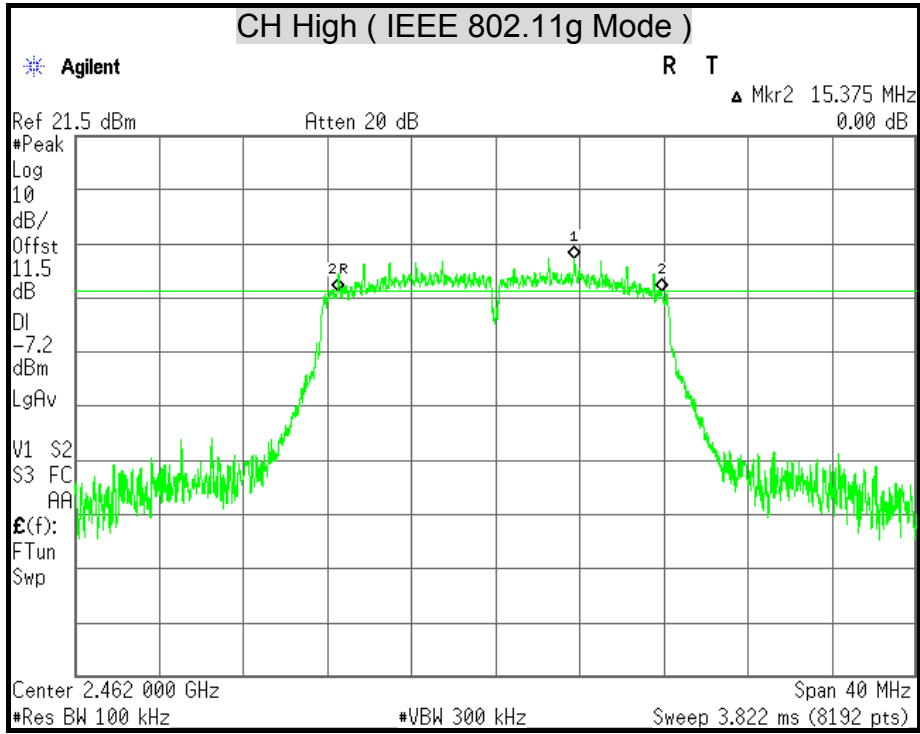

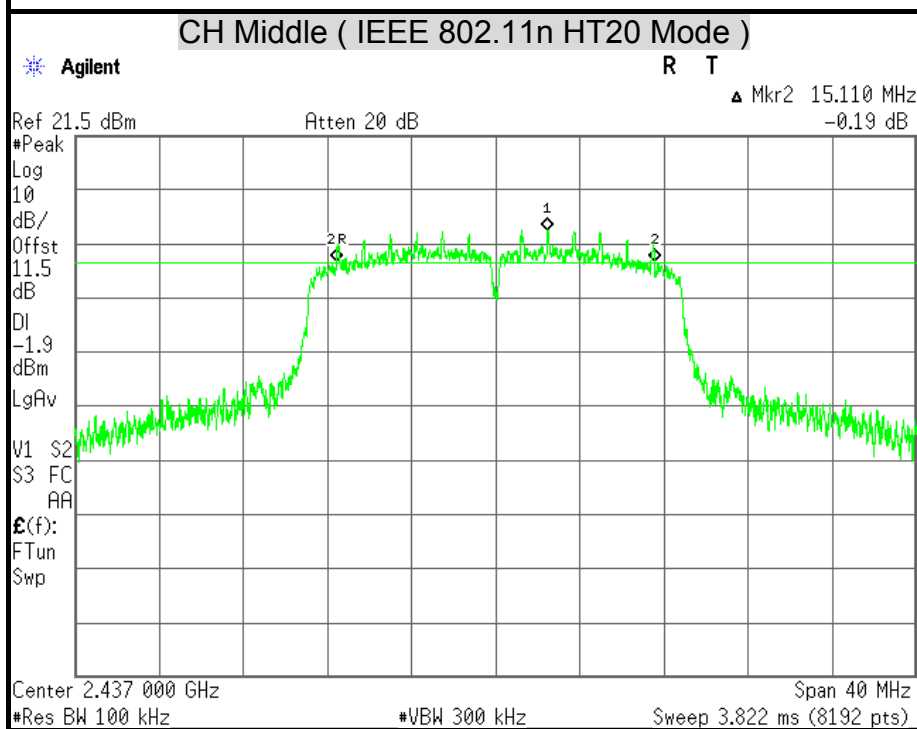
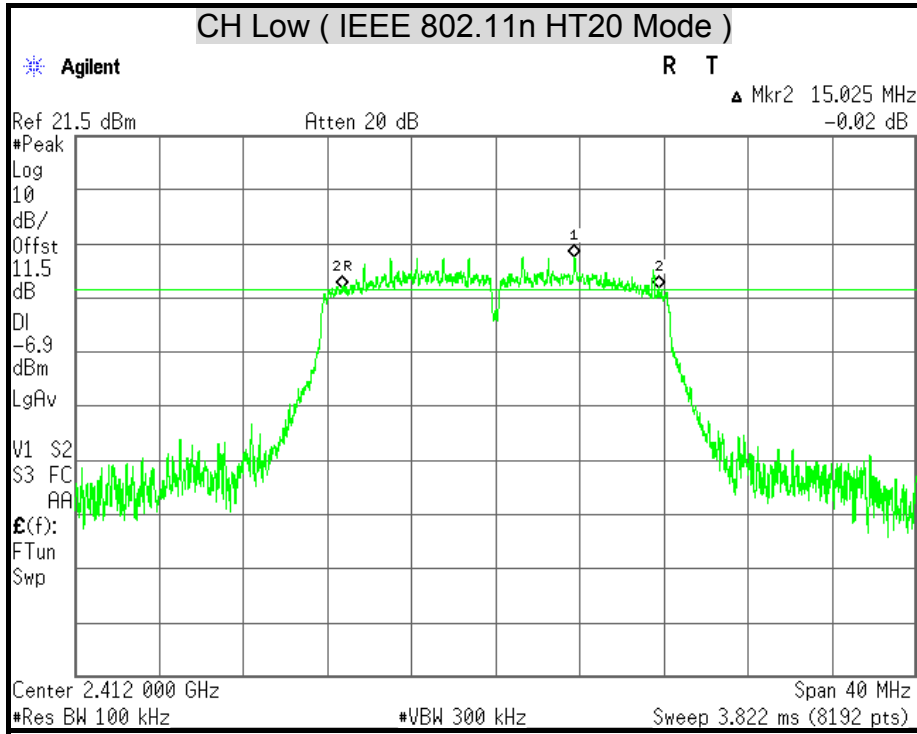

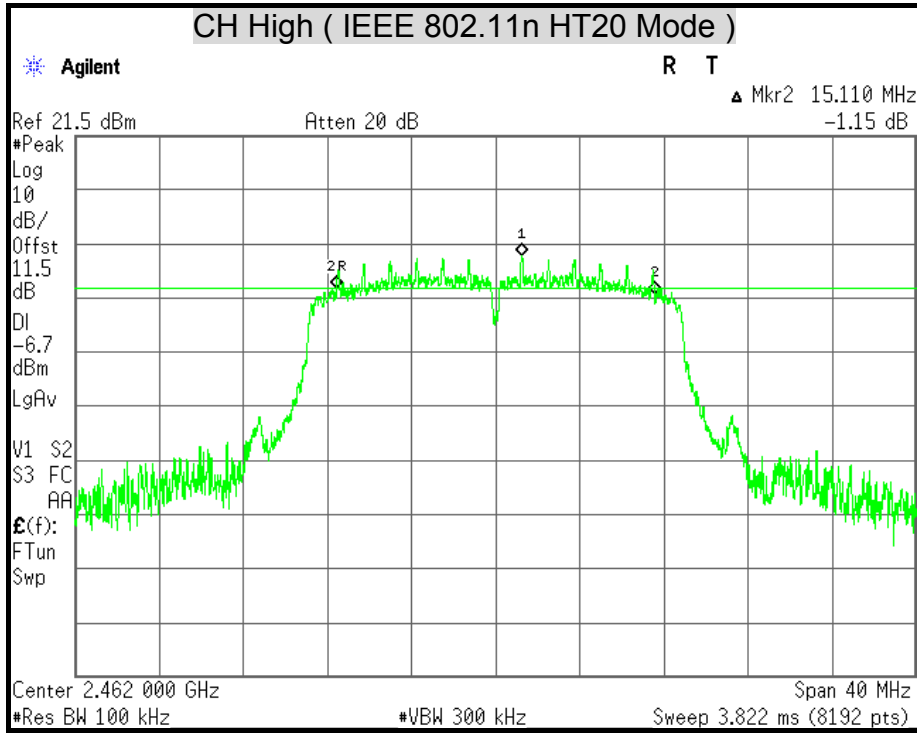

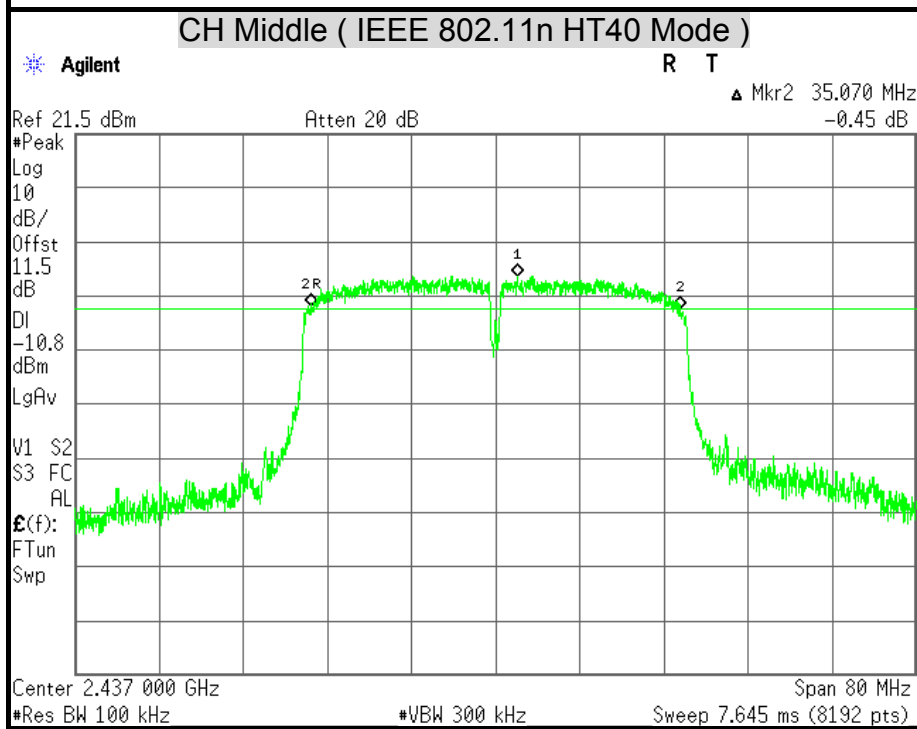
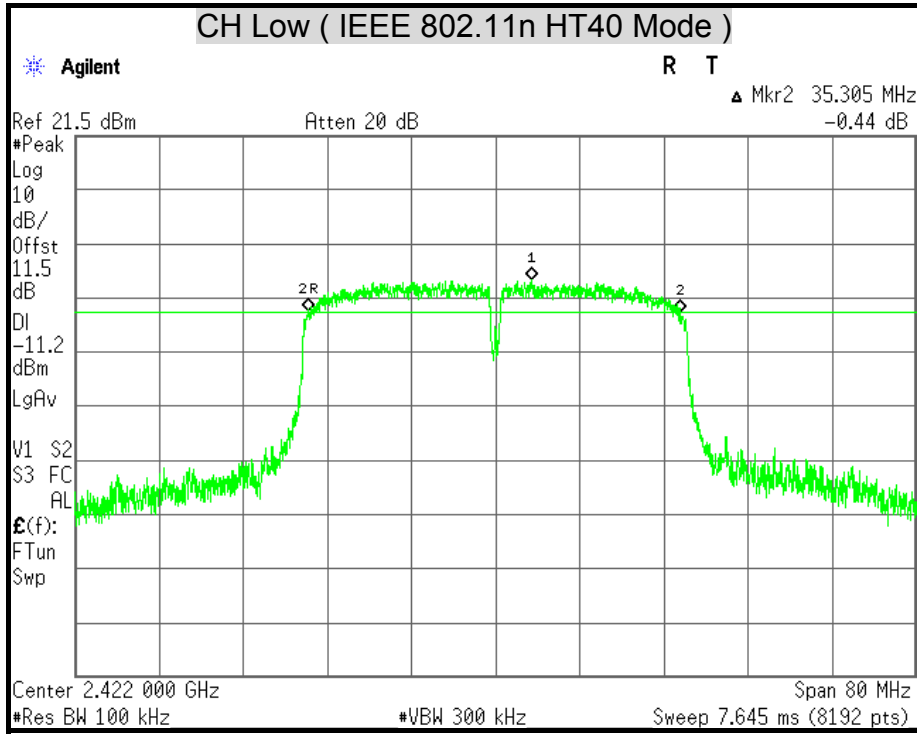

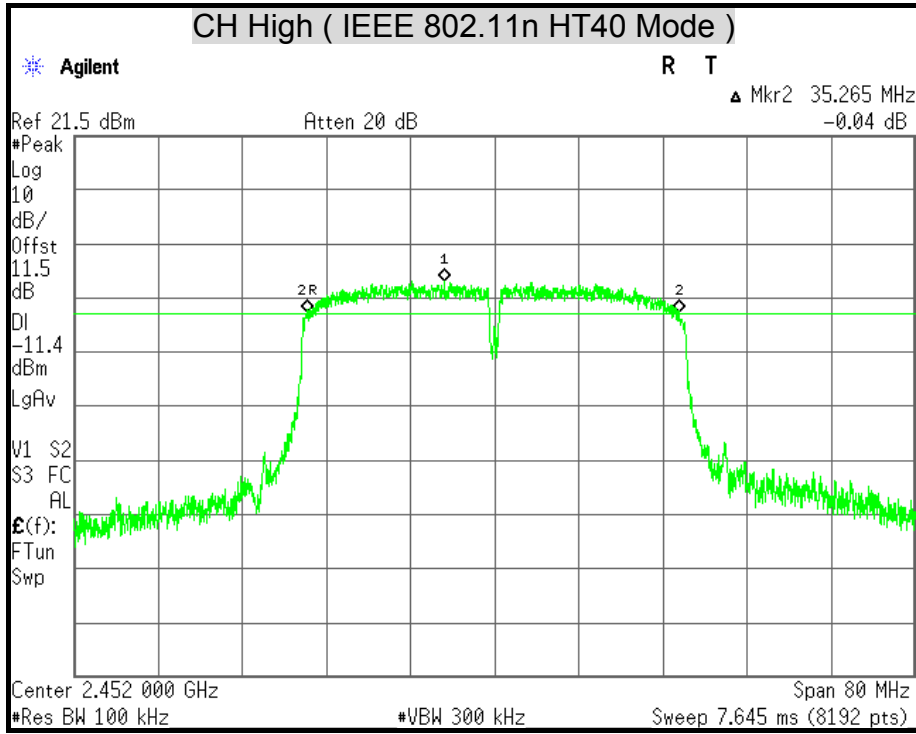

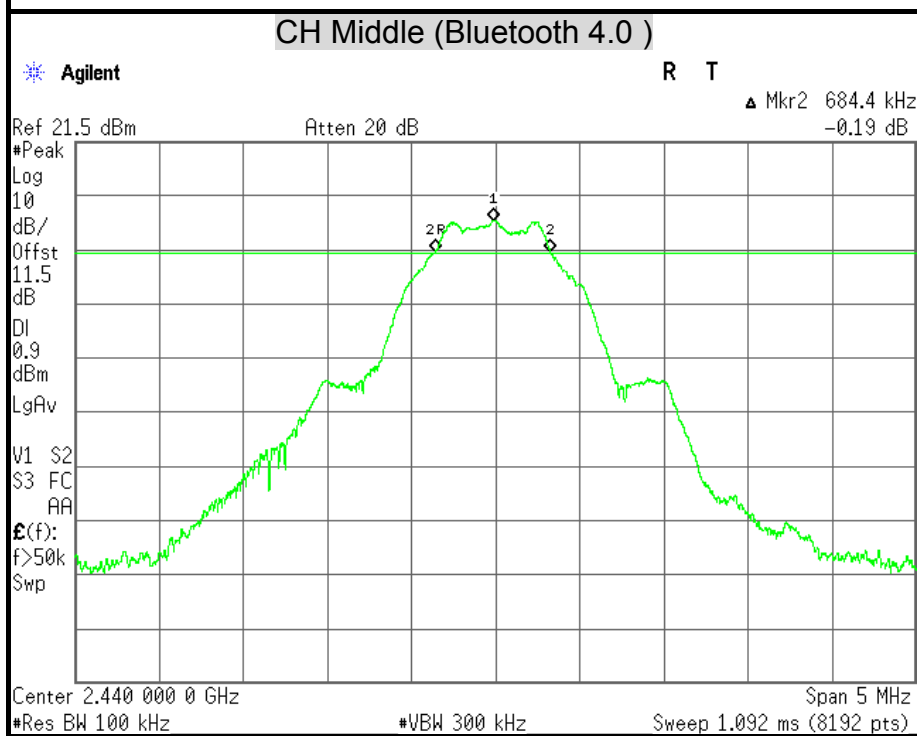
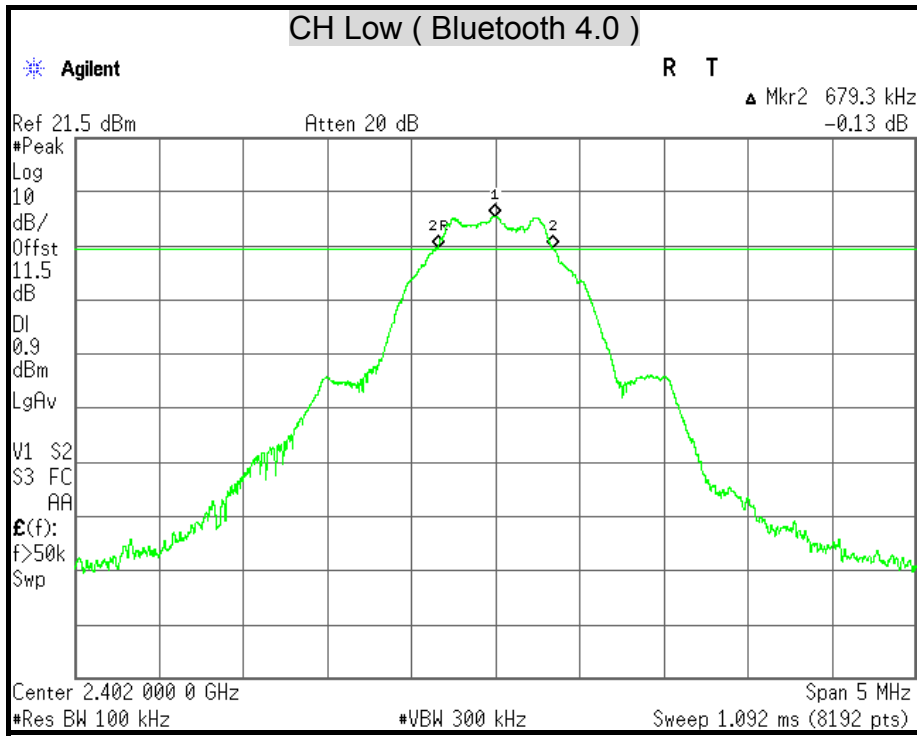

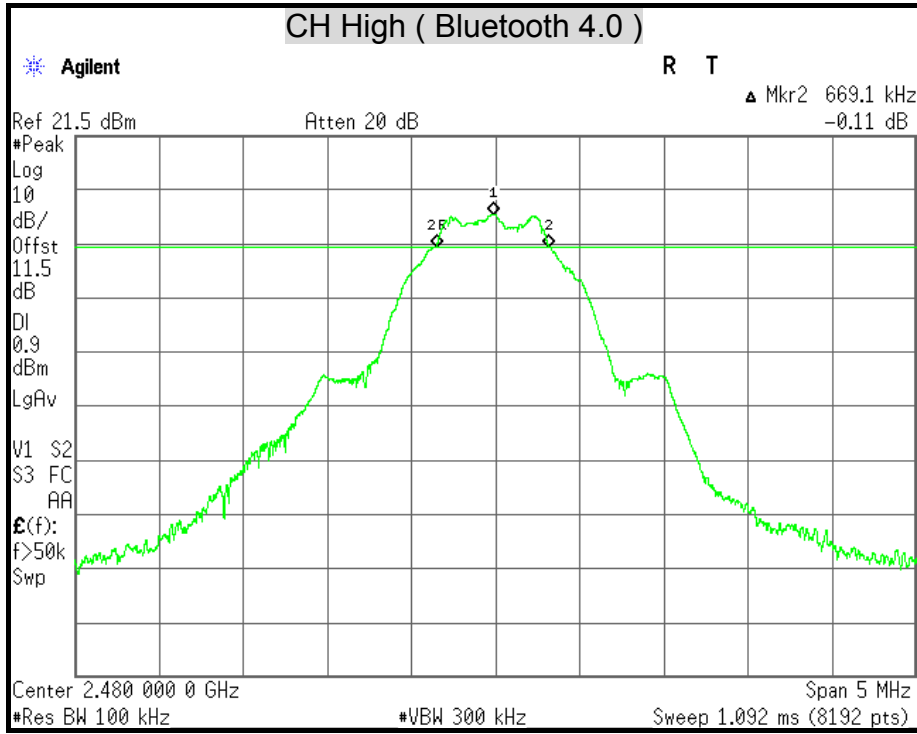



7.2 MAXIMUM PEAK OUTPUT POWER

LIMITS

§ 15.247(b) The maximum peak output power of the intentional radiator shall not exceed the following :

§ 15.247(b) (3) For systems using digital modulation in the 902-928 MHz, 2400-2483.5 MHz, and 5725-5850 MHz bands : 1 watt.

§ 15.247(b) (4) Except as shown in paragraphs (c) of this section, if transmitting antennas of directional gain greater than 6 dBi are used the peak output power from the intentional radiator shall be reduced below the stated values in paragraphs (b)(1) or (b)(2), and (b)(3) of this section, as appropriate, by the amount in dB that the directional gain of the antenna exceeds 6 dBi.

TEST EQUIPMENT

Name of Equipment	Manufacturer	Model	Serial Number	Calibration Due
Power Meter	Anritsu	ML2495A	1149001	12/06/2014
Power Sensor	Anritsu	MA2411B	1126148	12/06/2014

Remark: Each piece of equipment is scheduled for calibration once a year.

TEST SETUP

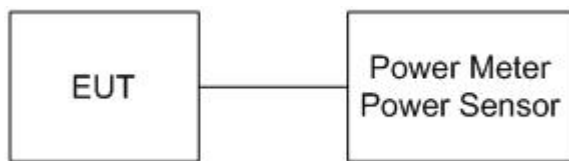

TEST PROCEDURE

The transmitter output is connected to the Power Meter. The Power Meter is set to the peak power detection.



TEST RESULTS

IEEE 802.11a Mode

Channel	Channel Frequency (MHz)	Peak Power		Peak Power Limit		Pass / Fail
		(dBm)	(W)	(dBm)	(W)	
Low	5745	18.13	0.0650	30	1	PASS
Middle	5785	18.12	0.0649	30	1	PASS
High	5825	18.08	0.0643	30	1	PASS

Remark:

1. At final test to get the worst-case emission at 6Mbps.
2. The cable assembly insertion loss of 12 dB (including 10 dB pad and 2 dB cable) was Entered as an offset in the power meter to allow for direct reading of power.

IEEE 802.11an HT20 Mode

Channel	Channel Frequency (MHz)	Peak Power		Peak Power Limit		Pass / Fail
		(dBm)	(W)	(dBm)	(W)	
Low	5745	18.26	0.0670	30	1	PASS
Middle	5785	18.36	0.0685	30	1	PASS
High	5825	18.41	0.0693	30	1	PASS

Remark:

1. At final test to get the worst-case emission at 6.5Mbps.
2. The cable assembly insertion loss of 12 dB (including 10 dB pad and 2 dB cable) was Entered as an offset in the power meter to allow for direct reading of power.

IEEE 802.11an HT40 Mode

Channel	Channel Frequency (MHz)	Peak Power		Peak Power Limit		Pass / Fail
		(dBm)	(W)	(dBm)	(W)	
Low	5755	18.06	0.0640	30	1	PASS
High	5815	18.01	0.0632	30	1	PASS

Remark:

1. At final test to get the worst-case emission at 13.5Mbps.
2. The cable assembly insertion loss of 12 dB (including 10 dB pad and 2 dB cable) was Entered as an offset in the power meter to allow for direct reading of power.



IEEE 802.11b Mode

Channel	Channel Frequency (MHz)	Peak Power		Peak Power Limit		Pass / Fail
		(dBm)	(W)	(dBm)	(W)	
Low	2412	16.76	0.0474	30	1	PASS
Middle	2437	18.36	0.0685	30	1	PASS
High	2462	16.73	0.0471	30	1	PASS

Remark:

1. At final test to get the worst-case emission at 1Mbps.
2. The cable assembly insertion loss of 11.5 dB (including 10 dB pad and 1.5 dB cable) was Entered as an offset in the power meter to allow for direct reading of power.

IEEE 802.11g Mode

Channel	Channel Frequency (MHz)	Peak Power		Peak Power Limit		Pass / Fail
		(dBm)	(W)	(dBm)	(W)	
Low	2412	21.18	0.1312	30	1	PASS
Middle	2437	20.52	0.1127	30	1	PASS
High	2462	19.91	0.0979	30	1	PASS

Remark:

1. At final test to get the worst-case emission at 6Mbps.
2. The cable assembly insertion loss of 11.5 dB (including 10 dB pad and 1.5 dB cable) was Entered as an offset in the power meter to allow for direct reading of power.

IEEE 802.11n HT20 Mode

Channel	Channel Frequency (MHz)	Peak Power		Peak Power Limit		Pass / Fail
		(dBm)	(W)	(dBm)	(W)	
Low	2412	20.74	0.1186	30	1	PASS
Middle	2437	20.53	0.1130	30	1	PASS
High	2462	19.45	0.0881	30	1	PASS

Remark:

1. At final test to get the worst-case emission at 6.5Mbps.
2. The cable assembly insertion loss of 11.5 dB (including 10 dB pad and 1.5 dB cable) was Entered as an offset in the power meter to allow for direct reading of power.



IEEE 802.11n HT40 Mode

Channel	Channel Frequency (MHz)	Peak Power		Peak Power Limit		Pass / Fail
		(dBm)	(W)	(dBm)	(W)	
Low	2422	20.37	0.1089	30	1	PASS
Middle	2437	20.23	0.1054	30	1	PASS
High	2452	19.71	0.0935	30	1	PASS

Remark:

1. At final test to get the worst-case emission at 13.5Mbps.
2. The cable assembly insertion loss of 11.5 dB (including 10 dB pad and 1.5 dB cable) was Entered as an offset in the power meter to allow for direct reading of power.

Bluetooth 4.0 Mode

Channel	Channel Frequency (MHz)	Peak Power		Peak Power Limit		Pass / Fail
		(dBm)	(W)	(dBm)	(W)	
Low	2402	7.59	0.0057	30	1	PASS
Middle	2440	7.70	0.0059	30	1	PASS
High	2480	7.64	0.0058	30	1	PASS

Remark: The cable assembly insertion loss of 11.5 dB (including 10 dB pad and 1.5 dB cable) was Entered as an offset in the power meter to allow for direct reading of power.



7.3 AVERAGE POWER

LIMITS

None; for reporting purposes only.

TEST EQUIPMENT

Name of Equipment	Manufacturer	Model	Serial Number	Calibration Due
Power Meter	ANRITSU	ML2495A	1149001	12/06/2014
Power Sensor	ANRITSU	MA2411B	1126148	12/06/2014

Remark: Each piece of equipment is scheduled for calibration once a year.

TEST SETUP



TEST PROCEDURE

The transmitter output is connected to the Power Meter. The Power Meter is set to the average power detection.



TEST RESULTS

IEEE 802.11a Mode

Channel	Channel Frequency (MHz)	Average Power (dBm)
Low	5745	11.32
Middle	5785	11.03
High	5825	11.01

Remark:

1. At final test to get the worst-case emission at 6Mbps.
2. The cable assembly insertion loss of 12 dB (including 10 dB pad and 2 dB cable) was Entered as an offset in the power meter to allow for direct reading of power.

IEEE 802.11an HT20 Mode

Channel	Channel Frequency (MHz)	Average Power (dBm)
Low	5745	11.33
Middle	5785	11.06
High	5825	11.09

Remark:

1. At final test to get the worst-case emission at 6.5Mbps.
2. The cable assembly insertion loss of 12 dB (including 10 dB pad and 2 dB cable) was Entered as an offset in the power meter to allow for direct reading of power.

IEEE 802.11an HT40 Mode

Channel	Channel Frequency (MHz)	Average Power (dBm)
Low	5755	11.38
High	5795	11.23

Remark:

1. At final test to get the worst-case emission at 13.5Mbps.
2. The cable assembly insertion loss of 12 dB (including 10 dB pad and 2 dB cable) was Entered as an offset in the power meter to allow for direct reading of power.



IEEE 802.11b Mode

Channel	Channel Frequency (MHz)	Average Power (dBm)
Low	2412	13.73
Middle	2437	15.48
High	2462	13.76

Remark:

1. At final test to get the worst-case emission at 1Mbps.
2. The cable assembly insertion loss of 11.5 dB (including 10 dB pad and 1.5 dB cable) was Entered as an offset in the power meter to allow for direct reading of power.

IEEE 802.11g Mode

Channel	Channel Frequency (MHz)	Average Power (dBm)
Low	2412	12.58
Middle	2437	12.16
High	2462	10.73

Remark:

1. At final test to get the worst-case emission at 6Mbps.
2. The cable assembly insertion loss of 11.5 dB (including 10 dB pad and 1.5 dB cable) was Entered as an offset in the power meter to allow for direct reading of power.

IEEE 802.11n HT20 Mode

Channel	Channel Frequency (MHz)	Average Power (dBm)
Low	2412	12.06
Middle	2437	12.06
High	2462	10.01

Remark:

1. At final test to get the worst-case emission at 6.5Mbps.
2. The cable assembly insertion loss of 11.5 dB (including 10 dB pad and 1.5 dB cable) was Entered as an offset in the power meter to allow for direct reading of power.



IEEE 802.11n HT40 Mode

Channel	Channel Frequency (MHz)	Average Power Total (dBm)
Low	2422	11.27
Middle	2437	12.31
High	2452	10.46

Remark:

1. At final test to get the worst-case emission at 13.5Mbps.
2. The cable assembly insertion loss of 11.5 dB (including 10 dB pad and 1.5 dB cable) was Entered as an offset in the power meter to allow for direct reading of power.

Bluetooth 4.0 Mode

Channel	Channel Frequency (MHz)	Average Power (dBm)
Low	2402	7.45
Middle	2440	7.58
High	2480	7.47

Remark: The cable assembly insertion loss of 11.5dB (including 10 dB pad and 1.5 dB cable) was Entered as an offset in the power meter to allow for direct reading of power.



7.4 POWER SPECTRAL DENSITY

LIMITS

§ 15.247(e) For digitally modulated systems, the power spectral density conducted from the intentional radiator to the antenna shall not greater than 8 dBm in any 3 kHz band during any time interval of continuous transmission.

TEST EQUIPMENT

Name of Equipment	Manufacturer	Model	Serial Number	Calibration Due
Spectrum Analyzer	Agilent	E4446A	MY43360132	06/10/2014

Remark: Each piece of equipment is scheduled for calibration once a year.

TEST SETUP



TEST PROCEDURE

1. The transmitter output was connected to the spectrum analyzer.
2. Set analyzer center frequency to DTS channel center frequency.
3. Set the span to 1.5 times the DTS channel bandwidth.
4. Set the RBW to: $3 \text{ kHz} \leq \text{RBW} \leq 100 \text{ kHz}$.
5. Set the VBW $\geq 3 \times \text{RBW}$.
6. Detector = peak.
7. Sweep time = auto couple.
8. Trace mode = max hold.
9. Allow trace to fully stabilize.
10. Use the peak marker function to determine the maximum amplitude level within the RBW.
11. If measured value exceeds limit, reduce RBW (no less than 3 kHz) and repeat.



TEST RESULTS

IEEE 802.11a Mode

Channel	Channel Frequency (MHz)	Final RF Power Level in 3KHz BW (dBm)	Minimum Limit (dBm)	Pass / Fail
Low	5745	-6.19	8	PASS
Middle	5785	-5.88	8	PASS
High	5825	-5.08	8	PASS

Remark:

1. At final test to get the worst-case emission at 6Mbps.
2. The cable assembly insertion loss of 12 dB (including 10 dB pad and 2 dB cable) was Entered as an offset in the spectrum analyzer to allow for direct reading of power.

IEEE 802.11an HT20 Mode

Channel	Channel Frequency (MHz)	Final RF Power Level in 3KHz BW (dBm)	Minimum Limit (dBm)	Pass / Fail
Low	5745	-6.25	8	PASS
Middle	5785	-7.40	8	PASS
High	5825	-5.13	8	PASS

Remark:

1. At final test to get the worst-case emission at 6.5Mbps.
2. The cable assembly insertion loss of 12 dB (including 10 dB pad and 2 dB cable) was Entered as an offset in the spectrum analyzer to allow for direct reading of power.

IEEE 802.11an HT40 Mode

Channel	Channel Frequency (MHz)	Final RF Power Level in 3KHz BW (dBm)	Minimum Limit (dBm)	Pass / Fail
Low	5755	-11.15	8	PASS
High	5795	-10.31	8	PASS

Remark:

1. At final test to get the worst-case emission at 13.5Mbps.
2. The cable assembly insertion loss of 12 dB (including 10 dB pad and 2 dB cable) was Entered as an offset in the spectrum analyzer to allow for direct reading of power.



IEEE 802.11b Mode

Channel	Channel Frequency (MHz)	Final RF Power Level in 3KHz BW (dBm)	Minimum Limit (dBm)	Pass / Fail
Low	2412	-8.07	8	PASS
Middle	2437	-7.76	8	PASS
High	2462	-8.64	8	PASS

Remark:

1. At final test to get the worst-case emission at 1Mbps.
2. The cable assembly insertion loss of 11.5 dB (including 10 dB pad and 1.5 dB cable) was Entered as an offset in the spectrum analyzer to allow for direct reading of power.

IEEE 802.11g Mode

Channel	Channel Frequency (MHz)	Final RF Power Level in 3KHz BW (dBm)	Minimum Limit (dBm)	Pass / Fail
Low	2412	-15.36	8	PASS
Middle	2437	-8.75	8	PASS
High	2462	-15.48	8	PASS

Remark:

1. At final test to get the worst-case emission at 6Mbps.
2. The cable assembly insertion loss of 11.5 dB (including 10 dB pad and 1.5 dB cable) was Entered as an offset in the spectrum analyzer to allow for direct reading of power.



IEEE 802.11n HT20 Mode

Channel	Channel Frequency (MHz)	Final RF Power Level in 3KHz BW (dBm)	Minimum Limit (dBm)	Pass / Fail
Low	2412	-14.47	8	PASS
Middle	2437	-10.93	8	PASS
High	2462	-14.61	8	PASS

Remark:

1. At final test to get the worst-case emission at 13Mbps.
2. The cable assembly insertion loss of 11.5 dB (including 10 dB pad and 1.5 dB cable) was Entered as an offset in the spectrum analyzer to allow for direct reading of power.

IEEE 802.11n HT40 Mode

Channel	Channel Frequency (MHz)	Final RF Power Level in 3KHz BW (dBm)	Minimum Limit (dBm)	Pass / Fail
Low	2422	-18.81	8	PASS
Middle	2437	-18.13	8	PASS
High	2452	-18.87	8	PASS

Remark:

1. At final test to get the worst-case emission at 13.5Mbps.
2. The cable assembly insertion loss of 11.5 dB (including 10 dB pad and 1.5 dB cable) was Entered as an offset in the spectrum analyzer to allow for direct reading of power.

Bluetooth 4.0 Mode

Channel	Channel Frequency (MHz)	Final RF Power Level in 3KHz BW (dBm)	Minimum Limit (dBm)	Pass / Fail
Low	2402	-7.04	8	PASS
Middle	2440	-6.89	8	PASS
High	2480	-6.98	8	PASS

Remark: The cable assembly insertion loss of 11.5 dB (including 10 dB pad and 1.5 dB cable) was Entered as an offset in the spectrum analyzer to allow for direct reading of power.



POWER SPECTRAL DENSITY

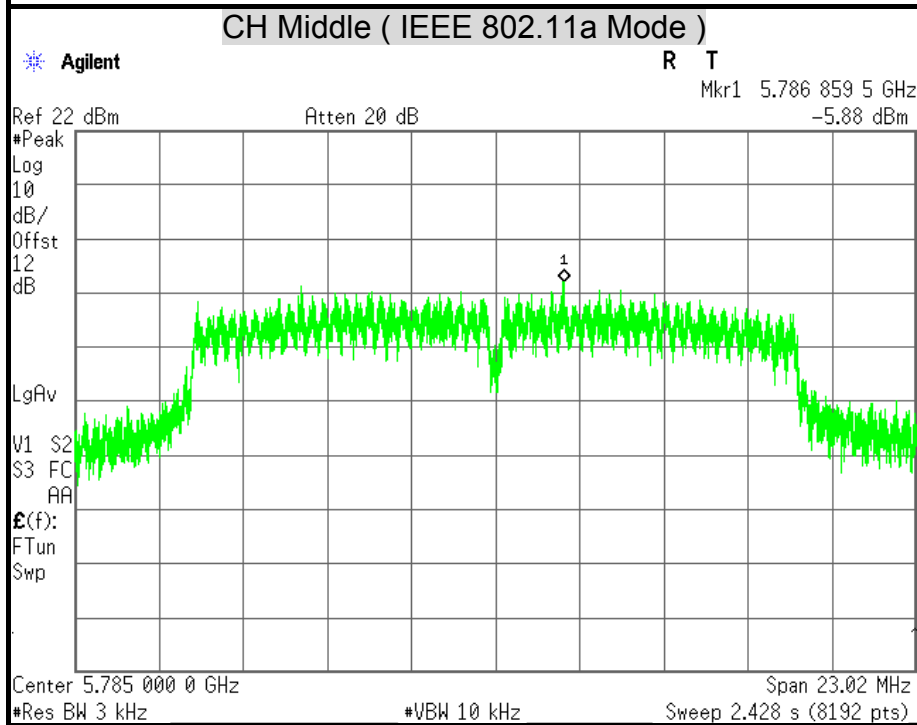
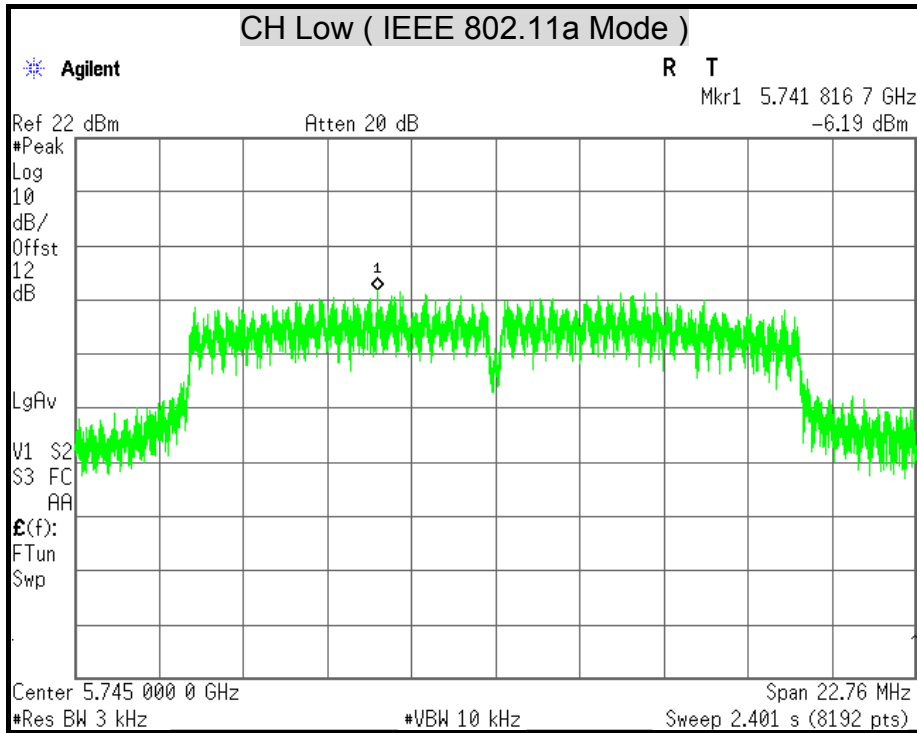

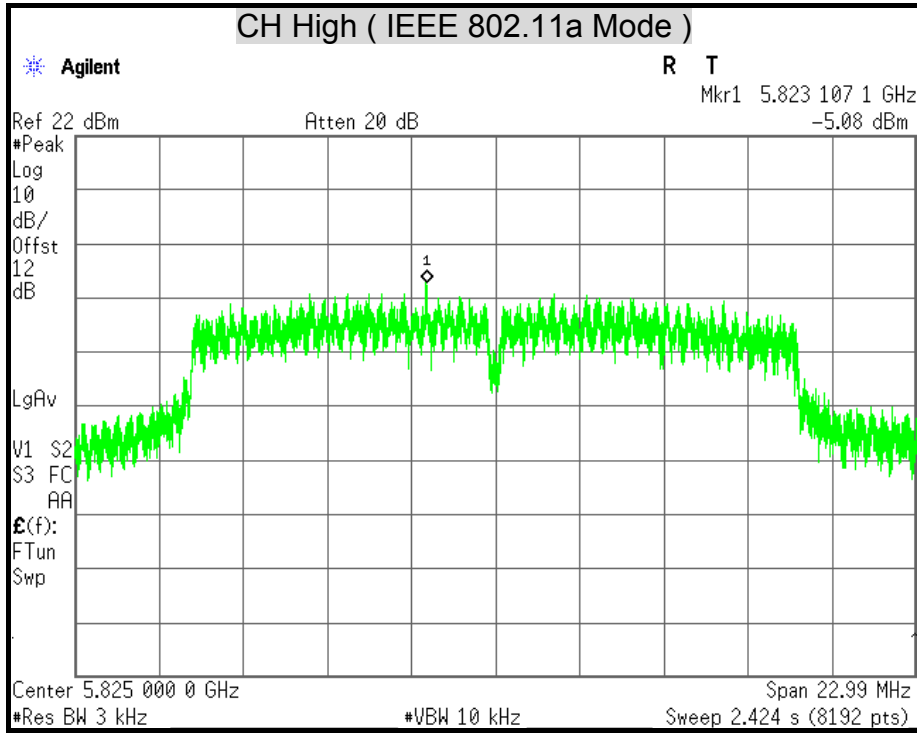

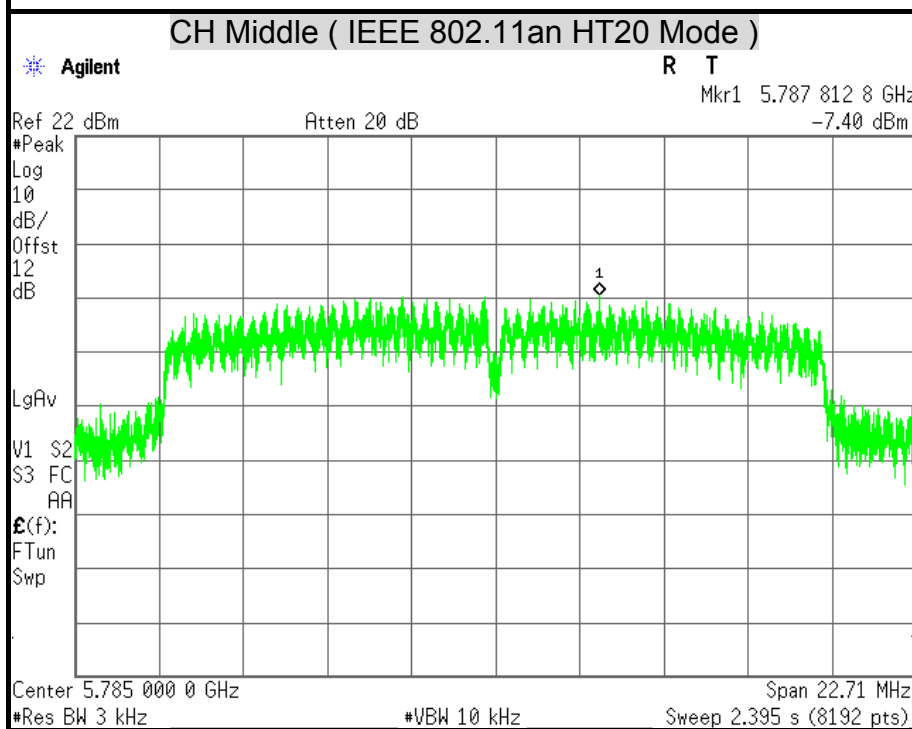
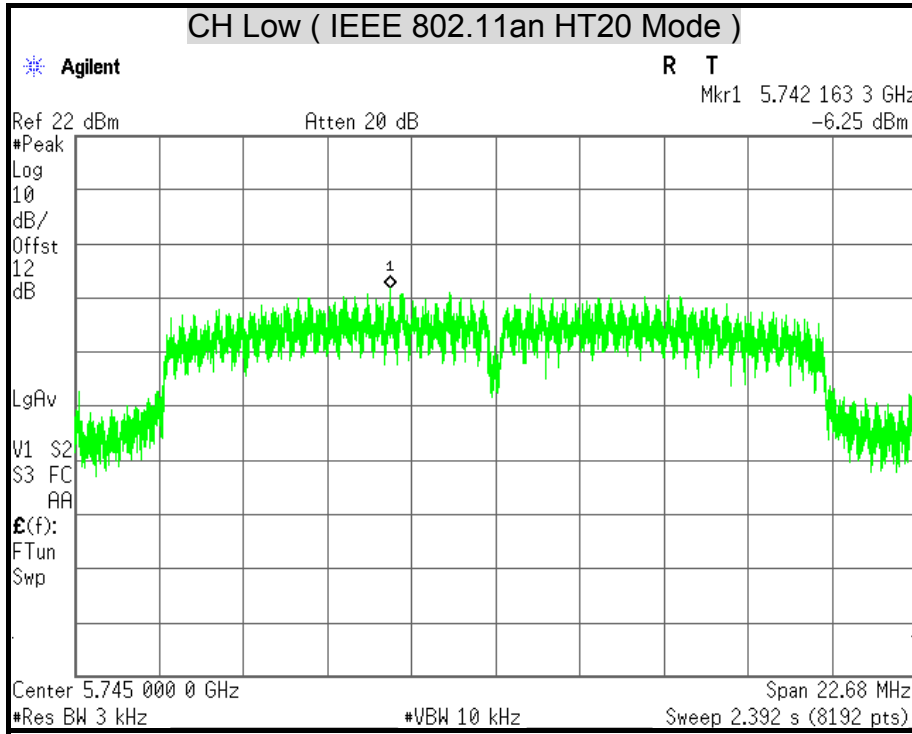

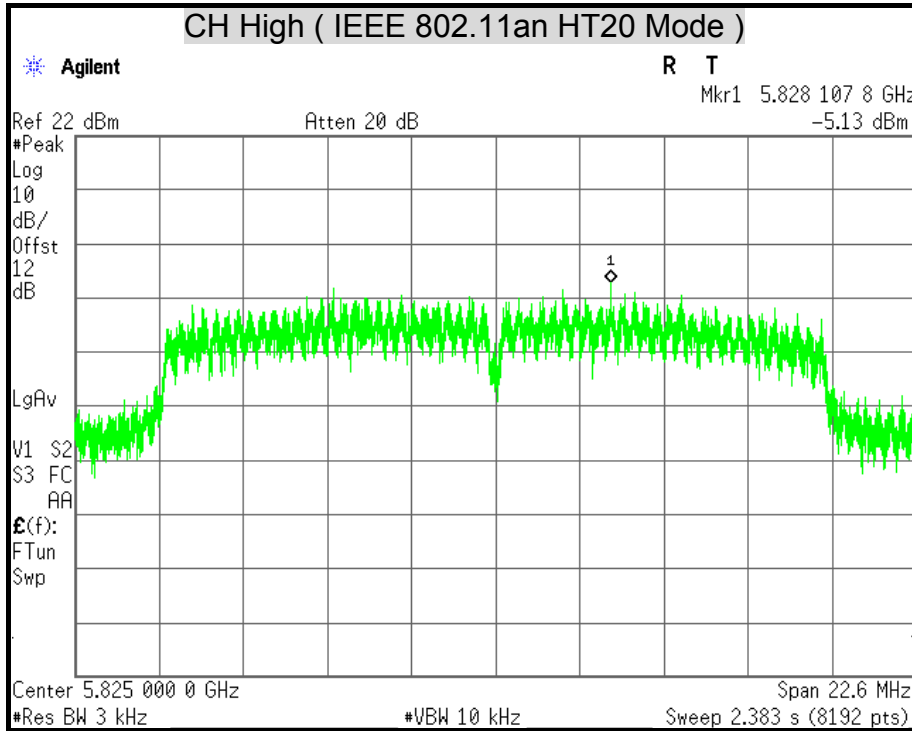

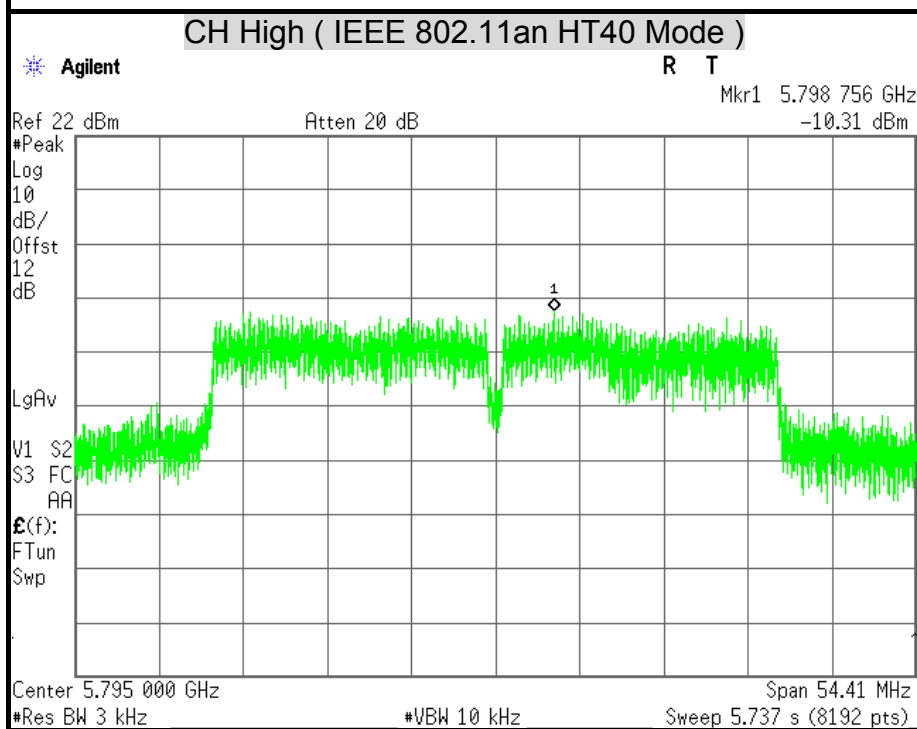
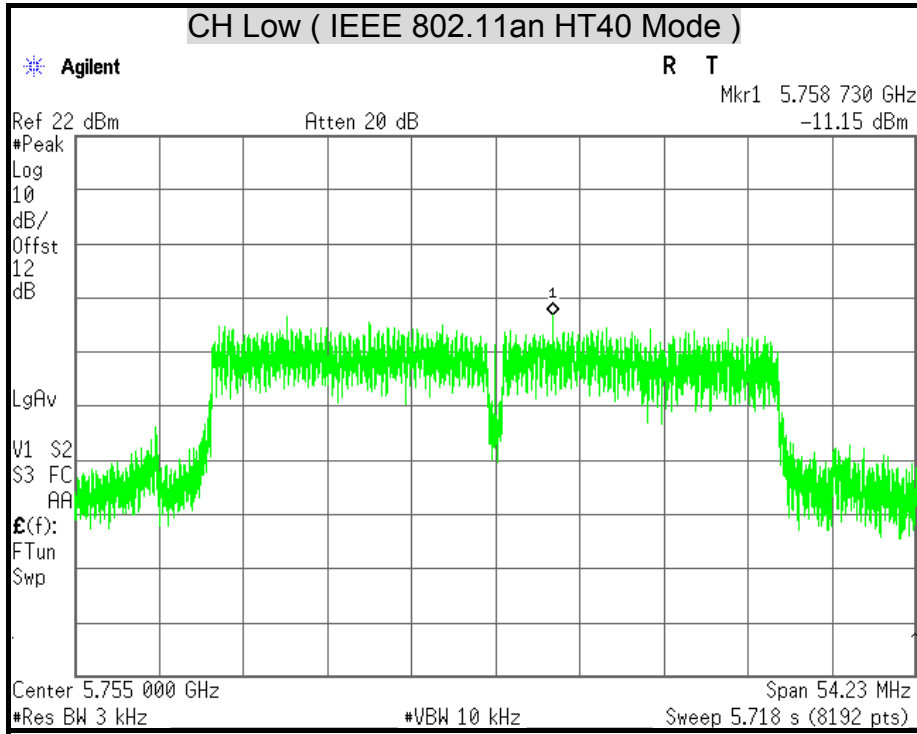

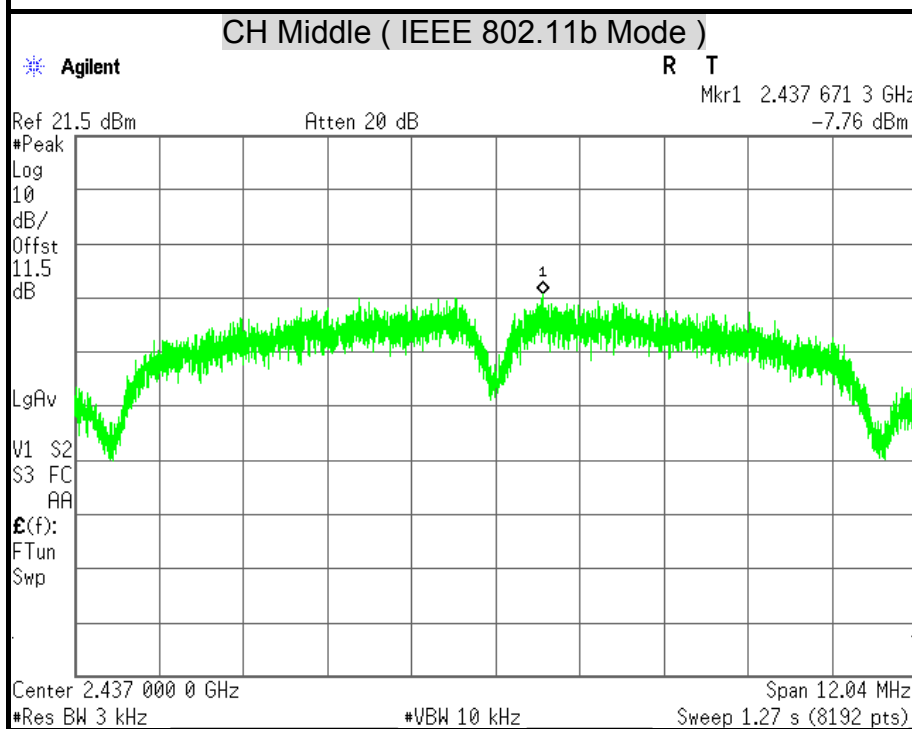
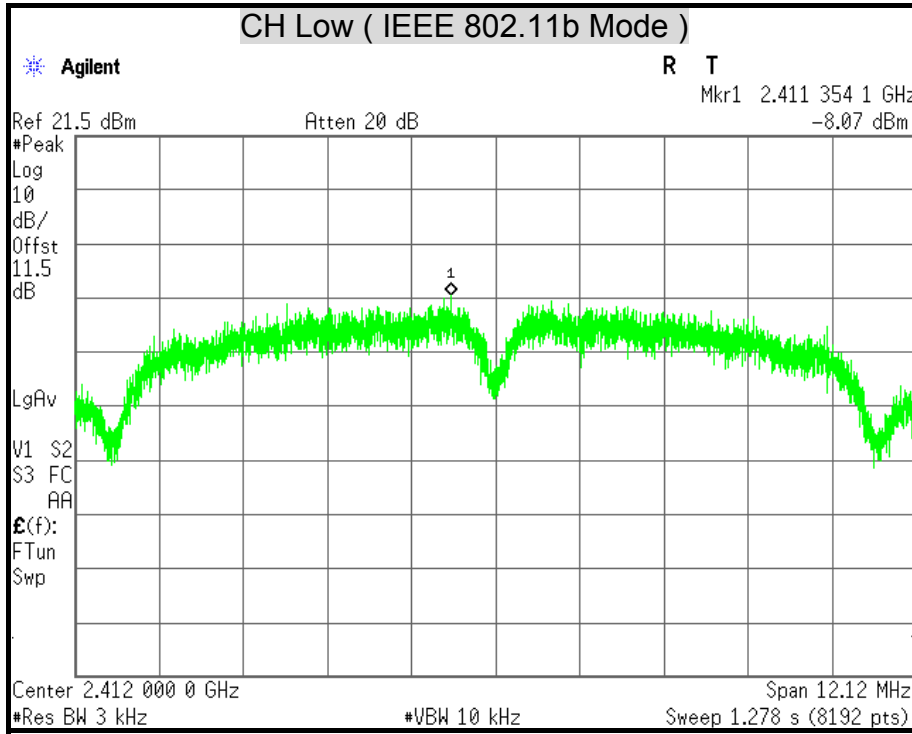

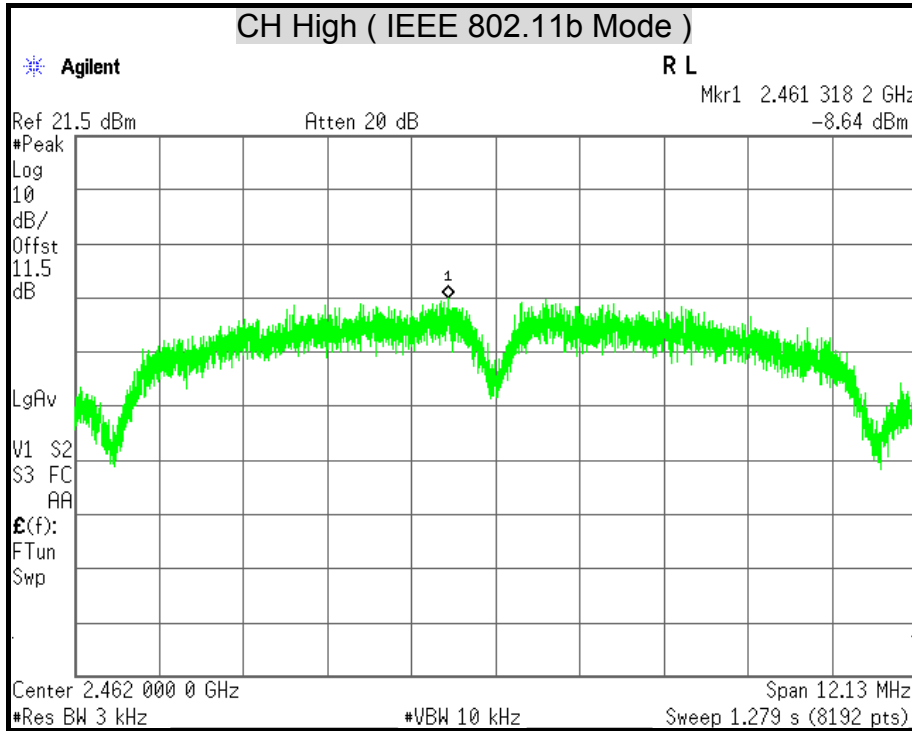

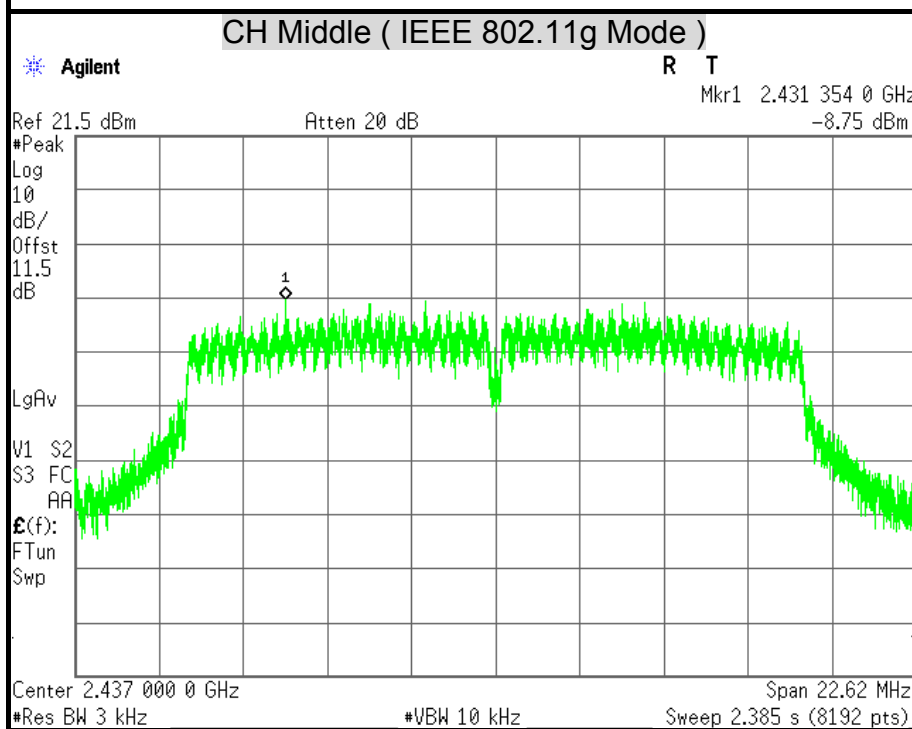
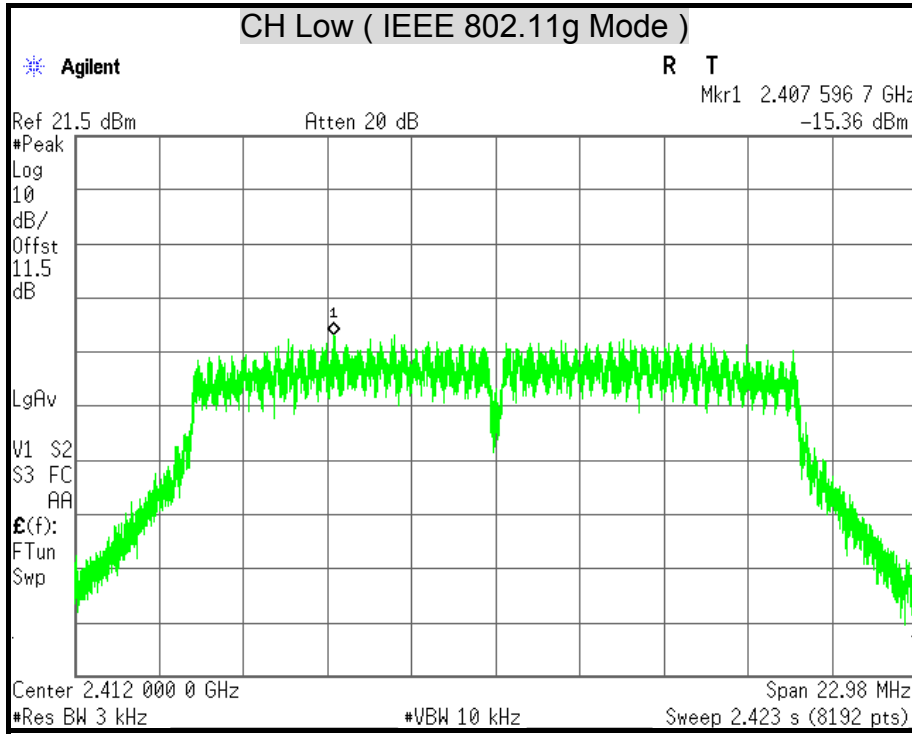

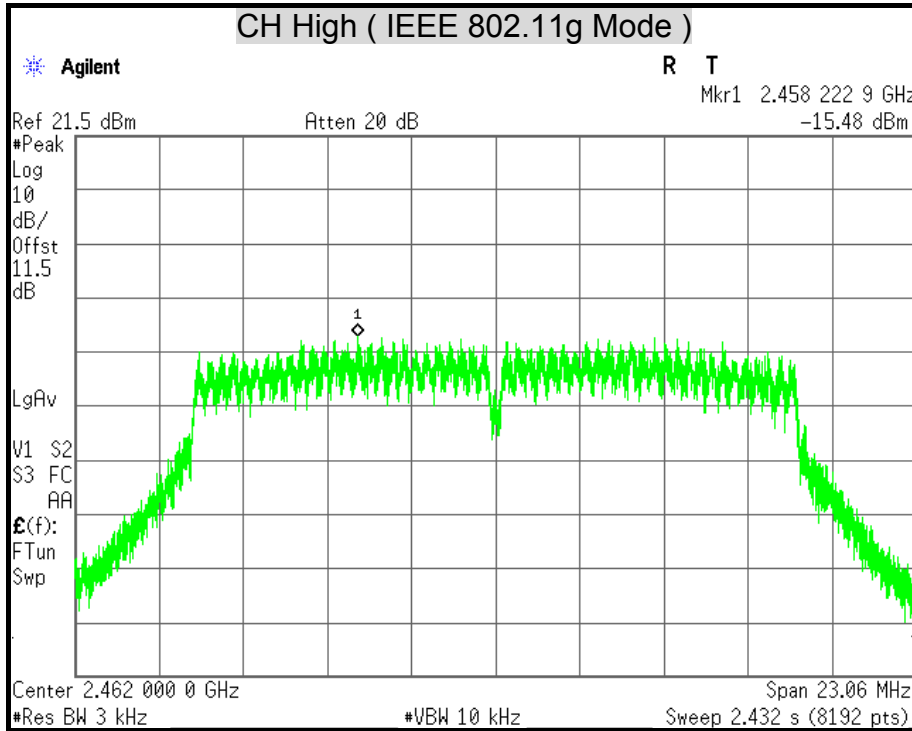

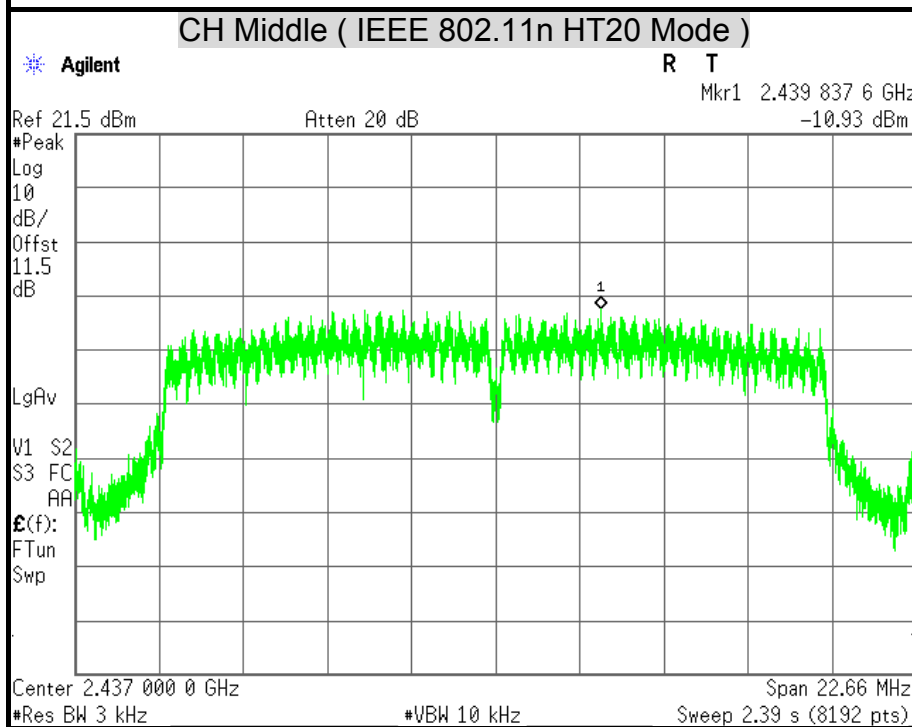
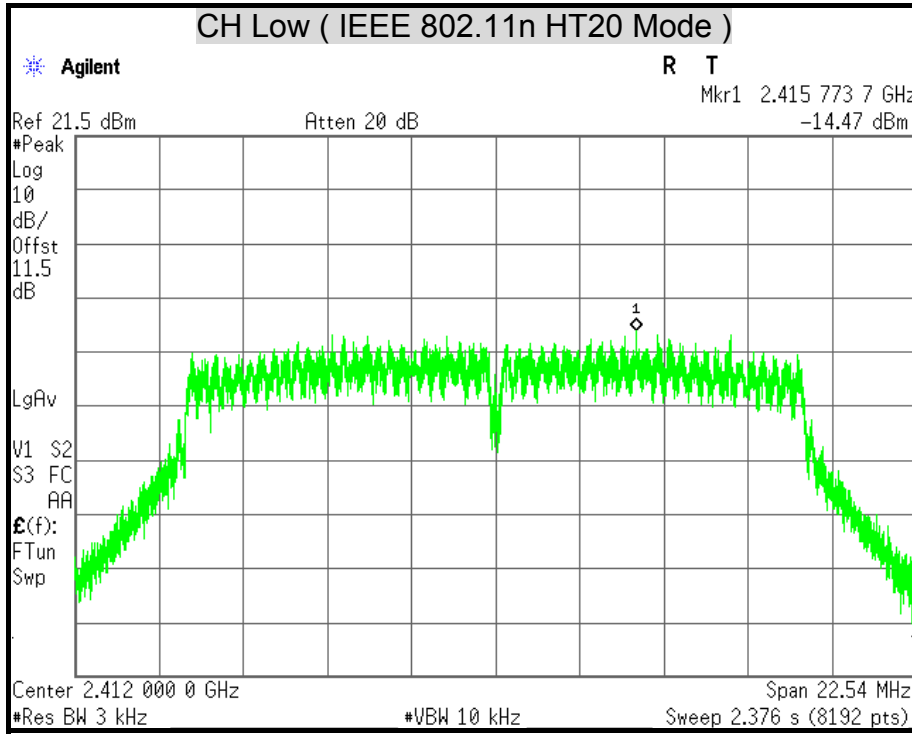

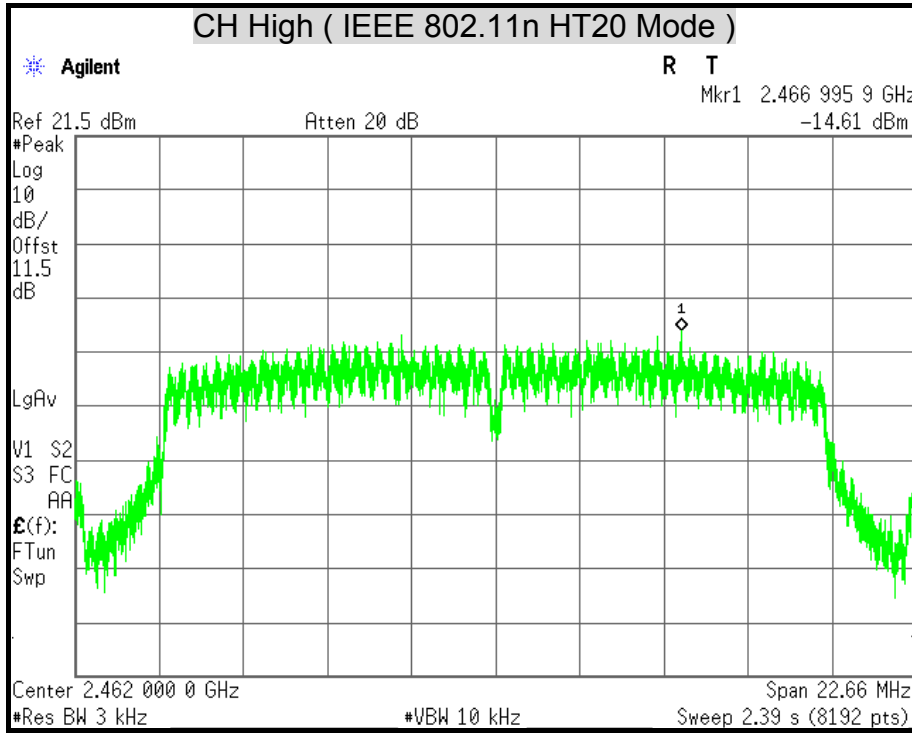

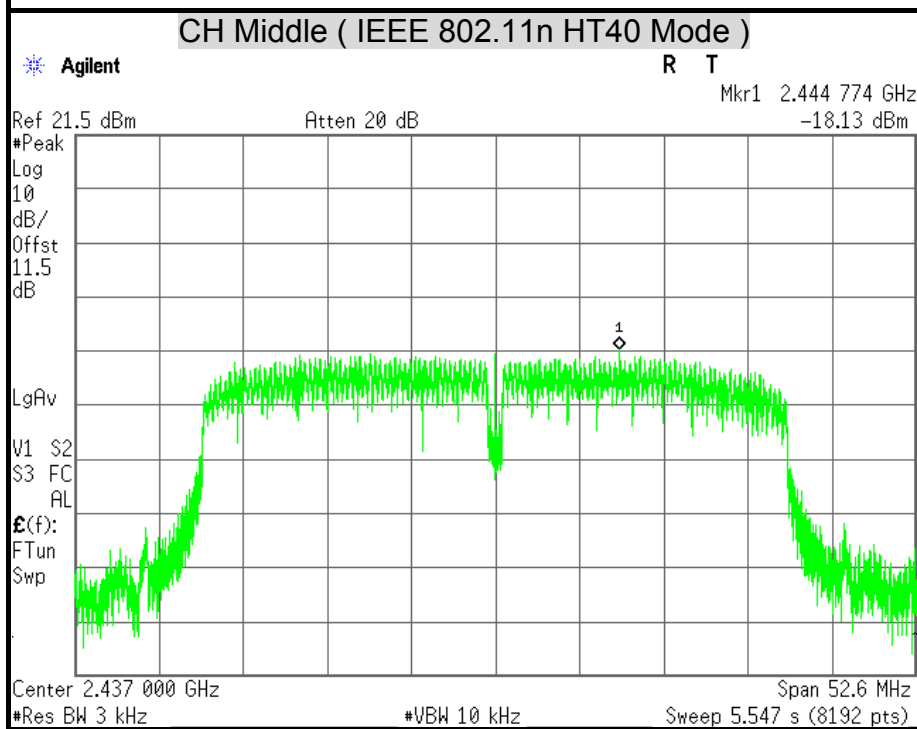
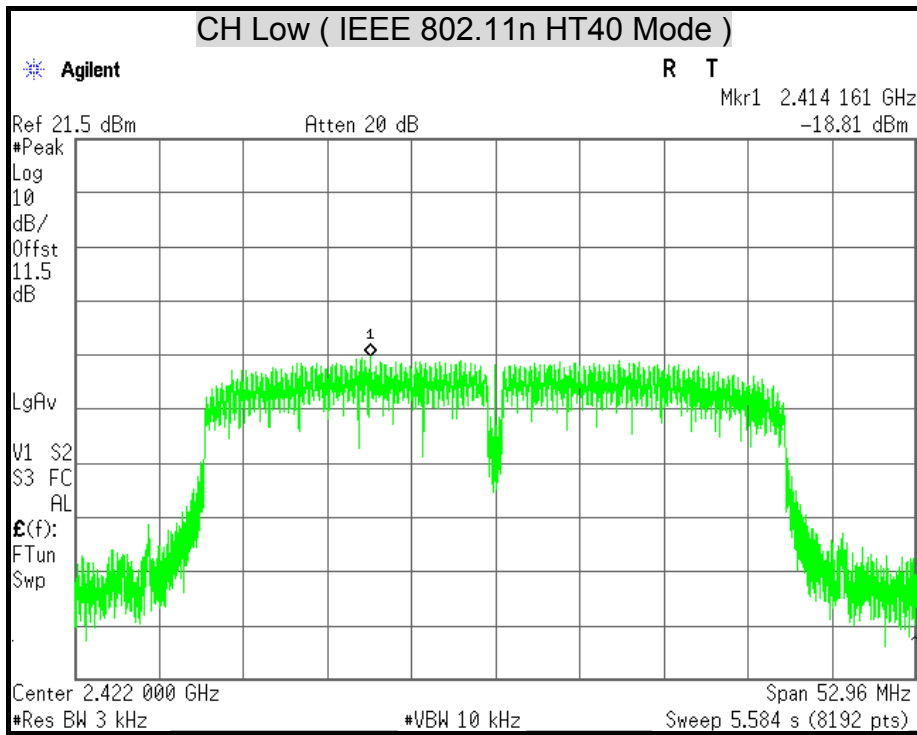

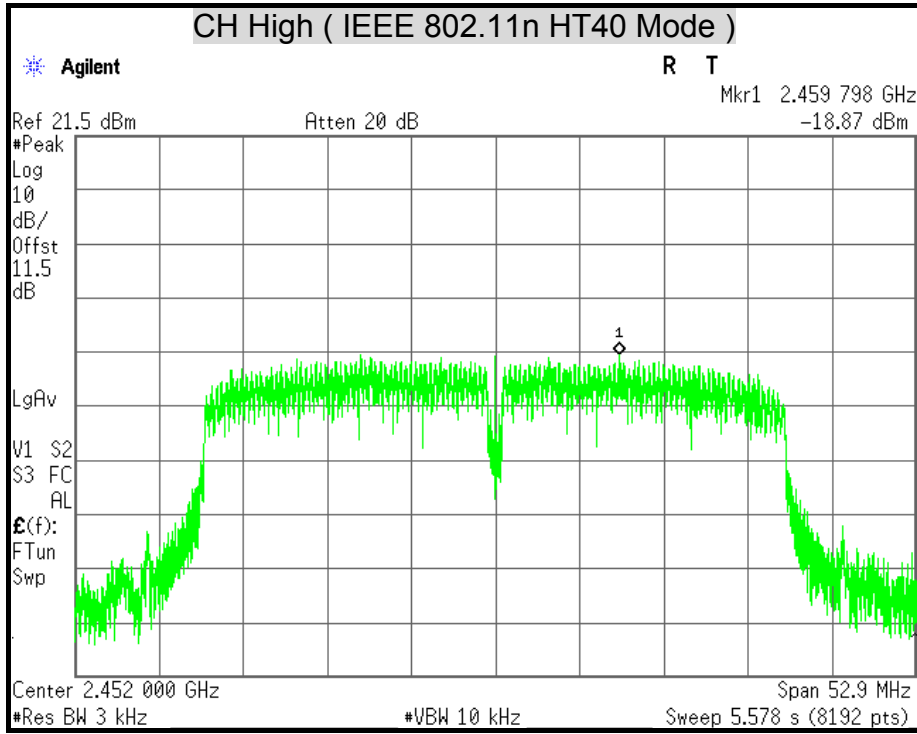

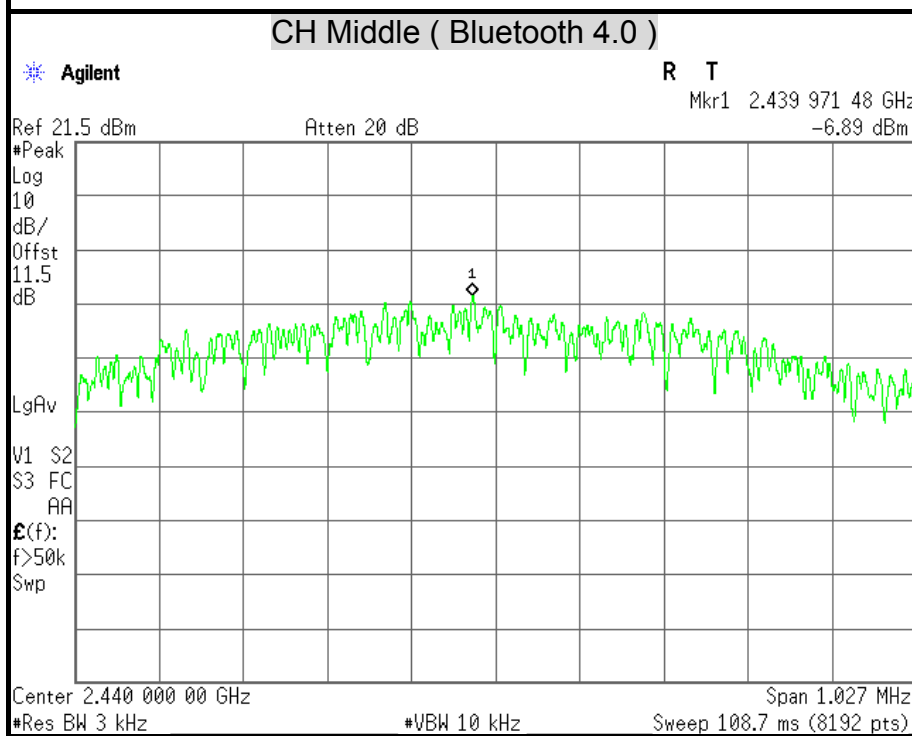
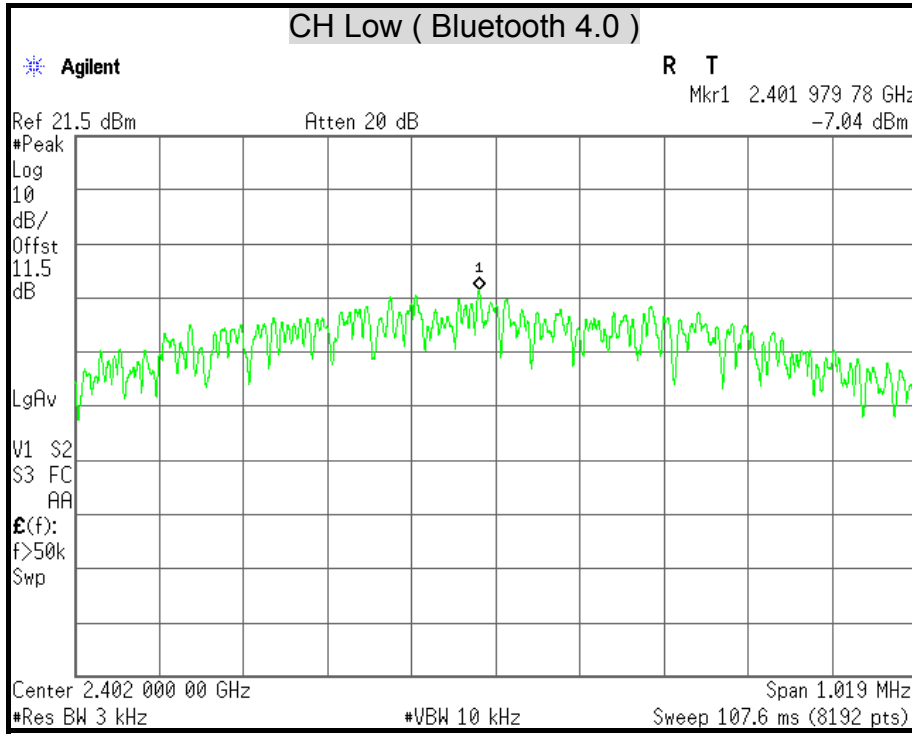

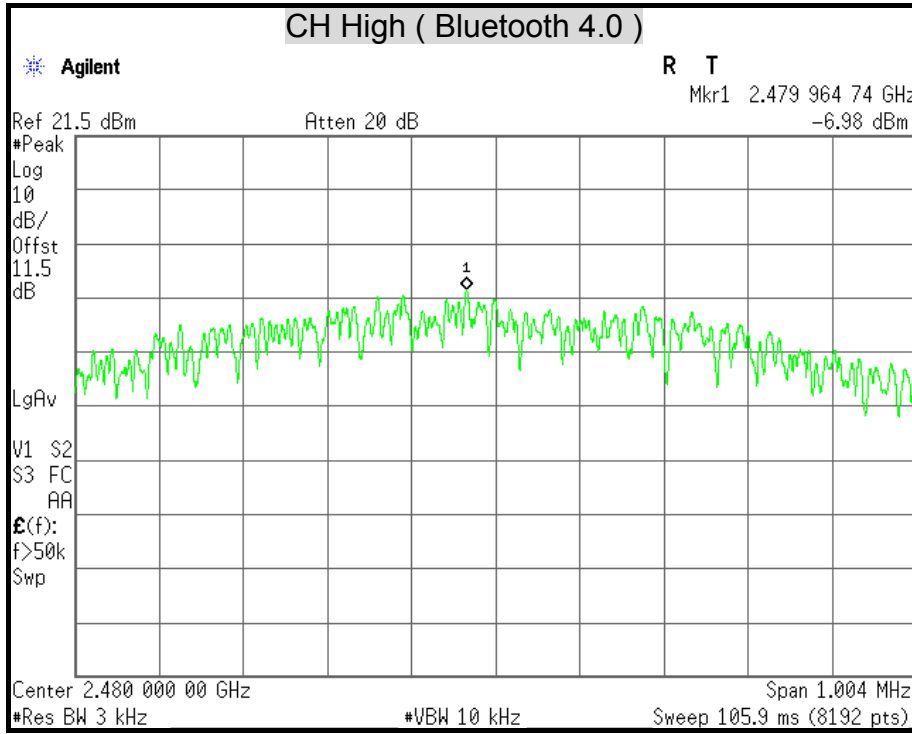



7.5 CONDUCTED SPURIOUS EMISSION

LIMITS

§ 15.247(d) In any 100 kHz bandwidth outside the frequency band in which the spread spectrum intentional radiator is operating, the radio frequency power that is produced by the intentional radiator shall be at least 20 dB below that in the 100 kHz bandwidth within the band that contains the highest level of the desired power, based on either an RF conducted or a radiated measurement. Attenuation below the general limits specified in § 15.209(a) is not required. In addition, radiated emissions which fall in the restricted bands, as defined in § 15.205(a), must also comply with the radiated emission limits specified in § 15.209(a) (see § 15.205(c)).

TEST EQUIPMENT

Name of Equipment	Manufacturer	Model	Serial Number	Calibration Due
Spectrum Analyzer	Agilent	E4446A	MY43360132	06/10/2014

Remark: Each piece of equipment is scheduled for calibration once a year.

TEST SETUP



TEST PROCEDURE

The transmitter output is connected to a spectrum analyzer. The resolution bandwidth is set to 100 kHz. The video bandwidth is set to 300 kHz.

The spectrum from 30 MHz to 26.5 GHz is investigated with the transmitter set to the lowest, middle, and highest channels in the 2.4 GHz band.

The spectrum from 30 MHz to 40 GHz is investigated with the transmitter set to the lowest, middle, and highest channels in the 5 GHz band.



TEST RESULTS

OUT-OF-BAND SPURIOUS EMISSIONS-CONDUCTED MEASUREMENT

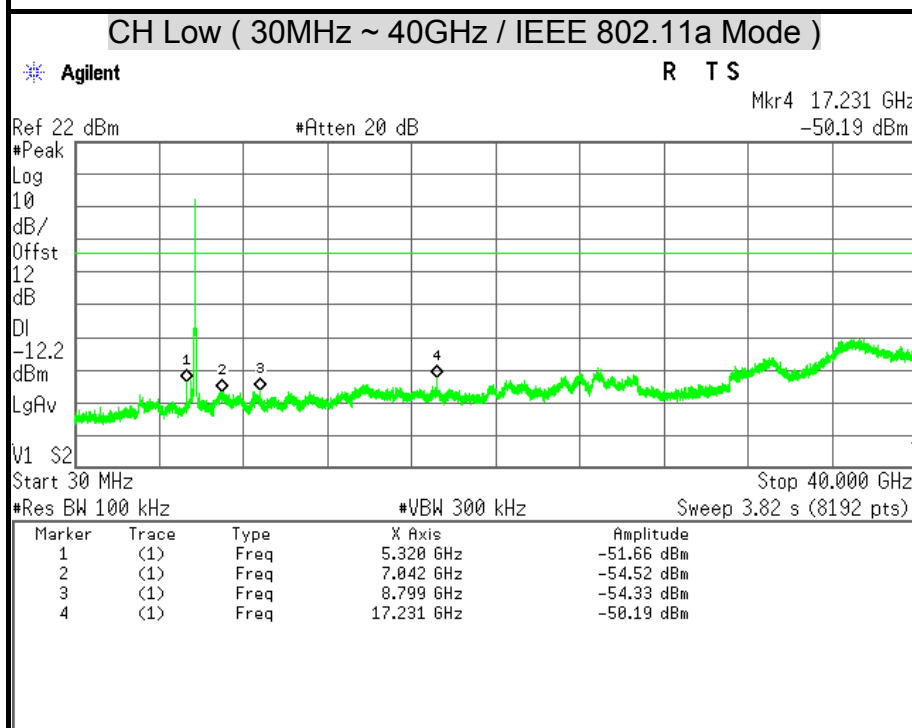
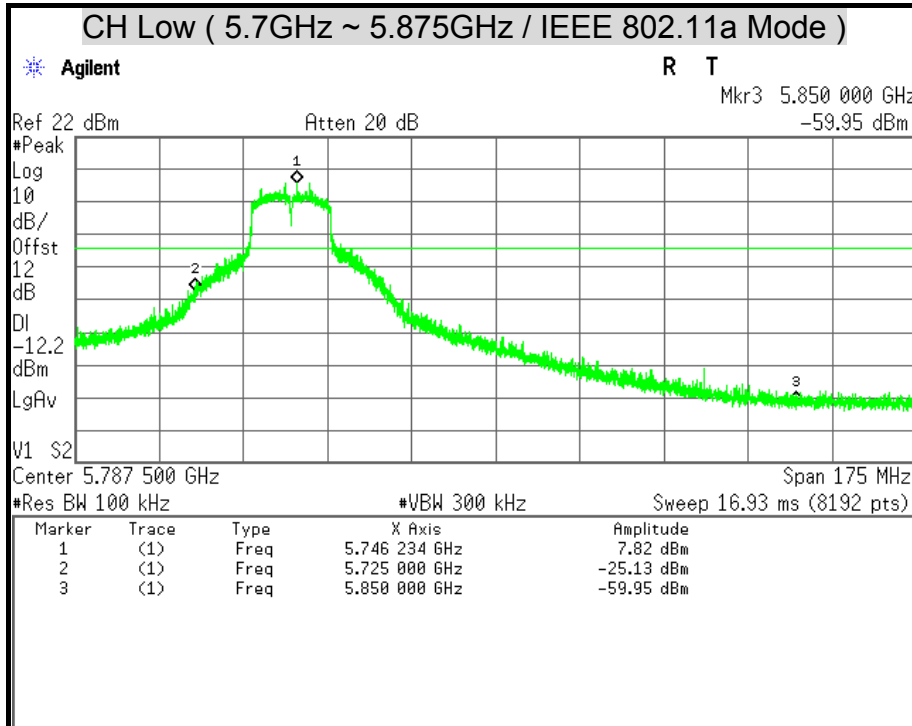

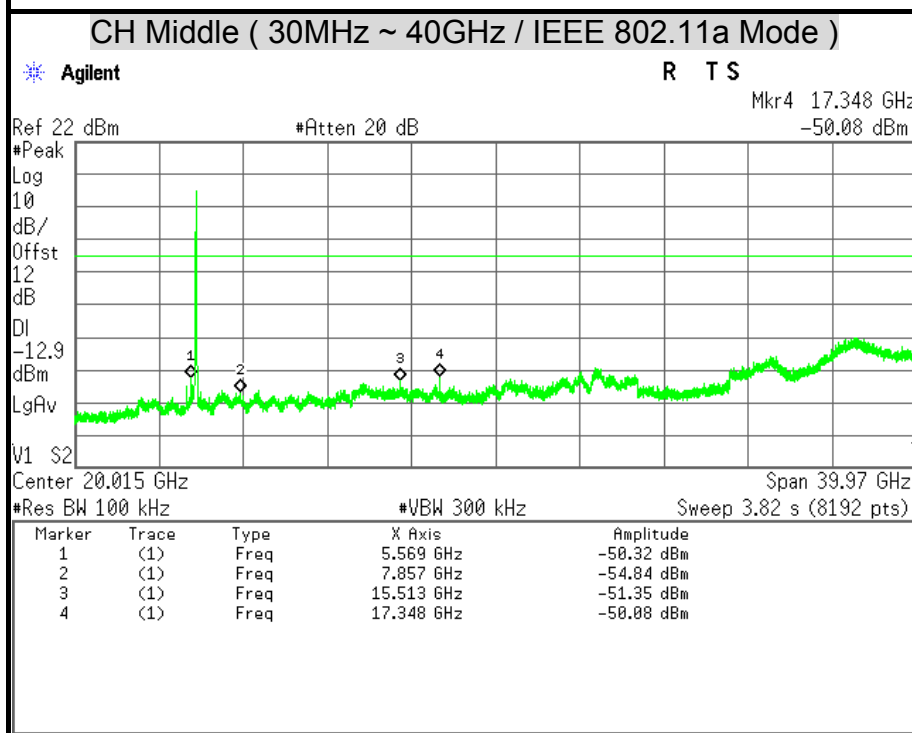
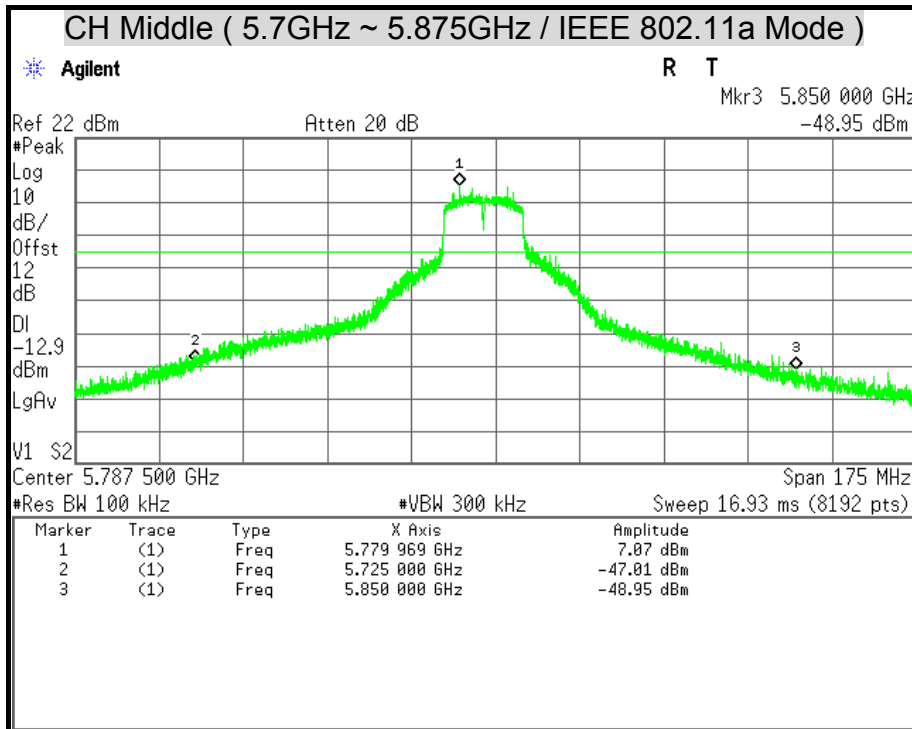

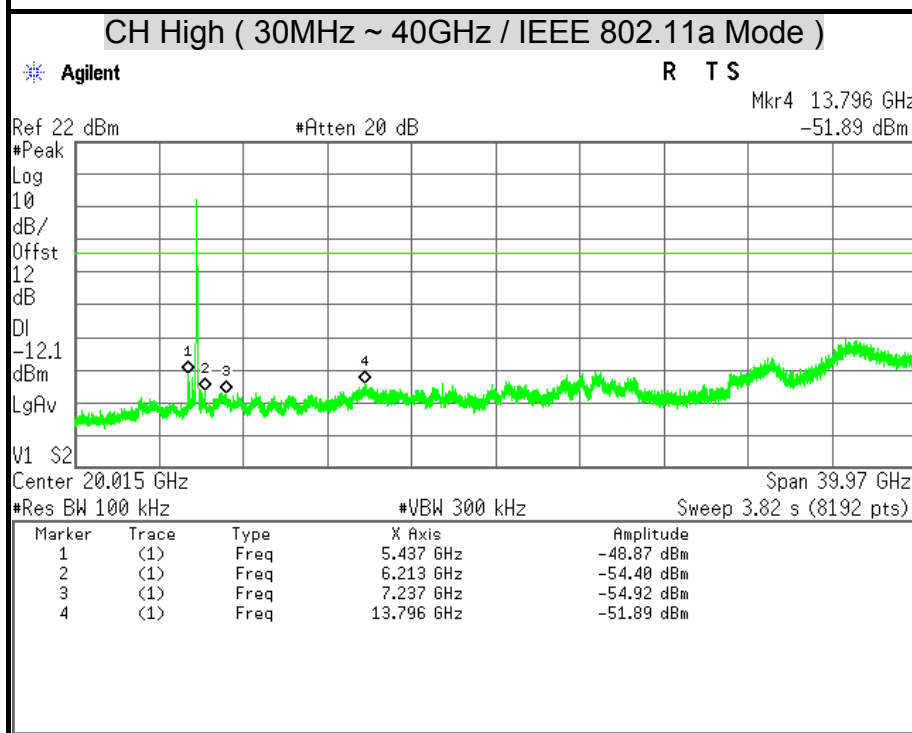
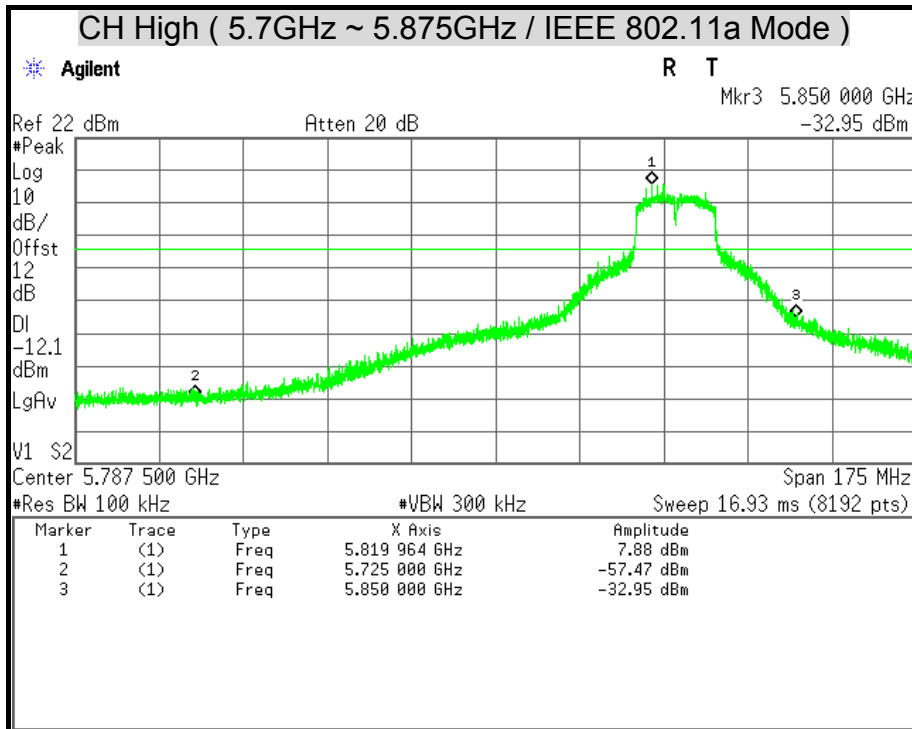

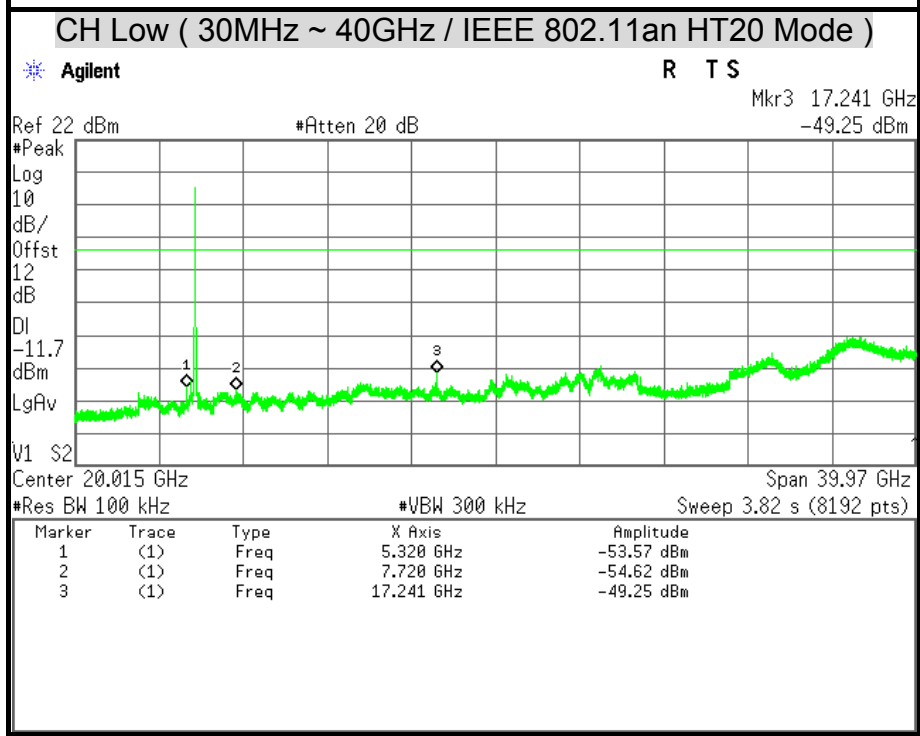
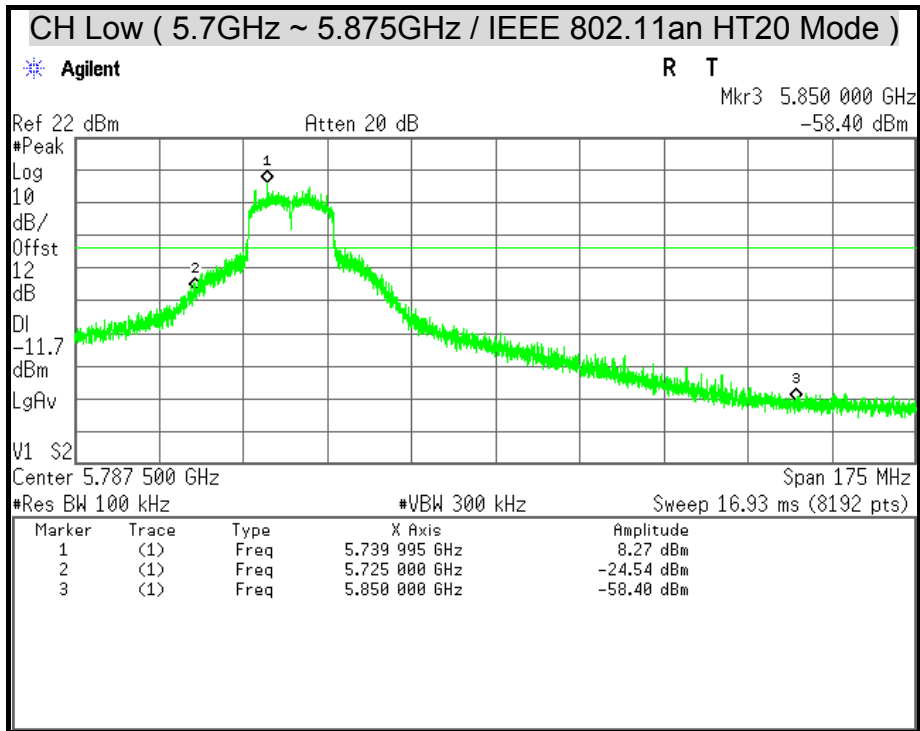

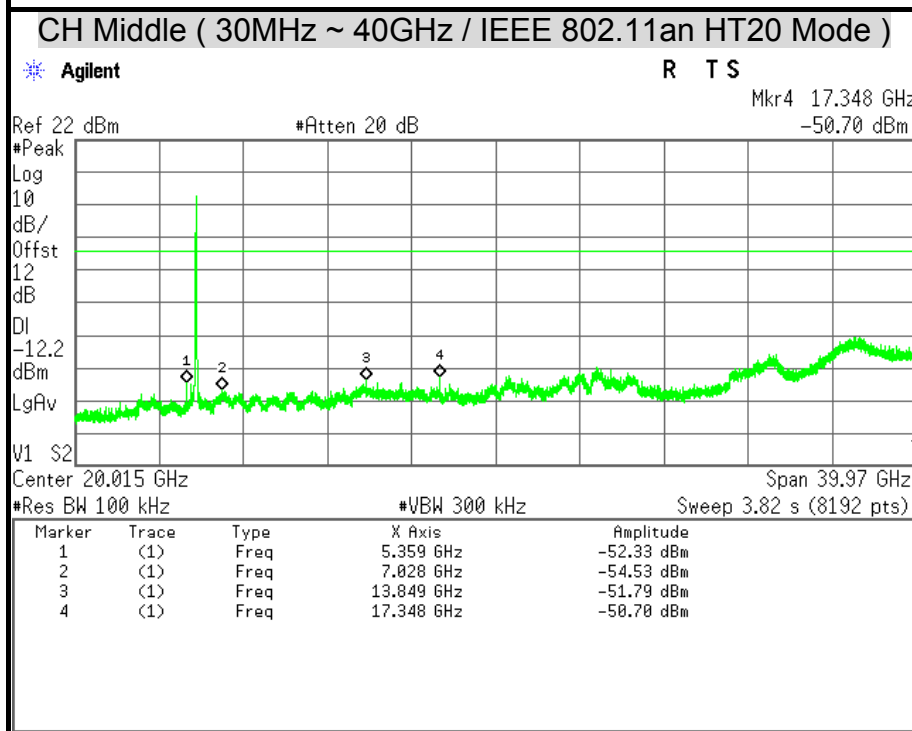
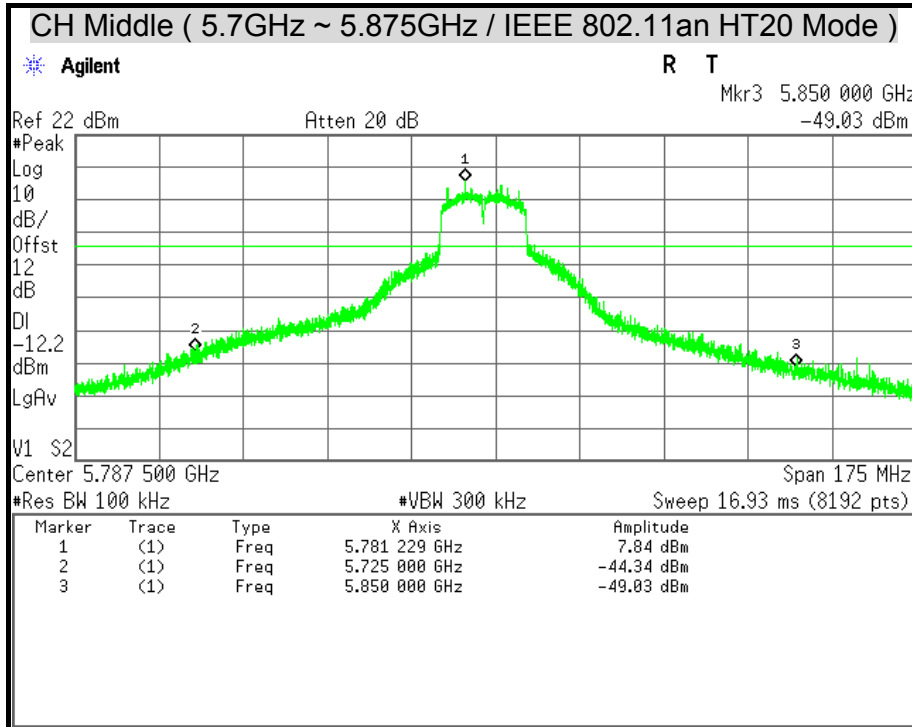

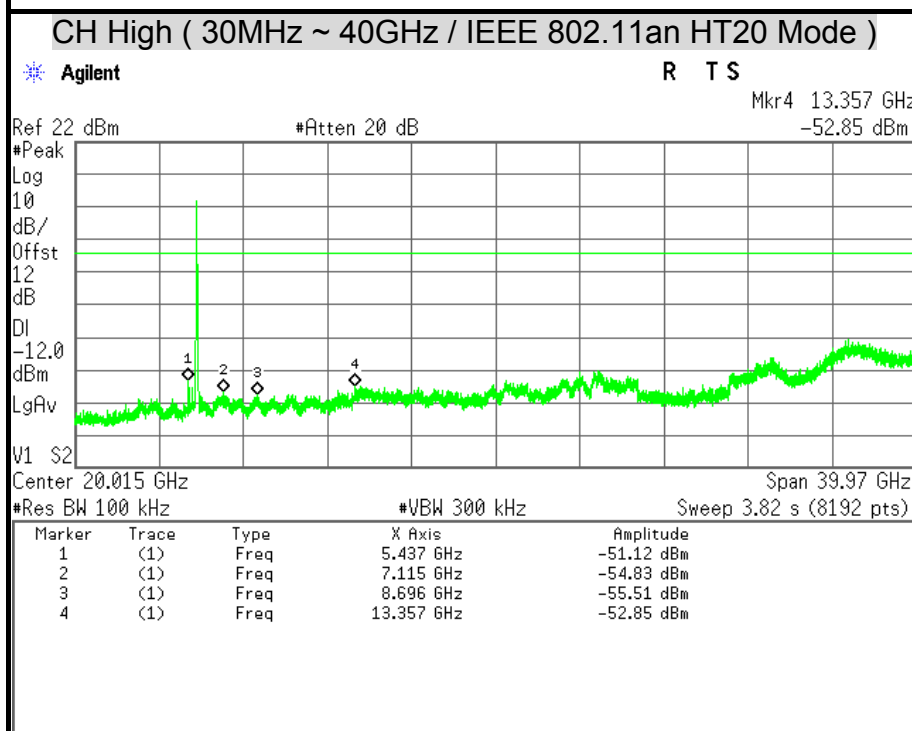
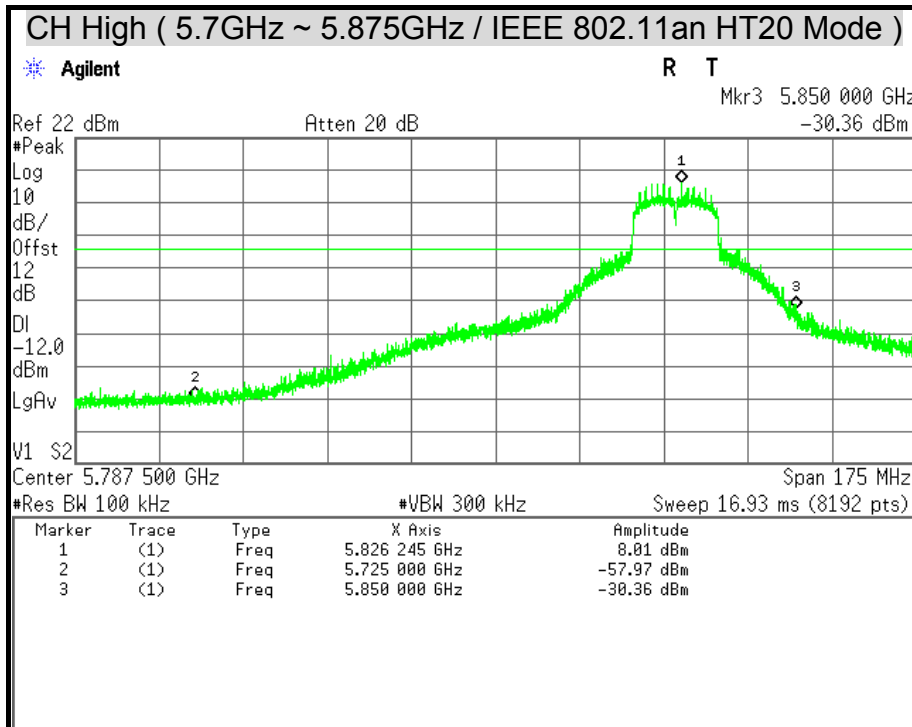

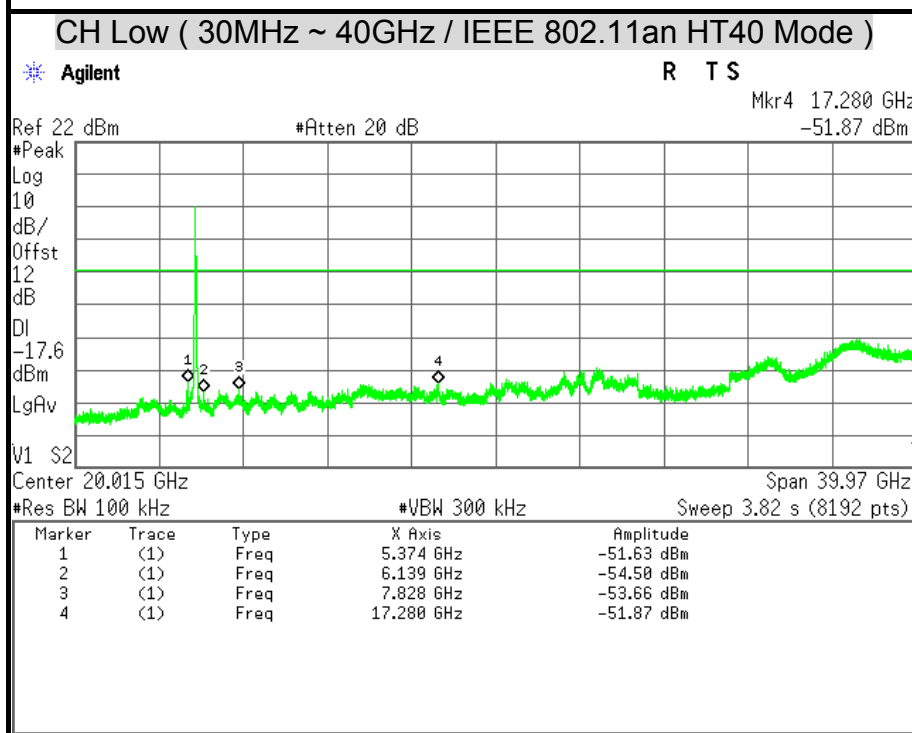
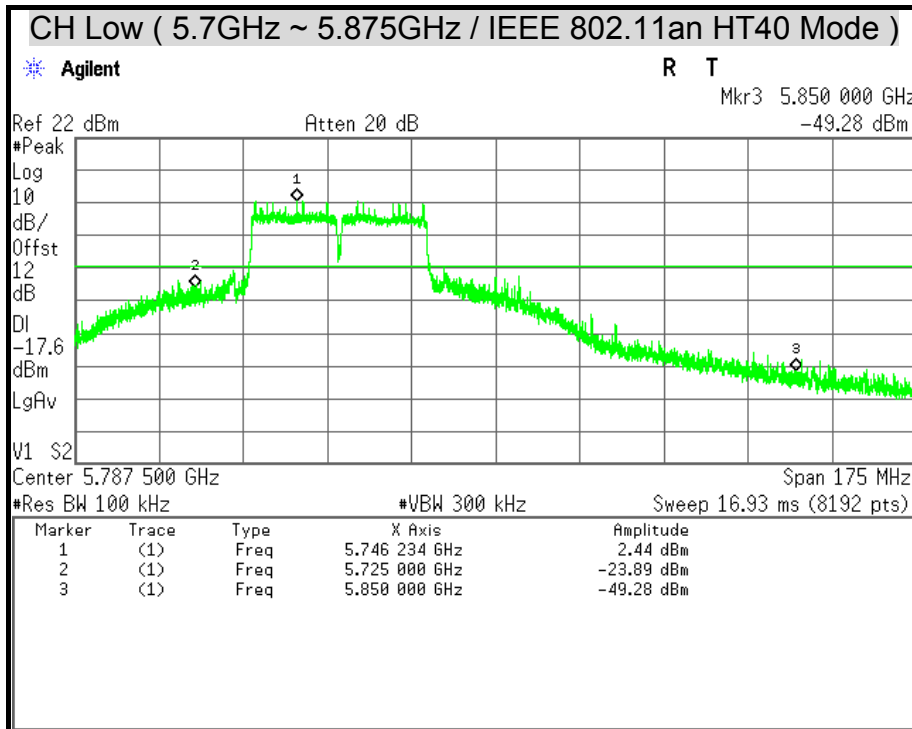

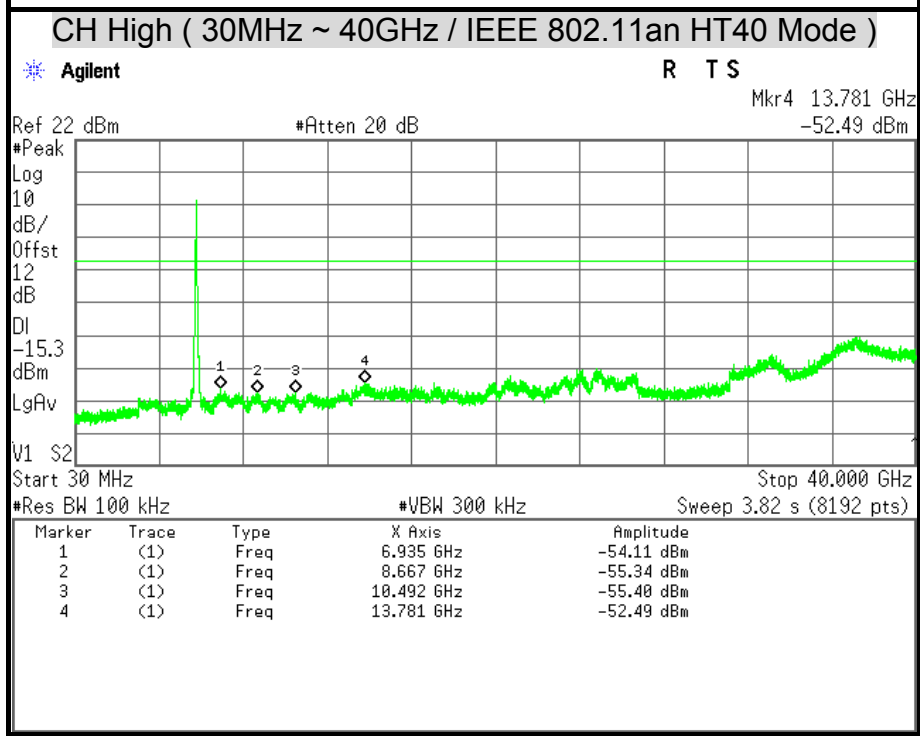
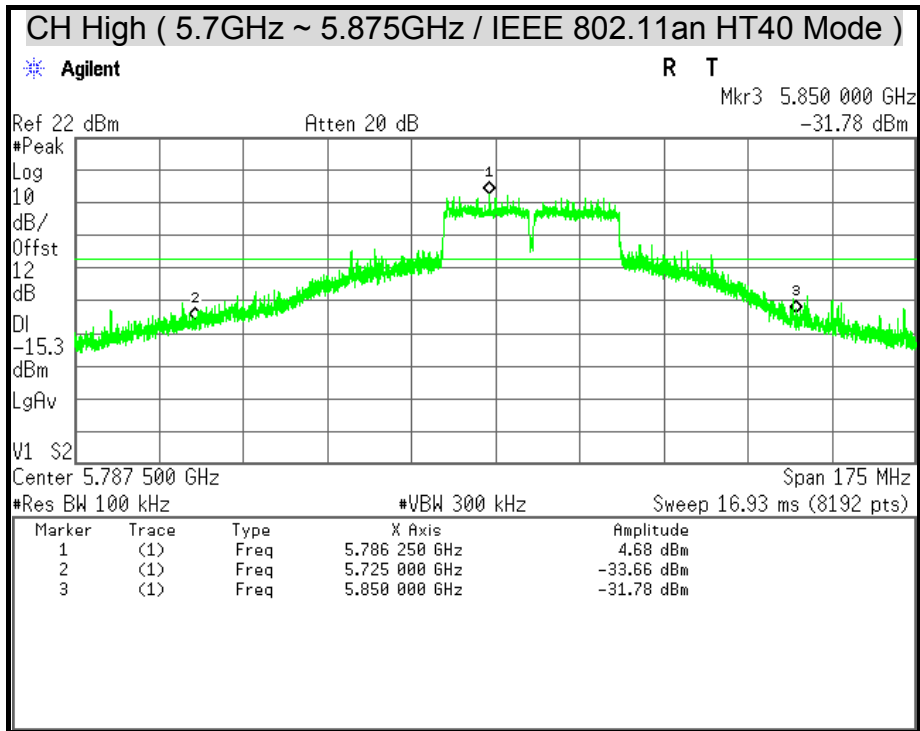

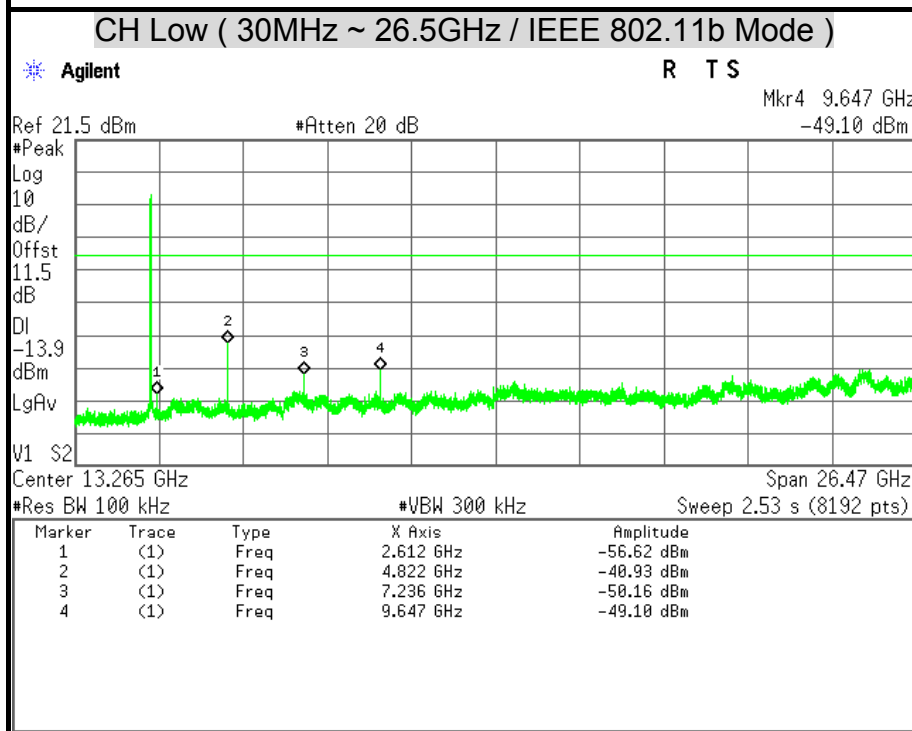
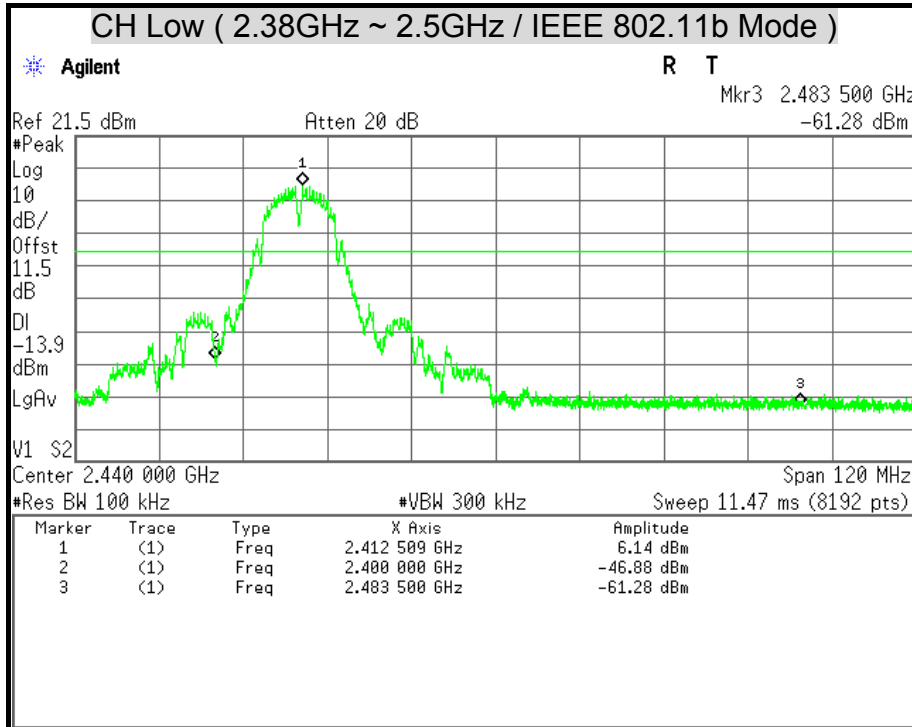

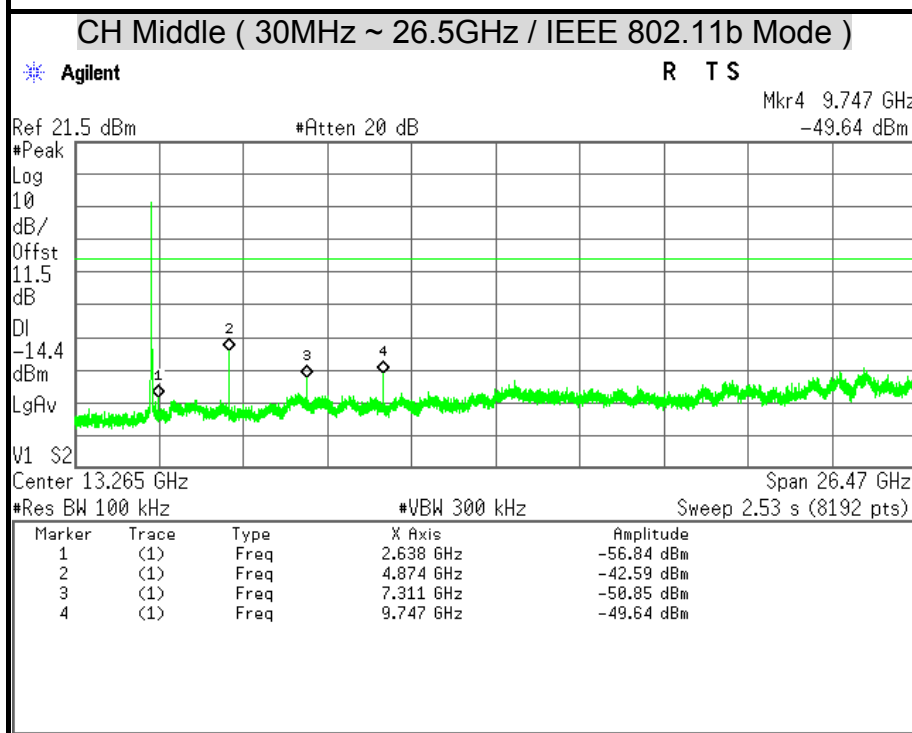
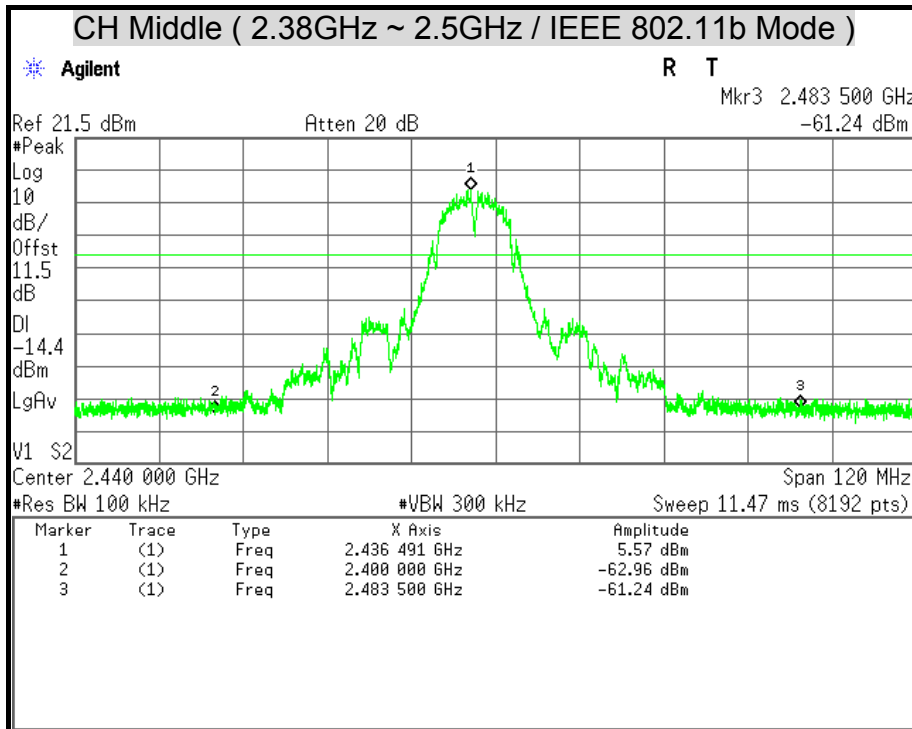

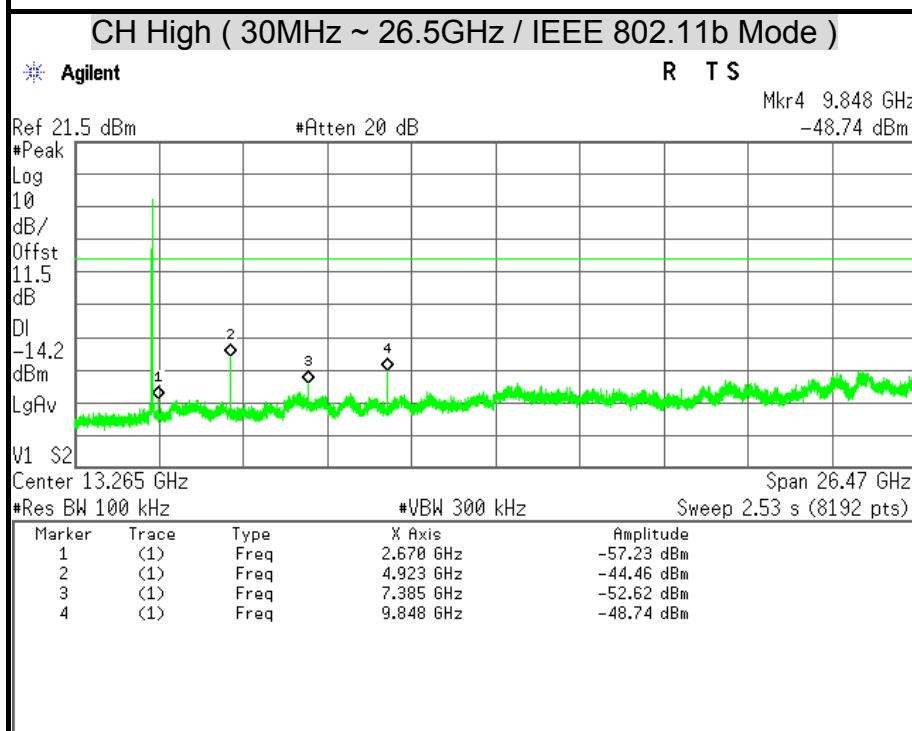
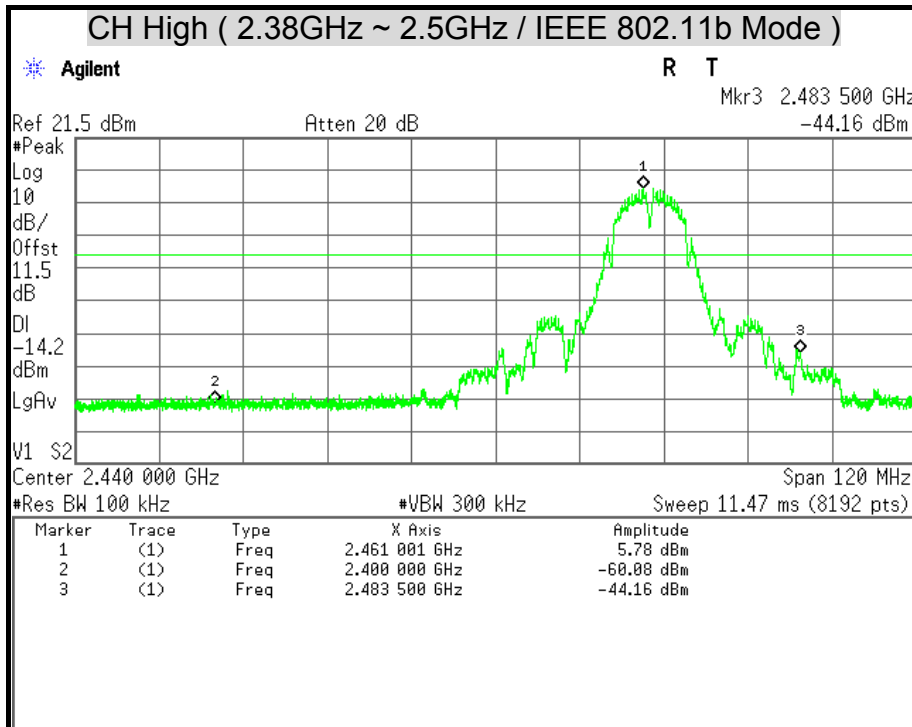

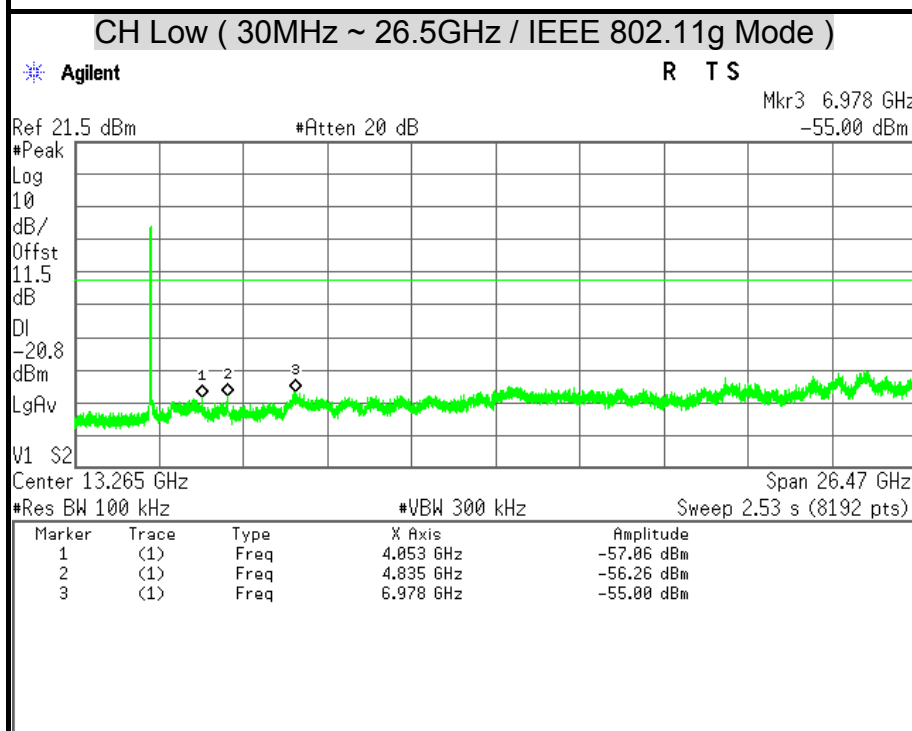
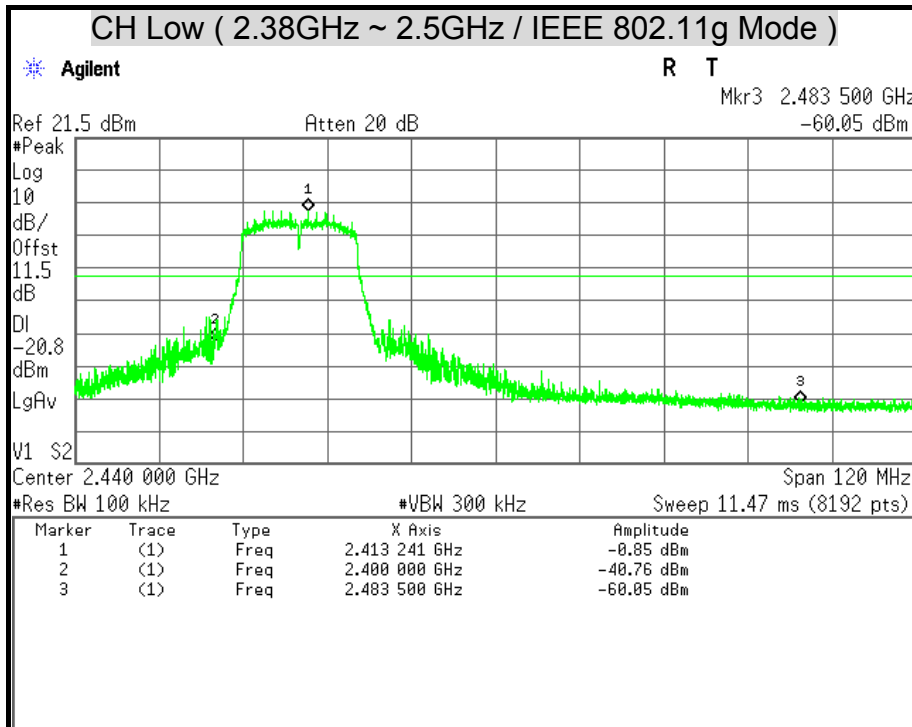

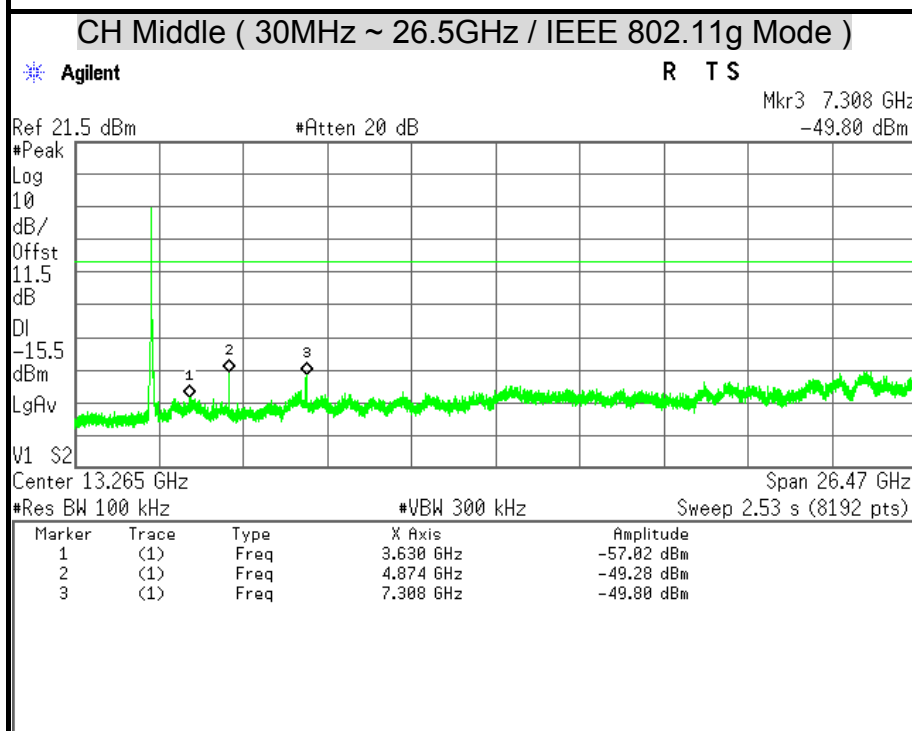
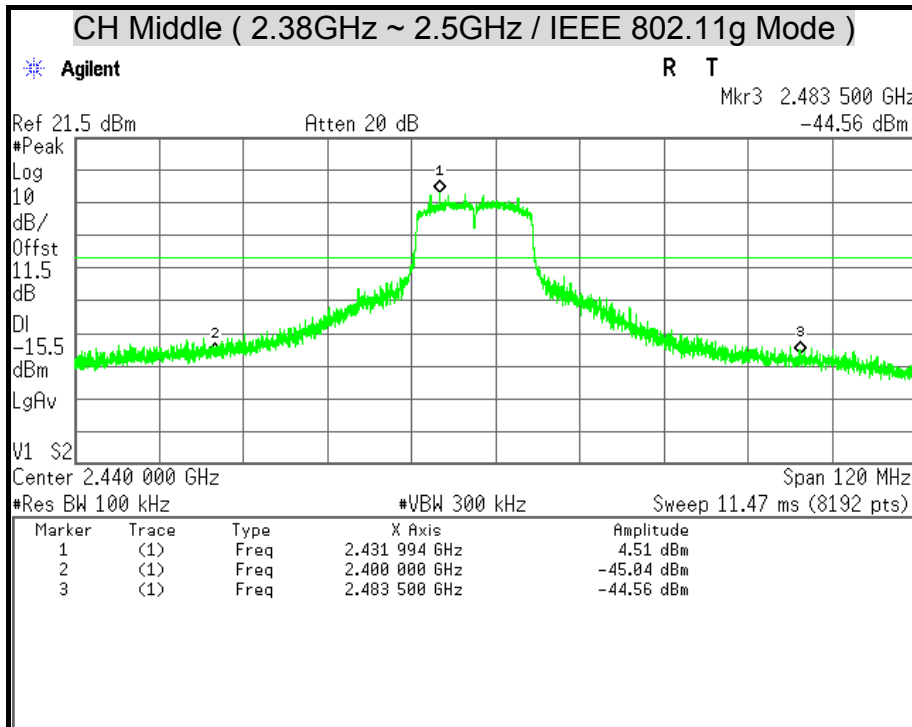

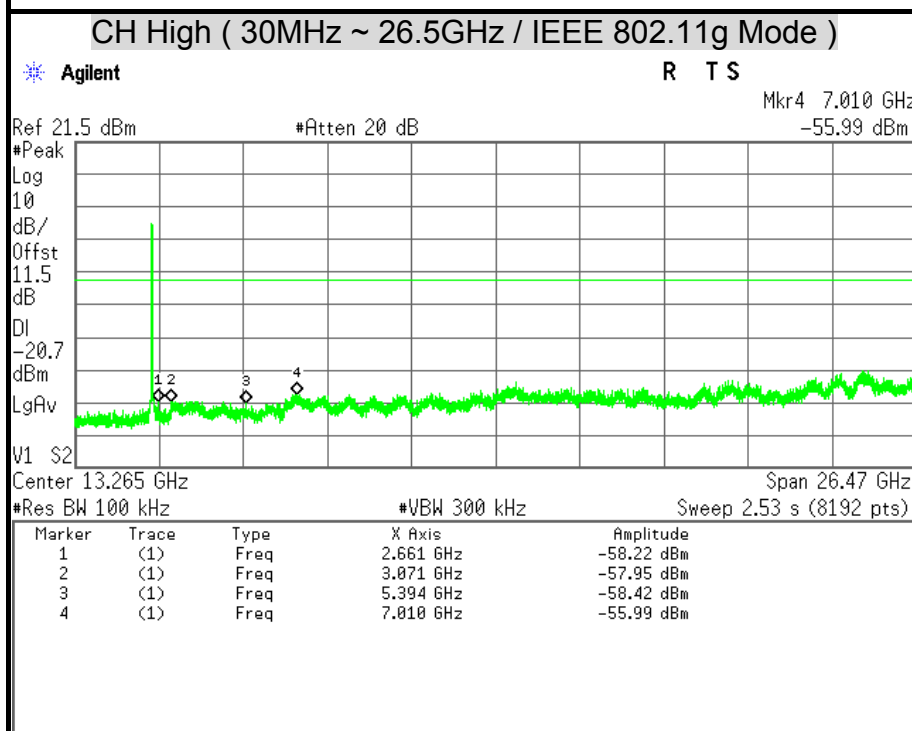
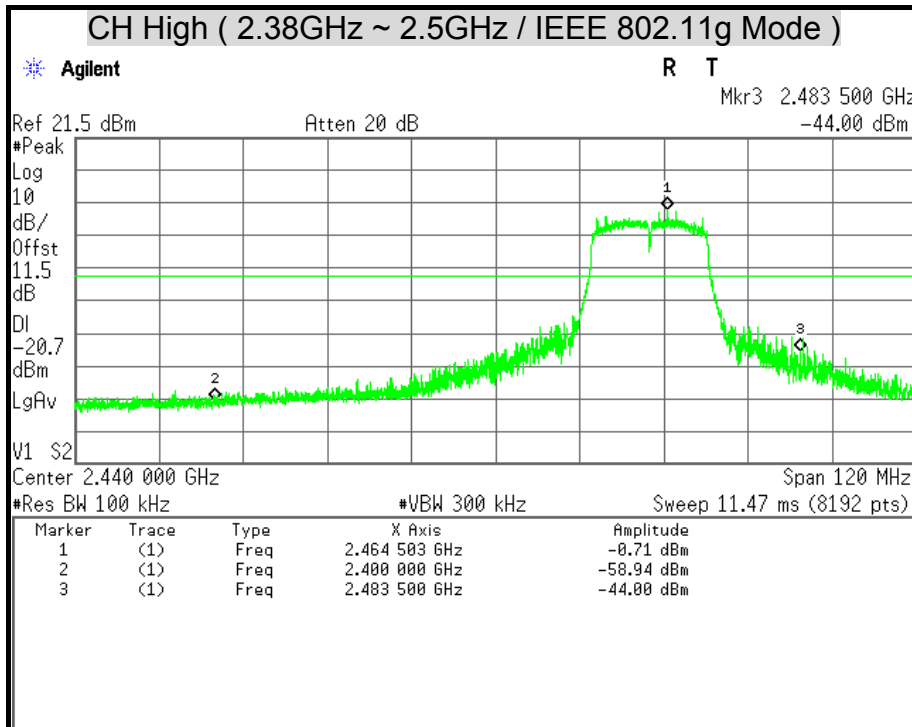

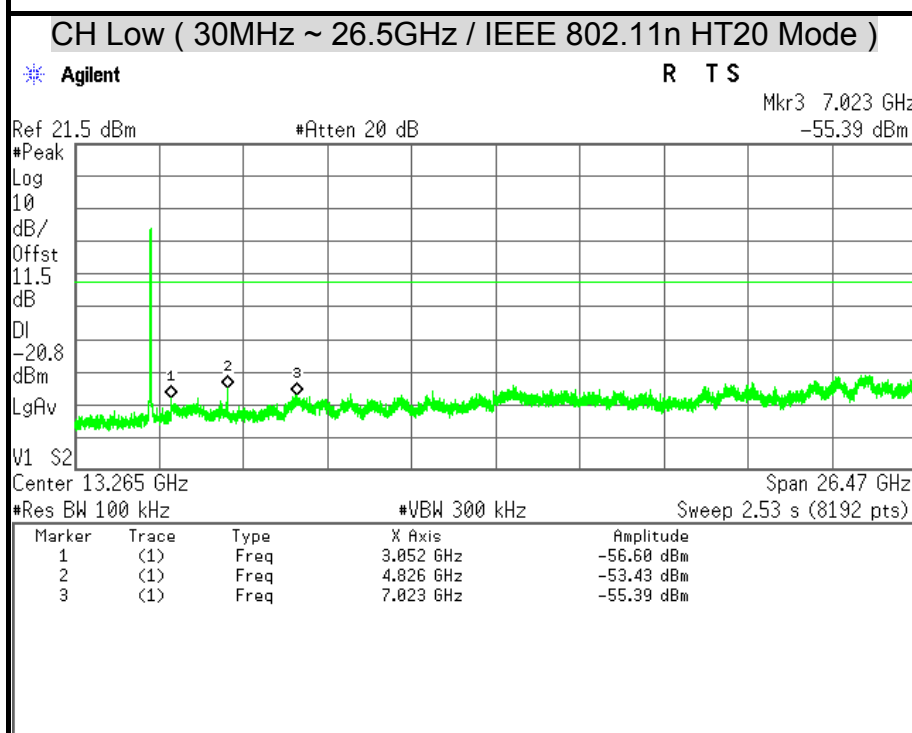
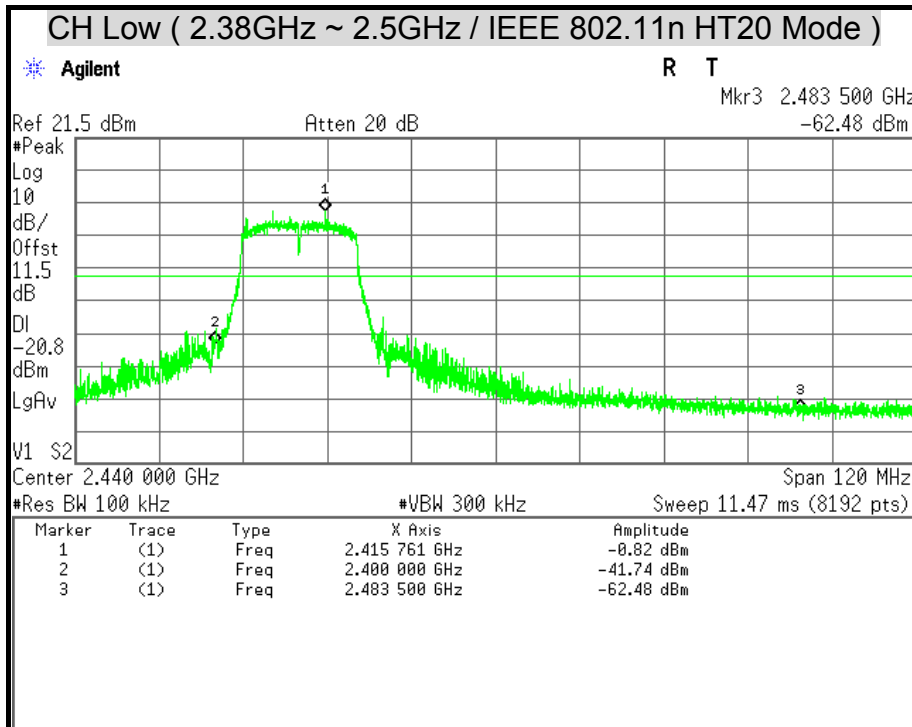

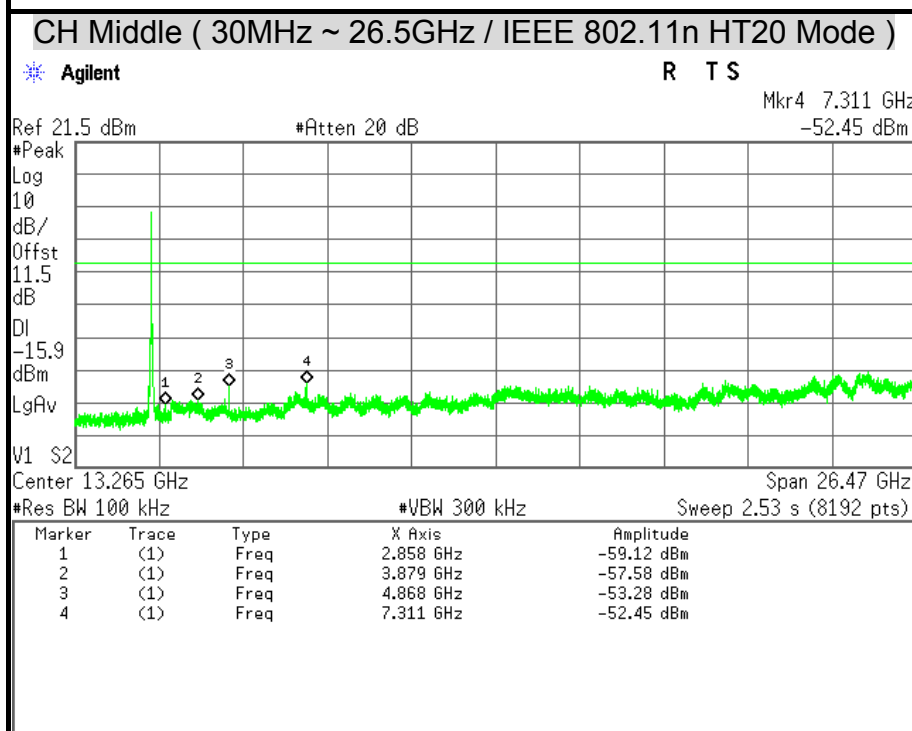
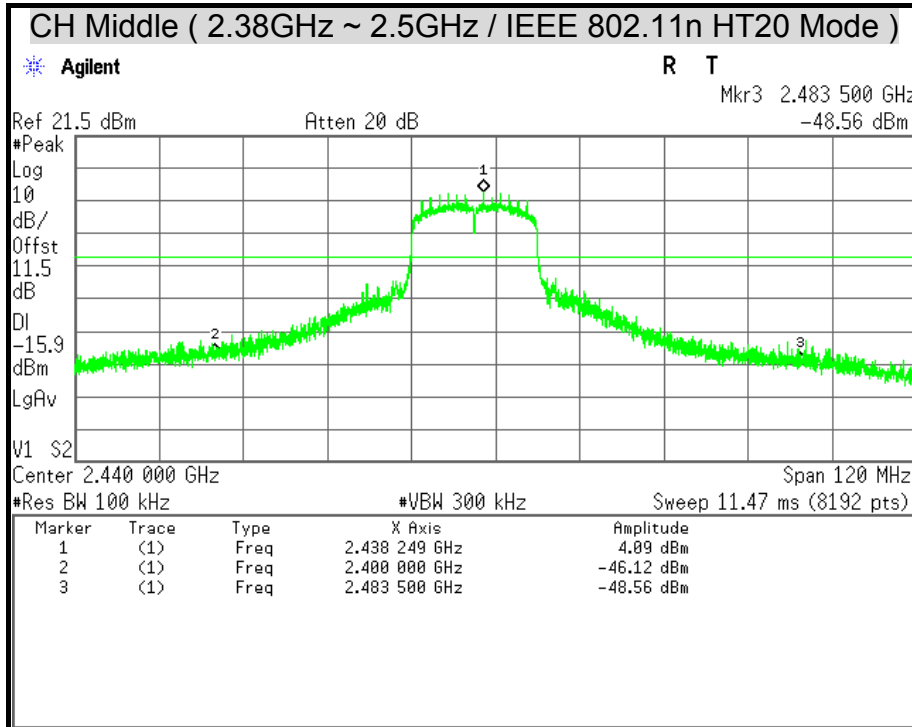

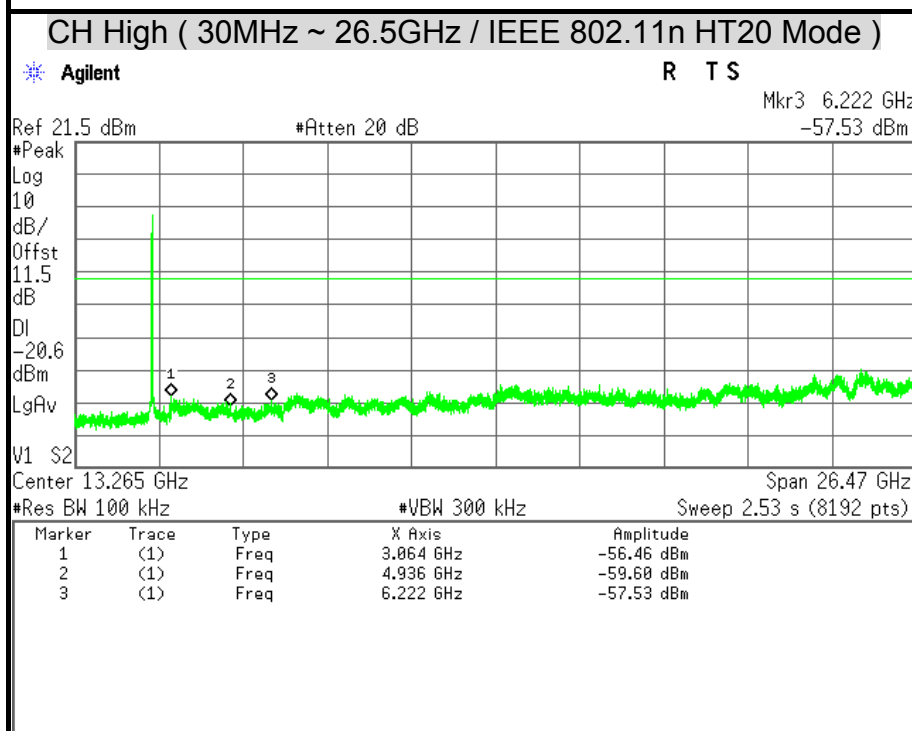
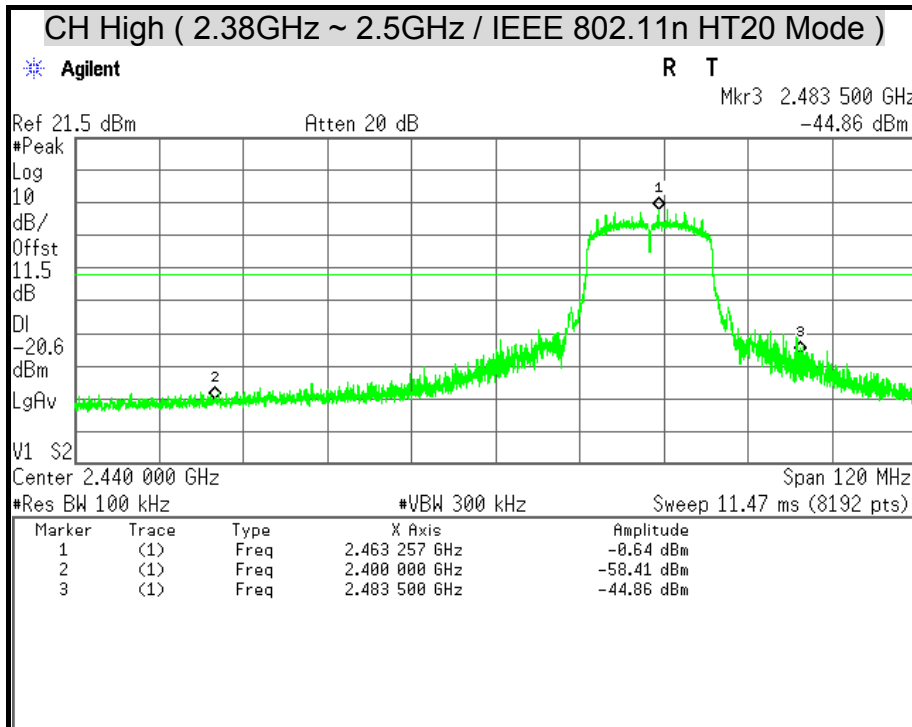

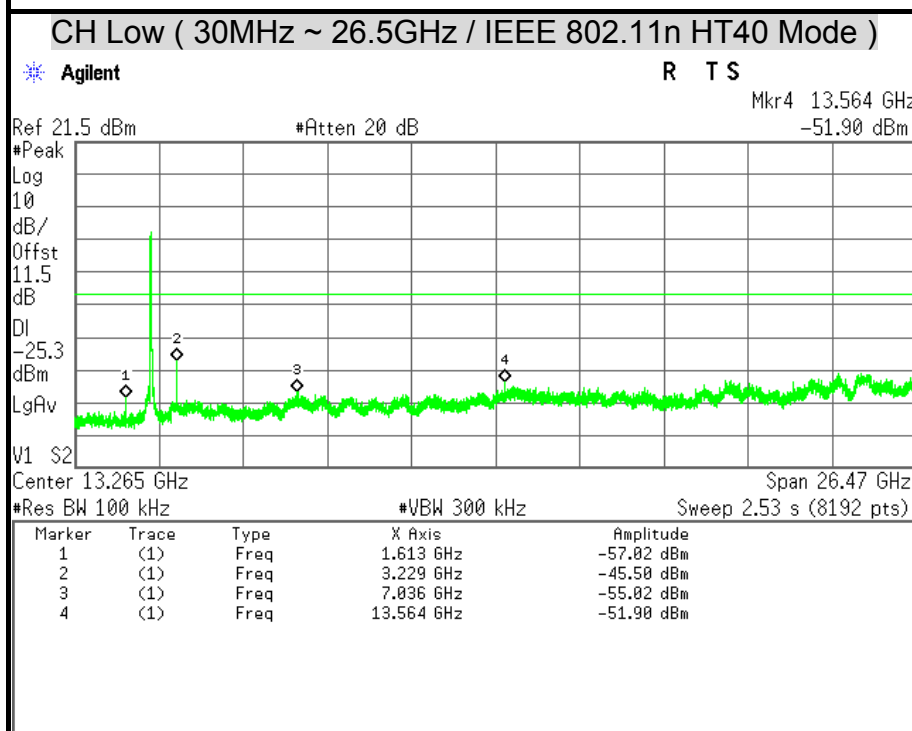
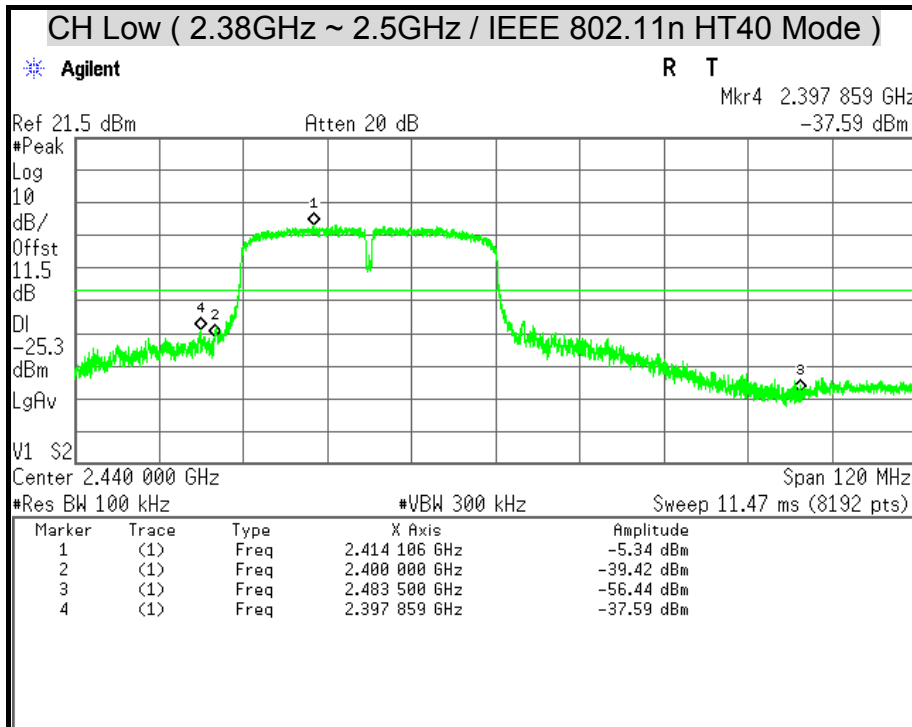

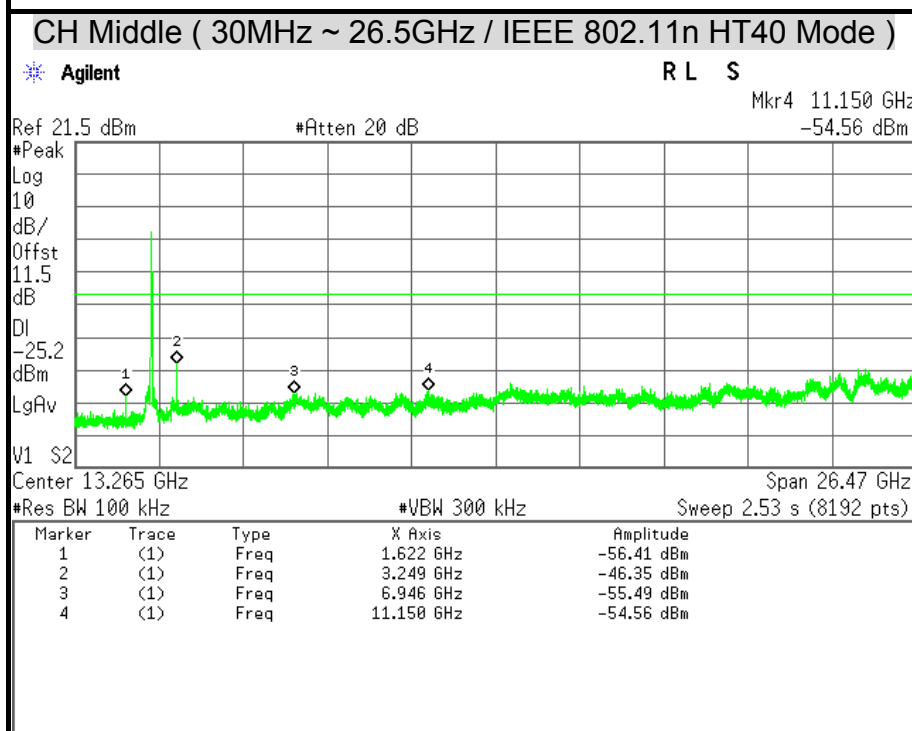
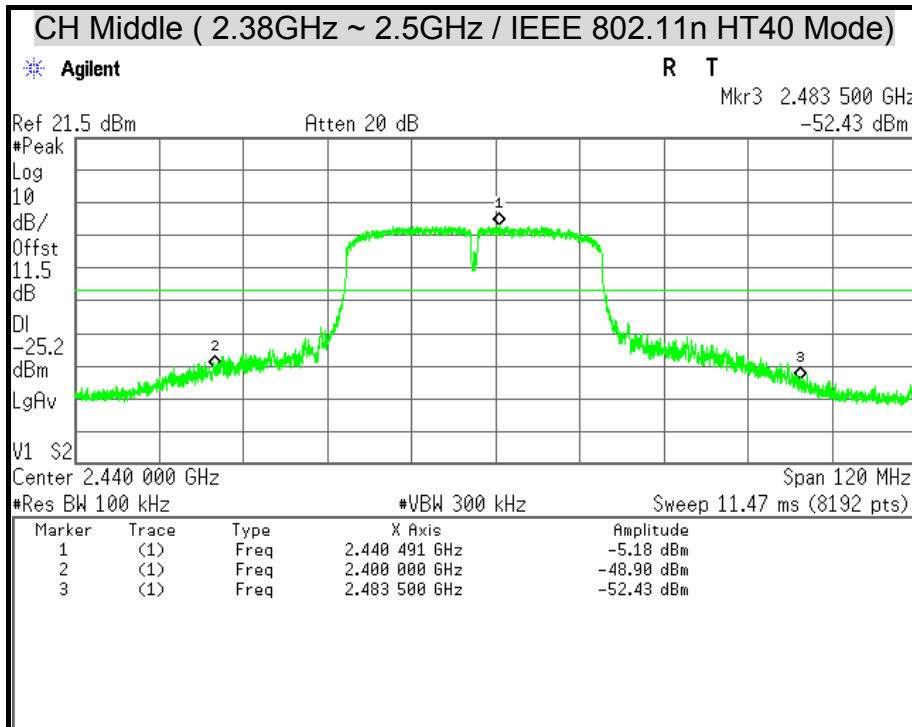

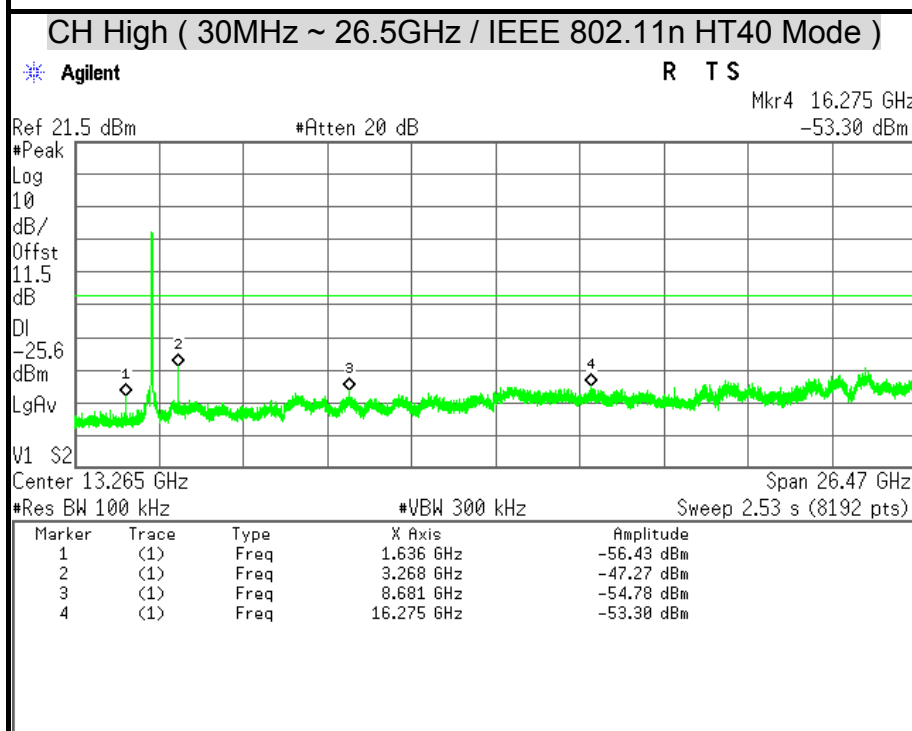
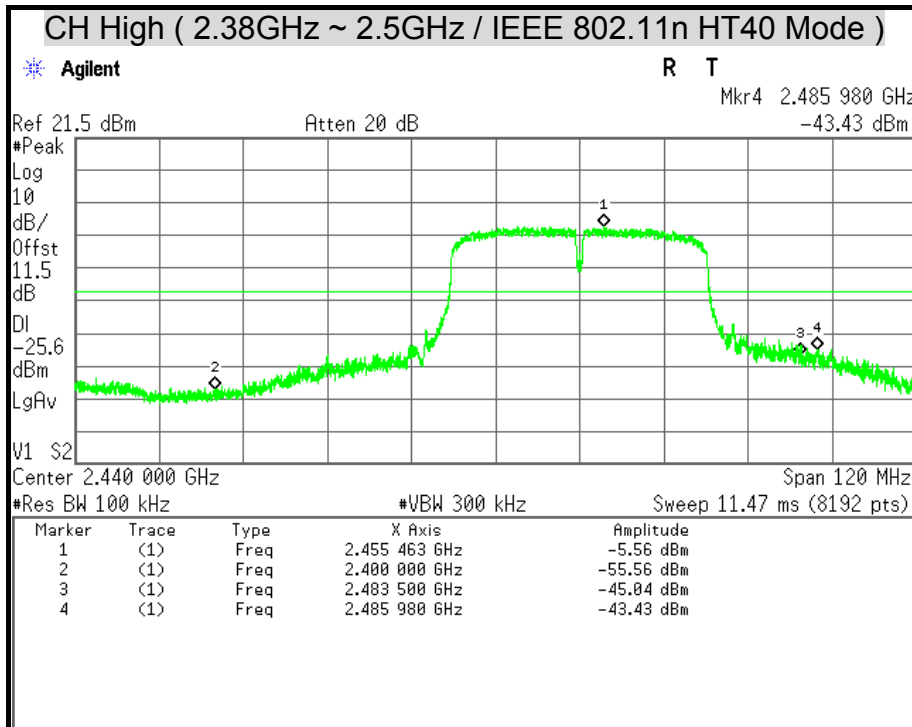

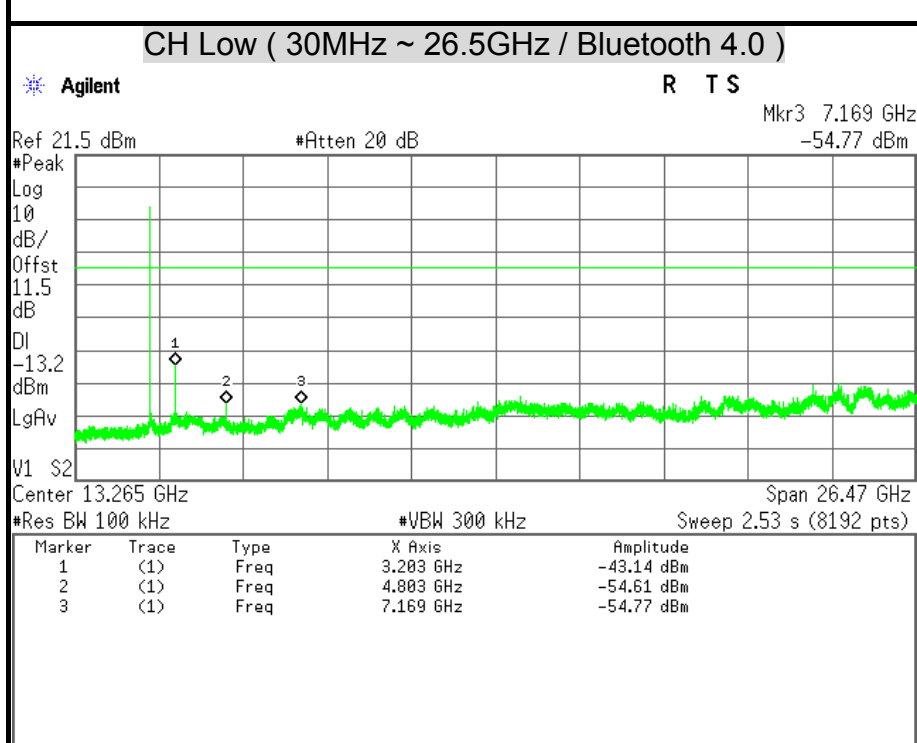
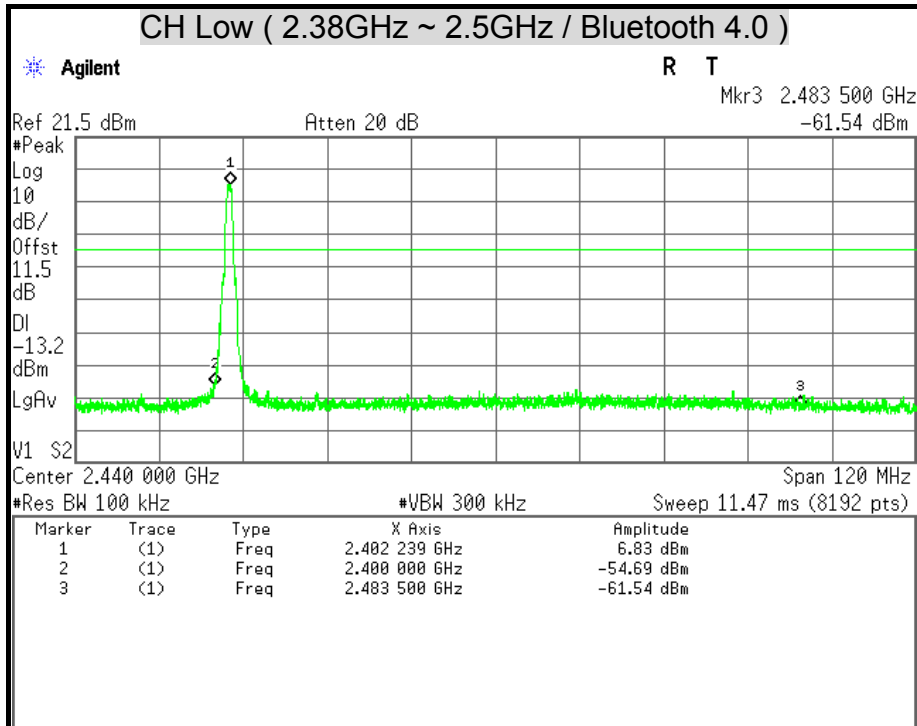

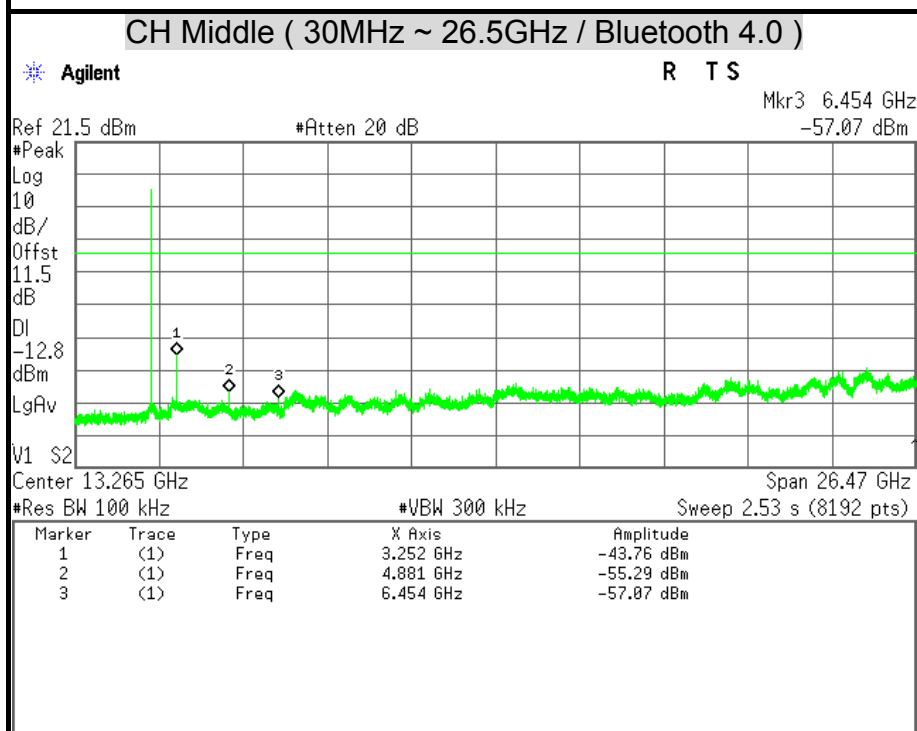
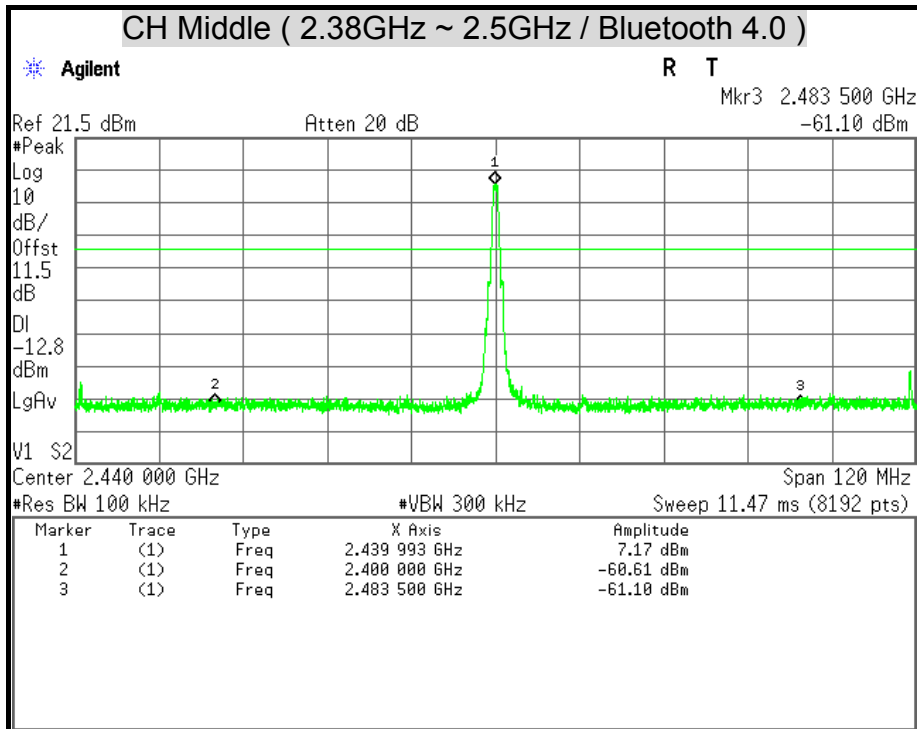

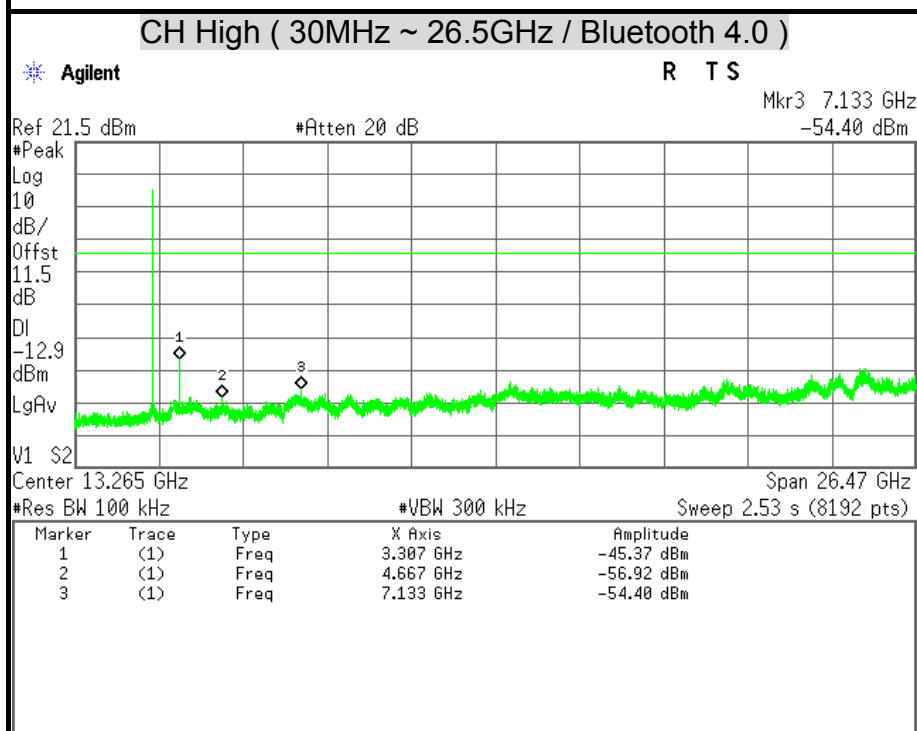
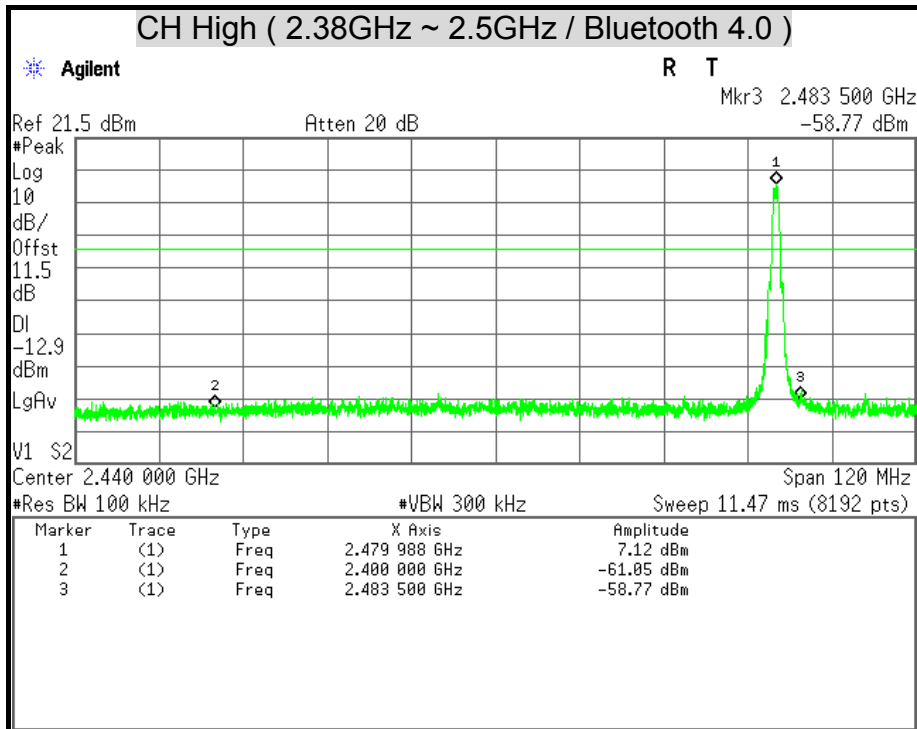



7.6 RADIATED EMISSION

LIMITS

(1) According to § 15.205 (a) Except as shown in paragraph (d) of this section, only spurious emissions are permitted in any of the frequency bands listed below:

MHz	MHz	MHz	GHz
0.090 - 0.110	16.42 - 16.423	399.9 - 410	4.5 - 5.15
¹ 0.495 - 0.505	16.69475 - 16.69525	608 - 614	5.35 - 5.46
2.1735 - 2.1905	16.80425 - 16.80475	960 - 1240	7.25 - 7.75
4.125 - 4.128	25.5 - 25.67	1300 - 1427	8.025 - 8.5
4.17725 - 4.17775	37.5 - 38.25	1435 - 1626.5	9.0 - 9.2
4.20725 - 4.20775	73 - 74.6	1645.5 - 1646.5	9.3 - 9.5
6.215 - 6.218	74.8 - 75.2	1660 - 1710	10.6 - 12.7
6.26775 - 6.26825	108 - 121.94	1718.8 - 1722.2	13.25 - 13.4
6.31175 - 6.31225	123 - 138	2200 - 2300	14.47 - 14.5
8.291 - 8.294	149.9 - 150.05	2310 - 2390	15.35 - 16.2
8.362 - 8.366	156.52475 - 156.52525	2483.5 - 2500	17.7 - 21.4
8.37625 - 8.38675	156.7 - 156.9	2655 - 2900	22.01 - 23.12
8.41425 - 8.41475	162.0125 - 167.17	3260 - 3267	23.6 - 24.0
12.29 - 12.293	167.72 - 173.2	3332 - 3339	31.2 - 31.8
12.51975 - 12.52025	240 - 285	3345.8 - 3338	36.43 - 36.5
12.57675 - 12.57725	322 - 335.4	3600 - 4400	(²)
13.36 - 13.41			

Remark:

- 1. ¹ Until February 1, 1999, this restricted band shall be 0.490-0.510 MHz.
- 2. ² Above 38.6

(2) According to § 15.205 (b) Except as provided in paragraphs (d) and (e), the field strength of emissions appearing within these frequency bands shall not exceed the limits shown in Section 15.209. At frequencies equal to or less than 1000 MHz, compliance with the limits in Section 15.209 shall be demonstrated using measurement instrumentation employing a CISPR quasi-peak detector. Above 1000 MHz, compliance with the emission limits in Section 15.209 shall be demonstrated based on the average value of the measured emissions. The provisions in Section 15.35 apply to these measurements.



(3) According to § 15.209 (a) Except as provided elsewhere in this Subpart, the emissions from an intentional radiator shall not exceed the field strength levels specified in the following table :

Frequency (MHz)	Field Strength (microvolts/meter)	Measurement Distance (meters)
0.009 – 0.490	2400/F(KHz)	300
0.490 – 1.705	24000/F(KHz)	30
1.705 – 30.0	30	30
30 - 88	100 **	3
88 - 216	150 **	3
216 - 960	200 **	3
Above 960	500	3

Remark: **Except as provided in paragraph (g), fundamental emissions from intentional radiators operating under this Section shall not be located in the frequency bands 54-72 MHz, 76-88 MHz, 174-216 MHz or 470-806 MHz. However, operation within these frequency bands is permitted under other sections of this Part, e.g., Sections 15.231 and 15.241.

(4) According to § 15.209 (b) In the emission table above, the tighter limit applies at the band edges.

TEST EQUIPMENT

Radiated Emission / 966Chamber_A

Name of Equipment	Manufacturer	Model	Serial Number	Calibration Due
Spectrum Analyzer	Agilent	E4446A	MY43360132	06/10/2014
EMI Receiver	ROHDE & SCHWARZ	ESCI	100221	04/29/2014
Bi-log Antenna	SCHWARZBECK	VULB 9168	9168-249	09/12/2014
Broad-Band Horn Antenna	SCHWARZBECK	BBHA 9120 D	9120D-778	09/12/2014
Pre-Amplifier	Agilent	8449B	3008A01471	07/16/2014
Pre-Amplifier	HP	8447F	2944A03748	07/16/2014
Band Reject Notch Filter	Micro-Tronics	BRM05702-01	009	N.C.R

Remark: 1. Each piece of equipment is scheduled for calibration once a year.
2. N.C.R = No Calibration Request.



Radiated Emission / 966Chamber_B

Name of Equipment	Manufacturer	Model	Serial Number	Calibration Due
Spectrum Analyzer	Agilent	E4446A	MY46180323	04/15/2014
EMI Test Receiver	ROHDE & SCHWARZ	ESCI	101387	10/09/2014
Broad-Band Horn Antenna	SCHWARZBECK	BBHA 9120 D	9120D-778	09/12/2014
Bi-log Antenna	SCHWARZBECK	VULB 9168	9168-250	09/12/2014
Double-Ridged Waveguide Horn	ETS-LINDGREN	3117	00078733	12/05/2014
Horn Antenna	COM-POWER	AH-840	03077	12/18/2014
Pre-Amplifier	Agilent	8447D	2944A10052	07/16/2014
Pre-Amplifier	Agilent	8449B	3008A01916	07/16/2014
LOOP Antenna	EMCO	6502	8905-2356	08/20/2014
Notch Filters Band Reject	Micro-Tronics	BRM05702-01	026	N.C.R
Band Reject Filter	Micro-Tronics	BRC50705-01	007	N.C.R.

Remark: 1. Each piece of equipment is scheduled for calibration once a year.
 2. N.C.R = No Calibration Request.

TEST SETUP

The diagram below shows the test setup that is utilized to make the measurements for emission below 1GHz.

9kHz ~ 30MHz

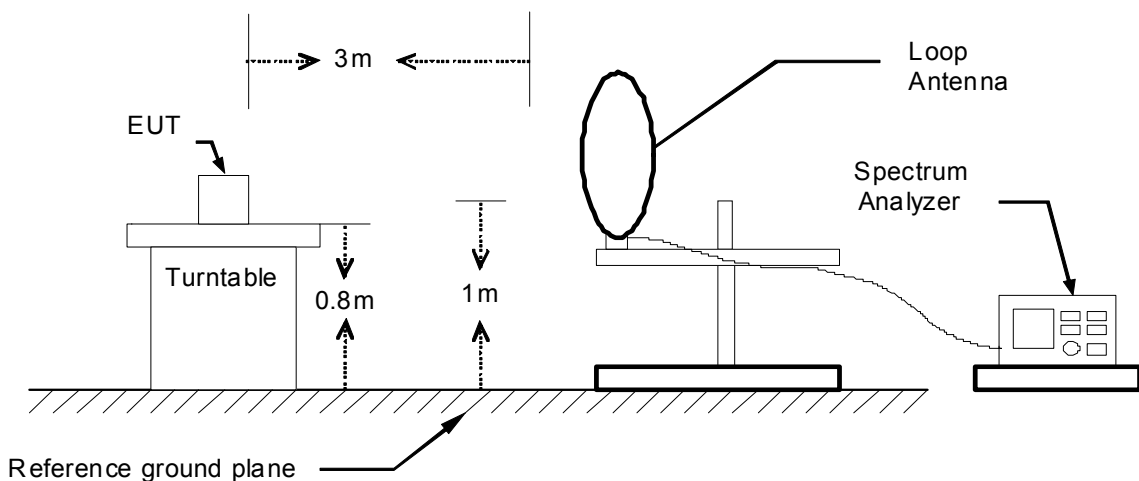



30MHz ~ 1GHz

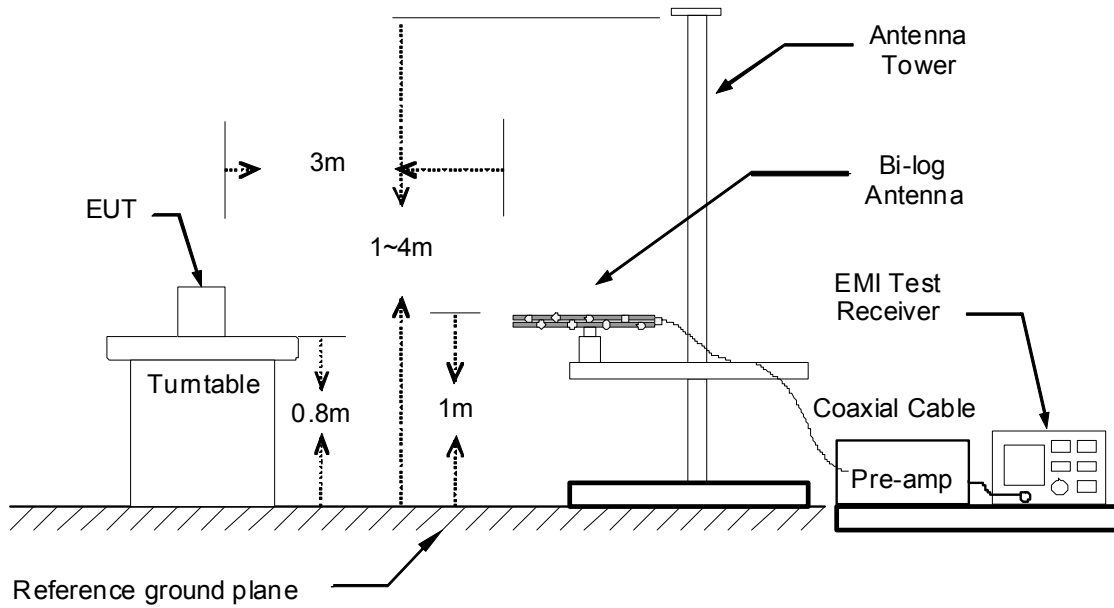

The diagram below shows the test setup that is utilized to make the measurements for emission above 1GHz.

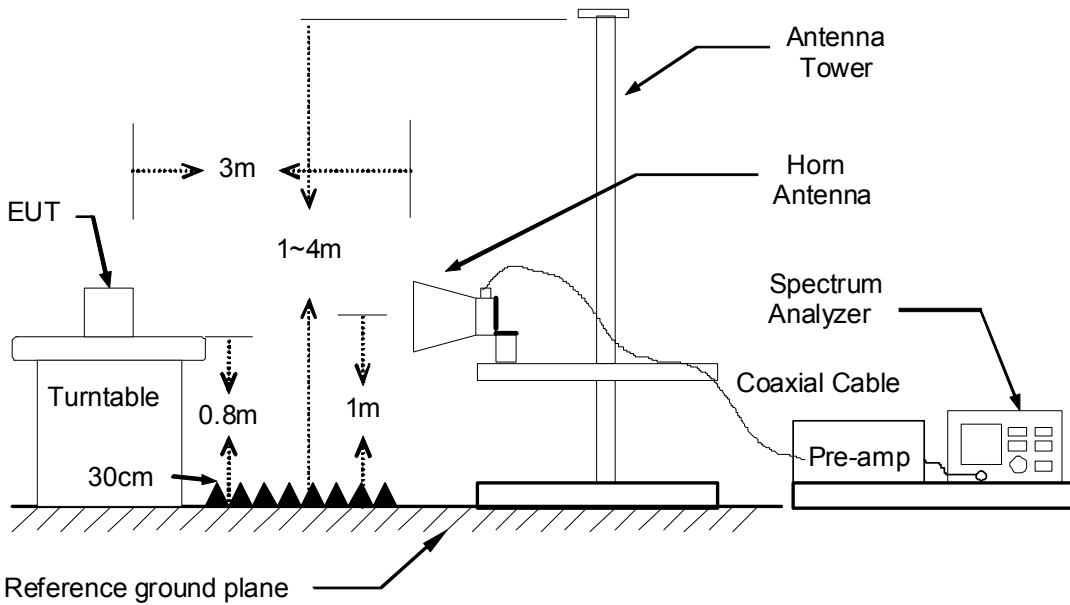



TEST PROCEDURE

1. The EUT was placed on the top of a rotating table 0.8 meters above the ground. The table was rotated 360 degrees to determine the position of the highest radiation.
2. While measuring the radiated emission below 1GHz, the EUT was set 3 meters away from the interference-receiving antenna, which was mounted on the top of a variable-height antenna tower. While measuring the radiated emission above 1GHz, the EUT was set 3 meters away from the interference-receiving antenna.
3. The antenna is a broadband antenna, and its height is varied from one meter to four meters above the ground to determine the maximum value of the field strength. Both horizontal and vertical polarization of the antenna are set to make the measurement.
4. For each suspected emission, the EUT was arranged to its worst case and then the antenna was tuned to heights from 1 meter to 4 meters and the table was turned from 0 degrees to 360 degrees to find the maximum reading.
5. The test-receiver system was set to Peak Detect Function and Specified Bandwidth with Maximum Hold Mode.
6. If the emission level of the EUT in peak mode was 10 dB lower than the limit specified, then testing could be stopped and the peak values of the EUT would be reported. Otherwise the emissions that did not have 10 dB margin would be re-tested one by one using peak, quasi-peak or average method as specified and then reported in a data sheet.

Remark :

1. *The resolution bandwidth and video bandwidth of test receiver/spectrum analyzer is 120 KHz for Peak detection (PK) and Quasi-peak detection (QP) at frequency below 1GHz.*
2. *The resolution bandwidth and video bandwidth of test receiver/spectrum analyzer is 1 MHz for Peak detection and frequency above 1GHz.*
3. *The resolution bandwidth of test receiver/spectrum analyzer is 1 MHz and the video bandwidth is 10 Hz for Average detection (AV) at frequency above 1GHz.*



TEST RESULTS

Below 1 GHz (9kHz ~ 30MHz)

No emission found between lowest internal used/generated frequency to 30MHz.

Below 1 GHz (30MHz ~ 1GHz)

Product Name	DreamTab HD8	Test By	Alan Wu
Test Model	DMTAB-IN08A	Test Date	2014/03/25
Test Mode	Normal Operating + Link Notebook PC Write	Temp. & Humidity	24 °C, 50%

966 Chamber_A at 3Meter / Horizontal						
Frequency (MHz)	Reading (dBµV)	Correction Factor (dB/m)	Result (dBµV/m)	Limit (dBµV/m)	Margin (dB)	Remark
66.86	36.24	-11.66	24.58	40.00	-15.42	Peak
159.98	38.26	-9.89	28.37	43.50	-15.13	Peak
239.52	48.02	-11.16	36.86	46.00	-9.14	Peak
421.88	42.00	-5.67	36.34	46.00	-9.66	Peak
600.36	41.30	-1.83	39.47	46.00	-6.53	Peak
961.20	31.93	4.34	36.27	54.00	-17.73	Peak
1000.00	32.56	4.76	37.32	74.00	-36.68	Peak

966 Chamber_A at 3Meter / Vertical						
Frequency (MHz)	Reading (dBµV)	Correction Factor (dB/m)	Result (dBµV/m)	Limit (dBµV/m)	Margin (dB)	Remark
158.04	39.43	-9.92	29.51	43.50	-13.99	Peak
239.52	48.98	-11.16	37.81	46.00	-8.19	Peak
419.94	43.10	-5.73	37.37	46.00	-8.63	Peak
482.02	43.51	-4.26	39.25	46.00	-6.75	Peak
600.36	45.40	-1.83	43.57	46.00	-2.43	Peak
840.92	33.99	2.08	36.07	46.00	-9.93	Peak
901.06	32.00	3.43	35.43	46.00	-10.57	Peak
961.20	29.84	4.34	34.18	54.00	-19.82	Peak

Remark:

1. Quasi-peak test would be performed if the peak result were greater than the quasi-peak limit.
2. Data of measurement within this frequency range shown " --- " in the table above means the reading of emissions are attenuated more than 20dB below the permissible limits or the field strength is too small to be measured.
3. Correction Factor (dB/m) = Antenna Factor (dB/m) + Cable Loss (dB) – PreAmp.Gain (dB)
4. Result (dBuV/m) = Reading (dBuV) + Correction Factor (dB/m)
5. Margin (dB) = Remark result (dBuV/m) - Quasi-peak limit (dBuV/m).



Above 1 GHz

Product Name	DreamTab HD8	Test By	Rueyyan Lin
Test Model	DMTAB-IN08A	Test Date	2014/03/25
Test Mode	IEEE 802.11a TX / CH Low	Temp. & Humidity	25°C, 49%

966 Chamber_B at 3Meter / Horizontal									
Frequency (MHz)	Reading-PK (dBuV)	Reading-AV (dBuV)	Correction Factor (dB/m)	Result-PK (dBuV/m)	Result-AV (dBuV/m)	Limit-PK (dBuV/m)	Limit-AV (dBuV/m)	Margin (dB)	Remark
1060.00	54.70	---	-4.34	50.36	---	74.00	54.00	-3.64	Peak
1255.00	54.06	---	-3.88	50.18	---	74.00	54.00	-3.82	Peak
1400.00	53.87	---	-3.54	50.33	---	74.00	54.00	-3.67	Peak
1600.00	53.90	---	-2.20	51.71	---	74.00	54.00	-2.29	Peak
6156.00	37.05	---	11.53	48.58	---	74.00	54.00	-5.42	Peak
6744.00	38.22	---	12.40	50.62	---	74.00	54.00	-3.38	Peak
7656.00	37.29	---	13.78	51.07	---	74.00	54.00	-2.93	Peak

966 Chamber_B at 3Meter / Vertical									
Frequency (MHz)	Reading-PK (dBuV)	Reading-AV (dBuV)	Correction Factor (dB/m)	Result-PK (dBuV/m)	Result-AV (dBuV/m)	Limit-PK (dBuV/m)	Limit-AV (dBuV/m)	Margin (dB)	Remark
1090.00	55.12	---	-4.27	50.86	---	74.00	54.00	-3.14	Peak
1355.00	53.86	---	-3.64	50.21	---	74.00	54.00	-3.79	Peak
1460.00	54.03	---	-3.39	50.64	---	74.00	54.00	-3.36	Peak
1600.00	52.58	---	-2.20	50.38	---	74.00	54.00	-3.62	Peak
6216.00	37.45	---	11.69	49.14	---	74.00	54.00	-4.86	Peak
6768.00	37.17	---	12.39	49.57	---	74.00	54.00	-4.43	Peak
7752.00	37.75	---	13.72	51.48	---	74.00	54.00	-2.52	Peak

Remark:

1. Measuring frequencies from 1 GHz to the 10th harmonic of highest fundamental frequency.
2. Average test would be performed if the peak result were greater than the average limit.
3. Data of measurement within this frequency range shown " --- " in the table above means the reading of emissions are attenuated more than 20dB below the permissible limits or the field strength is too small to be measured.
4. Measurements above show only up to 6 maximum emissions noted, or would be lesser, with " N/A " remark, if no specific emissions from the EUT are recorded (ie: margin>20dB from the applicable limit) and considered that's already beyond the background noise floor.
5. Result = Reading + Correction Factor
Margin = Result - Limit
Remark Peak = Result(PK) - Limit(AV)
Remark AVG = Result(AV) - Limit(AV)



Product Name	DreamTab HD8	Test By	Rueyyan Lin
Test Model	DMTAB-IN08A	Test Date	2014/03/25
Test Mode	IEEE 802.11a TX / CH Middle	Temp. & Humidity	25°C, 49%

966 Chamber_B at 3Meter / Horizontal									
Frequency (MHz)	Reading-PK (dBuV)	Reading-AV (dBuV)	Correction Factor (dB/m)	Result-PK (dBuV/m)	Result-AV (dBuV/m)	Limit-PK (dBuV/m)	Limit-AV (dBuV/m)	Margin (dB)	Remark
1005.00	55.27	---	-4.47	50.80	---	74.00	54.00	-3.20	Peak
1245.00	53.98	---	-3.90	50.07	---	74.00	54.00	-3.93	Peak
1395.00	54.20	---	-3.55	50.65	---	74.00	54.00	-3.35	Peak
1610.00	53.42	---	-2.09	51.33	---	74.00	54.00	-2.67	Peak
6144.00	36.88	---	11.49	48.38	---	74.00	54.00	-5.62	Peak
6708.00	37.52	---	12.41	49.93	---	74.00	54.00	-4.07	Peak
7500.00	37.98	---	13.88	51.86	---	74.00	54.00	-2.14	Peak

966 Chamber_B at 3Meter / Vertical									
Frequency (MHz)	Reading-PK (dBuV)	Reading-AV (dBuV)	Correction Factor (dB/m)	Result-PK (dBuV/m)	Result-AV (dBuV/m)	Limit-PK (dBuV/m)	Limit-AV (dBuV/m)	Margin (dB)	Remark
1005.00	54.71	---	-4.47	50.25	---	74.00	54.00	-3.75	Peak
1170.00	54.12	---	-4.08	50.04	---	74.00	54.00	-3.96	Peak
1350.00	54.66	---	-3.65	51.01	---	74.00	54.00	-2.99	Peak
1605.00	53.60	---	-2.14	51.46	---	74.00	54.00	-2.54	Peak
6144.00	37.25	---	11.49	48.74	---	74.00	54.00	-5.26	Peak
6768.00	37.88	---	12.39	50.28	---	74.00	54.00	-3.72	Peak
7764.00	37.76	---	13.72	51.48	---	74.00	54.00	-2.52	Peak

Remark:

1. Measuring frequencies from 1 GHz to the 10th harmonic of highest fundamental frequency.
2. Average test would be performed if the peak result were greater than the average limit.
3. Data of measurement within this frequency range shown " --- " in the table above means the reading of emissions are attenuated more than 20dB below the permissible limits or the field strength is too small to be measured.
4. Measurements above show only up to 6 maximum emissions noted, or would be lesser, with " N/A " remark, if no specific emissions from the EUT are recorded (ie: margin>20dB from the applicable limit) and considered that's already beyond the background noise floor.
5. Result = Reading + Correction Factor
Margin = Result - Limit
Remark Peak = Result(PK) - Limit(AV)
Remark AVG = Result(AV) - Limit(AV)



Product Name	DreamTab HD8	Test By	Rueyyan Lin
Test Model	DMTAB-IN08A	Test Date	2014/03/25
Test Mode	IEEE 802.11a TX / CH High	Temp. & Humidity	25°C, 49%

966 Chamber_B at 3Meter / Horizontal									
Frequency (MHz)	Reading-PK (dBuV)	Reading-AV (dBuV)	Correction Factor (dB/m)	Result-PK (dBuV/m)	Result-AV (dBuV/m)	Limit-PK (dBuV/m)	Limit-AV (dBuV/m)	Margin (dB)	Remark
1050.00	55.13	---	-4.36	50.76	---	74.00	54.00	-3.24	Peak
1180.00	53.98	---	-4.06	49.92	---	74.00	54.00	-4.08	Peak
1405.00	53.98	---	-3.52	50.46	---	74.00	54.00	-3.54	Peak
1680.00	53.30	---	-1.31	51.99	---	74.00	54.00	-2.01	Peak
6168.00	37.41	---	11.56	48.97	---	74.00	54.00	-5.03	Peak
6660.00	38.40	---	12.43	50.83	---	74.00	54.00	-3.17	Peak
7524.00	38.40	---	13.87	52.26	---	74.00	54.00	-1.74	Peak

966 Chamber_B at 3Meter / Vertical									
Frequency (MHz)	Reading-PK (dBuV)	Reading-AV (dBuV)	Correction Factor (dB/m)	Result-PK (dBuV/m)	Result-AV (dBuV/m)	Limit-PK (dBuV/m)	Limit-AV (dBuV/m)	Margin (dB)	Remark
1050.00	55.48	---	-4.36	51.12	---	74.00	54.00	-2.88	Peak
1185.00	53.42	---	-4.04	49.38	---	74.00	54.00	-4.62	Peak
1310.00	54.75	---	-3.75	51.00	---	74.00	54.00	-3.00	Peak
1550.00	53.02	---	-2.75	50.28	---	74.00	54.00	-3.72	Peak
6168.00	37.31	---	11.56	48.88	---	74.00	54.00	-5.12	Peak
6912.00	37.85	---	12.35	50.21	---	74.00	54.00	-3.79	Peak
7764.00	38.53	---	13.72	52.25	---	74.00	54.00	-1.75	Peak

Remark:

1. Measuring frequencies from 1 GHz to the 10th harmonic of highest fundamental frequency.
2. Average test would be performed if the peak result were greater than the average limit.
3. Data of measurement within this frequency range shown " --- " in the table above means the reading of emissions are attenuated more than 20dB below the permissible limits or the field strength is too small to be measured.
4. Measurements above show only up to 6 maximum emissions noted, or would be lesser, with " N/A " remark, if no specific emissions from the EUT are recorded (ie: margin>20dB from the applicable limit) and considered that's already beyond the background noise floor.
5. Result = Reading + Correction Factor
Margin = Result - Limit
Remark Peak = Result(PK) - Limit(AV)
Remark AVG = Result(AV) - Limit(AV)



Product Name	DreamTab HD8	Test By	Rueyyan Lin
Test Model	DMTAB-IN08A	Test Date	2014/03/25
Test Mode	IEEE 802.11an HT20 TX / CH Low	Temp. & Humidity	25°C, 49%

966 Chamber_B at 3Meter / Horizontal

Frequency (MHz)	Reading-PK (dBuV)	Reading-AV (dBuV)	Correction Factor (dB/m)	Result-PK (dBuV/m)	Result-AV (dBuV/m)	Limit-PK (dBuV/m)	Limit-AV (dBuV/m)	Margin (dB)	Remark
1030.00	54.76	---	-4.41	50.35	---	74.00	54.00	-3.65	Peak
1215.00	55.05	---	-3.97	51.08	---	74.00	54.00	-2.92	Peak
1335.00	54.24	---	-3.69	50.56	---	74.00	54.00	-3.44	Peak
1600.00	53.45	---	-2.20	51.25	---	74.00	54.00	-2.75	Peak
6096.00	37.48	---	11.36	48.85	---	74.00	54.00	-5.15	Peak
6804.00	38.41	---	12.38	50.80	---	74.00	54.00	-3.20	Peak
7584.00	38.17	---	13.83	52.00	---	74.00	54.00	-2.00	Peak

966 Chamber_B at 3Meter / Vertical

Frequency (MHz)	Reading-PK (dBuV)	Reading-AV (dBuV)	Correction Factor (dB/m)	Result-PK (dBuV/m)	Result-AV (dBuV/m)	Limit-PK (dBuV/m)	Limit-AV (dBuV/m)	Margin (dB)	Remark
1095.00	64.85	45.93	-4.26	60.59	41.67	74.00	54.00	-12.33	AVG
1255.00	54.19	---	-3.88	50.31	---	74.00	54.00	-3.69	Peak
1435.00	53.80	---	-3.45	50.35	---	74.00	54.00	-3.65	Peak
6144.00	37.35	---	11.49	48.84	---	74.00	54.00	-5.16	Peak
6768.00	38.06	---	12.39	50.45	---	74.00	54.00	-3.55	Peak
7620.00	38.20	---	13.81	52.01	---	74.00	54.00	-1.99	Peak

Remark:

1. Measuring frequencies from 1 GHz to the 10th harmonic of highest fundamental frequency.
2. Average test would be performed if the peak result were greater than the average limit.
3. Data of measurement within this frequency range shown " --- " in the table above means the reading of emissions are attenuated more than 20dB below the permissible limits or the field strength is too small to be measured.
4. Measurements above show only up to 6 maximum emissions noted, or would be lesser, with " N/A " remark, if no specific emissions from the EUT are recorded (ie: margin>20dB from the applicable limit) and considered that's already beyond the background noise floor.
5. Result = Reading + Correction Factor
Margin = Result - Limit
Remark Peak = Result(PK) - Limit(AV)
Remark AVG = Result(AV) - Limit(AV)



Product Name	DreamTab HD8	Test By	Rueyyan Lin
Test Model	DMTAB-IN08A	Test Date	2014/03/25
Test Mode	IEEE 802.11an HT20 TX / CH Middle	Temp. & Humidity	25°C, 49%

966 Chamber_B at 3Meter / Horizontal									
Frequency (MHz)	Reading-PK (dBuV)	Reading-AV (dBuV)	Correction Factor (dB/m)	Result-PK (dBuV/m)	Result-AV (dBuV/m)	Limit-PK (dBuV/m)	Limit-AV (dBuV/m)	Margin (dB)	Remark
1060.00	55.04	---	-4.34	50.71	---	74.00	54.00	-3.29	Peak
1260.00	54.67	---	-3.87	50.81	---	74.00	54.00	-3.19	Peak
1475.00	54.16	---	-3.36	50.80	---	74.00	54.00	-3.20	Peak
1690.00	52.92	---	-1.20	51.72	---	74.00	54.00	-2.28	Peak
6384.00	37.32	---	12.15	49.47	---	74.00	54.00	-4.53	Peak
6912.00	37.96	---	12.35	50.31	---	74.00	54.00	-3.69	Peak
7752.00	37.92	---	13.72	51.64	---	74.00	54.00	-2.36	Peak

966 Chamber_B at 3Meter / Vertical									
Frequency (MHz)	Reading-PK (dBuV)	Reading-AV (dBuV)	Correction Factor (dB/m)	Result-PK (dBuV/m)	Result-AV (dBuV/m)	Limit-PK (dBuV/m)	Limit-AV (dBuV/m)	Margin (dB)	Remark
1120.00	55.13	---	-4.20	50.94	---	74.00	54.00	-3.06	Peak
1340.00	54.44	---	-3.68	50.77	---	74.00	54.00	-3.23	Peak
1550.00	53.33	---	-2.75	50.59	---	74.00	54.00	-3.41	Peak
1705.00	52.52	---	-1.04	51.48	---	74.00	54.00	-2.52	Peak
6108.00	37.16	---	11.40	48.56	---	74.00	54.00	-5.44	Peak
6744.00	37.78	---	12.40	50.18	---	74.00	54.00	-3.82	Peak
7620.00	37.87	---	13.81	51.68	---	74.00	54.00	-2.32	Peak

Remark:

1. Measuring frequencies from 1 GHz to the 10th harmonic of highest fundamental frequency.
2. Average test would be performed if the peak result were greater than the average limit.
3. Data of measurement within this frequency range shown " --- " in the table above means the reading of emissions are attenuated more than 20dB below the permissible limits or the field strength is too small to be measured.
4. Measurements above show only up to 6 maximum emissions noted, or would be lesser, with " N/A " remark, if no specific emissions from the EUT are recorded (ie: margin>20dB from the applicable limit) and considered that's already beyond the background noise floor.
5. Result = Reading + Correction Factor
Margin = Result - Limit
Remark Peak = Result(PK) - Limit(AV)
Remark AVG = Result(AV) - Limit(AV)



Product Name	DreamTab HD8	Test By	Rueyyan Lin
Test Model	DMTAB-IN08A	Test Date	2014/03/25
Test Mode	IEEE 802.11an HT20 TX / CH High	Temp. & Humidity	25°C, 49%

966 Chamber_B at 3Meter / Horizontal									
Frequency (MHz)	Reading-PK (dBuV)	Reading-AV (dBuV)	Correction Factor (dB/m)	Result-PK (dBuV/m)	Result-AV (dBuV/m)	Limit-PK (dBuV/m)	Limit-AV (dBuV/m)	Margin (dB)	Remark
1035.00	55.01	---	-4.40	50.62	---	74.00	54.00	-3.38	Peak
1160.00	54.36	---	-4.10	50.26	---	74.00	54.00	-3.74	Peak
1390.00	54.05	---	-3.56	50.50	---	74.00	54.00	-3.50	Peak
1620.00	53.10	---	-1.98	51.12	---	74.00	54.00	-2.88	Peak
6204.00	36.81	---	11.66	48.47	---	74.00	54.00	-5.53	Peak
6720.00	37.23	---	12.41	49.64	---	74.00	54.00	-4.36	Peak
7716.00	38.07	---	13.75	51.82	---	74.00	54.00	-2.18	Peak

966 Chamber_B at 3Meter / Vertical									
Frequency (MHz)	Reading-PK (dBuV)	Reading-AV (dBuV)	Correction Factor (dB/m)	Result-PK (dBuV/m)	Result-AV (dBuV/m)	Limit-PK (dBuV/m)	Limit-AV (dBuV/m)	Margin (dB)	Remark
1030.00	54.70	---	-4.41	50.29	---	74.00	54.00	-3.71	Peak
1180.00	54.55	---	-4.06	50.50	---	74.00	54.00	-3.50	Peak
1405.00	54.58	---	-3.52	51.06	---	74.00	54.00	-2.94	Peak
1620.00	53.62	---	-1.98	51.65	---	74.00	54.00	-2.35	Peak
6216.00	37.68	---	11.69	49.37	---	74.00	54.00	-4.63	Peak
6828.00	38.06	---	12.38	50.44	---	74.00	54.00	-3.56	Peak
7656.00	37.89	---	13.78	51.67	---	74.00	54.00	-2.33	Peak

Remark:

1. Measuring frequencies from 1 GHz to the 10th harmonic of highest fundamental frequency.
2. Average test would be performed if the peak result were greater than the average limit.
3. Data of measurement within this frequency range shown " --- " in the table above means the reading of emissions are attenuated more than 20dB below the permissible limits or the field strength is too small to be measured.
4. Measurements above show only up to 6 maximum emissions noted, or would be lesser, with " N/A " remark, if no specific emissions from the EUT are recorded (ie: margin>20dB from the applicable limit) and considered that's already beyond the background noise floor.
5. Result = Reading + Correction Factor
Margin = Result - Limit
Remark Peak = Result(PK) - Limit(AV)
Remark AVG = Result(AV) - Limit(AV)



Product Name	DreamTab HD8	Test By	Rueyyan Lin
Test Model	DMTAB-IN08A	Test Date	2014/03/25
Test Mode	IEEE 802.11an HT40 TX / CH Low	Temp. & Humidity	25°C, 49%

966 Chamber_B at 3Meter / Horizontal									
Frequency (MHz)	Reading-PK (dBuV)	Reading-AV (dBuV)	Correction Factor (dB/m)	Result-PK (dBuV/m)	Result-AV (dBuV/m)	Limit-PK (dBuV/m)	Limit-AV (dBuV/m)	Margin (dB)	Remark
1090.00	55.53	---	-4.27	51.26	---	74.00	54.00	-2.74	Peak
1235.00	54.02	---	-3.93	50.09	---	74.00	54.00	-3.91	Peak
1405.00	53.60	---	-3.52	50.08	---	74.00	54.00	-3.92	Peak
1665.00	53.45	---	-1.48	51.97	---	74.00	54.00	-2.03	Peak
6216.00	36.28	---	11.69	47.98	---	74.00	54.00	-6.02	Peak
6936.00	37.14	---	12.35	49.48	---	74.00	54.00	-4.52	Peak
7608.00	37.85	---	13.81	51.67	---	74.00	54.00	-2.33	Peak

966 Chamber_B at 3Meter / Vertical									
Frequency (MHz)	Reading-PK (dBuV)	Reading-AV (dBuV)	Correction Factor (dB/m)	Result-PK (dBuV/m)	Result-AV (dBuV/m)	Limit-PK (dBuV/m)	Limit-AV (dBuV/m)	Margin (dB)	Remark
1075.00	54.92	---	-4.30	50.62	---	74.00	54.00	-3.38	Peak
1320.00	54.48	---	-3.72	50.75	---	74.00	54.00	-3.25	Peak
1465.00	54.19	---	-3.38	50.81	---	74.00	54.00	-3.19	Peak
1665.00	53.13	---	-1.48	51.66	---	74.00	54.00	-2.34	Peak
6156.00	37.26	---	11.53	48.79	---	74.00	54.00	-5.21	Peak
6912.00	37.56	---	12.35	49.91	---	74.00	54.00	-4.09	Peak
7716.00	38.39	---	13.75	52.14	---	74.00	54.00	-1.86	Peak

Remark:

1. Measuring frequencies from 1 GHz to the 10th harmonic of highest fundamental frequency.
2. Average test would be performed if the peak result were greater than the average limit.
3. Data of measurement within this frequency range shown " --- " in the table above means the reading of emissions are attenuated more than 20dB below the permissible limits or the field strength is too small to be measured.
4. Measurements above show only up to 6 maximum emissions noted, or would be lesser, with " N/A " remark, if no specific emissions from the EUT are recorded (ie: margin>20dB from the applicable limit) and considered that's already beyond the background noise floor.
5. Result = Reading + Correction Factor
Margin = Result - Limit
Remark Peak = Result(PK) - Limit(AV)
Remark AVG = Result(AV) - Limit(AV)



Product Name	DreamTab HD8	Test By	Rueyyan Lin
Test Model	DMTAB-IN08A	Test Date	2014/03/25
Test Mode	IEEE 802.11an HT40 TX / CH High	Temp. & Humidity	25°C, 49%

966 Chamber_B at 3Meter / Horizontal									
Frequency (MHz)	Reading-PK (dBuV)	Reading-AV (dBuV)	Correction Factor (dB/m)	Result-PK (dBuV/m)	Result-AV (dBuV/m)	Limit-PK (dBuV/m)	Limit-AV (dBuV/m)	Margin (dB)	Remark
1060.00	55.83	---	-4.34	51.49	---	74.00	54.00	-2.51	Peak
1205.00	54.24	---	-4.00	50.24	---	74.00	54.00	-3.76	Peak
1390.00	54.57	---	-3.56	51.01	---	74.00	54.00	-2.99	Peak
1635.00	53.11	---	-1.81	51.30	---	74.00	54.00	-2.70	Peak
6132.00	37.12	---	11.46	48.58	---	74.00	54.00	-5.42	Peak
6816.00	37.54	---	12.38	49.92	---	74.00	54.00	-4.08	Peak
7776.00	37.98	---	13.71	51.69	---	74.00	54.00	-2.31	Peak

966 Chamber_B at 3Meter / Vertical									
Frequency (MHz)	Reading-PK (dBuV)	Reading-AV (dBuV)	Correction Factor (dB/m)	Result-PK (dBuV/m)	Result-AV (dBuV/m)	Limit-PK (dBuV/m)	Limit-AV (dBuV/m)	Margin (dB)	Remark
1010.00	54.55	---	-4.46	50.10	---	74.00	54.00	-3.90	Peak
1250.00	54.34	---	-3.89	50.45	---	74.00	54.00	-3.55	Peak
1465.00	54.18	---	-3.38	50.80	---	74.00	54.00	-3.20	Peak
1635.00	53.51	---	-1.81	51.71	---	74.00	54.00	-2.29	Peak
6264.00	37.11	---	11.82	48.94	---	74.00	54.00	-5.06	Peak
6756.00	38.61	---	12.40	51.01	---	74.00	54.00	-2.99	Peak
7752.00	38.72	---	13.72	52.45	---	74.00	54.00	-1.55	Peak

Remark:

1. Measuring frequencies from 1 GHz to the 10th harmonic of highest fundamental frequency.
2. Average test would be performed if the peak result were greater than the average limit.
3. Data of measurement within this frequency range shown " --- " in the table above means the reading of emissions are attenuated more than 20dB below the permissible limits or the field strength is too small to be measured.
4. Measurements above show only up to 6 maximum emissions noted, or would be lesser, with " N/A " remark, if no specific emissions from the EUT are recorded (ie: margin>20dB from the applicable limit) and considered that's already beyond the background noise floor.
5. Result = Reading + Correction Factor
Margin = Result - Limit
Remark Peak = Result(PK) - Limit(AV)
Remark AVG = Result(AV) - Limit(AV)



Product Name	DreamTab HD8	Test By	Rueyyan Lin
Test Model	DMTAB-IN08A	Test Date	2014/03/27
Test Mode	IEEE 802.11b TX / CH Low	Temp. & Humidity	25°C, 49%

966 Chamber_B at 3Meter / Horizontal									
Frequency (MHz)	Reading-PK (dBuV)	Reading-AV (dBuV)	Correction Factor (dB/m)	Result-PK (dBuV/m)	Result-AV (dBuV/m)	Limit-PK (dBuV/m)	Limit-AV (dBuV/m)	Margin (dB)	Remark
1030.00	55.24	---	-4.41	50.83	---	74.00	54.00	-3.17	Peak
1168.00	54.76	---	-4.08	50.67	---	74.00	54.00	-3.33	Peak
1330.00	54.84	---	-3.70	51.13	---	74.00	54.00	-2.87	Peak
1464.00	54.66	---	-3.38	51.27	---	74.00	54.00	-2.73	Peak
2390.00	59.67	50.56	2.91	62.58	53.47	74.00	54.00	-0.53	AVG
3225.00	41.69	---	4.96	46.65	---	74.00	54.00	-7.35	Peak
4005.00	40.89	---	6.77	47.66	---	74.00	54.00	-6.34	Peak
4830.00	47.98	45.13	8.75	56.73	53.88	74.00	54.00	-0.12	AVG

966 Chamber_B at 3Meter / Vertical									
Frequency (MHz)	Reading-PK (dBuV)	Reading-AV (dBuV)	Correction Factor (dB/m)	Result-PK (dBuV/m)	Result-AV (dBuV/m)	Limit-PK (dBuV/m)	Limit-AV (dBuV/m)	Margin (dB)	Remark
1006.00	55.20	---	-4.47	50.73	---	74.00	54.00	-3.27	Peak
1234.00	54.81	---	-3.93	50.88	---	74.00	54.00	-3.12	Peak
1474.00	54.01	---	-3.36	50.65	---	74.00	54.00	-3.35	Peak
1886.00	55.35	40.21	0.96	56.31	41.17	74.00	54.00	-12.83	AVG
2390.00	55.86	43.77	2.91	58.77	46.68	74.00	54.00	-7.32	AVG
3720.00	43.94	---	5.88	49.82	---	74.00	54.00	-4.18	Peak
4305.00	41.75	---	7.40	49.15	---	74.00	54.00	-4.85	Peak
4830.00	47.99	44.95	8.75	56.74	53.70	74.00	54.00	-0.30	AVG

Remark:

1. Measuring frequencies from 1 GHz to the 10th harmonic of highest fundamental frequency.
2. Average test would be performed if the peak result were greater than the average limit.
3. Data of measurement within this frequency range shown " --- " in the table above means the reading of emissions are attenuated more than 20dB below the permissible limits or the field strength is too small to be measured.
4. Measurements above show only up to 6 maximum emissions noted, or would be lesser, with " N/A " remark, if no specific emissions from the EUT are recorded (ie: margin>20dB from the applicable limit) and considered that's already beyond the background noise floor.
5. Result = Reading + Correction Factor
 Margin = Result - Limit
 Remark Peak = Result(PK) - Limit(AV)
 Remark AVG = Result(AV) - Limit(AV)



Product Name	DreamTab HD8	Test By	Rueyyan Lin
Test Model	DMTAB-IN08A	Test Date	2014/03/27
Test Mode	IEEE 802.11b TX / CH Middle	Temp. & Humidity	25°C, 49%

966 Chamber_B at 3Meter / Horizontal									
Frequency (MHz)	Reading-PK (dBuV)	Reading-AV (dBuV)	Correction Factor (dB/m)	Result-PK (dBuV/m)	Result-AV (dBuV/m)	Limit-PK (dBuV/m)	Limit-AV (dBuV/m)	Margin (dB)	Remark
1020.00	55.06	---	-4.43	50.63	---	74.00	54.00	-3.37	Peak
1156.00	54.86	---	-4.11	50.75	---	74.00	54.00	-3.25	Peak
1350.00	54.63	---	-3.65	50.98	---	74.00	54.00	-3.02	Peak
1520.00	53.76	---	-3.08	50.68	---	74.00	54.00	-3.32	Peak
3225.00	41.08	---	4.96	46.05	---	74.00	54.00	-7.95	Peak
3945.00	39.93	---	6.59	46.51	---	74.00	54.00	-7.49	Peak
4875.00	48.16	44.13	8.88	57.04	53.01	74.00	54.00	-0.99	AVG

966 Chamber_B at 3Meter / Vertical									
Frequency (MHz)	Reading-PK (dBuV)	Reading-AV (dBuV)	Correction Factor (dB/m)	Result-PK (dBuV/m)	Result-AV (dBuV/m)	Limit-PK (dBuV/m)	Limit-AV (dBuV/m)	Margin (dB)	Remark
1016.00	55.05	---	-4.44	50.61	---	74.00	54.00	-3.39	Peak
1186.00	54.36	---	-4.04	50.32	---	74.00	54.00	-3.68	Peak
1336.00	54.98	---	-3.69	51.29	---	74.00	54.00	-2.71	Peak
1488.00	54.49	---	-3.33	51.16	---	74.00	54.00	-2.84	Peak
3277.50	41.89	---	5.01	46.90	---	74.00	54.00	-7.10	Peak
3862.50	41.85	---	6.33	48.18	---	74.00	54.00	-5.82	Peak
4305.00	41.78	---	7.40	49.19	---	74.00	54.00	-4.81	Peak
4875.00	48.22	44.83	8.88	57.10	53.71	74.00	54.00	-0.29	AVG

Remark:

1. Measuring frequencies from 1 GHz to the 10th harmonic of highest fundamental frequency.
2. Average test would be performed if the peak result were greater than the average limit.
3. Data of measurement within this frequency range shown " --- " in the table above means the reading of emissions are attenuated more than 20dB below the permissible limits or the field strength is too small to be measured.
4. Measurements above show only up to 6 maximum emissions noted, or would be lesser, with " N/A " remark, if no specific emissions from the EUT are recorded (ie: margin>20dB from the applicable limit) and considered that's already beyond the background noise floor.
5. Result = Reading + Correction Factor
Margin = Result - Limit
Remark Peak = Result(PK) - Limit(AV)
Remark AVG = Result(AV) - Limit(AV)



Product Name	DreamTab HD8	Test By	Rueyyan Lin
Test Model	DMTAB-IN08A	Test Date	2014/03/27
Test Mode	IEEE 802.11b TX / CH High	Temp. & Humidity	25°C, 49%

966 Chamber_B at 3Meter / Horizontal									
Frequency (MHz)	Reading-PK (dBuV)	Reading-AV (dBuV)	Correction Factor (dB/m)	Result-PK (dBuV/m)	Result-AV (dBuV/m)	Limit-PK (dBuV/m)	Limit-AV (dBuV/m)	Margin (dB)	Remark
1028.00	54.34	---	-4.41	49.93	---	74.00	54.00	-4.07	Peak
1254.00	55.14	---	-3.88	51.26	---	74.00	54.00	-2.74	Peak
1458.00	54.05	---	-3.40	50.65	---	74.00	54.00	-3.35	Peak
1638.00	53.43	---	-1.78	51.66	---	74.00	54.00	-2.34	Peak
2483.50	57.78	50.73	3.08	60.86	53.81	74.00	54.00	-0.19	AVG
3232.50	42.28	---	4.97	47.25	---	74.00	54.00	-6.75	Peak
4297.50	40.72	---	7.38	48.10	---	74.00	54.00	-5.90	Peak
4927.50	46.63	41.80	9.03	55.66	50.83	74.00	54.00	-3.17	AVG

966 Chamber_B at 3Meter / Vertical									
Frequency (MHz)	Reading-PK (dBuV)	Reading-AV (dBuV)	Correction Factor (dB/m)	Result-PK (dBuV/m)	Result-AV (dBuV/m)	Limit-PK (dBuV/m)	Limit-AV (dBuV/m)	Margin (dB)	Remark
1046.00	54.74	---	-4.37	50.37	---	74.00	54.00	-3.63	Peak
1202.00	55.23	---	-4.00	51.23	---	74.00	54.00	-2.77	Peak
1404.00	53.93	---	-3.53	50.40	---	74.00	54.00	-3.60	Peak
1602.00	57.63	41.63	-2.17	55.46	39.46	74.00	54.00	-14.54	AVG
2483.50	56.25	46.42	3.08	59.33	49.50	74.00	54.00	-4.50	AVG
3705.00	43.16	---	5.83	49.00	---	74.00	54.00	-5.00	Peak
4305.00	40.83	---	7.40	48.23	---	74.00	54.00	-5.77	Peak
4920.00	47.92	43.73	9.01	56.93	52.74	74.00	54.00	-1.26	AVG

Remark:

1. Measuring frequencies from 1 GHz to the 10th harmonic of highest fundamental frequency.
2. Average test would be performed if the peak result were greater than the average limit.
3. Data of measurement within this frequency range shown " --- " in the table above means the reading of emissions are attenuated more than 20dB below the permissible limits or the field strength is too small to be measured.
4. Measurements above show only up to 6 maximum emissions noted, or would be lesser, with " N/A " remark, if no specific emissions from the EUT are recorded (ie: margin>20dB from the applicable limit) and considered that's already beyond the background noise floor.
5. Result = Reading + Correction Factor
 Margin = Result - Limit
 Remark Peak = Result(PK) - Limit(AV)
 Remark AVG = Result(AV) - Limit(AV)



Product Name	DreamTab HD8	Test By	Rueyyan Lin
Test Model	DMTAB-IN08A	Test Date	2014/03/27
Test Mode	IEEE 802.11g TX / CH Low	Temp. & Humidity	25°C, 49%

966 Chamber_B at 3Meter / Horizontal									
Frequency (MHz)	Reading-PK (dBuV)	Reading-AV (dBuV)	Correction Factor (dB/m)	Result-PK (dBuV/m)	Result-AV (dBuV/m)	Limit-PK (dBuV/m)	Limit-AV (dBuV/m)	Margin (dB)	Remark
1026.00	55.22	---	-4.42	50.80	---	74.00	54.00	-3.20	Peak
1212.00	54.61	---	-3.98	50.63	---	74.00	54.00	-3.37	Peak
1410.00	53.97	---	-3.51	50.46	---	74.00	54.00	-3.54	Peak
2390.00	70.33	46.64	2.91	73.24	49.55	74.00	54.00	-0.76	AVG
3180.00	41.62	---	4.93	46.55	---	74.00	54.00	-7.45	Peak
4005.00	39.88	---	6.77	46.65	---	74.00	54.00	-7.35	Peak
4830.00	39.01	---	8.75	47.76	---	74.00	54.00	-6.24	Peak

966 Chamber_B at 3Meter / Vertical									
Frequency (MHz)	Reading-PK (dBuV)	Reading-AV (dBuV)	Correction Factor (dB/m)	Result-PK (dBuV/m)	Result-AV (dBuV/m)	Limit-PK (dBuV/m)	Limit-AV (dBuV/m)	Margin (dB)	Remark
1064.00	54.73	---	-4.33	50.40	---	74.00	54.00	-3.60	Peak
1266.00	54.30	---	-3.85	50.45	---	74.00	54.00	-3.55	Peak
1444.00	53.75	---	-3.43	50.32	---	74.00	54.00	-3.68	Peak
2390.00	63.24	41.82	2.91	66.15	44.73	74.00	54.00	-7.85	AVG
3180.00	41.65	---	4.93	46.58	---	74.00	54.00	-7.42	Peak
3855.00	44.23	---	6.30	50.54	---	74.00	54.00	-3.46	Peak
4305.00	42.47	---	7.40	49.87	---	74.00	54.00	-4.13	Peak
4830.00	37.87	---	8.75	46.63	---	74.00	54.00	-7.37	Peak

Remark:

1. Measuring frequencies from 1 GHz to the 10th harmonic of highest fundamental frequency.
2. Average test would be performed if the peak result were greater than the average limit.
3. Data of measurement within this frequency range shown " --- " in the table above means the reading of emissions are attenuated more than 20dB below the permissible limits or the field strength is too small to be measured.
4. Measurements above show only up to 6 maximum emissions noted, or would be lesser, with " N/A " remark, if no specific emissions from the EUT are recorded (ie: margin>20dB from the applicable limit) and considered that's already beyond the background noise floor.
5. Result = Reading + Correction Factor
Margin = Result - Limit
Remark Peak = Result(PK) - Limit(AV)
Remark AVG = Result(AV) - Limit(AV)



Product Name	DreamTab HD8	Test By	Rueyyan Lin
Test Model	DMTAB-IN08A	Test Date	2014/03/27
Test Mode	IEEE 802.11g TX / CH Middle	Temp. & Humidity	25°C, 49%

966 Chamber_B at 3Meter / Horizontal									
Frequency (MHz)	Reading-PK (dBuV)	Reading-AV (dBuV)	Correction Factor (dB/m)	Result-PK (dBuV/m)	Result-AV (dBuV/m)	Limit-PK (dBuV/m)	Limit-AV (dBuV/m)	Margin (dB)	Remark
1044.00	55.34	---	-4.38	50.96	---	74.00	54.00	-3.04	Peak
1220.00	54.92	---	-3.96	50.96	---	74.00	54.00	-3.04	Peak
1354.00	53.78	---	-3.64	50.14	---	74.00	54.00	-3.86	Peak
2390.00	70.97	47.63	2.91	73.88	50.54	74.00	54.00	-0.12	AVG
2483.50	69.76	47.55	3.08	72.84	50.63	74.00	54.00	-1.16	AVG
3225.00	42.46	---	4.96	47.42	---	74.00	54.00	-6.58	Peak
4005.00	39.86	---	6.77	46.63	---	74.00	54.00	-7.37	Peak
4425.00	39.69	---	7.65	47.34	---	74.00	54.00	-6.66	Peak
4875.00	48.26	33.95	8.88	57.14	42.83	74.00	54.00	-11.17	AVG

966 Chamber_B at 3Meter / Vertical									
Frequency (MHz)	Reading-PK (dBuV)	Reading-AV (dBuV)	Correction Factor (dB/m)	Result-PK (dBuV/m)	Result-AV (dBuV/m)	Limit-PK (dBuV/m)	Limit-AV (dBuV/m)	Margin (dB)	Remark
1026.00	55.48	---	-4.42	51.06	---	74.00	54.00	-2.94	Peak
1172.00	55.00	---	-4.07	50.93	---	74.00	54.00	-3.07	Peak
1336.00	53.93	---	-3.69	50.24	---	74.00	54.00	-3.76	Peak
2390.00	61.19	42.43	2.91	64.10	45.34	74.00	54.00	-8.66	AVG
2483.50	63.68	43.51	3.08	66.76	46.59	74.00	54.00	-7.24	AVG
3720.00	43.88	---	5.88	49.76	---	74.00	54.00	-4.24	Peak
3855.00	43.90	---	6.30	50.21	---	74.00	54.00	-3.79	Peak
4305.00	43.15	---	7.40	50.55	---	74.00	54.00	-3.45	Peak
4875.00	49.23	35.50	8.88	58.11	44.38	74.00	54.00	-9.62	AVG

Remark:

1. Measuring frequencies from 1 GHz to the 10th harmonic of highest fundamental frequency.
2. Average test would be performed if the peak result were greater than the average limit.
3. Data of measurement within this frequency range shown " --- " in the table above means the reading of emissions are attenuated more than 20dB below the permissible limits or the field strength is too small to be measured.
4. Measurements above show only up to 6 maximum emissions noted, or would be lesser, with " N/A " remark, if no specific emissions from the EUT are recorded (ie: margin>20dB from the applicable limit) and considered that's already beyond the background noise floor.
5. Result = Reading + Correction Factor
 Margin = Result - Limit
 Remark Peak = Result(PK) - Limit(AV)
 Remark AVG = Result(AV) - Limit(AV)



Product Name	DreamTab HD8	Test By	Rueyyan Lin
Test Model	DMTAB-IN08A	Test Date	2014/03/27
Test Mode	IEEE 802.11g TX / CH High	Temp. & Humidity	25°C, 49%

966 Chamber_B at 3Meter / Horizontal									
Frequency (MHz)	Reading-PK (dBuV)	Reading-AV (dBuV)	Correction Factor (dB/m)	Result-PK (dBuV/m)	Result-AV (dBuV/m)	Limit-PK (dBuV/m)	Limit-AV (dBuV/m)	Margin (dB)	Remark
1016.00	55.05	---	-4.44	50.60	---	74.00	54.00	-3.40	Peak
1186.00	55.04	---	-4.04	51.00	---	74.00	54.00	-3.00	Peak
1306.00	54.54	---	-3.76	50.78	---	74.00	54.00	-3.22	Peak
2483.50	70.17	44.73	3.08	73.25	47.81	74.00	54.00	-0.75	AVG
3240.00	41.61	---	4.98	46.59	---	74.00	54.00	-7.41	Peak
3855.00	40.32	---	6.30	46.62	---	74.00	54.00	-7.38	Peak
4290.00	39.91	---	7.37	47.28	---	74.00	54.00	-6.72	Peak
4935.00	38.68	---	9.05	47.73	---	74.00	54.00	-6.27	Peak

966 Chamber_B at 3Meter / Vertical									
Frequency (MHz)	Reading-PK (dBuV)	Reading-AV (dBuV)	Correction Factor (dB/m)	Result-PK (dBuV/m)	Result-AV (dBuV/m)	Limit-PK (dBuV/m)	Limit-AV (dBuV/m)	Margin (dB)	Remark
1016.00	55.25	---	-4.44	50.81	---	74.00	54.00	-3.19	Peak
1138.00	54.90	---	-4.15	50.74	---	74.00	54.00	-3.26	Peak
1340.00	54.43	---	-3.68	50.75	---	74.00	54.00	-3.25	Peak
2484.00	64.62	41.72	3.08	67.70	44.80	74.00	54.00	-6.30	AVG
3705.00	43.28	---	5.83	49.11	---	74.00	54.00	-4.89	Peak
4005.00	42.94	---	6.77	49.71	---	74.00	54.00	-4.29	Peak
4305.00	42.36	---	7.40	49.77	---	74.00	54.00	-4.23	Peak
4890.00	39.57	---	8.93	48.50	---	74.00	54.00	-5.50	Peak

Remark:

1. Measuring frequencies from 1 GHz to the 10th harmonic of highest fundamental frequency.
2. Average test would be performed if the peak result were greater than the average limit.
3. Data of measurement within this frequency range shown " --- " in the table above means the reading of emissions are attenuated more than 20dB below the permissible limits or the field strength is too small to be measured.
4. Measurements above show only up to 6 maximum emissions noted, or would be lesser, with " N/A " remark, if no specific emissions from the EUT are recorded (ie: margin>20dB from the applicable limit) and considered that's already beyond the background noise floor.
5. Result = Reading + Correction Factor
Margin = Result - Limit
Remark Peak = Result(PK) - Limit(AV)
Remark AVG = Result(AV) - Limit(AV)



Product Name	DreamTab HD8	Test By	Rueyyan Lin
Test Model	DMTAB-IN08A	Test Date	2014/03/27
Test Mode	IEEE 802.11n HT20 TX / CH Low	Temp. & Humidity	25°C, 49%

966 Chamber_B at 3Meter / Horizontal									
Frequency (MHz)	Reading-PK (dBuV)	Reading-AV (dBuV)	Correction Factor (dB/m)	Result-PK (dBuV/m)	Result-AV (dBuV/m)	Limit-PK (dBuV/m)	Limit-AV (dBuV/m)	Margin (dB)	Remark
1014.00	54.75	---	-4.45	50.30	---	74.00	54.00	-3.70	Peak
1158.00	55.42	---	-4.11	51.31	---	74.00	54.00	-2.69	Peak
1338.00	54.07	---	-3.68	50.38	---	74.00	54.00	-3.62	Peak
2390.00	70.15	47.71	2.91	73.06	50.62	74.00	54.00	-0.94	AVG
3195.00	42.54	---	4.94	47.48	---	74.00	54.00	-6.52	Peak
4005.00	40.03	---	6.77	46.80	---	74.00	54.00	-7.20	Peak
4830.00	38.09	---	8.75	46.84	---	74.00	54.00	-7.16	Peak

966 Chamber_B at 3Meter / Vertical									
Frequency (MHz)	Reading-PK (dBuV)	Reading-AV (dBuV)	Correction Factor (dB/m)	Result-PK (dBuV/m)	Result-AV (dBuV/m)	Limit-PK (dBuV/m)	Limit-AV (dBuV/m)	Margin (dB)	Remark
1064.00	55.59	---	-4.33	51.26	---	74.00	54.00	-2.74	Peak
1226.00	54.21	---	-3.95	50.27	---	74.00	54.00	-3.73	Peak
1342.00	54.26	---	-3.67	50.59	---	74.00	54.00	-3.41	Peak
2390.00	65.18	43.43	2.91	68.09	46.34	74.00	54.00	-5.91	AVG
3315.00	41.59	---	5.04	46.63	---	74.00	54.00	-7.37	Peak
3720.00	41.14	---	5.88	47.02	---	74.00	54.00	-6.98	Peak
4305.00	42.96	---	7.40	50.36	---	74.00	54.00	-3.64	Peak
4830.00	38.78	---	8.75	47.54	---	74.00	54.00	-6.46	Peak

Remark:

1. Measuring frequencies from 1 GHz to the 10th harmonic of highest fundamental frequency.
2. Average test would be performed if the peak result were greater than the average limit.
3. Data of measurement within this frequency range shown " --- " in the table above means the reading of emissions are attenuated more than 20dB below the permissible limits or the field strength is too small to be measured.
4. Measurements above show only up to 6 maximum emissions noted, or would be lesser, with " N/A " remark, if no specific emissions from the EUT are recorded (ie: margin>20dB from the applicable limit) and considered that's already beyond the background noise floor.
5. Result = Reading + Correction Factor
Margin = Result - Limit
Remark Peak = Result(PK) - Limit(AV)
Remark AVG = Result(AV) - Limit(AV)



Product Name	DreamTab HD8	Test By	Rueyyan Lin
Test Model	DMTAB-IN08A	Test Date	2014/03/27
Test Mode	IEEE 802.11n HT20 TX / CH Middle	Temp. & Humidity	25°C, 49%

966 Chamber_B at 3Meter / Horizontal									
Frequency (MHz)	Reading-PK (dBuV)	Reading-AV (dBuV)	Correction Factor (dB/m)	Result-PK (dBuV/m)	Result-AV (dBuV/m)	Limit-PK (dBuV/m)	Limit-AV (dBuV/m)	Margin (dB)	Remark
1090.00	54.61	---	-4.27	50.34	---	74.00	54.00	-3.66	Peak
1248.00	54.08	---	-3.89	50.18	---	74.00	54.00	-3.82	Peak
1362.00	54.27	---	-3.63	50.64	---	74.00	54.00	-3.36	Peak
2390.00	70.10	47.86	2.91	73.01	50.77	74.00	54.00	-0.99	AVG
2483.50	68.60	46.92	3.08	71.68	50.00	74.00	54.00	-2.32	AVG
3225.00	41.54	---	4.96	46.50	---	74.00	54.00	-7.50	Peak
3915.00	40.70	---	6.49	47.19	---	74.00	54.00	-6.81	Peak
4875.00	41.33	---	8.88	50.21	---	74.00	54.00	-3.79	Peak

966 Chamber_B at 3Meter / Vertical									
Frequency (MHz)	Reading-PK (dBuV)	Reading-AV (dBuV)	Correction Factor (dB/m)	Result-PK (dBuV/m)	Result-AV (dBuV/m)	Limit-PK (dBuV/m)	Limit-AV (dBuV/m)	Margin (dB)	Remark
1034.00	55.38	---	-4.40	50.98	---	74.00	54.00	-3.02	Peak
1218.00	54.08	---	-3.97	50.11	---	74.00	54.00	-3.89	Peak
1362.00	53.37	---	-3.63	49.74	---	74.00	54.00	-4.26	Peak
2390.00	64.31	44.26	2.91	67.22	47.17	74.00	54.00	-6.78	AVG
2483.50	64.18	44.24	3.08	67.26	47.32	74.00	54.00	-6.68	AVG
3225.00	40.62	---	4.96	45.59	---	74.00	54.00	-8.41	Peak
3720.00	42.04	---	5.88	47.92	---	74.00	54.00	-6.08	Peak
4305.00	40.75	---	7.40	48.15	---	74.00	54.00	-5.85	Peak
4890.00	46.70	32.78	8.93	55.63	41.71	74.00	54.00	-12.29	AVG

Remark:

1. Measuring frequencies from 1 GHz to the 10th harmonic of highest fundamental frequency.
2. Average test would be performed if the peak result were greater than the average limit.
3. Data of measurement within this frequency range shown " --- " in the table above means the reading of emissions are attenuated more than 20dB below the permissible limits or the field strength is too small to be measured.
4. Measurements above show only up to 6 maximum emissions noted, or would be lesser, with " N/A " remark, if no specific emissions from the EUT are recorded (ie: margin>20dB from the applicable limit) and considered that's already beyond the background noise floor.
5. Result = Reading + Correction Factor
Margin = Result - Limit
Remark Peak = Result(PK) - Limit(AV)
Remark AVG = Result(AV) - Limit(AV)



Product Name	DreamTab HD8	Test By	Rueyyan Lin
Test Model	DMTAB-IN08A	Test Date	2014/03/27
Test Mode	IEEE 802.11n HT20 TX / CH High	Temp. & Humidity	25°C, 49%

966 Chamber_B at 3Meter / Horizontal									
Frequency (MHz)	Reading-PK (dBuV)	Reading-AV (dBuV)	Correction Factor (dB/m)	Result-PK (dBuV/m)	Result-AV (dBuV/m)	Limit-PK (dBuV/m)	Limit-AV (dBuV/m)	Margin (dB)	Remark
1034.00	55.33	---	-4.40	50.93	---	74.00	54.00	-3.07	Peak
1170.00	55.56	---	-4.08	51.48	---	74.00	54.00	-2.52	Peak
1282.00	54.68	---	-3.81	50.86	---	74.00	54.00	-3.14	Peak
2483.50	70.47	45.01	3.08	73.55	48.09	74.00	54.00	-0.45	AVG
3120.00	41.62	---	4.88	46.50	---	74.00	54.00	-7.50	Peak
3945.00	40.31	---	6.59	46.90	---	74.00	54.00	-7.10	Peak
4920.00	38.93	---	9.01	47.94	---	74.00	54.00	-6.06	Peak

966 Chamber_B at 3Meter / Vertical									
Frequency (MHz)	Reading-PK (dBuV)	Reading-AV (dBuV)	Correction Factor (dB/m)	Result-PK (dBuV/m)	Result-AV (dBuV/m)	Limit-PK (dBuV/m)	Limit-AV (dBuV/m)	Margin (dB)	Remark
1044.00	55.12	---	-4.38	50.74	---	74.00	54.00	-3.26	Peak
1190.00	54.23	---	-4.03	50.20	---	74.00	54.00	-3.80	Peak
1346.00	54.60	---	-3.66	50.94	---	74.00	54.00	-3.06	Peak
2483.50	70.17	42.72	3.08	73.25	45.80	74.00	54.00	-0.75	AVG
3720.00	42.17	---	5.88	48.05	---	74.00	54.00	-5.95	Peak
3855.00	41.93	---	6.30	48.24	---	74.00	54.00	-5.76	Peak
4305.00	42.61	---	7.40	50.01	---	74.00	54.00	-3.99	Peak
4935.00	39.03	---	9.05	48.08	---	74.00	54.00	-5.92	Peak

Remark:

1. Measuring frequencies from 1 GHz to the 10th harmonic of highest fundamental frequency.
2. Average test would be performed if the peak result were greater than the average limit.
3. Data of measurement within this frequency range shown " --- " in the table above means the reading of emissions are attenuated more than 20dB below the permissible limits or the field strength is too small to be measured.
4. Measurements above show only up to 6 maximum emissions noted, or would be lesser, with " N/A " remark, if no specific emissions from the EUT are recorded (ie: margin>20dB from the applicable limit) and considered that's already beyond the background noise floor.
5. Result = Reading + Correction Factor
Margin = Result - Limit
Remark Peak = Result(PK) - Limit(AV)
Remark AVG = Result(AV) - Limit(AV)



Product Name	DreamTab HD8	Test By	Rueyyan Lin
Test Model	DMTAB-IN08A	Test Date	2014/03/27
Test Mode	IEEE 802.11n HT40 TX / CH Low	Temp. & Humidity	25°C, 49%

966 Chamber_B at 3Meter / Horizontal									
Frequency (MHz)	Reading-PK (dBuV)	Reading-AV (dBuV)	Correction Factor (dB/m)	Result-PK (dBuV/m)	Result-AV (dBuV/m)	Limit-PK (dBuV/m)	Limit-AV (dBuV/m)	Margin (dB)	Remark
1146.00	50.00	---	-2.89	47.12	---	74.00	54.00	-6.88	Peak
1452.00	49.09	---	-2.90	46.19	---	74.00	54.00	-7.81	Peak
1696.00	48.95	---	-1.05	47.90	---	74.00	54.00	-6.10	Peak
2024.00	47.97	---	1.87	49.83	---	74.00	54.00	-4.17	Peak
3165.00	42.39	---	4.22	46.61	---	74.00	54.00	-7.39	Peak
3885.00	41.00	---	5.54	46.55	---	74.00	54.00	-7.45	Peak
4882.50	40.39	---	8.20	48.59	---	74.00	54.00	-5.41	Peak

966 Chamber_B at 3Meter / Vertical									
Frequency (MHz)	Reading-PK (dBuV)	Reading-AV (dBuV)	Correction Factor (dB/m)	Result-PK (dBuV/m)	Result-AV (dBuV/m)	Limit-PK (dBuV/m)	Limit-AV (dBuV/m)	Margin (dB)	Remark
1048.00	49.75	---	-2.88	46.87	---	74.00	54.00	-7.13	Peak
1218.00	49.92	---	-2.89	47.03	---	74.00	54.00	-6.97	Peak
1528.00	49.47	---	-2.64	46.83	---	74.00	54.00	-7.17	Peak
2200.00	47.67	---	2.22	49.88	---	74.00	54.00	-4.12	Peak
3172.50	42.04	---	4.22	46.27	---	74.00	54.00	-7.73	Peak
3847.50	41.65	---	5.44	47.09	---	74.00	54.00	-6.91	Peak
4942.50	40.88	---	8.32	49.20	---	74.00	54.00	-4.80	Peak

Remark:

1. Measuring frequencies from 1 GHz to the 10th harmonic of highest fundamental frequency.
2. Average test would be performed if the peak result were greater than the average limit.
3. Data of measurement within this frequency range shown " --- " in the table above means the reading of emissions are attenuated more than 20dB below the permissible limits or the field strength is too small to be measured.
4. Measurements above show only up to 6 maximum emissions noted, or would be lesser, with " N/A " remark, if no specific emissions from the EUT are recorded (ie: margin>20dB from the applicable limit) and considered that's already beyond the background noise floor.
5. Result = Reading + Correction Factor
 Margin = Result - Limit
 Remark Peak = Result(PK) - Limit(AV)
 Remark AVG = Result(AV) - Limit(AV)



Product Name	DreamTab HD8	Test By	Rueyyan Lin
Test Model	DMTAB-IN08A	Test Date	2014/03/27
Test Mode	IEEE 802.11n HT40 TX / CH Middle	Temp. & Humidity	25°C, 49%

966 Chamber_B at 3Meter / Horizontal									
Frequency (MHz)	Reading-PK (dBuV)	Reading-AV (dBuV)	Correction Factor (dB/m)	Result-PK (dBuV/m)	Result-AV (dBuV/m)	Limit-PK (dBuV/m)	Limit-AV (dBuV/m)	Margin (dB)	Remark
1148.00	50.32	---	-2.89	47.43	---	74.00	54.00	-6.57	Peak
1516.00	49.15	---	-2.75	46.40	---	74.00	54.00	-7.60	Peak
1908.00	48.29	---	0.95	49.24	---	74.00	54.00	-4.76	Peak
2116.00	47.19	---	2.05	49.24	---	74.00	54.00	-4.76	Peak
3195.00	42.11	---	4.24	46.35	---	74.00	54.00	-7.65	Peak
4155.00	40.36	---	6.34	46.70	---	74.00	54.00	-7.30	Peak
4845.00	39.34	---	8.12	47.46	---	74.00	54.00	-6.54	Peak

966 Chamber_B at 3Meter / Vertical									
Frequency (MHz)	Reading-PK (dBuV)	Reading-AV (dBuV)	Correction Factor (dB/m)	Result-PK (dBuV/m)	Result-AV (dBuV/m)	Limit-PK (dBuV/m)	Limit-AV (dBuV/m)	Margin (dB)	Remark
1064.00	50.24	---	-2.88	47.36	---	74.00	54.00	-6.64	Peak
1354.00	49.60	---	-2.89	46.71	---	74.00	54.00	-7.29	Peak
1630.00	50.17	---	-1.67	48.49	---	74.00	54.00	-5.51	Peak
1984.00	47.10	---	1.67	48.77	---	74.00	54.00	-5.23	Peak
3082.50	42.32	---	4.15	46.47	---	74.00	54.00	-7.53	Peak
3952.50	40.88	---	5.73	46.61	---	74.00	54.00	-7.39	Peak
4905.00	40.22	---	8.24	48.47	---	74.00	54.00	-5.53	Peak

Remark:

1. Measuring frequencies from 1 GHz to the 10th harmonic of highest fundamental frequency.
2. Average test would be performed if the peak result were greater than the average limit.
3. Data of measurement within this frequency range shown " --- " in the table above means the reading of emissions are attenuated more than 20dB below the permissible limits or the field strength is too small to be measured.
4. Measurements above show only up to 6 maximum emissions noted, or would be lesser, with " N/A " remark, if no specific emissions from the EUT are recorded (ie: margin>20dB from the applicable limit) and considered that's already beyond the background noise floor.
5. Result = Reading + Correction Factor
Margin = Result - Limit
Remark Peak = Result(PK) - Limit(AV)
Remark AVG = Result(AV) - Limit(AV)



Product Name	DreamTab HD8	Test By	Rueyyan Lin
Test Model	DMTAB-IN08A	Test Date	2014/03/27
Test Mode	IEEE 802.11n HT40 TX / CH High	Temp. & Humidity	25°C, 49%

966 Chamber_B at 3Meter / Horizontal									
Frequency (MHz)	Reading-PK (dBuV)	Reading-AV (dBuV)	Correction Factor (dB/m)	Result-PK (dBuV/m)	Result-AV (dBuV/m)	Limit-PK (dBuV/m)	Limit-AV (dBuV/m)	Margin (dB)	Remark
1108.00	50.25	---	-2.88	47.37	---	74.00	54.00	-6.63	Peak
1420.00	48.99	---	-2.90	46.10	---	74.00	54.00	-7.90	Peak
1684.00	48.34	---	-1.16	47.18	---	74.00	54.00	-6.82	Peak
2014.00	47.78	---	1.85	49.63	---	74.00	54.00	-4.37	Peak
3307.50	41.95	---	4.33	46.28	---	74.00	54.00	-7.72	Peak
4252.50	40.06	---	6.64	46.70	---	74.00	54.00	-7.30	Peak
4912.50	40.47	---	8.26	48.73	---	74.00	54.00	-5.27	Peak

966 Chamber_B at 3Meter / Vertical									
Frequency (MHz)	Reading-PK (dBuV)	Reading-AV (dBuV)	Correction Factor (dB/m)	Result-PK (dBuV/m)	Result-AV (dBuV/m)	Limit-PK (dBuV/m)	Limit-AV (dBuV/m)	Margin (dB)	Remark
1064.00	49.68	---	-2.88	46.80	---	74.00	54.00	-7.20	Peak
1366.00	49.42	---	-2.89	46.52	---	74.00	54.00	-7.48	Peak
1784.00	48.01	---	-0.22	47.79	---	74.00	54.00	-6.21	Peak
2076.00	47.36	---	1.97	49.33	---	74.00	54.00	-4.67	Peak
3232.50	42.62	---	4.27	46.89	---	74.00	54.00	-7.11	Peak
4027.50	40.43	---	5.95	46.37	---	74.00	54.00	-7.63	Peak
4912.50	39.42	---	8.26	47.68	---	74.00	54.00	-6.32	Peak

Remark:

1. Measuring frequencies from 1 GHz to the 10th harmonic of highest fundamental frequency.
2. Average test would be performed if the peak result were greater than the average limit.
3. Data of measurement within this frequency range shown " --- " in the table above means the reading of emissions are attenuated more than 20dB below the permissible limits or the field strength is too small to be measured.
4. Measurements above show only up to 6 maximum emissions noted, or would be lesser, with " N/A " remark, if no specific emissions from the EUT are recorded (ie: margin>20dB from the applicable limit) and considered that's already beyond the background noise floor.
5. Result = Reading + Correction Factor
Margin = Result - Limit
Remark Peak = Result(PK) - Limit(AV)
Remark AVG = Result(AV) - Limit(AV)



Product Name	DreamTab HD8	Test By	Rueyyan Lin
Test Model	DMTAB-IN08A	Test Date	2014/03/27
Test Mode	Bluetooth 4.0 / TX Mode /CH Low	Temp. & Humidity	25°C, 49%

966 Chamber_B at 3Meter / Horizontal									
Frequency (MHz)	Reading-PK (dBuV)	Reading-AV (dBuV)	Correction Factor (dB/m)	Result-PK (dBuV/m)	Result-AV (dBuV/m)	Limit-PK (dBuV/m)	Limit-AV (dBuV/m)	Margin (dB)	Remark
1024.00	54.92	---	-4.42	50.49	---	74.00	54.00	-3.51	Peak
1228.00	55.20	---	-3.94	51.25	---	74.00	54.00	-2.75	Peak
1426.00	52.99	---	-3.47	49.51	---	74.00	54.00	-4.49	Peak
1610.00	53.29	---	-2.09	51.20	---	74.00	54.00	-2.80	Peak
3255.00	41.31	---	4.99	46.30	---	74.00	54.00	-7.70	Peak
4005.00	41.52	---	6.77	48.29	---	74.00	54.00	-5.71	Peak
4845.00	38.29	---	8.80	47.09	---	74.00	54.00	-6.91	Peak

966 Chamber_B at 3Meter / Vertical									
Frequency (MHz)	Reading-PK (dBuV)	Reading-AV (dBuV)	Correction Factor (dB/m)	Result-PK (dBuV/m)	Result-AV (dBuV/m)	Limit-PK (dBuV/m)	Limit-AV (dBuV/m)	Margin (dB)	Remark
1016.00	55.01	---	-4.44	50.57	---	74.00	54.00	-3.43	Peak
1152.00	53.59	---	-4.12	49.47	---	74.00	54.00	-4.53	Peak
1330.00	54.05	---	-3.70	50.35	---	74.00	54.00	-3.65	Peak
1602.00	53.08	---	-2.17	50.91	---	74.00	54.00	-3.09	Peak
3180.00	42.15	---	4.93	47.07	---	74.00	54.00	-6.93	Peak
3720.00	43.92	---	5.88	49.80	---	74.00	54.00	-4.20	Peak
3855.00	43.64	---	6.30	49.95	---	74.00	54.00	-4.05	Peak
4800.00	38.70	---	8.67	47.37	---	74.00	54.00	-6.63	Peak

Remark:

1. Measuring frequencies from 1 GHz to the 10th harmonic of highest fundamental frequency.
2. Average test would be performed if the peak result were greater than the average limit.
3. Data of measurement within this frequency range shown " --- " in the table above means the reading of emissions are attenuated more than 20dB below the permissible limits or the field strength is too small to be measured.
4. Measurements above show only up to 6 maximum emissions noted, or would be lesser, with " N/A " remark, if no specific emissions from the EUT are recorded (ie: margin>20dB from the applicable limit) and considered that's already beyond the background noise floor.
5. Result = Reading + Correction Factor
Margin = Result - Limit
Remark Peak = Result(PK) - Limit(AV)
Remark AVG = Result(AV) - Limit(AV)



Product Name	DreamTab HD8	Test By	Rueyyan Lin
Test Model	DMTAB-IN08A	Test Date	2014/03/27
Test Mode	Bluetooth 4.0 / TX Mode / CH Middle	Temp. & Humidity	25°C, 49%

966 Chamber_B at 3Meter / Horizontal									
Frequency (MHz)	Reading-PK (dBuV)	Reading-AV (dBuV)	Correction Factor (dB/m)	Result-PK (dBuV/m)	Result-AV (dBuV/m)	Limit-PK (dBuV/m)	Limit-AV (dBuV/m)	Margin (dB)	Remark
1026.00	53.95	---	-4.42	49.53	---	74.00	54.00	-4.47	Peak
1174.00	54.27	---	-4.07	50.20	---	74.00	54.00	-3.80	Peak
1368.00	53.84	---	-3.61	50.23	---	74.00	54.00	-3.77	Peak
1704.00	52.70	---	-1.05	51.65	---	74.00	54.00	-2.35	Peak
3270.00	41.99	---	5.00	47.00	---	74.00	54.00	-7.00	Peak
4005.00	41.22	---	6.77	47.99	---	74.00	54.00	-6.01	Peak
4305.00	39.66	---	7.40	47.06	---	74.00	54.00	-6.94	Peak
4890.00	38.41	---	8.93	47.34	---	74.00	54.00	-6.66	Peak

966 Chamber_B at 3Meter / Vertical									
Frequency (MHz)	Reading-PK (dBuV)	Reading-AV (dBuV)	Correction Factor (dB/m)	Result-PK (dBuV/m)	Result-AV (dBuV/m)	Limit-PK (dBuV/m)	Limit-AV (dBuV/m)	Margin (dB)	Remark
1036.00	54.25	---	-4.40	49.85	---	74.00	54.00	-4.15	Peak
1246.00	54.47	---	-3.90	50.57	---	74.00	54.00	-3.43	Peak
1438.00	53.94	---	-3.45	50.49	---	74.00	54.00	-3.51	Peak
1634.00	52.79	---	-1.82	50.97	---	74.00	54.00	-3.03	Peak
3270.00	43.60	---	5.00	48.60	---	74.00	54.00	-5.40	Peak
3720.00	44.73	---	5.88	50.62	---	74.00	54.00	-3.38	Peak
3855.00	44.04	---	6.30	50.34	---	74.00	54.00	-3.66	Peak
4890.00	38.79	---	8.93	47.71	---	74.00	54.00	-6.29	Peak

Remark:

1. Measuring frequencies from 1 GHz to the 10th harmonic of highest fundamental frequency.
2. Average test would be performed if the peak result were greater than the average limit.
3. Data of measurement within this frequency range shown " --- " in the table above means the reading of emissions are attenuated more than 20dB below the permissible limits or the field strength is too small to be measured.
4. Measurements above show only up to 6 maximum emissions noted, or would be lesser, with " N/A " remark, if no specific emissions from the EUT are recorded (ie: margin>20dB from the applicable limit) and considered that's already beyond the background noise floor.
5. Result = Reading + Correction Factor
Margin = Result - Limit
Remark Peak = Result(PK) - Limit(AV)
Remark AVG = Result(AV) - Limit(AV)



Product Name	DreamTab HD8	Test By	Rueyyan Lin
Test Model	DMTAB-IN08A	Test Date	2014/03/27
Test Mode	Bluetooth 4.0 / TX Mode / CH High	Temp. & Humidity	25°C, 49%

966 Chamber_B at 3Meter / Horizontal									
Frequency (MHz)	Reading-PK (dBuV)	Reading-AV (dBuV)	Correction Factor (dB/m)	Result-PK (dBuV/m)	Result-AV (dBuV/m)	Limit-PK (dBuV/m)	Limit-AV (dBuV/m)	Margin (dB)	Remark
1016.00	54.60	---	-4.44	50.16	---	74.00	54.00	-3.84	Peak
1186.00	55.47	---	-4.04	51.43	---	74.00	54.00	-2.57	Peak
1370.00	53.62	---	-3.61	50.01	---	74.00	54.00	-3.99	Peak
1524.00	53.77	---	-3.04	50.73	---	74.00	54.00	-3.27	Peak
3210.00	41.13	---	4.95	46.08	---	74.00	54.00	-7.92	Peak
4005.00	41.46	---	6.77	48.23	---	74.00	54.00	-5.77	Peak
4935.00	39.07	---	9.05	48.12	---	74.00	54.00	-5.88	Peak

966 Chamber_B at 3Meter / Vertical									
Frequency (MHz)	Reading-PK (dBuV)	Reading-AV (dBuV)	Correction Factor (dB/m)	Result-PK (dBuV/m)	Result-AV (dBuV/m)	Limit-PK (dBuV/m)	Limit-AV (dBuV/m)	Margin (dB)	Remark
1032.00	55.06	---	-4.40	50.65	---	74.00	54.00	-3.35	Peak
1150.00	54.37	---	-4.13	50.25	---	74.00	54.00	-3.75	Peak
1296.00	53.61	---	-3.78	49.82	---	74.00	54.00	-4.18	Peak
1508.00	54.22	---	-3.21	51.01	---	74.00	54.00	-2.99	Peak
3270.00	42.12	---	5.00	47.12	---	74.00	54.00	-6.88	Peak
4005.00	41.98	---	6.77	48.76	---	74.00	54.00	-5.24	Peak
4305.00	41.58	---	7.40	48.99	---	74.00	54.00	-5.01	Peak
4920.00	38.95	---	9.01	47.96	---	74.00	54.00	-6.04	Peak

Remark:

1. Measuring frequencies from 1 GHz to the 10th harmonic of highest fundamental frequency.
2. Average test would be performed if the peak result were greater than the average limit.
3. Data of measurement within this frequency range shown " --- " in the table above means the reading of emissions are attenuated more than 20dB below the permissible limits or the field strength is too small to be measured.
4. Measurements above show only up to 6 maximum emissions noted, or would be lesser, with " N/A " remark, if no specific emissions from the EUT are recorded (ie: margin>20dB from the applicable limit) and considered that's already beyond the background noise floor.
5. Result = Reading + Correction Factor
Margin = Result - Limit
Remark Peak = Result(PK) - Limit(AV)
Remark AVG = Result(AV) - Limit(AV)



Restricted Band Edges

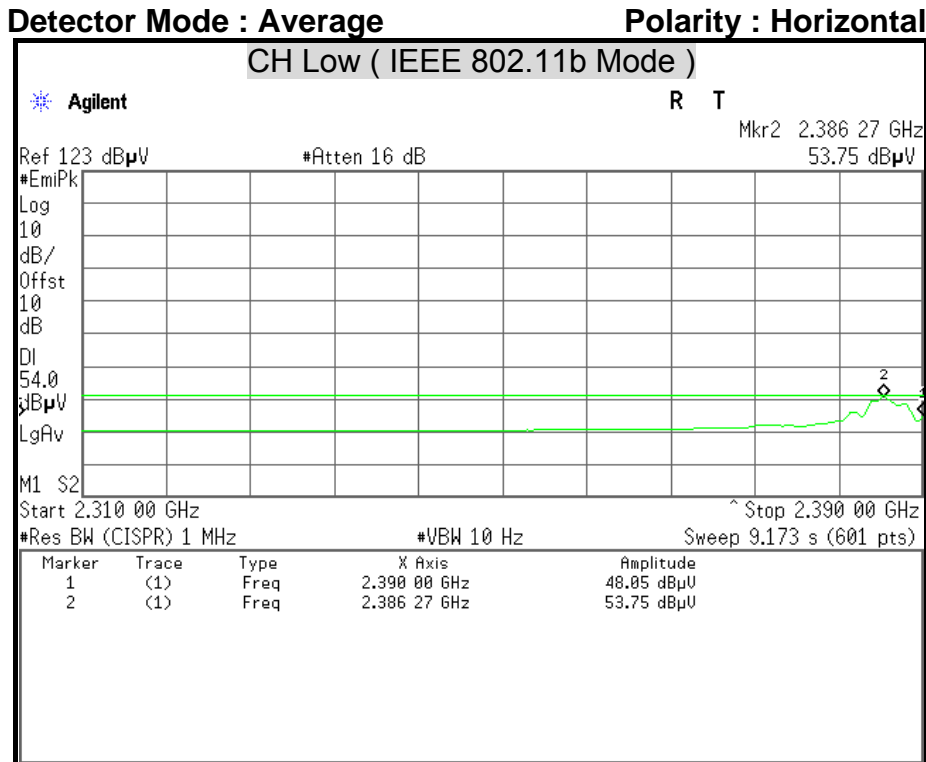
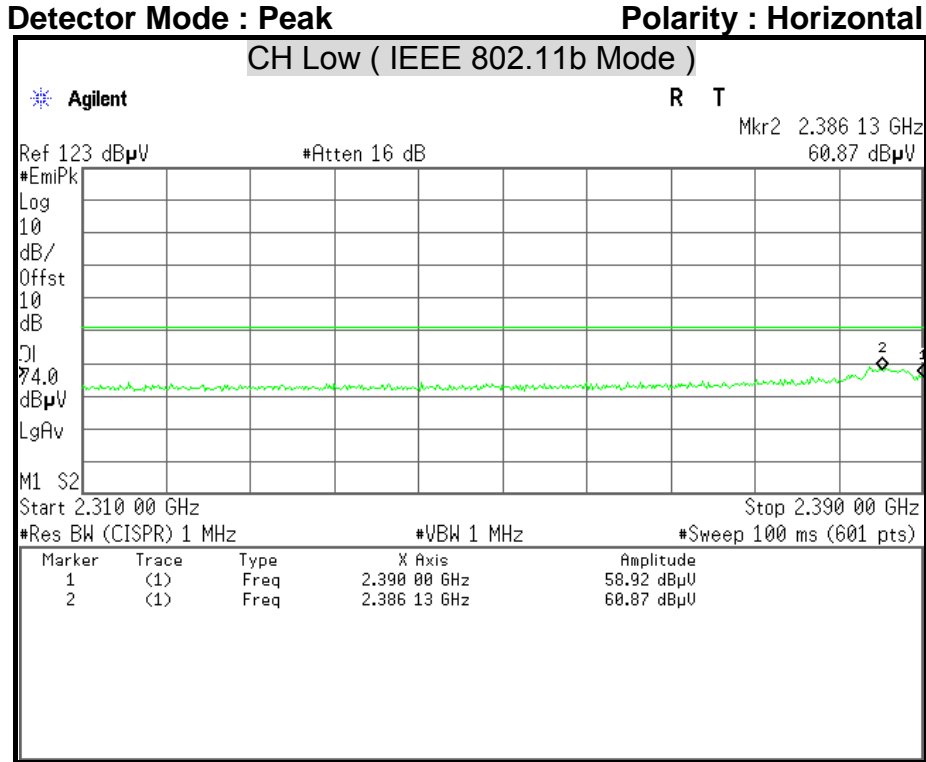



Detector Mode : Peak

Polarity : Vertical

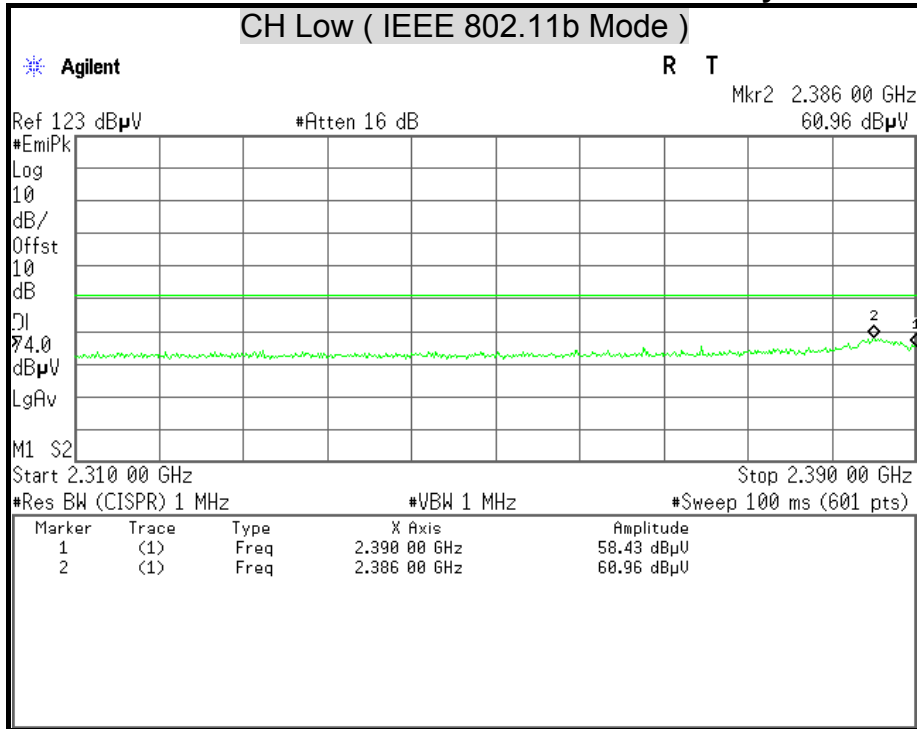

Detector Mode : Average

Polarity : Vertical

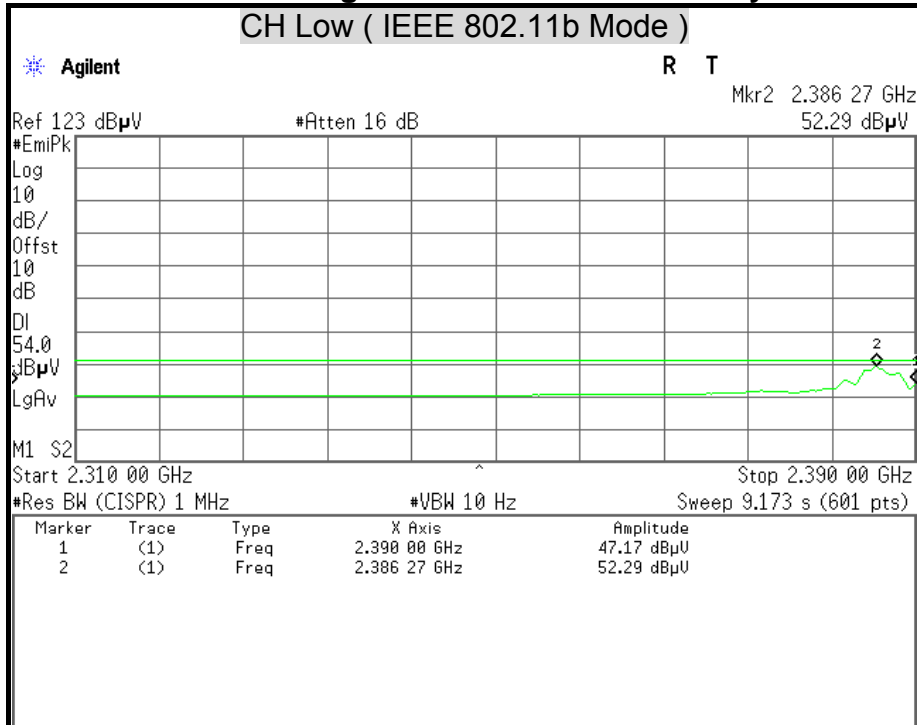



Detector Mode : Peak

Polarity : Horizontal

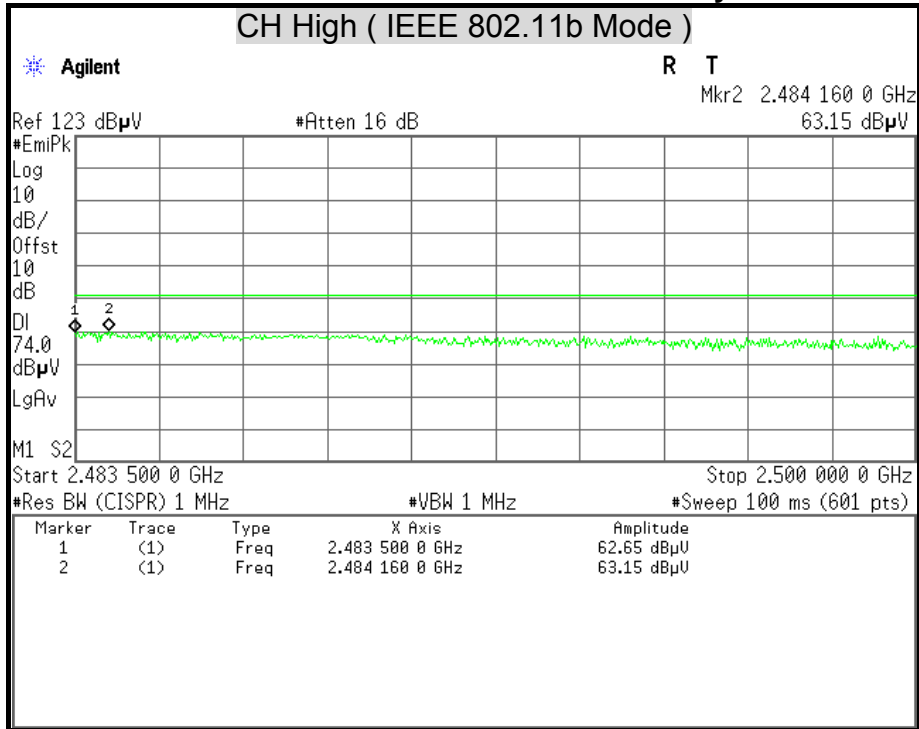

Detector Mode : Average

Polarity : Horizontal

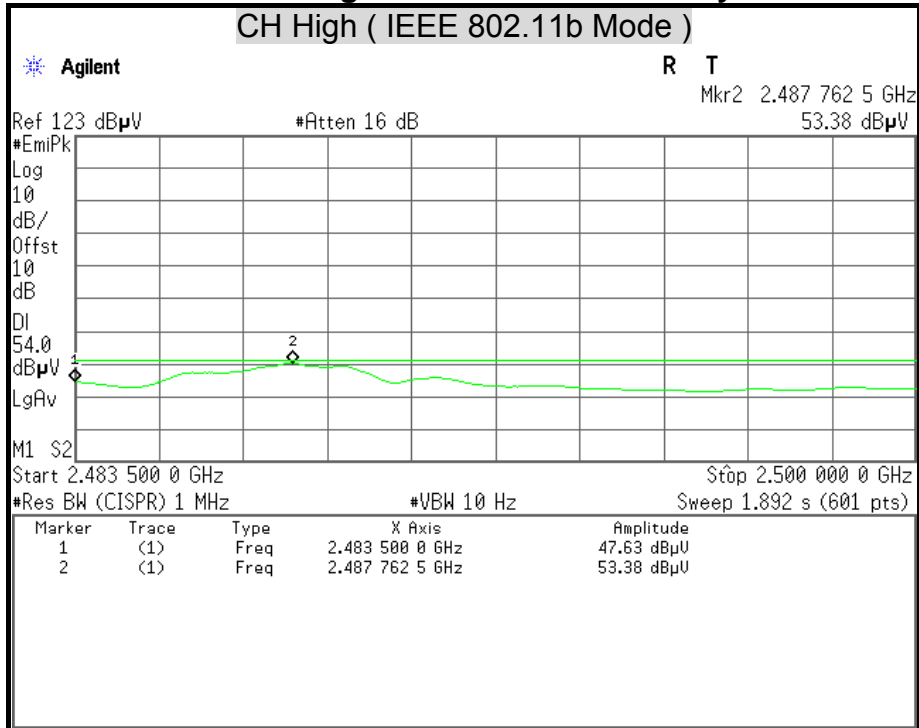



Detector Mode : Peak

Polarity : Vertical

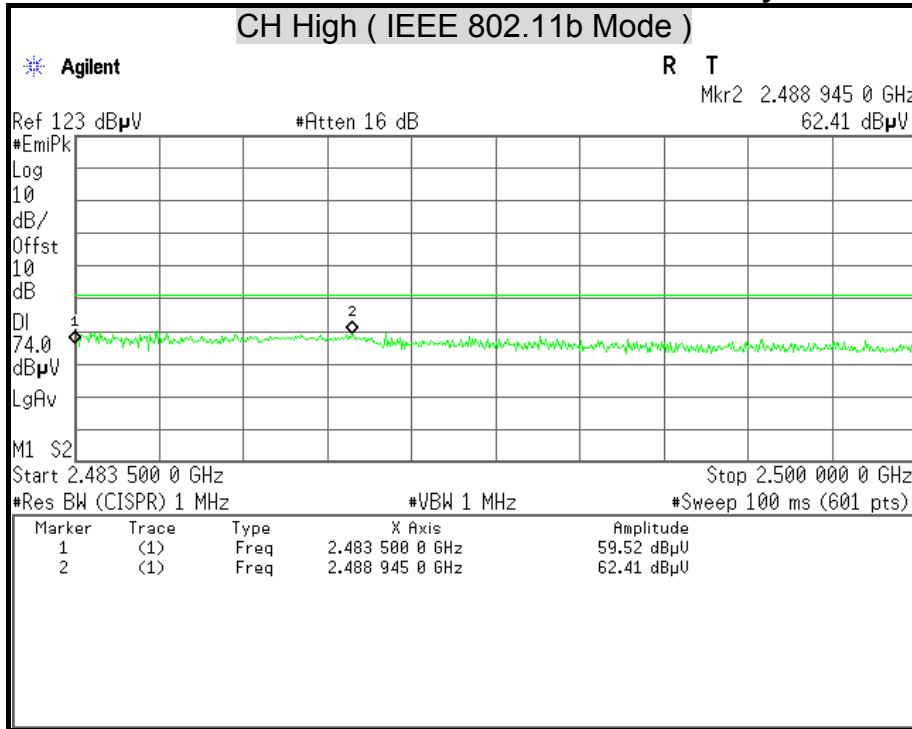

Detector Mode : Average

Polarity : Vertical

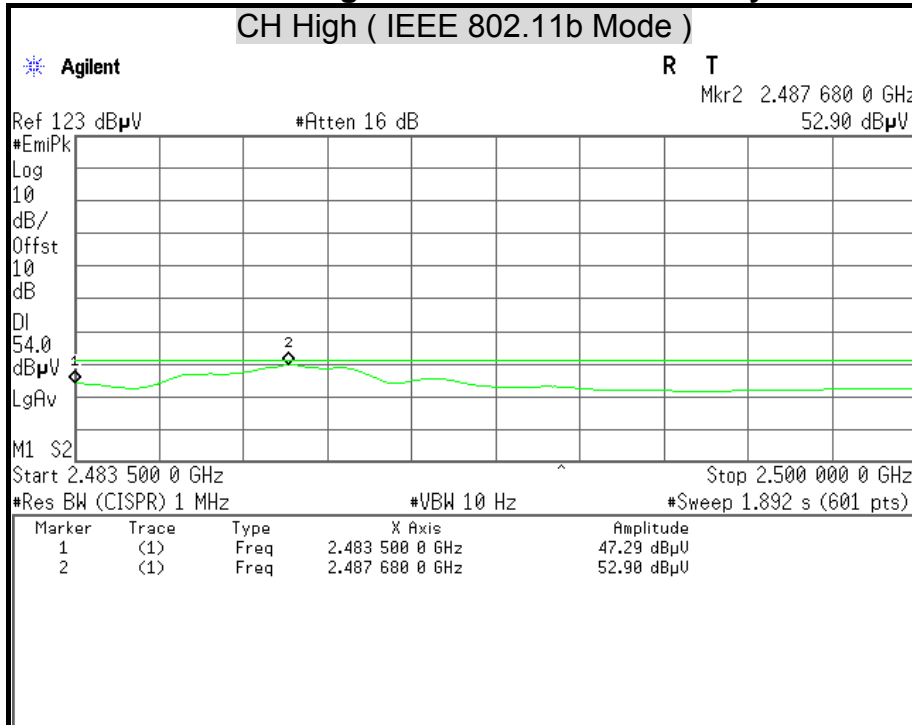



Detector Mode : Peak

Polarity : Horizontal

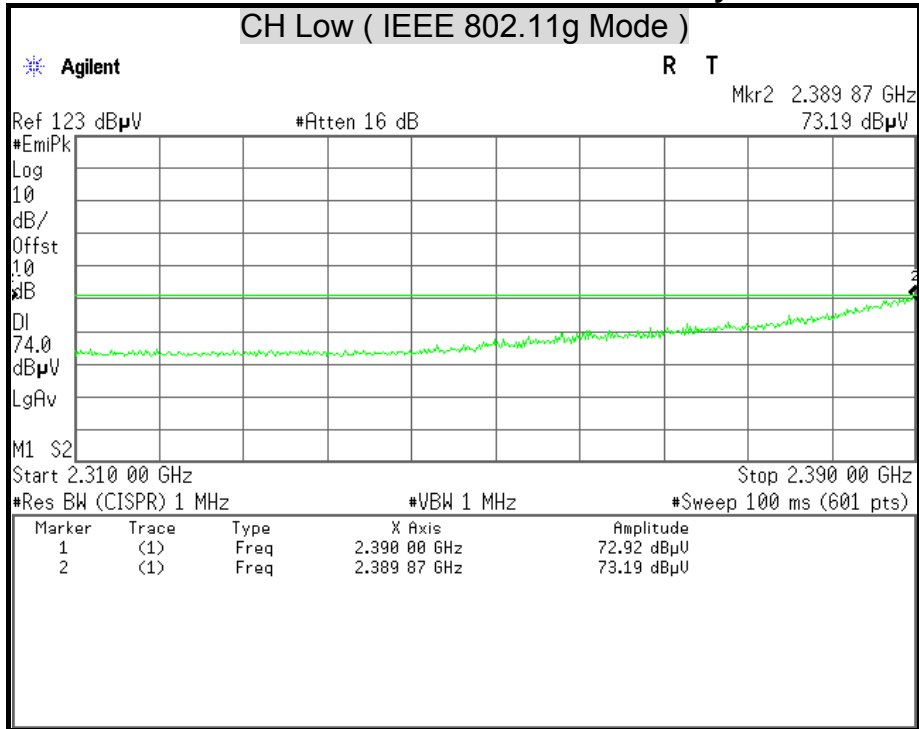

Detector Mode : Average

Polarity : Horizontal

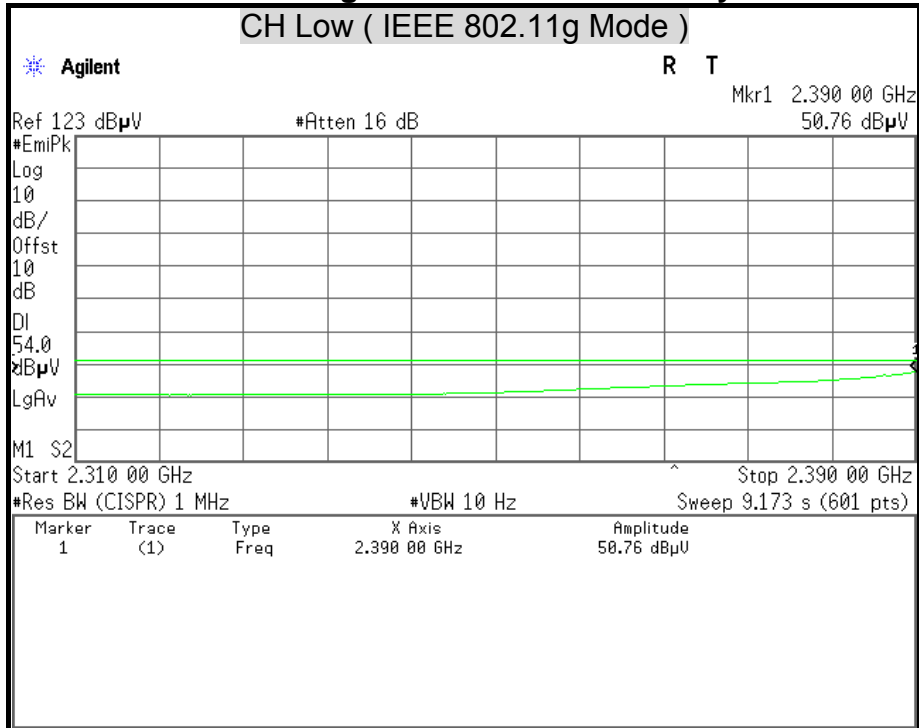



Detector Mode : Peak

Polarity : Vertical

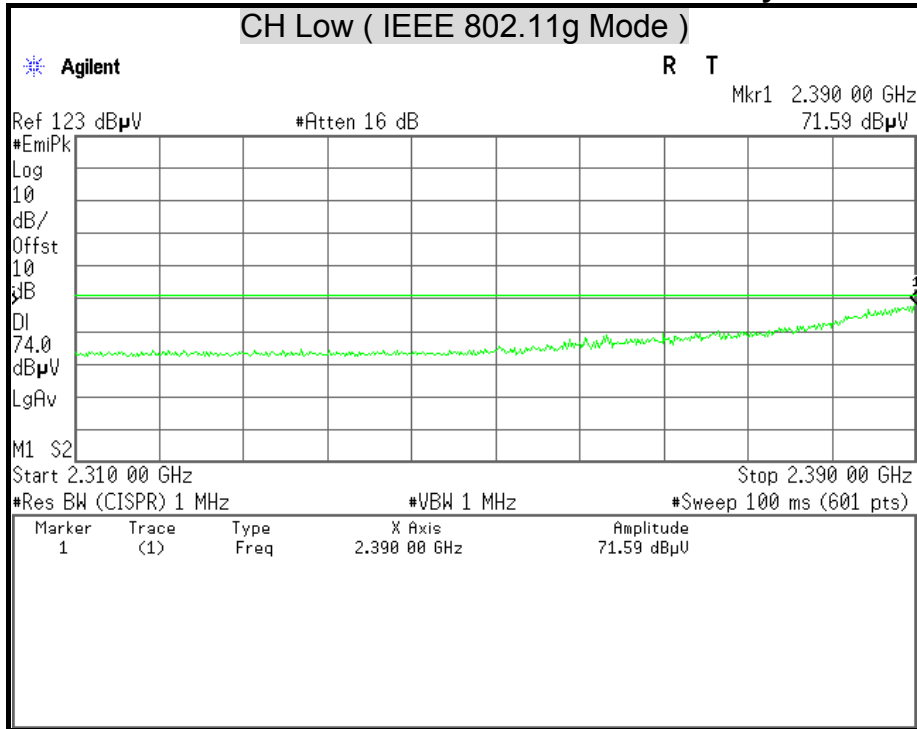

Detector Mode : Average

Polarity : Vertical

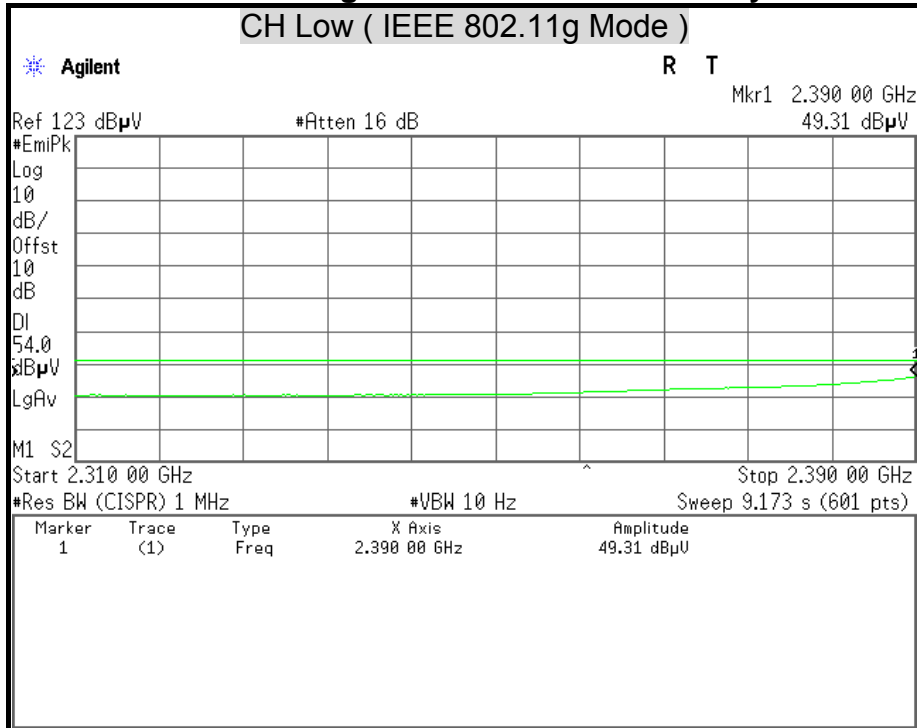



Detector Mode : Peak

Polarity : Horizontal

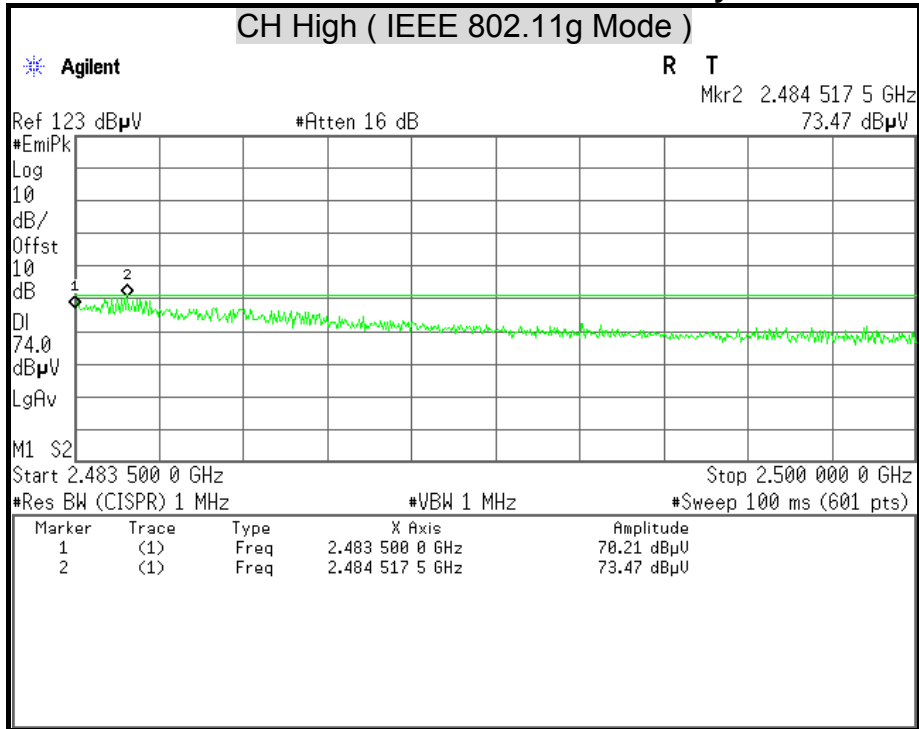

Detector Mode : Average

Polarity : Horizontal

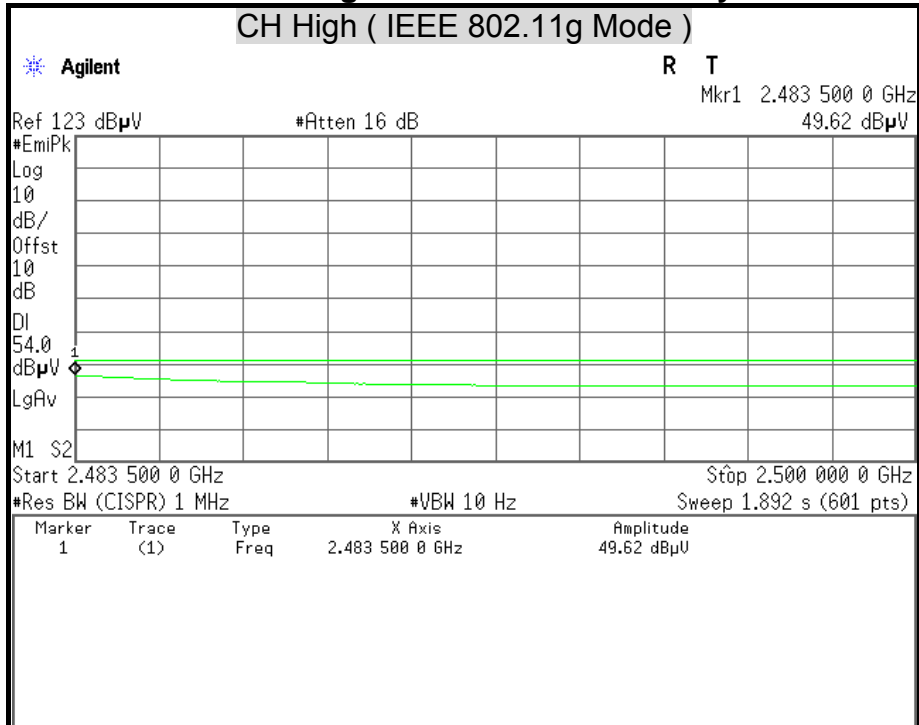



Detector Mode : Peak

Polarity : Vertical

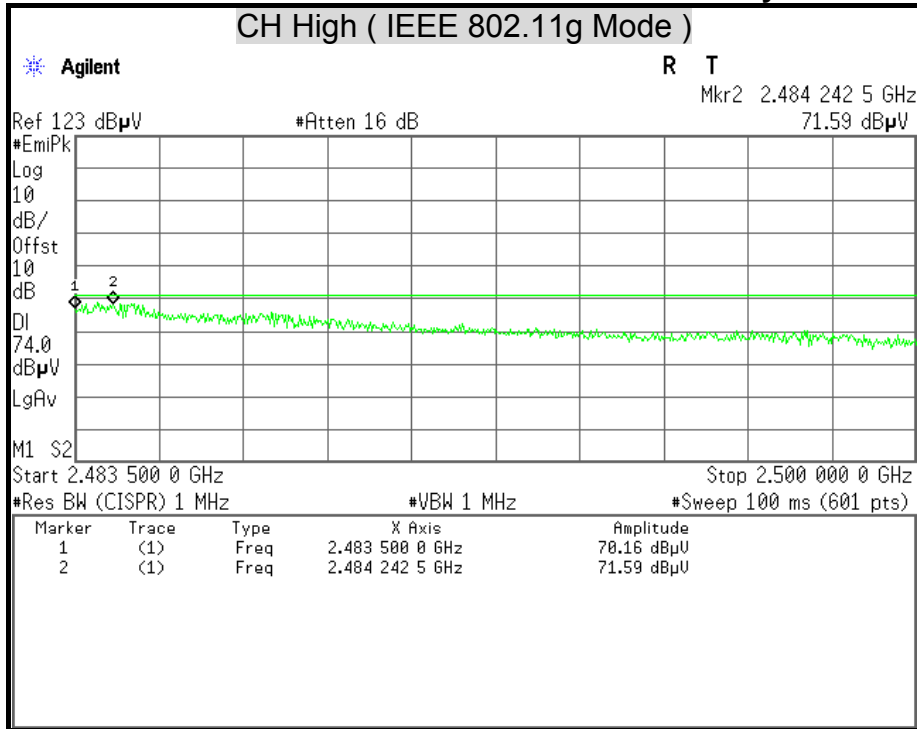

Detector Mode : Average

Polarity : Vertical

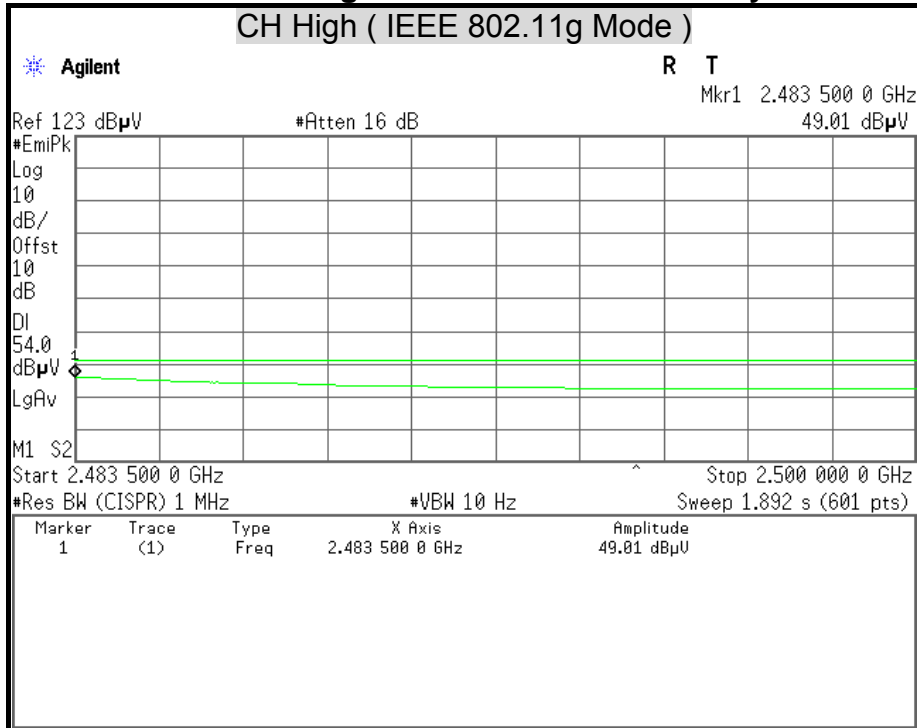



Detector Mode : Peak

Polarity : Horizontal

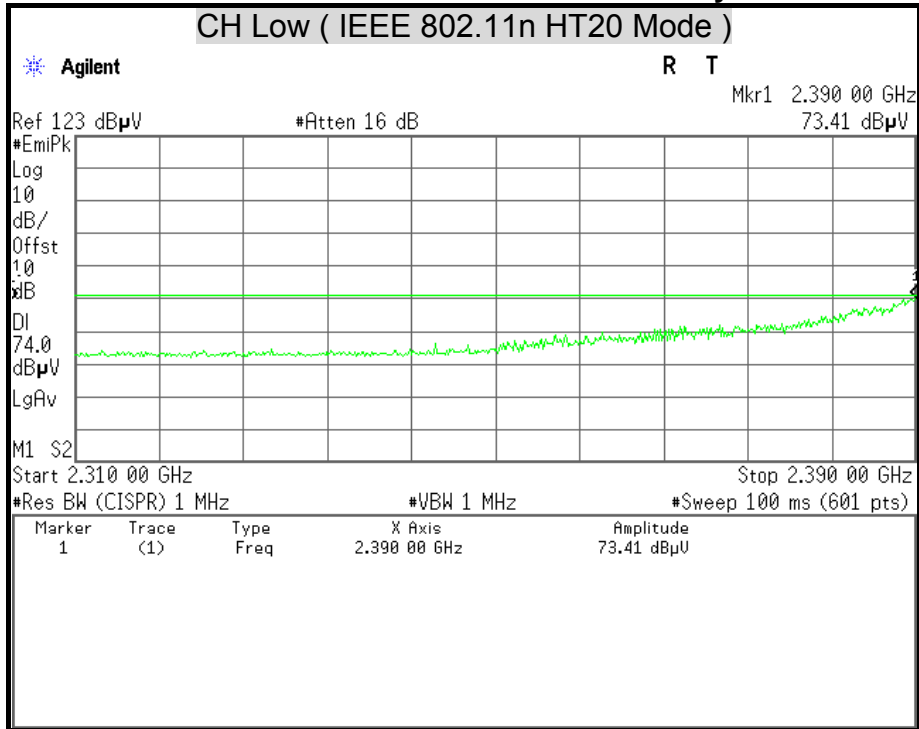

Detector Mode : Average

Polarity : Horizontal

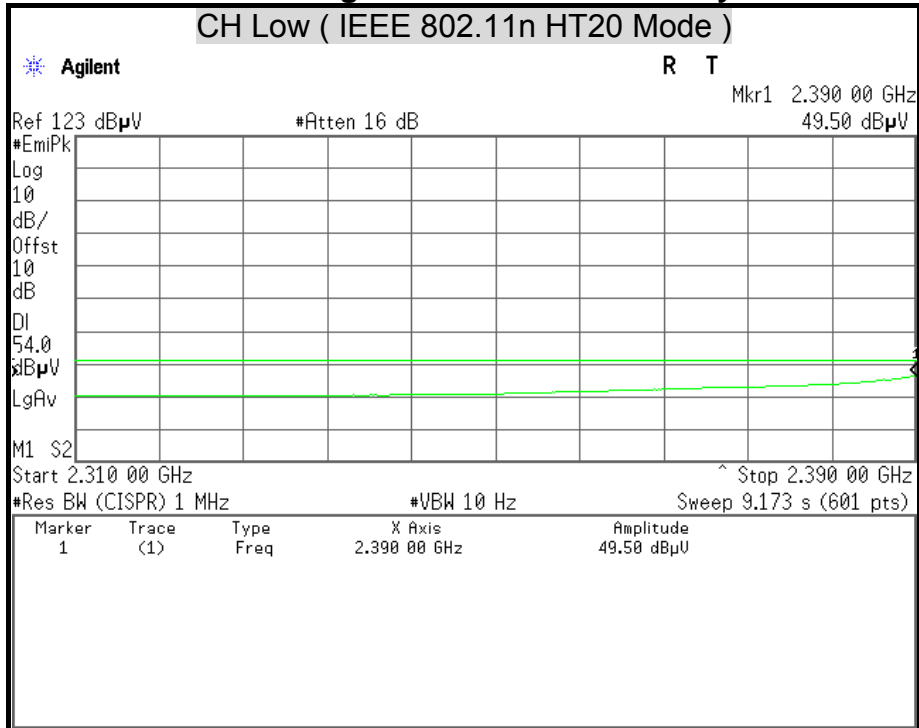



Detector Mode : Peak

Polarity : Vertical

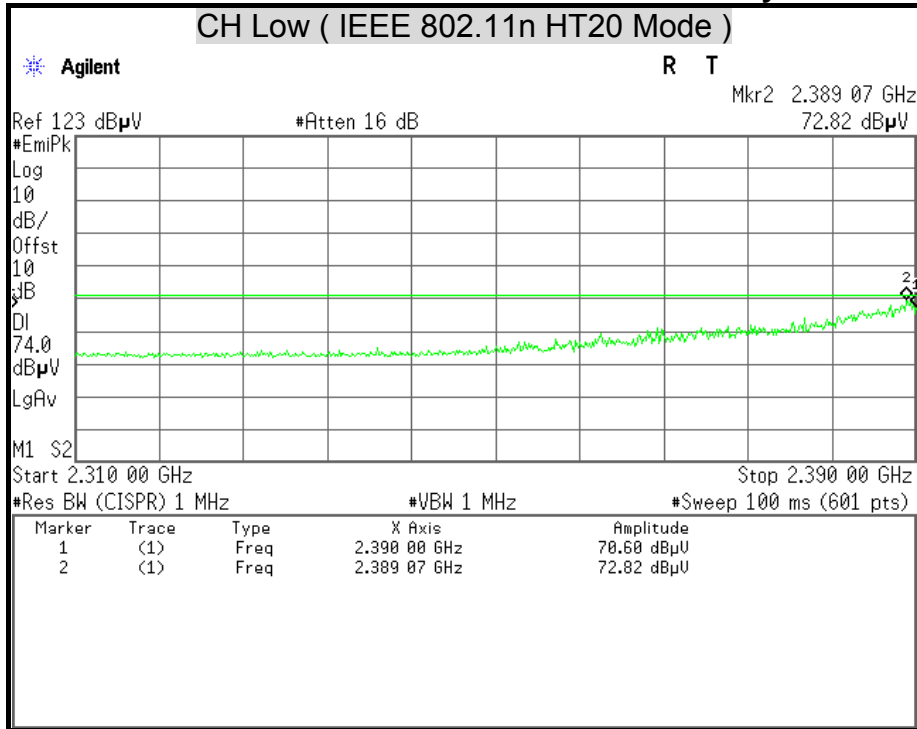

Detector Mode : Average

Polarity : Vertical

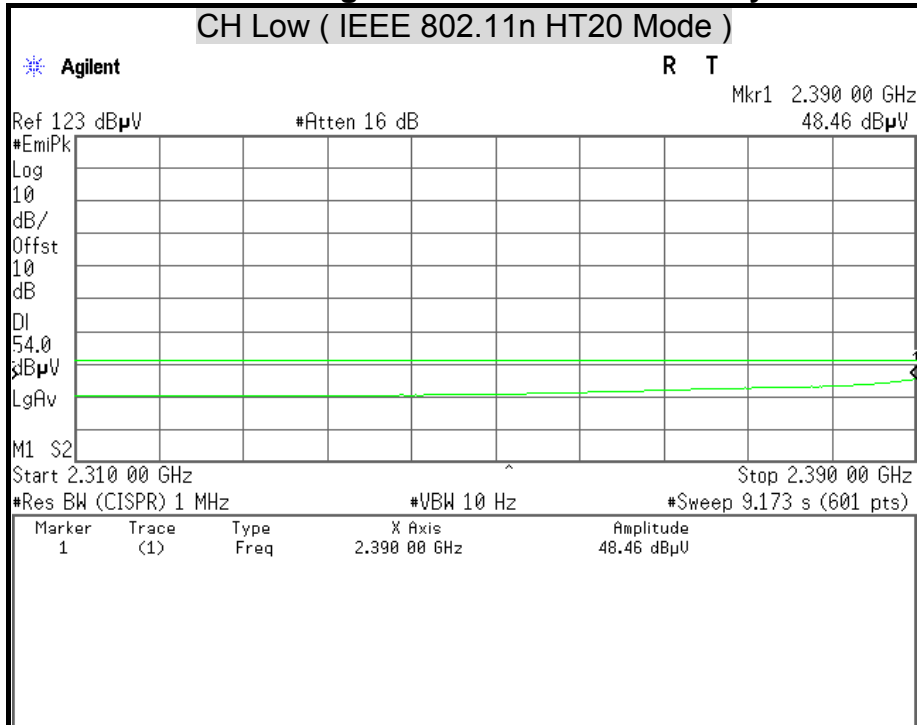



Detector Mode : Peak

Polarity : Horizontal

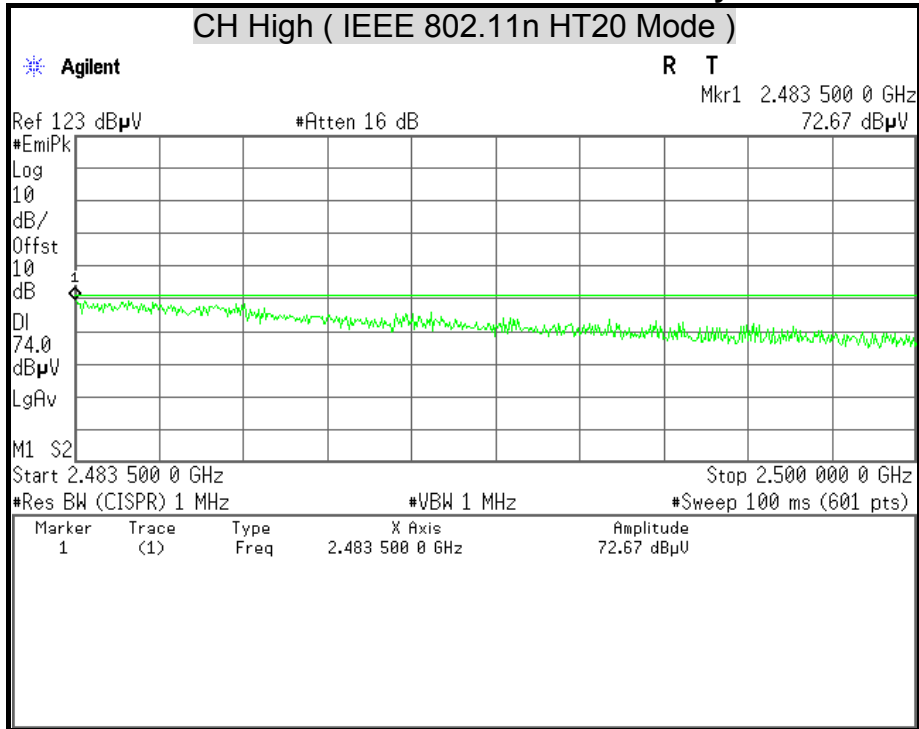

Detector Mode : Average

Polarity : Horizontal

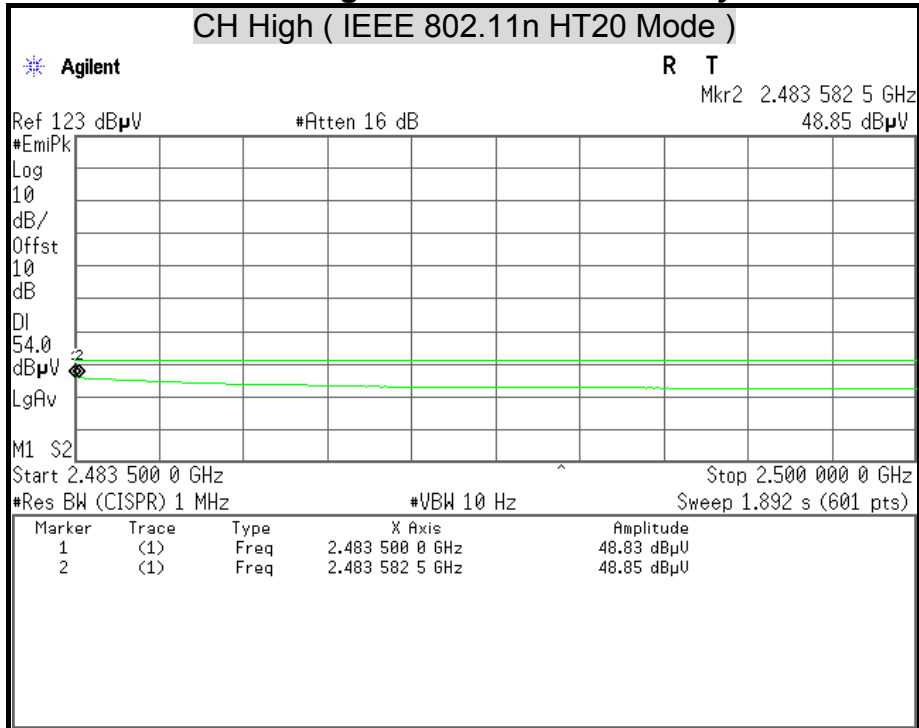



Detector Mode : Peak

Polarity : Vertical

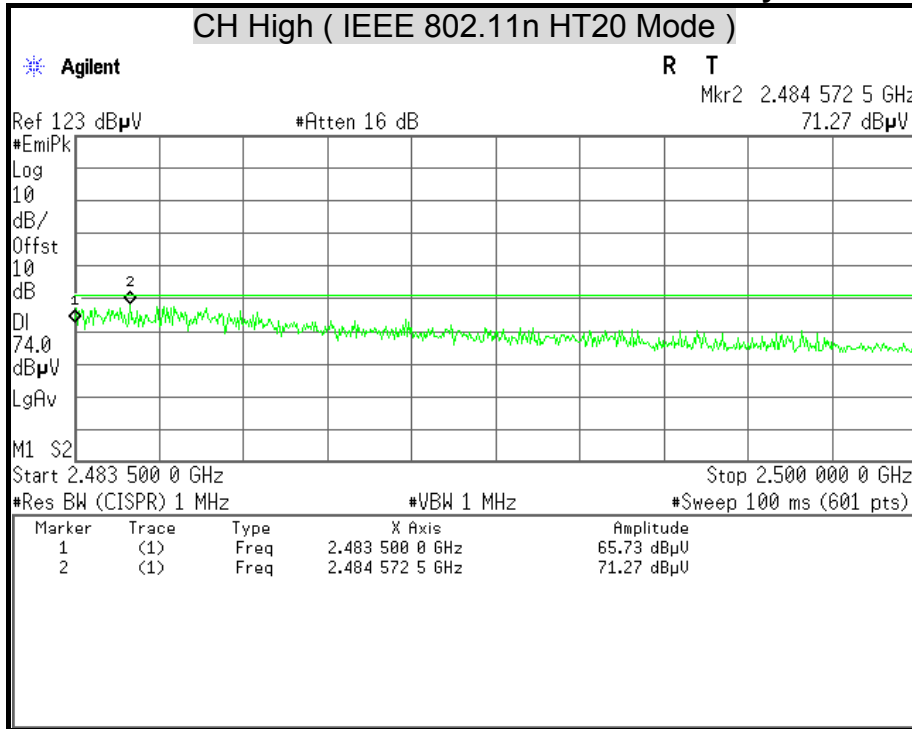

Detector Mode : Average

Polarity : Vertical

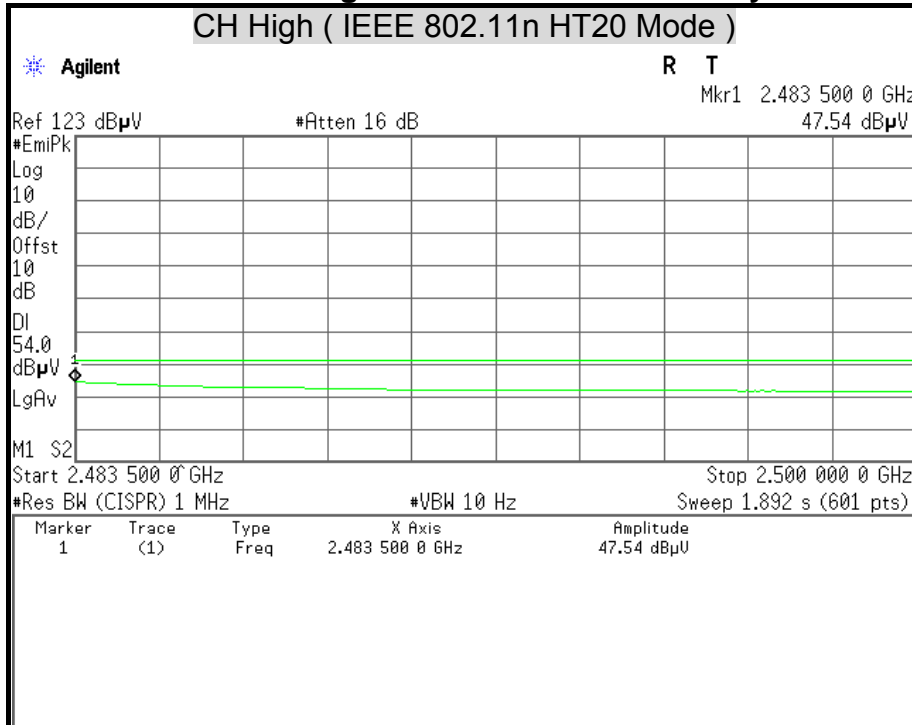



Detector Mode : Peak

Polarity : Horizontal

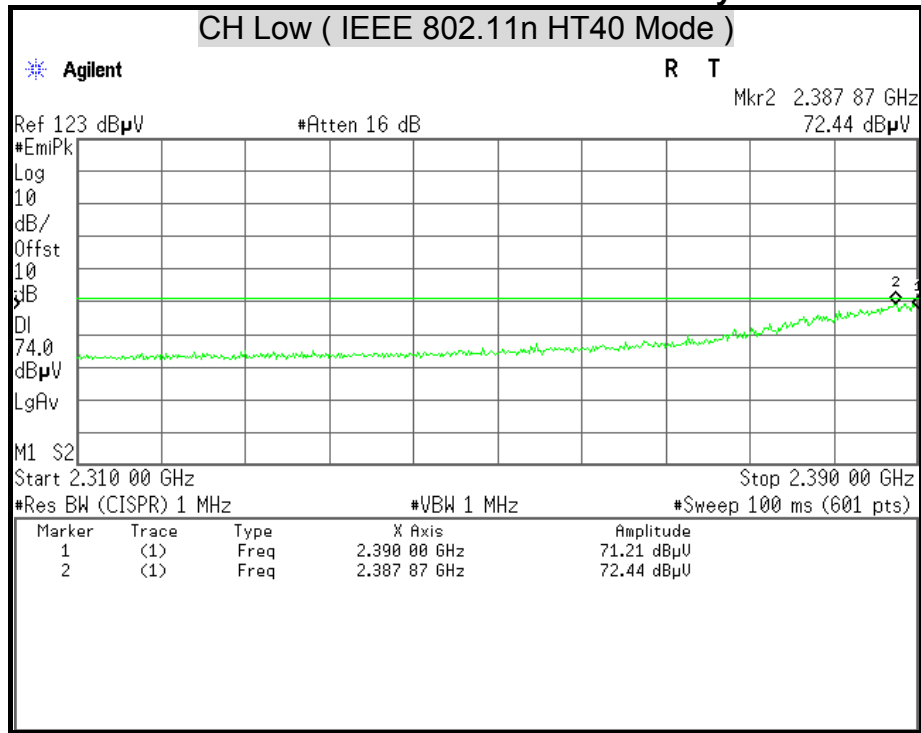

Detector Mode : Average

Polarity : Horizontal

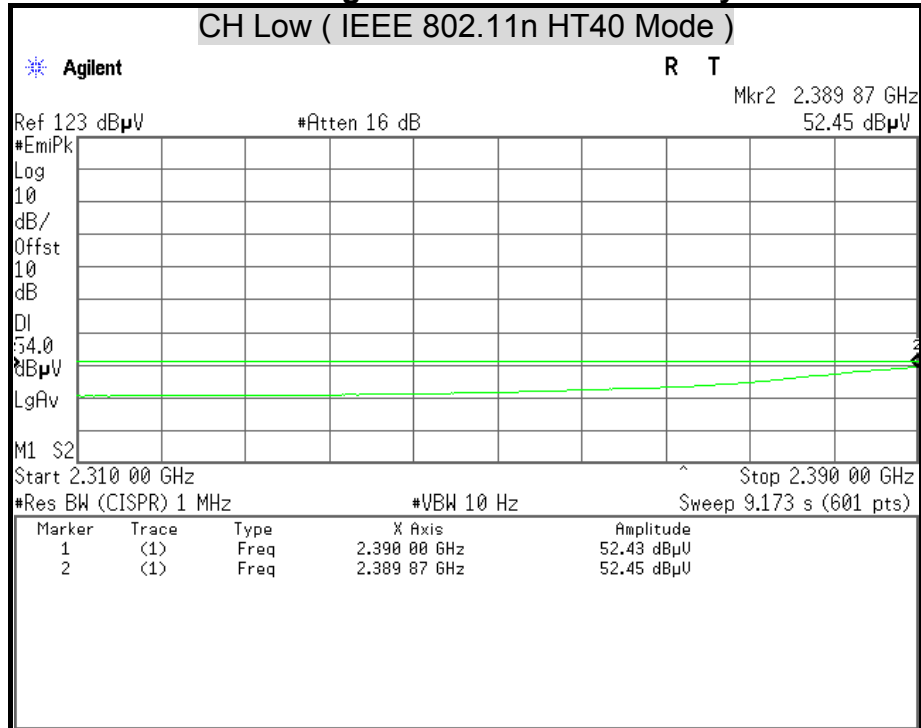



Detector Mode : Peak

Polarity : Vertical

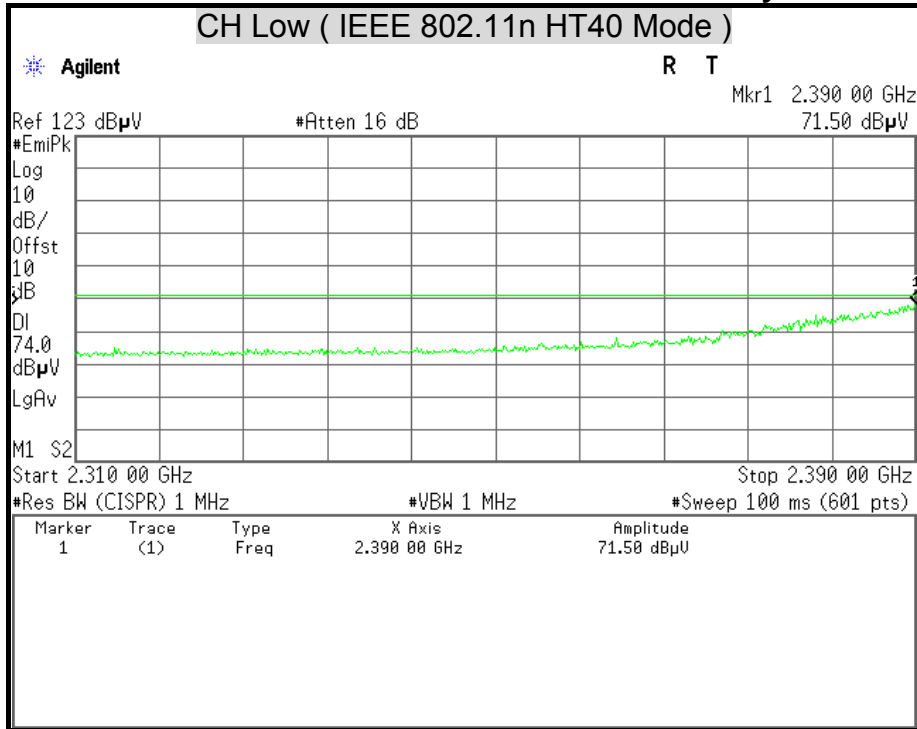

Detector Mode : Average

Polarity : Vertical

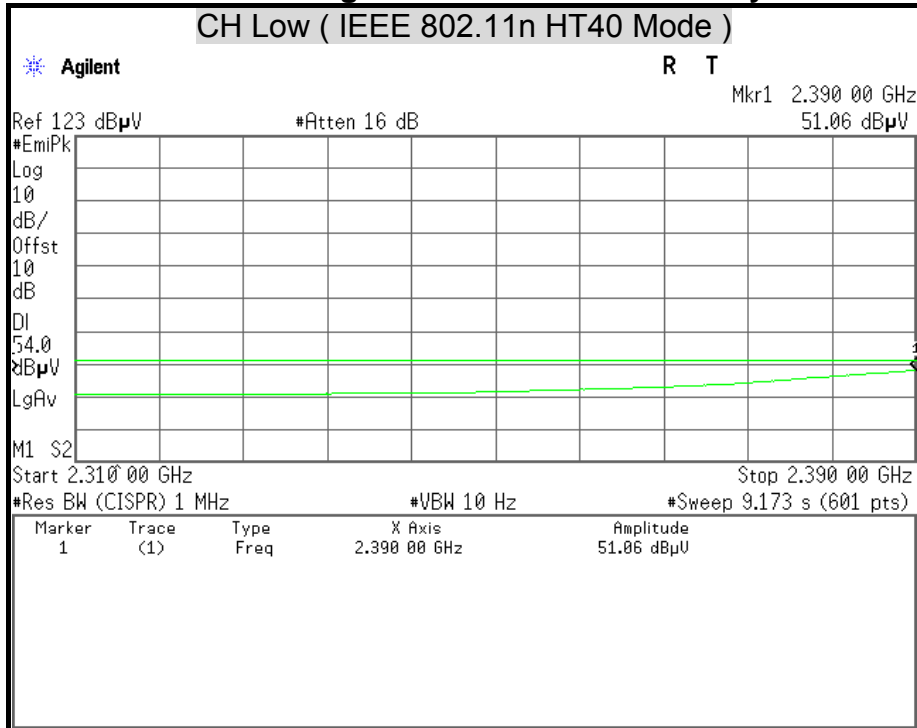



Detector Mode : Peak

Polarity : Horizontal

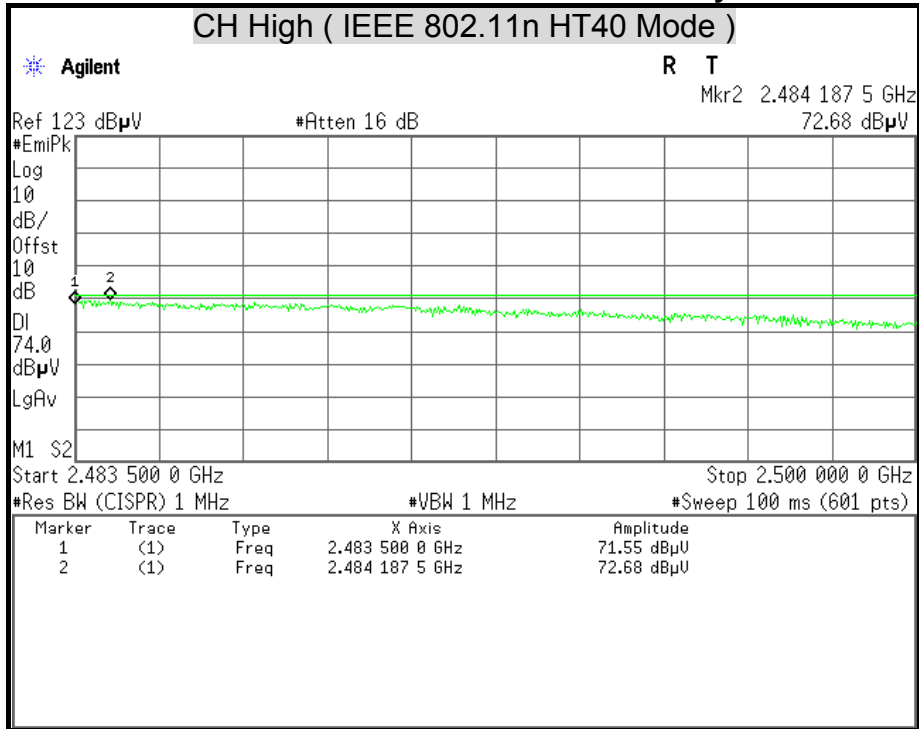

Detector Mode : Average

Polarity : Horizontal

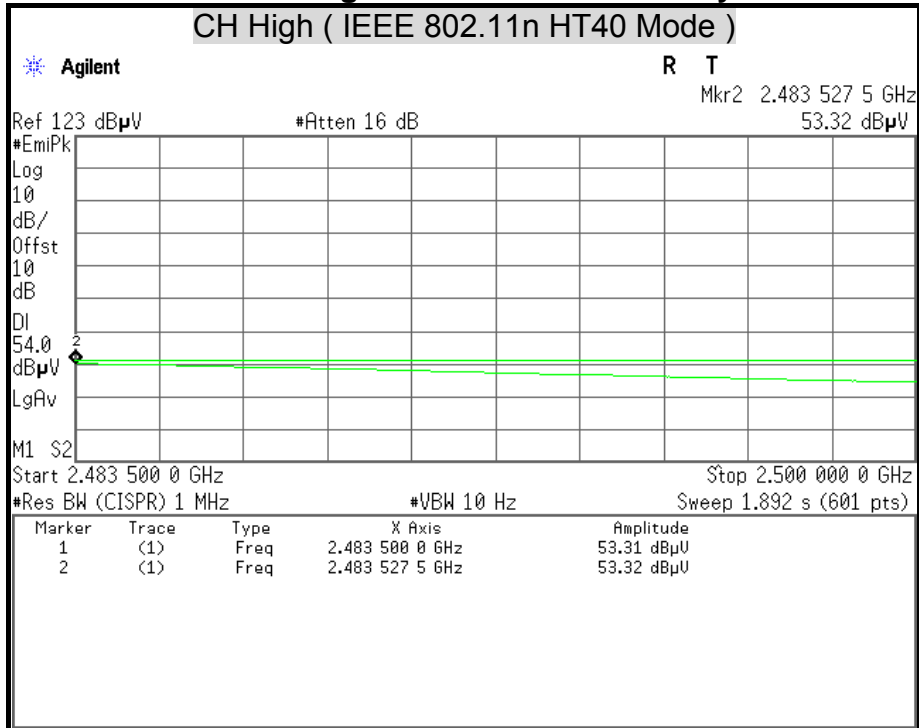



Detector Mode : Peak

Polarity : Vertical

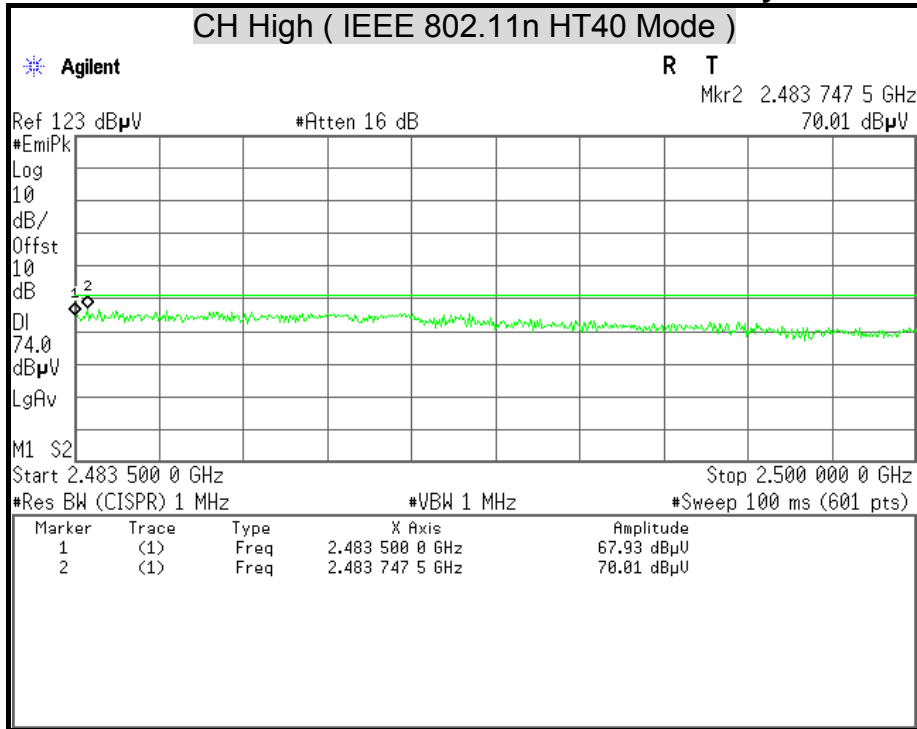

Detector Mode : Average

Polarity : Vertical

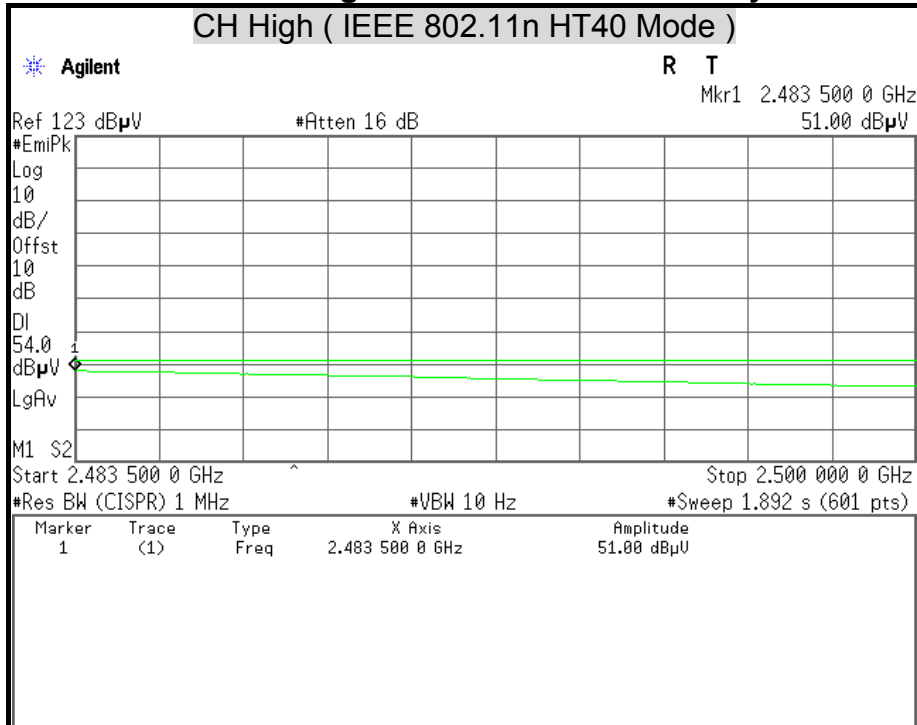



Detector Mode : Peak

Polarity : Horizontal

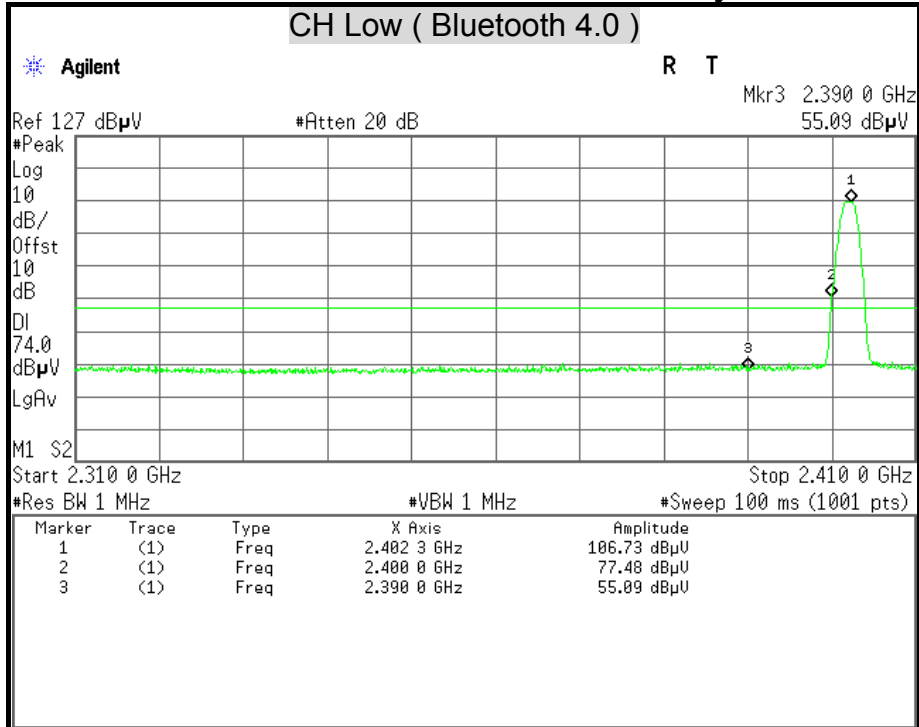

Detector Mode : Average

Polarity : Horizontal

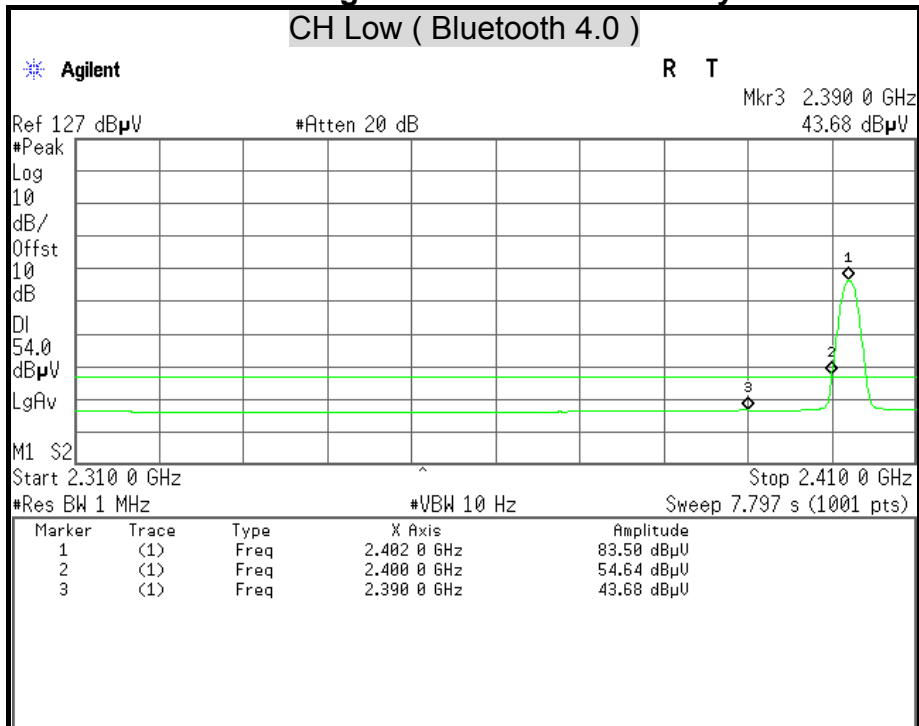



Detector Mode : Peak

Polarity : Vertical

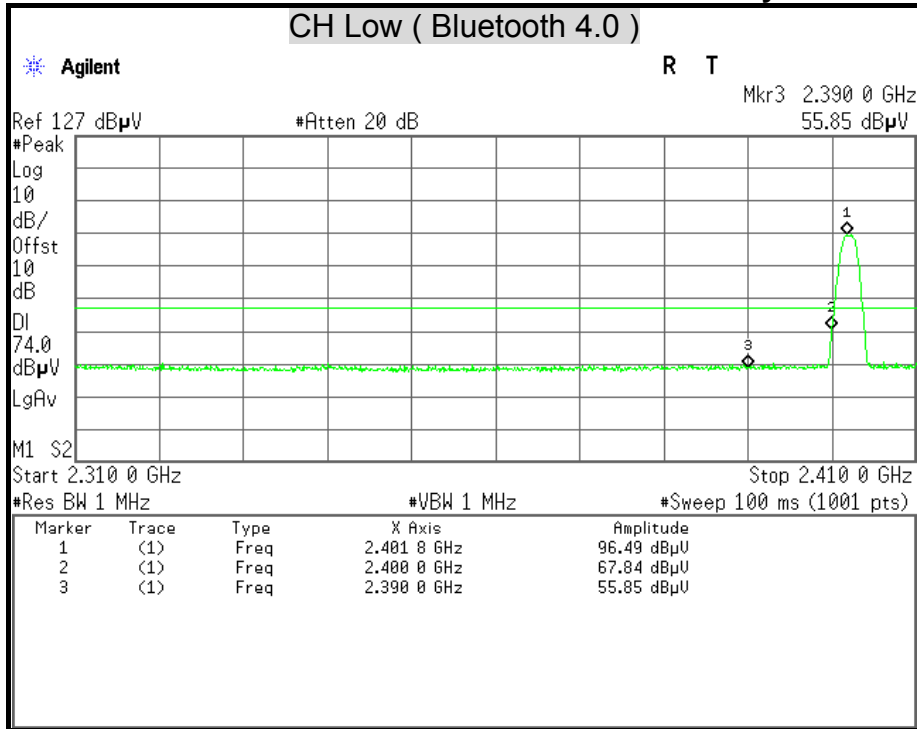

Detector Mode : Average

Polarity : Vertical

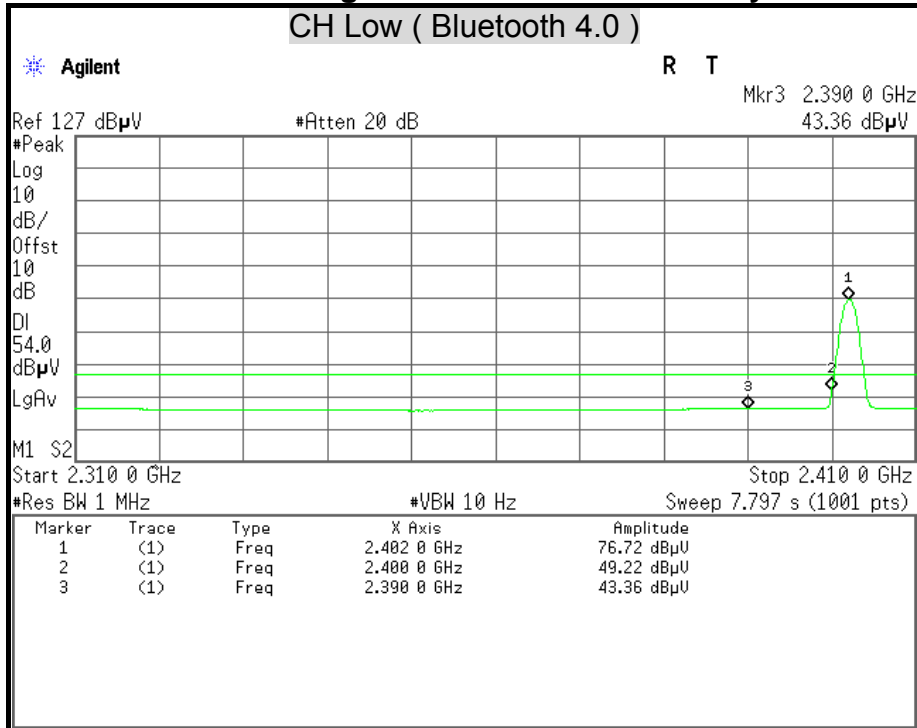



Detector Mode : Peak

Polarity : Horizontal

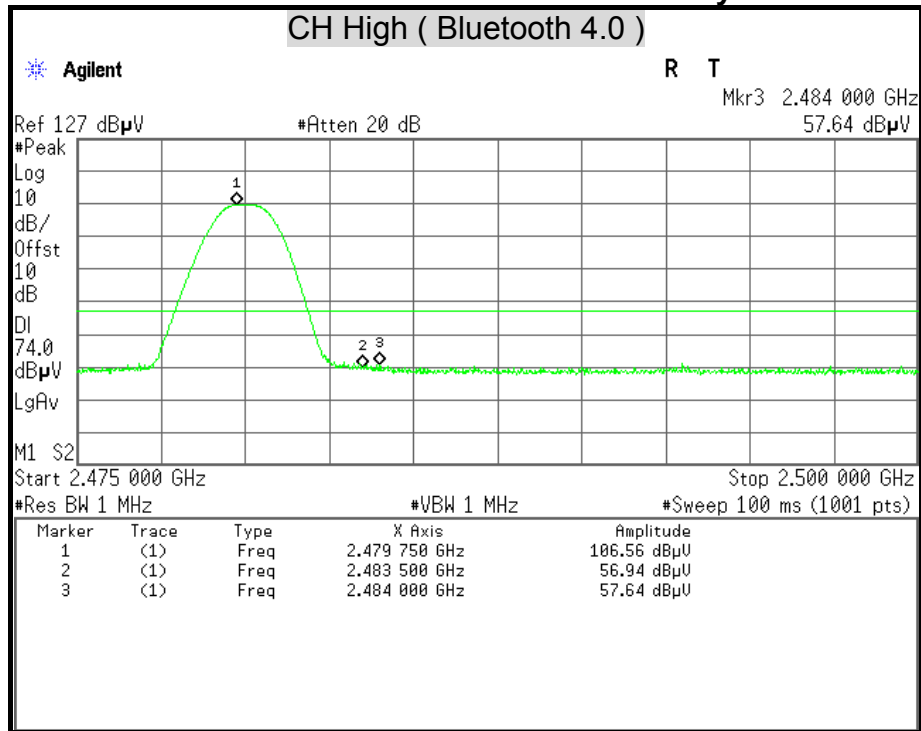

Detector Mode : Average

Polarity : Horizontal

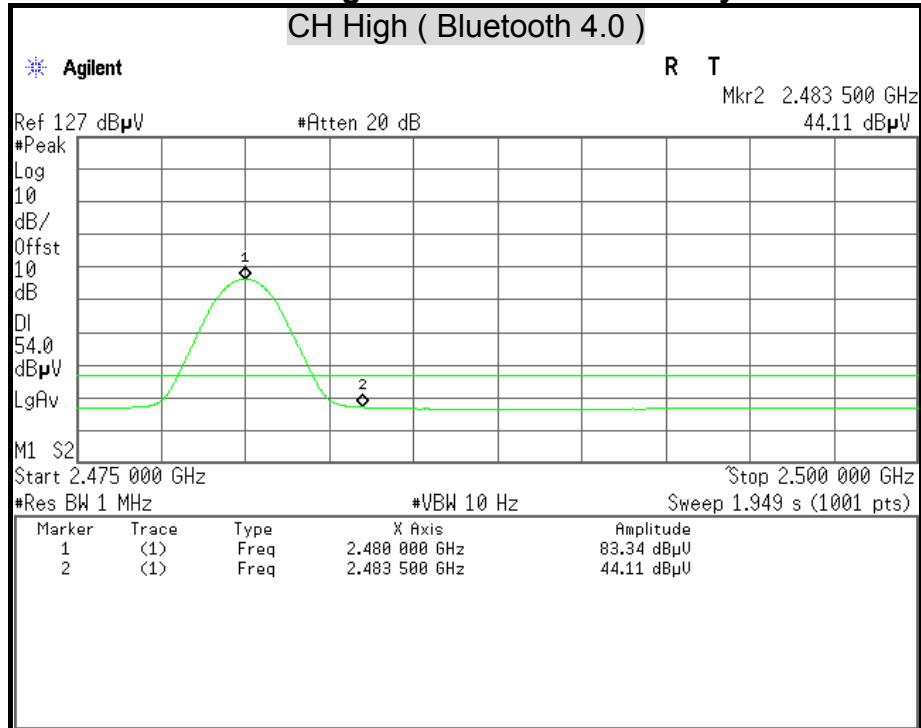



Detector Mode : Peak

Polarity : Vertical

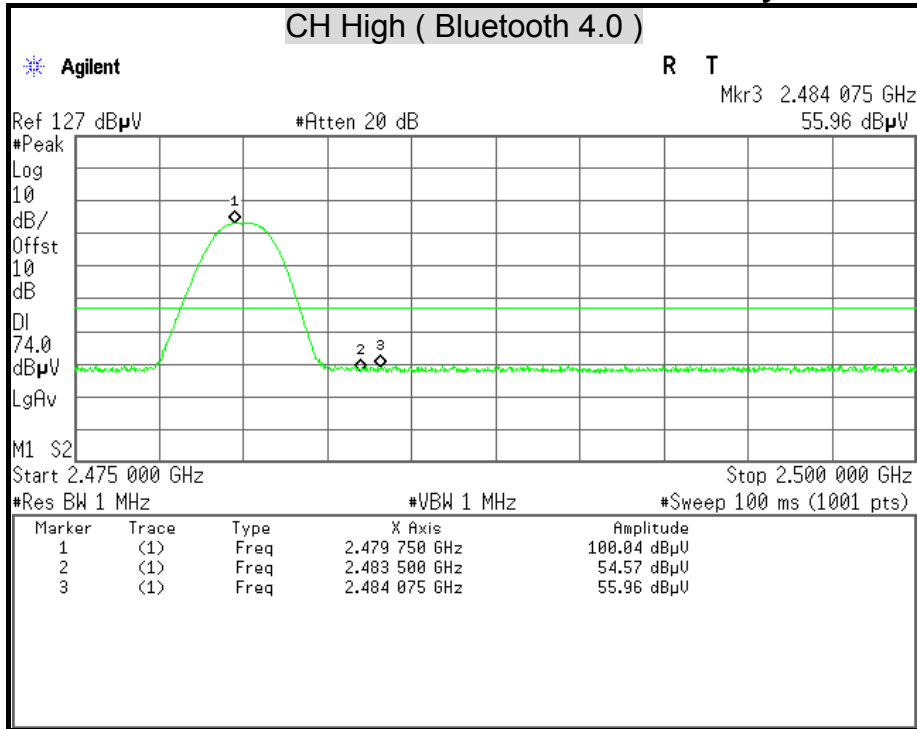

Detector Mode : Average

Polarity : Vertical

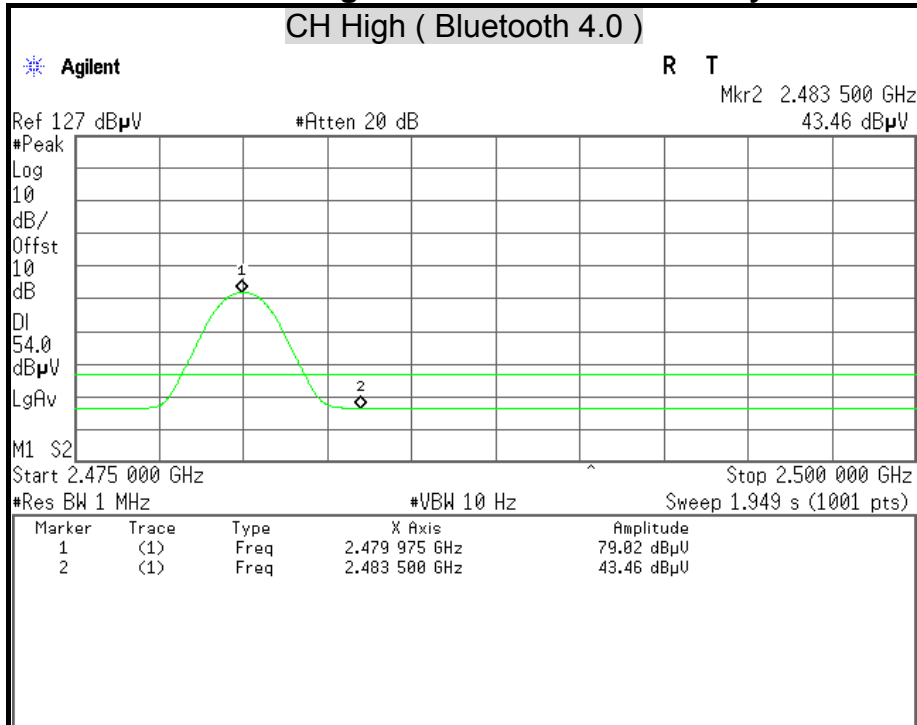



7.7 CONDUCTED EMISSION

LIMITS

§ 15.207 (a) Except as shown in paragraph (b) and (c) this section, for an intentional radiator that is designed to be connected to the public utility (AC) power line, the radio frequency voltage that is conducted back onto the AC power line on any frequency or frequencies within the band 150 kHz to 30 MHz shall not exceed the limits in the following table, as measured using a 50 μ H/50 ohms line impedance stabilization network (LISN). Compliance with the provisions of this paragraph shall be based on the measurement of the radio frequency voltage between each power line and ground at the power terminal. The lower limit applies at the boundary between the frequency ranges.

Frequency Range (MHz)	Conducted Limit (dB μ v)	
	Quasi-peak	Average
0.15 - 0.50	66 to 56	56 to 46
0.50 - 5.00	56	46
5.00 - 30.0	60	50

TEST EQUIPMENT

Name of Equipment	Manufacturer	Model	Serial Number	Calibration Due
L.I.S.N	SCHWARZBECK	NSLK 8127	8127-465	08/11/2014
L.I.S.N	SCHWARZBECK	NSLK 8127	8127-473	03/10/2015
EMI Receiver	ROHDE & SCHWARZ	ESCS 30	835418/008	10/16/2014
Pulse Limiter	ROHDE & SCHWARZ	ESH3-Z2	100117	07/01/2014

Remark: Each piece of equipment is scheduled for calibration once a year.



TEST SETUP

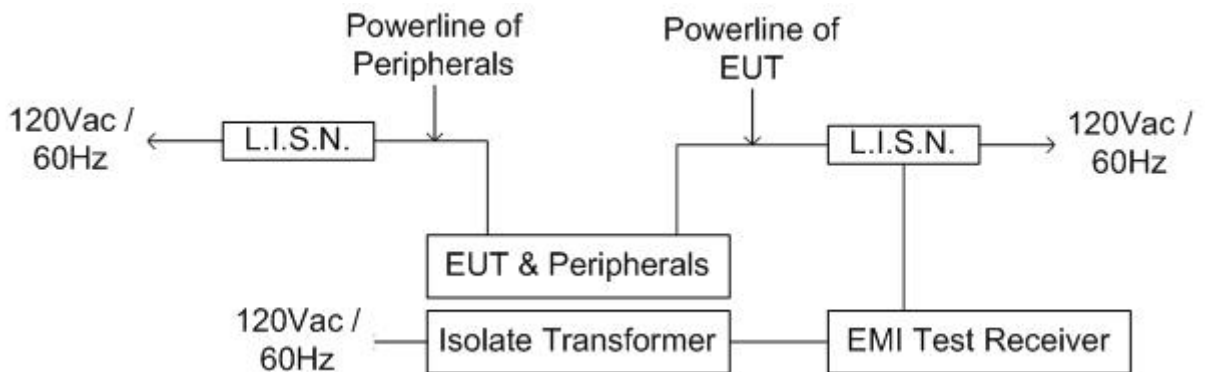
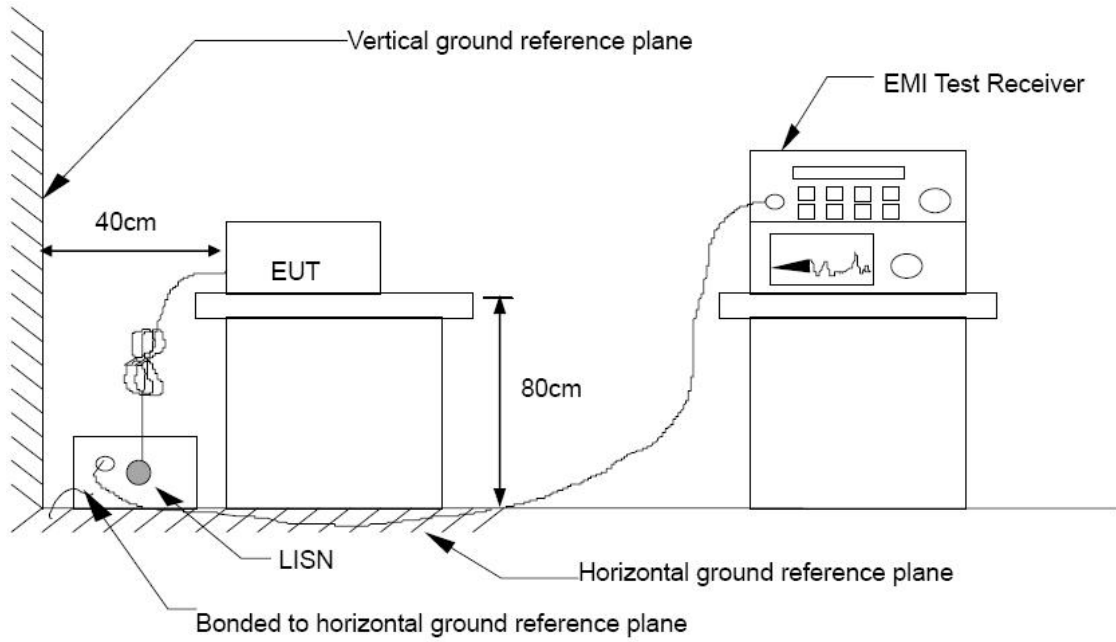



TEST PROCEDURE

The basic test procedure was in accordance with ANSI C63.4:2009.

The test procedure is performed in a 4m × 3m × 2.4m (L×W×H) shielded room.

The EUT along with its peripherals were placed on a 1.0m (W) × 1.5m (L) and 0.8m in height wooden table and the EUT was adjusted to maintain a 0.4 meter space from a vertical reference plane.

The EUT was connected to power mains through a line impedance stabilization network (LISN) which provides 50 ohm coupling impedance for measuring instrument and the chassis ground was bounded to the horizontal ground plane of shielded room. All peripherals were connected to the second LISN and the chassis ground also bounded to the horizontal ground plane of shielded room.

The EUT was located so that the distance between the boundary of the EUT and the closest surface of the LISN is 0.8 m. Where a mains flexible cord was provided by the manufacturer shall be 1 m long, or if in excess of 1 m, the excess cable was folded back and forth as far as possible so as to form a bundle not exceeding 0.4 m in length.



TEST RESULTS

Product Name	DreamTab HD8	Test By	Alan Wu
Test Model	DMTAB-IN08A	Test Date	2014/03/26
Test Mode	Charge Mode + Play Video	Temp. & Humidity	21 °C, 50%

LINE

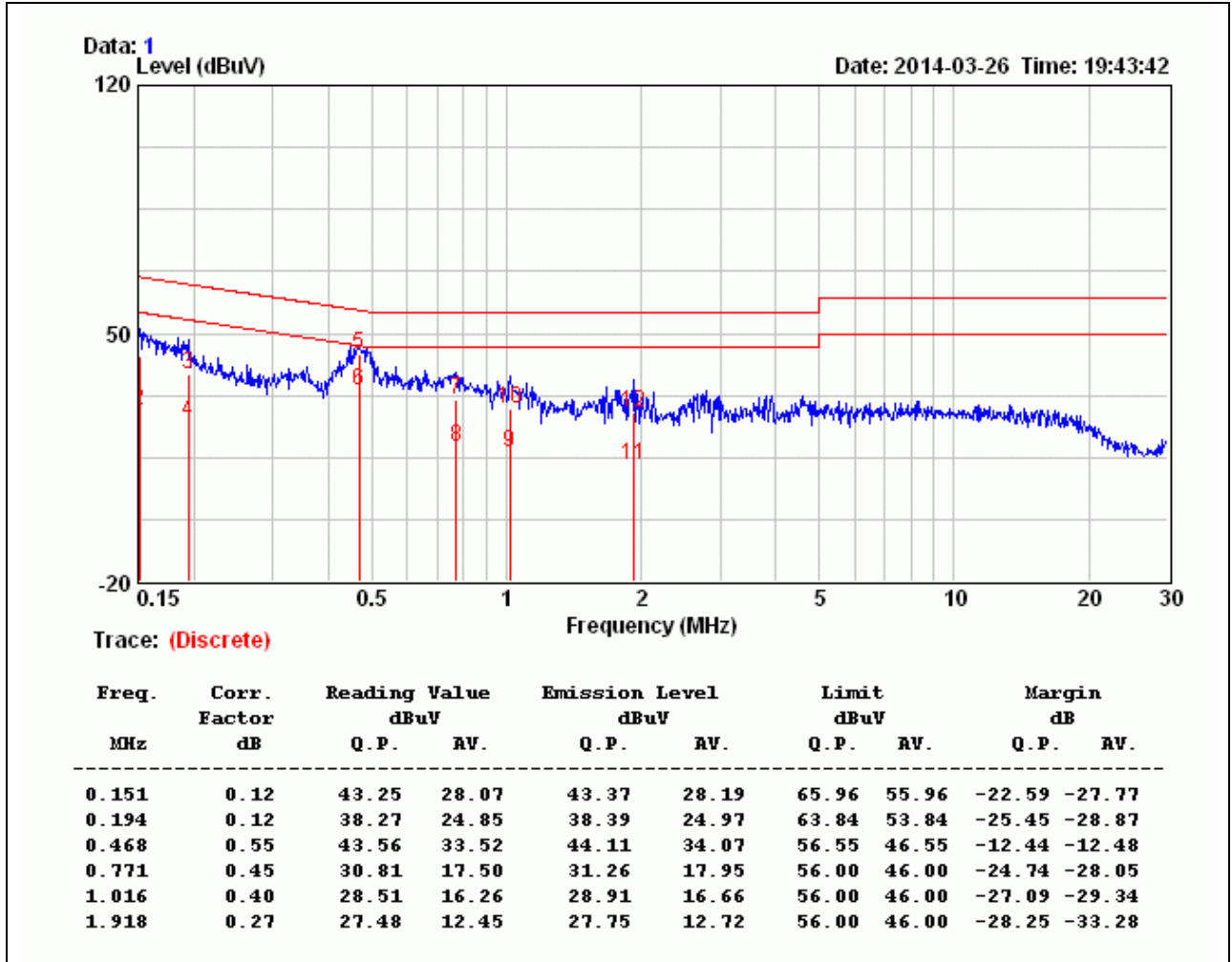

Remark:

1. Correction Factor = Insertion loss + Cable loss
2. Emission level = Reading Value + Correction factor
3. Margin value = Emission level – Limit value



Product Name	DreamTab HD8	Test By	Alan Wu
Test Model	DMTAB-IN08A	Test Date	2014/03/26
Test Mode	Charge Mode + Play Video	Temp. & Humidity	21°C, 50%

NEUTRAL

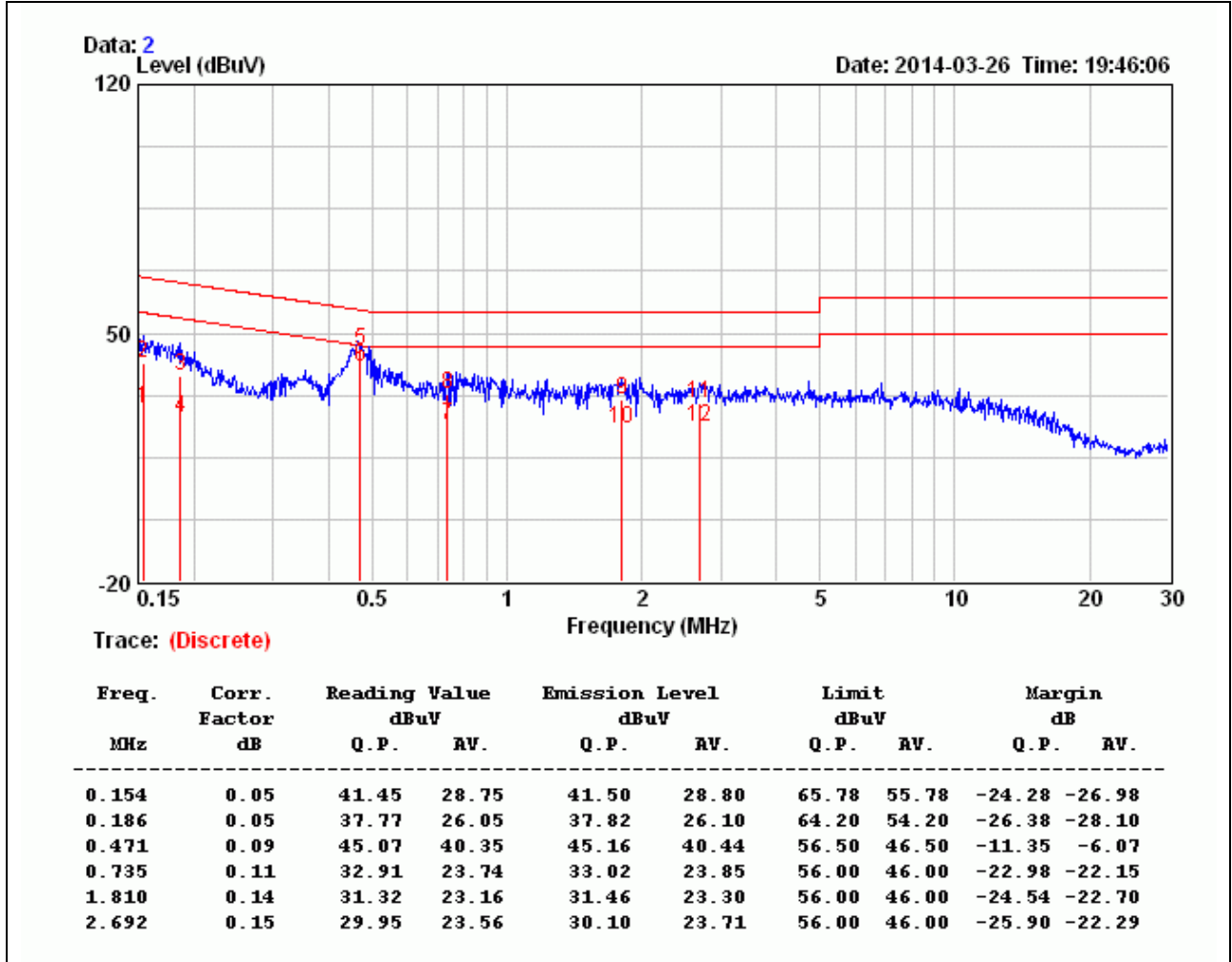

Remark:

1. Correction Factor = Insertion loss + Cable loss
2. Emission level = Reading Value + Correction factor
3. Margin value = Emission level - Limit value