

# FCC&IC DFS Test Report

## FCC ID: SIB-BGTAB-NV24A

## IC: 6719D-BGTABNV24A

This report concerns (check one):  Original Grant  Class I Change

**Project No.** : 1406C178  
**Equipment** : dreamtab  
**Model Name** : BGTAB-NV24A  
**Applicant** : Foxconn International Inc  
**Address** : NO 2 ZIYOU ST TUCHENG DISTRICT NEW  
TAIPEI,236 Taiwan

**Date of Receipt** : Jun. 24, 2014  
**Date of Test** : Jun. 24, 2014~ Aug. 08, 2014  
**Issued Date** : Aug. 11, 2014  
**Tested by** : BTL Inc.

**Testing Engineer** : David Mao  
(David Mao)

**Technical Manager** : Leo Hung  
(Leo Hung)

**Authorized Signatory** : Steven Lu  
(Steven Lu)

# **B T L I N C .**

No.3,Jinshagang 1st Road, Shixia,Dalang Town, Dongguan, China.  
TEL: +86-769-8318-3000FAX: +86-769-8319-6000

**Declaration**

**BTL** represents to the client that testing is done in accordance with standard procedures as applicable and that test instruments used has been calibrated with the standards traceable to National Measurement Laboratory (**NML**) of **R.O.C.**, or National Institute of Standards and Technology (**NIST**) of **U.S.A.**

**BTL's** reports apply only to the specific samples tested under conditions. It is manufacture's responsibility to ensure that additional production units of this model are manufactured with the identical electrical and mechanical components. **BTL** shall have no liability for any declarations, inferences or generalizations drawn by the client or others from **BTL** issued reports.

**BTL's** reports must not be used by the client to claim product endorsement by the authorities or any agency of the Government.

This report is the confidential property of the client. As a mutual protection to the clients, the public and **BTL-self**, extracts from the test report shall not be reproduced except in full with **BTL's** authorized written approval.

**BTL's** laboratory quality assurance procedures are in compliance with the **ISO Guide 17025** requirements, and accredited by the conformity assessment authorities listed in this test report.

**Limitation**

For the use of the authority's logo is limited unless the Test Standard(s)/Scope(s)/Item(s) mentioned in this test report is (are) included in the conformity assessment authorities acceptance respective.

<b>Table of Contents</b>	<b>Page</b>
<b>1 . CERTIFICATION</b>	<b>5</b>
<b>2 . EUT INFORMATION</b>	<b>6</b>
2.1 EUT SPECIFICATION TABLE	6
2.4 EUT MAXIMUM AND MINIMUM E.I.R.P. POWER	7
<b>3 . U-NII DFS RULE REQUIREMENTS</b>	<b>8</b>
3.1 WORKING MODES AND REQUIRED TEST ITEMS	8
3.2 TEST LIMITS AND RADAR SIGNAL PARAMETERS	9
<b>4 . TEST INSTRUMENTS</b>	<b>11</b>
<b>5 . EMC EMISSION TEST</b>	<b>12</b>
5.1 DFS MEASUREMENT SYSTEM:	12
5.2 CALIBRATION OF DFS DETECTION THRESHOLD LEVEL:	14
5.3 DEVIATION FROM TEST STANDARD	14
<b>6 . TEST RESULTS</b>	<b>15</b>
6.1 SUMMARY OF TEST RESULT	15
6.2 DELETED TEST RESULTS	16
6.2.1 TEST MODE: DEVICE OPERATING IN MASTER MODE.	16
6.2.2 DFS DETECTION THRESHOLD	16
6.2.5 NON- OCCUPANCY PERIOD	32

**REPORT ISSUED HISTORY**

Issued No.	Description	Issued Date
BTL-FICP-5-1406C178	Original Report.	Aug. 11, 2014

## 1. CERTIFICATION

Equipment : dreamtab  
Trade Name : FUHU  
Model Name. : BGTAB-NV24A  
Applicant : Foxconn International Inc.  
Manufacturer : FUHU INC  
Address : 909N., Sepulveda Blvd., Suite 540, E1 Segundo, CA 90245  
Factory : HONGFUJIN Precision Electronics (Chong Qing) Co., Ltd.  
Address : No.1, 1<sup>st</sup> E District RD., Shapingba District, Chongqing 401332, P.R. China  
Date of Test: : Jun. 24, 2014~ Aug. 08, 2014  
Test Item : ENGINEERING SAMPLE  
Standard(s) : FCC Part 15, Subpart E (Section 15.407) FCC 06-96  
Canada RSS-210:2010

The above equipment has been tested and found compliance with the requirement of the relative standards by BTL Inc.

The test data, data evaluation, and equipment configuration contained in our test report (Ref No. BTL-FICP-5-1406C178) were obtained utilizing the test procedures, test instruments, test sites that has been accredited by the Authority of TAF according to the ISO-17025 quality assessment standard and technical standard(s).

## 2. EUT INFORMATION

### 2.1 EUT SPECIFICATION TABLE

Table 1: Specification of EUT

<b>Product name</b>	dreamtab
<b>Brand Name</b>	FUHU
<b>Model</b>	BGTAB-NV24A
<b>Model difference</b>	N/A
<b>FCC ID</b>	SIB-BGTAB-NV24A
<b>IC ID</b>	6719D-BGTABNV24A
<b>Operational Mode</b>	Slave
<b>Operating Frequency Range</b>	5250~5350MHz&5470~5725MHz
<b>Modulation</b>	OFDM

**Note:** This device was functioned as a  Master  Slave device during the DFS

### 2.2 DESCRIPTION OF AVAILABLE ANTENNAS TO THE EUT

Table 2: Antenna list.

#### Group 1

Ant.	Manufacturer	Model Name	Antenna Type	Connector	Gain (dBi)	Note
1	FOXCONN	PCA-3007-25GC1-A2	Integral	N/A	-1.31	360mm
2	FOXCONN	PCA-3007-25GC1-A5	Integral	N/A	-3.46	65mm

#### Group 2

Ant.	Manufacturer	Model Name	Antenna Type	Connector	Gain (dBi)	Note
1	MAG Corporation	PCA-3007-25GC1-A2	Integral	N/A	2.24	360mm
2	MAG Corporation	PCA-3007-25GC1-A5	Integral	N/A	1.92	65mm

**Note:**

- 1.The EUT incorporates a MIMO function. Physically, the EUT provides two completed two transmitters and two receivers (2T2R).
2. Two groups of antenna were used with the same type, only differ in manufacturer and gain, group 2 is tested and recorded as the worst case in this report.

### 2.3 CONDUCTED OUTPUT POWER AND EIRP POWER

TABLE 3: THE CONDUCTED OUTPUT POWER LIST

TX (11a)

FREQUENCY BAND (MHz)	MAX. POWER	
	OUTPUT POWER(dBm)	OUTPUT POWER(mW)
5250~5350	13.63	23.07
5470~5725	13.51	22.44

TX (11n 40MHz)

FREQUENCY BAND (MHz)	MAX. POWER	
	OUTPUT POWER(dBm)	OUTPUT POWER(mW)
5250~5350	15.15	32.73
5470~5725	15.42	34.83

### 2.4 EUT MAXIMUM AND MINIMUM E.I.R.P. POWER

TABLE 4: THE MAX EIRP LIST

TX (11a)

FREQUENCY BAND (MHz)	MAX. POWER	
	OUTPUT POWER(dBm)	OUTPUT POWER(mW)
5250~5350	16.39	43.55
5470~5725	16.27	42.36

TX (11n 40MHz)

FREQUENCY BAND (MHz)	MAX. POWER	
	OUTPUT POWER(dBm)	OUTPUT POWER(mW)
5250~5350	17.91	61.80
5470~5725	18.18	65.77

### 3. U-NII DFS RULE REQUIREMENTS

#### 3.1 WORKING MODES AND REQUIRED TEST ITEMS

The manufacturer shall state whether the UUT is capable of operating as a Master and/or a Client. If the UUT is capable of operating in more than one operating mode then each operating mode shall be tested separately. See tables 1 and 2 for the applicability of DFS requirements for each of the operational modes.

Table 5: Applicability of DFS requirements prior to use a channel

Requirement	Operational Mode		
	Master	Client without radar detection	Client with radar detection
Non-Occupancy Period	✓	Not required	✓
DFS Detection Threshold	✓	Not required	✓
Channel Availability Check Time	✓	Not required	Not required
Uniform Spreading	✓	Not required	Not required
U-NII Detection Bandwidth	✓	Not required	✓

Table 6: Applicability of DFS requirements during normal operation.

Requirement	Operational Mode		
	Master	Client without radar detection	Client with radar detection
DFS Detection Threshold	✓	Not required	✓
Channel Closing Transmission Time	✓	✓	✓
Channel Move Time	✓	✓	✓
U-NII Detection Bandwidth	✓	Not required	✓



### 3.2 TEST LIMITS AND RADAR SIGNAL PARAMETERS

#### DETECTION THRESHOLD VALUES

Table 7: DFS Detection Thresholds for Master Devices and Client Devices With Radar Detection.

Maximum Transmit Power	Value (See Notes 1 and 2)
$\geq$ 200 milliwatt	-64 dBm
< 200 milliwatt	-62 dBm

Note 1: This is the level at the input of the receiver assuming a 0 dBi receive antenna.

Note 2: Throughout these test procedures an additional 1 dB has been added to the amplitude of the test transmission waveforms to account for variations in measurement equipment. This will ensure that the test signal is at or above the detection threshold level to trigger a DFS response.

Table 8: DFS Response Requirement Values

Parameter	Value
Non-occupancy period	Minimum 30 minutes
Channel Availability Check Time	60 seconds
Channel Move Time	10 seconds See Note 1.
Channel Closing Transmission Time	200 milliseconds + an aggregate of 60 milliseconds over remaining 10 second period. See Notes 1 and 2.
U-NII Detection Bandwidth	Minimum 80% of the UNII 99% transmission power bandwidth. See Note 3.

**Note 1:** The instant that the Channel Move Time and the Channel Closing Transmission Time begins is as follows:

- For the Short Pulse Radar Test Signals this instant is the end of the Burst.
- For the Frequency Hopping radar Test Signal, this instant is the end of the last radar Burst generated.
- For the Long Pulse Radar Test Signal this instant is the end of the 12 second period defining the Radar Waveform.

**Note 2:** The Channel Closing Transmission Time is comprised of 200 milliseconds starting at the beginning of the Channel Move Time plus any additional intermittent control signals required to facilitate a Channel move (an aggregate of 60 milliseconds) during the remainder of the 10 second period. The aggregate duration of control signals will not count quiet periods in between transmissions.

**Note 3:** During the U-NII Detection Bandwidth detection test, radar type 1 is used and for each frequency step the minimum percentage of detection is 90 percent. Measurements are performed with no data traffic.

## PARAMETERS OF DFS TEST SIGNALS

Step intervals of 0.1 microsecond for Pulse Width, 1 microsecond for PRI, 1 MHz for chirp width and 1 for the number of pulses will be utilized for the random determination of specific test waveforms.

Table 9: Short Pulse Radar Test Waveforms.

Radar Type	Pulse Width (μsec)	PRI (μsec)	Number of Pulses	Minimum Percentage of Successful Detection	Minimum Number of Trials
1	1	1428	18	60%	30
2	1-5	150-230	23-29	60%	30
3	6-10	200-500	16-18	60%	30
4	11-20	200-500	12-16	60%	30
Aggregate (Radar Types 1-4)				80%	120

Table 10: Long Pulse Radar Test Waveform

Radar Type	Pulse Width (μsec)	Chirp Width (MHz)	PRI (μsec)	Number of Pulses per Burst	Number of Bursts	Minimum Percentage of Successful Detection	Minimum Number of Trials
5	50-100	5-20	1000-2000	1-3	8-20	80%	30

Table 11: Frequency Hopping Radar Test Waveform

Radar Type	Pulse Width (μsec)	Chirp Width (MHz)	PRI (μsec)	Number of Pulses per Burst	Number of Bursts	Minimum Percentage of Successful Detection	Minimum Number of Trials
6	1	333	9	0.333	300	70%	30

#### 4. TEST INSTRUMENTS

Table 1: Test instruments list.

DESCRIPTION	MANUFACTURER	MODEL NO.	Serial No	Calibration Until
EXA Spectrum Analyzer	Agilent	N9010A	MY50520044	2015-04-25
Signal Generator	Agilent	E4438C	My49071316	2015-04-25
POWER SPLITTER	Mini-Circuits	ZFRSC-123-S+	331000910	2015-04-25
POWER SPLITTER	Mini-Circuits	ZN4PD1-63-S+	SF933501045	2015-04-25
POWER SPLITTER	Mini-Circuits	ZN2PD-9G-S+	SF012700714	2015-04-25
attenuator	Mini-Circuits	VAT-30+	30912	2015-04-25
attenuator	Mini-Circuits	VAT-10+	30909	2015-04-25
Spectrum Analyzer	R&S	FSL6	1004423	2014-11-25
PC	Dell 745	DCSM	G7K832X	--
Netbook	Hp	HSTNN-I69C-3	CNU02203XG	--

Note: Calibration interval of instruments listed above is one year.

## 5. EMC EMISSION TEST

### 5.1 DFS MEASUREMENT SYSTEM:

#### CONDUCTED METHOD SYSTEM BLOCK DIAGRAM

##### Master Conducted Measurement

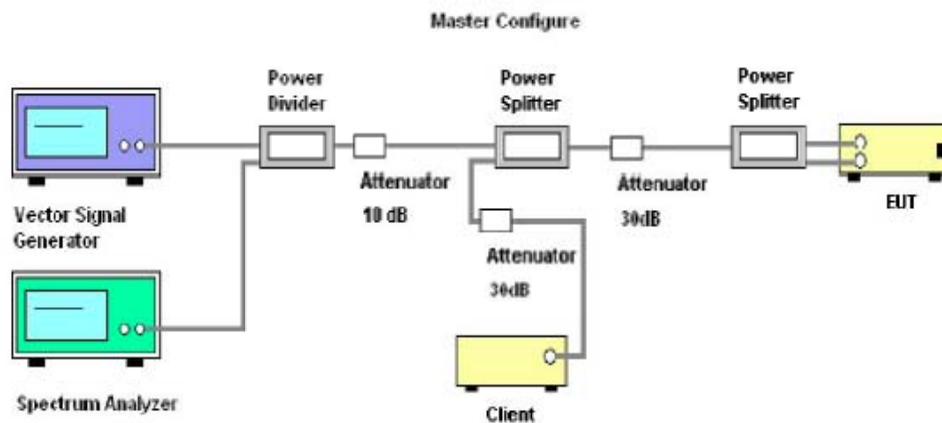

#### SYSTEM OVERVIEW

The short pulse and long pulse signal generating system utilizes the NTIA software. The Vector Signal Generator has been validated by the NTIA. The hopping signal generating system utilizes the CCS simulated hopping method and system, which has been validated by the DoD, FCC and NTIA. The software selects waveform parameters from within the bounds of the signal type on a random basis using uniform distribution.

The short pulse types 2, 3 and 4, and the long pulse type 5 parameters are randomized at run-time.

The hopping type 6 pulse parameters are fixed while the hopping sequence is based on the August 2005 NTIA Hopping Frequency List. The initial starting point is randomized at run-time and each subsequent starting point is incremented by 475. Each frequency in the 100-length segment is compared to the boundaries of the EUT Detection Bandwidth and the software creates a hopping burst pattern in accordance with Section 7.4.1.3 Method #2 Simulated Frequency Hopping Radar Waveform Generating Subsystem of FCC 06-96. The frequency of the signal generator is incremented in 1 MHz steps from FL to FH for each successive trial. This incremental sequence is repeated as required to generate a minimum of 30 total trials and to maintain a uniform frequency distribution over the entire Detection Bandwidth.

The signal monitoring equipment consists of a spectrum analyzer set to display 8001 bins on the horizontal axis. The time-domain resolution is 2 msec / bin with a 16 second sweep time, meeting the 10 second short pulse reporting criteria. The aggregate ON time is calculated by multiplying the number of bins above a threshold during a particular observation period by the dwell time per bin, with the analyzer set to peak detection and max hold.

Should multiple RF ports be utilized for the Master and/or Slave devices (for example, for diversity or MIMO implementations), additional combiner/dividers are inserted between the Master Combiner/Divider and the pad connected to the Master Device (and/or between the Slave Combiner/Divider and the pad connected to the Slave Device). Additional pads are utilized such that there is one pad at each RF port on each EUT.

**5.2 CALIBRATION OF DFS DETECTION THRESHOLD LEVEL:**

A 50 ohm load is connected in place of the spectrum analyzer, and the spectrum analyzer is connected in place of the master device and the signal generator is set to CW mode. The amplitude of the signal generator is adjusted to yield a level of -62 dBm as measured on the spectrum analyzer.

Without changing any of the instrument settings, the spectrum analyzer is reconnected to the Common port of the Spectrum Analyzer Combiner/Divider. Measure the amplitude and calculate the difference from -62 dBm. Adjust the Reference Level Offset of the spectrum analyzer to this difference.

The spectrum analyzer displays the level of the signal generator as received at the antenna ports of the Master Device. The interference detection threshold may be varied from the calibrated value of -62 dBm and the spectrum analyzer will still indicate the level as received by the Master Device.

Set the signal generator to produce a radar waveform, trigger a burst manually and measure the level on the spectrum analyzer. Readjust the amplitude of the signal generator as required so that the peak level of the waveform is at a displayed level equal to the required or desired interference detection threshold. Separate signal generator amplitude settings are determined as required for each radar type.

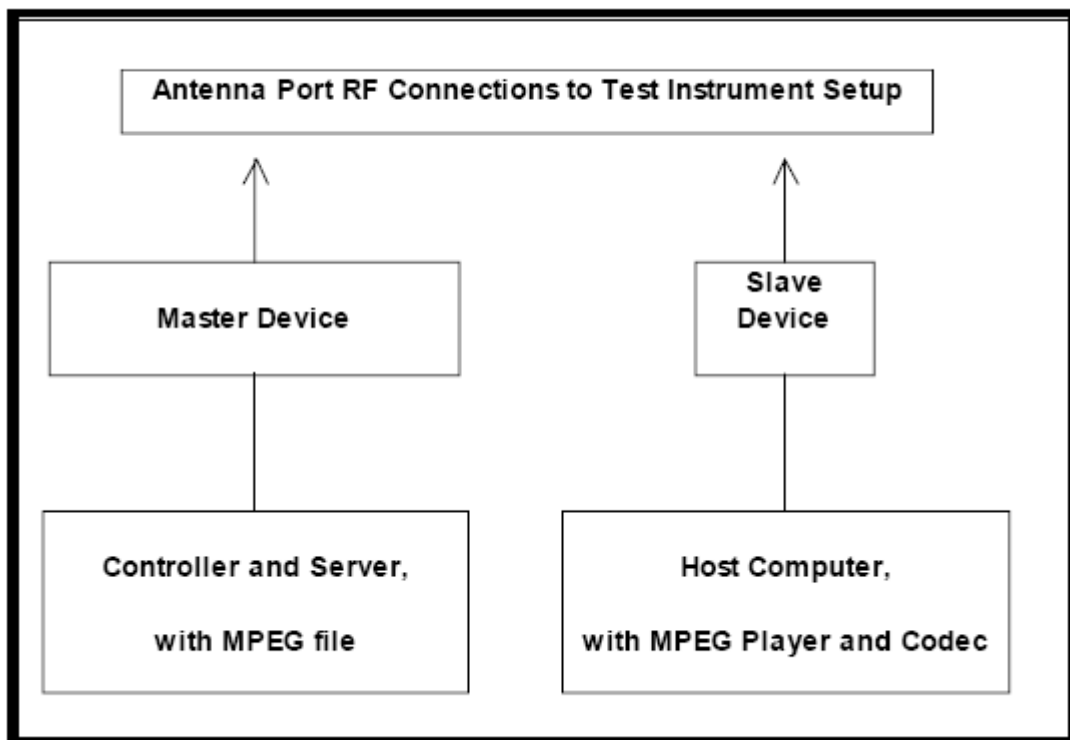

**5.3 DEVIATION FROM TEST STANDARD**

No deviation.

## 6. TEST RESULTS

### 6.1 SUMMARY OF TEST RESULT

Clause	Test Parameter	Remarks	Pass/Fail
15.407	DFS Detection Threshold	No Applicable	N/A
15.407	Channel Availability Check Time	No Applicable	N/A
15.407	Channel Move Time	Applicable	Pass
15.407	Channel Closing Transmission Time	Applicable	Pass
15.407	Non- Occupancy Period	No Applicable	N/A
15.407	Uniform Spreading	No Applicable	N/A
15.407	U-NII Detection Bandwidth	No Applicable	N/A

## 6.2 DETELED TEST RESULTS

Clause	Test Parameter	Remarks	Pass/Fail
15.407	DFS Detection Threshold	No Applicable	N/A
15.407	Channel Availability Check Time	No Applicable	N/A
15.407	Channel Move Time	Applicable	Pass
15.407	Channel Closing Transmission Time	Applicable	Pass
15.407	Non- Occupancy Period	No Applicable	N/A
15.407	Uniform Spreading	No Applicable	N/A
15.407	U-NII Detection Bandwidth	No Applicable	N/A

### 6.2.1 TEST MODE: DEVICE OPERATING IN MASTER MODE.

The EUT is slave equipment, it need a master device when testing.  
 Master with injection at the Master. (Radar Test Waveforms are injected into the Master)

### 6.2.2 DFS DETECTION THRESHOLD

Calibration:

For a detection threshold level of -64dBm and the Master antenna gain is 5.7dBi, required detection threshold is -56.30 dBm (= -62+5.7).

Note: Maximum Transmit Power is more than 200 milliwatt in this report, so detection threshold level is -64dBm (please refer to Table 7 [page 9]).



### Radar Signal 1

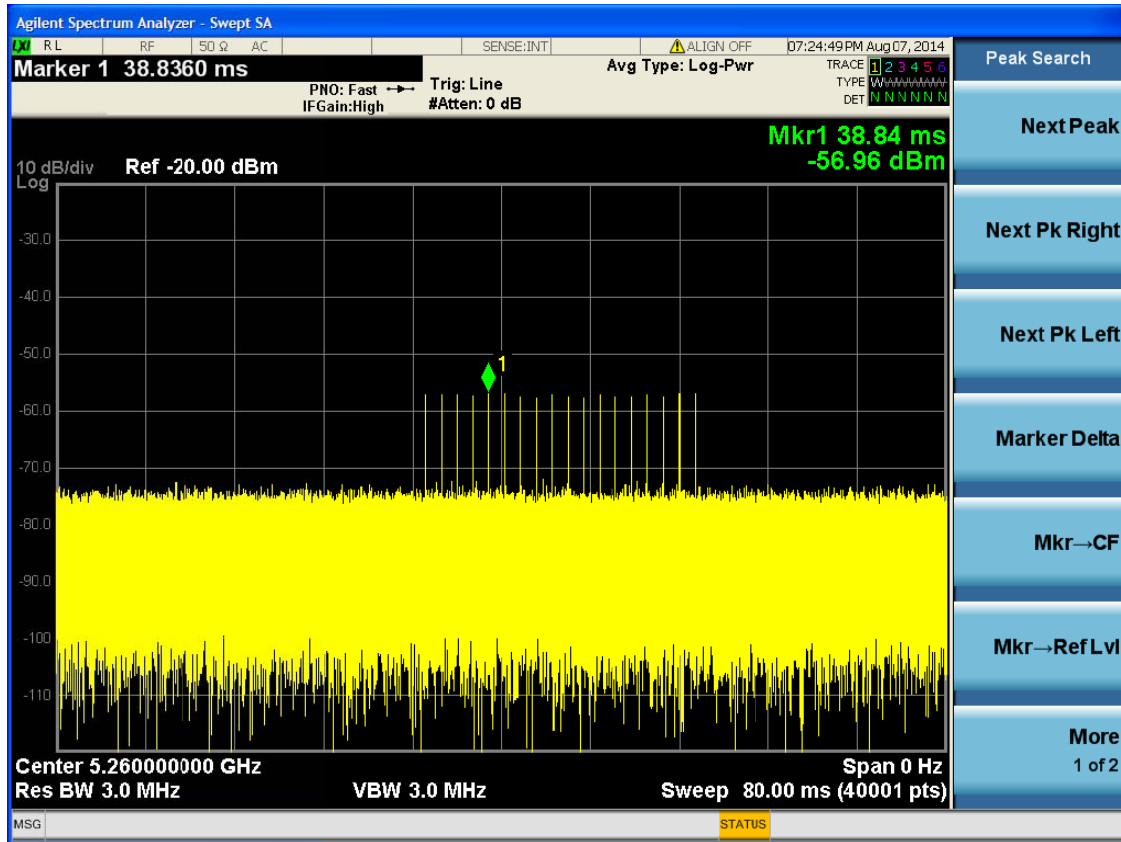

### Radar Signal 2

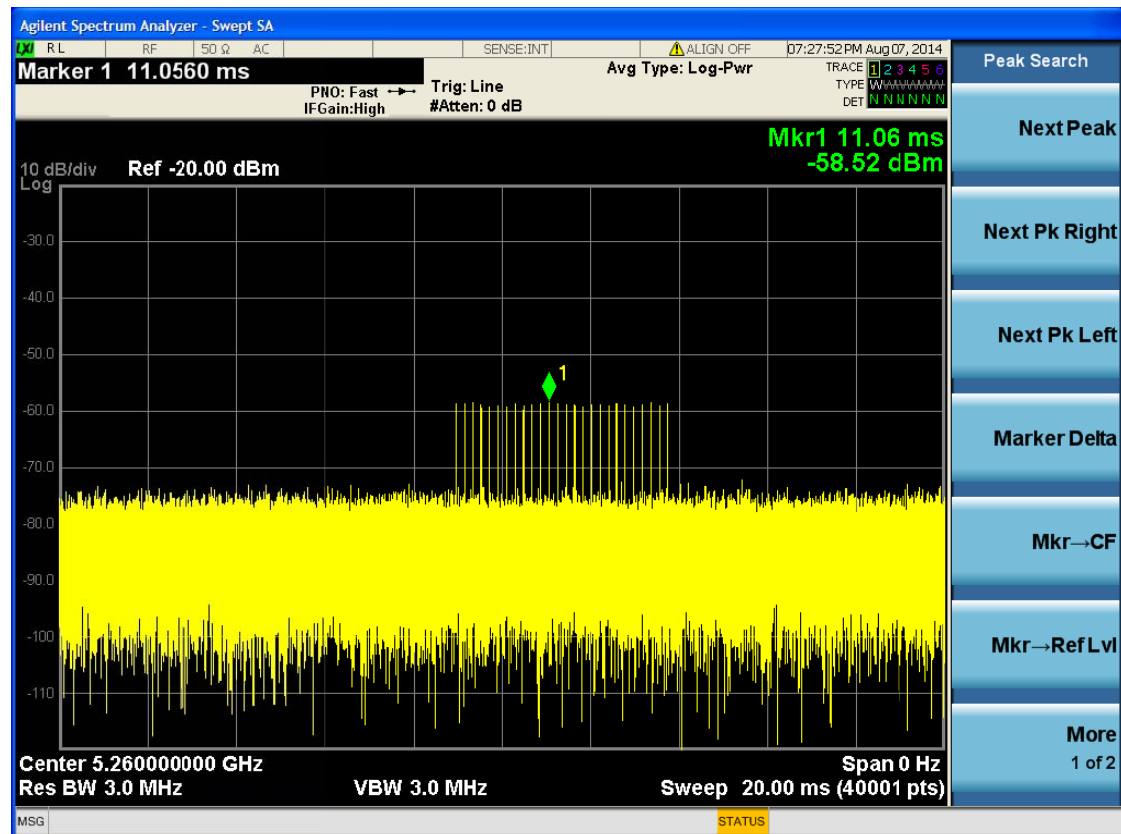

### Radar Signal 3

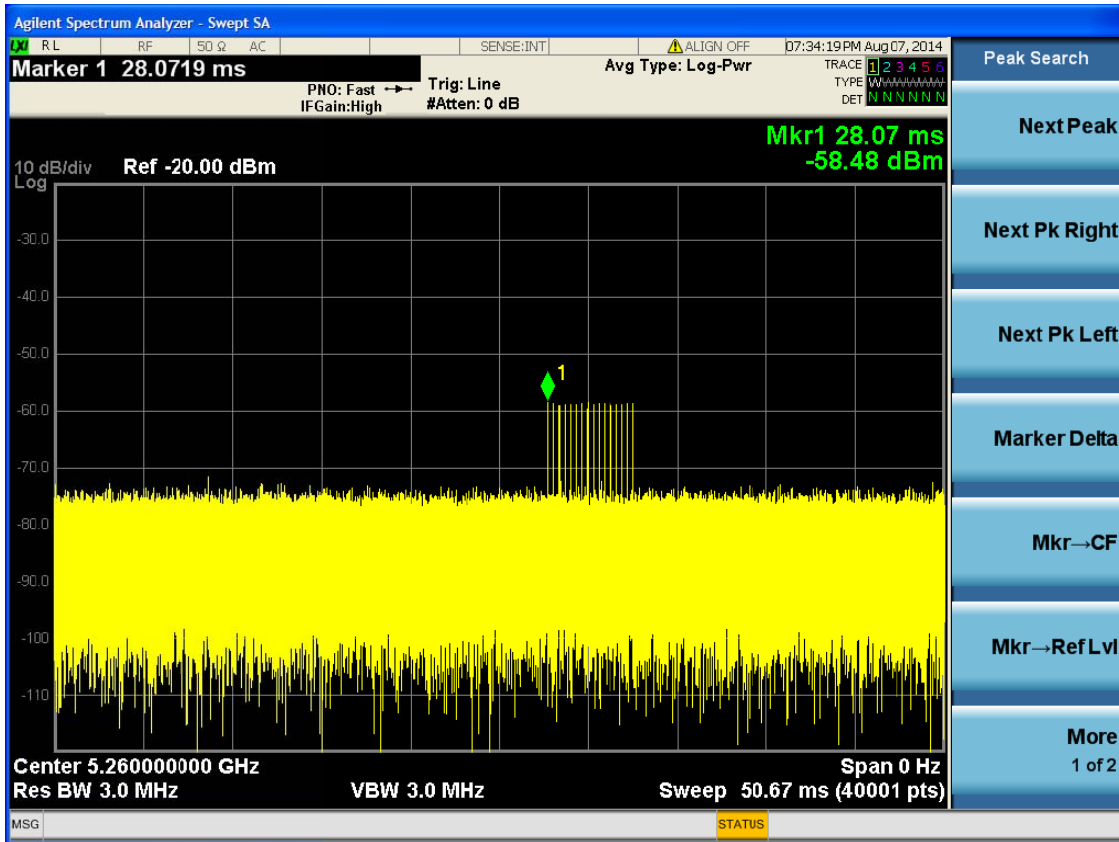

### Radar Signal 4

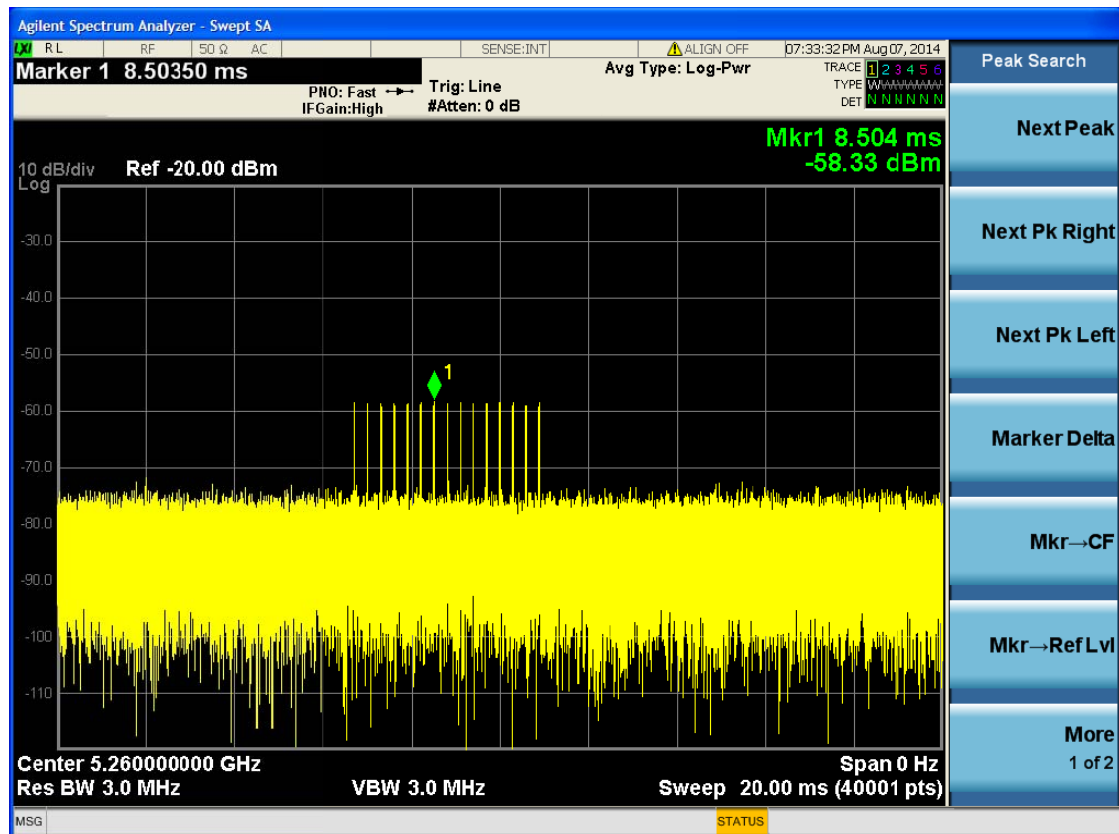

### Radar Signal 5

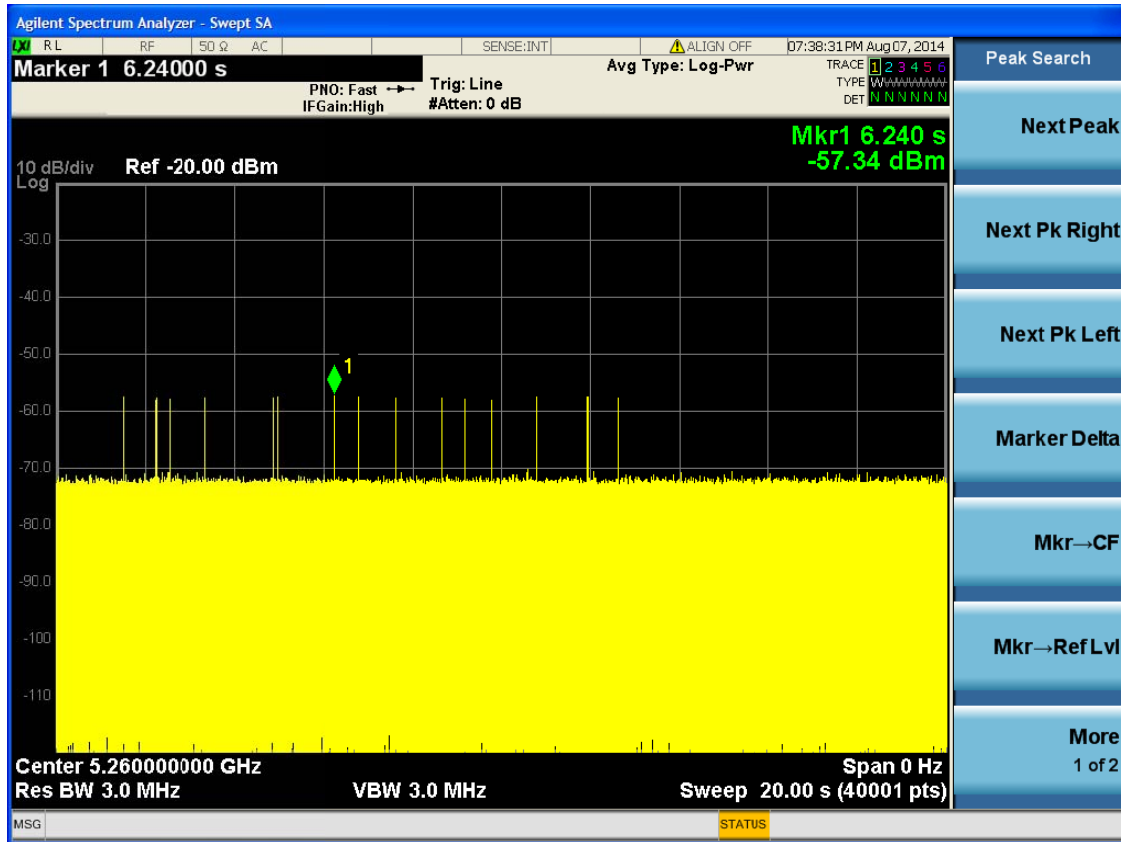

### Radar Signal 6

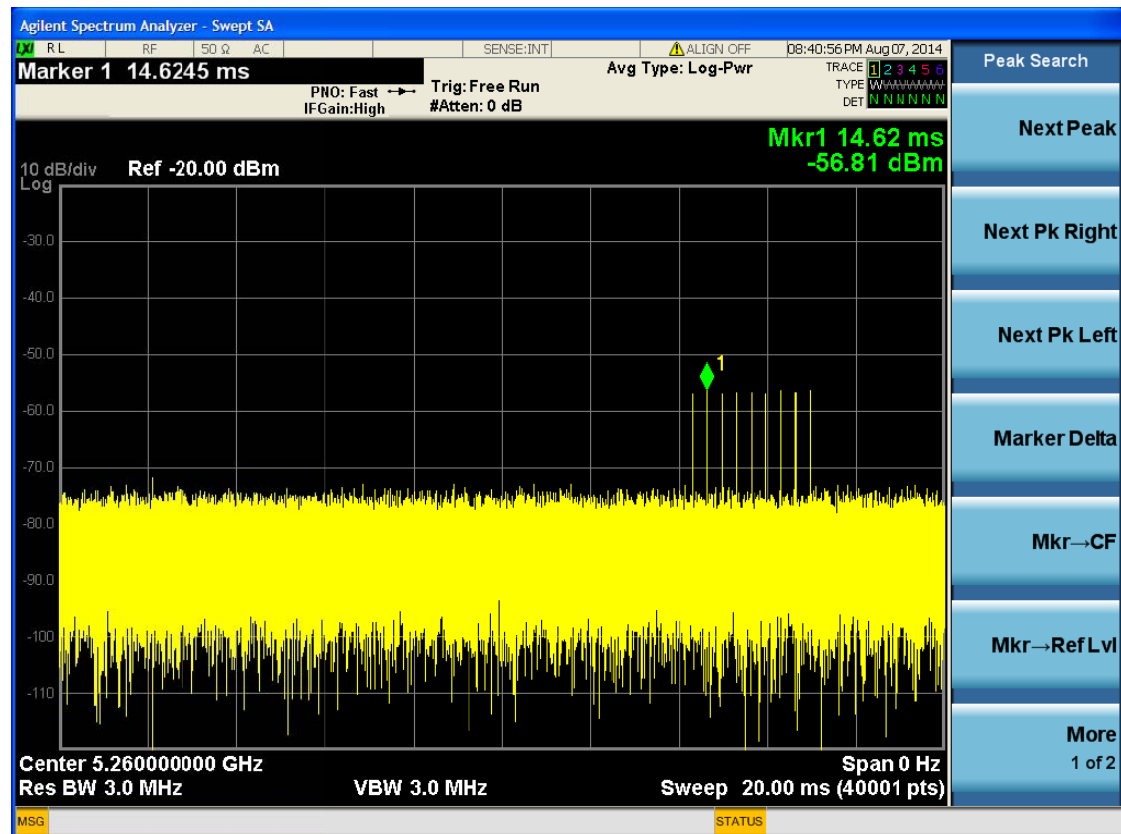

TX (11a Mode )

Radar signal 1

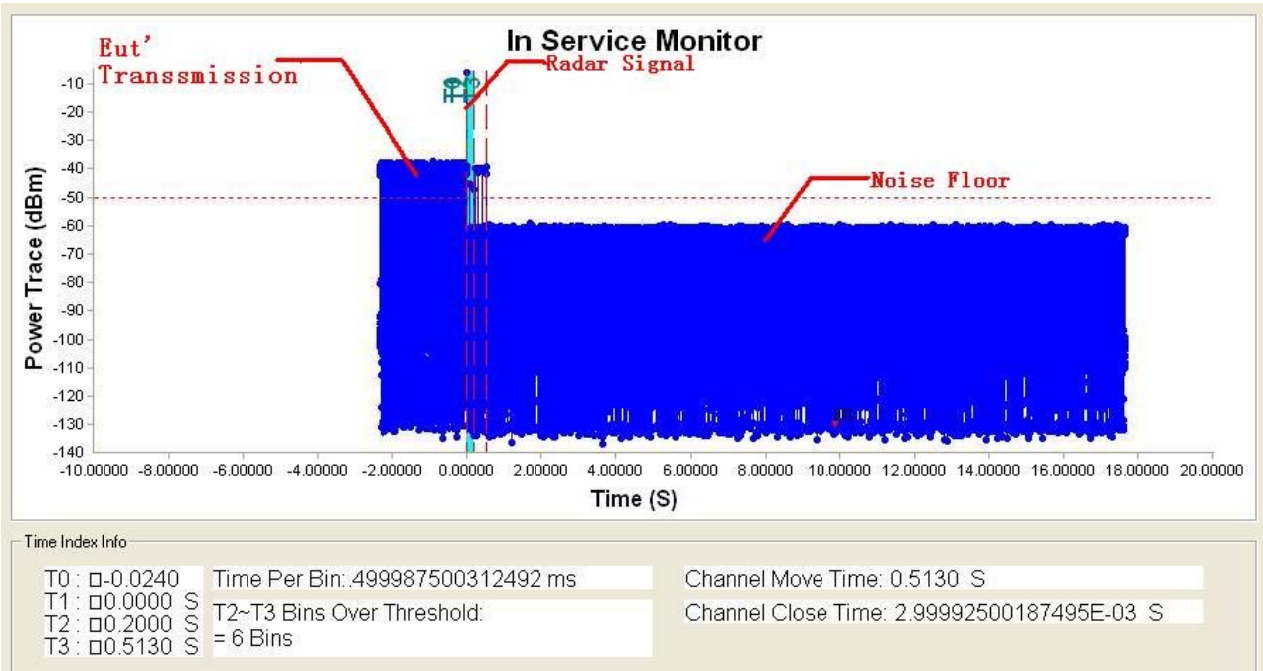

**Note:** T0 denotes the start of Channel Move Time upon the end of the last Radar burst.  
 T1 denotes the data transmission time of 200ms from T0.  
 T2 denotes the end of Channel Move Time.  
 T3 denotes the 10 second from T0 to observe the aggregate duration of transmissions.

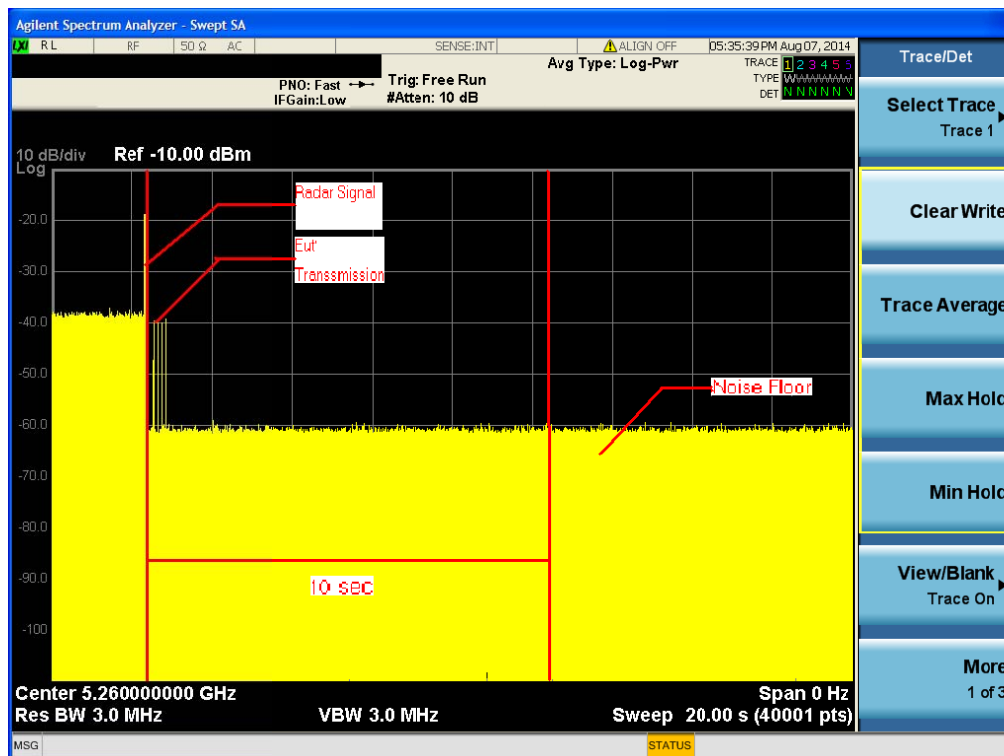

**Note:** An expanded plot for the device vacates the channel in the required 500ms

TX (11a Mode )

Radar signal 2

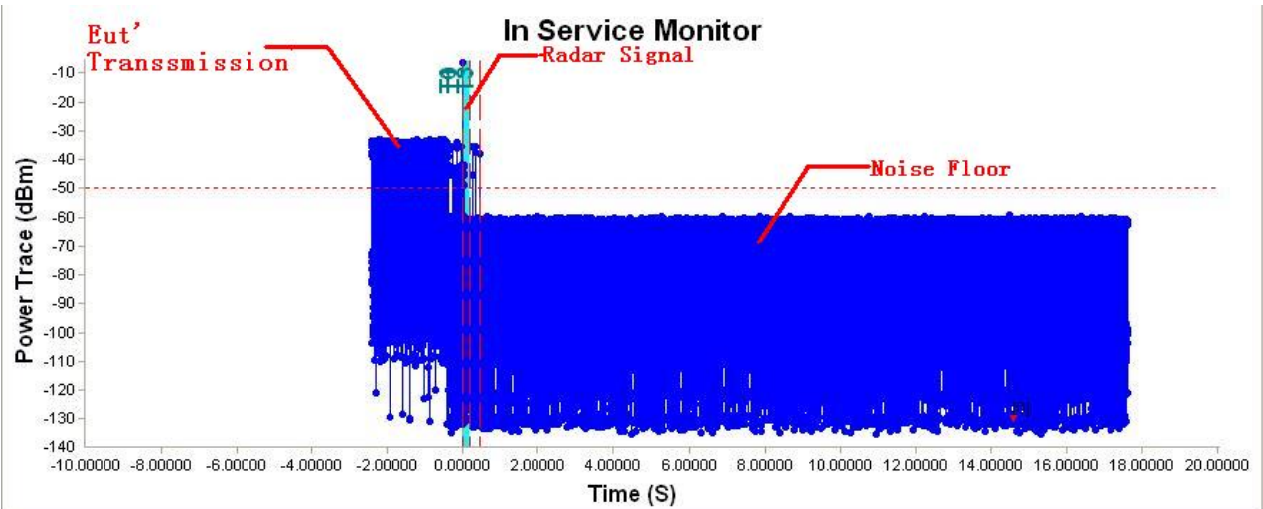

Time Index Info

T0 : 0.0050	Time Per Bin: .499987500312492 ms	Channel Move Time: 0.4500 S
T1 : 0.0000 S	T2~T3 Bins Over Threshold: = 5 Bins	Channel Close Time: 2.49993750156246E-03 S
T2 : 0.2000 S		
T3 : 0.4500 S		

**Note:** T0 denotes the start of Channel Move Time upon the end of the last Radar burst.  
 T1 denotes the data transmission time of 200ms from T0.  
 T2 denotes the end of Channel Move Time.  
 T3 denotes the 10 second from T0 to observe the aggregate duration of transmissions.

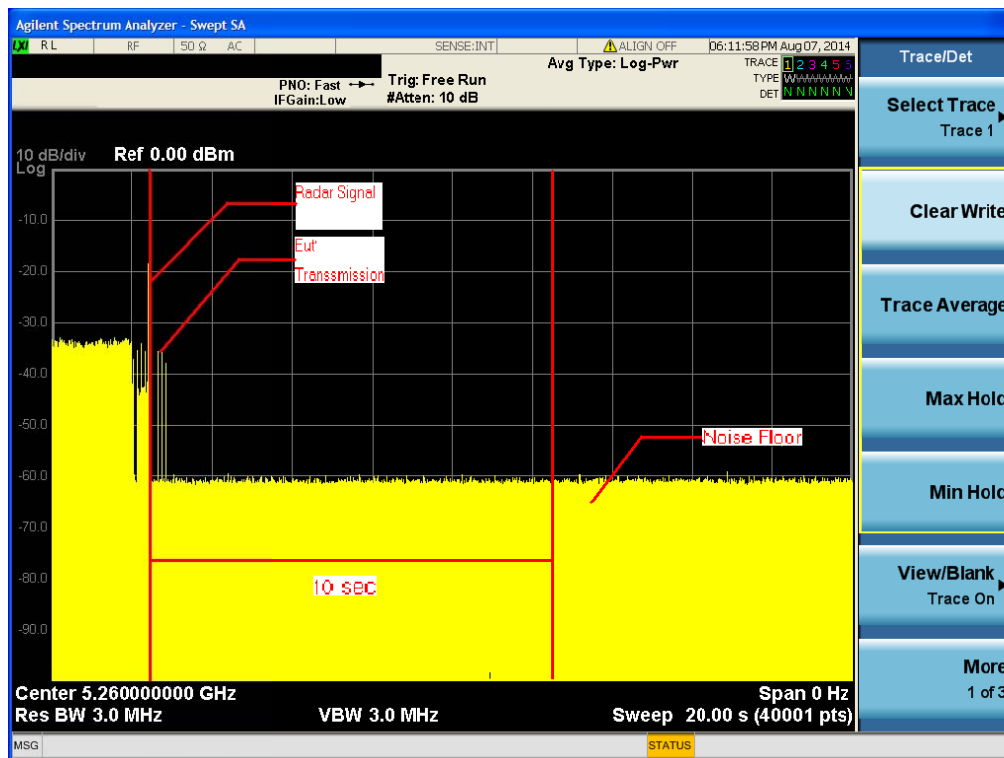

**Note:** An expanded plot for the device vacates the channel in the required 500ms

TX (11a Mode )

Radar signal 3

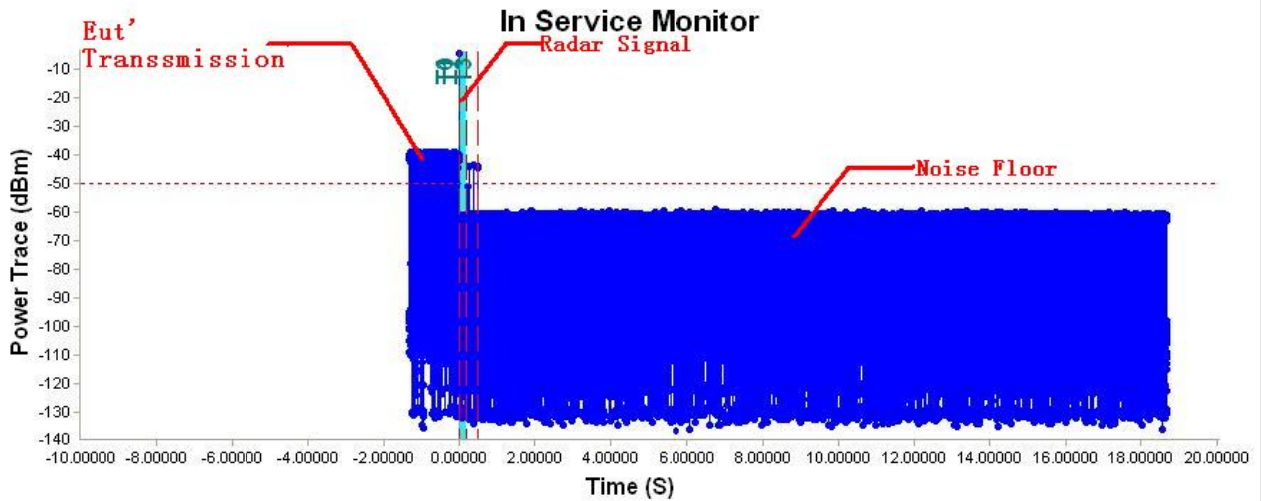

Time Index Info			
T0 : 0.0060 S	Time Per Bin: 499987500312492 ms	Channel Move Time: 0.4690 S	
T1 : 0.0000 S	T2~T3 Bins Over Threshold:	Channel Close Time: 1.99995000124997E-03 S	
T2 : 0.2000 S	= 4 Bins		
T3 : 0.4690 S			

**Note:** T0 denotes the start of Channel Move Time upon the end of the last Radar burst.  
 T1 denotes the data transmission time of 200ms from T0.  
 T2 denotes the end of Channel Move Time.  
 T3 denotes the 10 second from T0 to observe the aggregate duration of transmissions.



**Note:** An expanded plot for the device vacates the channel in the required 500ms

TX (11a Mode )

Radar signal 4

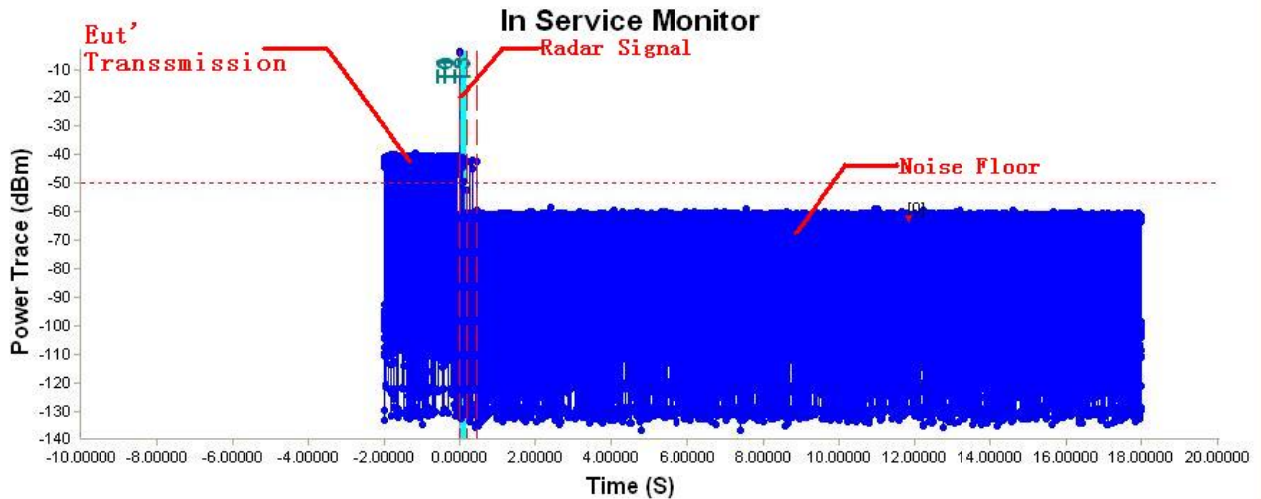

Time Index Info

T0 : 0.0060	Time Per Bin: .499987500312492 ms	Channel Move Time: 0.4490 S
T1 : 0.0000 S	T2~T3 Bins Over Threshold:	Channel Close Time: 1.99995000124997E-03 S
T2 : 0.2000 S	= 4 Bins	
T3 : 0.4490 S		

**Note:** T0 denotes the start of Channel Move Time upon the end of the last Radar burst.  
 T1 denotes the data transmission time of 200ms from T0.  
 T2 denotes the end of Channel Move Time.  
 T3 denotes the 10 second from T0 to observe the aggregate duration of transmissions.

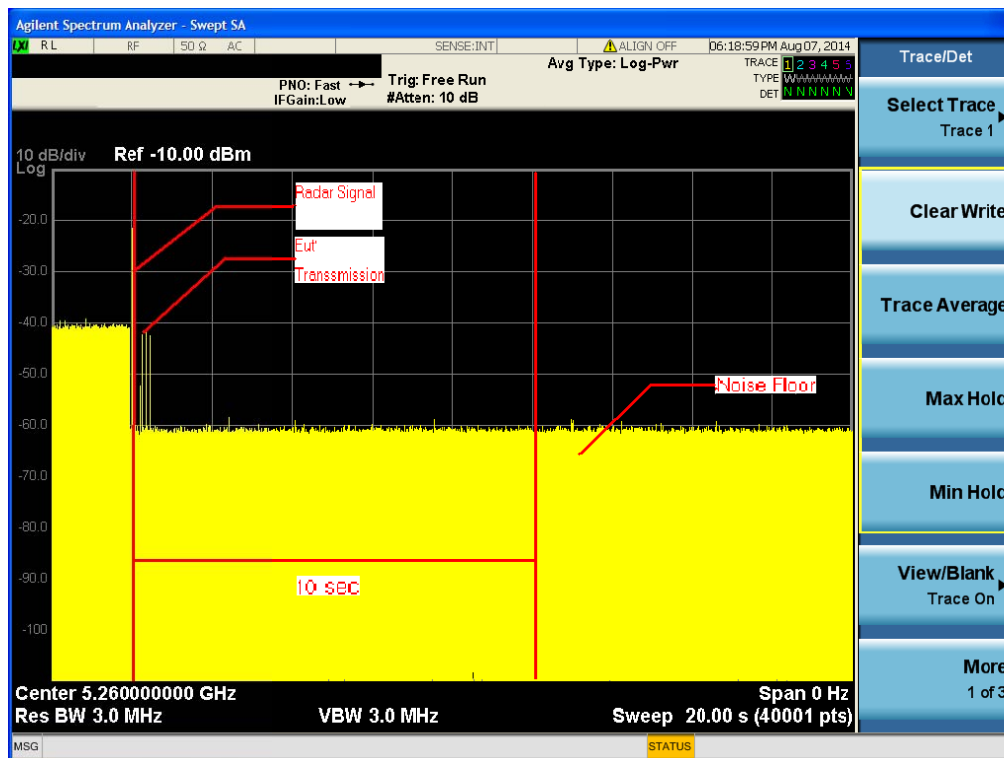

**Note:** An expanded plot for the device vacates the channel in the required 500ms

TX (11a Mode )

Radar signal 5

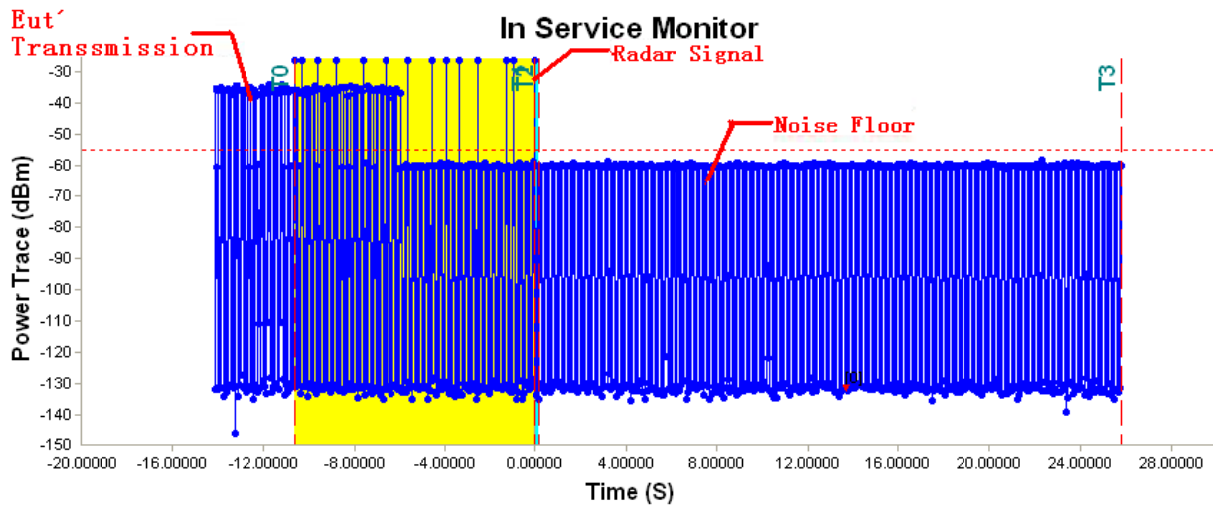

Time Index Info

T0 : -10.6294 S	Time Per Bin: 39.96004 ms	Channel Move Time: 25.8141858 S
T1 : 0.0000 S	T2~T3 Bins Over Threshold: = 0 Bins	Channel Close Time: 0.0 S
T2 : 0.1998 S		
T3 : 25.8142 S		

**Note:** T0 denotes the start of Channel Move Time upon the end of the last Radar burst.  
 T1 denotes the data transmission time of 200ms from T0.  
 T2 denotes the end of Channel Move Time.  
 T3 denotes the 10 second from T0 to observe the aggregate duration of transmissions.

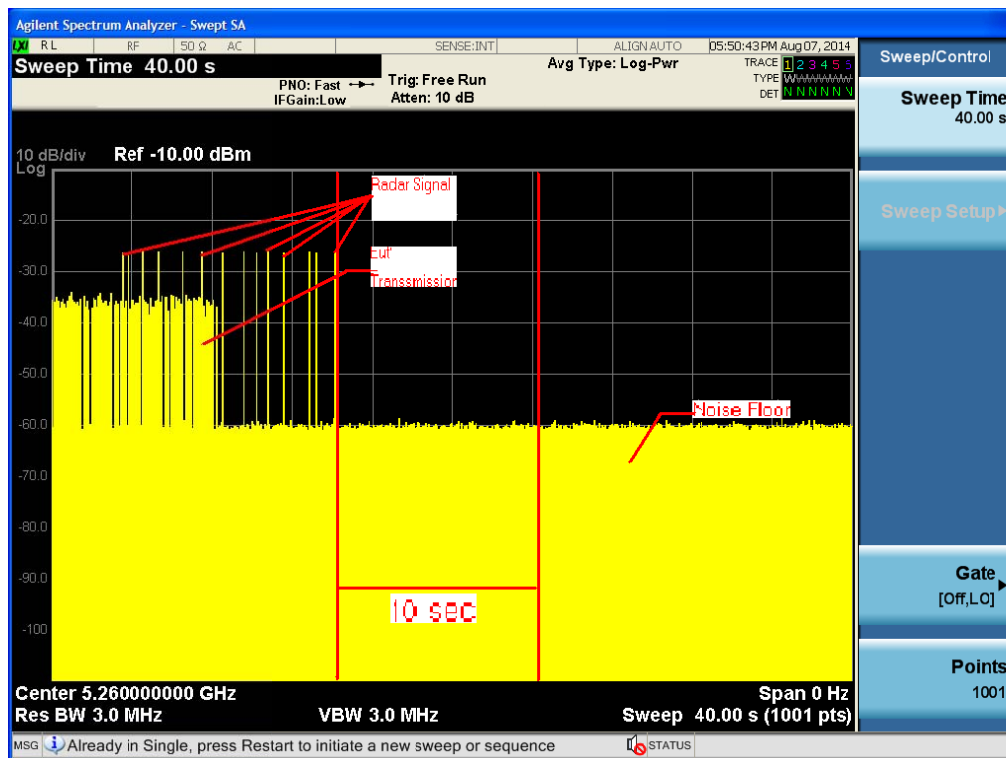

**Note:** An expanded plot for the device vacates the channel in the required 500ms



TX (11a Mode )

Radar signal 6

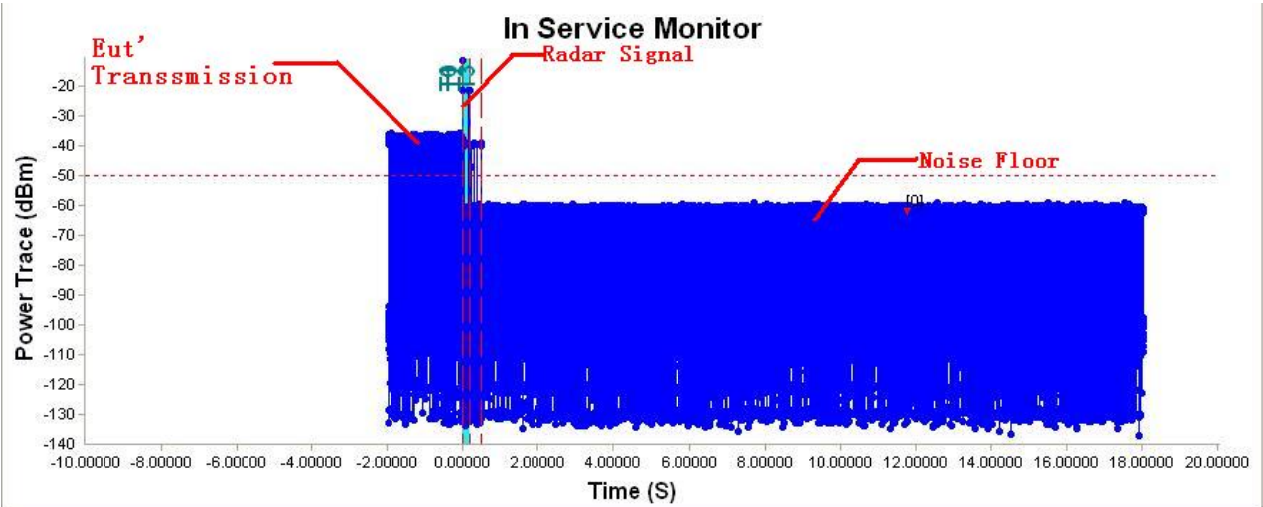

Time Index Info

T0 : 0.0030 S	Time Per Bin: .499987500312492 ms	Channel Move Time: 0.4830 S
T1 : 0.0000 S	T2~T3 Bins Over Threshold: = 9 Bins	Channel Close Time: 4.49988750281243E-03 S
T2 : 0.2000 S		
T3 : 0.4830 S		

**Note:** T0 denotes the start of Channel Move Time upon the end of the last Radar burst.  
 T1 denotes the data transmission time of 200ms from T0.  
 T2 denotes the end of Channel Move Time.  
 T3 denotes the 10 second from T0 to observe the aggregate duration of transmissions.

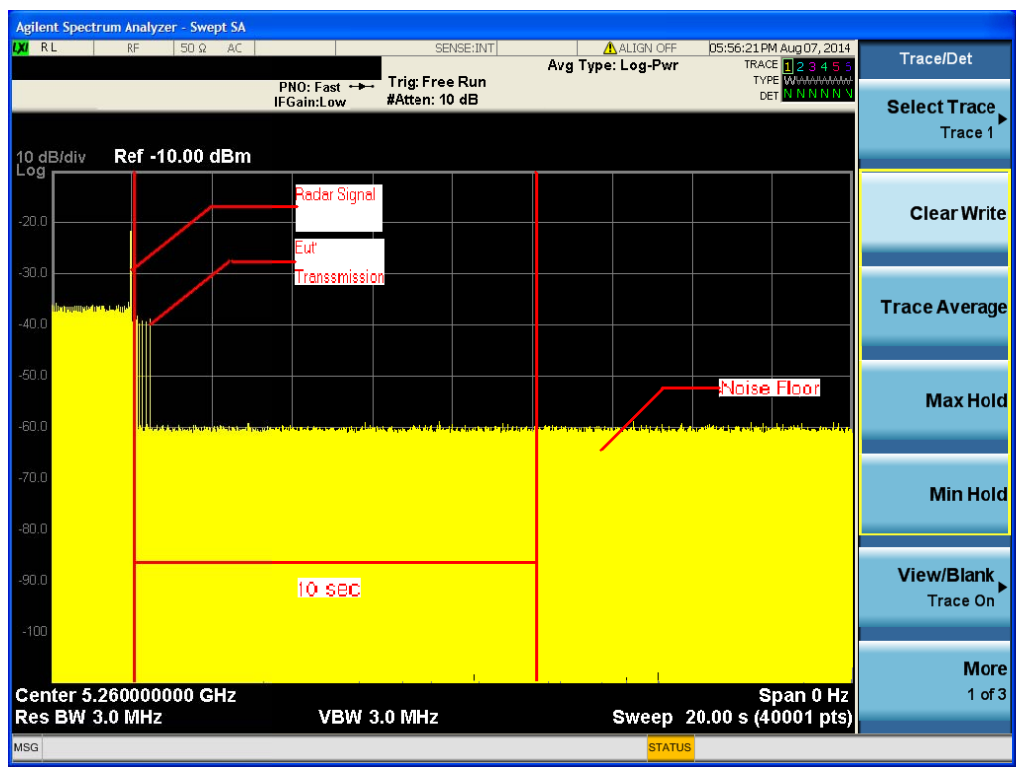

**Note:** An expanded plot for the device vacates the channel in the required 500ms

TX (11n 40MHz Mode)

Radar signal 1

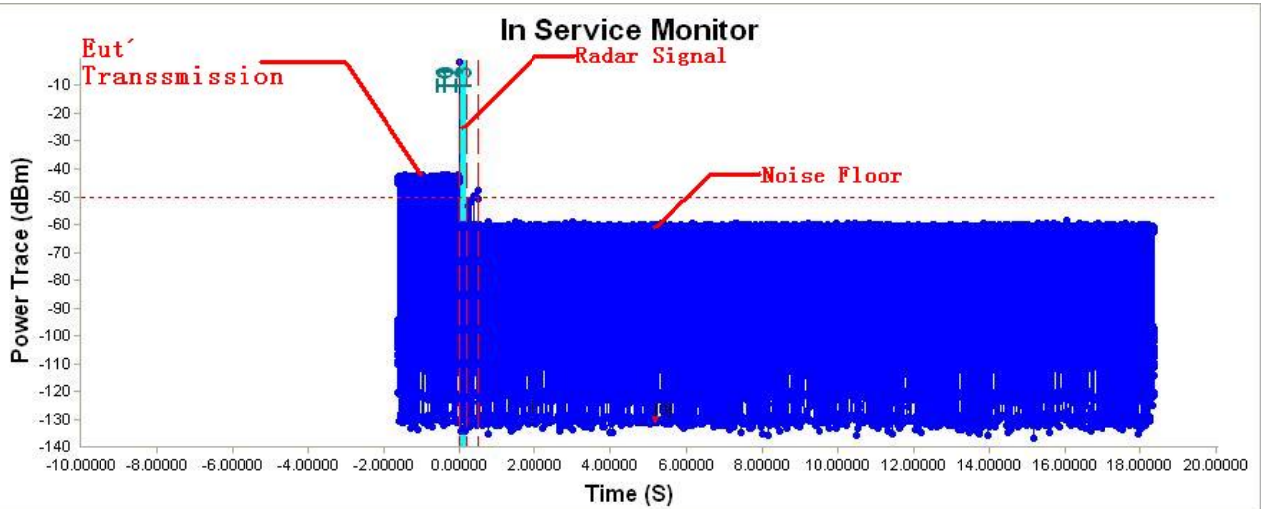

Time Index Info

T0 : 0.00250	Time Per Bin : 499987500312492 ms	Channel Move Time : 0.4820 S
T1 : 00.0000 S	T2~T3 Bins Over Threshold :	Channel Close Time : 9.99975000624984E-04 S
T2 : 00.2000 S	= 2 Bins	
T3 : 00.4820 S		

**Note:** T0 denotes the start of Channel Move Time upon the end of the last Radar burst.  
 T1 denotes the data transmission time of 200ms from T0.  
 T2 denotes the end of Channel Move Time.  
 T3 denotes the 10 second from T0 to observe the aggregate duration of transmissions.

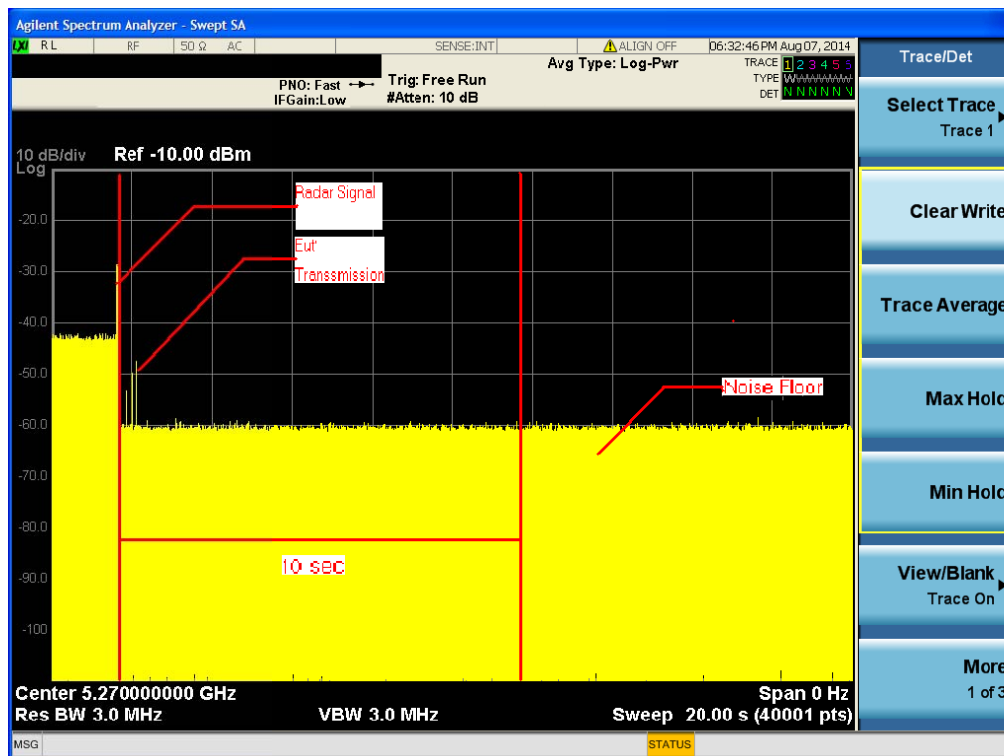

**Note:** An expanded plot for the device vacates the channel in the required 500ms

TX (11n 40MHz Mode)

Radar signal 2

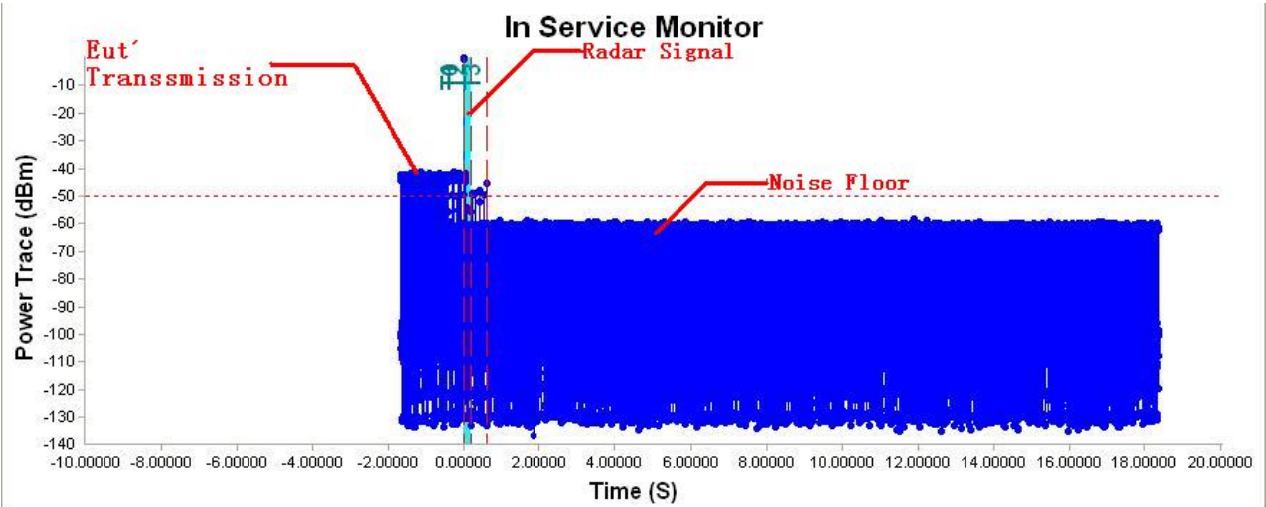

Time Index Info

T0 : 0.0060 S	Time Per Bin: 499987500312492 ms	Channel Move Time: 0.6060 S
T1 : 0.0000 S	T2~T3 Bins Over Threshold: = 6 Bins	Channel Close Time: 2.99992500187495E-03 S
T2 : 0.2000 S		
T3 : 0.6060 S		

**Note:** T0 denotes the start of Channel Move Time upon the end of the last Radar burst.  
 T1 denotes the data transmission time of 200ms from T0.  
 T2 denotes the end of Channel Move Time.  
 T3 denotes the 10 second from T0 to observe the aggregate duration of transmissions.

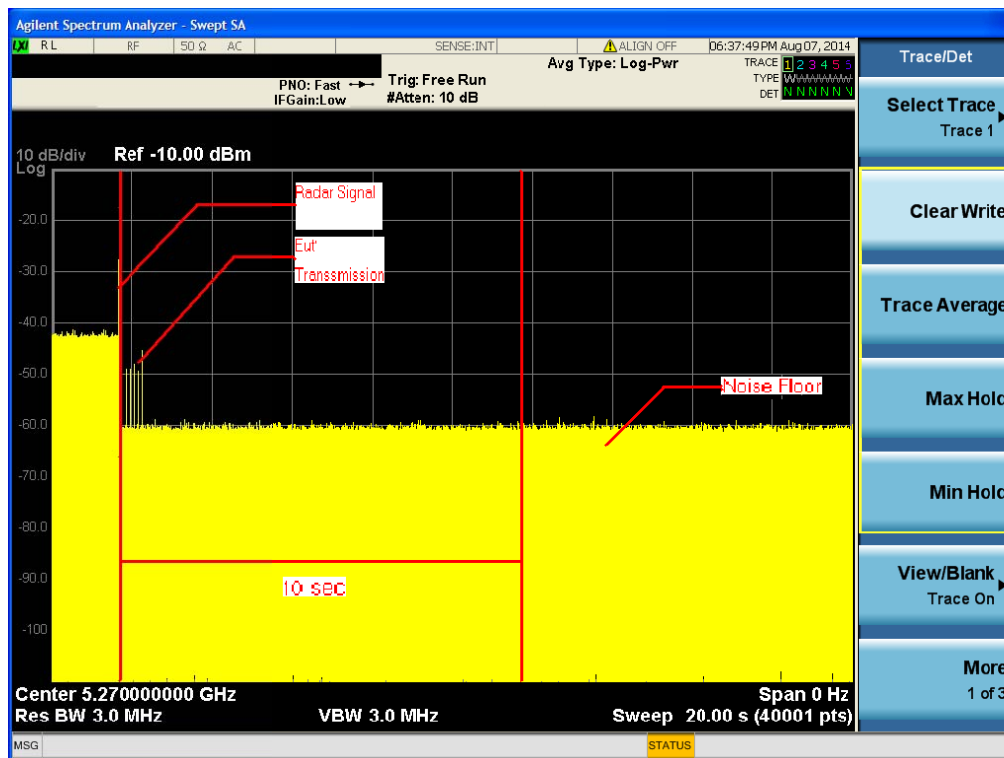

**Note:** An expanded plot for the device vacates the channel in the required 500ms

TX (11n 40MHz Mode )

Radar signal 3

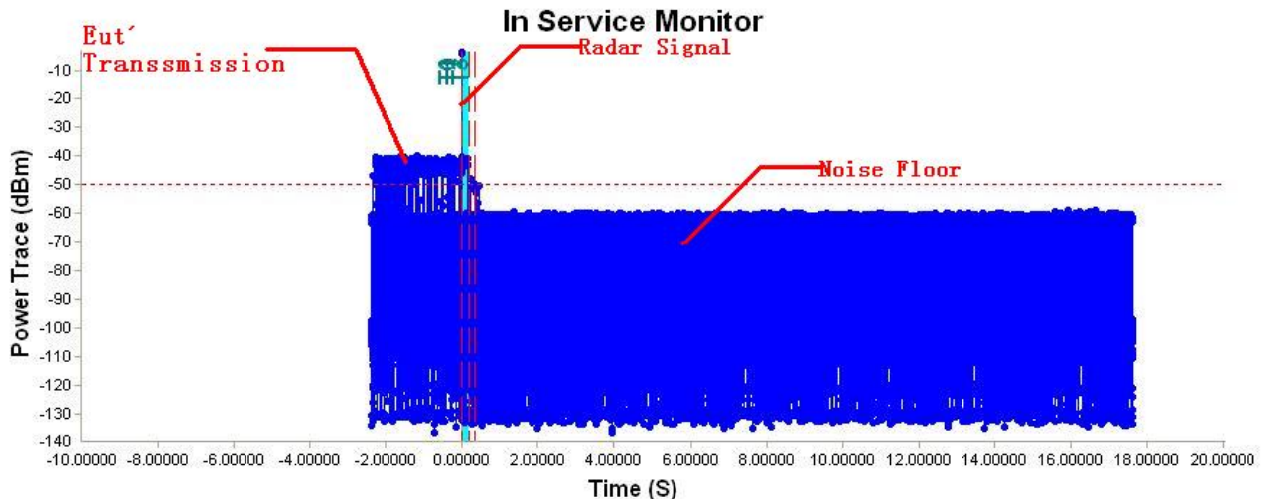

Time Index Info		
T0 : 0.00050 S	Time Per Bin: 499987500312492 ms	Channel Move Time: 0.3330 S
T1 : 0.20000 S	T2~T3 Bins Over Threshold: = 2 Bins	Channel Close Time: 9.99975000624984E-04 S
T2 : 0.33300 S		
T3 : 10.00000 S		

**Note:** T0 denotes the start of Channel Move Time upon the end of the last Radar burst.  
 T1 denotes the data transmission time of 200ms from T0.  
 T2 denotes the end of Channel Move Time.  
 T3 denotes the 10 second from T0 to observe the aggregate duration of transmissions.

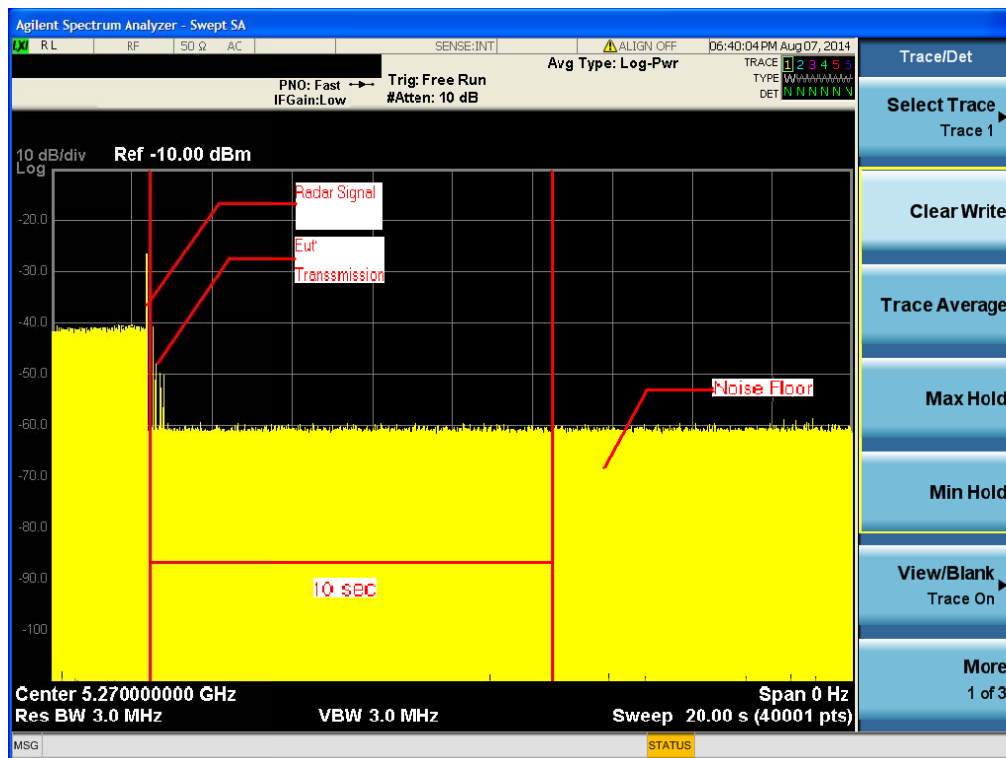

**Note:** An expanded plot for the device vacates the channel in the required 500ms

TX (11n 40MHz Mode)

Radar signal 4

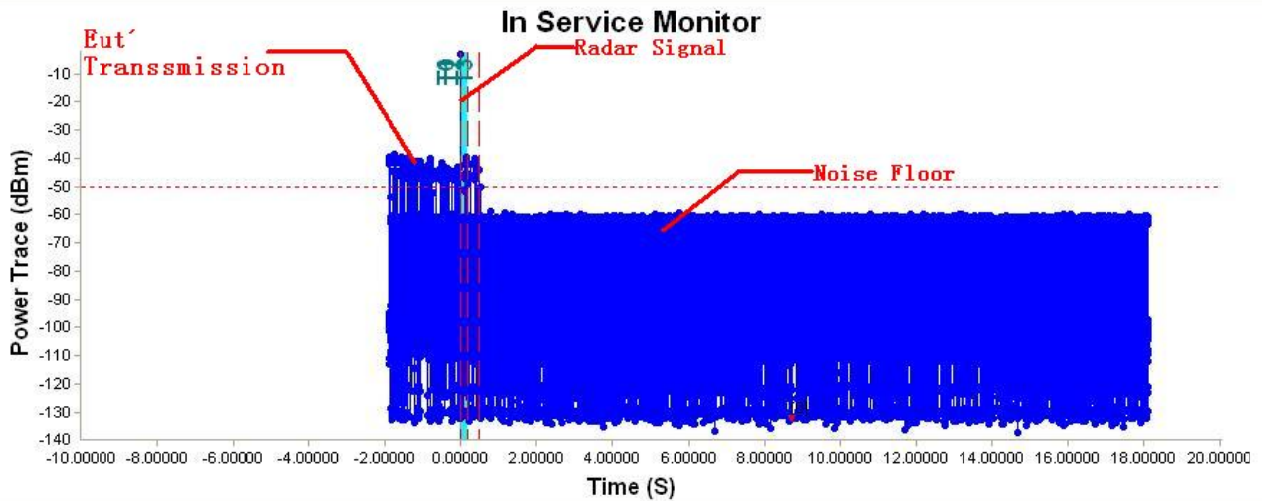

Time Index Info		
T0 : 0.00040 S	Time Per Bin: .499987500312492 ms	Channel Move Time: 0.4780 S
T1 : 0.20000 S	T2~T3 Bins Over Threshold: = 71 Bins	Channel Close Time: 3.54991125221869E-02 S
T2 : 0.20000 S		
T3 : 0.47800 S		

**Note:** T0 denotes the start of Channel Move Time upon the end of the last Radar burst.  
 T1 denotes the data transmission time of 200ms from T0.  
 T2 denotes the end of Channel Move Time.  
 T3 denotes the 10 second from T0 to observe the aggregate duration of transmissions.

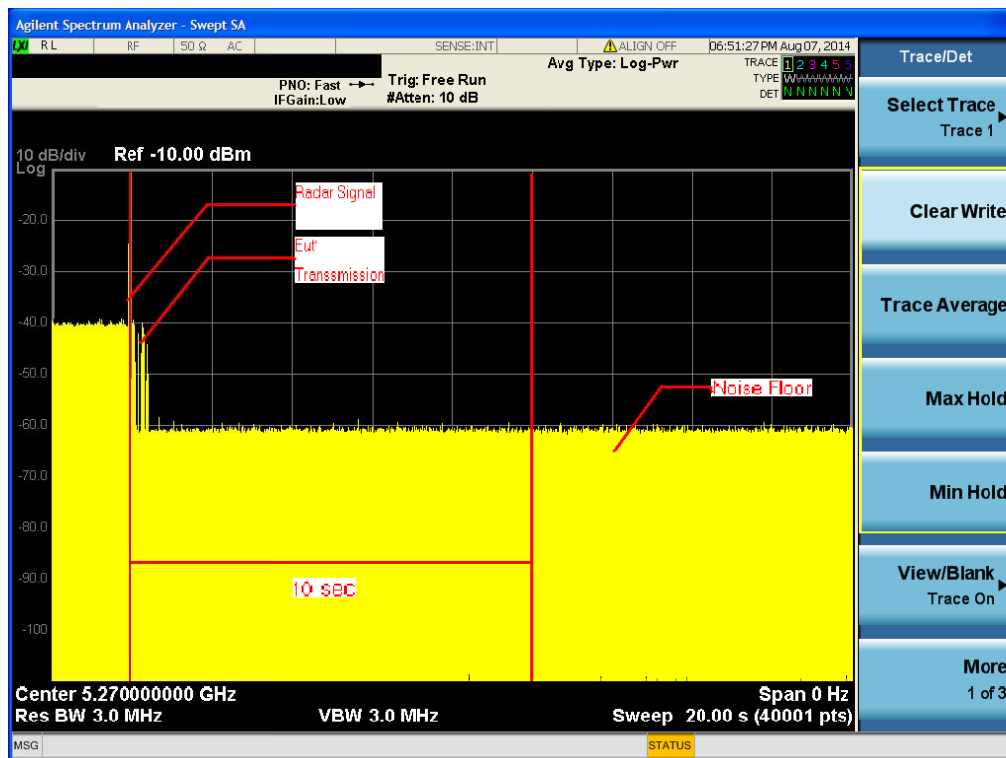

**Note:** An expanded plot for the device vacates the channel in the required 500ms

TX (11n 40MHz Mode)

Radar signal 5

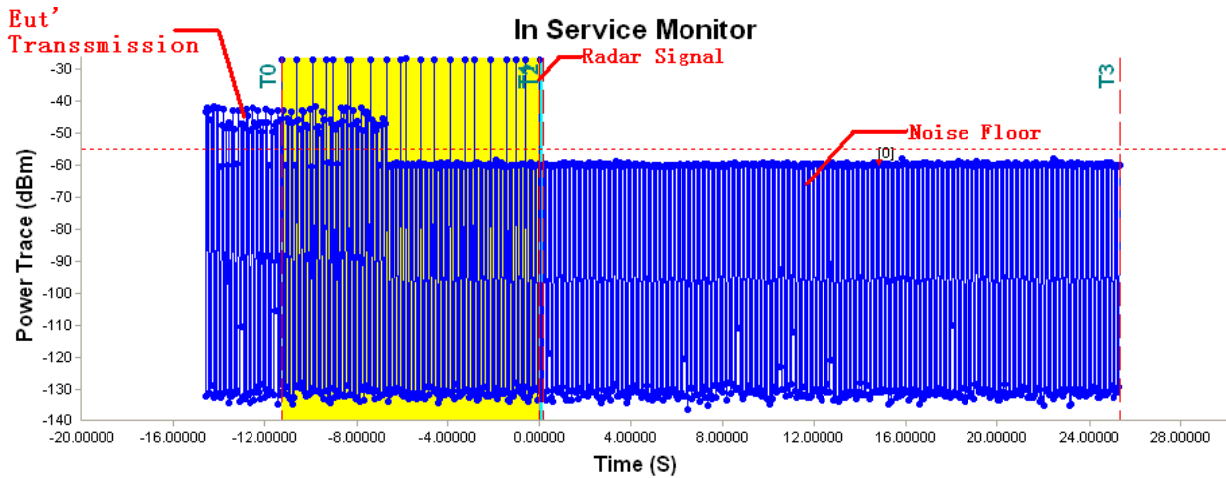

Time Index Info			
T0 : -11.2687 S	Time Per Bin: 39.96004 ms	Channel Move Time: 25.3346653 S	
T1 : 0.0000 S		Channel Close Time: 0.0 S	
T2 : 0.1998 S	T2~T3 Bins Over Threshold:		
T3 : 25.3347 S	= 0 Bins		

**Note:** T0 denotes the start of Channel Move Time upon the end of the last Radar burst.  
 T1 denotes the data transmission time of 200ms from T0.  
 T2 denotes the end of Channel Move Time.  
 T3 denotes the 10 second from T0 to observe the aggregate duration of transmissions.

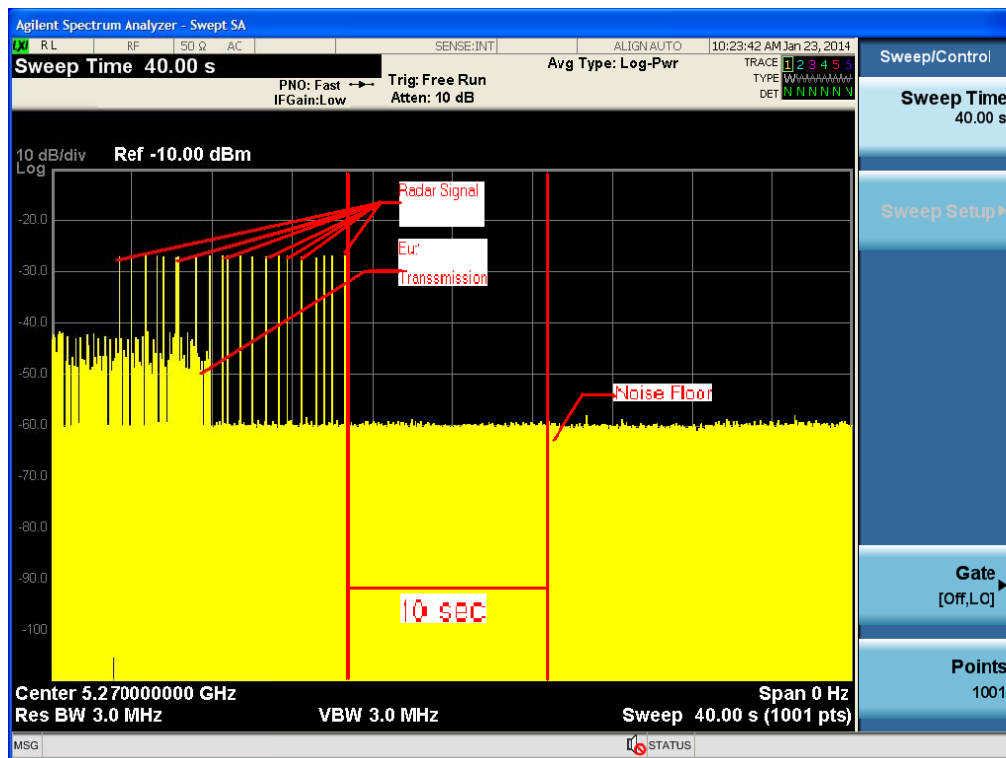

**Note:** An expanded plot for the device vacates the channel in the required 500ms

TX (11n 40MHz Mode)

Radar signal 6

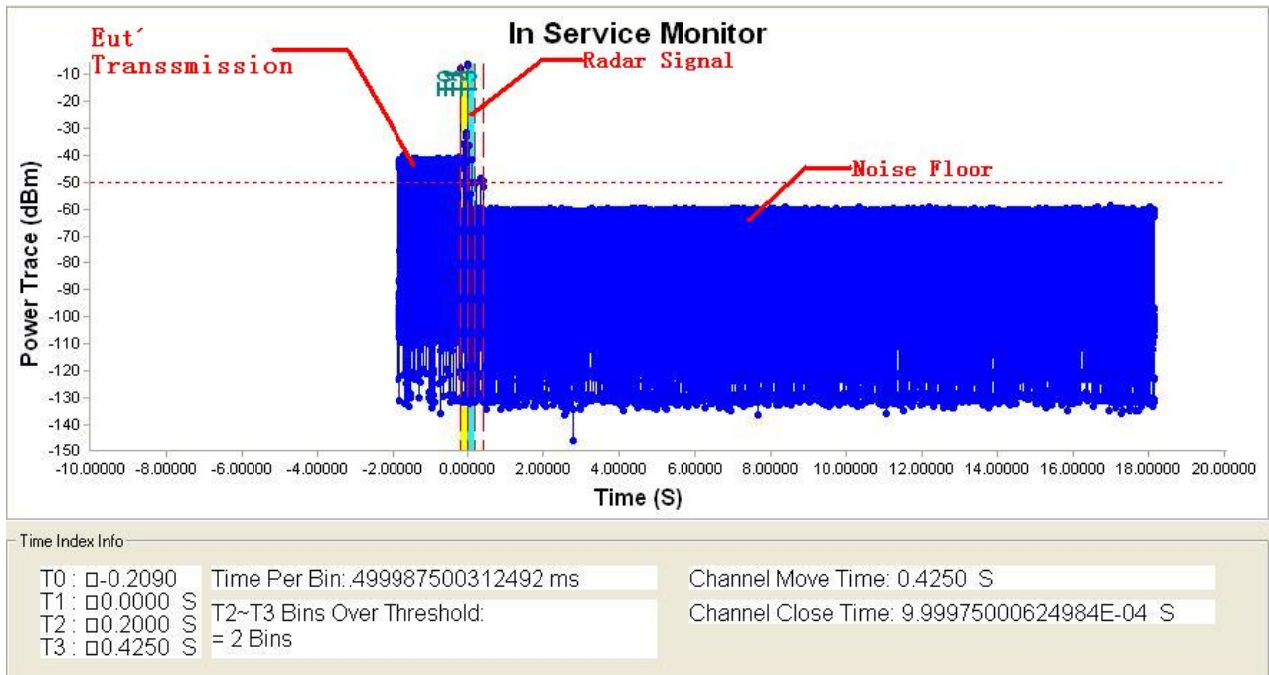

**Note:** T0 denotes the start of Channel Move Time upon the end of the last Radar burst.  
 T1 denotes the data transmission time of 200ms from T0.  
 T2 denotes the end of Channel Move Time.  
 T3 denotes the 10 second from T0 to observe the aggregate duration of transmissions.

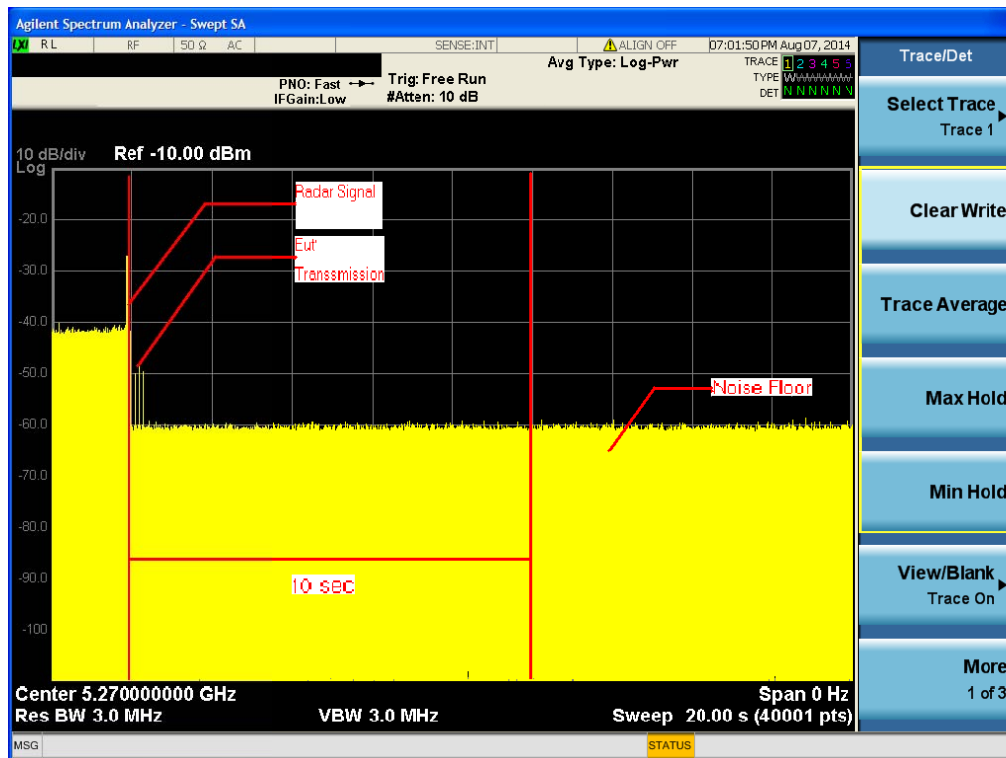

**Note:** An expanded plot for the device vacates the channel in the required 500ms

### 6.2.5 NON- OCCUPANCY PERIOD

During the 30 minutes observation time, UUT did not make any transmissions on a channel after a radar signal was detected on that channel by either the Channel Availability Check or the In-Service Monitoring.

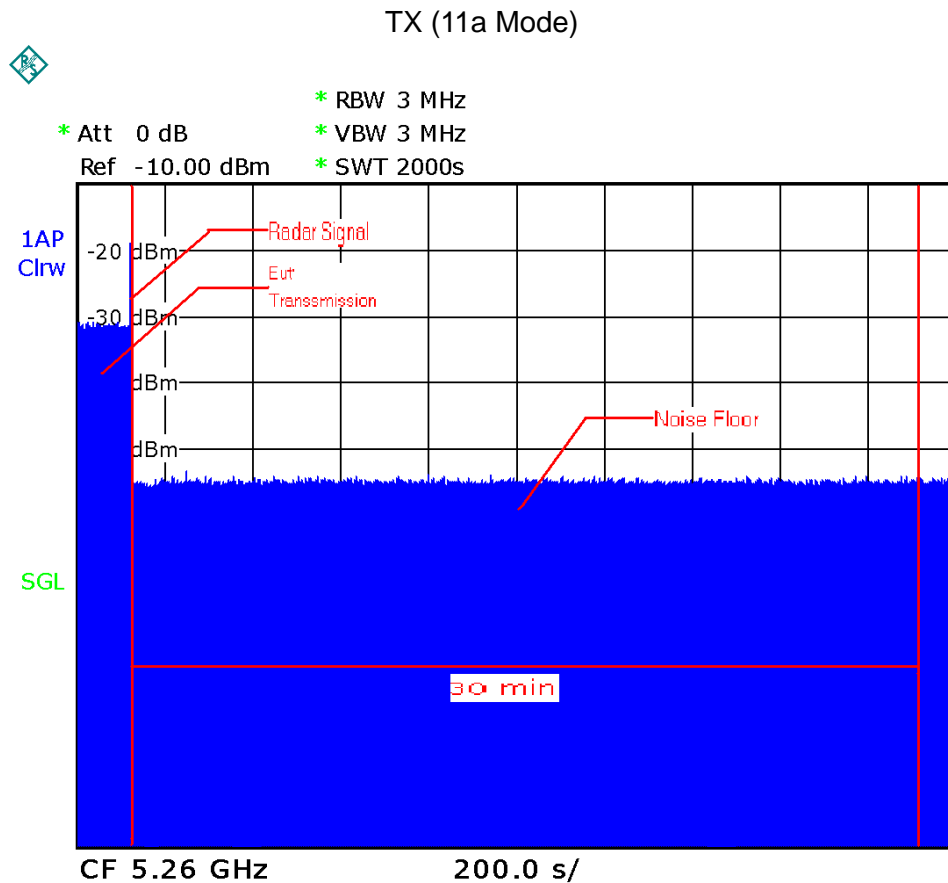

Date: 7.AUG.2014 18:15:44



TX (11n 40MHz Mode)

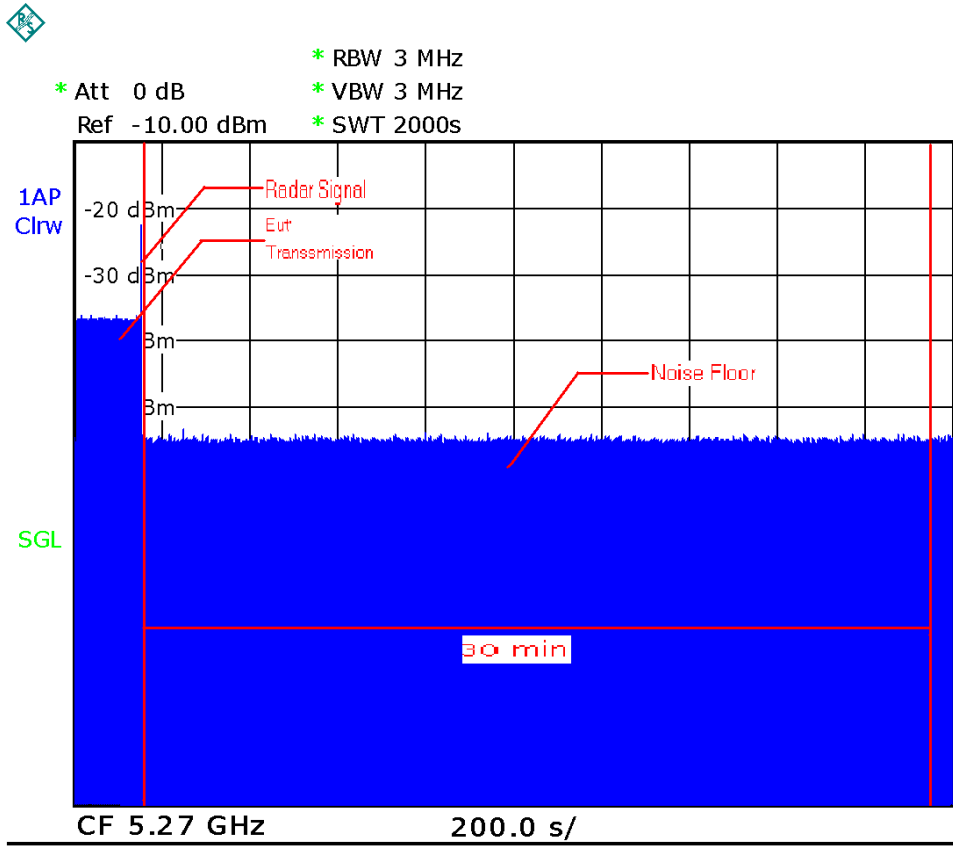

Date: 7.AUG.2014 18:09:42