

FCC&IC Radio Test Report

FCC ID: SIB-BGTAB-NV20A

IC: 6719D-BGTABNV20A

This report concerns (check one): Original Grant Class II Change

Project No. : 1407C097
Equipment : dreamtab
Model Name : BGTAB-NV20A
Applicant : Foxconn International Inc
Address : NO 2 ZIYOU ST TUCHENG DISTRICT NEW
TAIPEI Taiwan 236

Date of Receipt : Jul. 04, 2014
Date of Test : Jul. 14, 2014~Jul. 25, 2014
Issued Date : Jul. 28, 2014
Tested by : BTL Inc.

Testing Engineer : David Mao
(David Mao)

Technical Manager : Leo Hung
(Leo Hung)

Authorized Signatory : Steven Lu
(Steven Lu)

B T L I N C .

No.3,Jinshagang 1st Road, Shixia,Dalang Town, Dongguan, China.
TEL: +86-769-8318-3000FAX: +86-769-8319-6000

Declaration

BTL represents to the client that testing is done in accordance with standard procedures as applicable and that test instruments used has been calibrated with the standards traceable to National Measurement Laboratory (**NML**) of **CHINA**, or National Institute of Standards and Technology (**NIST**) of **U.S.A.**

BTL's reports apply only to the specific samples tested under conditions. It is manufacture's responsibility to ensure that additional production units of this model are manufactured with the identical electrical and mechanical components. **BTL** shall have no liability for any declarations, inferences or generalizations drawn by the client or others from **BTL** issued reports.

BTL's reports must not be used by the client to claim product endorsement by the authorities or any agency of the Government.

This report is the confidential property of the client. As a mutual protection to the clients, the public and **BTL-self**, extracts from the test report shall not be reproduced except in full with **BTL's** authorized written approval.

BTL's laboratory quality assurance procedures are in compliance with the **ISO Guide 17025** requirements, and accredited by the conformity assessment authorities listed in this test report.

Limitation

For the use of the authority's logo is limited unless the Test Standard(s)/Scope(s)/Item(s) mentioned in this test report is (are) included in the conformity assessment authorities acceptance respective.

Table of Contents	Page
1 . CERTIFICATION	7
2 . SUMMARY OF TEST RESULTS	8
2.1 TEST FACILITY	9
2.2 MEASUREMENT UNCERTAINTY	9
3 . GENERAL INFORMATION	10
3.1 GENERAL DESCRIPTION OF EUT	10
3.2 DESCRIPTION OF TEST MODES	12
3.3 TABLE OF PARAMETERS OF TEXT SOFTWARE SETTING	12
3.4 BLOCK DIAGRAM SHOWING THE CONFIGURATION OF SYSTEM TESTED	13
3.5 DESCRIPTION OF SUPPORT UNITS	14
4 . EMC EMISSION TEST	15
4.1 CONDUCTED EMISSION MEASUREMENT	15
4.1.1 POWER LINE CONDUCTED EMISSION LIMITS	15
4.1.2 TEST PROCEDURE	15
4.1.3 DEVIATION FROM TEST STANDARD	15
4.1.4 TEST SETUP	16
4.1.5 EUT OPERATING CONDITIONS	16
4.1.6 EUT TEST CONDITIONS	16
4.1.7 TEST RESULTS	16
4.2 RADIATED EMISSION MEASUREMENT	17
4.2.1 RADIATED EMISSION LIMITS	17
4.2.2 TEST PROCEDURE	18
4.2.3 DEVIATION FROM TEST STANDARD	18
4.2.4 TEST SETUP	19
4.2.5 EUT OPERATING CONDITIONS	20
4.2.6 EUT TEST CONDITIONS	20
4.2.7 TEST RESULTS (9KHZ TO 30MHZ)	20
4.2.8 TEST RESULTS (BETWEEN 30MHZ TO 1000 MHZ)	21
4.2.9 TEST RESULTS (ABOVE 1000 MHZ)	21
5 . NUMBER OF HOPPING CHANNEL	22
5.1 APPLIED PROCEDURES	22
5.1.1 TEST PROCEDURE	22
5.1.2 DEVIATION FROM STANDARD	22
5.1.3 TEST SETUP	22
5.1.4 EUT OPERATION CONDITIONS	22
5.1.5 EUT TEST CONDITIONS	22
5.1.6 TEST RESULTS	22

Table of Contents	Page
6 . AVERAGE TIME OF OCCUPANCY	23
6.1 APPLIED PROCEDURES / LIMIT	23
6.1.1 TEST PROCEDURE	23
6.1.2 DEVIATION FROM STANDARD	23
6.1.3 TEST SETUP	23
6.1.4 EUT OPERATION CONDITIONS	24
6.1.5 EUT TEST CONDITIONS	24
6.1.6 TEST RESULTS	24
7 . HOPPING CHANNEL SEPARATION MEASUREMENT	25
7.1 APPLIED PROCEDURES / LIMIT	25
7.1.1 TEST PROCEDURE	25
7.1.2 DEVIATION FROM STANDARD	25
7.1.3 TEST SETUP	25
7.1.4 EUT TEST CONDITIONS	25
7.1.5 TEST RESULTS	25
8 . BANDWIDTH TEST	26
8.1 APPLIED PROCEDURES	26
8.1.1 TEST PROCEDURE	26
8.1.2 DEVIATION FROM STANDARD	26
8.1.3 TEST SETUP	26
8.1.4 EUT OPERATION CONDITIONS	26
8.1.5 EUT TEST CONDITIONS	26
8.1.6 TEST RESULTS	26
9 . PEAK OUTPUT POWER TEST	27
9.1 APPLIED PROCEDURES / LIMIT	27
9.1.1 TEST PROCEDURE	27
9.1.2 DEVIATION FROM STANDARD	27
9.1.3 TEST SETUP	27
9.1.4 EUT OPERATION CONDITIONS	27
9.1.5 EUT TEST CONDITIONS	27
9.1.6 TEST RESULTS	27
10 . ANTENNA CONDUCTED SPURIOUS EMISSION	28
10.1 APPLIED PROCEDURES / LIMIT	28
10.1.1 TEST PROCEDURE	28
10.1.2 DEVIATION FROM STANDARD	28
10.1.3 TEST SETUP	28
10.1.4 EUT OPERATION CONDITIONS	28
10.1.5 EUT TEST CONDITIONS	28
10.1.6 TEST RESULTS	28
11 . MEASUREMENT INSTRUMENTS LIST	29

Table of Contents	Page
12 . EUT TEST PHOTO	31
ATTACHMENT A - CONDUCTED EMISSION	35
ATTACHMENT B - RADIATED EMISSION (9KHZ-30MHZ)	38
ATTACHMENT C - RADIATED EMISSION (30MHZ TO 1000MHZ)	40
ATTACHMENT D - RADIATED EMISSION (ABOVE 1000MHZ)	47
ATTACHMENT E - NUMBER OF HOPPING CHANNEL	72
ATTACHMENT F - AVERAGE TIME OF OCCUPANCY	74
ATTACHMENT G - HOPPING CHANNEL SEPARATION MEASUREMENT	87
ATTACHMENT H - BANDWIDTH	92
ATTACHMENT I - PEAK OUTPUT POWER	97
ATTACHMENT J - ANTENNA CONDUCTED SPURIOUS EMISSION	102

REPORT ISSUED HISTORY

Issued No.	Description	Issued Date
NEI-FICP-1-1407C097	Original Issue.	Jul. 28, 2014

1. CERTIFICATION

Equipment : dreamtab
Brand Name : FUHU
Model Name : BGTAB-NV20A
Applicant : Foxconn International Inc
Manufacturer : FUHU INC.
Address : 909N., Sepulveda Blvd., Suite 540, E1 Segundo, CA 90245
Factory : HONGFUJIN Precision Electronics (Chong Qing) Co., Ltd.
Address : No.1, 1st E District RD., Shapingba District, Chongqing 401332, P.R. China
Date of Test : Jul. 14, 2014~Jul. 25, 2014
Test Item : ENGINEERING SAMPLE
Standard(s) : FCC Part15, Subpart C : 2013 (15.247) / ANSI C63.4 : 2009 /
FCC Public Notice DA 00-705, March 30, 2000.
Canada RSS-210: 2010
RSS-GEN Issue 3, Dec 2010

The above equipment has been tested and found compliance with the requirement of the relative standards by BTL Inc.

The test data, data evaluation, and equipment configuration contained in our test report (Ref No. NEI-FICP-1-1407C097) were obtained utilizing the test procedures, test instruments, test sites that has been accredited by the Authority of TAF according to the ISO-17025 quality assessment standard and technical standard(s).

2. SUMMARY OF TEST RESULTS

Test procedures according to the technical standard(s):

Applied Standard(s): 47 CFR Part 15, Subpart C: 2013; Canada RSS-210:2010; RSS-GEN Issue 3, Dec 2010				
Standard(s) Section		Test Item	Judgment	Remark
FCC	IC			
15.207	RSS-GEN Issue 3, Dec 2010 7.2.4	Conducted Emission	PASS	
15.247(d)	RSS-210, Issue 8, Annex 8, A8.5	Antenna conducted Spurious Emission	PASS	
15.247 (a)(1)	RSS-210, Issue 8, Annex 8, A8.1(b)	Hopping Channel Separation	PASS	
15.247 (b)(1)	RSS-210, Issue 8, Annex 8, A8.1(b)	Peak Output Power	PASS	
15.247(d) 15.209	RSS-210, Issue 8, Annex 8, Section 8.5	Radiated Spurious Emission	PASS	
15.247 (a)(1)(iii)	RSS-210, Issue 8, Annex 8, A8.1(d)	Number of Hopping Frequency	PASS	
15.247 (a)(1)(iii)	RSS-210, Issue 8, Annex 8, A8.1(d)	Dwell Time	PASS	
15.205	RSS-GEN Issue 3, Dec 2010 7.2.2	Restricted Bands	PASS	
15.203	-	Antenna Requirement	PASS	

Note:

- (1) "N/A" denotes test is not applicable in this test report
- (2) According to FCC Public Notice DA 00-705, March 30, 2000.

2.1 TEST FACILITY

The test facilities used to collect the test data in this report is **DG-C02/DG-CB03** at the location of No.3,Jinshagang 1st Road, Shixia, Dalang Town, Dong Guan, China.523792

BTL's test firm number for FCC: 319330

BTL's test firm number for IC: 4428B-1

2.2 MEASUREMENT UNCERTAINTY

Where relevant, the following measurement uncertainty levels have been estimated for tests performed on the EUT as specified in CISPR 16-4-2:

The reported uncertainty of measurement $y \pm U$, where expanded uncertainty U is based on a standard uncertainty multiplied by a coverage factor of $k=2$, providing a level of confidence of approximately **95 %**.

A. Conducted Measurement :

Test Site	Method	Measurement Frequency Range	U , (dB)	Note
DG-C02	CISPR	150 KHz ~ 30MHz	1.94	

B. Radiated Measurement :

Test Site	Method	Measurement Frequency Range	Ant. H / V	U , (dB)	Note
DG-CB03	CISPR	9KHz~30MHz	V	3.79	
		9KHz~30MHz	H	3.57	
		30MHz ~ 200MHz	V	3.82	
		30MHz ~ 200MHz	H	3.60	
		200MHz ~ 1,000MHz	V	3.86	
		200MHz ~ 1,000MHz	H	3.94	
		1GHz~18GHz	V	3.12	
		1GHz~18GHz	H	3.68	
		18GHz~40GHz	V	4.15	
		18GHz~40GHz	H	4.14	

3. GENERAL INFORMATION

3.1 GENERAL DESCRIPTION OF EUT

Equipment	dreamtab	
Brand Name	FUHU	
Model Name	BGTAB-NV20A	
Model Difference	N/A	
Output Power (Max.)	Operation Frequency	2402~2480 MHz
	Modulation Technology	GFSK(1Mbps) $\pi/4$ -DQPSK(2Mbps)
	Bit Rate of Transmitter	8-DPSK(3Mbps)
	Output Power Max.	-1.29 dBm(1Mbps) -2.33 dBm(3Mbps)
Power Source	#1 DC supplied from AC Adapter. Model: ADS-65LSI-19-3 19065G #2 Supplied from rechargeable Li-ion polymer battery. Brand / Model: McNair / MLP2462113-4S	
Power Rating	#1 I/P AC 100-240V~ 50/60Hz 1.5A O/P: DC 19V 3.42A #2 DC14.8V 1650mAh 24.42Wh	
Connecting I/O Port(s)	Please refer to the User' Manual	

Note:

1. For a more detailed features description, please refer to the manufacturer's specifications or the User's Manual.

2.

Channel List					
Channel	Frequency (MHz)	Channel	Frequency (MHz)	Channel	Frequency (MHz)
00	2402	27	2429	54	2456
01	2403	28	2430	55	2457
02	2404	29	2431	56	2458
03	2405	30	2432	57	2459
04	2406	31	2433	58	2460
05	2407	32	2434	59	2461
06	2408	33	2435	60	2462
07	2409	34	2436	61	2463
08	2410	35	2437	62	2464
09	2411	36	2438	63	2465
10	2412	37	2439	64	2466
11	2413	38	2440	65	2467
12	2414	39	2441	66	2468
13	2415	40	2442	67	2469
14	2416	41	2443	68	2470
15	2417	42	2444	69	2471
16	2418	43	2445	70	2472
17	2419	44	2446	71	2473
18	2420	45	2447	72	2474
19	2421	46	2448	73	2475
20	2422	47	2449	74	2476
21	2423	48	2450	75	2477
22	2424	49	2451	76	2478
23	2425	50	2452	77	2479
24	2426	51	2453	78	2480
25	2427	52	2454		
26	2428	53	2455		

3 Table for Filed Antenna

The product has 2 group antenna: MAG Corporation and FOXCONN .

Group 1

Ant.	Manufacturer	Model Name	Antenna Type	Connector	Gain (dBi)	Length
1	FOXCONN	PCA-3007-25GC1-A3	PIFA	N/A	2.32	320mm
2	FOXCONN	PCA-3007-25GC1-A4	PIFA	N/A	0.21	600mm

Group 2

Ant.	Manufacturer	Model Name	Antenna Type	Connector	Gain (dBi)	Note
1	MAG Corporation	PCA-3007-25GC1-A3	PIFA	N/A	0.07	320mm
2	MAG Corporation	PCA-3007-25GC1-A4	PIFA	N/A	0.74	600mm

3.2 DESCRIPTION OF TEST MODES

To investigate the maximum EMI emission characteristics generated from EUT, the test system was pre-scanning tested based on the consideration of following EUT operation mode or test configuration mode which possibly have effect on EMI emission level. Each of these EUT operation mode(s) or test configuration mode(s) mentioned above was evaluated respectively.

Pretest Mode	Description
Mode 1	TX Mode Note (1)
Mode 2	Bluetooth

The EUT system operated these modes were found to be the worst case during the pre-scanning test as following:

For Conducted Emission	
Final Test Mode	Description
Mode 2	Bluetooth

For Radiated Emission	
Final Test Mode	Description
Mode 1	TX Mode Note (1)

Note:

- (1) The measurements are performed at the high, middle, low available channels.
- (2) The measurements for Hopping Channel Separation, Bandwidth and Peak Output Power were tested during 1Mbps, 2Mbps and 3Mbps, the worst case are 1Mbps and 3Mbps, only worst case was documented.
- (3) The EUT is considered a portable unit; it was pre-tested on the positioned of each 3 axis. The worst case was found positioned on Z-plane. Therefore only the test data of this Z-plane was used for radiated emission measurement test.

3.3 TABLE OF PARAMETERS OF TEXT SOFTWARE SETTING

During testing, channel & power controlling software provided by the customer was used to control the operating channel as well as the output power level. The RF output power selection is for the setting of RF output power expected by the customer and is going to be fixed on the firmware of the final end product power parameters of FHSS

1Mbps

Test Software	N/A		
Frequency	2402	2441	2480
Parameters	0X0	0X0	0X0

3Mbps

Test Software	N/A		
Frequency	2402 MHz	2441 MHz	2480 MHz
Parameters	0X0	0X0	0X0

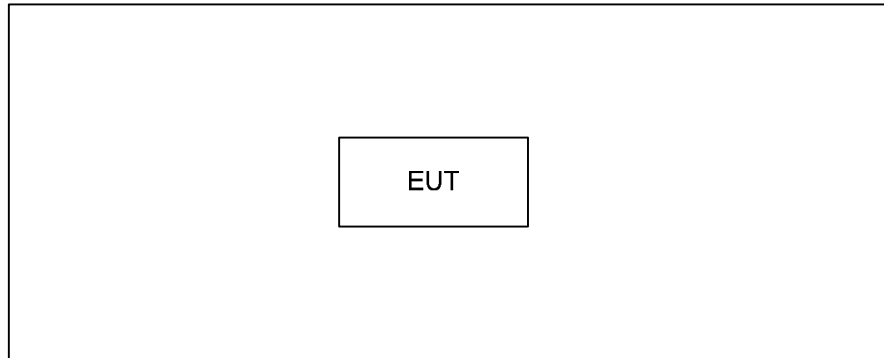
3.4 BLOCK DIAGRAM SHOWING THE CONFIGURATION OF SYSTEM TESTED

3.5 DESCRIPTION OF SUPPORT UNITS

The EUT has been tested as an independent unit together with other necessary accessories or support units. The following support units or accessories were used to form a representative test configuration during the tests.

Item	Equipment	Mfr/Brand	Model/Type No.	FCC ID/IC	Series No.	Note
-	-	-	-	-	-	

Item	Shielded Type	Ferrite Core	Length	Note
-	-	-	-	

4. EMC EMISSION TEST

4.1 CONDUCTED EMISSION MEASUREMENT

4.1.1 POWER LINE CONDUCTED EMISSION Limits (Frequency Range 150KHz-30MHz)

Frequency of Emission (MHz)	Conducted Limit (dB μ V)	
	Quasi-peak	Average
0.15 -0.5	66 to 56*	56 to 46*
0.50 -5.0	56	46
5.0 -30.0	60	50

Note:

(1) The limit of " * " decreases with the logarithm of the frequency

The following table is the setting of the receiver

Receiver Parameters	Setting
Attenuation	10 dB
Start Frequency	0.15 MHz
Stop Frequency	30 MHz
IF Bandwidth	9 KHz

4.1.2 TEST PROCEDURE

- The EUT was placed 0.8 meters from the horizontal ground plane with EUT being connected to the power mains through a line impedance stabilization network (LISN). All other support equipments powered from additional LISN(s). The LISN provide 50 Ohm/ 50uH of coupling impedance for the measuring instrument.
- Interconnecting cables that hang closer than 40 cm to the ground plane shall be folded back and forth in the center forming a bundle 30 to 40 cm long.
- I/O cables that are not connected to a peripheral shall be bundled in the center. The end of the cable may be terminated, if required, using the correct terminating impedance. The overall length shall not exceed 1 m.
- LISN at least 80 cm from nearest part of EUT chassis.
- For the actual test configuration, please refer to the related Item –EUT Test Photos.

4.1.3 DEVIATION FROM TEST STANDARD

No deviation

4.1.4 TEST SETUP

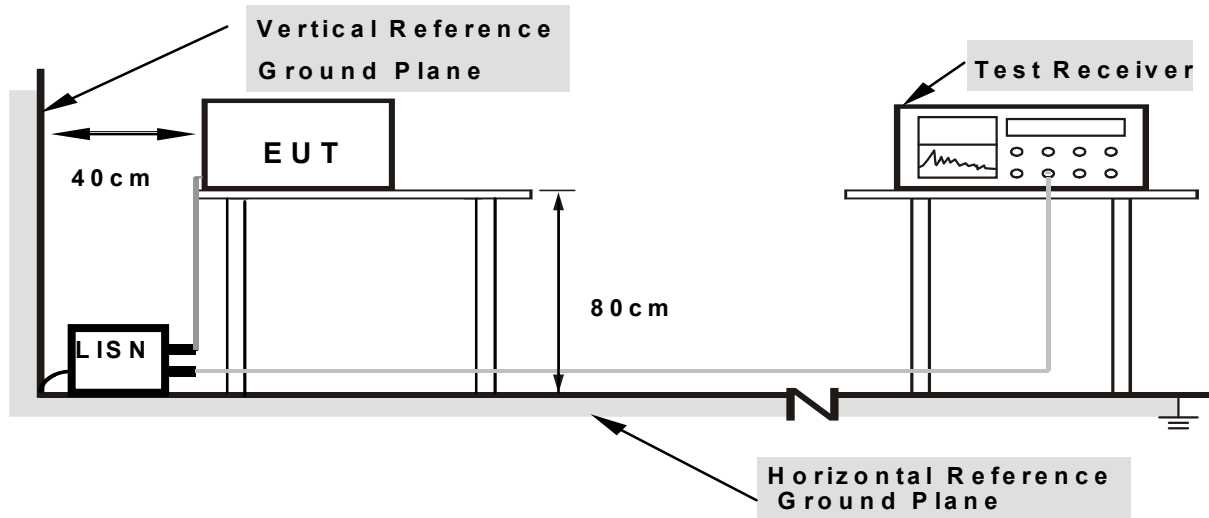

- Note:**
1. Support units were connected to second LISN.
 2. Both of LISNs (AMN) are 80 cm from EUT and at least 80 from other units and other metal planes

4.1.5 EUT OPERATING CONDITIONS

The EUT was configured for testing in a typical function (as a customer would normally use it), EUT was programmed to be in continuously transmitting/receiving data or hopping on mode.

4.1.6 EUT TEST CONDITIONS

Temperature: 25°C
 Relative Humidity: 55%
 Test Voltage: DC14.8V

4.1.7 TEST RESULTS

Please refer to the Attachment A.

Remark:

- (1) All readings are QP Mode value unless otherwise stated AVG in column of Note. If the QP Mode Measured value compliance with the QP Limits and lower than AVG Limits, the EUT shall be deemed to meet both QP & AVG Limits and then only QP Mode was measured, but AVG Mode didn't perform in this case, a "*" marked in AVG Mode column of Interference Voltage Measured.
- (2) Measuring frequency range from 150KHz to 30MHz.

4.2 RADIATED EMISSION MEASUREMENT

4.2.1 RADIATED EMISSION LIMITS (Frequency Range 9KHz -1000MHz)

20dB in any 100 KHz bandwidth outside the operating frequency band. In case the emission fall within the restricted band specified on 15.205(a) & RSS-210 section 2.2& Annex 8 (A8.5), then the 15.209(a) & RSS-Gen limit in the table below has to be followed.

Frequency (MHz)	Field Strength (microvolts/meter)	Measurement Distance (meters)
0.009~0.490	2400/F(KHz)	300
0.490~1.705	24000/F(KHz)	30
1.705~30.0	30	30
30~88	100	3
88~216	150	3
216~960	200	3
960~1000	500	3

LIMITS OF RADIATED EMISSION MEASUREMENT (Above 1000MHz)

Frequency (MHz)	dB(uV/m) (at 3 meters)	
	Peak	Average
Above 1000	74	54

Notes:

- (1) The limit for radiated test was performed according to FCC PART 15C.
- (2) The tighter limit applies at the band edges.
- (3) Emission level (dBuV/m) =20log Emission level (uV/m).

Spectrum Parameter	Setting
Attenuation	Auto
Start Frequency	1000 MHz
Stop Frequency	10th carrier harmonic
RBW / VBW (emission in restricted band)	1 MHz / 1 MHz for Peak, 1 MHz / 10Hz for Average

Spectrum Receiver Parameter	Setting
Attenuation	Auto
Start ~ Stop Frequency	9KHz ~90KHz for PK/AVG detector
Start ~ Stop Frequency	90KHz ~110KHz for QP detector
Start ~ Stop Frequency	110KHz ~490KHz for PK/AVG detector
Start ~ Stop Frequency	490KHz ~30MHz for QP detector
Start ~ Stop Frequency	30MHz~1000MHz for QP detector

4.2.2 TEST PROCEDURE

- a. The EUT was placed on the top of a rotating table 0.8 meters above the ground at a 3 meter semi-anechoic chamber. The table was rotated 360 degrees to determine the position of the highest radiation.(below 1GHz)
- b. The EUT was placed on the top of a rotating table 0.8 meters above the ground at a 3 meter semi-anechoic chamber. The table was rotated 360 degrees to determine the position of the highest radiation.(above 1GHz)
- c. The height of the equipment or of the substitution antenna shall be 0.8 m; the height of the test antenna shall vary between 1 m to 4 m. Both horizontal and vertical polarizations of the antenna are set to make the measurement.
- d. The initial step in collecting conducted emission data is a spectrum analyzer peak detector mode pre-scanning the measurement frequency range. Significant peaks are then marked and then Quasi Peak detector mode re-measured.
- e. If the Peak Mode measured value compliance with and lower than Quasi Peak Mode Limit, the EUT shall be deemed to meet QP Limits and then no additional QP Mode measurement performed.
- f. For the actual test configuration, please refer to the related Item –EUT Test Photos.

4.2.3 DEVIATION FROM TEST STANDARD

No deviation

4.2.4 TEST SETUP

(A) Radiated Emission Test Set-Up Frequency Below 1 GHz

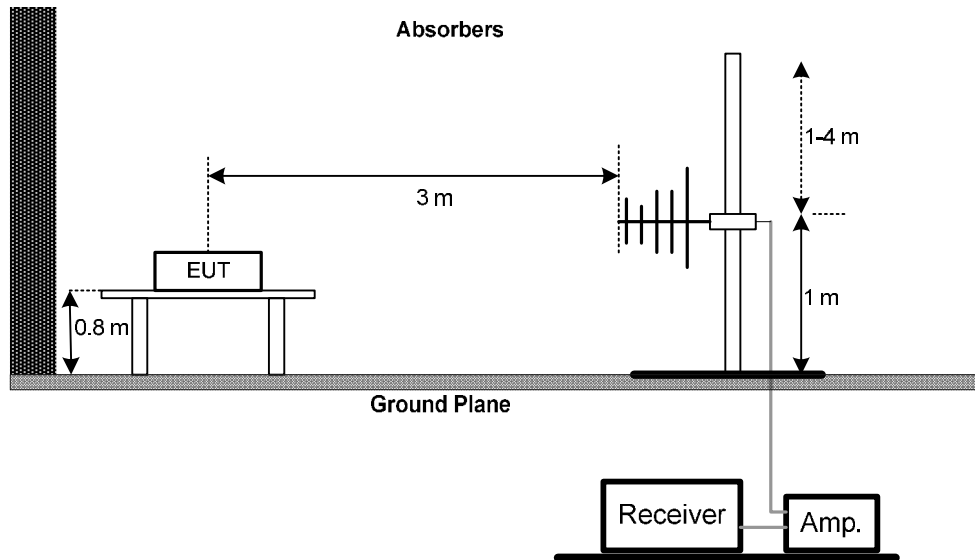

(B) Radiated Emission Test Set-Up Frequency Above 1 GHz

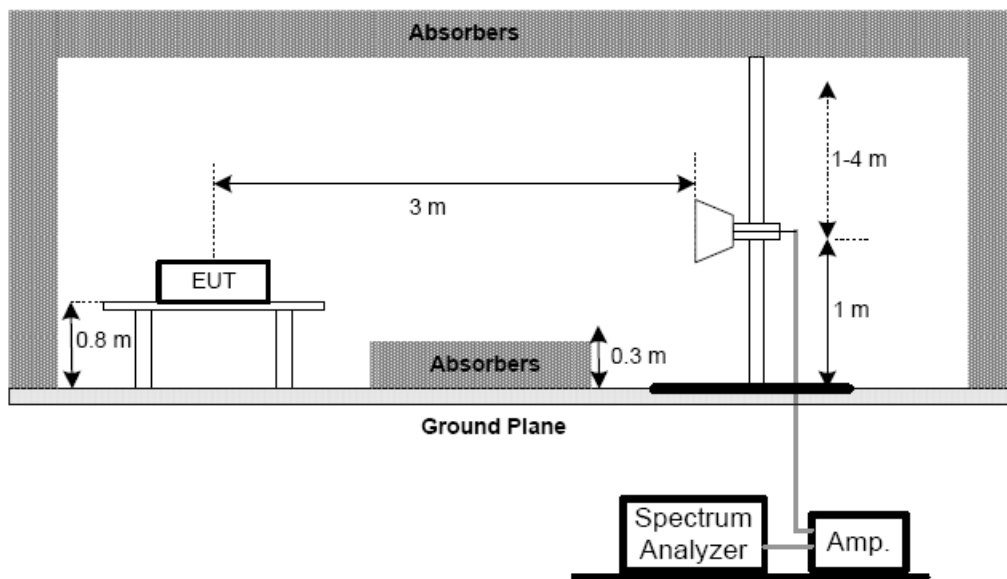

(C) For radiated emissions below 30MHz

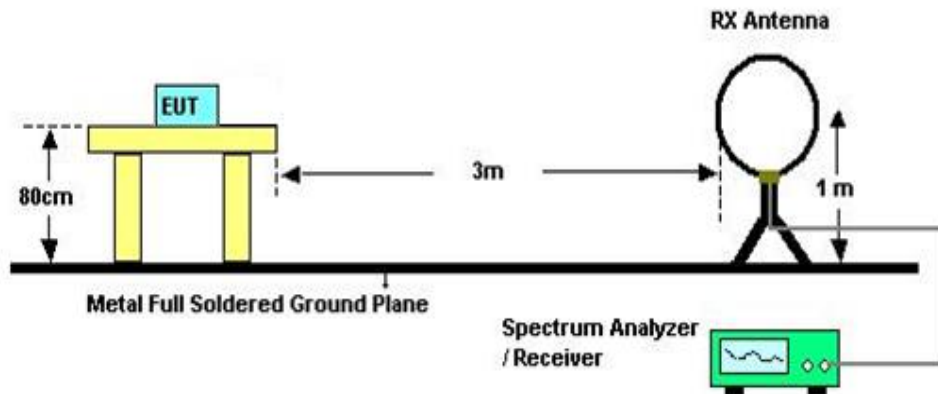

4.2.5 EUT OPERATING CONDITIONS

The EUT tested system was configured as the statements of 4.1.5 Unless otherwise a special operating condition is specified in the follows during the testing

4.2.6 EUT TEST CONDITIONS

Temperature: 25°C
 Relative Humidity: 55%
 Test Voltage: DC14.8V

4.2.7 TEST RESULTS (9KHZ TO 30MHZ)

Please refer to the Attachment B

Remark:

- (1) The amplitude of spurious emissions which are attenuated by more than 20 dB below the permissible value has no need to be reported.
- (2) Distance extrapolation factor = $40 \log (\text{specific distance} / \text{test distance})$ (dB).
- (3) Limit line = specific limits (dBuV) + distance extrapolation factor.

4.2.8 TEST RESULTS (BETWEEN 30MHZ TO 1000 MHZ)

Please refer to the Attachment C.

Remark:

- (1) Reading in which marked as QP or Peak means measurements by using are Quasi-Peak Mode or Peak Mode with Detector BW=120KHz ; SPA setting in RBW=120KHz, VBW =120KHz, Swp. Time = 0.3 sec./MHz.
- (2) All readings are Peak unless otherwise stated QP in column of 『Note 』 . Peak denotes that the Peak reading compliance with the QP Limits and then QP Mode measurement didn't perform.
- (3) Measuring frequency range from 30MHz to 1000MHz.
- (4) If the peak scan value lower limit more than 20dB, then this signal data does not show in table.

4.2.9 TEST RESULTS (ABOVE 1000 MHZ)

Please refer to the Attachment D.

Remark:

- (1) All readings are Peak unless otherwise stated QP in column of 『Note 』 . Peak denotes that the Peak reading compliance with the QP Limits and then QP Mode measurement didn't perform.
- (2) Radiated emissions measured in frequency range above 1000MHz were made with an instrument using Peak detector mode and AV detector mode of the emission
- (3) A preamp and high pass filter were used for this test in order to provide sufficient measurement sensitivity.
- (4) EUT Orthogonal Axis:
"X" - denotes Laid on Table ; "Y" - denotes Vertical Stand ; "Z" - denotes Side Stand
- (5) During the measurements above 1 GHz it is taken care of that the EUT is always within the 3 dB cone of radiation BW of the used antenna

5. NUMBER OF HOPPING CHANNEL

5.1 APPLIED PROCEDURES

FCC Part15 (15.247) , Subpart C/ RSS-GEN and RSS-210			
Section	Test Item	Frequency Range (MHz)	Result
15.247(a)(1)(iii) RSS-210, Issue 8, Annex 8, A8.1(d)	Number of Hopping Channel	2400-2483.5	PASS

Spectrum Parameters	Setting
Attenuation	Auto
Span Frequency	> Operating Frequency Range
RBW	100 KHz
VBW	100 KHz
Detector	Peak
Trace	Max Hold
Sweep Time	Auto

5.1.1 TEST PROCEDURE

- a. The EUT was directly connected to the spectrum analyzer and antenna output port as show in the block diagram below,
- b. Spectrum Setting: RBW=100KHz, VBW=100KHz, Sweep time = Auto.

5.1.2 DEVIATION FROM STANDARD

No deviation.

5.1.3 TEST SETUP

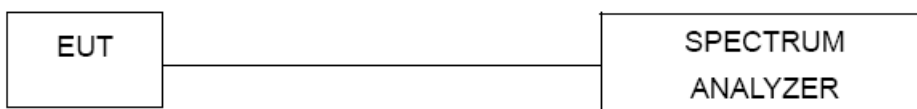

5.1.4 EUT OPERATION CONDITIONS

The EUT tested system was configured as the statements of 4.1.5 Unless otherwise a special operating condition is specified in the follows during the testing.

5.1.5 EUT TEST CONDITIONS

Temperature: 25°C
 Relative Humidity: 55%
 Test Voltage: DC14.8V

5.1.6 TEST RESULTS

Please refer to the Attachment E

6. AVERAGE TIME OF OCCUPANCY

6.1 APPLIED PROCEDURES / LIMIT

FCC Part15 (15.247) , Subpart C/ RSS-GEN and RSS-210				
Section	Test Item	Limit	Frequency Range (MHz)	Result
15.247(a)(1)(iii) RSS-210, Issue 8, Annex 8, A8.1(d)	Average Time of Occupancy	0.4sec	2400-2483.5	PASS

6.1.1 TEST PROCEDURE

- a. The transmitter output (antenna port) was connected to the spectrum analyzer
- b. Set RBW of spectrum analyzer to 1MHz and VBW to 1MHz.
- c. Use a video trigger with the trigger level set to enable triggering only on full pulses.
- d. Sweep Time is more than once pulse time.
- e. Set the center frequency on any frequency would be measure and set the frequency span to zero span.
- f. Measure the maximum time duration of one single pulse.
- g. Set the EUT for DH5, DH3 and DH1 packet transmitting.
- h. Measure the maximum time duration of one single pulse.
- i. DH5 Packet permit maximum $1600 / 79 / 6 = 3.37$ hops per second in each channel (5 time slots TX, 1 time slot RX). So, the dwell time is the time duration of the pulse times $3.37 \times 31.6 = 106.6$ within 31.6 seconds.
- j. DH3 Packet permit maximum $1600 / 79 / 4 = 5.06$ hops per second in each channel (3 time slots TX, 1 time slot RX). So, the dwell time is the time duration of the pulse times $5.06 \times 31.6 = 160$ within 31.6 seconds.
- k. DH1 Packet permit maximum $1600 / 79 / 2 = 10.12$ hops per second in each channel (1 time slot TX, 1 time slot RX). So, the dwell time is the time duration of the pulse times $10.12 \times 31.6 = 320$ within 31.6 seconds.

6.1.2 DEVIATION FROM STANDARD

No deviation.

6.1.3 TEST SETUP

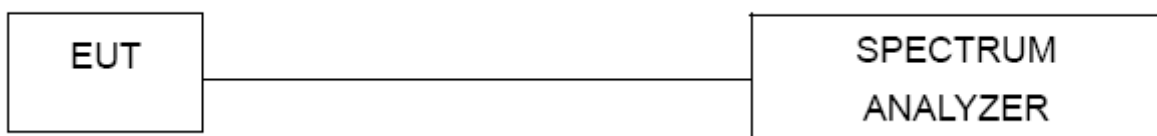

6.1.4 EUT OPERATION CONDITIONS

The EUT tested system was configured as the statements of 4.1.5 Unless otherwise a special operating condition is specified in the follows during the testing.

6.1.5 EUT TEST CONDITIONS

Temperature: 25°C

Relative Humidity: 55%

Test Voltage: DC14.8V

6.1.6 TEST RESULTS

Please refer to the Attachment F

7. HOPPING CHANNEL SEPARATION MEASUREMENT

7.1 APPLIED PROCEDURES / LIMIT

Frequency hopping systems operating in the 2400-2483.5 MHz band may have hopping channel carrier frequencies that are separated by 25 KHz or two-thirds of the 20 dB bandwidth of the hopping channel, whichever is greater.

Spectrum Parameter	Setting
Attenuation	Auto
Span Frequency	> Measurement Bandwidth or Channel Separation
RBW	30 KHz
VBW	100 KHz
Detector	Peak
Trace	Max Hold
Sweep Time	Auto

7.1.1 TEST PROCEDURE

- a. The EUT must have its hopping function enabled
- b. Span = wide enough to capture the peaks of two adjacent channels
 - Resolution (or IF) Bandwidth (RBW) \geq 1% of the span
 - Video (or Average) Bandwidth (VBW) \geq RBW
 - Sweep = Auto
 - Detector function = Peak
 - Trace = Max Hold

7.1.2 DEVIATION FROM STANDARD

No deviation.

7.1.3 TEST SETUP

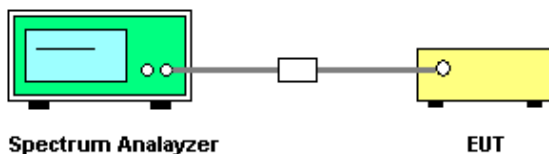

7.1.4 EUT TEST CONDITIONS

Temperature: 25°C
 Relative Humidity: 55%
 Test Voltage: DC14.8V

7.1.5 TEST RESULTS

Please refer to the Attachment G

8. BANDWIDTH TEST

8.1 APPLIED PROCEDURES

FCC Part15 (15.247) , Subpart C/ RSS-GEN and RSS-210		
Section	Test Item	Frequency Range (MHz)
15.247(a)(2) RSS-GEN section 4.6.1 RSS-210, Issue 8, Annex 8, A8.1(b)	Bandwidth	2400-2483.5

Spectrum Parameter	Setting
Attenuation	Auto
Span Frequency	> Measurement Bandwidth or Channel Separation
RBW	30 KHz (20dB Bandwidth) / 30 KHz (Channel Separation)
VBW	100 KHz (20dB Bandwidth) / 100 KHz (Channel Separation)
Detector	Peak
Trace	Max Hold
Sweep Time	Auto

8.1.1 TEST PROCEDURE

- a. The EUT was directly connected to the spectrum analyzer and antenna output port as show in the block diagram below,
- b. Spectrum Setting: RBW= 30KHz, VBW=100KHz, Sweep Time = Auto.

8.1.2 DEVIATION FROM STANDARD

No deviation.

8.1.3 TEST SETUP



8.1.4 EUT OPERATION CONDITIONS

The EUT tested system was configured as the statements of 4.1.5 Unless otherwise a special operating condition is specified in the follows during the testing.

8.1.5 EUT TEST CONDITIONS

Temperature: 25°C
Relative Humidity: 55%
Test Voltage: DC14.8V

8.1.6 TEST RESULTS

Please refer to the Attachment H

9. PEAK OUTPUT POWER TEST

9.1 APPLIED PROCEDURES / LIMIT

FCC Part15 (15.247) , Subpart C/ RSS-GEN and RSS-210				
Section	Test Item	Limit	Frequency Range (MHz)	Result
15.247(b)(1) RSS-GEN section 4.8 RSS-210, Issue 8, Annex 8, A8.1(b)	Peak Output Power	0.125 Watt or 21dBm	2400-2483.5	PASS

9.1.1 TEST PROCEDURE

- a. The EUT was directly connected to the spectrum analyzer and antenna output port as show in the block diagram below,
- b. Spectrum Setting: RBW= 1MHz/3MHz, VBW= 1MHz/3MHz, Sweep time = Auto.

9.1.2 DEVIATION FROM STANDARD

No deviation.

9.1.3 TEST SETUP

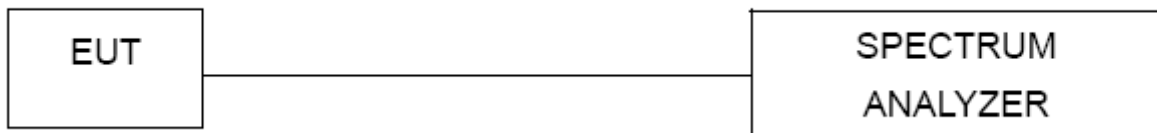

9.1.4 EUT OPERATION CONDITIONS

The EUT tested system was configured as the statements of 4.1.5 Unless otherwise a special operating condition is specified in the follows during the testing.

9.1.5 EUT TEST CONDITIONS

Temperature: 25°C
Relative Humidity: 55%
Test Voltage: DC14.8V

9.1.6 TEST RESULTS

Please refer to the Attachment I

10. ANTENNA CONDUCTED SPURIOUS EMISSION

10.1 APPLIED PROCEDURES / LIMIT

In any 100 kHz bandwidth outside the frequency band in which the spread spectrum or digitally modulated intentional radiator is operating, the radio frequency power that is produced by the intentional radiator shall be at least 20 dB below that in the 100 kHz bandwidth within the band that contains the highest level of the desired power, based on either an RF conducted measurement, provided the transmitter demonstrates compliance with the peak conducted power limits.

10.1.1 TEST PROCEDURE

- a. The EUT was directly connected to the spectrum analyzer and antenna output port as show in the block diagram below,
- b. Spectrum Setting: RBW= 100KHz, VBW=100KHz, Sweep time = Auto.

10.1.2 DEVIATION FROM STANDARD

No deviation.

10.1.3 TEST SETUP

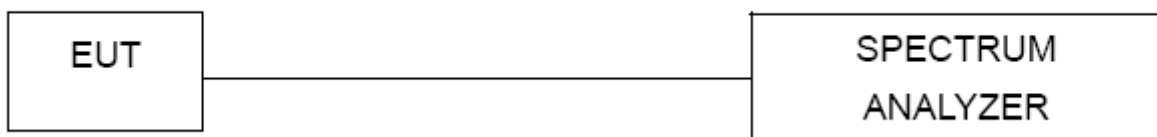

10.1.4 EUT OPERATION CONDITIONS

The EUT tested system was configured as the statements of 4.1.5 Unless otherwise a special operating condition is specified in the follows during the testing.

10.1.5 EUT TEST CONDITIONS

Temperature: 25°C
Relative Humidity: 55%
Test Voltage: DC14.8V

10.1.6 TEST RESULTS

Please refer to the Attachment J

11. MEASUREMENT INSTRUMENTS LIST

Conducted Emission Measurement					
Item	Kind of Equipment	Manufacturer	Type No.	Serial No.	Calibrated until
1	LISN	EMCO	3816/2	00052765	Mar. 29, 2015
2	LISN	R&S	ENV216	101447	Mar. 29, 2015
3	Test Cable	N/A	C_17	N/A	Mar. 14, 2015
4	EMI TEST RECEIVER	R&S	ESCS30	833364/017	Mar. 29, 2015
5	50Ω Terminator	SHX	TF2-3G-A	08122902	Mar. 29, 2015

Radiated Emission Measurement					
Item	Kind of Equipment	Manufacturer	Type No.	Serial No.	Calibrated until
1	Antenna	Schwarbeck	VULB9160	9160-3232	Mar. 29, 2015
2	Amplifier	HP	8447D	2944A09673	Mar. 29, 2015
3	Test Receiver	R&S	ESCI	100382	Mar. 29, 2015
4	Test Cable	N/A	C-01_CB03	N/A	Jul. 01, 2015
5	Antenna	ETS	3115	00075789	Mar. 29, 2015
6	Amplifier	Agilent	8449B	3008A02274	Mar. 29, 2015
7	Spectrum	Agilent	E4408B	US39240143	Nov. 09, 2014
8	Test Cable	HUBER+SUHNER	C-45	N/A	Apr. 29, 2015
9	Controller	CT	SC100	N/A	N/A
10	Horn Antenna	EMCO	3115	9605-4803	Mar. 29, 2015
11	Active Loop Antenna	R&S	HFH2-Z2	830749/020	Mar. 29, 2015

Number of Hopping Channel

Item	Kind of Equipment	Manufacturer	Type No.	Serial No.	Calibrated until
1	Spectrum Analyzer	R&S	FSP 40	100185	Nov. 11, 2014

Average Time of Occupancy

Item	Kind of Equipment	Manufacturer	Type No.	Serial No.	Calibrated until
1	Spectrum Analyzer	R&S	FSP 40	100185	Nov. 11, 2014

Hopping Channel Separation Measurement

Item	Kind of Equipment	Manufacturer	Type No.	Serial No.	Calibrated until
1	Spectrum Analyzer	R&S	FSP 40	100185	Nov. 11, 2014

Bandwidth

Item	Kind of Equipment	Manufacturer	Type No.	Serial No.	Calibrated until
1	Spectrum Analyzer	R&S	FSP 40	100185	Nov. 11, 2014

Peak Output Power

Item	Kind of Equipment	Manufacturer	Type No.	Serial No.	Calibrated until
1	Spectrum Analyzer	R&S	FSP 40	100185	Nov. 11, 2014

Antenna Conducted Spurious Emission

Item	Kind of Equipment	Manufacturer	Type No.	Serial No.	Calibrated until
1	Spectrum Analyzer	R&S	FSP 40	100185	Nov. 11, 2014

Remark: "N/A" denotes no model name, serial no. or calibration specified.
All calibration period of equipment list is one year.

12. EUT TEST PHOTO**Conducted Measurement Photos**

Radiated Measurement Photos

9KHz to 30MHz



Radiated Measurement Photos

30MHz to 1000MHz

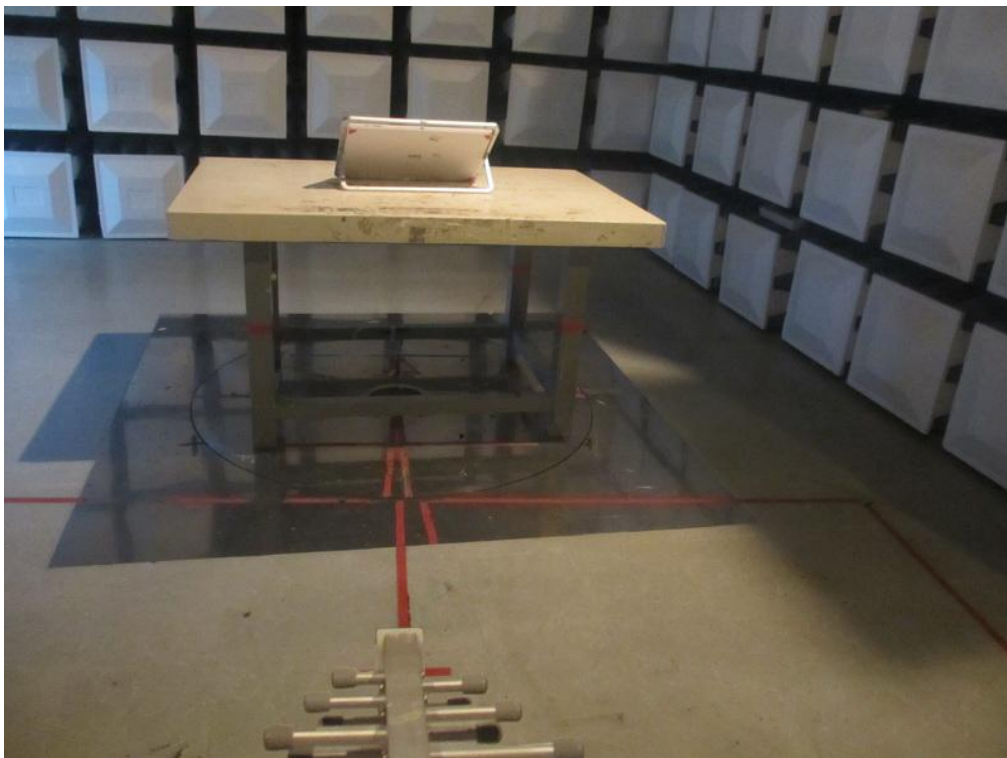

Radiated Measurement Photos

Above 1000MHz



ATTACHMENT A - CONDUCTED EMISSION

Test Mode: TX Mode

Line

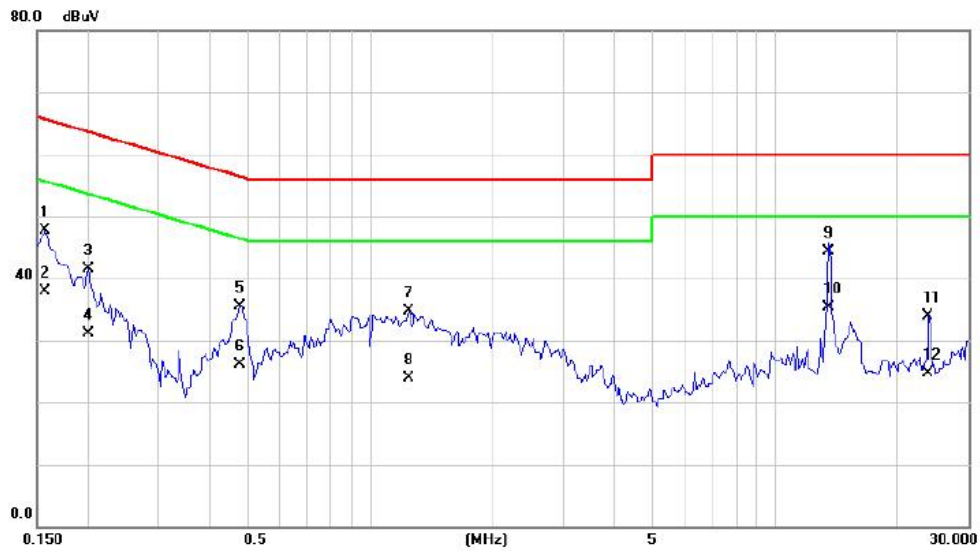

No.	Mk.	Freq. MHz	Reading Level dBuV	Correct Factor dB	Measure- ment dBuV	Limit dBuV	Over dB	Detector	Comment
1		0.1577	38.10	9.52	47.62	65.58	-17.96	QP	
2		0.1577	28.34	9.52	37.86	55.58	-17.72	AVG	
3		0.2006	32.01	9.54	41.55	63.59	-22.04	QP	
4		0.2006	21.64	9.54	31.18	53.59	-22.41	AVG	
5		0.4781	25.83	9.69	35.52	56.37	-20.85	QP	
6		0.4781	16.37	9.69	26.06	46.37	-20.31	AVG	
7		1.2437	24.99	9.71	34.70	56.00	-21.30	QP	
8		1.2437	14.29	9.71	24.00	46.00	-22.00	AVG	
9		13.6013	34.08	10.19	44.27	60.00	-15.73	QP	
10	*	13.6013	25.16	10.19	35.35	50.00	-14.65	AVG	
11		24.0000	23.42	10.55	33.97	60.00	-26.03	QP	
12		24.0000	14.07	10.55	24.62	50.00	-25.38	AVG	

Test Mode: TX Mode

Neutral

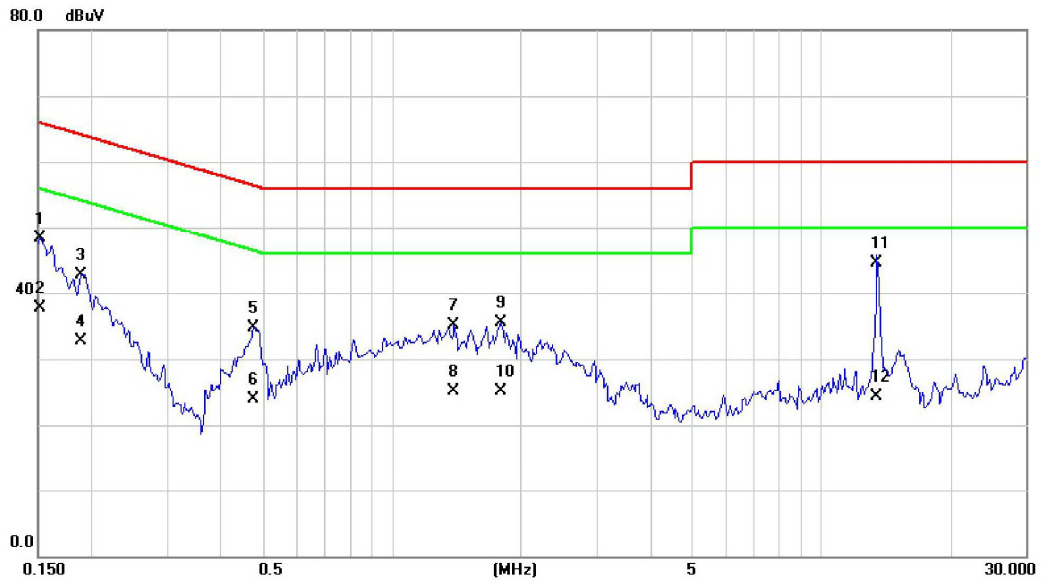

No.	Mk.	Freq. MHz	Reading Level dBuV	Correct Factor dB	Measure- ment dBuV	Limit dBuV	Over dB	Detector	Comment
1		0.1514	38.71	9.63	48.34	65.92	-17.58	QP	
2		0.1514	28.11	9.63	37.74	55.92	-18.18	AVG	
3		0.1890	33.01	9.61	42.62	64.08	-21.46	QP	
4		0.1890	23.16	9.61	32.77	54.08	-21.31	AVG	
5		0.4781	25.09	9.64	34.73	56.37	-21.64	QP	
6		0.4781	14.33	9.64	23.97	46.37	-22.40	AVG	
7		1.3960	25.40	9.70	35.10	56.00	-20.90	QP	
8		1.3960	15.37	9.70	25.07	46.00	-20.93	AVG	
9		1.7943	25.69	9.73	35.42	56.00	-20.58	QP	
10		1.7943	15.31	9.73	25.04	46.00	-20.96	AVG	
11	*	13.5152	34.25	10.23	44.48	60.00	-15.52	QP	
12		13.5152	14.16	10.23	24.39	50.00	-25.61	AVG	

ATTACHMENT B - RADIATED EMISSION (9KHZ-30MHZ)

Test Mode : TX Mode

Freq. (MHz)	Ant. 0°/90°	Reading(RA) (dBuV)	Corr.Factor(CF) (dB)	Measured(FS) (dBuV/m)	Limits(QP) (dBuV/m)	Margin (dB)	Note
0.0094	0°	68.24	24.30	92.54	128.12	-35.58	AVG
0.0094	0°	72.17	24.30	96.47	148.12	-51.65	PEAK
0.0138	0°	70.22	24.30	94.52	124.81	-30.29	AVG
0.0138	0°	79.65	24.30	103.95	144.81	-40.86	PEAK
0.0245	0°	56.46	24.02	80.48	119.82	-39.35	AVG
0.0245	0°	60.09	24.02	84.11	139.82	-55.72	PEAK
0.0313	0°	61.25	23.58	84.83	117.69	-32.86	AVG
0.0313	0°	65.54	23.58	89.12	137.69	-48.57	PEAK
0.5680	0°	18.48	20.02	38.50	72.52	-34.02	QP
1.7543	0°	18.38	19.52	37.90	69.54	-31.64	QP

Freq. (MHz)	Ant. 0°/90°	Reading(RA) (dBuV)	Corr.Factor(CF) (dB)	Measured(FS) (dBuV/m)	Limits(QP) (dBuV/m)	Margin (dB)	Note
0.0094	90°	76.64	24.30	100.94	128.18	-27.24	AVG
0.0094	90°	82.52	24.30	106.82	148.18	-41.36	PEAK
0.0237	90°	56.41	24.07	80.48	120.11	-39.63	AVG
0.0237	90°	59.21	24.07	83.28	140.11	-56.83	PEAK
0.0308	90°	57.25	23.62	80.87	117.83	-36.97	AVG
0.0308	90°	58.17	23.62	81.79	137.83	-56.05	PEAK
0.0426	90°	59.36	22.87	82.23	115.02	-32.79	AVG
0.0426	90°	63.23	22.87	86.10	135.02	-48.92	PEAK
0.4911	90°	17.55	19.82	37.37	73.78	-36.41	QP
1.7155	90°	18.67	19.53	38.20	69.54	-31.34	QP

Remark:

- (1) The amplitude of spurious emissions which are attenuated by more than 20 dB below the permissible value has no need to be reported.
- (2) Distance extrapolation factor = 40 log (specific distance / test distance) (dB);
- (3) Limit line = specific limits (dBuV) + distance extrapolation factor.

ATTACHMENT C - RADIATED EMISSION (30MHZ TO 1000MHZ)

Test Mode: TX 2402MHz_CH00_1Mbps

Vertical

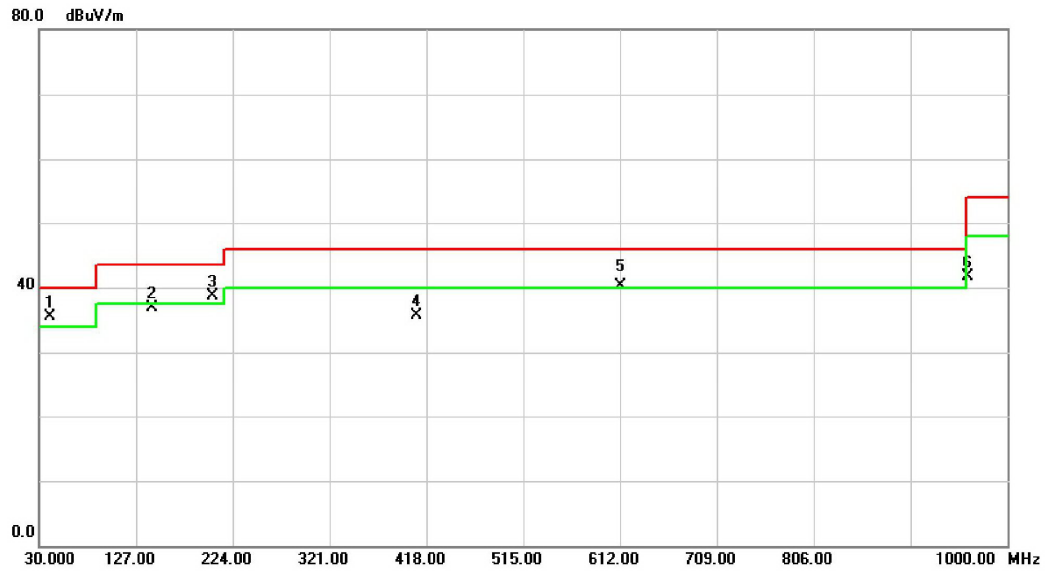

No.	Mk.	Freq. MHz	Reading Level dBuV	Correct Factor dB	Measure- ment dBuV/m	Limit dBuV/m	Over dB	Detector	Comment
1	*	40.6700	52.92	-17.32	35.60	40.00	-4.40	peak	
2		142.5200	59.18	-22.33	36.85	43.50	-6.65	peak	
3	!	203.6300	58.69	-20.04	38.65	43.50	-4.85	peak	
4		408.3000	49.10	-13.43	35.67	46.00	-10.33	peak	
5	!	612.0000	48.92	-8.63	40.29	46.00	-5.71	QP	
6		960.2300	45.06	-3.40	41.66	54.00	-12.34	peak	

Test Mode: TX 2402MHz_CH00_1Mbps

Horizontal

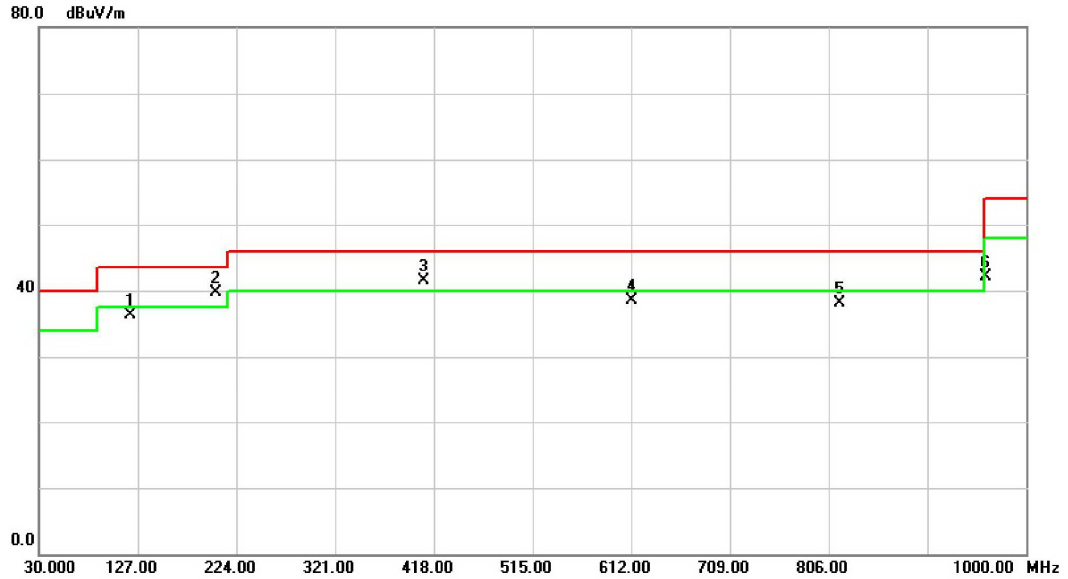

No.	Mk.	Freq. MHz	Reading Level dBuV	Correct Factor dB	Measure- ment dBuV/m	Limit dBuV/m	Over dB	Detector	Comment
1		119.2400	58.68	-22.45	36.23	43.50	-7.27	peak	
2	*	203.6300	59.67	-20.04	39.63	43.50	-3.87	peak	
3	!	408.3000	55.00	-13.43	41.57	46.00	-4.43	peak	
4		612.0000	47.16	-8.63	38.53	46.00	-7.47	peak	
5		816.6700	43.95	-5.85	38.10	46.00	-7.90	peak	
6		960.2300	45.49	-3.40	42.09	54.00	-11.91	peak	

Test Mode: TX 2441MHz _CH39_1Mbps

Vertical

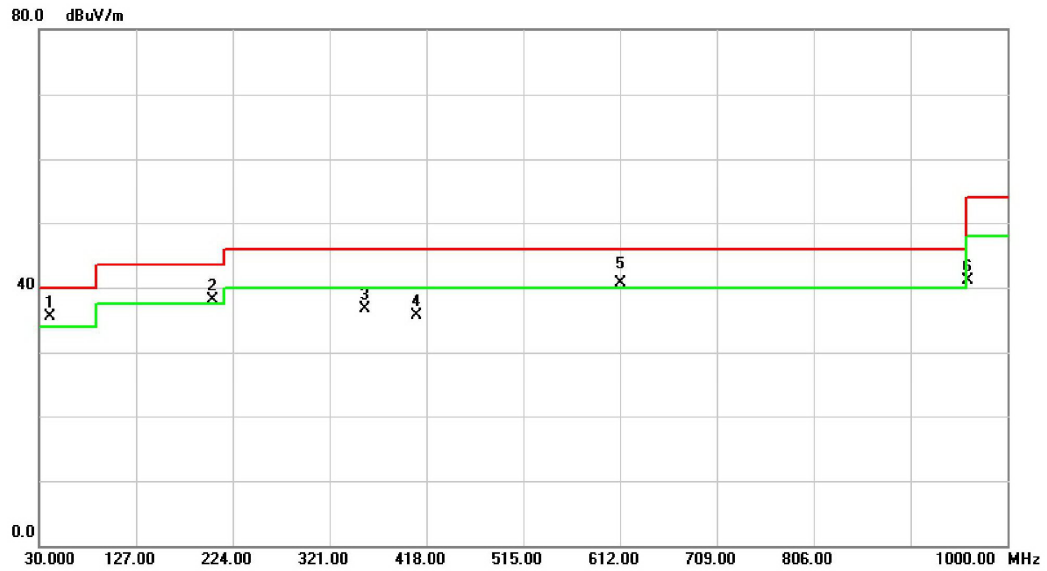

No.	Mk.	Freq. MHz	Reading Level dBuV	Correct Factor dB	Measure- ment dBuV/m	Limit dBuV/m	Over dB	Detector	Comment
1	*	40.6700	52.92	-17.32	35.60	40.00	-4.40	peak	
2	!	203.6300	58.19	-20.04	38.15	43.50	-5.35	peak	
3		356.8900	50.66	-14.01	36.65	46.00	-9.35	peak	
4		408.3000	49.10	-13.43	35.67	46.00	-10.33	peak	
5	!	612.0000	49.37	-8.63	40.74	46.00	-5.26	QP	
6		960.2300	44.56	-3.40	41.16	54.00	-12.84	peak	

Test Mode: TX 2441MHz _CH39_1Mbps

Horizontal

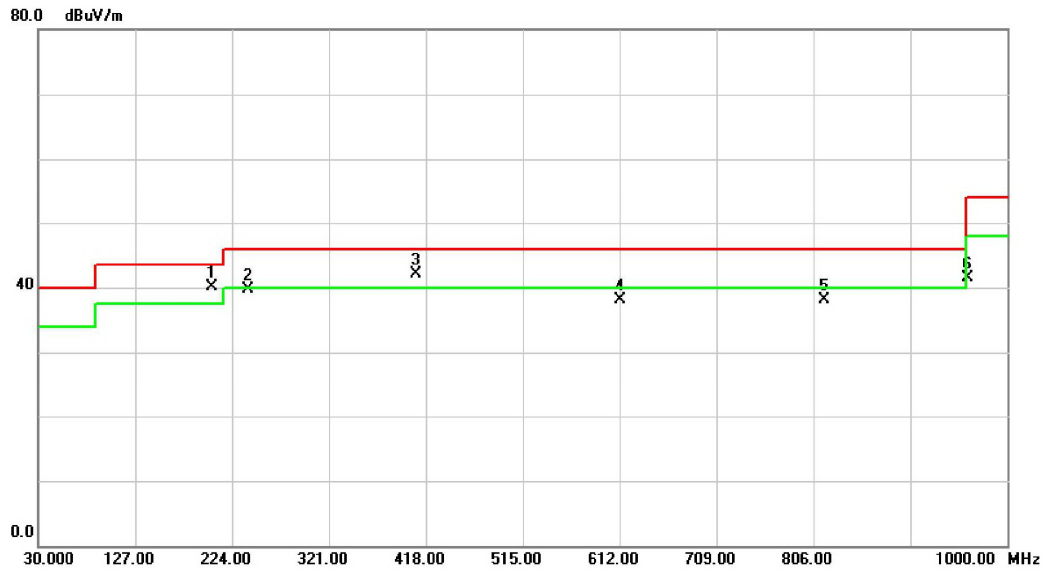

No.	Mk.	Freq. MHz	Reading Level dBuV	Correct Factor dB	Measure- ment dBuV/m	Limit dBuV/m	Over dB	Detector	Comment
1	*	203.6300	60.17	-20.04	40.13	43.50	-3.37	peak	
2		239.5200	57.48	-17.86	39.62	46.00	-6.38	peak	
3	!	408.3000	55.50	-13.43	42.07	46.00	-3.93	peak	
4		612.0000	46.66	-8.63	38.03	46.00	-7.97	peak	
5		816.6700	43.95	-5.85	38.10	46.00	-7.90	peak	
6		960.2300	44.99	-3.40	41.59	54.00	-12.41	peak	

Test Mode: TX 2480MHz_CH78_1Mbps

Vertical

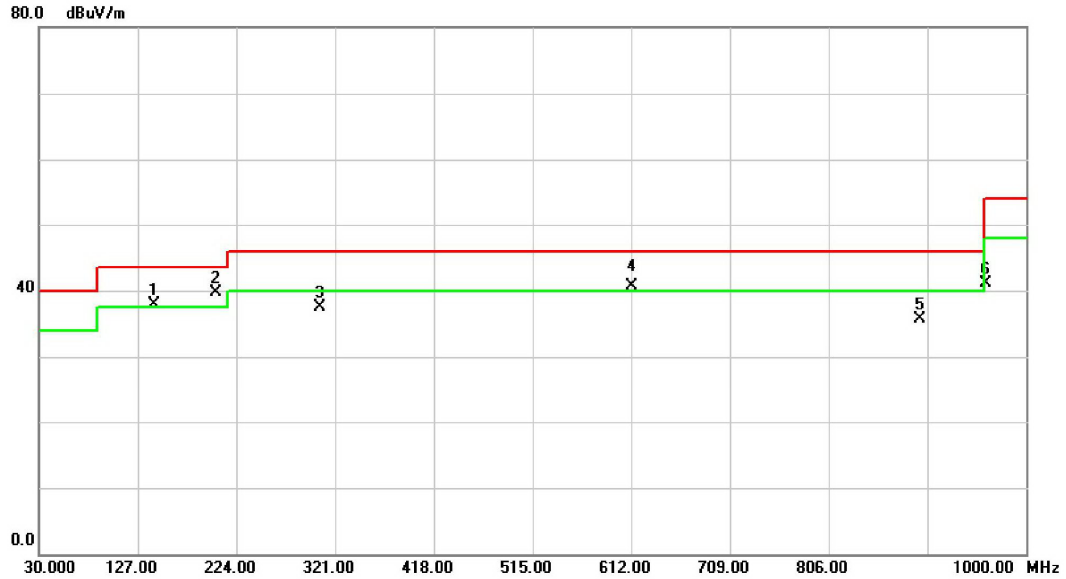

No.	Mk.	Freq. MHz	Reading Level dBuV	Correct Factor dB	Measure- ment dBuV/m	Limit dBuV/m	Over dB	Detector	Comment
1	!	142.5200	60.18	-22.33	37.85	43.50	-5.65	peak	
2	*	203.6300	59.69	-20.04	39.65	43.50	-3.85	peak	
3		305.4800	53.67	-16.22	37.45	46.00	-8.55	peak	
4	!	612.0000	49.32	-8.63	40.69	46.00	-5.31	QP	
5		896.2100	40.70	-4.90	35.80	46.00	-10.20	peak	
6		960.2300	44.56	-3.40	41.16	54.00	-12.84	peak	

Test Mode: TX 2480MHz_CH78_1Mbps

Horizontal

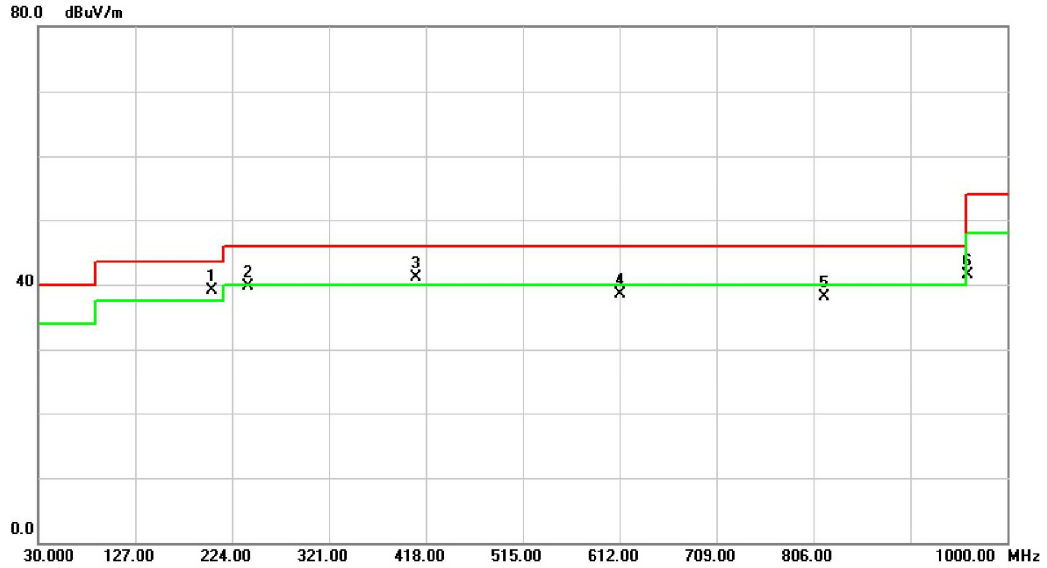

No.	Mk.	Freq. MHz	Reading Level dBuV	Correct Factor dB	Measure- ment dBuV/m	Limit dBuV/m	Over dB	Detector	Comment
1	*	203.6300	59.17	-20.04	39.13	43.50	-4.37	peak	
2		239.5200	57.48	-17.86	39.62	46.00	-6.38	peak	
3	!	408.3000	54.50	-13.43	41.07	46.00	-4.93	peak	
4		612.0000	47.16	-8.63	38.53	46.00	-7.47	peak	
5		816.6700	43.95	-5.85	38.10	46.00	-7.90	peak	
6		960.2300	44.99	-3.40	41.59	54.00	-12.41	peak	

ATTACHMENT D - RADIATED EMISSION (ABOVE 1000MHZ)

Orthogonal Axis :	X
Test Mode :	TX 2402MHz_CH00_1Mbps

Vertical

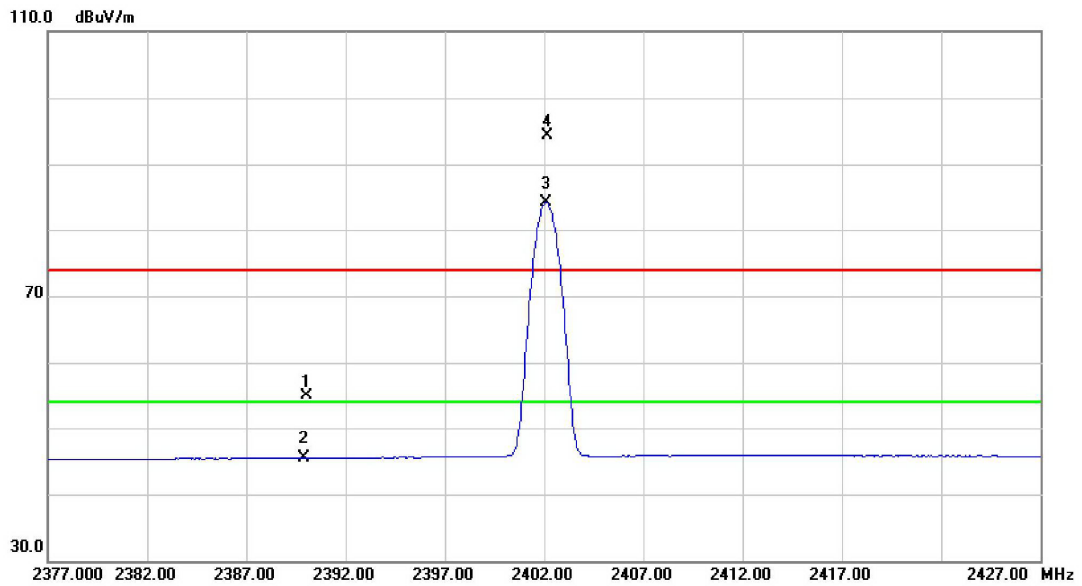

No.	Mk.	Freq. MHz	Reading Level dBuV	Correct Factor dB	Measure- ment dBuV/m	Limit dBuV/m	Over dB	Detector	Comment
1		2390.000	21.59	33.38	54.97	74.00	-19.03	peak	
2		2390.000	12.10	33.38	45.48	54.00	-8.52	AVG	
3	*	2402.100	50.67	33.41	84.08	54.00	30.08	AVG	Fundamental frequency, no limit
4	X	2402.150	60.96	33.41	94.37	74.00	20.37	peak	Fundamental frequency, no limit

Orthogonal Axis :	X
Test Mode :	TX 2402MHz _CH00_1Mbps

Vertical

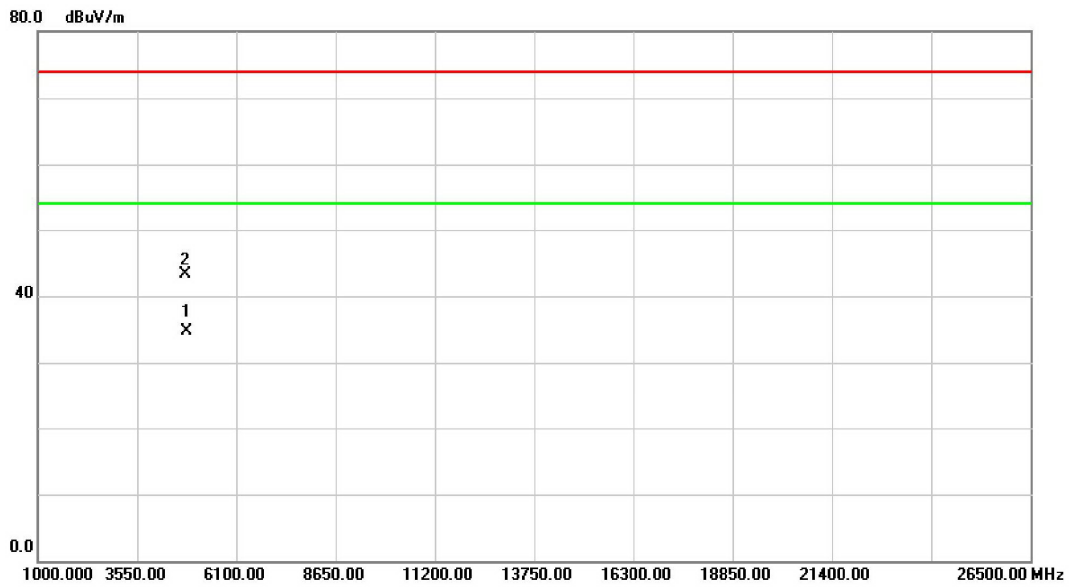

No.	Mk.	Freq. MHz	Reading Level dBuV	Correct Factor dB	Measure- ment dBuV/m	Limit dBuV/m	Over dB	Detector	Comment
1	*	4803.980	28.23	6.38	34.61	54.00	-19.39	AVG	
2		4803.980	36.92	6.38	43.30	74.00	-30.70	peak	

Orthogonal Axis :	X
Test Mode :	TX 2402MHz_CH00_1Mbps

Horizontal

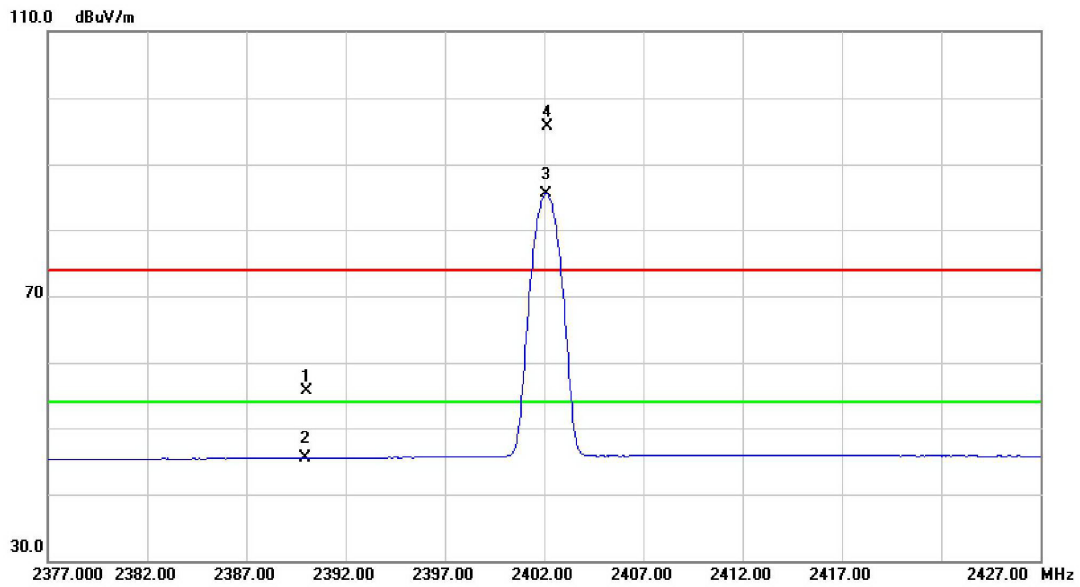

No.	Mk.	Freq. MHz	Reading Level dBuV	Correct Factor dB	Measure- ment dBuV/m	Limit dBuV/m	Over dB	Detector	Comment
1		2390.000	22.35	33.38	55.73	74.00	-18.27	peak	
2		2390.000	12.12	33.38	45.50	54.00	-8.50	AVG	
3	*	2402.100	52.02	33.41	85.43	54.00	31.43	AVG	Fundamental frequency, no limit
4	X	2402.150	62.22	33.41	95.63	74.00	21.63	peak	Fundamental frequency, no limit

Orthogonal Axis :	X
Test Mode :	TX 2402MHz _CH00_1Mbps

Horizontal

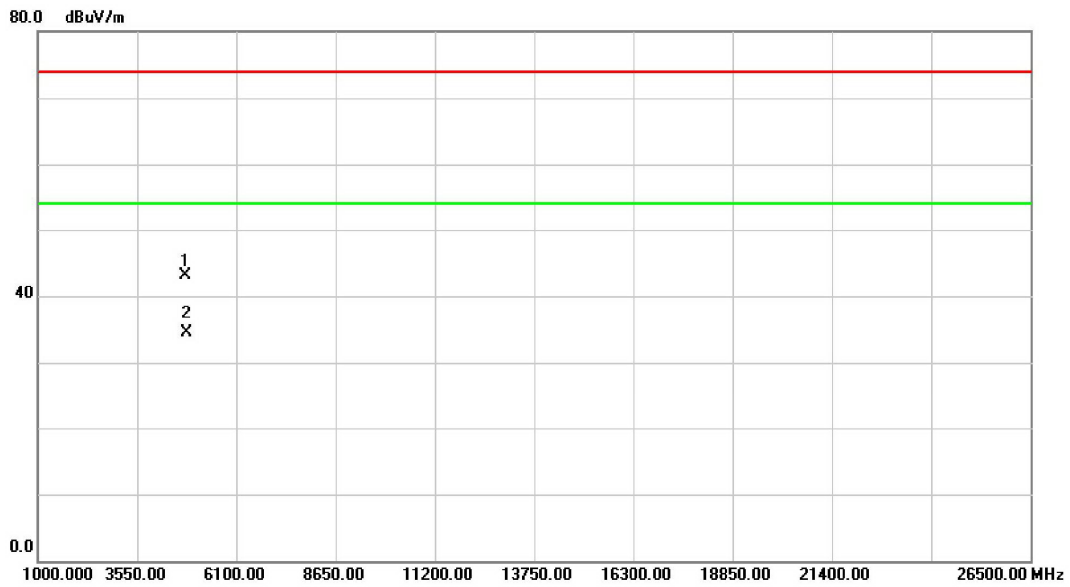

No.	Mk.	Freq. MHz	Reading Level dBuV	Correct Factor dB	Measure- ment dBuV/m	Limit dBuV/m	Over dB	Detector	Comment
1		4804.130	36.82	6.38	43.20	74.00	-30.80	peak	
2	*	4804.130	28.11	6.38	34.49	54.00	-19.51	AVG	