



# SAR TEST REPORT

**REPORT NO.:** SA970605L10

**MODEL NO.:** WUB-375L

**RECEIVED:** Jun. 05, 2008

**TESTED:** Jun. 23, 2008

**ISSUED:** Jun. 24, 2008

**APPLICANT:** U-MEDIA Communications, Inc.

**ADDRESS:** 9F, No.1, Jin-shan 7th St., Hsinchu 300, Taiwan,  
R.O.C.

**ISSUED BY:** Advance Data Technology Corporation

**LAB ADDRESS:** No.47, 14<sup>th</sup> Ling, Chia Pau Tsuen, Lin Kou Hsiang  
244, Taipei Hsien, Taiwan, R.O.C.

**TEST LOCATION:** No. 19, Hwa Ya 2<sup>nd</sup> Rd, Wen Hwa Tsuen, Kwei  
Shan Hsiang, Taoyuan Hsien 333, Taiwan,  
R.O.C.

This test report consists of 40 pages in total except Appendix. It may be duplicated completely for legal use with the approval of the applicant. It should not be reproduced except in full, without the written approval of our laboratory. The client should not use it to claim product endorsement by TAF, A2LA or any government agencies. The test results in the report only apply to the tested sample.





## TABLE OF CONTENTS

1.	CERTIFICATION .....	3
2.	GENERAL INFORMATION.....	4
2.1	GENERAL DESCRIPTION OF EUT .....	4
2.2	GENERAL DESCRIPTION OF APPLIED STANDARDS .....	5
2.3	GENERAL INFORMATION OF THE SAR SYSTEM .....	6
2.4	GENERAL DESCRIPTION OF THE SPATIAL PEAK SAR EVALUATION .....	9
3.	DESCRIPTION OF SUPPORT UNITS .....	13
4.	DESCRIPTION OF TEST MODES AND CONFIGURATIONS .....	14
4.1.	DESCRIPTION OF ANTENNA LOCATION .....	14
4.2.	DESCRIPTION OF ASSESSMENT POSITION .....	15
4.3.	DESCRIPTION OF TEST MODE .....	15
4.4.	SUMMARY OF TEST RESULTS .....	16
5.	TEST RESULTS .....	18
5.1	TEST PROCEDURES .....	18
5.2	MEASURED SAR RESULTS .....	20
5.3	SAR LIMITS.....	23
5.4	RECIPES FOR TISSUE SIMULATING LIQUIDS .....	24
5.5	TEST EQUIPMENT FOR TISSUE PROPERTY .....	27
6.	SYSTEM VALIDATION .....	28
6.1	TEST EQUIPMENT .....	28
6.2	TEST PROCEDURE .....	29
6.3	VALIDATION RESULTS .....	31
6.4	SYSTEM VALIDATION UNCERTAINTIES .....	32
7.	MEASUREMENT SAR PROCEDURE UNCERTAINTIES.....	33
7.1.	PROBE CALIBRATION UNCERTAINTY .....	33
7.2.	ISOTROPY UNCERTAINTY .....	34
7.3.	BOUNDARY EFFECT UNCERTAINTY .....	34
7.4.	PROBE LINEARITY UNCERTAINTY .....	35
7.5.	READOUT ELECTRONICS UNCERTAINTY .....	35
7.6.	RESPONSE TIME UNCERTAINTY .....	35
7.7.	INTEGRATION TIME UNCERTAINTY .....	36
7.8.	PROBE POSITIONER MECHANICAL TOLERANCE .....	37
7.9.	PROBE POSITIONING .....	37
7.10.	PHANTOM UNCERTAINTY .....	38
7.11.	DASY4 UNCERTAINTY BUDGET.....	39
8.	INFORMATION ON THE TESTING LABORATORIES .....	40
	APPENDIX A: TEST CONFIGURATIONS AND TEST DATA	
	APPENDIX B: ADT SAR MEASUREMENT SYSTEM	
	APPENDIX C: PHOTOGRAPHS OF SYSTEM VALIDATION	
	APPENDIX D: SYSTEM CERTIFICATE & CALIBRATION	



## 1. CERTIFICATION

**PRODUCT:** 802.11n/g/b Wireless USB Adapter

**MODEL:** WUB-375L

**BRAND:** U-MEDIA

**APPLICANT:** U-MEDIA Communications, Inc.

**TESTED:** Jun. 23, 2008

**TEST SAMPLE:** ENGINEERING SAMPLE

**STANDARDS:** **FCC Part 2 (Section 2.1093)**  
**FCC OET Bulletin 65, Supplement C (01-01)**  
**RSS-102**  
**IEEE 1528-2003**

The above equipment (model: WUB-375L) have been tested by **Advance Data Technology Corporation**, and found compliance with the requirement of the above standards. The test record, data evaluation & Equipment Under Test (EUT) configurations represented herein are true and accurate accounts of the measurements of the sample's EMC characteristics under the conditions specified in this report.

**PREPARED BY** : Rennie Wang , **DATE:** Jun. 24, 2008  
Rennie Wang / Senior Specialist

**TECHNICAL**  
**ACCEPTANCE** : James Fan , **DATE:** Jun. 24, 2008  
Responsible for RF James Fan / Engineer

**APPROVED BY** : Gary Chang , **DATE:** Jun. 24, 2008  
Gary Chang / Assistant Manager

## 2. GENERAL INFORMATION

### 2.1 GENERAL DESCRIPTION OF EUT

<b>PRODUCT</b>	802.11n/g/b Wireless USB Adapter
<b>MODEL NO.</b>	WUB-375L
<b>FCC ID</b>	SI5WUB375L
<b>POWER SUPPLY</b>	5.0Vdc from host equipment
<b>CLASSIFICATION</b>	Portable device, production unit
<b>MODULATION TYPE</b>	CCK, DQPSK, DBPSK for DSSS, 64QAM, 16QAM, QPSK, BPSK for OFDM
<b>RADIO TECHNOLOGY</b>	DSSS, OFDM
<b>TRANSFER RATE</b>	802.11b: 11.0/ 5.5/ 2.0/ 1.0Mbps 802.11g: 54.0/ 48.0/ 36.0/ 24.0/ 18.0/ 12.0/ 9.0/ 6.0Mbps Draft 802.11n: up to 150.0Mbps
<b>FREQUENCY RANGE</b>	2412MHz ~ 2462MHz
<b>NUMBER OF CHANNEL</b>	11 for 802.11b, 802.11g, draft 802.11n (20MHz) 7 for draft 802.11n (40MHz)
<b>CHANNEL FREQUENCIES UNDER TEST AND ITS CONDUCTED OUTPUT POWER</b>	<p><b>802.11b:</b> 45.290mW / Ch1: 2412MHz 44.875mW / Ch6: 2437MHz 63.387mW / Ch11: 2462MHz</p> <p><b>802.11g:</b> 126.765mW / Ch1: 2412MHz 130.317mW / Ch6: 2437MHz 80.724mW / Ch11: 2462MHz</p> <p><b>DRAFT 802.11n (20MHz):</b> 128.529mW / Ch1: 2412MHz 126.474mW / Ch6: 2437MHz 64.417mW / Ch11: 2462MHz</p> <p><b>DRAFT 802.11n (40MHz):</b> 50.933mW / Ch1: 2422MHz 50.933mW / Ch4: 2437MHz 44.771mW / Ch7: 2452MHz</p>
<b>AVERAGE SAR (1g)</b>	0.854W/kg
<b>ANTENNA TYPE</b>	Printed antenna with 2.01dBi gain
<b>DATA CABLE</b>	1.4m shielded USB cable for cradle
<b>I/O PORTS</b>	USB
<b>ACCESSORY DEVICES</b>	Cradle

**NOTE:**

1. The EUT incorporates a MIMO function. Physically, the EUT provides one completed transmitter and two receivers.

MODULATION MODE	TX FUNCTION
802.11b	1TX
802.11g	1TX
Draft 802.11n (20MHz)	1TX
Draft 802.11n (40MHz)	1TX

2. The above EUT information was declared by manufacturer and for more detailed features description, please refer to the manufacturer's specifications or user's manual.

## 2.2 GENERAL DESCRIPTION OF APPLIED STANDARDS

According to the specifications of the manufacturer, this product must comply with the requirements of the following standards:

**FCC Part 2 (2.1093)**

**FCC OET Bulletin 65, Supplement C (01- 01)**

**RSS-102**

**IEEE 1528-2003**

All test items have been performed and recorded as per the above standards.

## 2.3 GENERAL INFORMATION OF THE SAR SYSTEM

DASY4 (**software 4.7 Build 53**) consists of high precision robot, probe alignment sensor, phantom, robot controller, controlled measurement server and near-field probe. The robot includes six axes that can move to the precision position of the DASY4 software defined. The DASY4 software can define the area that is detected by the probe. The robot is connected to controlled box. Controlled measurement server is connected to the controlled robot box. The DAE includes amplifier, signal multiplexing, AD converter, offset measurement and surface detection. It is connected to the Electro-optical coupler (ECO). The ECO performs the conversion from the optical into digital electric signal of the DAE and transfers data to the PC.

### ET3DV6 ISOTROPIC E-FIELD PROBE

<b>CONSTRUCTION</b>	Symmetrical design with triangular core. Built-in optical fiber for surface detection system. Built-in shielding against static charges. PEEK enclosure material (resistant to organic solvents, e.g., glycolether).
<b>FREQUENCY</b>	10MHz to 3GHz; Linearity: $\pm 0.2\text{dB}$ (30MHz to 3GHz)
<b>DYNAMIC RANGE</b>	$5\mu\text{W/g}$ to $> 100\text{mW/g}$ ; Linearity: $\pm 0.2\text{dB}$
<b>OPTICAL SURFACE DETECTION</b>	$\pm 0.2\text{mm}$ repeatability in air and clear liquids over diffuse reflecting surfaces
<b>DIMENSIONS</b>	Overall length: 330mm (Tip Length: 16mm) Tip diameter: 6.8mm (Body diameter: 12mm) Distance from probe tip to dipole centers: 2.7mm
<b>APPLICATION</b>	General dosimetric measurements up to 3GHz Compliance tests of mobile phones Fast automatic scanning in arbitrary phantoms (ET3DV6)

#### NOTE

1. The Probe parameters have been calibrated by the SPEAG. Please reference "APPENDIX D" for the Calibration Certification Report.
2. For frequencies above 800MHz, calibration in a rectangular wave-guide is used, because wave-guide size is manageable.
3. For frequencies below 800MHz, temperature transfer calibration is used because the wave-guide size becomes relatively large.



## **TWIN SAM V4.0**

**CONSTRUCTION** The shell corresponds to the specifications of the Specific Anthropomorphic Mannequin (SAM) phantom defined in IEEE 1528-2003, EN 62209-1 and IEC 62209. It enables the dosimetric evaluation of left and right hand phone usage as well as body mounted usage at the flat phantom region. A cover prevents evaporation of the liquid. Reference markings on the phantom allow the complete setup of all predefined phantom positions and measurement grids by manually teaching three points with the robot.

**SHELL THICKNESS**  $2 \pm 0.2\text{mm}$

**FILLING VOLUME** Approx. 25liters

**DIMENSIONS** Height: 810mm; Length: 1000mm; Width: 500mm

### **SYSTEM VALIDATION KITS:**

**CONSTRUCTION** Symmetrical dipole with 1/4 balun enables measurement of feedpoint impedance with NWA matched for use near flat phantoms filled with brain simulating solutions. Includes distance holder and tripod adaptor

**CALIBRATION** Calibrated SAR value for specified position and input power at the flat phantom in brain simulating solutions

**FREQUENCY** 2450MHz

**RETURN LOSS** > 20dB at specified validation position

**POWER CAPABILITY** > 100W ( $f < 1\text{GHz}$ ); > 40W ( $f > 1\text{GHz}$ )

**OPTIONS** Dipoles for other frequencies or solutions and other calibration conditions upon request

## DEVICE HOLDER FOR SAM TWIN PHANTOM

### CONSTRUCTION

The device holder for the mobile phone device is designed to cope with different positions given in the standard. It has two scales for the device rotation (with respect to the body axis) and the device inclination (with respect to the line between the ear reference points). The rotation centers for both scales is the ear reference point (ERP). Thus the device needs no repositioning when changing the angles. The holder has been made out of low-loss POM material having the following dielectric parameters: relative permittivity  $\epsilon = 3$  and loss tangent  $\delta = 0.02$ . The amount of dielectric material has been reduced in the closest vicinity of the device, since measurements have suggested that the influence of the clamp on the test results could thus be lowered. The device holder for the portable device makes up of the polyethylene foam. The dielectric parameters of material close to the dielectric parameters of the air.

## DATA ACQUISITION ELECTRONICS

### CONSTRUCTION

The data acquisition electronics (DAE3) consists of a highly sensitive electrometer grade preamplifier with auto-zeroing, a channel and gain-switching multiplex, a fast 16 bit AD converter and a command decoder and control logic unit. Transmission to the measurement server is accomplished through an optical downlink for data and status information as well as an optical uplink for commands and the clock. The mechanical probe is mounting device includes two different sensor systems for frontal and sideways probe contacts. They are used for mechanical surface detection and probe collision detection. The input impedance of the DAE3 box is 200M $\Omega$ ; the inputs are symmetrical and floating. Common mode rejection is above 80 dB.



## 2.4 GENERAL DESCRIPTION OF THE SPATIAL PEAK SAR EVALUATION

The DASY4 post-processing software (SEMCAD) automatically executes the following procedures to calculate the field units from the micro-volt readings at the probe connector. The parameters used in the evaluation are stored in the configuration modules of the software:

Probe parameters:	- Sensitivity	Norm <sub>i</sub> , a <sub>i0</sub> , a <sub>i1</sub> , a <sub>i2</sub>
	- Conversion factor	ConvF <sub>i</sub>
	- Diode compression point	dcp <sub>i</sub>
Device parameters:	- Frequency	F
	- Crest factor	Cf
Media parameters:	- Conductivity	$\sigma$
	- Density	$\rho$

The first step of the evaluation is a linearization of the filtered input signal to account for the compression characteristics of the detector diode. The compensation depends on the input signal, the diode type and the DC-transmission factor from the diode to the evaluation electronics. If the exciting field is pulsed, the crest factor of the signal must be known to correctly compensate for peak power. The formula for each channel can be given as:

$$V_i = U_i + U_i^2 \cdot \frac{cf}{dcp_i}$$

V <sub>i</sub>	=compensated signal of channel i	(i = x, y, z)
U <sub>i</sub>	=input signal of channel I	(i = x, y, z)
Cf	=crest factor of exciting field	(DASY parameter)
dcp <sub>i</sub>	=diode compression point	(DASY parameter)

From the compensated input signals the primary field data for each channel can be evaluated:

$$\text{E-field probes: } E_i = \sqrt{\frac{V_i}{\text{Norm}_i \cdot \text{ConvF}}}$$

$$\text{H-field probes: } H_i = \sqrt{V_i} \cdot \frac{a_{i0} + a_{i1}f + a_{i2}f^2}{f}$$

- $V_i$  = compensated signal of channel I (i = x, y, z)
- $\text{Norm}_i$  = sensor sensitivity of channel i  $\mu\text{V}/(\text{V/m})^2$  for E-field Probes (i = x, y, z)
- $\text{ConvF}$  = sensitivity enhancement in solution
- $a_{ij}$  = sensor sensitivity factors for H-field probes
- $f$  = carrier frequency [GHz]
- $E_i$  = electric field strength of channel i in V/m
- $H_i$  = magnetic field strength of channel i in A/m

The RSS value of the field components gives the total field strength (Hermitian magnitude):

$$E_{tot} = \sqrt{E_x^2 + E_y^2 + E_z^2}$$

The primary field data are used to calculate the derived field units.

$$SAR = E_{tot}^2 \cdot \frac{\sigma}{\rho \cdot 1'000}$$

- $SAR$  = local specific absorption rate in mW/g
- $E_{tot}$  = total field strength in V/m
- $\sigma$  = conductivity in [mho/m] or [Siemens/m]
- $\rho$  = equivalent tissue density in g/cm<sup>3</sup>

Note that the density is set to 1, to account for actual head tissue density rather than the density of the tissue simulating liquid. The entire evaluation of the spatial peak values is performed within the Post-processing engine (SEMCAD). The system always gives the maximum values for the 1g and 10g cubes. The algorithm to find the cube with highest averaged SAR is divided into the following stages:

1. The extraction of the measured data (grid and values) from the Zoom Scan
2. The calculation of the SAR value at every measurement point based on all stored data (A/D values and measurement parameters)
3. The generation of a high-resolution mesh within the measured volume
4. The interpolation of all measured values from the measurement grid to the high-resolution grid
5. The extrapolation of the entire 3-D field distribution to the phantom surface over the distance from sensor to surface
6. The calculation of the averaged SAR within masses of 1g and 10g.

The probe is calibrated at the center of the dipole sensors that is located 1 to 2.7mm away from the probe tip. During measurements, the probe stops shortly above the phantom surface, depending on the probe and the surface detecting system. Both distances are included as parameters in the probe configuration file. The software always knows exactly how far away the measured point is from the surface. As the probe cannot directly measure at the surface, the values between the deepest measured point and the surface must be extrapolated. The angle between the probe axis and the surface normal line is less than 30 degree.

In the Area Scan, the gradient of the interpolation function is evaluated to find all the extreme of the SAR distribution. The uncertainty on the locations of the extreme is less than 1/20 of the grid size. Only local maximum within -2dB of the global maximum are searched and passed for the Cube Scan measurement. In the Cube Scan, the interpolation function is used to extrapolate the Peak SAR from the lowest measurement points to the inner phantom surface (the extrapolation distance). The uncertainty increases with the extrapolation distance. To keep the uncertainty within 1% for the 1g and 10g cubes, the extrapolation distance should not be larger than 5mm.

The maximum search is automatically performed after each area scan measurement. It is based on splines in two or three dimensions. The procedure can find the maximum for most SAR distributions even with relatively large grid spacing. After the area scanning measurement, the probe is automatically moved to a position at the interpolated maximum. The following scan can directly use this position for reference, e.g., for a finer resolution grid or the cube evaluations. The 1g and 10g peak evaluations are only available for the predefined cube 7 x 7 x 7 scans. The routines are verified and optimized for the grid dimensions used in these cube measurements. The measured volume of 30 x 30 x 30mm contains about 30g of tissue. The first procedure is an extrapolation (incl. boundary correction) to get the points between the lowest measured plane and the surface. The next step uses 3D interpolation to get all points within the measured volume in a 1mm grid (42875 points). In the last step, a 1g cube is placed numerically into the volume and its averaged SAR is calculated. This cube is moved around until the highest averaged SAR is found. If the highest SAR is found at the edge of the measured volume, the system will issue a warning: higher SAR values might be found outside of the measured volume. In that case the cube measurement can be repeated, using the new interpolated maximum as the center.

### 3. DESCRIPTION OF SUPPORT UNITS

The EUT has been tested as an independent unit together with other necessary accessories or support units. The following support units or accessories were used to form a representative test configuration during the tests.

NO.	PRODUCT	BRAND	MODEL NO.	SERIAL NO.	FCC ID
1	NOTEBOOK	HP	nx6215	CND5390CMP	FCC DoC Approved
2	NOTEBOOK	Dell	PP01L	TW-09C748-12800-16M-5064	FCC DoC Approved

NO.	SIGNAL CABLE DESCRIPTION OF THE ABOVE SUPPORT UNITS
1	NA
2	NA

**NOTE:** All power cords of the above support units are non shielded (1.8m).



## 4. DESCRIPTION OF TEST MODES AND CONFIGURATIONS

### 4.1. DESCRIPTION OF ANTENNA LOCATION



## 4.2. DESCRIPTION OF ASSESSMENT POSITION

The following test configurations have been applied in this test report:

	
<p style="text-align: center;"><b>A: NOTEBOOK nx6125</b></p> <p>The bottom of the EUT face to the phantom with 0mm-separation distance.</p>	<p style="text-align: center;"><b>B: NOTEBOOK PP01L</b></p> <p>The edge of the EUT face to the phantom with 4mm-separation distance.</p>

**NOTE:** The bottom of the notebook contacts to the bottom of the flat phantom with 0mm-separation distance.

## 4.3. DESCRIPTION OF TEST MODE

ITEM	TEST MODE	MODULATION	ASSESSMENT POSITION	TESTED CHANNEL
1	802.11b	DBPSK	A	1, 6, 11
2	802.11g	BPSK	A	1, 6, 11
3	Draft 802.11n (20MHz)	BPSK	A	1, 6, 11
4	Draft 802.11n (40MHz)	BPSK	A	1, 4, 7
5	802.11b	DBPSK	B	11
6	802.11g	BPSK	B	6
7	Draft 802.11n (20MHz)	BPSK	B	1
8	Draft 802.11n (40MHz)	BPSK	B	1

#### 4.4. SUMMARY OF TEST RESULTS

ITEM		1	2	3
TEST MODE		802.11b	802.11g	DRAFT 802.11n (20MHz)
CHAN.	FREQ. (MHz)	MEASURED VALUE OF 1g SAR ( W/kg)		
1	2412 (Low)	0.672	0.841	0.803
6	2437 (Mid.)	0.704	<b>0.854</b>	0.815
11	2462 (High)	0.824	0.631	0.571

ITEM		4
TEST MODE		DRAFT 802.11n (40MHz)
CHAN.	FREQ. (MHz)	MEASURED VALUE OF 1g SAR ( W/kg)
1	2422 (Low)	0.493
4	2437 (Mid.)	0.489
7	2452 (High)	0.424

ITEM		5	6	7
TEST MODE		802.11b	802.11g	DRAFT 802.11n (20MHz)
CHAN.	FREQ. (MHz)	MEASURED VALUE OF 1g SAR ( W/kg)		
1	2412 (Low)	-	-	0.407
6	2437 (Mid.)	-	0.415	-
11	2462 (High)	0.408	-	-

ITEM		8
TEST MODE		DRAFT 802.11n (40MHz)
CHAN.	FREQ. (MHz)	MEASURED VALUE OF 1g SAR ( W/kg)
1	2422 (Low)	0.269

**NOTE:** The worst value has been marked by boldface.

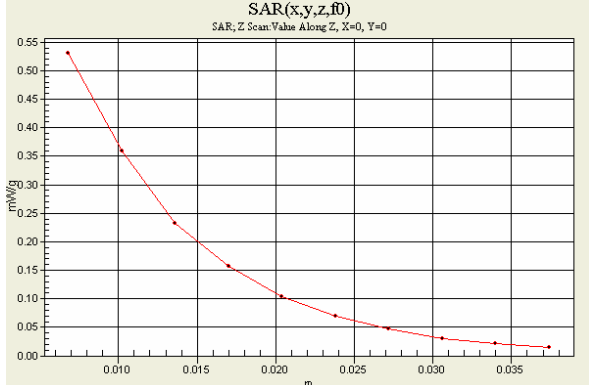
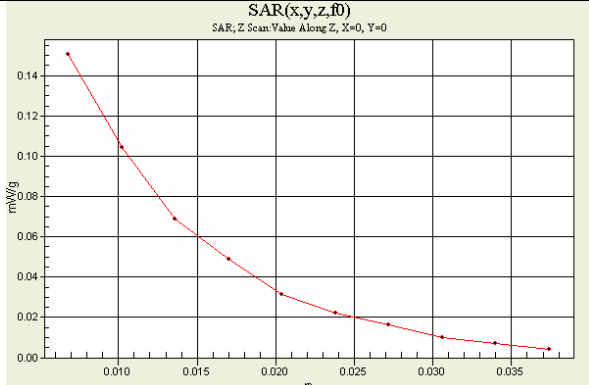

Followed Mobile and Portable device RF exposure policies (Document 44798 D01) section 2) b) ii), additional SAR requirement was evaluated. And here is the measured result of peak SAR value.

TEST POSITION	SAR VALUE (mW/g)	PLOT
INITIAL POSITION	0.533	 <p>SAR(x,y,z,t) SAR, Z Scan: Value Along Z, X=0, Y=0</p>
5mm INCREMENTS FROM INITIAL POSITION	0.151	 <p>SAR(x,y,z,t) SAR, Z Scan: Value Along Z, X=0, Y=0</p>

**THE WORST POSITION FROM EVALUATED RESULT:** Initial position.

## **5. TEST RESULTS**

### **5.1 TEST PROCEDURES**

The EUT plugged into the notebook. Use the software to control the EUT channel and transmission power. Then record the conducted power before the testing. Place the EUT to the specific test location. After the testing, must writing down the conducted power of the EUT into the report. The SAR value was calculated via the 3D spline interpolation algorithm that has been implemented in the software of DASY4 SAR measurement system manufactured and calibrated by SPEAG. According to the IEEE 1528 standards, the recommended procedure for assessing the peak spatial-average SAR value consists of the following steps:

- Power reference measurement
- Verification of the power reference measurement
- Area scan
- Zoom scan
- Power reference measurement

The area scan was performed for the highest spatial SAR location. The zoom scan with 30mm x 30mm x 30mm volume was performed for SAR value averaged over 1g and 10g spatial volumes.

In the zoom scan, the distance between the measurement point at the probe sensor location (geometric center behind the probe tip) and the phantom surface is 4.0mm and maintained at a constant distance of  $\pm 1.0$ mm during a zoom scan to determine peak SAR locations. The distance is 4mm between the first measurement point and the bottom surface of the phantom. The secondary measurement point to the bottom surface of the phantom is with 9mm separation distance. The cube size is 7 x 7 x 7 points consist of 343 points and the grid space is 5mm.

The measurement time is 0.5s at each point of the zoom scan. The probe boundary effect compensation shall be applied during the SAR test. Because of the tip of the probe to the Phantom surface separated distances are longer than half a tip probe diameter.

In the area scan, the separation distance is 4mm between the each measurement point and the phantom surface. The scan size shall be included the transmission portion of the EUT. The measurement time is the same as the zoom scan. At last the reference power drift shall be less than  $\pm 5\%$ .

## 5.2 MEASURED SAR RESULTS

<b>ENVIRONMENTAL CONDITION</b>		Air Temperature : 23.6°C, Liquid Temperature : 22.5°C Humidity : 60%RH					
<b>TESTED BY</b>		Sam Onn			<b>DATE</b>		Jun. 23, 2008
CHAN.	FREQ. (MHz)	TEST MODE	CONDUCTED POWER (mW)		POWER DRIFT (%)	DEVICE TEST POSITION MODE	MEASURED 1g SAR (W/kg)
			BEGIN TEST	AFTER TEST			
1	2412 (Low)	802.11b	45.290	44.873	-0.92	1	0.672
6	2437 (Mid.)	802.11b	44.875	44.417	-1.02	1	0.704
11	2462 (High)	802.11b	63.387	62.696	-1.09	1	0.824
1	2412 (Low)	802.11g	126.765	125.333	-1.13	2	0.841
6	2437 (Mid.)	802.11g	130.317	128.752	-1.20	2	<b>0.854</b>
11	2462 (High)	802.11g	80.724	79.683	-1.29	2	0.631

**NOTE:**

1. Test configuration of each mode is described in section 3.
2. In this testing, the limit for General Population Spatial Peak averaged over 1g, **1.6 W/kg**, is applied.
3. Please see the Appendix A for the data.
4. The variation of the EUT conducted power measured before and after SAR testing should not over 5%.

<b>ENVIRONMENTAL CONDITION</b>		Air Temperature : 23.6°C, Liquid Temperature : 22.5°C Humidity : 60%RH					
<b>TESTED BY</b>		Sam Onn			<b>DATE</b>		Jun. 23, 2008
CHAN.	FREQ. (MHz)	TEST MODE	CONDUCTED POWER (mW)		POWER DRIFT (%)	DEVICE TEST POSITION MODE	MEASURED 1g SAR (W/kg)
			BEGIN TEST	AFTER TEST			
1	2412 (Low)	DRAFT 802.11n (20MHz)	128.529	126.781	-1.36	3	0.803
6	2437 (Mid.)	DRAFT 802.11n (20MHz)	126.474	124.678	-1.42	3	0.815
11	2462 (High)	DRAFT 802.11n (20MHz)	64.417	63.425	-1.54	3	0.571
1	2422 (Low)	DRAFT 802.11n (40MHz)	50.933	50.108	-1.62	4	0.493
4	2437 (Mid.)	DRAFT 802.11n (40MHz)	50.933	50.062	-1.71	4	0.489
7	2452 (High)	DRAFT 802.11n (40MHz)	44.771	43.961	-1.81	4	0.424

**NOTE:**

1. Test configuration of each mode is described in section 3.
2. In this testing, the limit for General Population Spatial Peak averaged over 1g, **1.6 W/kg**, is applied.
3. Please see the Appendix A for the data.
4. The variation of the EUT conducted power measured before and after SAR testing should not over 5%.



<b>ENVIRONMENTAL CONDITION</b>		Air Temperature : 23.6°C, Liquid Temperature : 22.5°C Humidity : 60%RH					
<b>TESTED BY</b>		Sam Onn			<b>DATE</b>		Jun. 23, 2008
CHAN.	FREQ. (MHz)	TEST MODE	CONDUCTED POWER (mW)		POWER DRIFT (%)	DEVICE TEST POSITION MODE	MEASURED 1g SAR (W/kg)
			BEGIN TEST	AFTER TEST			
11	2462 (High)	802.11b	63.387	62.183	-1.90	5	0.408
6	2437 (Mid.)	802.11g	130.317	127.646	-2.05	6	0.415
1	2412 (Low)	DRAFT 802.11n (20MHz)	128.529	125.791	-2.13	7	0.407
1	2422 (Low)	DRAFT 802.11n (40MHz)	50.933	49.772	-2.28	8	0.269

**NOTE:**

1. Test configuration of each mode is described in section 3.
2. In this testing, the limit for General Population Spatial Peak averaged over 1g, **1.6 W/kg**, is applied.
3. Please see the Appendix A for the data.
4. The variation of the EUT conducted power measured before and after SAR testing should not over 5%.

### 5.3 SAR LIMITS

HUMAN EXPOSURE	SAR (W/kg)	
	(GENERAL POPULATION / UNCONTROLLED EXPOSURE ENVIRONMENT)	(OCCUPATIONAL / CONTROLLED EXPOSURE ENVIRONMENT)
Spatial Average (whole body)	0.08	0.4
Spatial Peak (averaged over 1 g)	<b>1.6</b>	8.0
Spatial Peak (hands / wrists / feet / ankles averaged over 10 g)	4.0	20.0

**NOTE:**

1. This limits accord to 47 CFR 2.1093 – Safety Limit.
2. The EUT property been complied with the partial body exposure limit under the general population environment.

## 5.4 RECIPES FOR TISSUE SIMULATING LIQUIDS

For the measurement of the field distribution inside the SAM phantom, the phantom must be filled with 25 liters of tissue simulation liquid.

The following ingredients are used :

- **WATER-** Deionized water (pure H<sub>2</sub>O), resistivity  $\approx 16$  M - as basis for the liquid
- **SUGAR-** Refined sugar in crystals, as available in food shops - to reduce relative permittivity
- **SALT-** Pure NaCl - to increase conductivity
- **CELLULOSE-** Hydroxyethyl-cellulose, medium viscosity (75-125mPa.s, 2% in water, 20°C),  
CAS # 54290 - to increase viscosity and to keep sugar in solution
- **PRESERVATIVE-** Preventol D-7 Bayer AG, D-51368 Leverkusen, CAS # 55965-84-9 - to prevent the spread of bacteria and molds
- **DGMBE-** Diethylenglycol-monobuthyl ether (DGMBE), Fluka Chemie GmbH, CAS # 112-34-5 - to reduce relative permittivity

**THE RECIPES FOR 2450MHz SIMULATING LIQUID TABLE**

INGREDIENT	HEAD SIMULATING LIQUID 2450MHz (HSL-2450)	MUSCLE SIMULATING LIQUID 2450MHz (MSL-2450)
Water	45%	69.83%
DGMBE	55%	30.17%
Salt	NA	NA
Dielectric Parameters at 22°C	f= 2450MHz $\epsilon = 39.2 \pm 5\%$ $\sigma = 1.80 \pm 5\%$ S/m	f= 2450MHz $\epsilon = 52.7 \pm 5\%$ $\sigma = 1.95 \pm 5\%$ S/m





Testing the liquids using the Agilent Network Analyzer E8358A and Agilent Dielectric Probe Kit 85070D. The testing procedure is following as

1. Turn Network Analyzer on and allow at least 30min. warm up.
2. Mount dielectric probe kit so that interconnecting cable to Network Analyzer will not be moved during measurements or calibration.
3. Pour de-ionized water and measure water temperature ( $\pm 1^\circ$ ).
4. Set water temperature in Agilent-Software (Calibration Setup).
5. Perform calibration.
6. Validate calibration with dielectric material of known properties (e.g. polished ceramic slab with  $>8\text{mm}$  thickness  $\epsilon' = 10.0$ ,  $\epsilon'' = 0.0$ ). If measured parameters do not fit within tolerance, repeat calibration ( $\pm 0.2$  for  $\epsilon'$ :  $\pm 0.1$  for  $\epsilon''$ ).
7. Conductivity can be calculated from  $\epsilon''$  by  $\sigma = \omega \epsilon_0 \epsilon'' = \epsilon'' f [\text{GHz}] / 18$ .
8. Measure liquid shortly after calibration. Repeat calibration every hour.
9. Stir the liquid to be measured. Take a sample ( $\sim 50\text{ml}$ ) with a syringe from the center of the liquid container.
10. Pour the liquid into a small glass flask. Hold the syringe at the bottom of the flask to avoid air bubbles.
11. Put the dielectric probe in the glass flask. Check that there are no air bubbles in front of the opening in the dielectric probe kit.
12. Perform measurements.
13. Adjust medium parameters in DASY4 for the frequencies necessary for the measurements ('Setup Config', select medium (e.g. Brain 900MHz) and press 'Option'-button.
14. Select the current medium for the frequency of the validation (e.g. Setup Medium Brain 900MHz).

**FOR 2.4GHz BAND SIMULATING LIQUID**

LIQUID TYPE		HSL-2450		MSL-2450	
SIMULATING LIQUID TEMP.		NA		22.5	
TEST DATE		NA		Jun. 23, 2008	
TESTED BY		NA		Sam Onn	
FREQ. (MHz)	LIQUID PARAMETER	STANDARD VALUE	MEASUREMENT VALUE	STANDARD VALUE	MEASUREMENT VALUE
2412.0	Permittivity ( $\epsilon$ )	NA	NA	52.80	53.1
2422.0		NA	NA	52.70	53.0
2437.0		NA	NA	52.70	53.0
2450.0		NA	NA	52.70	52.9
2452.0		NA	NA	52.70	52.9
2462.0		NA	NA	52.70	52.8
2412.0	Conductivity ( $\sigma$ ) S/m	NA	NA	1.91	1.93
2422.0		NA	NA	1.92	1.94
2437.0		NA	NA	1.94	1.96
2450.0		NA	NA	1.95	1.97
2452.0		NA	NA	1.95	1.97
2462.0		NA	NA	1.97	1.98
Dielectric Parameters Required at 22°C		<b>f= 2450MHz</b> $\epsilon = 39.2 \pm 5\%$ $\sigma = 1.80 \pm 5\% \text{ S/m}$		<b>f= 2450MHz</b> $\epsilon = 52.7 \pm 5\%$ $\sigma = 1.95 \pm 5\% \text{ S/m}$	



## 5.5 TEST EQUIPMENT FOR TISSUE PROPERTY

ITEM	NAME	BAND	TYPE	SERIES NO.	CALIBRATED UNTIL
1	Network Analyzer	Agilent	E8358A	US41480538	Nov. 11, 2008
2	Dielectric Probe	Agilent	85070D	US01440176	NA

**NOTE:**

1. Before starting, all test equipment shall be warmed up for 30min.
2. The tolerance ( $k=1$ ) specified by Agilent for general dielectric measurements, deriving from inaccuracies in the calibration data, analyzer drift, and random errors, are usually  $\pm 2.5\%$  and  $\pm 5\%$  for measured permittivity and conductivity, respectively. However, the tolerances for the conductivity is smaller for material with large loss tangents, i.e., less than  $\pm 2.5\%$  ( $k=1$ ). It can be substantially smaller if more accurate methods are applied.

## 6. SYSTEM VALIDATION

The system validation was performed in the flat phantom with equipment listed in the following table. Since the SAR value is calculated from the measured electric field, dielectric constant and conductivity of the body tissue, and the SAR is proportional to the square of the electric field. So, the SAR value will be also proportional to the RF power input to the system validation dipole under the same test environment. In our system validation test, 250mW RF input power was used.

### 6.1 TEST EQUIPMENT

ITEM	NAME	BAND	TYPE	SERIES NO.	CALIBRATED UNTIL
1	SAM Phantom	S & P	QD000 P40 CA	TP-1150	NA
2	Signal Generator	Anritsu	68247B	984703	May 26, 2009
3	E-Field Probe	S & P	ET3DV6	1790	Nov. 19, 2008
4	DAE	S & P	DAE	510	Aug. 28, 2008
5	Robot Positioner	Staubli Unimation	NA	NA	NA
6	Validation Dipole	S & P	D2450V2	716	Aug. 19, 2008

**NOTE:** 1. Before starting the measurement, all test equipment shall be warmed up for 30min.

## 6.2 TEST PROCEDURE

Before the system performance check, we need only to tell the system which components (probe, medium, and device) are used for the system performance check; the system will take care of all parameters. The dipole must be placed beneath the flat section of the SAM Twin Phantom with the correct distance holder in place. The distance holder should touch the phantom surface with a light pressure at the reference marking (little cross) and be oriented parallel to the long side of the phantom. Accurate positioning is not necessary, since the system will search for the peak SAR location, except that the dipole arms should be parallel to the surface. The device holder for mobile phones can be left in place but should be rotated away from the dipole.

The "Power Reference Measurement" and "Power Drift Measurement" jobs are located at the beginning and end of the batch process. They measure the field drift at one single point in the liquid over the complete procedure. The indicated drift is mainly the variation of the amplifier output power. If it is too high (above  $\pm 0.1$  dB), the system performance check should be repeated; some amplifiers have very high drift during warm-up. A stable amplifier gives drift results in the DASY system below  $\pm 0.02$ dB.

The "Surface Check" job tests the optical surface detection system of the DASY system by repeatedly detecting the surface with the optical and mechanical surface detector and comparing the results. The output gives the detecting heights of both systems, the difference between the two systems and the standard deviation of the detection repeatability. Air bubbles or refraction in the liquid due to separation of the sugar-water mixture gives poor repeatability (above  $\pm 0.1$ mm). In that case it is better to abort the system performance check and stir the liquid. The difference between the optical surface detection and the actual surface depends on the probe and is specified with each probe. (It does not depend on the surface reflectivity or the probe angle to the surface within  $\pm 30^\circ$ .) However, varying breaking indices of different liquid compositions might also influence the distance. If the indicated difference varies from the actual setting, the probe parameter "optical surface

The "Area Scan" job measures the SAR above the dipole on a plane parallel to the surface. It is used to locate the approximate location of the peak SAR. The proposed scan uses large grid spacing for faster measurement; due to the symmetric field, the peak detection is reliable. If a finer graphic is desired, the grid spacing can be reduced. Grid spacing and orientation have no influence on the SAR result.

The "Zoom Scan" job measures the field in a volume around the peak SAR value assessed in the previous "Area Scan" job (for more information see the application note on SAR evaluation).

About the validation dipole positioning uncertainty, the constant and low loss dielectric spacer is used to establish the correct distance between the top surface of the dipole and the bottom surface of the phantom, the error component introduced by the uncertainty of the distance between the liquid (i.e., phantom shell) and the validation dipole in the DASY4 system is less than  $\pm 0.1$ mm.

$$SAR_{tolerance} [\%] = 100 \times \left( \frac{(a + d)^2}{a^2} - 1 \right)$$

As the closest distance is 10mm, the resulting tolerance  $SAR_{tolerance} [\%]$  is <2%.



### 6.3 VALIDATION RESULTS

SYSTEM VALIDATION TEST OF SIMULATING LIQUID					
FREQUENCY (MHz)	REQUIRED SAR (mW/g)	MEASURED SAR (mW/g)	DEVIATION (%)	SEPARATION DISTANCE	TESTED DATE
MSL2450	13.10 (1g)	12.20	-6.87	10mm	Jun. 23, 2008
TESTED BY	Sam Onn				

**NOTE:** Please see Appendix for the photo of system validation test.

## 6.4 SYSTEM VALIDATION UNCERTAINTIES

In the table below, the system validation uncertainty with respect to the analytically assessed SAR value of a dipole source as given in the IEEE 1528 standard is given. This uncertainty is smaller than the expected uncertainty for mobile phone measurements due to the simplified setup and the symmetric field distribution.

Error Description	Tolerance (±%)	Probability Distribution	Divisor	(C <sub>i</sub> )		Standard Uncertainty (±%)		(v <sub>i</sub> )
				(1g)	(10g)	(1g)	(10g)	
<b>Measurement System</b>								
Probe Calibration	4.8	Normal	1	1	1	4.8	4.8	∞
Axial Isotropy	4.7	Rectangular	$\sqrt{3}$	1	1	2.7	2.7	∞
Hemispherical Isotropy	0	Rectangular	$\sqrt{3}$	1	1	0	0	∞
Boundary effect	1.0	Rectangular	$\sqrt{3}$	1	1	0.6	0.6	∞
Linearity	4.7	Rectangular	$\sqrt{3}$	1	1	2.7	2.7	∞
System Detection Limit	1.0	Rectangular	$\sqrt{3}$	1	1	0.6	0.6	∞
Readout Electronics	1.0	Normal	1	1	1	1.0	1.0	∞
Response Time	0	Rectangular	$\sqrt{3}$	1	1	0	0	∞
Integration Time	0	Rectangular	$\sqrt{3}$	1	1	0	0	∞
RF Ambient Conditions	3.0	Rectangular	$\sqrt{3}$	1	1	1.7	1.7	∞
Probe Positioner	0.4	Rectangular	$\sqrt{3}$	1	1	0.2	0.2	∞
Probe positioning	2.9	Rectangular	$\sqrt{3}$	1	1	1.7	1.7	∞
Algorithms for Max. SAR Evaluation	1.0	Rectangular	$\sqrt{3}$	1	1	0.6	0.6	∞
<b>Dipole</b>								
Dipole Axis to Liquid Distance	2.0	Rectangular	$\sqrt{3}$	1	1	1.2	1.2	∞
Input power and SAR drift measurement	4.7	Rectangular	$\sqrt{3}$	1	1	2.7	2.7	∞
<b>Phantom and Tissue Parameters</b>								
Phantom Uncertainty	4.0	Rectangular	$\sqrt{3}$	1	1	2.3	2.3	∞
Liquid Conductivity (target)	5.0	Rectangular	$\sqrt{3}$	0.64	0.43	1.8	1.2	∞
Liquid Conductivity (measurement)	2.5	Normal	1	0.64	0.43	1.6	1.1	∞
Liquid Permittivity (target)	5.0	Rectangular	$\sqrt{3}$	0.6	0.49	1.7	1.4	∞
Liquid Permittivity (measurement)	2.5	Normal	1	0.6	0.49	1.5	1.2	∞
<b>Combined Standard Uncertainty</b>						8.4	8.1	∞
<b>Coverage Factor for 95%</b>						kp=2		
<b>Expanded Uncertainty (K=2)</b>						16.8	16.2	

**NOTE:** About the system validation uncertainty assessment, please reference the section 7.



## 7. MEASUREMENT SAR PROCEDURE UNCERTAINTIES

The assessment of spatial peak SAR of the hand held devices is according to IEEE 1528. All testing situation shall be met below these requirements.

- The system is used by an experienced engineer who follows the manual and the guidelines taught during the training provided by SPEAG.
- The probe has been calibrated within the requested period and the stated uncertainty for the relevant frequency bands does not exceed 4.8% (k=1).
- The validation dipole has been calibrated within the requested period and the system performance check has been successful.
- The DAE unit has been calibrated within the within the requested period.
- The minimum distance between the probe sensor and inner phantom shell is selected to be between 4 and 5mm.
- The operational mode of the DUT is CW, CDMA, FDMA or TDMA (GSM, DCS, PCS, IS136 and PDC) and the measurement/integration time per point is >500 ms.
- The dielectric parameters of the liquid have been assessed using Agilent 85070D dielectric probe kit or a more accurate method.
- The dielectric parameters are within 5% of the target values.
- The DUT has been positioned as described in section 3.

### 7.1. PROBE CALIBRATION UNCERTAINTY

SPEAG conducts the probe calibration in compliance with international and national standards (e.g. IEEE 1528, EN 62209-1, IEC 62209, etc.) under ISO17025. The uncertainties are stated on the calibration certificate. For the most relevant frequency bands, these values do not exceed 4.8% (k=1). If evaluations of other bands are performed for which the uncertainty exceeds these values, the uncertainty tables given in the summary have to be revised accordingly.

## 7.2. ISOTROPY UNCERTAINTY

The axial isotropy tolerance accounts for probe rotation around its axis while the hemispherical isotropy error includes all probe orientations and field polarizations. These parameters are assessed by SPEAG during initial calibration. In 2001, SPEAG further tightened its quality controls and warrants that the maximal deviation from axial isotropy is  $\pm 0.20\text{dB}$ , while the maximum deviation of hemispherical isotropy is  $\pm 0.40\text{dB}$ , corresponding to  $\pm 4.7\%$  and  $\pm 9.6\%$ , respectively. A weighting factor of  $c_p$  equal to 0.5 can be applied, since the axis of the probe deviates less than 30 degrees from the normal surface orientation.

## 7.3. BOUNDARY EFFECT UNCERTAINTY

The effect can be estimated according to the following error approximation formula

$$SAR_{tolerance} [\%] = SAR_{be} [\%] \times \frac{(d_{be} + d_{step})^2}{2d_{step}} e^{-\frac{d_{be}}{\delta/2}}$$

$$d_{be} + d_{step} < 10\text{mm}$$

The parameter  $d_{be}$  is the distance in mm between the surface and the closest measurement point used in the averaging process;  $d_{step}$  is the separation distance in mm between the first and second measurement points;  $\delta$  is the minimum penetration depth in mm within the head tissue equivalent liquids (i.e.,  $\delta = 13.95\text{mm}$  at 3GHz);  $SAR_{be}$  is the deviation between the measured SAR value at the distance  $d_{be}$  from the boundary and the wave-guide analytical value  $SAR_{ref}$ . DASY4 applies a boundary effect compensation algorithm according to IEEE 1528, which is possible since the axis of the probe never deviates more than 30 degrees from the normal surface orientation.  $SAR_{be}[\%]$  is assessed during the calibration process and SPEAG warrants that the uncertainty at distances larger than 4mm is always less than 1%. In summary, the worst case boundary effect SAR tolerance[%] for scanning distances larger than 4mm is  $< \pm 0.8\%$ .

#### 7.4. PROBE LINEARITY UNCERTAINTY

Field probe linearity uncertainty includes errors from the assessment and compensation of the diode compression effects for CW and pulsed signals with known duty cycles. This error is assessed using the procedure described in IEEE 1528. For SPEAG field probes, the measured difference between CW and pulsed signals, with pulse frequencies between 10Hz and 1kHz and duty cycles between 1 and 100, is  $< \pm 0.20\text{dB}$  ( $< \pm 4.7\%$ ).

#### 7.5. READOUT ELECTRONICS UNCERTAINTY

All uncertainties related to the probe readout electronics (DAE unit), including the gain and linearity of the instrumentation amplifier, its loading effect on the probe, and accuracy of the signal conversion algorithm, have been assessed accordingly to IEEE 1528. The combination (root-sum-square RSS method) of these components results in an overall maximum error of  $\pm 1.0\%$ .

#### 7.6. RESPONSE TIME UNCERTAINTY

The time response of the field probes is assessed by exposing the probe to a well-controlled electric field producing SAR larger than  $2.0\text{W/kg}$  at the tissue medium surface. The signal response time is evaluated as the time required by the system to reach 90% of the expected final value after an on/of switch of the power source. Analytically, it can be expressed as:

$$SAR_{tolerance} [\%] = 100 \times \left( \frac{T_m}{T_m + \tau e^{-T_m/\tau} - \tau} - 1 \right)$$

where  $T_m$  is 500 ms, i.e., the time between measurement samples, and  $\tau$  the time constant. The response time  $\tau$  of SPEAG's probes is  $< 5\text{ms}$ . In the current implementation, DASY4 waits longer than 100 ms after having reached the grid point before starting a measurement, i.e., the response time uncertainty is negligible.

## 7.7. INTEGRATION TIME UNCERTAINTY

If the device under test does not emit a CW signal, the integration time applied to measure the electric field at a specific point may introduce additional uncertainties due to the discretization and can be assessed as follows

$$SAR_{tolerance} [\%] = 100 \times \sum_{all\ sub-frames} \frac{t_{frame}}{t_{integration}} \frac{slot_{idle}}{slot_{total}}$$

The tolerances for the different systems are given in Table 7.1, whereby the worst-case  $SAR_{tolerance}$  is 2.6%.

System	$SAR_{tolerance} \%$
CW	0
CDMA*	0
WCDMA*	0
FDMA	0
IS-136	2.6
PDC	2.6
GSM/DCS/PCS	1.7
DECT	1.9
Worst-Case	2.6

**TABLE 7.1**

## 7.8. PROBE POSITIONER MECHANICAL TOLERANCE

The mechanical tolerance of the field probe positioner can introduce probe positioning uncertainties. The resulting SAR uncertainty is assessed by comparing the SAR obtained according to the specifications of the probe positioner with respect to the actual position defined by the geometric center of the probe sensors. The tolerance is determined as:

$$SAR_{tolerance} [\%] = 100 \times \frac{d_{ph}}{\delta/2}$$

The specified repeatability of the RX robot family used in DASY4 systems is  $\pm 25\mu\text{m}$ . The absolute accuracy for short distance movements is better than  $\pm 0.1\text{mm}$ , i.e., the  $SAR_{tolerance} [\%]$  is better than 1.5% (rectangular).

## 7.9. PROBE POSITIONING

The probe positioning procedures affect the tolerance of the separation distance between the probe tip and the phantom surface as:

$$SAR_{tolerance} [\%] = 100 \times \frac{d_{ph}}{\delta/2}$$

where  $d_{ph}$  is the maximum deviation of the distance between the probe tip and the phantom surface. The optical surface detection has a precision of better than 0.2mm, resulting in an  $SAR_{tolerance} [\%]$  of <2.9% (rectangular distribution). Since the mechanical detection provides better accuracy, 2.9% is a worst-case figure for DASY4 system.

## 7.10. PHANTOM UNCERTAINTY

The SAR measurement uncertainty due to SPEAG phantom shell production tolerances has been evaluated using

$$SAR_{tolerance} [\%] \cong 100 \times \frac{2d}{a}, \quad d \ll a$$

For a maximum deviation  $d$  of the inner and outer shell of the phantom from that specified in the CAD file of  $\pm 0.2\text{mm}$ , and a  $10\text{mm}$  spacing  $a$  between source and tissue liquid, the calculated phantom uncertainty is  $\pm 4.0\%$ .

## 7.11. DASY4 UNCERTAINTY BUDGET

Error Description	Tolerance (±%)	Probability Distribution	Divisor	(C <sub>i</sub> )		Standard Uncertainty (±%)		(v <sub>i</sub> )
				(1g)	(10g)	(1g)	(10g)	
<b>Measurement Equipment</b>								
Probe Calibration	4.8	Normal	1	1	1	4.8	4.8	∞
Axial Isotropy	4.7	Rectangular	√3	1	1	1.9	1.9	∞
Hemispherical Isotropy	9.6	Rectangular	√3	1	1	3.9	3.9	∞
Boundary effect	1.0	Rectangular	√3	1	1	0.6	0.6	∞
Linearity	4.7	Rectangular	√3	1	1	2.7	2.7	∞
System Detection Limit	1.0	Rectangular	√3	1	1	0.6	0.6	∞
Readout Electronics	1.0	Normal	1	1	1	1.0	1.0	∞
Response Time	0.8	Normal	1	1	1	0.8	0.8	∞
Integration Time	2.6	Normal	1	1	1	2.6	2.6	∞
Noise	0.0	Normal	1	0	0	0	0	∞
<b>Mechanical Constraints</b>								
Scanning System	0.4	Rectangular	√3	1	1	0.2	0.2	∞
Phantom Shell	4.0	Rectangular	√3	1	1	2.3	2.3	∞
Probe Positioning	2.9	Rectangular	√3	1	1	1.7	1.7	∞
Device Positioning	2.9	Normal	1	1	1	2.9	2.9	875
<b>Physical Parameters</b>								
Liquid Conductivity (target)	5.0	Rectangular	√3	0.7	0.5	2	1.4	∞
Liquid Conductivity (measurement)	4.3	Rectangular	√3	0.7	0.5	1.7	1.2	∞
Liquid Permittivity (target)	5.0	Rectangular	√3	0.6	0.5	1.7	1.4	∞
Liquid Permittivity (measurement)	4.3	Rectangular	√3	0.6	0.5	1.5	1.2	∞
Power Drift	5	Rectangular	√3	1	1	2.9	2.9	∞
RF Ambient Conditions	3.0	Rectangular	√3	1	1	1.7	1.7	∞
<b>Post-Processing</b>								
Extrapolation and Integration	1	Rectangular	√3	1	1	0.6	0.6	∞
<b>Combined Standard Uncertainty</b>						<b>9.9</b>	<b>9.7</b>	
<b>Coverage Factor for 95%</b>						<b>kp=2</b>		
<b>Expanded Uncertainty (K=2)</b>						<b>19.9</b>	<b>19.3</b>	

**TABLE 7.2**

The table 7.2: Worst-Case uncertainty budget for DASY4 assessed according to IEEE 1528. The budget is valid for the frequency range 300MHz ~ 3GHz and represents a worst-case analysis. For specific tests and configurations, the uncertainty could be considerable smaller.



## 8. INFORMATION ON THE TESTING LABORATORIES

We, ADT Corp., were founded in 1988 to provide our best service in EMC, Radio, Telecom and Safety consultation. Our laboratories are accredited and approved by the following approval agencies according to ISO/IEC 17025.

<b>USA</b>	FCC, UL, A2LA
<b>GERMANY</b>	TUV Rheinland
<b>JAPAN</b>	VCCI
<b>NORWAY</b>	NEMKO
<b>CANADA</b>	INDUSTRY CANADA, CSA
<b>R.O.C.</b>	TAF, BSMI, NCC
<b>NETHERLANDS</b>	Telefication
<b>SINGAPORE</b>	GOST-ASIA (MOU)
<b>RUSSIA</b>	CERTIS (MOU)

Copies of accreditation certificates of our laboratories obtained from approval agencies can be downloaded from our web site:

[www.adt.com.tw/index.5/phtml](http://www.adt.com.tw/index.5/phtml). If you have any comments, please feel free to contact us at the following:

**Linko EMC/RF Lab:**

Tel: 886-2-26052180  
Fax: 886-2-26051924

**Hsin Chu EMC/RF Lab:**

Tel: 886-3-5935343  
Fax: 886-3-5935342

**Hwa Ya EMC/RF/Safety/Telecom Lab:**

Tel: 886-3-3183232  
Fax: 886-3-3185050

**Web Site:** [www.adt.com.tw](http://www.adt.com.tw)

The address and road map of all our labs can be found in our web site also.

---END---



## APPENDIX A: TEST DATA

### Liquid Level Photo

MSL 2450MHz D=152mm



Test Laboratory: Advance Data Technology

## 11b-Ch1-M01

**DUT: 802.11n/g/b Wireless USB Adapter ; Type: WUB-375L ; Test Frequency: 2412 MHz**

Communication System: 802.11b ; Frequency: 2412 MHz ; Duty Cycle: 1:1 ; Modulation type: DBPSK  
Medium: MSL2450 Medium parameters used:  $f = 2412$  MHz;  $\sigma = 1.93$  mho/m;  $\epsilon_r = 53.1$ ;  $\rho = 1000$  kg/m<sup>3</sup> ; Liquid level : 152 mm

Phantom section: Flat Section ; Separation distance : 0 mm (The bottom side of the EUT to the Phantom)

Antenna type : Printed Antenna ; Air temp. : 23.6 degrees ; Liquid temp. : 22.5 degrees

DASY4 Configuration:

- Probe: ET3DV6 - SN1790 ; ConvF(4.16, 4.16, 4.16) ; Calibrated: 2007/11/20
- Sensor-Surface: 4mm (Mechanical Surface Detection)
- Electronics: DAE3 Sn510 ; Calibrated: 2007/8/29
- Phantom: SAM 12 ; Type: SAM V4.0 ; Serial: TP 1202
- Measurement SW: DASY4, V4.7 Build 53 ; Postprocessing SW: SEMCAD, V1.8 Build 172

**Low Channel 1/Area Scan (4x14x1):** Measurement grid: dx=15mm, dy=15mm

Maximum value of SAR (measured) = 0.691 mW/g

**Low Channel 1/Zoom Scan (7x7x7) (7x7x7)/Cube 0:** Measurement grid: dx=5mm, dy=5mm, dz=5mm

Reference Value = 19.7 V/m

Peak SAR (extrapolated) = 1.37 W/kg

**SAR(1 g) = 0.672 mW/g; SAR(10 g) = 0.364 mW/g**

Maximum value of SAR (measured) = 0.714 mW/g

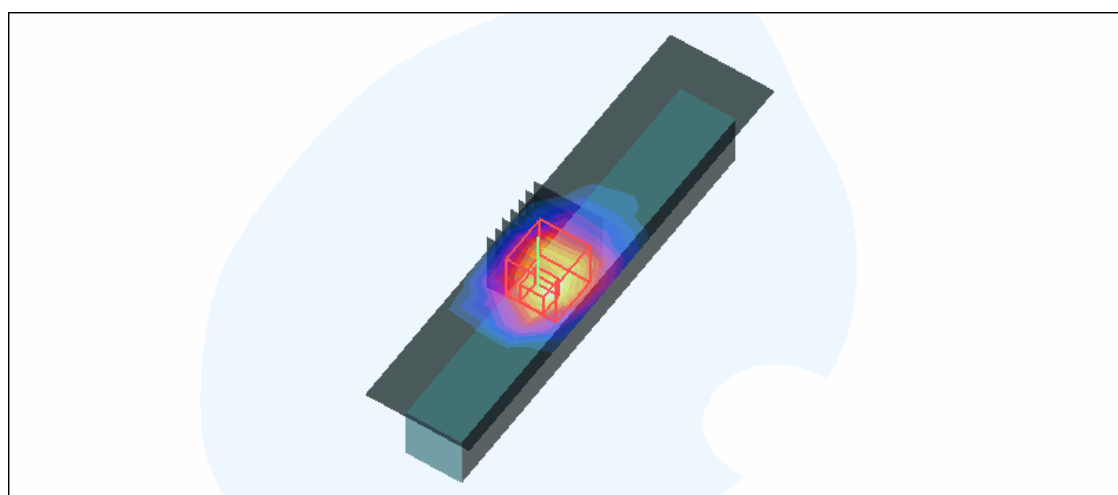
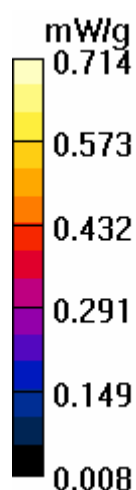

Test Laboratory: Advance Data Technology

### 11b-Ch6-M01

**DUT: 802.11n/g/b Wireless USB Adapter ; Type: WUB-375L ; Test Frequency: 2437 MHz**

Communication System: 802.11b ; Frequency: 2437 MHz ; Duty Cycle: 1:1 ; Modulation type: DBPSK  
 Medium: MSL2450 Medium parameters used:  $f = 2437 \text{ MHz}$ ;  $\sigma = 1.96 \text{ mho/m}$ ;  $\epsilon_r = 53$ ;  $\rho = 1000 \text{ kg/m}^3$  ; Liquid level : 152 mm

Phantom section: Flat Section ; Separation distance : 0 mm (The bottom side of the EUT to the Phantom)

Antenna type : Printed Antenna ; Air temp. : 23.6 degrees ; Liquid temp. : 22.5 degrees

DASY4 Configuration:

- Probe: ET3DV6 - SN1790 ; ConvF(4.16, 4.16, 4.16) ; Calibrated: 2007/11/20
- Sensor-Surface: 4mm (Mechanical Surface Detection)
- Electronics: DAE3 Sn510 ; Calibrated: 2007/8/29
- Phantom: SAM 12 ; Type: SAM V4.0 ; Serial: TP 1202
- Measurement SW: DASY4, V4.7 Build 53 ; Postprocessing SW: SEMCAD, V1.8 Build 172

**Mid Channel 6/Area Scan (4x5x1):** Measurement grid:  $dx=15\text{mm}$ ,  $dy=15\text{mm}$

Maximum value of SAR (measured) = 0.722 mW/g

**Mid Channel 6/Zoom Scan (7x7x7) (7x7x7)/Cube 0:** Measurement grid:  $dx=5\text{mm}$ ,  $dy=5\text{mm}$ ,  $dz=5\text{mm}$

Reference Value = 19.8 V/m

Peak SAR (extrapolated) = 1.46 W/kg

**SAR(1 g) = 0.704 mW/g; SAR(10 g) = 0.375 mW/g**

Maximum value of SAR (measured) = 0.744 mW/g

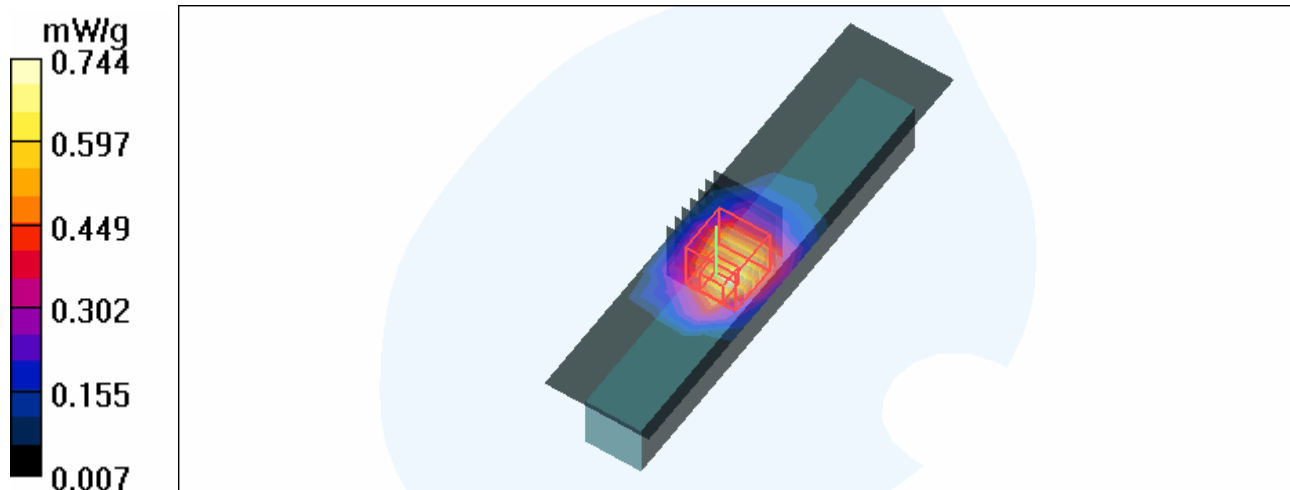

Test Laboratory: Advance Data Technology

## 11b-Ch11-M01

**DUT: 802.11n/g/b Wireless USB Adapter ; Type: WUB-375L ; Test Frequency: 2462 MHz**

Communication System: 802.11b ; Frequency: 2462 MHz ; Duty Cycle: 1:1 ; Modulation type: DBPSK  
Medium: MSL2450 Medium parameters used:  $f = 2462$  MHz;  $\sigma = 1.98$  mho/m;  $\epsilon_r = 52.8$ ;  $\rho = 1000$  kg/m<sup>3</sup> ; Liquid level : 152 mm

Phantom section: Flat Section ; Separation distance : 0 mm (The bottom side of the EUT to the Phantom)  
Antenna type : Printed Antenna ; Air temp. : 23.6 degrees ; Liquid temp. : 22.5 degrees

DASY4 Configuration:

- Probe: ET3DV6 - SN1790 ; ConvF(4.16, 4.16, 4.16) ; Calibrated: 2007/11/20
- Sensor-Surface: 4mm (Mechanical Surface Detection)
- Electronics: DAE3 Sn510 ; Calibrated: 2007/8/29
- Phantom: SAM 12 ; Type: SAM V4.0 ; Serial: TP 1202
- Measurement SW: DASY4, V4.7 Build 53 ; Postprocessing SW: SEMCAD, V1.8 Build 172

**High Channel 11/Area Scan (4x14x1):** Measurement grid: dx=15mm, dy=15mm  
Maximum value of SAR (measured) = 0.727 mW/g

**High Channel 11/Zoom Scan (7x7x7) (7x7x7)/Cube 0:** Measurement grid: dx=5mm, dy=5mm, dz=5mm

Reference Value = 20.6 V/m

Peak SAR (extrapolated) = 1.75 W/kg

**SAR(1 g) = 0.824 mW/g; SAR(10 g) = 0.432 mW/g**

Maximum value of SAR (measured) = 0.889 mW/g

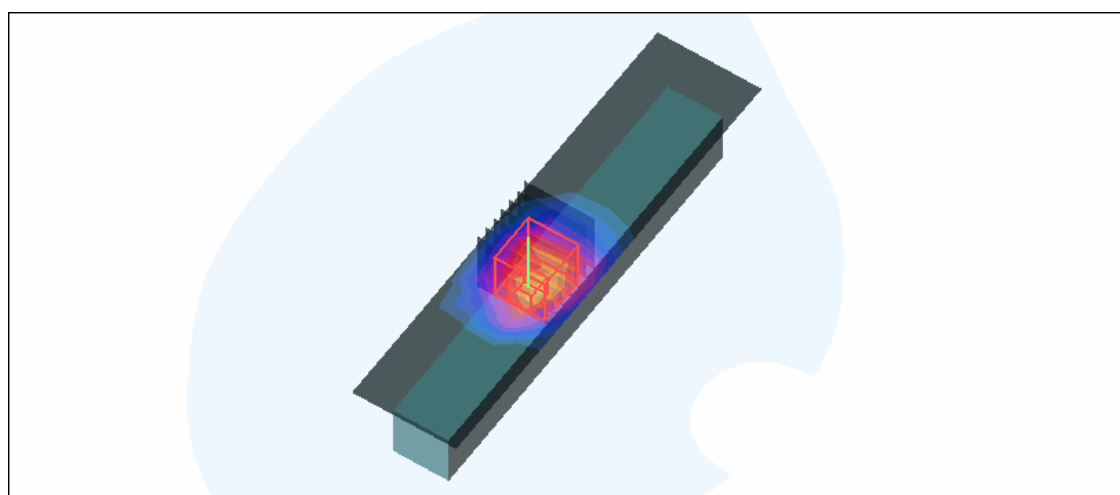
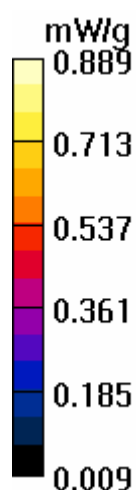

Test Laboratory: Advance Data Technology

## 11g-Ch1-M02

**DUT: 802.11n/g/b Wireless USB Adapter ; Type: WUB-375L ; Test Frequency: 2412 MHz**

Communication System: 802.11g ; Frequency: 2412 MHz ; Duty Cycle: 1:1 ; Modulation type: BPSK  
 Medium: MSL2450 Medium parameters used:  $f = 2412$  MHz;  $\sigma = 1.93$  mho/m;  $\epsilon_r = 53.1$ ;  $\rho = 1000$  kg/m<sup>3</sup> ; Liquid level : 152 mm

Phantom section: Flat Section ; Separation distance : 0 mm (The bottom side of the EUT to the Phantom)  
 Antenna type : Printed Antenna ; Air temp. : 23.6 degrees ; Liquid temp. : 22.5 degrees

DASY4 Configuration:

- Probe: ET3DV6 - SN1790 ; ConvF(4.16, 4.16, 4.16) ; Calibrated: 2007/11/20
- Sensor-Surface: 4mm (Mechanical Surface Detection)
- Electronics: DAE3 Sn510 ; Calibrated: 2007/8/29
- Phantom: SAM 12 ; Type: SAM V4.0 ; Serial: TP 1202
- Measurement SW: DASY4, V4.7 Build 53 ; Postprocessing SW: SEMCAD, V1.8 Build 172

**Low Channel 1/Area Scan (4x14x1):** Measurement grid: dx=15mm, dy=15mm  
 Maximum value of SAR (measured) = 0.872 mW/g

**Low Channel 1/Zoom Scan (7x7x7) (7x7x7)/Cube 0:** Measurement grid: dx=5mm, dy=5mm, dz=5mm

Reference Value = 20.8 V/m

Peak SAR (extrapolated) = 1.76 W/kg

**SAR(1 g) = 0.841 mW/g; SAR(10 g) = 0.451 mW/g**

Maximum value of SAR (measured) = 0.908 mW/g

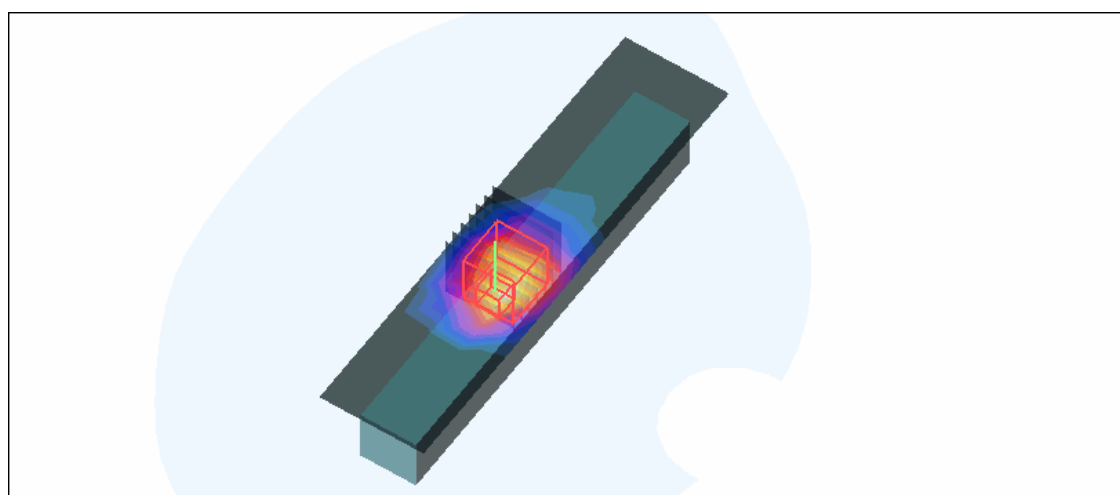
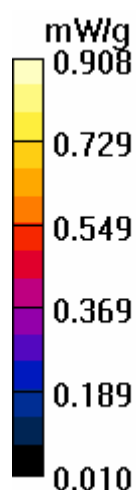

Test Laboratory: Advance Data Technology

### 11g-Ch6-M02

**DUT: 802.11n/g/b Wireless USB Adapter ; Type: WUB-375L ; Test Frequency: 2437 MHz**

Communication System: 802.11g ; Frequency: 2437 MHz ; Duty Cycle: 1:1 ; Modulation type: BPSK  
Medium: MSL2450 Medium parameters used:  $f = 2437$  MHz;  $\sigma = 1.96$  mho/m;  $\epsilon_r = 53$ ;  $\rho = 1000$  kg/m<sup>3</sup> ; Liquid level : 152 mm

Phantom section: Flat Section ; Separation distance : 0 mm (The bottom side of the EUT to the Phantom)  
Antenna type : Printed Antenna ; Air temp. : 23.6 degrees ; Liquid temp. : 22.5 degrees

DASY4 Configuration:

- Probe: ET3DV6 - SN1790 ; ConvF(4.16, 4.16, 4.16) ; Calibrated: 2007/11/20
- Sensor-Surface: 4mm (Mechanical Surface Detection)
- Electronics: DAE3 Sn510 ; Calibrated: 2007/8/29
- Phantom: SAM 12 ; Type: SAM V4.0 ; Serial: TP 1202
- Measurement SW: DASY4, V4.7 Build 53 ; Postprocessing SW: SEMCAD, V1.8 Build 172

**Mid Channel 6/Area Scan (4x14x1):** Measurement grid: dx=15mm, dy=15mm  
Maximum value of SAR (measured) = 0.887 mW/g

**Mid Channel 6/Zoom Scan (7x7x7) (7x7x7)/Cube 0:** Measurement grid: dx=5mm, dy=5mm, dz=5mm

Reference Value = 20.4 V/m

Peak SAR (extrapolated) = 1.81 W/kg

**SAR(1 g) = 0.854 mW/g; SAR(10 g) = 0.449 mW/g**

Maximum value of SAR (measured) = 0.918 mW/g

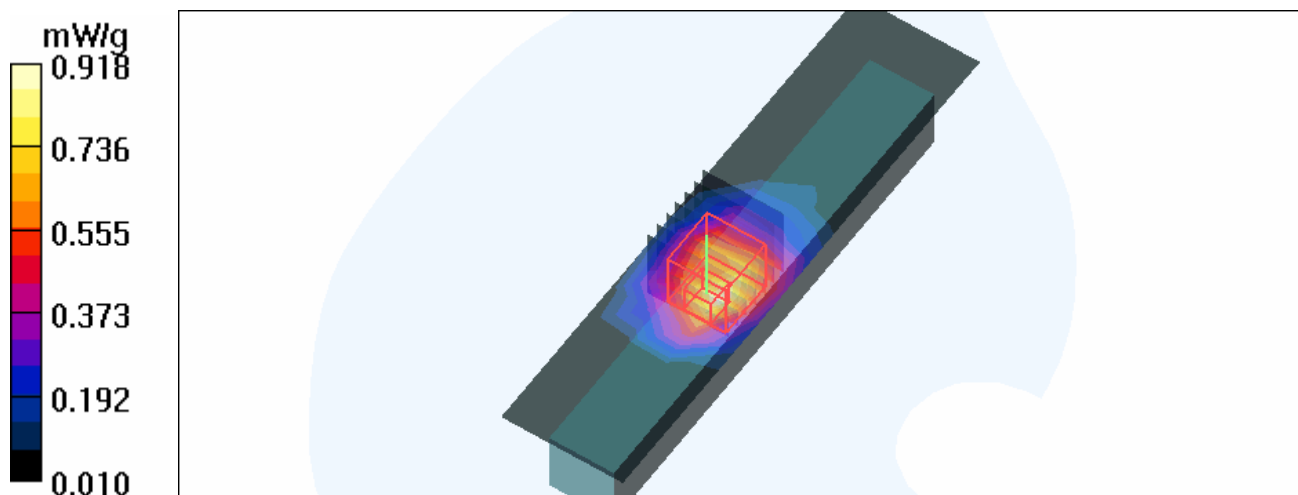

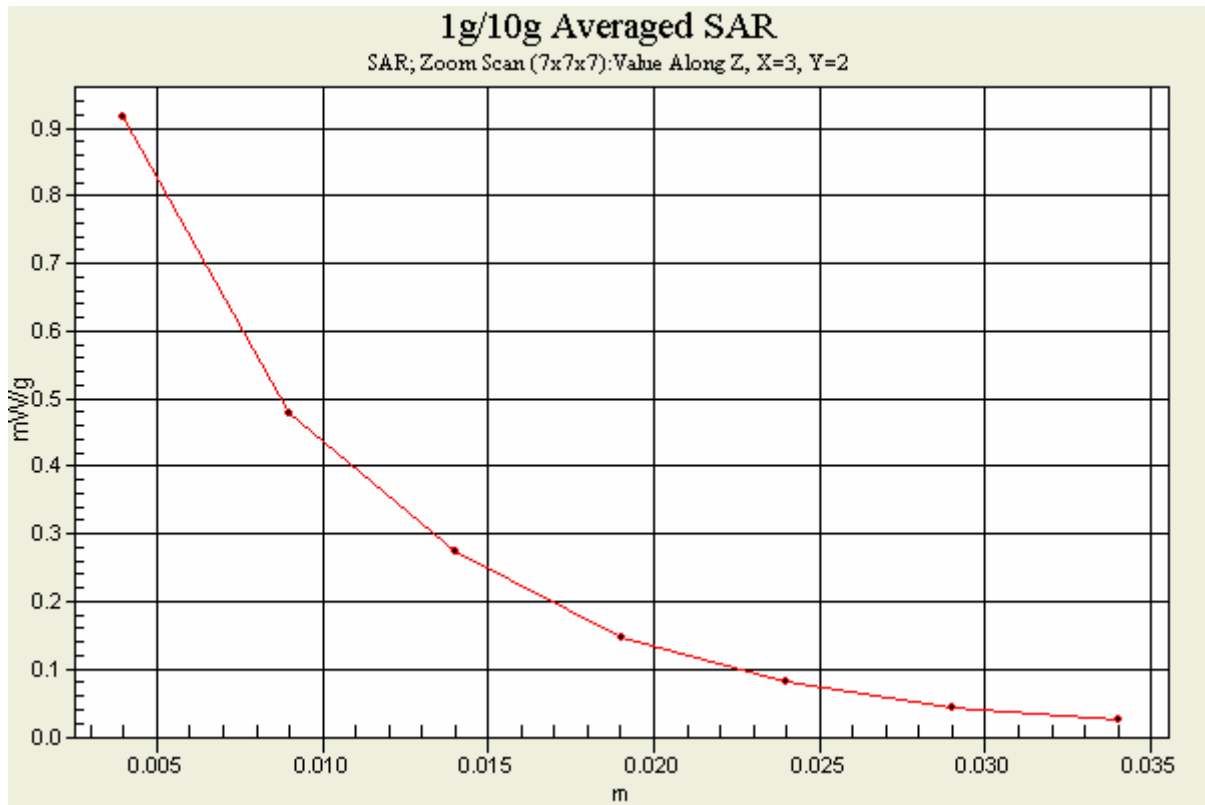

Test Laboratory: Advance Data Technology

## 11g-Ch11-M02

**DUT: 802.11n/g/b Wireless USB Adapter ; Type: WUB-375L ; Test Frequency: 2462 MHz**

Communication System: 802.11g ; Frequency: 2462 MHz ; Duty Cycle: 1:1 ; Modulation type: BPSK  
Medium: MSL2450 Medium parameters used:  $f = 2462$  MHz;  $\sigma = 1.98$  mho/m;  $\epsilon_r = 52.8$ ;  $\rho = 1000$  kg/m<sup>3</sup> ; Liquid level : 152 mm

Phantom section: Flat Section ; Separation distance : 0 mm (The bottom side of the EUT to the Phantom)  
Antenna type : Printed Antenna ; Air temp. : 23.6 degrees ; Liquid temp. : 22.5 degrees

DASY4 Configuration:

- Probe: ET3DV6 - SN1790 ; ConvF(4.16, 4.16, 4.16) ; Calibrated: 2007/11/20
- Sensor-Surface: 4mm (Mechanical Surface Detection)
- Electronics: DAE3 Sn510 ; Calibrated: 2007/8/29
- Phantom: SAM 12 ; Type: SAM V4.0 ; Serial: TP 1202
- Measurement SW: DASY4, V4.7 Build 53 ; Postprocessing SW: SEMCAD, V1.8 Build 172

**High Channel 11/Area Scan (4x14x1):** Measurement grid: dx=15mm, dy=15mm  
Maximum value of SAR (measured) = 0.645 mW/g

**High Channel 11/Zoom Scan (7x7x7) (7x7x7)/Cube 0:** Measurement grid: dx=5mm, dy=5mm, dz=5mm

Reference Value = 17.3 V/m

Peak SAR (extrapolated) = 1.36 W/kg

**SAR(1 g) = 0.631 mW/g; SAR(10 g) = 0.329 mW/g**

Maximum value of SAR (measured) = 0.679 mW/g

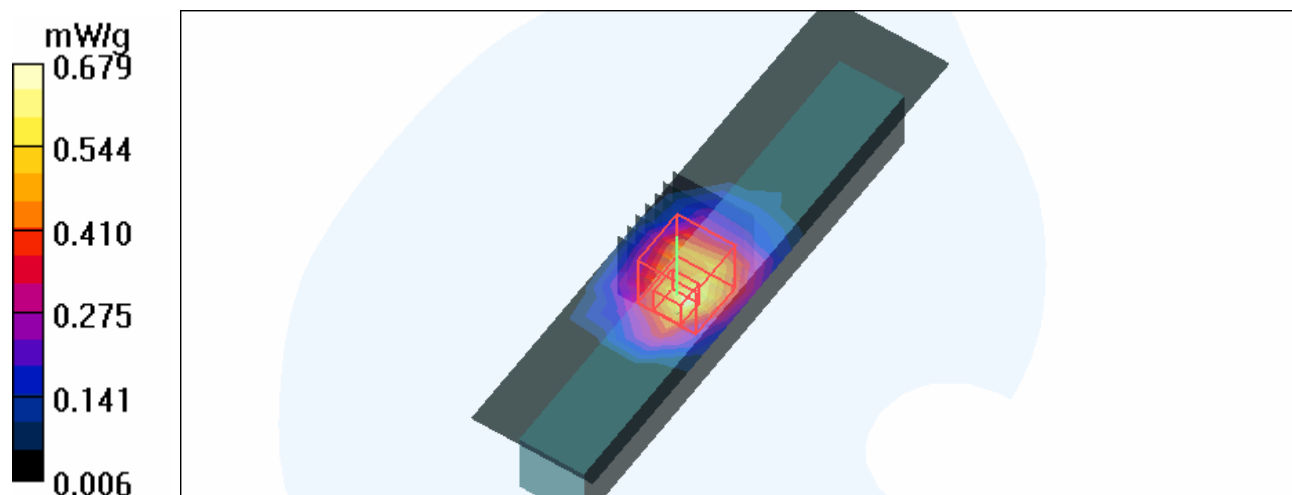



Test Laboratory: Advance Data Technology

## 11N 20M-Ch1-M03

**DUT: 802.11n/g/b Wireless USB Adapter ; Type: WUB-375L ; Test Frequency: 2412 MHz**

Communication System: 2.4G 11n span20 ; Frequency: 2412 MHz ; Duty Cycle: 1:1 ; Modulation type: BPSK

Medium: MSL2450 Medium parameters used:  $f = 2412$  MHz;  $\sigma = 1.93$  mho/m;  $\epsilon_r = 53.1$ ;  $\rho = 1000$  kg/m<sup>3</sup> ; Liquid level : 152 mm

Phantom section: Flat Section ; Separation distance : 0 mm (The bottom side of the EUT to the Phantom)

Antenna type : Printed Antenna ; Air temp. : 23.6 degrees ; Liquid temp. : 22.5 degrees

DASY4 Configuration:

- Probe: ET3DV6 - SN1790 ; ConvF(4.16, 4.16, 4.16) ; Calibrated: 2007/11/20
- Sensor-Surface: 4mm (Mechanical Surface Detection)
- Electronics: DAE3 Sn510 ; Calibrated: 2007/8/29
- Phantom: SAM 12 ; Type: SAM V4.0 ; Serial: TP 1202
- Measurement SW: DASY4, V4.7 Build 53 ; Postprocessing SW: SEMCAD, V1.8 Build 172

**Low Channel 1/Area Scan (4x14x1):** Measurement grid: dx=15mm, dy=15mm

Maximum value of SAR (measured) = 0.844 mW/g

**Low Channel 1/Zoom Scan (7x7x7) (7x7x7)/Cube 0:** Measurement grid: dx=5mm, dy=5mm, dz=5mm

Reference Value = 20.1 V/m

Peak SAR (extrapolated) = 1.67 W/kg

**SAR(1 g) = 0.803 mW/g; SAR(10 g) = 0.431 mW/g**

Maximum value of SAR (measured) = 0.864 mW/g

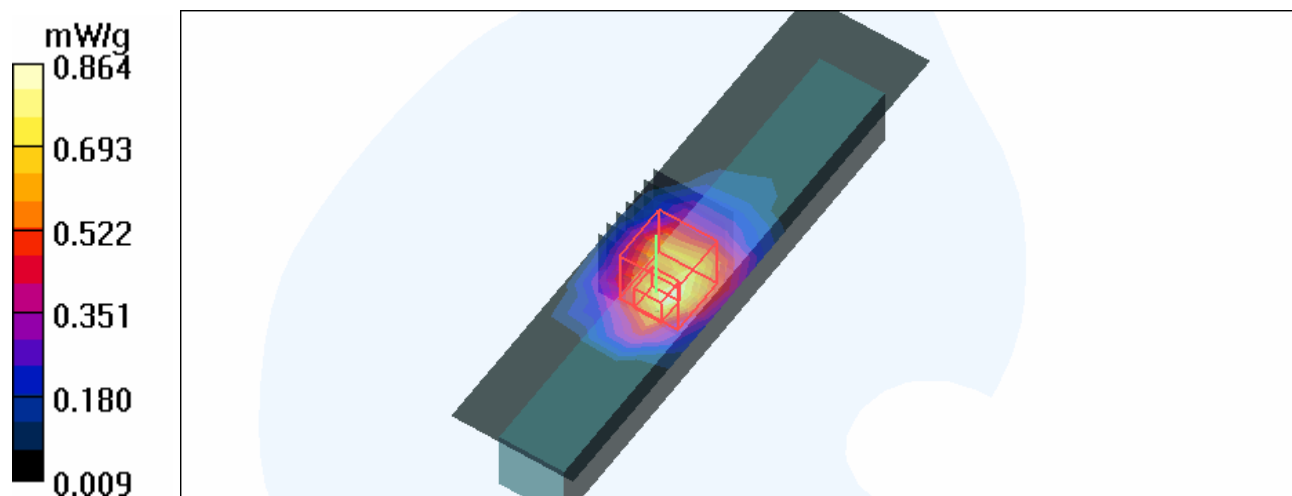

Test Laboratory: Advance Data Technology

## 11N 20M-Ch6-M03

**DUT: 802.11n/g/b Wireless USB Adapter ; Type: WUB-375L ; Test Frequency: 2437 MHz**

Communication System: 2.4G 11n span20 ; Frequency: 2437 MHz ; Duty Cycle: 1:1 ; Modulation type: BPSK

Medium: MSL2450 Medium parameters used:  $f = 2437$  MHz;  $\sigma = 1.96$  mho/m;  $\epsilon_r = 53$ ;  $\rho = 1000$  kg/m<sup>3</sup> ; Liquid level : 152 mm

Phantom section: Flat Section ; Separation distance : 0 mm (The bottom side of the EUT to the Phantom)

Antenna type : Printed Antenna ; Air temp. : 23.6 degrees ; Liquid temp. : 22.5 degrees

DASY4 Configuration:

- Probe: ET3DV6 - SN1790 ; ConvF(4.16, 4.16, 4.16) ; Calibrated: 2007/11/20
- Sensor-Surface: 4mm (Mechanical Surface Detection)
- Electronics: DAE3 Sn510 ; Calibrated: 2007/8/29
- Phantom: SAM 12 ; Type: SAM V4.0 ; Serial: TP 1202
- Measurement SW: DASY4, V4.7 Build 53 ; Postprocessing SW: SEMCAD, V1.8 Build 172

**Mid Channel 6/Area Scan (4x14x1):** Measurement grid: dx=15mm, dy=15mm

Maximum value of SAR (measured) = 0.845 mW/g

**Mid Channel 6/Zoom Scan (7x7x7) (7x7x7)/Cube 0:** Measurement grid: dx=5mm, dy=5mm, dz=5mm

Reference Value = 20.6 V/m

Peak SAR (extrapolated) = 1.73 W/kg

**SAR(1 g) = 0.815 mW/g; SAR(10 g) = 0.429 mW/g**

Maximum value of SAR (measured) = 0.877 mW/g

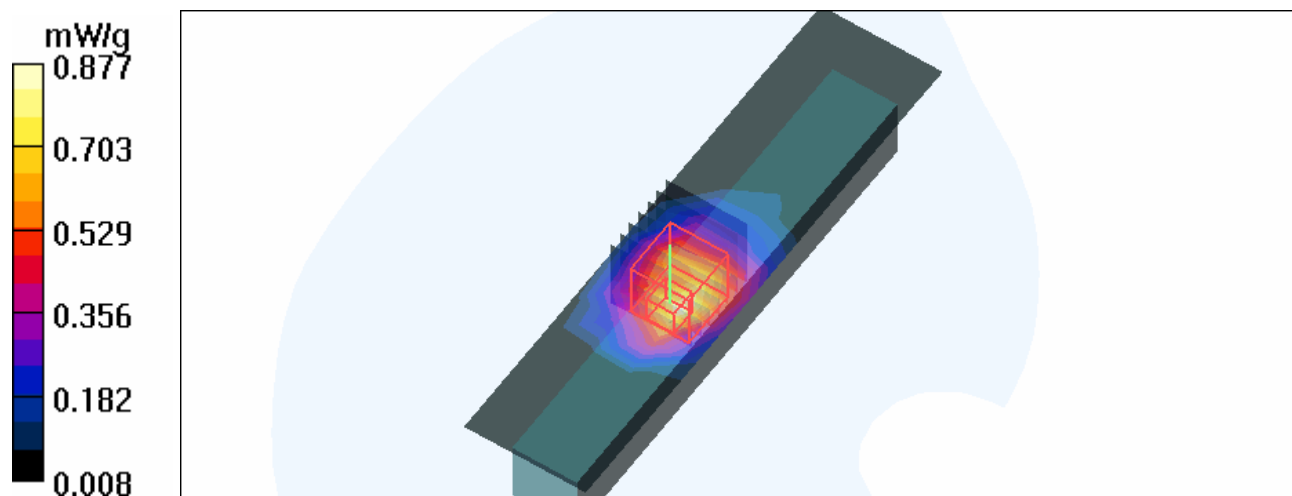

Test Laboratory: Advance Data Technology

## 11N 20M-Ch11-M03

**DUT: 802.11n/g/b Wireless USB Adapter ; Type: WUB-375L ; Test Frequency: 2462 MHz**

Communication System: 2.4G 11n span20 ; Frequency: 2462 MHz ; Duty Cycle: 1:1 ; Modulation type: BPSK

Medium: MSL2450 Medium parameters used:  $f = 2462$  MHz;  $\sigma = 1.98$  mho/m;  $\epsilon_r = 52.8$ ;  $\rho = 1000$  kg/m<sup>3</sup> ; Liquid level : 152 mm

Phantom section: Flat Section ; Separation distance : 0 mm (The bottom side of the EUT to the Phantom)

Antenna type : Printed Antenna ; Air temp. : 23.6 degrees ; Liquid temp. : 22.5 degrees

DASY4 Configuration:

- Probe: ET3DV6 - SN1790 ; ConvF(4.16, 4.16, 4.16) ; Calibrated: 2007/11/20
- Sensor-Surface: 4mm (Mechanical Surface Detection)
- Electronics: DAE3 Sn510 ; Calibrated: 2007/8/29
- Phantom: SAM 12 ; Type: SAM V4.0 ; Serial: TP 1202
- Measurement SW: DASY4, V4.7 Build 53 ; Postprocessing SW: SEMCAD, V1.8 Build 172

**High Channel 11/Area Scan (4x14x1):** Measurement grid: dx=15mm, dy=15mm

Maximum value of SAR (measured) = 0.589 mW/g

**High Channel 11/Zoom Scan (7x7x7) (7x7x7)/Cube 0:** Measurement grid: dx=5mm, dy=5mm, dz=5mm

Reference Value = 16.2 V/m

Peak SAR (extrapolated) = 1.22 W/kg

**SAR(1 g) = 0.571 mW/g; SAR(10 g) = 0.298 mW/g**

Maximum value of SAR (measured) = 0.613 mW/g

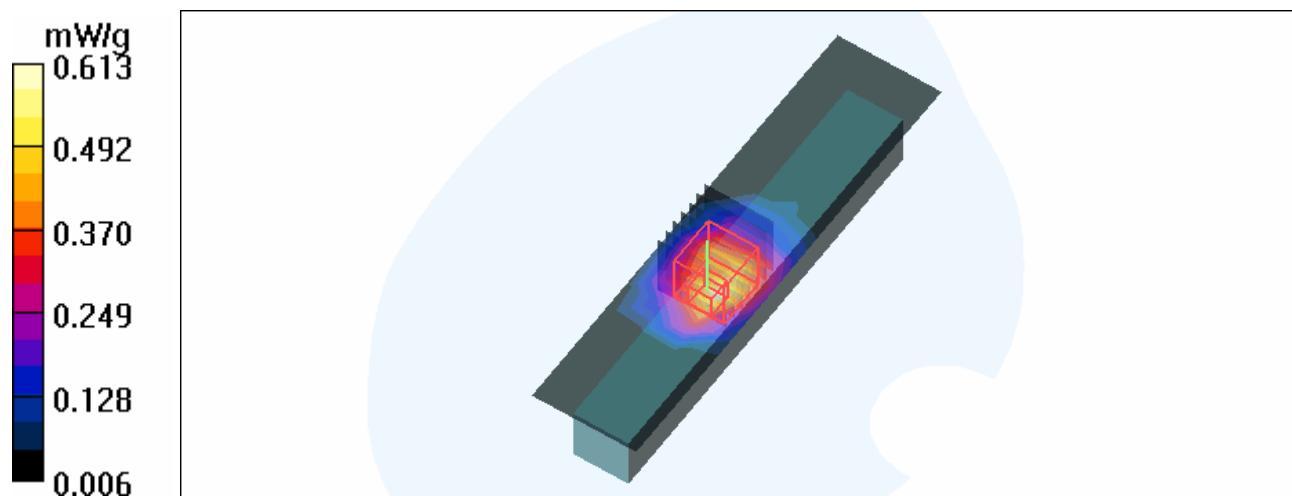

Test Laboratory: Advance Data Technology

## 11N 40M-Ch1-M04

**DUT: 802.11n/g/b Wireless USB Adapter ; Type: WUB-375L ; Test Frequency: 2422 MHz**

Communication System: 802.11n 40MHz ; Frequency: 2422 MHz ; Duty Cycle: 1:1 ; Modulation type: BPSK

Medium: MSL2450 Medium parameters used:  $f = 2422$  MHz;  $\sigma = 1.94$  mho/m;  $\epsilon_r = 53$ ;  $\rho = 1000$  kg/m<sup>3</sup> ; Liquid level : 152 mm

Phantom section: Flat Section ; Separation distance : 0 mm (The bottom side of the EUT to the Phantom)

Antenna type : Printed Antenna ; Air temp. : 23.6 degrees ; Liquid temp. : 22.5 degrees

DASY4 Configuration:

- Probe: ET3DV6 - SN1790 ; ConvF(4.16, 4.16, 4.16) ; Calibrated: 2007/11/20
- Sensor-Surface: 4mm (Mechanical Surface Detection)
- Electronics: DAE3 Sn510 ; Calibrated: 2007/8/29
- Phantom: SAM 12 ; Type: SAM V4.0 ; Serial: TP 1202
- Measurement SW: DASY4, V4.7 Build 53 ; Postprocessing SW: SEMCAD, V1.8 Build 172

**Low Channel 1/Area Scan (4x14x1):** Measurement grid: dx=15mm, dy=15mm

Maximum value of SAR (measured) = 0.520 mW/g

**Low Channel 1/Zoom Scan (7x7x7) (7x7x7)/Cube 0:** Measurement grid: dx=5mm, dy=5mm, dz=5mm

Reference Value = 15.2 V/m

Peak SAR (extrapolated) = 1.04 W/kg

**SAR(1 g) = 0.493 mW/g; SAR(10 g) = 0.263 mW/g**

Maximum value of SAR (measured) = 0.532 mW/g

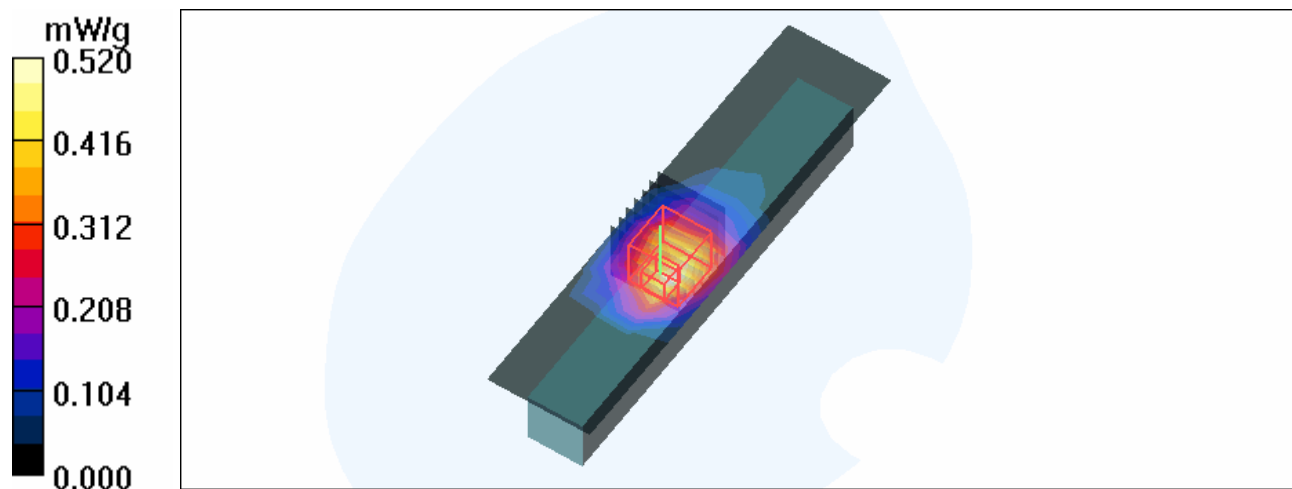

Test Laboratory: Advance Data Technology

## 11N 40M-Ch4-M04

**DUT: 802.11n/g/b Wireless USB Adapter ; Type: WUB-375L ; Test Frequency: 2437 MHz**

Communication System: 802.11n 40MHz ; Frequency: 2437 MHz ; Duty Cycle: 1:1 ; Modulation type: BPSK

Medium: MSL2450 Medium parameters used:  $f = 2437$  MHz;  $\sigma = 1.96$  mho/m;  $\epsilon_r = 53$ ;  $\rho = 1000$  kg/m<sup>3</sup> ; Liquid level : 152 mm

Phantom section: Flat Section ; Separation distance : 0 mm (The bottom side of the EUT to the Phantom)

Antenna type : Printed Antenna ; Air temp. : 23.6 degrees ; Liquid temp. : 22.5 degrees

DASY4 Configuration:

- Probe: ET3DV6 - SN1790 ; ConvF(4.16, 4.16, 4.16) ; Calibrated: 2007/11/20
- Sensor-Surface: 4mm (Mechanical Surface Detection)
- Electronics: DAE3 Sn510 ; Calibrated: 2007/8/29
- Phantom: SAM 12 ; Type: SAM V4.0 ; Serial: TP 1202
- Measurement SW: DASY4, V4.7 Build 53 ; Postprocessing SW: SEMCAD, V1.8 Build 172

**Mid Channel 4/Area Scan (4x14x1):** Measurement grid: dx=15mm, dy=15mm

Maximum value of SAR (measured) = 0.514 mW/g

**Mid Channel 4/Zoom Scan (7x7x7) (7x7x7)/Cube 0:** Measurement grid: dx=5mm, dy=5mm, dz=5mm

Reference Value = 15.9 V/m

Peak SAR (extrapolated) = 1.04 W/kg

**SAR(1 g) = 0.489 mW/g; SAR(10 g) = 0.257 mW/g**

Maximum value of SAR (measured) = 0.529 mW/g

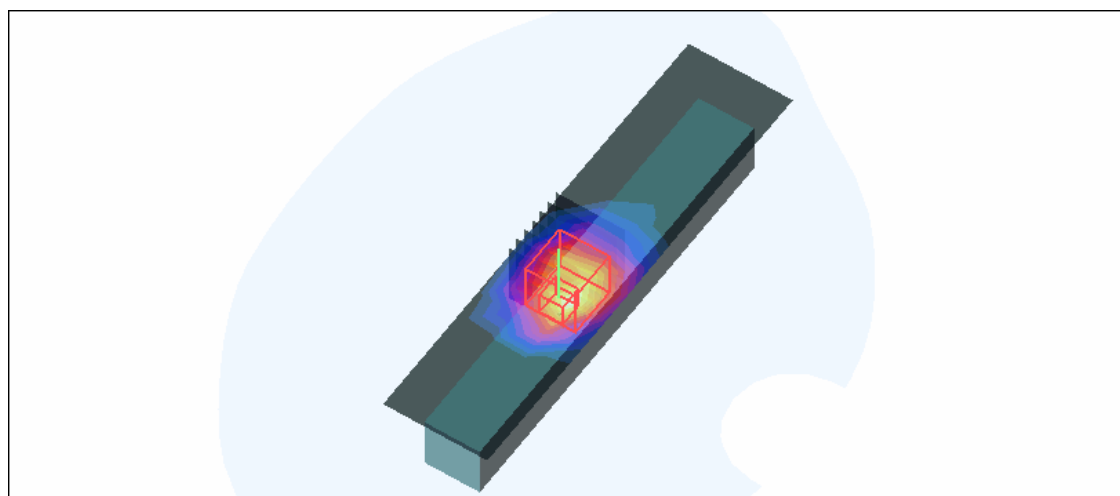
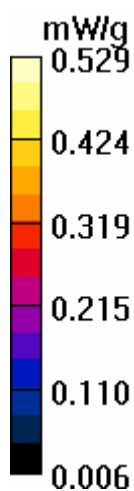

Test Laboratory: Advance Data Technology

## 11N 40M-Ch7-M04

**DUT: 802.11n/g/b Wireless USB Adapter ; Type: WUB-375L ; Test Frequency: 2452 MHz**

Communication System: 802.11n 40MHz ; Frequency: 2452 MHz ; Duty Cycle: 1:1 ; Modulation type: BPSK

Medium: MSL2450 Medium parameters used:  $f = 2452$  MHz;  $\sigma = 1.97$  mho/m;  $\epsilon_r = 52.9$ ;  $\rho = 1000$  kg/m<sup>3</sup> ; Liquid level : 152 mm

Phantom section: Flat Section ; Separation distance : 0 mm (The bottom side of the EUT to the Phantom)

Antenna type : Printed Antenna ; Air temp. : 23.6 degrees ; Liquid temp. : 22.5 degrees

DASY4 Configuration:

- Probe: ET3DV6 - SN1790 ; ConvF(4.16, 4.16, 4.16) ; Calibrated: 2007/11/20
- Sensor-Surface: 4mm (Mechanical Surface Detection)
- Electronics: DAE3 Sn510 ; Calibrated: 2007/8/29
- Phantom: SAM 12 ; Type: SAM V4.0 ; Serial: TP 1202
- Measurement SW: DASY4, V4.7 Build 53 ; Postprocessing SW: SEMCAD, V1.8 Build 172

**High Channel 7/Area Scan (4x14x1):** Measurement grid: dx=15mm, dy=15mm

Maximum value of SAR (measured) = 0.439 mW/g

**High Channel 7/Zoom Scan (7x7x7) (7x7x7)/Cube 0:** Measurement grid: dx=5mm, dy=5mm, dz=5mm

Reference Value = 14.4 V/m

Peak SAR (extrapolated) = 0.910 W/kg

**SAR(1 g) = 0.424 mW/g; SAR(10 g) = 0.222 mW/g**

Maximum value of SAR (measured) = 0.457 mW/g

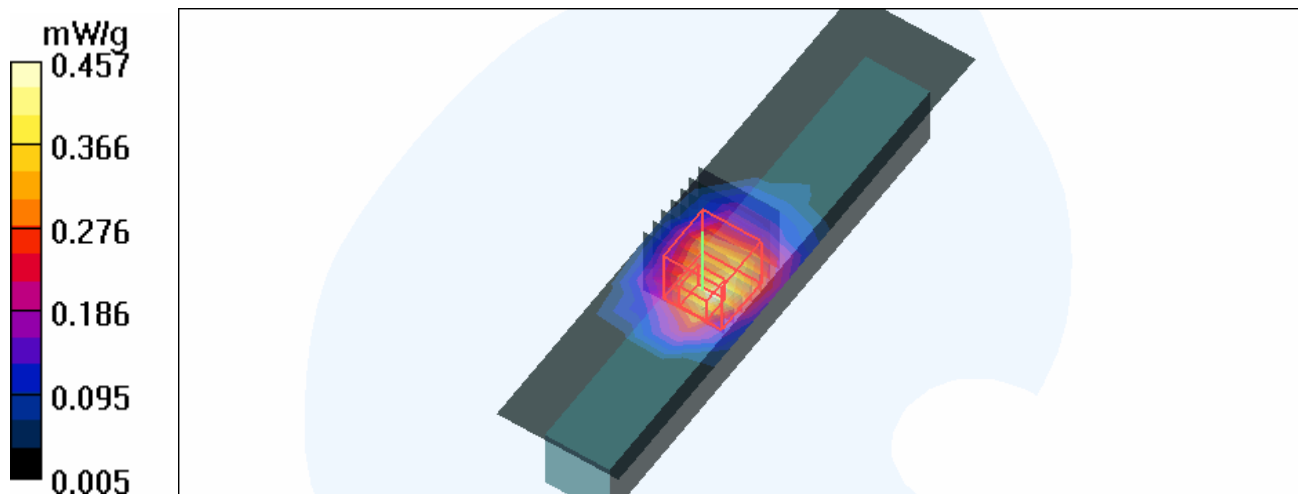

Test Laboratory: Advance Data Technology

### 11b-Ch11-M05

**DUT: 802.11n/g/b Wireless USB Adapter ; Type: WUB-375L ; Test Frequency: 2462 MHz**

Communication System: 802.11b ; Frequency: 2462 MHz ; Duty Cycle: 1:1 ; Modulation type: DBPSK  
Medium: MSL2450 Medium parameters used:  $f = 2462$  MHz;  $\sigma = 1.98$  mho/m;  $\epsilon_r = 52.8$ ;  $\rho = 1000$  kg/m<sup>3</sup> ; Liquid level : 152 mm  
Phantom section: Flat Section ; Separation distance : 4 mm (The edge side of the EUT to the Phantom)  
Antenna type : Printed Antenna ; Air temp. : 23.6 degrees ; Liquid temp. : 22.5 degrees

DASY4 Configuration:

- Probe: ET3DV6 - SN1790 ; ConvF(4.16, 4.16, 4.16) ; Calibrated: 2007/11/20
- Sensor-Surface: 4mm (Mechanical Surface Detection)
- Electronics: DAE3 Sn510 ; Calibrated: 2007/8/29
- Phantom: SAM 12 ; Type: SAM V4.0 ; Serial: TP 1202
- Measurement SW: DASY4, V4.7 Build 53 ; Postprocessing SW: SEMCAD, V1.8 Build 172

**High Channel 11/Area Scan (4x14x1):** Measurement grid: dx=15mm, dy=15mm  
Maximum value of SAR (measured) = 0.369 mW/g

**High Channel 11/Zoom Scan (7x7x7) (7x7x7)/Cube 0:** Measurement grid: dx=5mm, dy=5mm, dz=5mm  
Reference Value = 11.1 V/m  
Peak SAR (extrapolated) = 0.943 W/kg  
**SAR(1 g) = 0.408 mW/g; SAR(10 g) = 0.195 mW/g**  
Maximum value of SAR (measured) = 0.454 mW/g

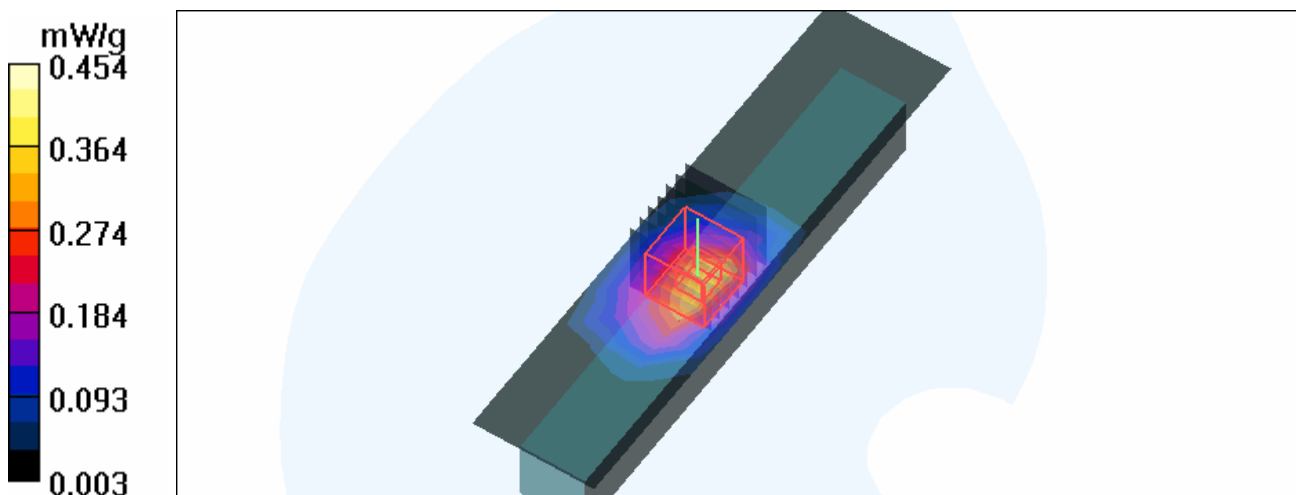

Test Laboratory: Advance Data Technology

**11g-Ch6-M06****DUT: 802.11n/g/b Wireless USB Adapter ; Type: WUB-375L ; Test Frequency: 2437 MHz**

Communication System: 802.11g ; Frequency: 2437 MHz ; Duty Cycle: 1:1 ; Modulation type: BPSK  
Medium: MSL2450 Medium parameters used:  $f = 2437$  MHz;  $\sigma = 1.96$  mho/m;  $\epsilon_r = 53$ ;  $\rho = 1000$  kg/m<sup>3</sup> ; Liquid level : 152 mm

Phantom section: Flat Section ; Separation distance : 4 mm (The edge side of the EUT to the Phantom)

Antenna type : Printed Antenna ; Air temp. : 23.6 degrees ; Liquid temp. : 22.5 degrees

DASY4 Configuration:

- Probe: ET3DV6 - SN1790 ; ConvF(4.16, 4.16, 4.16) ; Calibrated: 2007/11/20
- Sensor-Surface: 4mm (Mechanical Surface Detection)
- Electronics: DAE3 Sn510 ; Calibrated: 2007/8/29
- Phantom: SAM 12 ; Type: SAM V4.0 ; Serial: TP 1202
- Measurement SW: DASY4, V4.7 Build 53 ; Postprocessing SW: SEMCAD, V1.8 Build 172

**Mid Channel 6/Area Scan (4x14x1):** Measurement grid: dx=15mm, dy=15mm

Maximum value of SAR (measured) = 0.382 mW/g

**Mid Channel 6/Zoom Scan (7x7x7) (7x7x7)/Cube 0:** Measurement grid: dx=5mm, dy=5mm, dz=5mm

Reference Value = 11.7 V/m

Peak SAR (extrapolated) = 0.962 W/kg

**SAR(1 g) = 0.415 mW/g; SAR(10 g) = 0.200 mW/g**

Maximum value of SAR (measured) = 0.459 mW/g

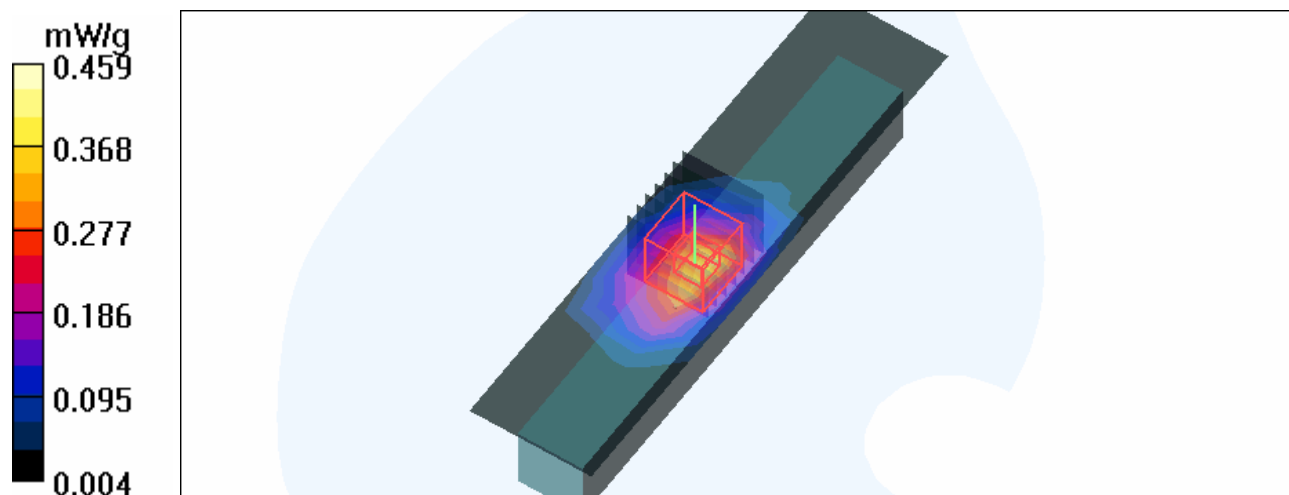



Test Laboratory: Advance Data Technology

## 11N 20M-Ch1-M07

**DUT: 802.11n/g/b Wireless USB Adapter ; Type: WUB-375L ; Test Frequency: 2412 MHz**

Communication System: 2.4G 11n span20 ; Frequency: 2412 MHz ; Duty Cycle: 1:1 ; Modulation type: BPSK

Medium: MSL2450 Medium parameters used:  $f = 2412$  MHz;  $\sigma = 1.93$  mho/m;  $\epsilon_r = 53.1$ ;  $\rho = 1000$  kg/m<sup>3</sup> ; Liquid level : 152 mm

Phantom section: Flat Section ; Separation distance : 4 mm (The edge side of the EUT to the Phantom)

Antenna type : Printed Antenna ; Air temp. : 23.6 degrees ; Liquid temp. : 22.5 degrees

DASY4 Configuration:

- Probe: ET3DV6 - SN1790 ; ConvF(4.16, 4.16, 4.16) ; Calibrated: 2007/11/20
- Sensor-Surface: 4mm (Mechanical Surface Detection)
- Electronics: DAE3 Sn510 ; Calibrated: 2007/8/29
- Phantom: SAM 12 ; Type: SAM V4.0 ; Serial: TP 1202
- Measurement SW: DASY4, V4.7 Build 53 ; Postprocessing SW: SEMCAD, V1.8 Build 172

**Low Channel 1/Area Scan (4x14x1):** Measurement grid: dx=15mm, dy=15mm

Maximum value of SAR (measured) = 0.372 mW/g

**Low Channel 1/Zoom Scan (7x7x7) (7x7x7)/Cube 0:** Measurement grid: dx=5mm, dy=5mm, dz=5mm

Reference Value = 10.9 V/m

Peak SAR (extrapolated) = 0.945 W/kg

**SAR(1 g) = 0.407 mW/g; SAR(10 g) = 0.196 mW/g**

Maximum value of SAR (measured) = 0.451 mW/g

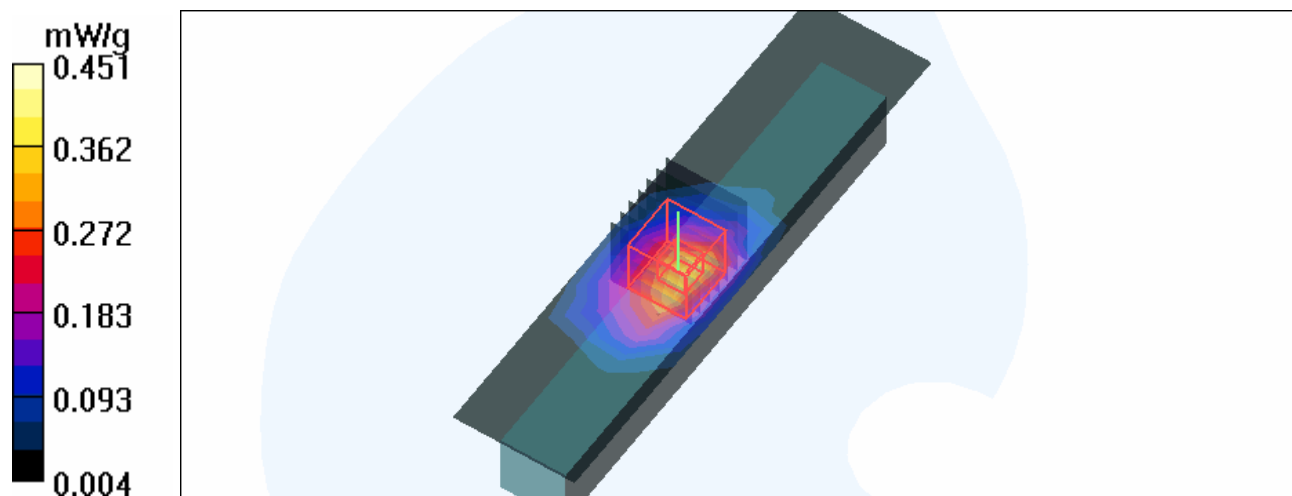

Test Laboratory: Advance Data Technology

### 11N 40M-Ch1-M08

**DUT: 802.11n/g/b Wireless USB Adapter ; Type: WUB-375L ; Test Frequency: 2422 MHz**

Communication System: 802.11n 40MHz ; Frequency: 2422 MHz ; Duty Cycle: 1:1 ; Modulation type: BPSK

Medium: MSL2450 Medium parameters used:  $f = 2422$  MHz;  $\sigma = 1.94$  mho/m;  $\epsilon_r = 53$ ;  $\rho = 1000$  kg/m<sup>3</sup> ; Liquid level : 152 mm

Phantom section: Flat Section ; Separation distance : 4 mm (The edge side of the EUT to the Phantom)

Antenna type : Printed Antenna ; Air temp. : 23.6 degrees ; Liquid temp. : 22.5 degrees

DASY4 Configuration:

- Probe: ET3DV6 - SN1790 ; ConvF(4.16, 4.16, 4.16) ; Calibrated: 2007/11/20
- Sensor-Surface: 4mm (Mechanical Surface Detection)
- Electronics: DAE3 Sn510 ; Calibrated: 2007/8/29
- Phantom: SAM 12 ; Type: SAM V4.0 ; Serial: TP 1202
- Measurement SW: DASY4, V4.7 Build 53 ; Postprocessing SW: SEMCAD, V1.8 Build 172

**Low Channel 1/Area Scan (4x14x1):** Measurement grid: dx=15mm, dy=15mm

Maximum value of SAR (measured) = 0.247 mW/g

**Low Channel 1/Zoom Scan (7x7x7) (7x7x7)/Cube 0:** Measurement grid: dx=5mm, dy=5mm, dz=5mm

Reference Value = 7.23 V/m

Peak SAR (extrapolated) = 0.615 W/kg

**SAR(1 g) = 0.269 mW/g; SAR(10 g) = 0.132 mW/g**

Maximum value of SAR (measured) = 0.296 mW/g

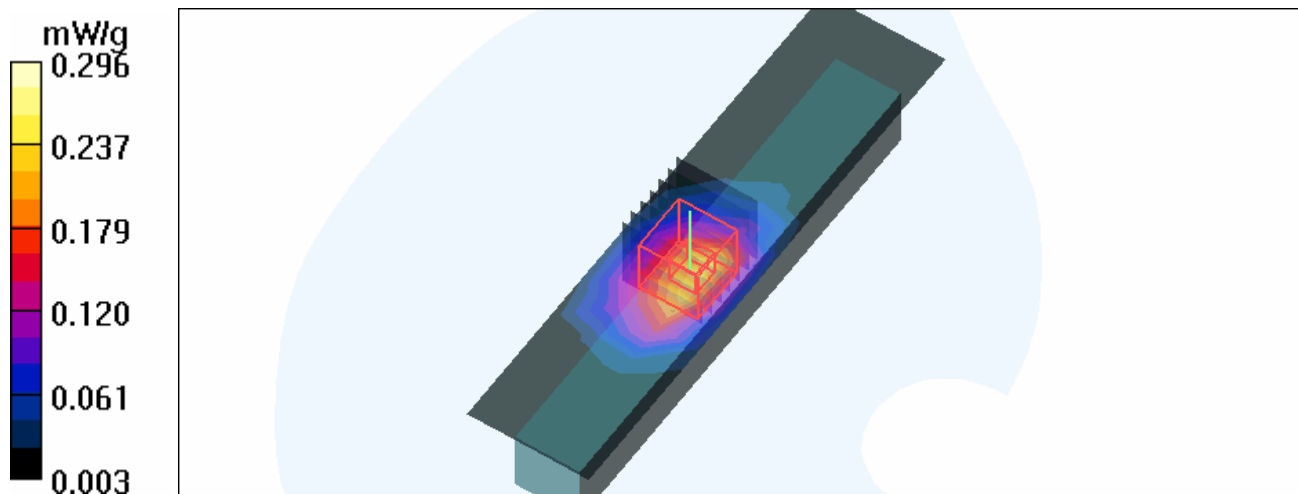

Test Laboratory: Advance Data Technology

## System Validation Check-MSL 2450MHz

**DUT: Dipole 2450 MHz ; Type: D2450V2 ; Serial: 716 ; Test Frequency: 2450 MHz**

Communication System: CW ; Frequency: 2450 MHz; Duty Cycle: 1:1; Modulation type: CW  
 Medium: MSL2450; Medium parameters used:  $f = 2450$  MHz;  $\sigma = 1.97$  mho/m;  $\epsilon_r = 52.9$ ;  $\rho = 1000$  kg/m<sup>3</sup> ; Liquid level : 152 mm

Phantom section: Flat Section ; Separation distance : 10 mm (The feetpoint of the dipole to the Phantom) Air temp. : 23.6 degrees ; Liquid temp. : 22.5 degrees

DASY4 Configuration:

- Probe: ET3DV6 - SN1790 ; ConvF(4.16, 4.16, 4.16) ; Calibrated: 2007/11/20
- Sensor-Surface: 4mm (Mechanical Surface Detection)
- Electronics: DAE3 Sn510; Calibrated: 2007/8/29
- Phantom: SAM 12; Type: SAM V4.0; Serial: TP 1202
- Measurement SW: DASY4, V4.7 Build 53; Postprocessing SW: SEMCAD, V1.8 Build 172

**d=10mm, Pin=250mW/Area Scan (5x7x1):** Measurement grid: dx=15mm, dy=15mm  
 Maximum value of SAR (measured) = 14.1 mW/g

**d=10mm, Pin=250mW/Zoom Scan (7x7x7)/Cube 0:** Measurement grid: dx=5mm, dy=5mm, dz=5mm

Reference Value = 89.5 V/m; Power Drift = -0.105 dB

Peak SAR (extrapolated) = 25.9 W/kg

**SAR(1 g) = 12.2 mW/g; SAR(10 g) = 5.68 mW/g**

Maximum value of SAR (measured) = 13.7 mW/g

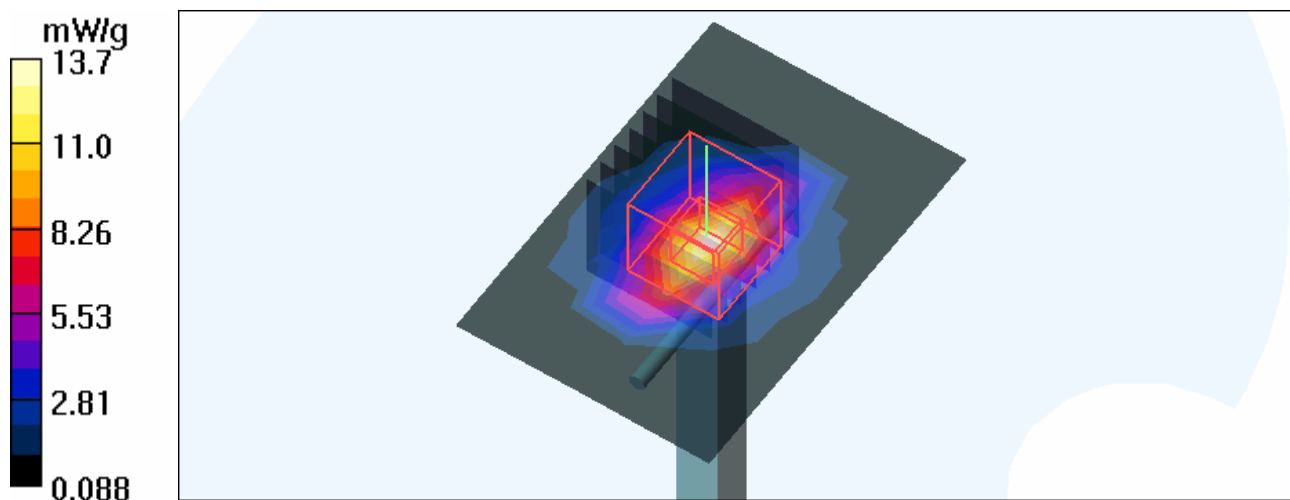

## APPENDIX B: ADT SAR MEASUREMENT SYSTEM



## APPENDIX C: PHOTOGRAPHS OF SYSTEM VALIDATION

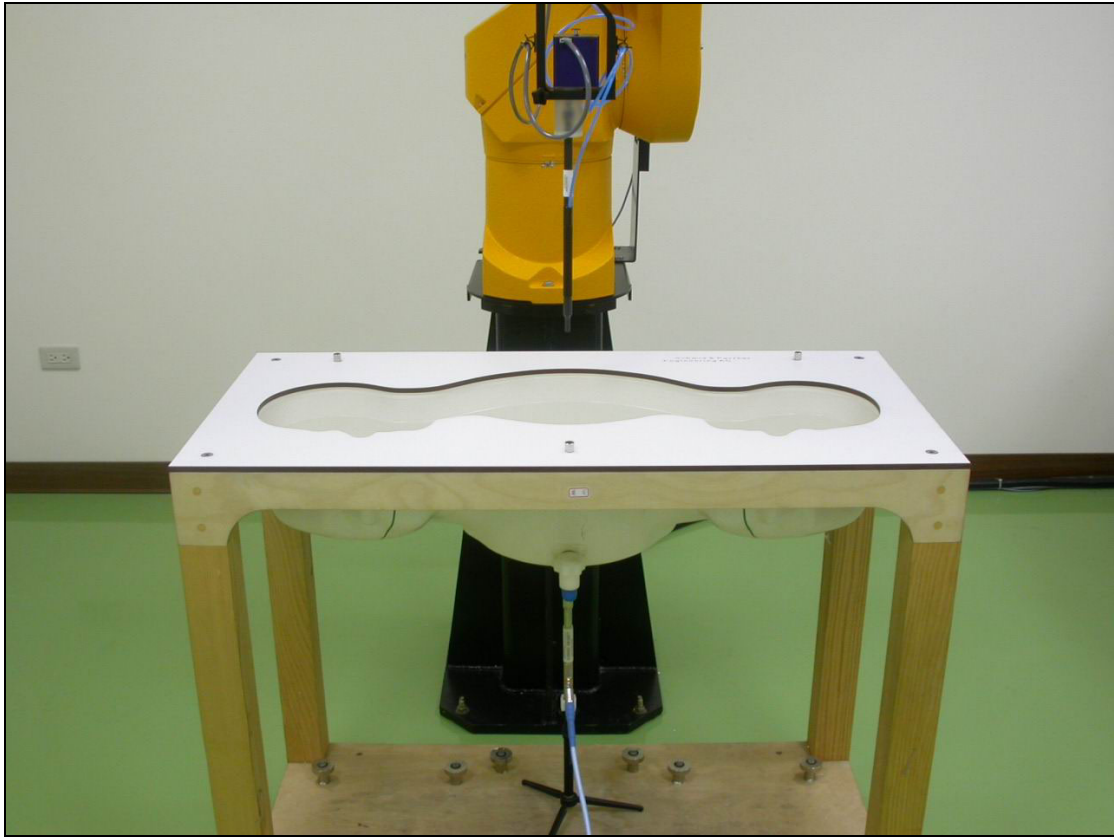



## **APPENDIX D: SYSTEM CERTIFICATE & CALIBRATION**

### **D1: SAM PHANTOM**

# Schmid & Partner Engineering AG

Zeughausstrasse 43, 8004 Zurich, Switzerland, Phone +41 1 245 97 00, Fax +41 1 245 97 79

## Certificate of conformity / First Article Inspection

Item	SAM Twin Phantom V4.0
Type No	QD 000 P40 CA
Series No	TP-1150 and higher
Manufacturer / Origin	Untersee Composites Hauptstr. 69 CH-8559 Fruthwilen Switzerland

### Tests

The series production process used allows the limitation to test of first articles. Complete tests were made on the pre-series Type No. QD 000 P40 AA, Serial No. TP-1001 and on the series first article Type No. QD 000 P40 BA, Serial No. TP-1006. Certain parameters have been retested using further series units (called samples).

Test	Requirement	Details	Units tested
Shape	Compliance with the geometry according to the CAD model.	IT'IS CAD File (*)	First article, Samples
Material thickness	Compliant with the requirements according to the standards	2mm +/- 0.2mm in specific areas	First article, Samples
Material parameters	Dielectric parameters for required frequencies	200 MHz – 3 GHz Relative permittivity < 5 Loss tangent < 0.05.	Material sample TP 104-5
Material resistivity	The material has been tested to be compatible with the liquids defined in the standards	Liquid type HSL 1800 and others according to the standard.	Pre-series, First article

### Standards

- [1] CENELEC EN 50361
- [2] IEEE P1528-200x draft 6.5
- [3] IEC PT 62209 draft 0.9

(\*) The IT'IS CAD file is derived from [2] and is also within the tolerance requirements of the shapes of [1] and [3].

### Conformity

Based on the sample tests above, we certify that this item is in compliance with the uncertainty requirements of SAR measurements specified in standard [1] and draft standards [2] and [3].

Date 28.02.2002

Signature / Stamp

*F. Bombault*

**Schmid & Partner  
Engineering AG**

Zeughausstrasse 43, CH-8004 Zurich  
Tel. +41 1 245 97 00, Fax +41 1 245 97 79

*Johannes Kofler*



## D2: DOSIMETRIC E-FIELD PROBE





Accredited by the Swiss Accreditation Service (SAS)  
The Swiss Accreditation Service is one of the signatories to the EA  
Multilateral Agreement for the recognition of calibration certificates

Accreditation No.: **SCS 108**

Client **ADT (Auden)**

Certificate No. **ET3-1790\_Nov07**

**CALIBRATION CERTIFICATE**

Object **ET3DV6 - SN 1790**

Calibration procedure(s) **QA CAL-01 v6  
Calibration procedure for dosimetric E-field probes**

Calibration date: **November 20, 2007**

Condition of the calibrated item **In Tolerance**

This calibration certificate documents the traceability to national standards, which realize the physical units of measurements (SI).  
The measurements and the uncertainties with confidence probability are given on the following pages and are part of the certificate.

All calibrations have been conducted in the closed laboratory facility: environment temperature (22 ± 3)°C and humidity < 70%.

Calibration Equipment used (M&TE critical for calibration)

Primary Standards	ID #	Cal Date (Calibrated by, Certificate No.)	Scheduled Calibration
Power meter E4419B	GB41293874	29-Mar-07 (METAS, No. 217-00670)	Mar-08
Power sensor E4412A	MY41495277	29-Mar-07 (METAS, No. 217-00670)	Mar-08
Power sensor E4412A	MY41498087	29-Mar-07 (METAS, No. 217-00670)	Mar-08
Reference 3 dB Attenuator	SN: S5054 (3c)	8-Aug-07 (METAS, No. 217-00719)	Aug-08
Reference 20 dB Attenuator	SN: S5086 (20b)	29-Mar-07 (METAS, No. 217-00671)	Mar-08
Reference 30 dB Attenuator	SN: S5129 (30b)	8-Aug-07 (METAS, No. 217-00720)	Aug-08
Reference Probe ES3DV2	SN: 3013	4-Jan-07 (SPEAG, No. ES3-3013_Jan07)	Jan-08
DAE4	SN: 654	20-Apr-07 (SPEAG, No. DAE4-654_Apr07)	Apr-08
Secondary Standards	ID #	Check Date (in house)	Scheduled Check
RF generator HP 8648C	US3642U01700	4-Aug-99 (SPEAG, in house check Oct-07)	In house check: Oct-09
Network Analyzer HP 8753E	US37390585	18-Oct-01 (SPEAG, in house check Oct-07)	In house check: Oct-08

	Name	Function	Signature
Calibrated by:	Katja Pokovic	Technical Manager	
Approved by:	Niels Kusler	Quality Manager	

Issued: November 20, 2007

This calibration certificate shall not be reproduced except in full without written approval of the laboratory.



Accredited by the Swiss Accreditation Service (SAS)  
The Swiss Accreditation Service is one of the signatories to the EA  
Multilateral Agreement for the recognition of calibration certificates

Accreditation No.: **SCS 108**

### Glossary:

TSL	tissue simulating liquid
NORM <sub>x,y,z</sub>	sensitivity in free space
ConvF	sensitivity in TSL / NORM <sub>x,y,z</sub>
DCP	diode compression point
Polarization $\phi$	$\phi$ rotation around probe axis
Polarization $\vartheta$	$\vartheta$ rotation around an axis that is in the plane normal to probe axis (at measurement center), i.e., $\vartheta = 0$ is normal to probe axis

### Calibration is Performed According to the Following Standards:

- IEEE Std 1528-2003, "IEEE Recommended Practice for Determining the Peak Spatial-Averaged Specific Absorption Rate (SAR) in the Human Head from Wireless Communications Devices: Measurement Techniques", December 2003
- IEC 62209-1, "Procedure to measure the Specific Absorption Rate (SAR) for hand-held devices used in close proximity to the ear (frequency range of 300 MHz to 3 GHz)", February 2005

### Methods Applied and Interpretation of Parameters:

- NORM<sub>x,y,z</sub>**: Assessed for E-field polarization  $\vartheta = 0$  ( $f \leq 900$  MHz in TEM-cell;  $f > 1800$  MHz: R22 waveguide). NORM<sub>x,y,z</sub> are only intermediate values, i.e., the uncertainties of NORM<sub>x,y,z</sub> does not effect the  $E^2$ -field uncertainty inside TSL (see below *ConvF*).
- NORM(f)<sub>x,y,z</sub>** = NORM<sub>x,y,z</sub> \* *frequency\_response* (see Frequency Response Chart). This linearization is implemented in DASY4 software versions later than 4.2. The uncertainty of the frequency response is included in the stated uncertainty of *ConvF*.
- DCP<sub>x,y,z</sub>**: DCP are numerical linearization parameters assessed based on the data of power sweep (no uncertainty required). DCP does not depend on frequency nor media.
- ConvF and Boundary Effect Parameters**: Assessed in flat phantom using E-field (or Temperature Transfer Standard for  $f \leq 800$  MHz) and inside waveguide using analytical field distributions based on power measurements for  $f > 800$  MHz. The same setups are used for assessment of the parameters applied for boundary compensation (alpha, depth) of which typical uncertainty values are given. These parameters are used in DASY4 software to improve probe accuracy close to the boundary. The sensitivity in TSL corresponds to NORM<sub>x,y,z</sub> \* *ConvF* whereby the uncertainty corresponds to that given for *ConvF*. A frequency dependent *ConvF* is used in DASY version 4.4 and higher which allows extending the validity from  $\pm 50$  MHz to  $\pm 100$  MHz.
- Spherical isotropy (3D deviation from isotropy)**: in a field of low gradients realized using a flat phantom exposed by a patch antenna.
- Sensor Offset**: The sensor offset corresponds to the offset of virtual measurement center from the probe tip (on probe axis). No tolerance required.

# Probe ET3DV6

## SN:1790

Manufactured:	May 28, 2003
Last calibrated:	November 23, 2006
Recalibrated:	November 20, 2007

Calibrated for DASY Systems

(Note: non-compatible with DASY2 system!)

**DASY - Parameters of Probe: ET3DV6 SN:1790**

Sensitivity in Free Space <sup>A</sup>			Diode Compression <sup>B</sup>	
NormX	2.10 ± 10.1%	$\mu\text{V}/(\text{V}/\text{m})^2$	DCP X	92 mV
NormY	2.11 ± 10.1%	$\mu\text{V}/(\text{V}/\text{m})^2$	DCP Y	92 mV
NormZ	1.77 ± 10.1%	$\mu\text{V}/(\text{V}/\text{m})^2$	DCP Z	92 mV

**Sensitivity in Tissue Simulating Liquid (Conversion Factors)**

Please see Page 8.

**Boundary Effect**

TSL	900 MHz	Typical SAR gradient: 5 % per mm	
	Sensor Center to Phantom Surface Distance	3.7 mm	4.7 mm
	SAR <sub>be</sub> [%] Without Correction Algorithm	6.2	3.3
	SAR <sub>be</sub> [%] With Correction Algorithm	0.8	0.5

TSL	1750 MHz	Typical SAR gradient: 10 % per mm	
	Sensor Center to Phantom Surface Distance	3.7 mm	4.7 mm
	SAR <sub>be</sub> [%] Without Correction Algorithm	12.2	8.1
	SAR <sub>be</sub> [%] With Correction Algorithm	0.9	0.0

**Sensor Offset**

Probe Tip to Sensor Center	2.7 mm
----------------------------	--------

**The reported uncertainty of measurement is stated as the standard uncertainty of measurement multiplied by the coverage factor k=2, which for a normal distribution corresponds to a coverage probability of approximately 95%.**

<sup>A</sup> The uncertainties of NormX,Y,Z do not affect the E<sup>2</sup>-field uncertainty inside TSL (see Page 8).

<sup>B</sup> Numerical linearization parameter: uncertainty not required.

# Frequency Response of E-Field

(TEM-Cell:ifi110 EXX, Waveguide: R22)

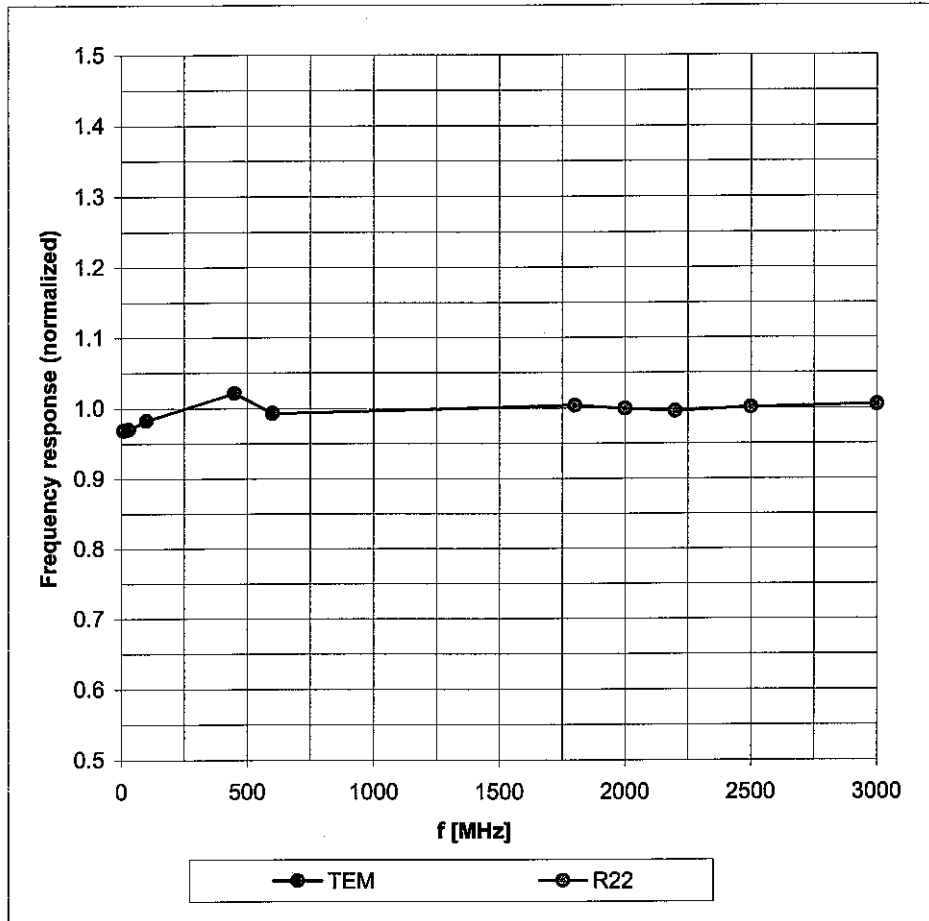

Uncertainty of Frequency Response of E-field:  $\pm 6.3\%$  (k=2)

### Receiving Pattern ( $\phi$ ), $\vartheta = 0^\circ$

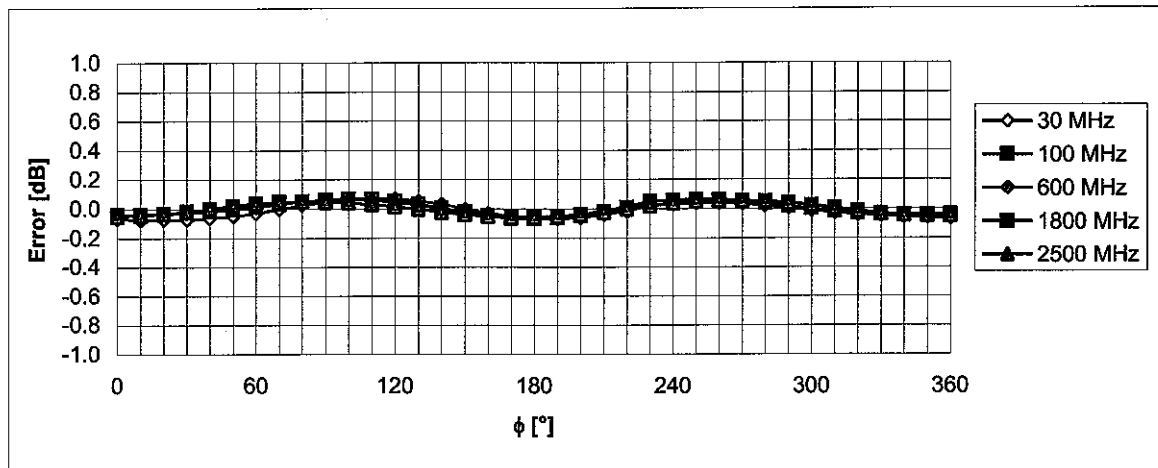
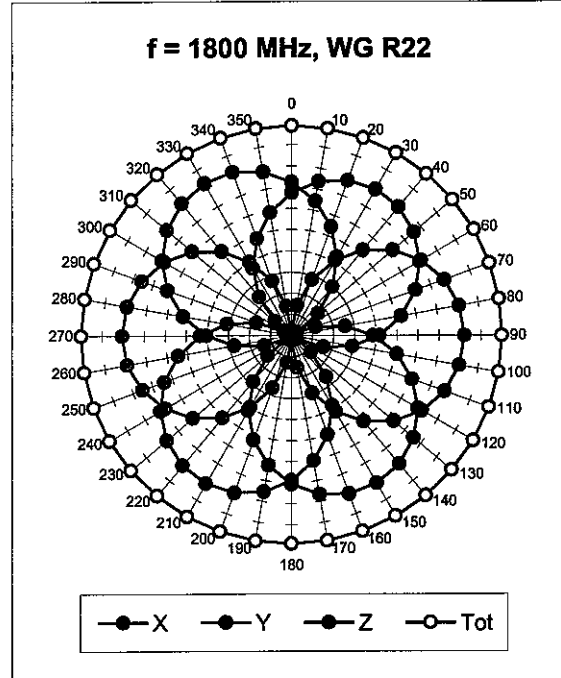
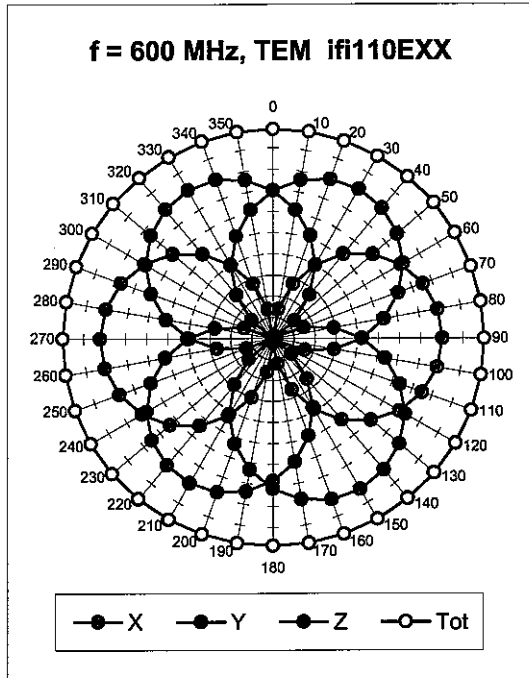

Uncertainty of Axial Isotropy Assessment:  $\pm 0.5\%$  ( $k=2$ )

### Dynamic Range f(SAR<sub>head</sub>) (Waveguide R22, f = 1800 MHz)

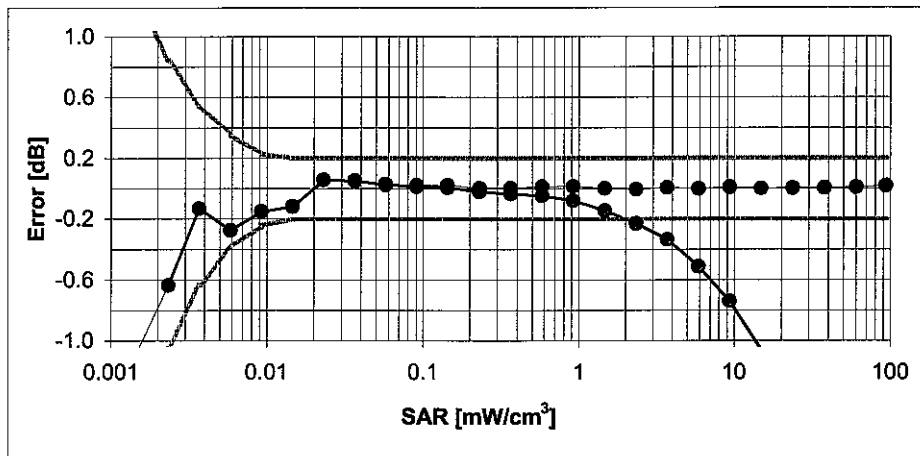
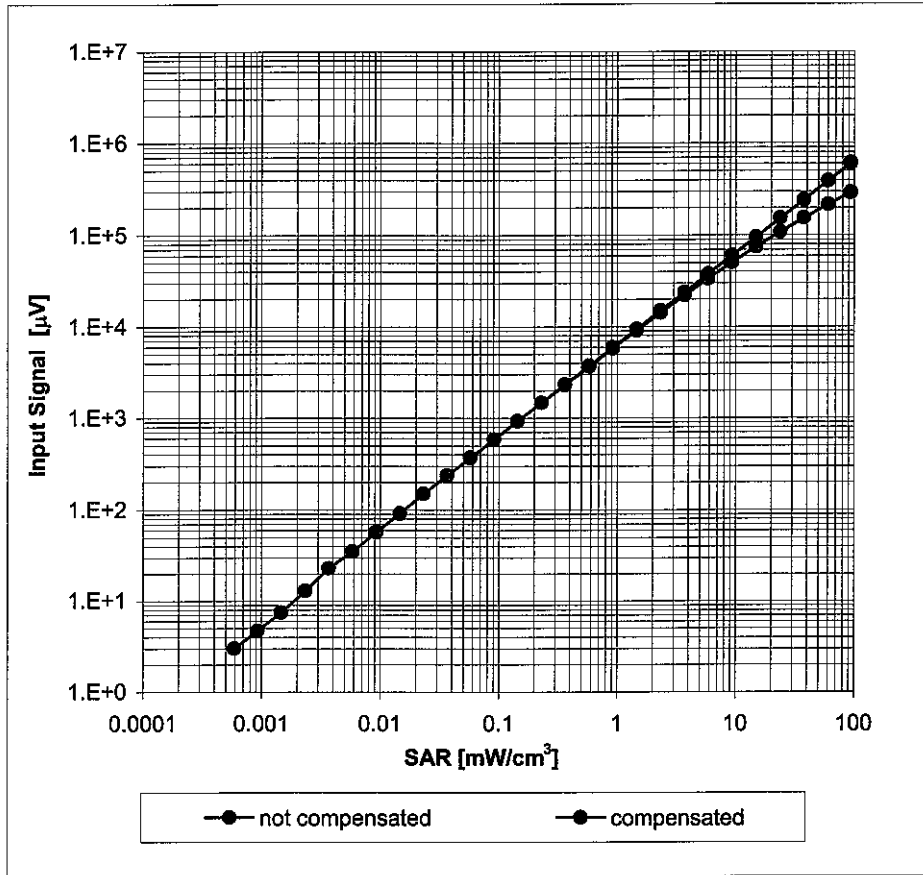

Uncertainty of Linearity Assessment:  $\pm 0.6\%$  (k=2)

## Conversion Factor Assessment

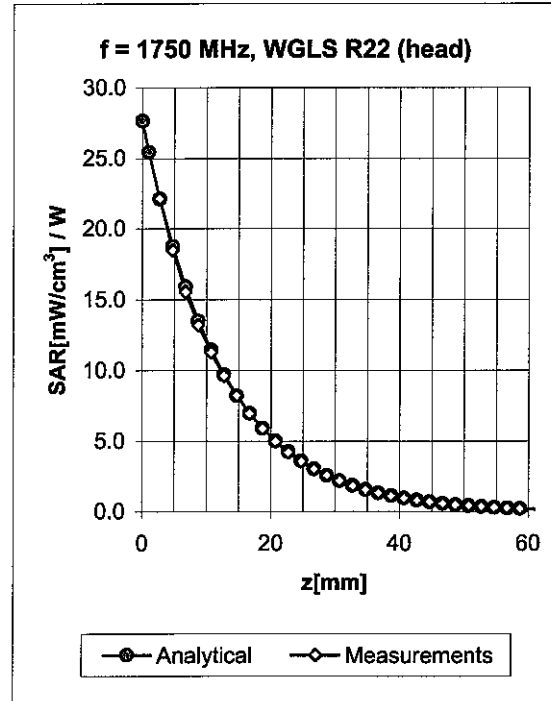
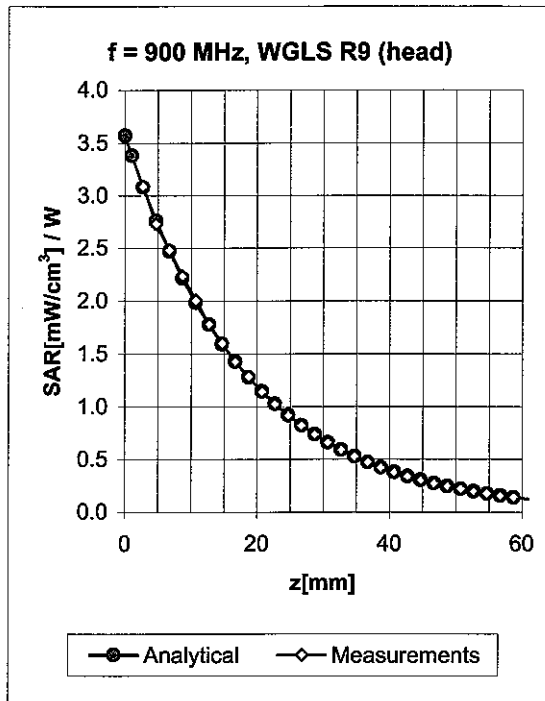

f [MHz]	Validity [MHz] <sup>c</sup>	TSL	Permittivity	Conductivity	Alpha	Depth	ConvF Uncertainty
900	± 50 / ± 100	Head	41.5 ± 5%	0.97 ± 5%	0.59	2.17	6.65 ± 11.0% (k=2)
1750	± 50 / ± 100	Head	40.1 ± 5%	1.37 ± 5%	0.59	2.28	5.42 ± 11.0% (k=2)
1950	± 50 / ± 100	Head	40.0 ± 5%	1.40 ± 5%	0.63	2.14	5.10 ± 11.0% (k=2)
2450	± 50 / ± 100	Head	39.2 ± 5%	1.80 ± 5%	0.74	1.94	4.74 ± 11.8% (k=2)
900	± 50 / ± 100	Body	55.0 ± 5%	1.05 ± 5%	0.67	2.06	6.15 ± 11.0% (k=2)
1750	± 50 / ± 100	Body	53.4 ± 5%	1.49 ± 5%	0.57	2.54	4.98 ± 11.0% (k=2)
1950	± 50 / ± 100	Body	53.3 ± 5%	1.52 ± 5%	0.60	2.49	4.58 ± 11.0% (k=2)
2450	± 50 / ± 100	Body	52.7 ± 5%	1.95 ± 5%	0.66	2.27	4.16 ± 11.8% (k=2)

<sup>c</sup> The validity of ± 100 MHz only applies for DASY v4.4 and higher (see Page 2). The uncertainty is the RSS of the ConvF uncertainty at calibration frequency and the uncertainty for the indicated frequency band.



# Deviation from Isotropy in HSL

Error ( $\phi$ ,  $\vartheta$ ),  $f = 900$  MHz

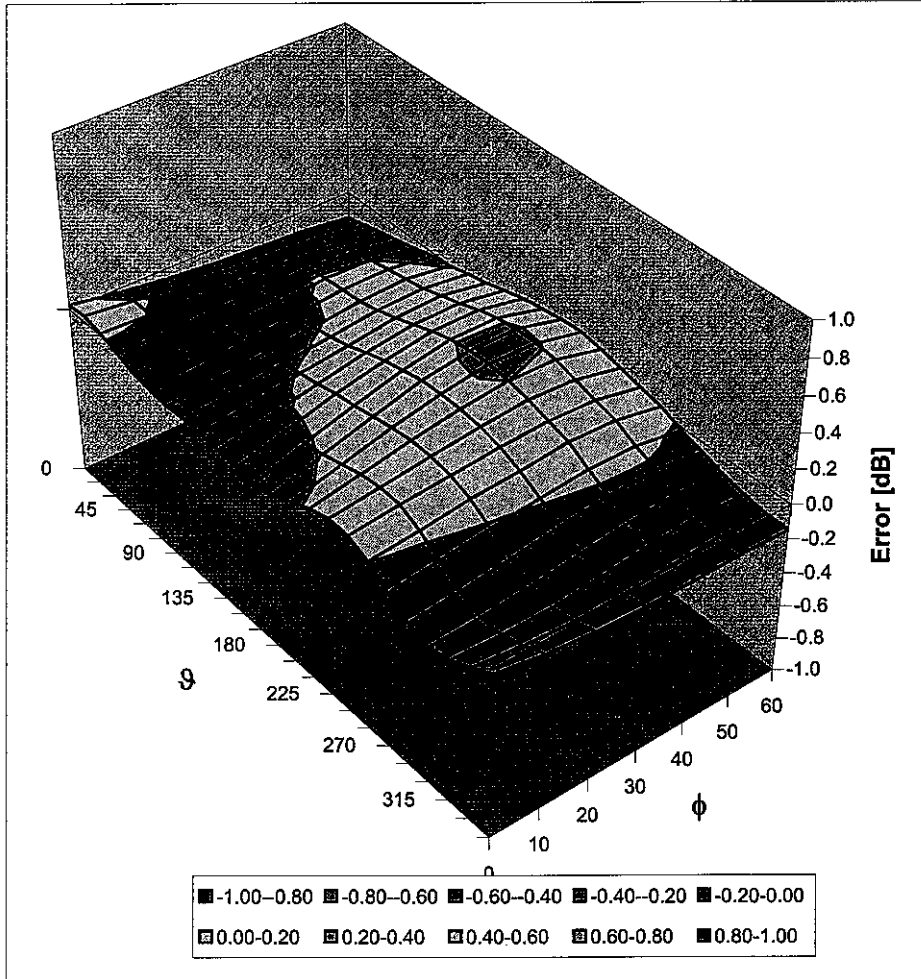

Uncertainty of Spherical Isotropy Assessment:  $\pm 2.6\%$  ( $k=2$ )



**D3: DAE**



Accredited by the Swiss Federal Office of Metrology and Accreditation  
The Swiss Accreditation Service is one of the signatories to the EA  
Multilateral Agreement for the recognition of calibration certificates

Accreditation No.: **SCS 108**

Client **ADT (Auden)**

Certificate No: **DAE3-510\_Aug07**

## CALIBRATION CERTIFICATE

Object **DAE3 - SD.000 D03 AA - SN: 510**

Calibration procedure(s) **QA CAL-06 v12  
Calibration procedure for the data acquisition electronics (DAE)**

Calibration date: **August 29, 2007**

Condition of the calibrated item **In Tolerance**

This calibration certificate documents the traceability to national standards, which realize the physical units of measurements (SI).  
The measurements and the uncertainties with confidence probability are given on the following pages and are part of the certificate.

All calibrations have been conducted in the closed laboratory facility: environment temperature ( $22 \pm 3$ )°C and humidity < 70%.

Calibration Equipment used (M&TE critical for calibration)

Primary Standards	ID #	Cal Date (Calibrated by, Certificate No.)	Scheduled Calibration
Fluke Process Calibrator Type 702	SN: 6295803	13-Oct-06 (Elcal AG, No: 5492)	Oct-07
Keithley Multimeter Type 2001	SN: 0810278	03-Oct-06 (Elcal AG, No: 5478)	Oct-07
Secondary Standards	ID #	Check Date (in house)	Scheduled Check
Calibrator Box V1.1	SE UMS 006 AB 1004	25-Jun-07 (SPEAG, in house check)	In house check Jun-08

Calibrated by: **Name** Dominique Steffen **Function** Technician **Signature**

Approved by: **Name** Fin Bornholt **Function** R&D Director **Signature**

Issued: August 29, 2007

This calibration certificate shall not be reproduced except in full without written approval of the laboratory.



## Glossary

DAE	data acquisition electronics
Connector angle	information used in DASY system to align probe sensor X to the robot coordinate system.

## Methods Applied and Interpretation of Parameters

- *DC Voltage Measurement:* Calibration Factor assessed for use in DASY system by comparison with a calibrated instrument traceable to national standards. The figure given corresponds to the full scale range of the voltmeter in the respective range.
- *Connector angle:* The angle of the connector is assessed measuring the angle mechanically by a tool inserted. Uncertainty is not required.
- The following parameters contain technical information as a result from the performance test and require no uncertainty.
- *DC Voltage Measurement Linearity:* Verification of the Linearity at +10% and -10% of the nominal calibration voltage. Influence of offset voltage is included in this measurement.
- *Common mode sensitivity:* Influence of a positive or negative common mode voltage on the differential measurement.
- *Channel separation:* Influence of a voltage on the neighbor channels not subject to an input voltage.
- *AD Converter Values with inputs shorted:* Values on the internal AD converter corresponding to zero input voltage
- *Input Offset Measurement:* Output voltage and statistical results over a large number of zero voltage measurements.
- *Input Offset Current:* Typical value for information; Maximum channel input offset current, not considering the input resistance.
- *Input resistance:* DAE input resistance at the connector, during internal auto-zeroing and during measurement.
- *Low Battery Alarm Voltage:* Typical value for information. Below this voltage, a battery alarm signal is generated.
- *Power consumption:* Typical value for information. Supply currents in various operating modes.

## DC Voltage Measurement

A/D - Converter Resolution nominal

High Range: 1LSB = 6.1 $\mu$ V, full range = -100...+300 mV

Low Range: 1LSB = 61nV, full range = -1.....+3mV

DASY measurement parameters: Auto Zero Time: 3 sec; Measuring time: 3 sec

Calibration Factors	X	Y	Z
High Range	404.150 $\pm$ 0.1% (k=2)	404.218 $\pm$ 0.1% (k=2)	404.585 $\pm$ 0.1% (k=2)
Low Range	3.98817 $\pm$ 0.7% (k=2)	3.97339 $\pm$ 0.7% (k=2)	3.96897 $\pm$ 0.7% (k=2)

## Connector Angle

Connector Angle to be used in DASY system	42 $^{\circ}$ $\pm$ 1 $^{\circ}$
-------------------------------------------	----------------------------------

## Appendix

### 1. DC Voltage Linearity

High Range	Input ( $\mu\text{V}$ )	Reading ( $\mu\text{V}$ )	Error (%)
Channel X + Input	200000	200000.7	0.00
Channel X + Input	20000	20006.63	0.03
Channel X - Input	20000	-19999.14	0.00
Channel Y + Input	200000	199999.5	0.00
Channel Y + Input	20000	20005.23	0.03
Channel Y - Input	20000	-20002.04	0.01
Channel Z + Input	200000	199999.6	0.00
Channel Z + Input	20000	20006.53	0.03
Channel Z - Input	20000	-20001.38	0.01

Low Range	Input ( $\mu\text{V}$ )	Reading ( $\mu\text{V}$ )	Error (%)
Channel X + Input	2000	2000	0.00
Channel X + Input	200	199.97	-0.01
Channel X - Input	200	-199.90	-0.05
Channel Y + Input	2000	2000.1	0.00
Channel Y + Input	200	199.64	-0.18
Channel Y - Input	200	-200.58	0.29
Channel Z + Input	2000	2000	0.00
Channel Z + Input	200	199.20	-0.40
Channel Z - Input	200	-200.81	0.41

### 2. Common mode sensitivity

DASY measurement parameters: Auto Zero Time: 3 sec; Measuring time: 3 sec

	Common mode Input Voltage (mV)	High Range Average Reading ( $\mu\text{V}$ )	Low Range Average Reading ( $\mu\text{V}$ )
Channel X	200	17.82	16.82
	- 200	-16.18	-16.83
Channel Y	200	14.68	14.20
	- 200	-15.70	-16.05
Channel Z	200	-8.25	-8.73
	- 200	8.01	8.08

### 3. Channel separation

DASY measurement parameters: Auto Zero Time: 3 sec; Measuring time: 3 sec

	Input Voltage (mV)	Channel X ( $\mu\text{V}$ )	Channel Y ( $\mu\text{V}$ )	Channel Z ( $\mu\text{V}$ )
Channel X	200	-	0.75	1.74
Channel Y	200	2.34	-	2.77
Channel Z	200	-1.43	0.25	-

#### 4. AD-Converter Values with inputs shorted

DASY measurement parameters: Auto Zero Time: 3 sec; Measuring time: 3 sec

	High Range (LSB)	Low Range (LSB)
Channel X	15893	16120
Channel Y	16114	16051
Channel Z	16081	16196

#### 5. Input Offset Measurement

DASY measurement parameters: Auto Zero Time: 3 sec; Measuring time: 3 sec

Input 10M $\Omega$

	Average ( $\mu$ V)	min. Offset ( $\mu$ V)	max. Offset ( $\mu$ V)	Std. Deviation ( $\mu$ V)
Channel X	-0.67	-1.71	-0.06	0.26
Channel Y	-1.04	-3.37	0.35	0.34
Channel Z	-1.26	-3.29	0.15	0.35

#### 6. Input Offset Current

Nominal Input circuitry offset current on all channels: <25fA

#### 7. Input Resistance

	Zeroing (MOhm)	Measuring (MOhm)
Channel X	0.2001	198.5
Channel Y	0.2001	199.2
Channel Z	0.2000	200.3

#### 8. Low Battery Alarm Voltage (verified during pre test)

Typical values	Alarm Level (VDC)
Supply (+ Vcc)	+7.9
Supply (- Vcc)	-7.6

#### 9. Power Consumption (verified during pre test)

Typical values	Switched off (mA)	Stand by (mA)	Transmitting (mA)
Supply (+ Vcc)	+0.0	+6	+14
Supply (- Vcc)	-0.01	-8	-9



## D4: SYSTEM VALIDATION DIPOLE





Accredited by the Swiss Federal Office of Metrology and Accreditation  
The Swiss Accreditation Service is one of the signatories to the EA  
Multilateral Agreement for the recognition of calibration certificates

Accreditation No.: **SCS 108**

Client **ADT (Auden)**

Certificate No: **D2450V2-716\_Aug07**

## CALIBRATION CERTIFICATE

Object **D2450V2 - SN: 716**

Calibration procedure(s) **QA CAL-05.v6  
Calibration procedure for dipole validation kits**

Calibration date: **August 20, 2007**

Condition of the calibrated item **In Tolerance**

This calibration certificate documents the traceability to national standards, which realize the physical units of measurements (SI).  
The measurements and the uncertainties with confidence probability are given on the following pages and are part of the certificate.

All calibrations have been conducted in the closed laboratory facility: environment temperature ( $22 \pm 3$ )°C and humidity < 70%.

Calibration Equipment used (M&TE critical for calibration)

Primary Standards	ID #	Cal Date (Calibrated by, Certificate No.)	Scheduled Calibration
Power meter EPM-442A	GB37480704	03-Oct-06 (METAS, No. 217-00608)	Oct-07
Power sensor HP 8481A	US37292783	03-Oct-06 (METAS, No. 217-00608)	Oct-07
Reference 20 dB Attenuator	SN: 5086 (20g)	07-Aug-07 (METAS, No 217-00718)	Aug-08
Reference 10 dB Attenuator	SN: 5047.2 (10r)	07-Aug-07 (METAS, No 217-00718)	Aug-08
Reference Probe ES3DV3	SN 3025	19-Oct-06 (SPEAG, No. ES3-3025_Oct06)	Oct-07
DAE4	SN 601	30-Jan-07 (SPEAG, No. DAE4-601_Jan07)	Jan-08

Secondary Standards	ID #	Check Date (in house)	Scheduled Check
Power sensor HP 8481A	MY41092317	18-Oct-02 (SPEAG, in house check Oct-05)	In house check: Oct-07
RF generator Agilent E4421B	MY41000675	11-May-05 (SPEAG, in house check Nov-05)	In house check: Nov-07
Network Analyzer HP 8753E	US37390585 S4206	18-Oct-01 (SPEAG, in house check Oct-06)	In house check: Oct-07

Calibrated by: **Name: Mike Meili, Function: Laboratory Technician, Signature: [Handwritten Signature]**

Approved by: **Katja Pokovic, Technical Manager, Signature: [Handwritten Signature]**

Issued: August 21, 2007

This calibration certificate shall not be reproduced except in full without written approval of the laboratory.



Accredited by the Swiss Federal Office of Metrology and Accreditation  
The Swiss Accreditation Service is one of the signatories to the EA  
Multilateral Agreement for the recognition of calibration certificates

Accreditation No.: **SCS 108**

### Glossary:

TSL	tissue simulating liquid
ConvF	sensitivity in TSL / NORM x,y,z
N/A	not applicable or not measured

### Calibration is Performed According to the Following Standards:

- IEEE Std 1528-2003, "IEEE Recommended Practice for Determining the Peak Spatial-Averaged Specific Absorption Rate (SAR) in the Human Head from Wireless Communications Devices: Measurement Techniques", December 2003
- IEC 62209-1, "Procedure to measure the Specific Absorption Rate (SAR) for hand-held devices used in close proximity to the ear (frequency range of 300 MHz to 3 GHz)", February 2005
- Federal Communications Commission Office of Engineering & Technology (FCC OET), "Evaluating Compliance with FCC Guidelines for Human Exposure to Radiofrequency Electromagnetic Fields; Additional Information for Evaluating Compliance of Mobile and Portable Devices with FCC Limits for Human Exposure to Radiofrequency Emissions", Supplement C (Edition 01-01) to Bulletin 65

### Additional Documentation:

- DASY4 System Handbook

### Methods Applied and Interpretation of Parameters:

- Measurement Conditions:** Further details are available from the Validation Report at the end of the certificate. All figures stated in the certificate are valid at the frequency indicated.
- Antenna Parameters with TSL:** The dipole is mounted with the spacer to position its feed point exactly below the center marking of the flat phantom section, with the arms oriented parallel to the body axis.
- Feed Point Impedance and Return Loss:** These parameters are measured with the dipole positioned under the liquid filled phantom. The impedance stated is transformed from the measurement at the SMA connector to the feed point. The Return Loss ensures low reflected power. No uncertainty required.
- Electrical Delay:** One-way delay between the SMA connector and the antenna feed point. No uncertainty required.
- SAR measured:** SAR measured at the stated antenna input power.
- SAR normalized:** SAR as measured, normalized to an input power of 1 W at the antenna connector.
- SAR for nominal TSL parameters:** The measured TSL parameters are used to calculate the nominal SAR result.

## Measurement Conditions

DASY system configuration, as far as not given on page 1.

DASY Version	DASY4	V4.7
Extrapolation	Advanced Extrapolation	
Phantom	Modular Flat Phantom V5.0	
Distance Dipole Center - TSL	10 mm	with Spacer
Zoom Scan Resolution	dx, dy, dz = 5 mm	
Frequency	2450 MHz $\pm$ 1 MHz	

## Head TSL parameters

The following parameters and calculations were applied.

	Temperature	Permittivity	Conductivity
Nominal Head TSL parameters	22.0 °C	39.2	1.80 mho/m
Measured Head TSL parameters	(22.0 $\pm$ 0.2) °C	38.7 $\pm$ 6 %	1.81 mho/m $\pm$ 6 %
Head TSL temperature during test	(22.3 $\pm$ 0.2) °C	-----	-----

## SAR result with Head TSL

SAR averaged over 1 cm <sup>3</sup> (1 g) of Head TSL	condition	
SAR measured	250 mW input power	13.2 mW / g
SAR normalized	normalized to 1W	52.8 mW / g
SAR for nominal Head TSL parameters <sup>1</sup>	normalized to 1W	<b>52.4 mW / g <math>\pm</math> 17.0 % (k=2)</b>

SAR averaged over 10 cm <sup>3</sup> (10 g) of Head TSL	condition	
SAR measured	250 mW input power	6.14 mW / g
SAR normalized	normalized to 1W	24.6 mW / g
SAR for nominal Head TSL parameters <sup>1</sup>	normalized to 1W	<b>24.4 mW / g <math>\pm</math> 16.5 % (k=2)</b>

<sup>1</sup> Correction to nominal TSL parameters according to d), chapter "SAR Sensitivities"

## Body TSL parameters

The following parameters and calculations were applied.

	Temperature	Permittivity	Conductivity
Nominal Body TSL parameters	22.0 °C	52.7	1.95 mho/m
Measured Body TSL parameters	(22.0 ± 0.2) °C	53.9 ± 6 %	1.97 mho/m ± 6 %
Body TSL temperature during test	(21.5 ± 0.2) °C	----	----

## SAR result with Body TSL

SAR averaged over 1 cm <sup>3</sup> (1 g) of Body TSL	Condition	
SAR measured	250 mW input power	13.1 mW / g
SAR normalized	normalized to 1W	52.4 mW / g
SAR for nominal Body TSL parameters <sup>2</sup>	normalized to 1W	<b>52.8 mW / g ± 17.0 % (k=2)</b>

SAR averaged over 10 cm <sup>3</sup> (10 g) of Body TSL	Condition	
SAR measured	250 mW input power	6.09 mW / g
SAR normalized	normalized to 1W	24.4 mW / g
SAR for nominal Body TSL parameters <sup>2</sup>	normalized to 1W	<b>24.5 mW / g ± 16.5 % (k=2)</b>

<sup>2</sup> Correction to nominal TSL parameters according to d), chapter "SAR Sensitivities"

## Appendix

### Antenna Parameters with Head TSL

Impedance, transformed to feed point	$54.2 \Omega + 2.1 j\Omega$
Return Loss	- 26.9 dB

### Antenna Parameters with Body TSL

Impedance, transformed to feed point	$49.5 \Omega + 3.6 j\Omega$
Return Loss	- 28.7 dB

### General Antenna Parameters and Design

Electrical Delay (one direction)	1.147 ns
----------------------------------	----------

After long term use with 100W radiated power, only a slight warming of the dipole near the feedpoint can be measured.

The dipole is made of standard semirigid coaxial cable. The center conductor of the feeding line is directly connected to the second arm of the dipole. The antenna is therefore short-circuited for DC-signals.

No excessive force must be applied to the dipole arms, because they might bend or the soldered connections near the feedpoint may be damaged.

### Additional EUT Data

Manufactured by	SPEAG
Manufactured on	September 10, 2002

## DASY4 Validation Report for Head TSL

Date/Time: 20.08.2007 13:03:38

Test Laboratory: SPEAG, Zurich, Switzerland

**DUT: Dipole 2450 MHz; Type: D2450V2; Serial: D2450V2 - SN716**

Communication System: CW-2450; Frequency: 2450 MHz; Duty Cycle: 1:1

Medium: HSL U10 BB;

Medium parameters used:  $f = 2450$  MHz;  $\sigma = 1.81$  mho/m;  $\epsilon_r = 38.7$ ;  $\rho = 1000$  kg/m<sup>3</sup>

Phantom section: Flat Section

Measurement Standard: DASY4 (High Precision Assessment)

### DASY4 Configuration:

- Probe: ES3DV2 - SN3025 (HF); ConvF(4.5, 4.5, 4.5); Calibrated: 19.10.2006
- Sensor-Surface: 4mm (Mechanical Surface Detection)
- Electronics: DAE4 Sn601; Calibrated: 30.01.2007
- Phantom: Flat Phantom 5.0 (front); Type: QD000P50AA
- Measurement SW: DASY4, V4.7 Build 53; Postprocessing SW: SEMCAD, V1.8 Build 172

**Pin = 250 mW; d = 10 mm/Zoom Scan (7x7x7)/Cube 0:**

Measurement grid: dx=5mm, dy=5mm, dz=5mm

Reference Value = 90.6 V/m; Power Drift = 0.032 dB

Peak SAR (extrapolated) = 27.5 W/kg

**SAR(1 g) = 13.2 mW/g; SAR(10 g) = 6.14 mW/g**

Maximum value of SAR (measured) = 14.3 mW/g

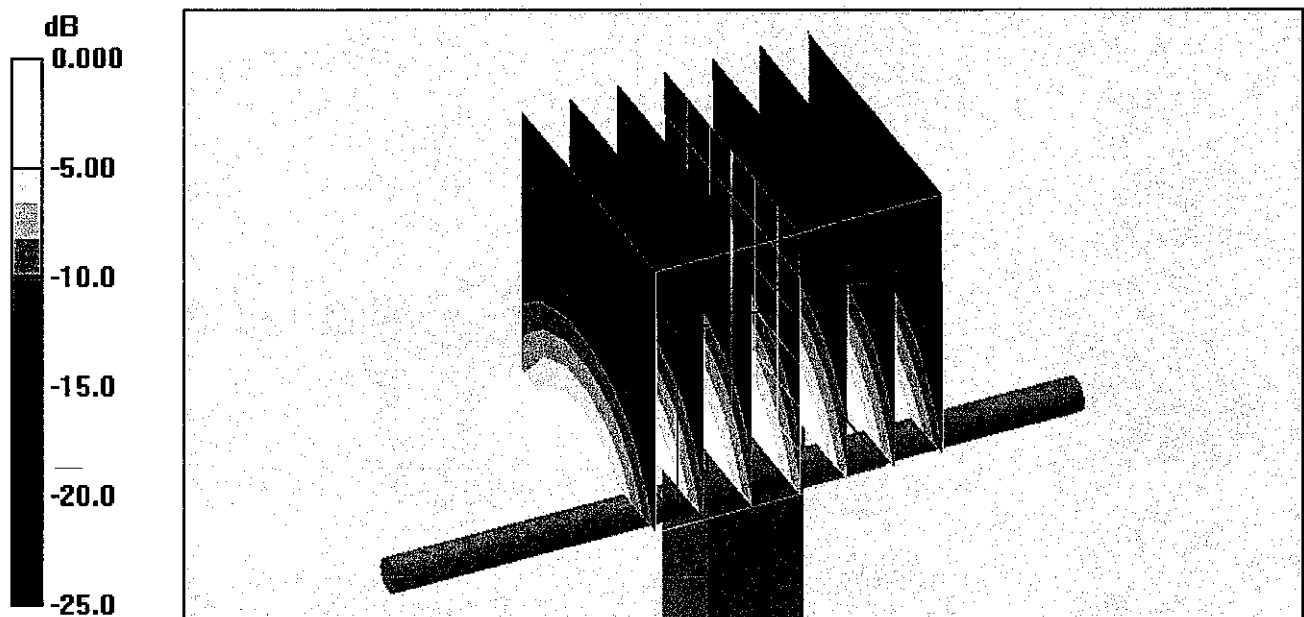

0 dB = 14.3mW/g

# Impedance Measurement Plot for Head TSL

20 Aug 2007 11:53:21

CH1 S11 1 U FS 1: 54.225  $\Omega$  2.1055  $\Omega$  136.77  $\mu\text{H}$  2 450.000 000 MHz

\*  
Del  
Cor

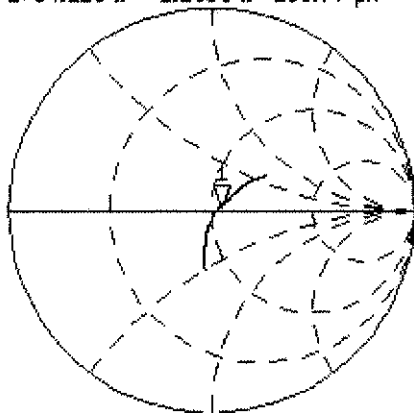

Avg  
16

CH2 S11 LOG 5 dB/REF -20 dB 1: -26.879 dB 2 450.000 000 MHz

Cor

Avg  
16

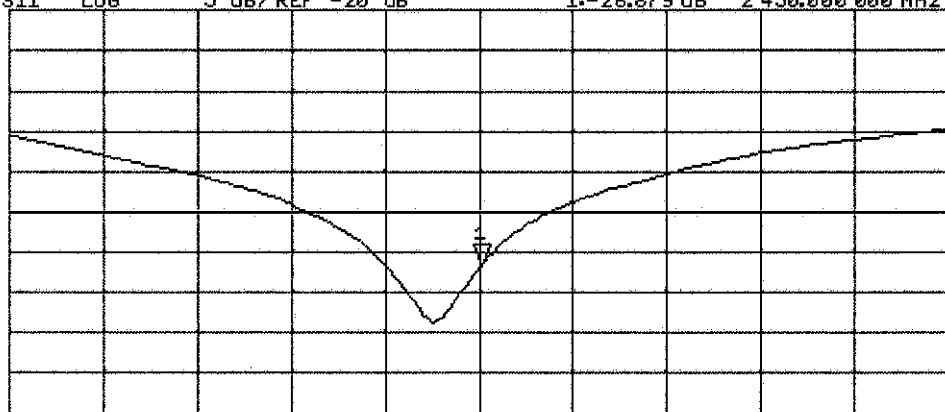

START 2 250.000 000 MHz

STOP 2 650.000 000 MHz

## DASY4 Validation Report for Body TSL

Date/Time: 20.08.2007 14:23:38

Test Laboratory: SPEAG, Zurich, Switzerland

**DUT: Dipole 2450 MHz; Type: D2450V2; Serial: D2450V2 - SN716**

Communication System: CW-2450; Frequency: 2450 MHz; Duty Cycle: 1:1

Medium: MSL U10 BB;

Medium parameters used:  $f = 2450$  MHz;  $\sigma = 1.98$  mho/m;  $\epsilon_r = 54$ ;  $\rho = 1000$  kg/m<sup>3</sup>

Phantom section: Flat Section

Measurement Standard: DASY4 (High Precision Assessment)

DASY4 Configuration:

- Probe: ES3DV2 - SN3025 (HF); ConvF(4.16, 4.16, 4.16); Calibrated: 19.10.2006
- Sensor-Surface: 4mm (Mechanical Surface Detection)
- Electronics: DAE4 Sn601; Calibrated: 30.01.2007
- Phantom: Flat Phantom 5.0 (back); Type: QD000P50AA
- Measurement SW: DASY4, V4.7 Build 53; Postprocessing SW: SEMCAD, V1.8 Build 172

**Pin = 250 mW; d = 10 mm/Zoom Scan (7x7x7)/Cube 0:**

Measurement grid: dx=5mm, dy=5mm, dz=5mm

Reference Value = 87.6 V/m; Power Drift = 0.014 dB

Peak SAR (extrapolated) = 27.0 W/kg

**SAR(1 g) = 13.1 mW/g; SAR(10 g) = 6.09 mW/g**

Maximum value of SAR (measured) = 14.9 mW/g

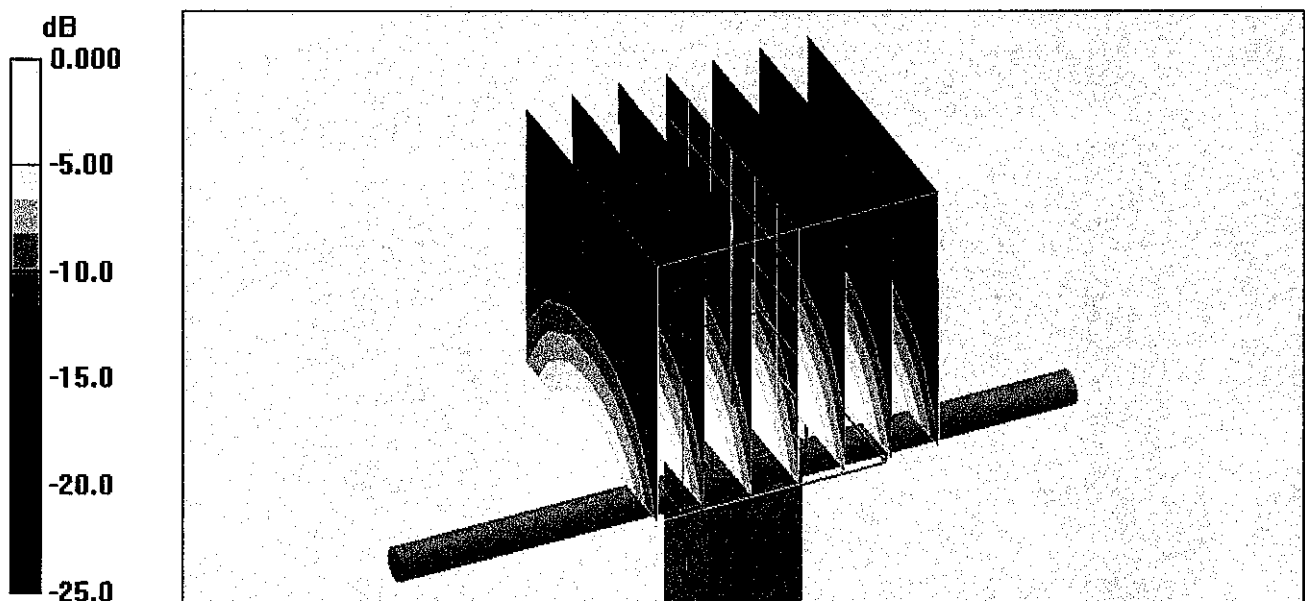

0 dB = 14.9mW/g



# Impedance Measurement Plot for Body TSL

20 Aug 2007 11:53:48

CH1 S11 1 U FS 1: 49.539  $\Omega$  3.6348  $\Omega$  236.12 pF 2 450.000 000 MHz

\*  
De1  
Cor

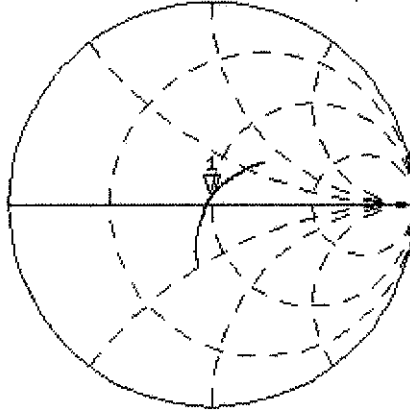

Avg  
16  
↑

CH2 S11 LOG 5 dB/REF -20 dB 1:-28.684 dB 2 450.000 000 MHz

Cor

Avg  
16  
↑

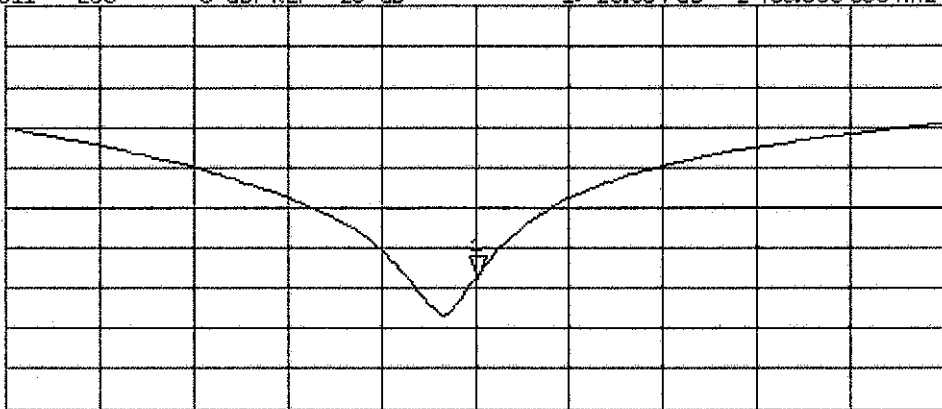

START 2 250.000 000 MHz

STOP 2 650.000 000 MHz