

FCC TEST REPORT

REPORT NO.: RF950720L03

MODEL NO.: WPC-370A

RECEIVED: Jul. 20, 2006

TESTED: Jul. 21 ~ Jul. 26, 2006

ISSUED: Jul. 27, 2006

APPLICANT: U-MEDIA Communications, Inc.

ADDRESS: 9F, No. 1, Jin-shan 7th St., Hsinchu 300, Taiwan,
R.O.C.

ISSUED BY: Advance Data Technology Corporation

LAB ADDRESS: 47 14th Lin, Chiapau Tsun, Linko, Taipei, Taiwan,
R.O.C.

TEST LOCATION: No. 19, Hwa Ya 2nd Rd., Kueishan, Taoyuan,
Taiwan, R.O.C.

This test report consists of 114 pages in total. It may be duplicated completely for legal use with the approval of the applicant. It should not be reproduced except in full, without the written approval of our laboratory. The client should not use it to claim product endorsement by CNLA, A2LA or any government agencies. The test results in the report only apply to the tested sample.





TABLE OF CONTENTS

1.	CERTIFICATION.....	4
2.	SUMMARY OF TEST RESULTS	5
2.1	MEASUREMENT UNCERTAINTY	5
3.	GENERAL INFORMATION	6
3.1	GENERAL DESCRIPTION OF EUT	6
3.2	DESCRIPTION OF TEST MODES	7
3.2.1	CONFIGURATION OF SYSTEM UNDER TEST	7
3.2.2	TEST MODE APPLICABILITY AND TESTED CHANNEL DETAIL	8
3.3	GENERAL DESCRIPTION OF APPLIED STANDARDS	10
3.4	DESCRIPTION OF SUPPORT UNITS.....	10
4.	TEST TYPES AND RESULTS	11
4.1	CONDUCTED EMISSION MEASUREMENT	11
4.1.1	LIMITS OF CONDUCTED EMISSION MEASUREMENT	11
4.1.2	TEST INSTRUMENTS.....	11
4.1.3	TEST PROCEDURES	12
4.1.4	DEVIATION FROM TEST STANDARD	12
4.1.5	TEST SETUP	13
4.1.6	EUT OPERATING CONDITIONS.....	13
4.1.7	TEST RESULTS	14
4.2	RADIATED EMISSION MEASUREMENT	32
4.2.1	LIMITS OF RADIATED EMISSION MEASUREMENT	32
4.2.2	TEST INSTRUMENTS.....	33
4.2.3	TEST PROCEDURES	34
4.2.4	DEVIATION FROM TEST STANDARD	34
4.2.5	TEST SETUP	35
4.2.6	EUT OPERATING CONDITIONS.....	35
4.2.7	TEST RESULTS	36
4.3	6dB BANDWIDTH MEASUREMENT	54
4.3.1	LIMITS OF 6dB BANDWIDTH MEASUREMENT	54
4.3.2	TEST INSTRUMENTS.....	54
4.3.3	TEST PROCEDURE.....	54
4.3.4	DEVIATION FROM TEST STANDARD	54
4.3.5	TEST SETUP	55
4.3.6	EUT OPERATING CONDITIONS.....	55
4.3.7	TEST RESULTS	56
4.4	MAXIMUM PEAK OUTPUT POWER.....	72
4.4.1	LIMITS OF MAXIMUM PEAK OUTPUT POWER MEASUREMENT	72
4.4.2	INSTRUMENTS.....	72
4.4.3	TEST PROCEDURES	72
4.4.4	DEVIATION FROM TEST STANDARD	72
4.4.5	TEST SETUP	73
4.4.6	EUT OPERATING CONDITIONS.....	73
4.4.7	TEST RESULTS	74
4.5	POWER SPECTRAL DENSITY MEASUREMENT.....	76
4.5.1	LIMITS OF POWER SPECTRAL DENSITY MEASUREMENT.....	76
4.5.2	TEST INSTRUMENTS.....	76
4.5.3	TEST PROCEDURE.....	76
4.5.4	DEVIATION FROM TEST STANDARD	76
4.5.5	TEST SETUP	77



4.5.6	EUT OPERATING CONDITION	77
4.5.7	TEST RESULTS	78
4.6	BAND EDGES MEASUREMENT	94
4.6.1	LIMITS OF BAND EDGES MEASUREMENT	94
4.6.2	TEST INSTRUMENTS	94
4.6.3	TEST PROCEDURE	95
4.6.4	DEVIATION FROM TEST STANDARD	95
4.6.5	EUT OPERATING CONDITION	95
4.6.6	TEST RESULTS	96
4.7	ANTENNA REQUIREMENT	112
4.7.1	STANDARD APPLICABLE	112
4.7.2	ANTENNA CONNECTED CONSTRUCTION	112
5.	INFORMATION ON THE TESTING LABORATORIES	113
	APPENDIX-A	A-1



1. CERTIFICATION

PRODUCT : 2.4GHz Wireless 802.11n(DRAFT) PCI Adapter
MODEL NO.: WPC-370A
BRAND: U-MEDIA
APPLICANT : U-MEDIA Communications, Inc.
TESTED: Jul. 21 ~ Jul. 26, 2006
TEST SAMPLE: ENGINEERING SAMPLE
STANDARDS : FCC Part 15, Subpart C (Section 15.247),
ANSI C63.4-2003

The above equipment has been tested by **Advance Data Technology Corporation**, and found compliance with the requirement of the above standards. The test record, data evaluation & Equipment Under Test (EUT) configurations represented herein are true and accurate accounts of the measurements of the sample's EMC characteristics under the conditions specified in this report.

PREPARED BY : Peggy Chen, **DATE:** Jul. 27, 2006
Peggy Chen

TECHNICAL ACCEPTANCE : Long Chen, **DATE:** Jul. 27, 2006
Responsible for RF Long Chen

APPROVED BY : Gary Chang, **DATE:** Jul. 27, 2006
Gary Chang / Supervisor

2. SUMMARY OF TEST RESULTS

The EUT has been tested according to the following specifications:

APPLIED STANDARD: FCC Part 15, Subpart C			
STANDARD SECTION	TEST TYPE AND LIMIT	RESULT	REMARK
15.207	AC Power Conducted Emission	PASS	Meet the requirement of limit. Minimum passing margin is -12.35dB at 0.643MHz.
15.247(a)(2)	Spectrum Bandwidth of a Direct Sequence Spread Spectrum System Limit : min. 500kHz	PASS	Meet the requirement of limit.
15.247(b)	Maximum Peak Output Power Limit: max. 30dBm	PASS	Meet the requirement of limit.
15.247(d)	Transmitter Radiated Emissions Limit: Table 15.209	PASS	Meet the requirement of limit. Minimum passing margin is -1.08dB at 7311.00MHz.
15.247(e)	Power Spectral Density Limit: max. 8dBm	PASS	Meet the requirement of limit.
15.247(d)	Band Edge Measurement Limit: 20dB less than the peak value of fundamental frequency	PASS	Meet the requirement of limit.

2.1 MEASUREMENT UNCERTAINTY

Where relevant, the following measurement uncertainty levels have been estimated for tests performed on the EUT as specified in CISPR 16-4:

MEASUREMENT	FREQUENCY	UNCERTAINTY
Conducted emissions	9kHz ~ 30MHz	2.44dB
Radiated emissions	30MHz ~ 200MHz	3.64 dB
	200MHz ~ 1000MHz	3.65 dB
	1GHz ~ 18GHz	2.26 dB
	18GHz ~ 40GHz	1.94 dB

This uncertainty represents an expanded uncertainty expressed at approximately the 95% confidence level using a coverage factor of $k = 2$.

3. GENERAL INFORMATION

3.1 GENERAL DESCRIPTION OF EUT

PRODUCT	2.4GHz Wireless 802.11n(DRAFT) PCI Adapter
MODEL NO.	WPC-370A
FCC ID	SI5WPC370A
POWER SUPPLY	3.3Vdc from host equipment
MODULATION TYPE	CCK, DQPSK, DBPSK for DSSS 64QAM, 16QAM, QPSK, BPSK for OFDM
MODULATION TECHNOLOGY	DSSS, OFDM
TRANSFER RATE	802.11b: 11.0/ 5.5/ 2.0/ 1.0Mbps 802.11g: 54.0/ 48.0/ 36.0/ 24.0/ 18.0/ 12.0/ 9.0/ 6.0Mbps Draft 802.11n (20MHz): 144.44/ 130.00/ 115.56/ 86.67/ 57.78/ 43.33/ 28.89/ 14.44/ 72.2/ 65.0/ 57.8/ 43.3/ 28.9/ 21.7/ 14.4/ 7.2Mbps Draft 802.11n (40MHz): 300.0/ 270.0/ 240.0/ 180.0/ 120.0/ 90.0/ 60.0/ 30.0/ 150.0/ 135.0/ 120.0/ 90.0/ 60.0/ 45.0/ 30.0/ 15.0Mbps
FREQUENCY RANGE	2412MHz ~ 2462MHz
NUMBER OF CHANNEL	11 for 802.11b, 802.11g, Draft 802.11n (20MHz) 7 for Draft 802.11n (40MHz)
MAXIMUM OUTPUT POWER	128.538mW
ANTENNA TYPE	Refer to NOTE 7
DATA CABLE	NA
I/O PORTS	NA

NOTE:

1. The EUT incorporates a MIMO function with 802.11b, 802.11g, draft 802.11n. Physically, the card provides two completed transmitters and three receivers.
2. The EUT is 2 * 3 spatial MIMO (2Tx & 3Rx) without beam forming function that only operate dual chain configuration (chain 0 and chain 1 transceivers are operational).
3. When the EUT operating in 802.11b and 802.11g, the software operation, which is defined by manufacturer, only set dual Tx.
4. When the EUT operating in draft 802.11n, the software operation, which is defined by manufacturer, only set 0 ~ 15 of "MCS" (MCS: Modulation and Coding Schemes) for dual Tx.
5. The EUT complies with draft 802.11n standards and backwards compatible with 802.11b, 802.11g products.
6. The EUT operates in the 2.4GHz frequency spectrum with throughput of up to 300Mbps.
7. There are 3 antennas for the EUT.

No.	Type	Gain(dBi)	Connector		Remark
1	monopole	5	R-SMA	TX, RX	Long antenna
2	monopole	4	SMA plug Reverse quick crimp	TX, RX	Short antenna
3	monopole	4	SMA plug Reverse quick crimp	RX	Short antenna

8. The above EUT information was declared by manufacturer and for more detailed features description, please refer to the manufacturer's specifications or user's manual.

3.2 DESCRIPTION OF TEST MODES

Eleven channels are provided for 802.11b, 802.11g, draft 802.11n (20MHz):

CHANNEL	FREQUENCY	CHANNEL	FREQUENCY
1	2412MHz	7	2442MHz
2	2417MHz	8	2447MHz
3	2422MHz	9	2452MHz
4	2427MHz	10	2457MHz
5	2432MHz	11	2462MHz
6	2437MHz		

Seven channels are provided for draft 802.11n (40MHz):

CHANNEL	FREQUENCY	CHANNEL	FREQUENCY
1	2422MHz	5	2442MHz
2	2427MHz	6	2447MHz
3	2432MHz	7	2452MHz
4	2437MHz		

3.2.1 CONFIGURATION OF SYSTEM UNDER TEST

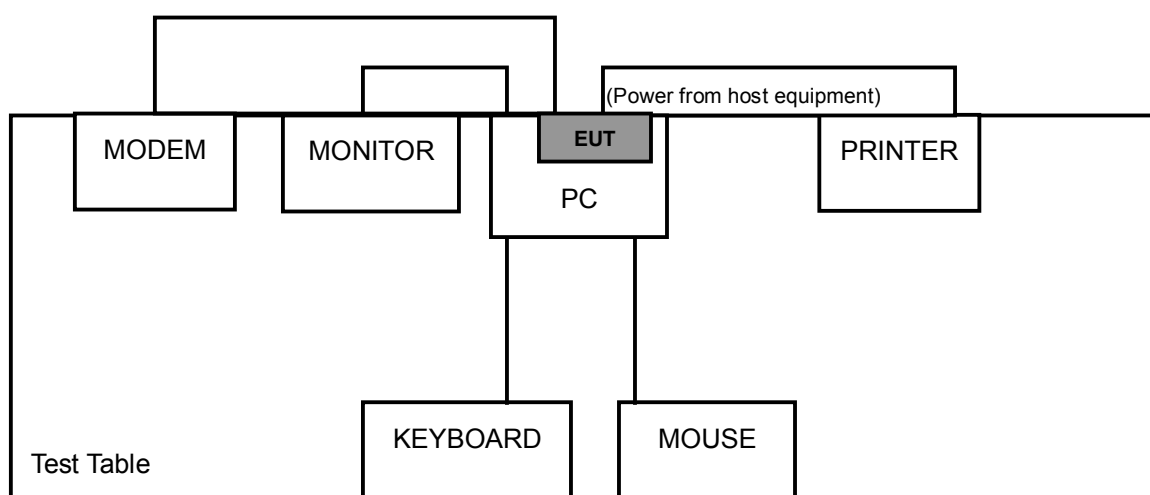

3.2.2 TEST MODE APPLICABILITY AND TESTED CHANNEL DETAIL

EUT CONFIGURE MODE	APPLICABLE TO				DESCRIPTION
	PLC	RE < 1G	RE ≥ 1G	APCM	
-	√	√	√	√	-

Where **PLC**: Power Line Conducted Emission **RE < 1G**: Radiated Emission below 1GHz
RE ≥ 1G: Radiated Emission above 1GHz **APCM**: Antenna Port Conducted Measurement

POWER LINE CONDUCTED EMISSION TEST:

- Pre-Scan has been conducted to determine the worst-case mode from all possible combinations between available modulations, data rates and antenna ports (if EUT with antenna diversity architecture).
- Following channel(s) was (were) selected for the final test as listed below.

MODE	AVAILABLE CHANNEL	TESTED CHANNEL	MODULATION TECHNOLOGY	MODULATION TYPE	DATA RATE (Mbps)	TX CONDITION
802.11g	1 to 11	1, 6, 11	OFDM	BPSK	6.0	Dual
Draft 802.11n (20MHz)	1 to 11	1, 6, 11	OFDM	BPSK	7.2	Dual
Draft 802.11n (40MHz)	1 to 7	1, 4, 7	OFDM	BPSK	15.0	Dual

RADIATED EMISSION TEST (BELOW 1 GHz):

- Pre-Scan has been conducted to determine the worst-case mode from all possible combinations between available modulations, data rates and antenna ports (if EUT with antenna diversity architecture).
- Following channel(s) was (were) selected for the final test as listed below.

MODE	AVAILABLE CHANNEL	TESTED CHANNEL	MODULATION TECHNOLOGY	MODULATION TYPE	DATA RATE (Mbps)	TX CONDITION
802.11g	1 to 11	1	OFDM	BPSK	6.0	Dual
Draft 802.11n (20MHz)	1 to 11	1	OFDM	BPSK	7.2	Dual
Draft 802.11n (40MHz)	1 to 7	1	OFDM	BPSK	15.0	Dual

RADIATED EMISSION TEST (ABOVE 1 GHz):

- Pre-Scan has been conducted to determine the worst-case mode from all possible combinations between available modulations, data rates and antenna ports (if EUT with antenna diversity architecture).
- Following channel(s) was (were) selected for the final test as listed below.

MODE	AVAILABLE CHANNEL	TESTED CHANNEL	MODULATION TECHNOLOGY	MODULATION TYPE	DATA RATE (Mbps)	TX CONDITION
802.11b	1 to 11	1, 6, 11	DSSS	DBPSK	1.0	Dual
802.11g	1 to 11	1, 6, 11	OFDM	BPSK	6.0	Dual
Draft 802.11n (20MHz)	1 to 11	1, 6, 11	OFDM	BPSK	7.2	Dual
Draft 802.11n (40MHz)	1 to 7	1, 4, 7	OFDM	BPSK	15.0	Dual

BANDEDGE MEASUREMENT:

- Pre-Scan has been conducted to determine the worst-case mode from all possible combinations between available modulations, data rates and antenna ports (if EUT with antenna diversity architecture).
- Following channel(s) was (were) selected for the final test as listed below.

MODE	AVAILABLE CHANNEL	TESTED CHANNEL	MODULATION TECHNOLOGY	MODULATION TYPE	DATA RATE (Mbps)	TX CONDITION
802.11b	1 to 11	1, 11	DSSS	DBPSK	1.0	Dual
802.11g	1 to 11	1, 11	OFDM	BPSK	6.0	Dual
Draft 802.11n (20MHz)	1 to 11	1, 11	OFDM	BPSK	7.2	Dual
Draft 802.11n (40MHz)	1 to 7	1, 7	OFDM	BPSK	15.0	Dual

ANTENNA PORT CONDUCTED MEASUREMENT:

- Pre-Scan has been conducted to determine the worst-case mode from all possible combinations between available modulations, data rates and antenna ports (if EUT with antenna diversity architecture).
- Following channel(s) was (were) selected for the final test as listed below.

MODE	AVAILABLE CHANNEL	TESTED CHANNEL	MODULATION TECHNOLOGY	MODULATION TYPE	DATA RATE (Mbps)	TX CONDITION
802.11b	1 to 11	1, 6, 11	DSSS	DBPSK	1.0	Dual
802.11g	1 to 11	1, 6, 11	OFDM	BPSK	6.0	Dual
Draft 802.11n (20MHz)	1 to 11	1, 6, 11	OFDM	BPSK	7.2	Dual
Draft 802.11n (40MHz)	1 to 7	1, 4, 7	OFDM	BPSK	15.0	Dual

3.3 GENERAL DESCRIPTION OF APPLIED STANDARDS

The EUT is a RF product. According to the specifications of the manufacturer, it must comply with the requirements of the following standards:

FCC Part 15, Subpart C. (15.247)

ANSI C63.4-2003

All test items have been performed and recorded as per the above standards.

NOTE: The EUT is also considered as a kind of computer peripheral, because the connection to computer is necessary for typical use. It has been verified to comply with the requirements of FCC Part 15, Subpart B, Class B (DoC). The test report has been issued separately.

3.4 DESCRIPTION OF SUPPORT UNITS

The EUT has been tested as an independent unit together with other necessary accessories or support units. The following support units or accessories were used to form a representative test configuration during the tests.

NO.	PRODUCT	BRAND	MODEL NO.	SERIAL NO.	FCC ID
1	PC	MSI	Hetis 865G	380125734	FCC DoC Approved
2	LCD MONITOR	ACER	AL1721	ET.L0408.010404 001E6PK00	FCC DoC Approved
3	PRINTER	EPSON	LQ-300+	DCGY054147	FCC DoC Approved
4	MODEM	ACEEX	1414V/3	0401008269	IFAXDM1414
5	KEYBOARD	HP	SK-1688	C0306114659	GYUR84SK
6	MOUSE	HP	M-S69	M4-010565	INZ211443

NO.	SIGNAL CABLE DESCRIPTION OF THE ABOVE SUPPORT UNITS
1	NA
2	1.8m shielded cable
3	1.2m shielded cable
4	1.2m shielded cable
5	1.3m shielded cable
6	1.8m shielded cable

NOTE: All power cords of the above support units are non-shielded (1.8m).

4. TEST TYPES AND RESULTS

4.1 CONDUCTED EMISSION MEASUREMENT

4.1.1 LIMITS OF CONDUCTED EMISSION MEASUREMENT

FREQUENCY OF EMISSION (MHz)	CONDUCTED LIMIT (dB μ V)	
	Quasi-peak	Average
0.15-0.5	66 to 56	56 to 46
0.5-5	56	46
5-30	60	50

- NOTE:**
1. The lower limit shall apply at the transition frequencies.
 2. The limit decreases in line with the logarithm of the frequency in the range of 0.15 to 0.50 MHz.
 3. All emanations from a class A/B digital device or system, including any network of conductors and apparatus connected thereto, shall not exceed the level of field strengths specified above.

4.1.2 TEST INSTRUMENTS

DESCRIPTION & MANUFACTURER	MODEL NO.	SERIAL NO.	CALIBRATED UNTIL
Test Receiver ROHDE & SCHWARZ	ESCS30	100291	Nov. 11, 2006
RF signal cable Woken	5D-FB	Cable-HYC01-01	Jan. 06, 2007
LISN ROHDE & SCHWARZ	ESH3-Z5	100312	Feb. 15, 2007
LISN ROHDE & SCHWARZ	ESH2-Z5	100104	Feb. 07, 2007
Software ADT	ADT_Cond_V3	NA	NA

- NOTE:**
1. The calibration interval of the above test instruments is 12 months and the calibrations are traceable to NML/ROC and NIST/USA.
 2. The test was performed in HwaYa Shielded Room 1.
 3. The VCCI Site Registration No. is C-2040.

4.1.3 TEST PROCEDURES

- a. The EUT was placed 0.4 meters from the conducting wall of the shielded room with EUT being connected to the power mains through a line impedance stabilization network (LISN). Other support units were connected to the power mains through another LISN. The two LISNs provide 50 ohm/ 50uH of coupling impedance for the measuring instrument.
- b. Both lines of the power mains connected to the EUT were checked for maximum conducted interference.
- c. The frequency range from 150kHz to 30MHz was searched. Emission levels under (Limit - 20dB) was not recorded.

4.1.4 DEVIATION FROM TEST STANDARD

No deviation

4.1.5 TEST SETUP

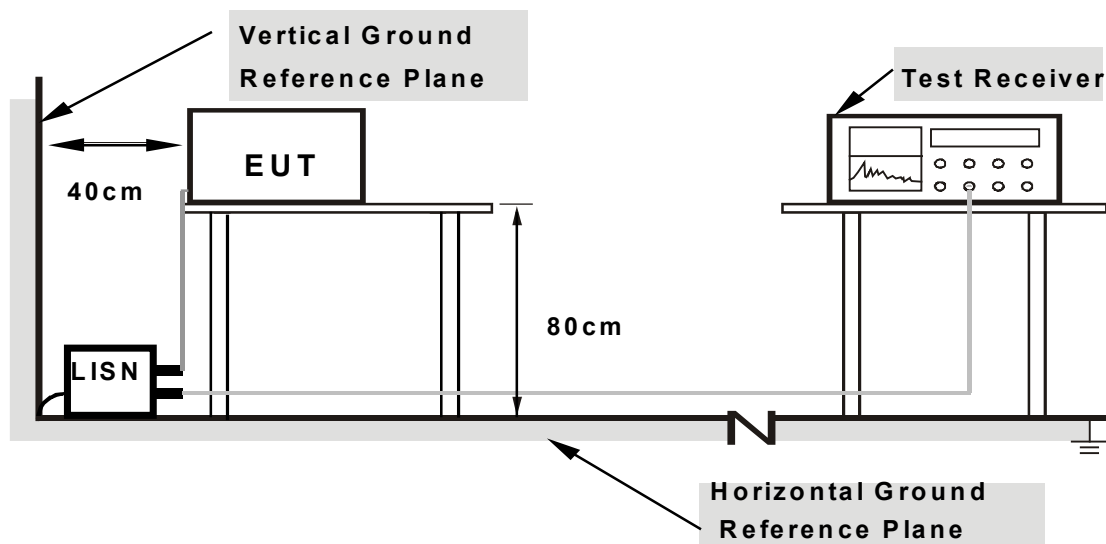

Note: 1. Support units were connected to second LISN.

2. Both of LISNs (AMN) are 80 cm from EUT and at least 80 from other units and other metal planes

For the actual test configuration, please refer to the related item – Photographs of the Test Configuration.

4.1.6 EUT OPERATING CONDITIONS

- a. Connected the EUT into the computer system and placed on a testing table.
- b. The computer system ran a test program (provided by manufacturer) to enable EUT under transmission/receiving condition continuously at specific channel frequency.
- c. The computer system sent "H" messages to monitor, and the monitor displayed them on the screen.
- d. The computer system show "H" messages to modem.
- e. The computer system sent "H" messages to printer and the printer prints them on paper.
- f. Repeated item c ~e.

4.1.7 TEST RESULTS

CONDUCTED WORST-CASE DATA: 802.11g OFDM MODULATION – DUAL TX:

EUT TEST CONDITION		MEASUREMENT DETAIL	
CHANNEL	Channel 1	PHASE	Line 1
MODULATION TYPE	BPSK	6dB BANDWIDTH	9 kHz
TRANSFER RATE	6.0Mbps	INPUT POWER (SYSTEM)	120Vac, 60 Hz
ENVIRONMENTAL CONDITIONS	20deg. C, 60% RH, 991hPa	TESTED BY	Match Tsui

No	FREQ. [MHz]	CORR. Factor (dB)	READING VALUE [dB (uV)]		EMISSION LEVEL [dB (uV)]		LIMIT [dB (uV)]		MARGIN (dB)	
			Q.P.	AV.	Q.P.	AV.	Q.P.	AV.	Q.P.	AV.
1	0.193	0.10	48.14	-	48.24	-	63.91	53.91	-15.67	-
2	0.255	0.10	38.93	-	39.03	-	61.58	51.58	-22.55	-
3	0.451	0.11	37.19	-	37.30	-	56.86	46.86	-19.56	-
4	0.963	0.19	37.40	-	37.59	-	56.00	46.00	-18.41	-
5	3.082	0.35	36.35	-	36.70	-	56.00	46.00	-19.30	-
6	23.040	0.95	31.59	-	32.54	-	60.00	50.00	-27.46	-

- REMARKS:**
1. Q.P. and AV. are abbreviations of quasi-peak and average individually.
 2. "-": The Quasi-peak reading value also meets average limit and measurement with the average detector is unnecessary.
 3. The emission levels of other frequencies were very low against the limit.
 4. Margin value = Emission level - Limit value
 5. Correction factor = Insertion loss + Cable loss
 6. Emission Level = Correction Factor + Reading Value.

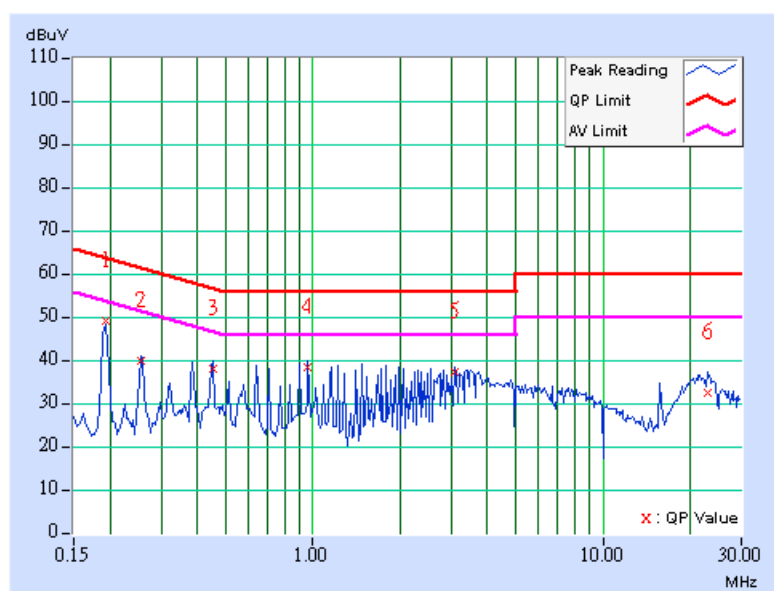

EUT TEST CONDITION		MEASUREMENT DETAIL	
CHANNEL	Channel 1	PHASE	Line 2
MODULATION TYPE	BPSK	6dB BANDWIDTH	9 kHz
TRANSFER RATE	6.0Mbps	INPUT POWER (SYSTEM)	120Vac, 60 Hz
ENVIRONMENTAL CONDITIONS	20deg. C, 60% RH, 991hPa	TESTED BY	Match Tsui

No	FREQ. [MHz]	CORR. Factor (dB)	READING VALUE [dB (uV)]		EMISSION LEVEL [dB (uV)]		LIMIT [dB (uV)]		MARGIN (dB)	
			Q.P.	AV.	Q.P.	AV.	Q.P.	AV.	Q.P.	AV.
1	0.193	0.10	46.37	-	46.47	-	63.91	53.91	-17.44	-
2	0.384	0.10	42.41	-	42.51	-	58.19	48.19	-15.68	-
3	0.638	0.10	42.78	-	42.88	-	56.00	46.00	-13.12	-
4	0.897	0.10	42.48	-	42.58	-	56.00	46.00	-13.42	-
5	3.528	0.33	36.51	-	36.84	-	56.00	46.00	-19.16	-
6	20.015	0.63	33.28	-	33.91	-	60.00	50.00	-26.09	-

- REMARKS:**
1. Q.P. and AV. are abbreviations of quasi-peak and average individually.
 2. "-": The Quasi-peak reading value also meets average limit and measurement with the average detector is unnecessary.
 3. The emission levels of other frequencies were very low against the limit.
 4. Margin value = Emission level - Limit value
 5. Correction factor = Insertion loss + Cable loss
 6. Emission Level = Correction Factor + Reading Value.

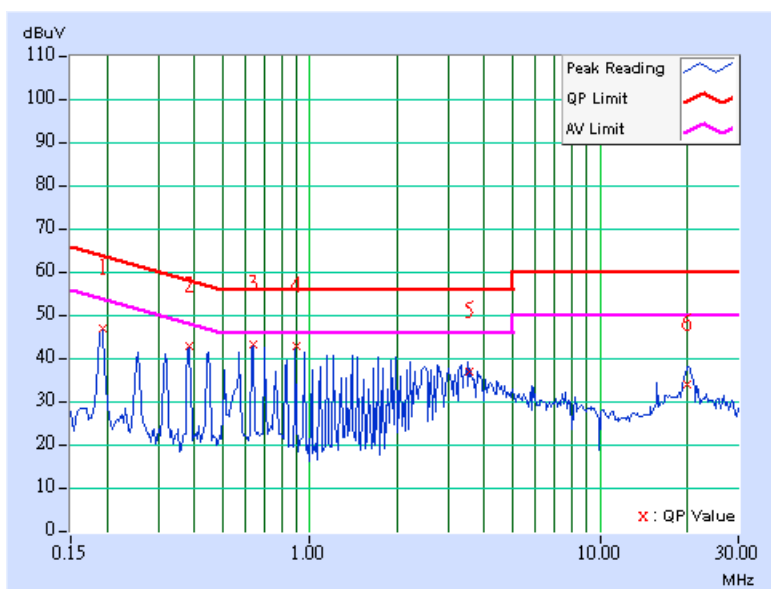

EUT TEST CONDITION		MEASUREMENT DETAIL	
CHANNEL	Channel 6	PHASE	Line 1
MODULATION TYPE	BPSK	6dB BANDWIDTH	9 kHz
TRANSFER RATE	6.0Mbps	INPUT POWER (SYSTEM)	120Vac, 60 Hz
ENVIRONMENTAL CONDITIONS	20deg. C, 60% RH, 991hPa	TESTED BY	Match Tsui

No	FREQ. [MHz]	CORR. Factor (dB)	READING VALUE [dB (uV)]		EMISSION LEVEL [dB (uV)]		LIMIT [dB (uV)]		MARGIN (dB)	
			Q.P.	AV.	Q.P.	AV.	Q.P.	AV.	Q.P.	AV.
1	0.193	0.10	48.20	-	48.30	-	63.91	53.91	-15.61	-
2	0.255	0.10	38.89	-	38.99	-	61.58	51.58	-22.59	-
3	0.451	0.11	37.55	-	37.66	-	56.86	46.86	-19.20	-
4	0.642	0.14	36.23	-	36.37	-	56.00	46.00	-19.63	-
5	3.598	0.42	35.94	-	36.36	-	56.00	46.00	-19.64	-
6	21.397	0.89	32.85	-	33.74	-	60.00	50.00	-26.26	-

- REMARKS:**
1. Q.P. and AV. are abbreviations of quasi-peak and average individually.
 2. "-": The Quasi-peak reading value also meets average limit and measurement with the average detector is unnecessary.
 3. The emission levels of other frequencies were very low against the limit.
 4. Margin value = Emission level - Limit value
 5. Correction factor = Insertion loss + Cable loss
 6. Emission Level = Correction Factor + Reading Value.

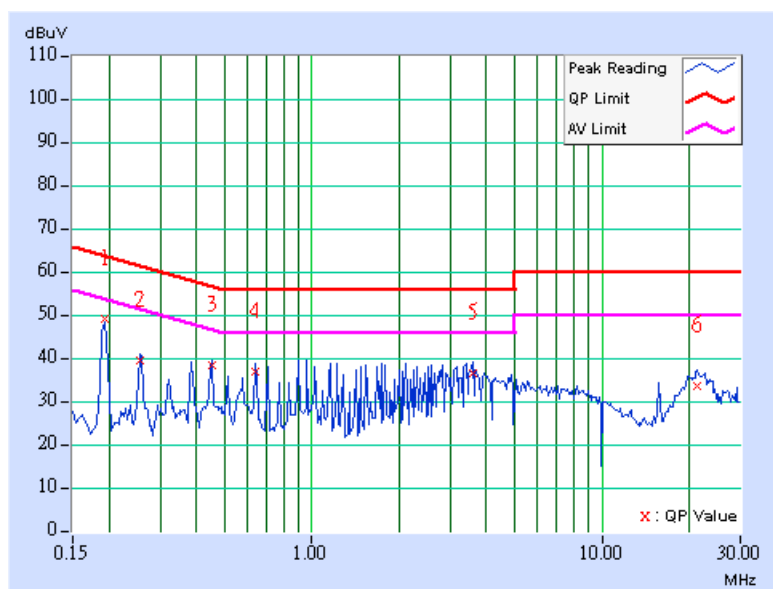

EUT TEST CONDITION		MEASUREMENT DETAIL	
CHANNEL	Channel 6	PHASE	Line 2
MODULATION TYPE	BPSK	6dB BANDWIDTH	9 kHz
TRANSFER RATE	6.0Mbps	INPUT POWER (SYSTEM)	120Vac, 60 Hz
ENVIRONMENTAL CONDITIONS	20deg. C, 60% RH, 991hPa	TESTED BY	Match Tsui

No	FREQ. [MHz]	CORR. Factor (dB)	READING VALUE [dB (uV)]		EMISSION LEVEL [dB (uV)]		LIMIT [dB (uV)]		MARGIN (dB)	
			Q.P.	AV.	Q.P.	AV.	Q.P.	AV.	Q.P.	AV.
1	0.193	0.10	46.49	-	46.59	-	63.91	53.91	-17.32	-
2	0.384	0.10	42.95	-	43.05	-	58.18	48.18	-15.13	-
3	0.451	0.10	41.76	-	41.86	-	56.86	46.86	-15.00	-
4	0.642	0.10	43.34	-	43.44	-	56.00	46.00	-12.56	-
5	1.219	0.12	41.93	-	42.05	-	56.00	46.00	-13.95	-
6	20.681	0.63	34.53	-	35.16	-	60.00	50.00	-24.84	-

- REMARKS:**
1. Q.P. and AV. are abbreviations of quasi-peak and average individually.
 2. "-": The Quasi-peak reading value also meets average limit and measurement with the average detector is unnecessary.
 3. The emission levels of other frequencies were very low against the limit.
 4. Margin value = Emission level - Limit value
 5. Correction factor = Insertion loss + Cable loss
 6. Emission Level = Correction Factor + Reading Value.

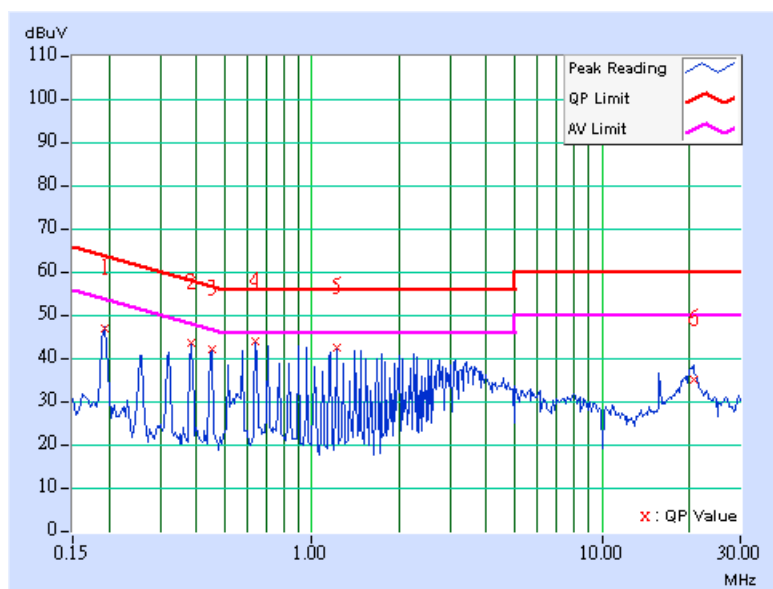

EUT TEST CONDITION		MEASUREMENT DETAIL	
CHANNEL	Channel 11	PHASE	Line 1
MODULATION TYPE	BPSK	6dB BANDWIDTH	9 kHz
TRANSFER RATE	6.0Mbps	INPUT POWER (SYSTEM)	120Vac, 60 Hz
ENVIRONMENTAL CONDITIONS	20deg. C, 60% RH, 991hPa	TESTED BY	Match Tsui

No	FREQ. [MHz]	CORR. Factor (dB)	READING VALUE [dB (uV)]		EMISSION LEVEL [dB (uV)]		LIMIT [dB (uV)]		MARGIN (dB)	
			Q.P.	AV.	Q.P.	AV.	Q.P.	AV.	Q.P.	AV.
1	0.193	0.10	48.24	-	48.34	-	63.91	53.91	-15.57	-
2	0.451	0.11	37.71	-	37.82	-	56.86	46.86	-19.04	-
3	0.642	0.14	36.29	-	36.43	-	56.00	46.00	-19.57	-
4	0.964	0.19	37.58	-	37.77	-	56.00	46.00	-18.23	-
5	3.410	0.39	36.90	-	37.29	-	56.00	46.00	-18.71	-
6	20.520	0.85	33.75	-	34.60	-	60.00	50.00	-25.40	-

- REMARKS:**
1. Q.P. and AV. are abbreviations of quasi-peak and average individually.
 2. "-": The Quasi-peak reading value also meets average limit and measurement with the average detector is unnecessary.
 3. The emission levels of other frequencies were very low against the limit.
 4. Margin value = Emission level - Limit value
 5. Correction factor = Insertion loss + Cable loss
 6. Emission Level = Correction Factor + Reading Value.

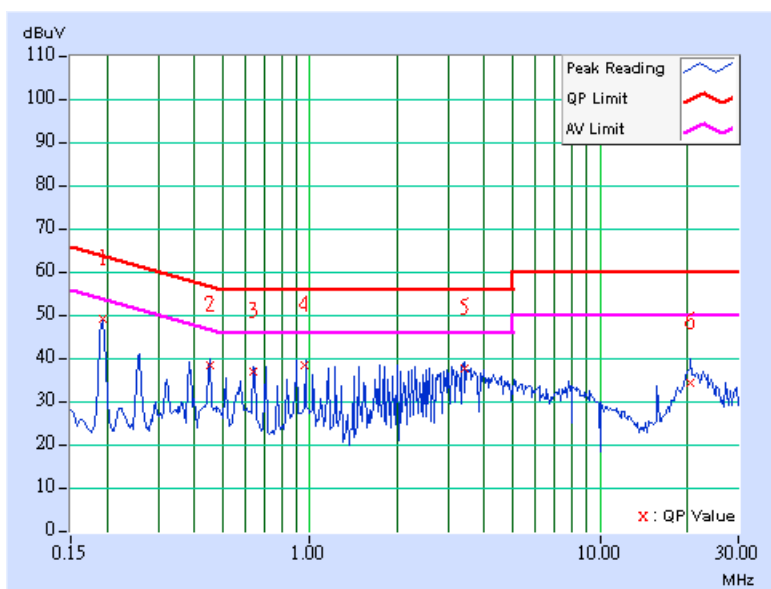

EUT TEST CONDITION		MEASUREMENT DETAIL	
CHANNEL	Channel 11	PHASE	Line 2
MODULATION TYPE	BPSK	6dB BANDWIDTH	9 kHz
TRANSFER RATE	6.0Mbps	INPUT POWER (SYSTEM)	120Vac, 60 Hz
ENVIRONMENTAL CONDITIONS	20deg. C, 60% RH, 991hPa	TESTED BY	Match Tsui

No	FREQ. [MHz]	CORR. Factor (dB)	READING VALUE [dB (uV)]		EMISSION LEVEL [dB (uV)]		LIMIT [dB (uV)]		MARGIN (dB)	
			Q.P.	AV.	Q.P.	AV.	Q.P.	AV.	Q.P.	AV.
1	0.193	0.10	46.45	-	46.55	-	63.91	53.91	-17.36	-
2	0.384	0.10	42.83	-	42.93	-	58.18	48.18	-15.25	-
3	0.451	0.10	41.96	-	42.06	-	56.86	46.86	-14.80	-
4	0.642	0.10	43.30	-	43.40	-	56.00	46.00	-12.60	-
5	2.250	0.22	39.64	-	39.86	-	56.00	46.00	-16.14	-
6	20.314	0.63	33.04	-	33.67	-	60.00	50.00	-26.33	-

- REMARKS:**
1. Q.P. and AV. are abbreviations of quasi-peak and average individually.
 2. "-": The Quasi-peak reading value also meets average limit and measurement with the average detector is unnecessary.
 3. The emission levels of other frequencies were very low against the limit.
 4. Margin value = Emission level - Limit value
 5. Correction factor = Insertion loss + Cable loss
 6. Emission Level = Correction Factor + Reading Value.

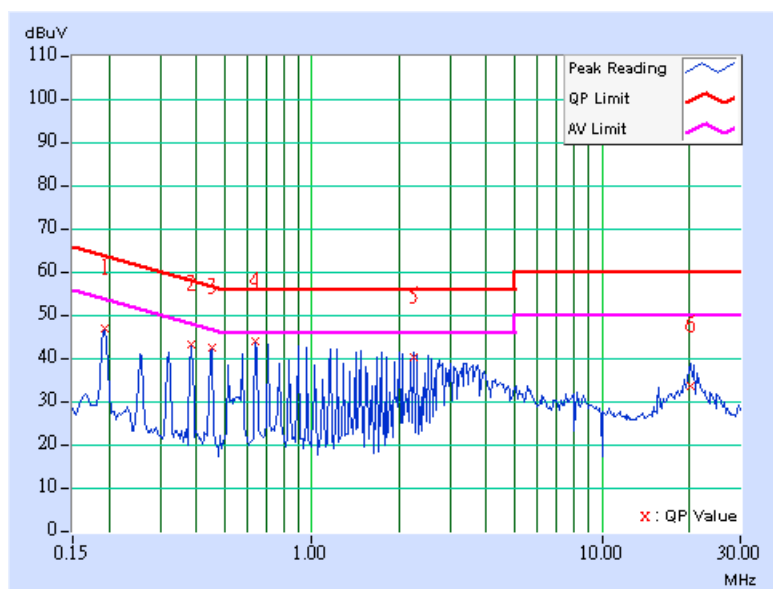

DRAFT 802.11n (20MHz) OFDM MODULATION – DUAL TX:

EUT TEST CONDITION		MEASUREMENT DETAIL	
CHANNEL	Channel 1	PHASE	Line 1
MODULATION TYPE	BPSK	6dB BANDWIDTH	9 kHz
TRANSFER RATE	7.2Mbps	INPUT POWER (SYSTEM)	120Vac, 60 Hz
ENVIRONMENTAL CONDITIONS	20deg. C, 60% RH, 991hPa	TESTED BY	Match Tsui

No	FREQ. [MHz]	CORR. Factor (dB)	READING VALUE [dB (uV)]		EMISSION LEVEL [dB (uV)]		LIMIT [dB (uV)]		MARGIN (dB)	
			Q.P.	AV.	Q.P.	AV.	Q.P.	AV.	Q.P.	AV.
1	0.193	0.10	48.30	-	48.40	-	63.91	53.91	-15.51	-
2	0.387	0.10	37.32	-	37.42	-	58.13	48.13	-20.71	-
3	0.451	0.11	37.71	-	37.82	-	56.86	46.86	-19.04	-
4	0.709	0.15	36.75	-	36.90	-	56.00	46.00	-19.10	-
5	1.547	0.20	36.67	-	36.87	-	56.00	46.00	-19.13	-
6	20.277	0.84	33.62	-	34.46	-	60.00	50.00	-25.54	-

- REMARKS:**
1. Q.P. and AV. are abbreviations of quasi-peak and average individually.
 2. "-": The Quasi-peak reading value also meets average limit and measurement with the average detector is unnecessary.
 3. The emission levels of other frequencies were very low against the limit.
 4. Margin value = Emission level - Limit value
 5. Correction factor = Insertion loss + Cable loss
 6. Emission Level = Correction Factor + Reading Value.

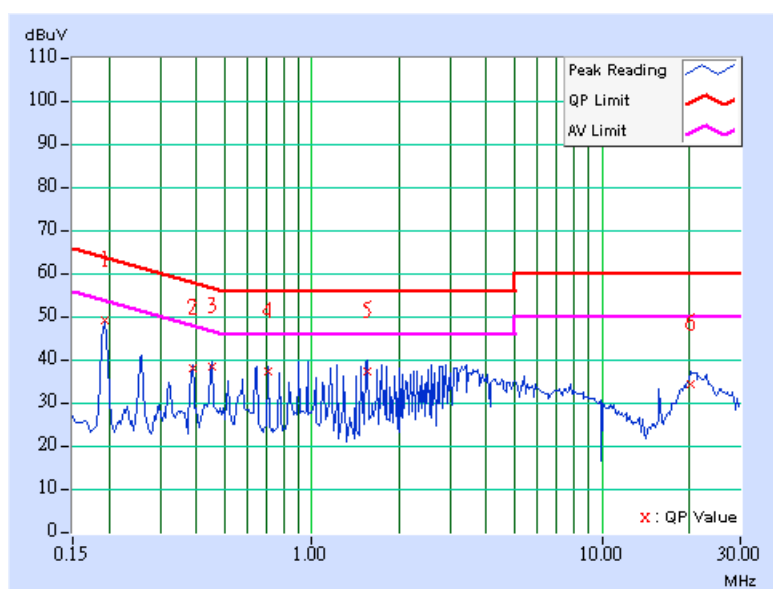

EUT TEST CONDITION		MEASUREMENT DETAIL	
CHANNEL	Channel 1	PHASE	Line 2
MODULATION TYPE	BPSK	6dB BANDWIDTH	9 kHz
TRANSFER RATE	7.2Mbps	INPUT POWER (SYSTEM)	120Vac, 60 Hz
ENVIRONMENTAL CONDITIONS	20deg. C, 60% RH, 991hPa	TESTED BY	Match Tsui

No	FREQ. [MHz]	CORR. Factor (dB)	READING VALUE [dB (uV)]		EMISSION LEVEL [dB (uV)]		LIMIT [dB (uV)]		MARGIN (dB)	
			Q.P.	AV.	Q.P.	AV.	Q.P.	AV.	Q.P.	AV.
1	0.193	0.10	46.43	-	46.53	-	63.91	53.91	-17.38	-
2	0.387	0.10	43.06	-	43.16	-	58.13	48.13	-14.97	-
3	0.451	0.10	42.00	-	42.10	-	56.86	46.86	-14.76	-
4	0.642	0.10	43.18	-	43.28	-	56.00	46.00	-12.72	-
5	1.223	0.12	42.29	-	42.41	-	56.00	46.00	-13.59	-
6	20.531	0.63	34.79	-	35.42	-	60.00	50.00	-24.58	-

- REMARKS:**
1. Q.P. and AV. are abbreviations of quasi-peak and average individually.
 2. "-": The Quasi-peak reading value also meets average limit and measurement with the average detector is unnecessary.
 3. The emission levels of other frequencies were very low against the limit.
 4. Margin value = Emission level - Limit value
 5. Correction factor = Insertion loss + Cable loss
 6. Emission Level = Correction Factor + Reading Value.

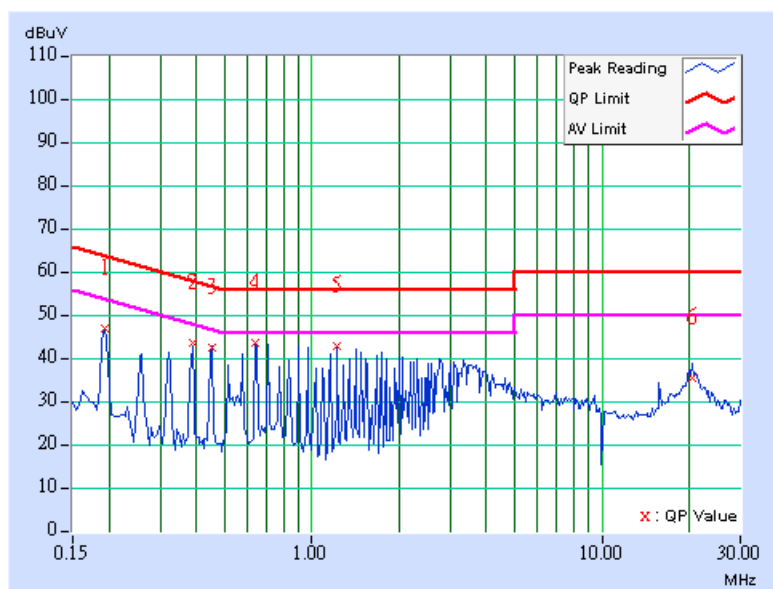

EUT TEST CONDITION		MEASUREMENT DETAIL	
CHANNEL	Channel 6	PHASE	Line 1
MODULATION TYPE	BPSK	6dB BANDWIDTH	9 kHz
TRANSFER RATE	7.2Mbps	INPUT POWER (SYSTEM)	120Vac, 60 Hz
ENVIRONMENTAL CONDITIONS	20deg. C, 60% RH, 991hPa	TESTED BY	Match Tsui

No	FREQ. [MHz]	CORR. Factor (dB)	READING VALUE [dB (uV)]		EMISSION LEVEL [dB (uV)]		LIMIT [dB (uV)]		MARGIN (dB)	
			Q.P.	AV.	Q.P.	AV.	Q.P.	AV.	Q.P.	AV.
1	0.193	0.10	48.26	-	47.36	-	63.91	53.91	-16.55	-
2	0.259	0.10	39.03	-	39.13	-	61.45	51.45	-22.32	-
3	0.451	0.11	37.67	-	37.78	-	56.86	46.86	-19.08	-
4	0.709	0.15	36.91	-	37.06	-	56.00	46.00	-18.94	-
5	3.479	0.40	36.58	-	36.98	-	56.00	46.00	-19.02	-
6	20.293	0.84	33.58	-	34.42	-	60.00	50.00	-25.58	-

- REMARKS:**
1. Q.P. and AV. are abbreviations of quasi-peak and average individually.
 2. "-": The Quasi-peak reading value also meets average limit and measurement with the average detector is unnecessary.
 3. The emission levels of other frequencies were very low against the limit.
 4. Margin value = Emission level - Limit value
 5. Correction factor = Insertion loss + Cable loss
 6. Emission Level = Correction Factor + Reading Value.

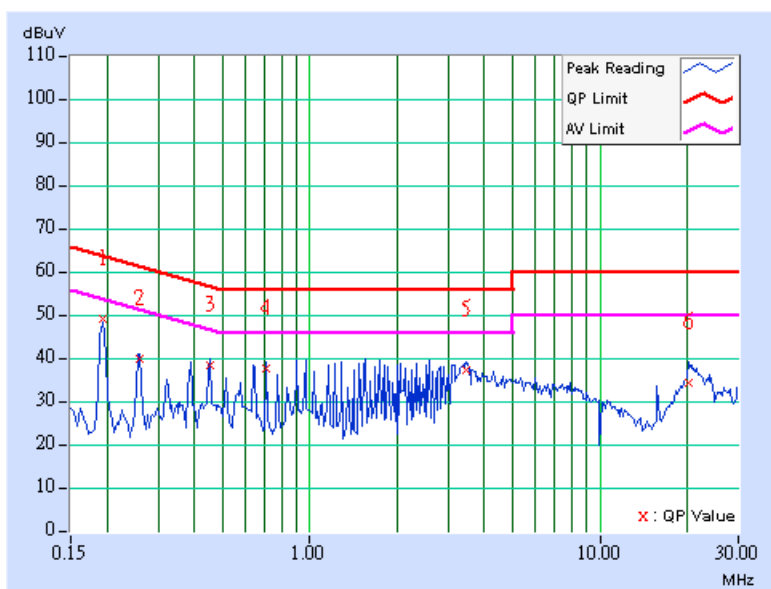

EUT TEST CONDITION		MEASUREMENT DETAIL	
CHANNEL	Channel 6	PHASE	Line 2
MODULATION TYPE	BPSK	6dB BANDWIDTH	9 kHz
TRANSFER RATE	7.2Mbps	INPUT POWER (SYSTEM)	120Vac, 60 Hz
ENVIRONMENTAL CONDITIONS	20deg. C, 60% RH, 991hPa	TESTED BY	Match Tsui

No	FREQ. [MHz]	CORR. Factor (dB)	READING VALUE [dB (uV)]		EMISSION LEVEL [dB (uV)]		LIMIT [dB (uV)]		MARGIN (dB)	
			Q.P.	AV.	Q.P.	AV.	Q.P.	AV.	Q.P.	AV.
1	0.193	0.10	46.05	-	46.15	-	63.91	53.91	-17.76	-
2	0.388	0.10	42.75	-	42.85	-	58.10	48.10	-15.25	-
3	0.451	0.10	42.40	-	42.50	-	56.86	46.86	-14.36	-
4	0.643	0.10	43.55	-	43.65	-	56.00	46.00	-12.35	-
5	3.477	0.33	36.52	-	36.85	-	56.00	46.00	-19.15	-
6	20.669	0.63	34.20	-	34.83	-	60.00	50.00	-25.17	-

- REMARKS:**
1. Q.P. and AV. are abbreviations of quasi-peak and average individually.
 2. "-": The Quasi-peak reading value also meets average limit and measurement with the average detector is unnecessary.
 3. The emission levels of other frequencies were very low against the limit.
 4. Margin value = Emission level - Limit value
 5. Correction factor = Insertion loss + Cable loss
 6. Emission Level = Correction Factor + Reading Value.

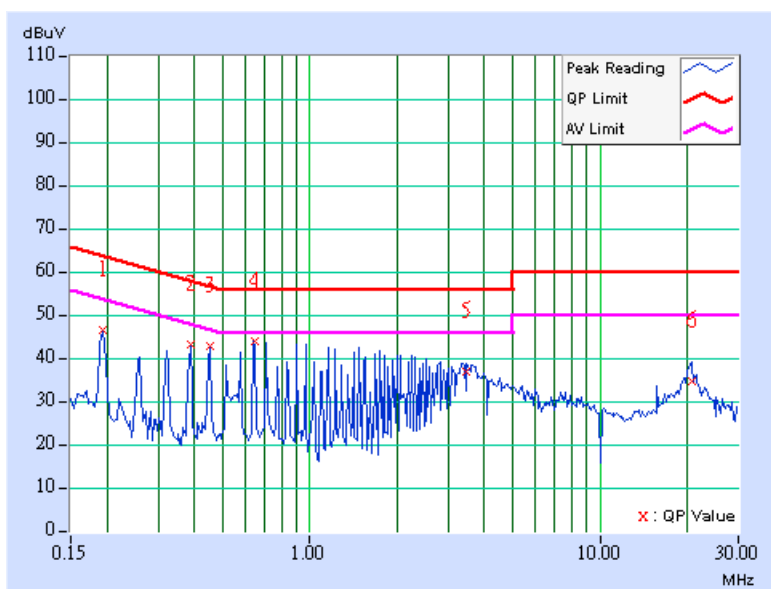

EUT TEST CONDITION		MEASUREMENT DETAIL	
CHANNEL	Channel 11	PHASE	Line 1
MODULATION TYPE	BPSK	6dB BANDWIDTH	9 kHz
TRANSFER RATE	7.2Mbps	INPUT POWER (SYSTEM)	120Vac, 60 Hz
ENVIRONMENTAL CONDITIONS	20deg. C, 60% RH, 991hPa	TESTED BY	Match Tsui

No	FREQ. [MHz]	CORR. Factor (dB)	READING VALUE [dB (uV)]		EMISSION LEVEL [dB (uV)]		LIMIT [dB (uV)]		MARGIN (dB)	
			Q.P.	AV.	Q.P.	AV.	Q.P.	AV.	Q.P.	AV.
1	0.193	0.10	48.26	-	48.36	-	63.91	53.91	-15.55	-
2	0.259	0.10	39.09	-	39.19	-	61.45	51.45	-22.26	-
3	0.451	0.11	37.77	-	37.88	-	56.86	46.86	-18.98	-
4	0.643	0.14	36.36	-	36.50	-	56.00	46.00	-19.50	-
5	3.609	0.42	35.98	-	36.40	-	56.00	46.00	-19.60	-
6	21.074	0.87	33.23	-	34.10	-	60.00	50.00	-25.90	-

- REMARKS:**
1. Q.P. and AV. are abbreviations of quasi-peak and average individually.
 2. "-": The Quasi-peak reading value also meets average limit and measurement with the average detector is unnecessary.
 3. The emission levels of other frequencies were very low against the limit.
 4. Margin value = Emission level - Limit value
 5. Correction factor = Insertion loss + Cable loss
 6. Emission Level = Correction Factor + Reading Value.

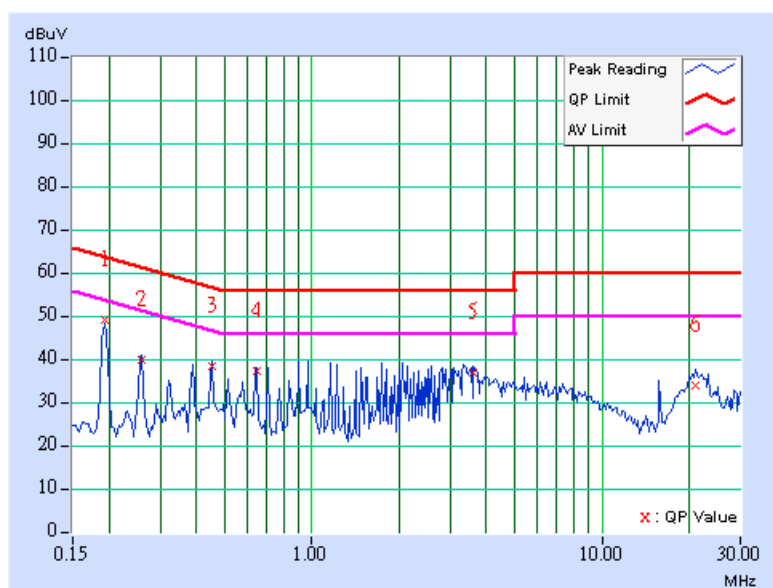

EUT TEST CONDITION		MEASUREMENT DETAIL	
CHANNEL	Channel 11	PHASE	Line 2
MODULATION TYPE	BPSK	6dB BANDWIDTH	9 kHz
TRANSFER RATE	7.2Mbps	INPUT POWER (SYSTEM)	120Vac, 60 Hz
ENVIRONMENTAL CONDITIONS	20deg. C, 60% RH, 991hPa	TESTED BY	Match Tsui

No	FREQ. [MHz]	CORR. Factor (dB)	READING VALUE [dB (uV)]		EMISSION LEVEL [dB (uV)]		LIMIT [dB (uV)]		MARGIN (dB)	
			Q.P.	AV.	Q.P.	AV.	Q.P.	AV.	Q.P.	AV.
1	0.193	0.10	46.35	-	46.45	-	63.91	53.91	-17.46	-
2	0.388	0.10	42.83	-	42.93	-	58.10	48.10	-15.17	-
3	0.451	0.10	42.04	-	42.14	-	56.86	46.86	-14.72	-
4	0.646	0.10	43.09	-	43.19	-	56.00	46.00	-12.81	-
5	3.543	0.33	36.65	-	36.98	-	56.00	46.00	-19.02	-
6	20.295	0.63	34.60	-	35.23	-	60.00	50.00	-24.77	-

- REMARKS:**
1. Q.P. and AV. are abbreviations of quasi-peak and average individually.
 2. "-": The Quasi-peak reading value also meets average limit and measurement with the average detector is unnecessary.
 3. The emission levels of other frequencies were very low against the limit.
 4. Margin value = Emission level - Limit value
 5. Correction factor = Insertion loss + Cable loss
 6. Emission Level = Correction Factor + Reading Value.

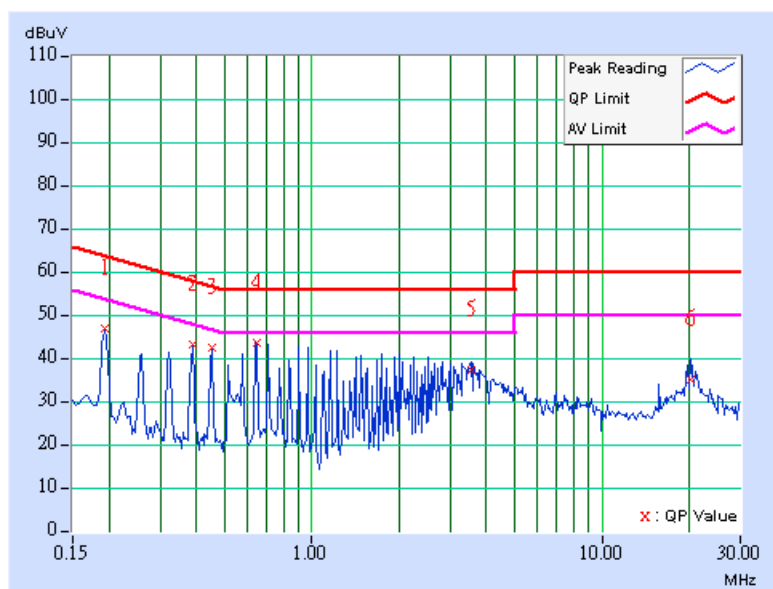

DRAFT 802.11n (40MHz) OFDM MODULATION – DUAL TX:

EUT TEST CONDITION		MEASUREMENT DETAIL	
CHANNEL	Channel 1	PHASE	Line 1
MODULATION TYPE	BPSK	6dB BANDWIDTH	9 kHz
TRANSFER RATE	15.0Mbps	INPUT POWER (SYSTEM)	120Vac, 60 Hz
ENVIRONMENTAL CONDITIONS	20deg. C, 60% RH, 991hPa	TESTED BY	Match Tsui

No	FREQ. [MHz]	CORR. Factor (dB)	READING VALUE [dB (uV)]		EMISSION LEVEL [dB (uV)]		LIMIT [dB (uV)]		MARGIN (dB)	
			Q.P.	AV.	Q.P.	AV.	Q.P.	AV.	Q.P.	AV.
1	0.193	0.10	48.26	-	48.36	-	63.91	53.91	-15.55	-
2	0.259	0.10	38.63	-	38.73	-	61.45	51.45	-22.72	-
3	0.451	0.11	37.27	-	37.38	-	56.86	46.86	-19.48	-
4	0.966	0.19	37.03	-	37.22	-	56.00	46.00	-18.78	-
5	3.484	0.40	35.86	-	36.26	-	56.00	46.00	-19.74	-
6	20.570	0.85	33.58	-	34.43	-	60.00	50.00	-25.57	-

- REMARKS:**
1. Q.P. and AV. are abbreviations of quasi-peak and average individually.
 2. "-": The Quasi-peak reading value also meets average limit and measurement with the average detector is unnecessary.
 3. The emission levels of other frequencies were very low against the limit.
 4. Margin value = Emission level - Limit value
 5. Correction factor = Insertion loss + Cable loss
 6. Emission Level = Correction Factor + Reading Value.

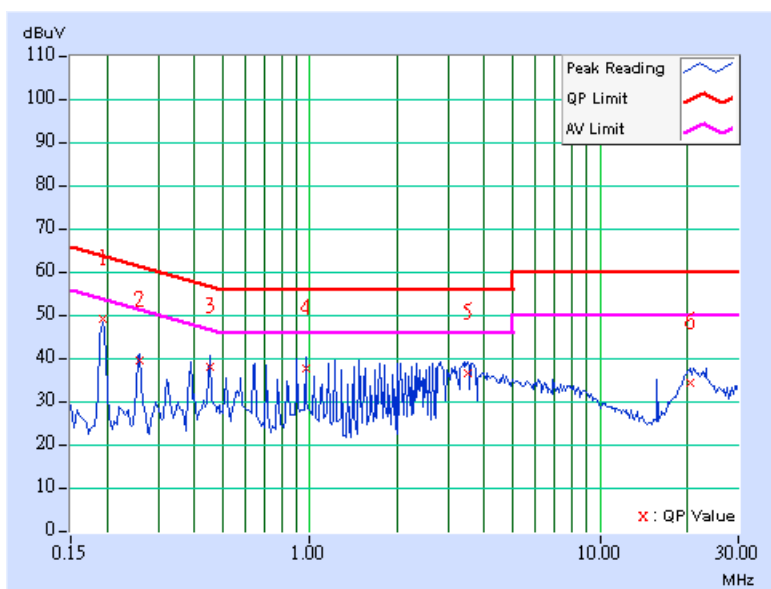

EUT TEST CONDITION		MEASUREMENT DETAIL	
CHANNEL	Channel 1	PHASE	Line 2
MODULATION TYPE	BPSK	6dB BANDWIDTH	9 kHz
TRANSFER RATE	15.0Mbps	INPUT POWER (SYSTEM)	120Vac, 60 Hz
ENVIRONMENTAL CONDITIONS	20deg. C, 60% RH, 991hPa	TESTED BY	Match Tsui

No	FREQ. [MHz]	CORR. Factor (dB)	READING VALUE [dB (uV)]		EMISSION LEVEL [dB (uV)]		LIMIT [dB (uV)]		MARGIN (dB)	
			Q.P.	AV.	Q.P.	AV.	Q.P.	AV.	Q.P.	AV.
1	0.193	0.10	46.35	-	46.45	-	63.91	53.91	-17.46	-
2	0.388	0.10	42.93	-	42.03	-	58.10	48.10	-16.07	-
3	0.451	0.10	41.98	-	42.08	-	56.86	46.86	-14.78	-
4	0.646	0.10	43.23	-	42.33	-	56.00	46.00	-13.67	-
5	3.674	0.34	36.74	-	37.08	-	56.00	46.00	-18.92	-
6	20.242	0.63	34.82	-	35.45	-	60.00	50.00	-24.55	-

- REMARKS:**
1. Q.P. and AV. are abbreviations of quasi-peak and average individually.
 2. "-": The Quasi-peak reading value also meets average limit and measurement with the average detector is unnecessary.
 3. The emission levels of other frequencies were very low against the limit.
 4. Margin value = Emission level - Limit value
 5. Correction factor = Insertion loss + Cable loss
 6. Emission Level = Correction Factor + Reading Value.

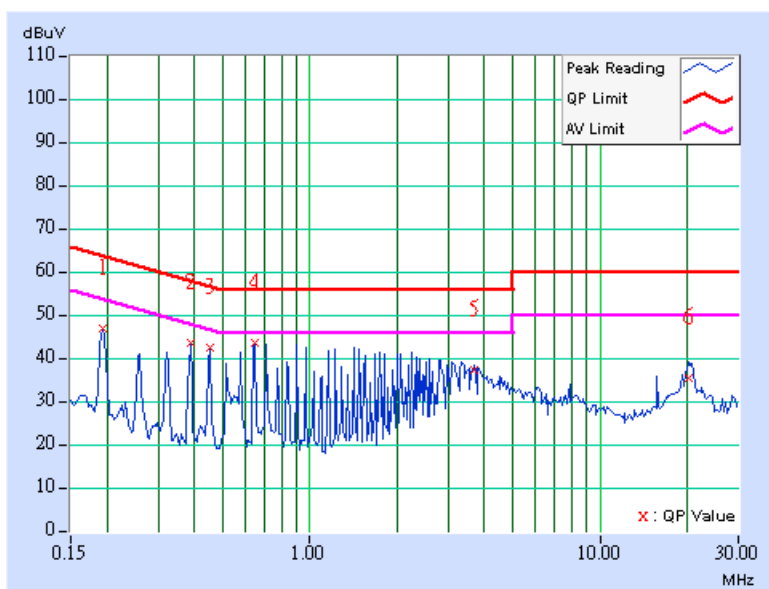

EUT TEST CONDITION		MEASUREMENT DETAIL	
CHANNEL	Channel 4	PHASE	Line 1
MODULATION TYPE	BPSK	6dB BANDWIDTH	9 kHz
TRANSFER RATE	15.0Mbps	INPUT POWER (SYSTEM)	120Vac, 60 Hz
ENVIRONMENTAL CONDITIONS	20deg. C, 60% RH, 991hPa	TESTED BY	Match Tsui

No	FREQ. [MHz]	CORR. Factor (dB)	READING VALUE [dB (uV)]		EMISSION LEVEL [dB (uV)]		LIMIT [dB (uV)]		MARGIN (dB)	
			Q.P.	AV.	Q.P.	AV.	Q.P.	AV.	Q.P.	AV.
1	0.193	0.10	47.96	-	48.06	-	63.91	53.91	-15.85	-
2	0.259	0.10	38.59	-	38.69	-	61.45	51.45	-22.76	-
3	0.451	0.11	37.33	-	37.44	-	56.86	46.86	-19.42	-
4	0.646	0.14	36.66	-	36.80	-	56.00	46.00	-19.20	-
5	3.098	0.35	36.23	-	36.58	-	56.00	46.00	-19.42	-
6	20.129	0.84	32.39	-	33.23	-	60.00	50.00	-26.77	-

- REMARKS:**
1. Q.P. and AV. are abbreviations of quasi-peak and average individually.
 2. "-": The Quasi-peak reading value also meets average limit and measurement with the average detector is unnecessary.
 3. The emission levels of other frequencies were very low against the limit.
 4. Margin value = Emission level - Limit value
 5. Correction factor = Insertion loss + Cable loss
 6. Emission Level = Correction Factor + Reading Value.

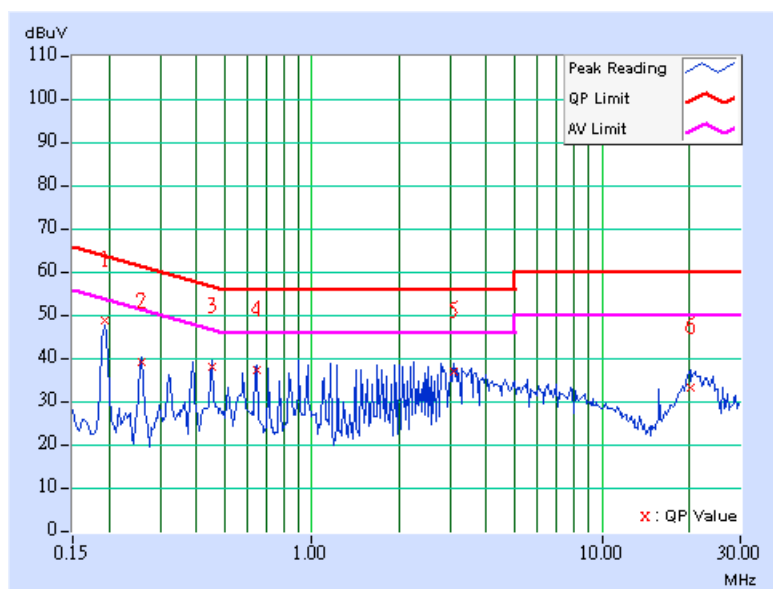

EUT TEST CONDITION		MEASUREMENT DETAIL	
CHANNEL	Channel 4	PHASE	Line 2
MODULATION TYPE	BPSK	6dB BANDWIDTH	9 kHz
TRANSFER RATE	15.0Mbps	INPUT POWER (SYSTEM)	120Vac, 60 Hz
ENVIRONMENTAL CONDITIONS	20deg. C, 60% RH, 991hPa	TESTED BY	Match Tsui

No	FREQ. [MHz]	CORR. Factor (dB)	READING VALUE [dB (uV)]		EMISSION LEVEL [dB (uV)]		LIMIT [dB (uV)]		MARGIN (dB)	
			Q.P.	AV.	Q.P.	AV.	Q.P.	AV.	Q.P.	AV.
1	0.193	0.10	46.29	-	46.39	-	63.91	53.91	-17.52	-
2	0.388	0.10	42.93	-	43.03	-	58.10	48.10	-15.07	-
3	0.451	0.10	41.54	-	41.64	-	56.86	46.86	-15.22	-
4	0.646	0.10	43.39	-	43.49	-	56.00	46.00	-12.51	-
5	1.934	0.19	39.95	-	40.14	-	56.00	46.00	-15.86	-
6	20.637	0.63	34.56	-	35.19	-	60.00	50.00	-24.81	-

- REMARKS:**
1. Q.P. and AV. are abbreviations of quasi-peak and average individually.
 2. "-": The Quasi-peak reading value also meets average limit and measurement with the average detector is unnecessary.
 3. The emission levels of other frequencies were very low against the limit.
 4. Margin value = Emission level - Limit value
 5. Correction factor = Insertion loss + Cable loss
 6. Emission Level = Correction Factor + Reading Value.

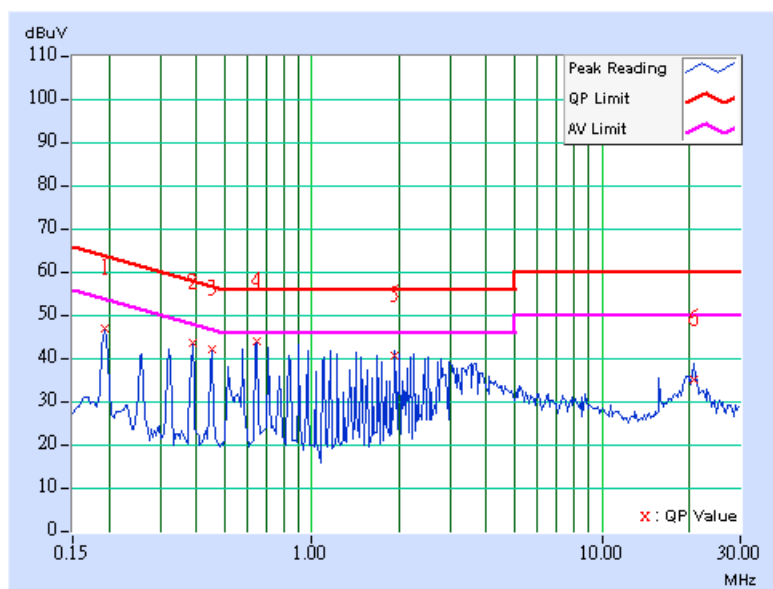

EUT TEST CONDITION		MEASUREMENT DETAIL	
CHANNEL	Channel 7	PHASE	Line 1
MODULATION TYPE	BPSK	6dB BANDWIDTH	9 kHz
TRANSFER RATE	15.0Mbps	INPUT POWER (SYSTEM)	120Vac, 60 Hz
ENVIRONMENTAL CONDITIONS	20deg. C, 60% RH, 991hPa	TESTED BY	Match Tsui

No	FREQ. [MHz]	CORR. Factor (dB)	READING VALUE [dB (uV)]		EMISSION LEVEL [dB (uV)]		LIMIT [dB (uV)]		MARGIN (dB)	
			Q.P.	AV.	Q.P.	AV.	Q.P.	AV.	Q.P.	AV.
1	0.193	0.10	47.94	-	48.04	-	63.91	53.91	-15.87	-
2	0.259	0.10	38.69	-	38.79	-	61.45	51.45	-22.66	-
3	0.451	0.11	37.57	-	37.68	-	56.86	46.86	-19.18	-
4	0.646	0.14	36.68	-	36.82	-	56.00	46.00	-19.18	-
5	3.742	0.44	34.80	-	35.24	-	56.00	46.00	-20.76	-
6	20.513	0.85	33.19	-	34.04	-	60.00	50.00	-25.96	-

- REMARKS:**
1. Q.P. and AV. are abbreviations of quasi-peak and average individually.
 2. "-": The Quasi-peak reading value also meets average limit and measurement with the average detector is unnecessary.
 3. The emission levels of other frequencies were very low against the limit.
 4. Margin value = Emission level - Limit value
 5. Correction factor = Insertion loss + Cable loss
 6. Emission Level = Correction Factor + Reading Value.

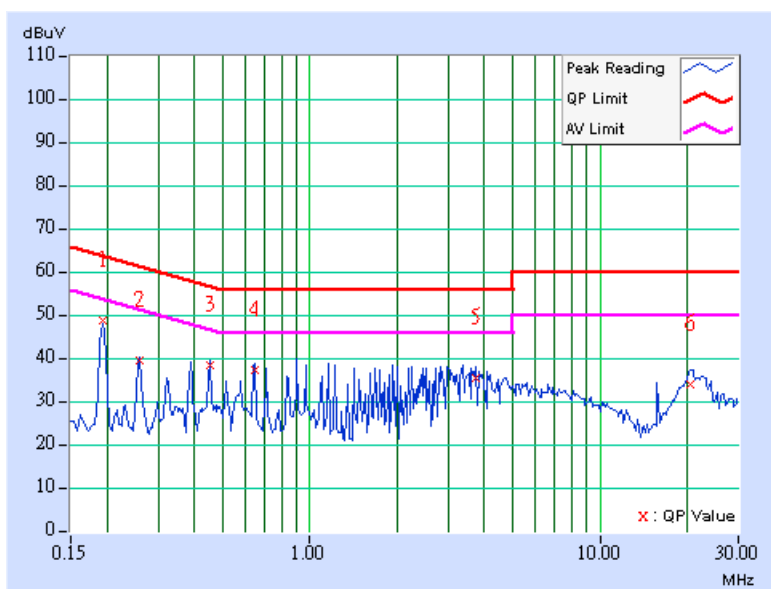

EUT TEST CONDITION		MEASUREMENT DETAIL	
CHANNEL	Channel 7	PHASE	Line 2
MODULATION TYPE	BPSK	6dB BANDWIDTH	9 kHz
TRANSFER RATE	15.0Mbps	INPUT POWER (SYSTEM)	120Vac, 60 Hz
ENVIRONMENTAL CONDITIONS	20deg. C, 60% RH, 991hPa	TESTED BY	Match Tsui

No	FREQ. [MHz]	CORR. Factor (dB)	READING VALUE [dB (uV)]		EMISSION LEVEL [dB (uV)]		LIMIT [dB (uV)]		MARGIN (dB)	
			Q.P.	AV.	Q.P.	AV.	Q.P.	AV.	Q.P.	AV.
1	0.193	0.10	46.23	-	46.33	-	63.91	53.91	-17.58	-
2	0.388	0.10	42.95	-	43.05	-	58.10	48.10	-15.05	-
3	0.451	0.10	41.54	-	41.64	-	56.86	46.86	-15.22	-
4	0.646	0.10	43.43	-	43.53	-	56.00	46.00	-12.47	-
5	3.613	0.34	37.04	-	37.38	-	56.00	46.00	-18.62	-
6	20.129	0.63	34.39	-	35.02	-	60.00	50.00	-24.98	-

- REMARKS:**
1. Q.P. and AV. are abbreviations of quasi-peak and average individually.
 2. "-": The Quasi-peak reading value also meets average limit and measurement with the average detector is unnecessary.
 3. The emission levels of other frequencies were very low against the limit.
 4. Margin value = Emission level - Limit value
 5. Correction factor = Insertion loss + Cable loss
 6. Emission Level = Correction Factor + Reading Value.

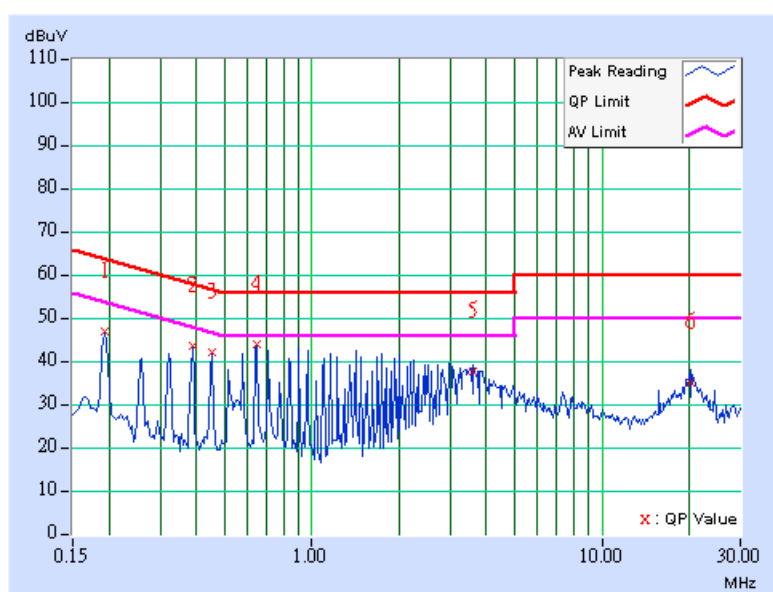

4.2 RADIATED EMISSION MEASUREMENT

4.2.1 LIMITS OF RADIATED EMISSION MEASUREMENT

Emissions radiated outside of the specified bands, shall be according to the general radiated limits in 15.209 as following:

FREQUENCIES (MHz)	FIELD STRENGTH (microvolts/meter)	MEASUREMENT DISTANCE (meters)
0.009 ~ 0.490	2400 / F(kHz)	300
0.490 ~ 1.705	24000 / F(kHz)	30
1.705 ~ 30.0	30	30
30 ~ 88	100	3
88 ~ 216	150	3
216 ~ 960	200	3
Above 960	500	3

NOTE:

1. The lower limit shall apply at the transition frequencies.
2. Emission level (dBuV/m) = 20 log Emission level (uV/m).
3. As shown in 15.35(b), for frequencies above 1000MHz, the field strength limits are based on average detector, however, the peak field strength of any emission shall not exceed the maximum permitted average limits, specified above by more than 20dB under any condition of modulation.

4.2.2 TEST INSTRUMENTS

DESCRIPTION & MANUFACTURER	MODEL NO.	SERIAL NO.	CALIBRATED UNTIL
Test Receiver ROHDE & SCHWARZ	ESIB7	100188	Dec. 20, 2006
Spectrum Analyzer ROHDE & SCHWARZ	FSP40	100039	Nov. 27, 2006
BILOG Antenna SCHWARZBECK	VULB9168	9168-157	Jan. 15, 2007
HORN Antenna SCHWARZBECK	BBHA 9120 D	9120D-407	Jan. 22, 2007
HORN Antenna SCHWARZBECK	BBHA 9170	BBHA9170147	Jan. 26, 2007
Preamplifier Agilent	8449B	3008A01961	Oct. 23, 2006
Preamplifier Agilent	8447D	2944A10629	Oct. 27, 2006
RF signal cable HUBER+SUHNER	SUCOFLEX 104	214380/4	Jan. 16, 2007
RF signal cable HUBER+SUHNER	SUCOFLEX 104	219266/4	Jan. 16, 2007
Software ADT.	ADT_Radiated_V5.14	NA	NA
Antenna Tower ADT.	AT100	AT93021702	NA
Turn Table ADT.	TT100.	TT93021702	NA
Controller ADT.	SC100.	SC93021702	NA

- NOTE:** 1. The calibration interval of the above test instruments is 12 months and the calibrations are traceable to NML/ROC and NIST/USA.
2. The test was performed in HwaYa Chamber 1.
3. The horn antenna and HP preamplifier (model: 8449B) are used only for the measurement of emission frequency above 1GHz if tested.
4. The IC Site Registration No. is IC4924-2.

4.2.3 TEST PROCEDURES

- a. The EUT was placed on the top of a rotating table 0.8 meters above the ground at a 3 meters semi-anechoic chamber. The table was rotated 360 degrees to determine the position of the highest radiation.
- b. The EUT was set 3 meters away from the interference-receiving antenna, which was mounted on the top of a variable-height antenna tower.
- c. The antenna is a broadband antenna, and its height is varied from one meter to four meters above the ground to determine the maximum value of the field strength. Both horizontal and vertical polarizations of the antenna are set to make the measurement.
- d. For each suspected emission, the EUT was arranged to its worst case and then the antenna was tuned to heights from 1 meter to 4 meters and the rotatable table was turned from 0 degrees to 360 degrees to find the maximum reading.
- e. The test-receiver system was set to Peak Detect Function and Specified Bandwidth with Maximum Hold Mode.
- f. If the emission level of the EUT in peak mode was lower than the limit specified, then testing could be stopped and the peak values of the EUT would be reported. Otherwise the emissions would be re-tested one by one using peak, quasi-peak or average method as specified and then reported in a data sheet.

NOTE:

1. The resolution bandwidth and video bandwidth of test receiver/spectrum analyzer is 120kHz for Peak detection (PK) and Quasi-peak detection (QP) at frequency below 1GHz.
2. The resolution bandwidth and video bandwidth of test receiver/spectrum analyzer is 1 MHz for Peak detection at frequency above 1GHz.
3. The resolution bandwidth of test receiver/spectrum analyzer is 1MHz and the video bandwidth is 10Hz for Average detection (AV) at frequency above 1GHz.

4.2.4 DEVIATION FROM TEST STANDARD

No deviation

4.2.5 TEST SETUP

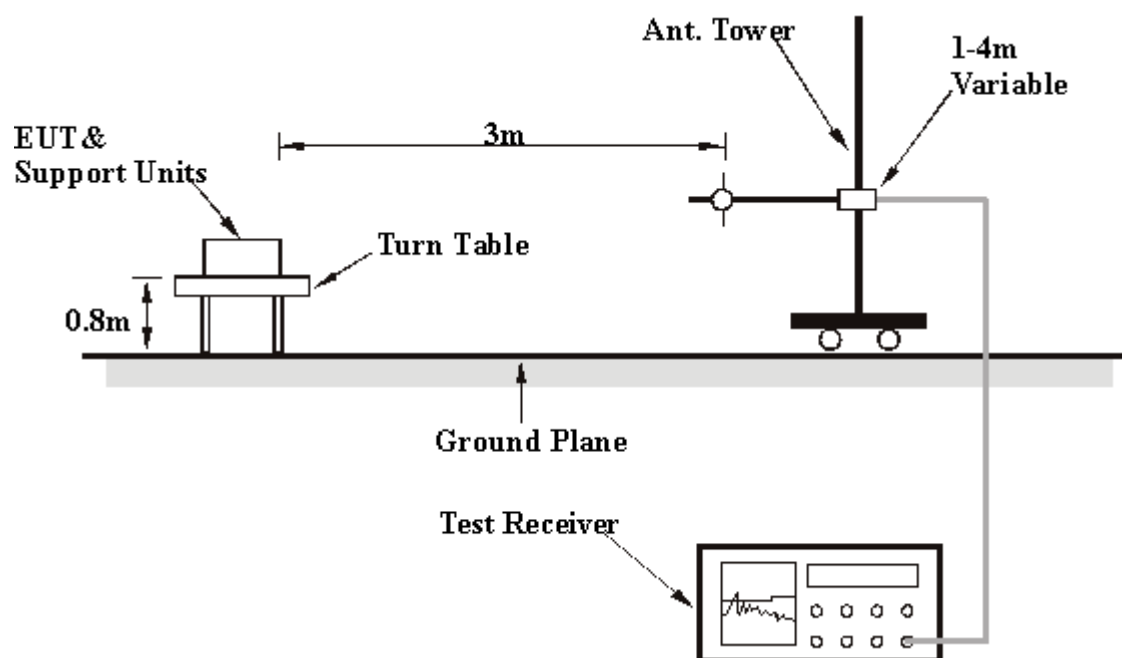

For the actual test configuration, please refer to the related item – Photographs of the Test Configuration.

4.2.6 EUT OPERATING CONDITIONS

Same as 4.1.6

4.2.7 TEST RESULTS

BELOW 1GHz WORST-CASE DATA 802.11g OFDM MODULATION – DUAL TX:

EUT TEST CONDITION		MEASUREMENT DETAIL	
CHANNEL	Channel 1	FREQUENCY RANGE	Below 1000MHz
MODULATION TYPE	BPSK for 802.11g	INPUT POWER (SYSTEM)	120Vac, 60 Hz
TRANSFER RATE	6.0Mbps	DETECTOR FUNCTION	Quasi-Peak
ENVIRONMENTAL CONDITIONS	27deg. C, 68% RH, 991hPa	TESTED BY	Match Tsui

ANTENNA POLARITY & TEST DISTANCE: HORIZONTAL AT 3 M								
NO.	FREQ. (MHz)	EMISSION LEVEL (dBuV/m)	LIMIT (dBuV/m)	MARGIN (dB)	ANTENNA HEIGHT (m)	TABLE ANGLE (Degree)	RAW VALUE (dBuV)	CORRECTION FACTOR (dB/m)
1	480.98	34.63 QP	46.00	-11.37	1.00 H	85	14.99	19.64
2	539.30	32.83 QP	46.00	-13.17	2.50 H	310	11.90	20.93
3	572.34	34.30 QP	46.00	-11.70	2.50 H	310	12.55	21.75
4	599.56	38.16 QP	46.00	-7.84	1.50 H	358	15.69	22.48
5	626.77	34.81 QP	46.00	-11.19	2.50 H	280	12.03	22.78
6	681.20	37.75 QP	46.00	-8.25	1.50 H	265	14.03	23.72
7	690.92	34.95 QP	46.00	-11.05	1.00 H	52	11.01	23.94

- REMARKS:**
1. Emission level (dBuV/m) = Raw Value (dBuV) + Correction Factor (dB/m).
 2. Correction Factor (dB/m) = Antenna Factor (dB/m) + Cable Factor (dB).
 3. The other emission levels were very low against the limit.
 4. Margin value = Emission level – Limit value.

EUT TEST CONDITION		MEASUREMENT DETAIL	
CHANNEL	Channel 1	FREQUENCY RANGE	Below 1000MHz
MODULATION TYPE	BPSK for 802.11g	INPUT POWER (SYSTEM)	120Vac, 60 Hz
TRANSFER RATE	6.0Mbps	DETECTOR FUNCTION	Quasi-Peak
ENVIRONMENTAL CONDITIONS	27deg. C, 68% RH, 991hPa	TESTED BY	Match Tsui

ANTENNA POLARITY & TEST DISTANCE: VERTICAL AT 3 M								
NO.	FREQ. (MHz)	EMISSION LEVEL (dBuV/m)	LIMIT (dBuV/m)	MARGIN (dB)	ANTENNA HEIGHT (m)	TABLE ANGLE (Degree)	RAW VALUE (dBuV)	CORRECTION FACTOR (dB/m)
1	39.72	28.52 QP	40.00	-11.48	2.50 V	304	14.15	14.37
2	399.34	34.15 QP	46.00	-11.85	1.00 V	64	16.23	17.92
3	482.93	37.90 QP	46.00	-8.10	1.00 V	88	18.22	19.68
4	506.25	33.49 QP	46.00	-12.51	2.50 V	100	13.29	20.20
5	537.35	33.50 QP	46.00	-12.50	1.00 V	253	12.61	20.88
6	574.29	34.20 QP	46.00	-11.80	1.00 V	358	12.39	21.81
7	599.56	38.31 QP	46.00	-7.69	1.00 V	79	15.84	22.48
8	642.32	36.32 QP	46.00	-9.68	1.00 V	55	13.37	22.94
9	681.20	39.42 QP	46.00	-6.58	1.00 V	88	15.70	23.72
10	690.92	36.22 QP	46.00	-9.78	1.00 V	184	12.28	23.94
11	949.46	33.21 QP	46.00	-12.79	2.50 V	304	3.82	29.39

- REMARKS:**
1. Emission level (dBuV/m) = Raw Value (dBuV) + Correction Factor (dB/m).
 2. Correction Factor (dB/m) = Antenna Factor (dB/m) + Cable Factor (dB).
 3. The other emission levels were very low against the limit.
 4. Margin value = Emission level – Limit value.

DRAFT 802.11N (20MHz) OFDM MODULATION – DUAL TX:

EUT TEST CONDITION		MEASUREMENT DETAIL	
CHANNEL	Channel 1	FREQUENCY RANGE	Below 1000MHz
MODULATION TYPE	BPSK for draft 802.11n (20MHz)	INPUT POWER (SYSTEM)	120Vac, 60 Hz
TRANSFER RATE	7.2Mbps	DETECTOR FUNCTION	Quasi-Peak
ENVIRONMENTAL CONDITIONS	27deg. C, 68% RH, 991hPa	TESTED BY	Match Tsui

ANTENNA POLARITY & TEST DISTANCE: HORIZONTAL AT 3 M								
NO.	FREQ. (MHz)	EMISSION LEVEL (dBuV/m)	LIMIT (dBuV/m)	MARGIN (dB)	ANTENNA HEIGHT (m)	TABLE ANGLE (Degree)	RAW VALUE (dBuV)	CORRECTION FACTOR (dB/m)
1	399.34	32.68 QP	46.00	-13.32	1.00 H	181	14.76	17.92
2	480.98	33.13 QP	46.00	-12.87	2.00 H	259	13.49	19.64
3	539.30	32.90 QP	46.00	-13.10	1.50 H	238	11.97	20.93
4	572.34	33.25 QP	46.00	-12.75	1.50 H	238	11.50	21.75
5	599.56	38.07 QP	46.00	-7.93	1.00 H	112	15.59	22.48
6	640.38	33.39 QP	46.00	-12.61	2.50 H	154	10.46	22.92
7	681.20	37.45 QP	46.00	-8.55	2.00 H	124	13.73	23.72
8	698.70	34.14 QP	46.00	-11.86	1.00 H	112	10.03	24.11

- REMARKS:**
1. Emission level (dBuV/m) = Raw Value (dBuV) + Correction Factor (dB/m).
 2. Correction Factor (dB/m) = Antenna Factor (dB/m) + Cable Factor (dB).
 3. The other emission levels were very low against the limit.
 4. Margin value = Emission level – Limit value.

EUT TEST CONDITION		MEASUREMENT DETAIL	
CHANNEL	Channel 1	FREQUENCY RANGE	Below 1000MHz
MODULATION TYPE	BPSK for draft 802.11n (20MHz)	INPUT POWER (SYSTEM)	120Vac, 60 Hz
TRANSFER RATE	7.2Mbps	DETECTOR FUNCTION	Quasi-Peak
ENVIRONMENTAL CONDITIONS	27deg. C, 68% RH, 991hPa	TESTED BY	Match Tsui

ANTENNA POLARITY & TEST DISTANCE: VERTICAL AT 3 M								
NO.	FREQ. (MHz)	EMISSION LEVEL (dBuV/m)	LIMIT (dBuV/m)	MARGIN (dB)	ANTENNA HEIGHT (m)	TABLE ANGLE (Degree)	RAW VALUE (dBuV)	CORRECTION FACTOR (dB/m)
1	399.34	35.38 QP	46.00	-10.62	1.00 V	163	17.46	17.92
2	488.76	38.83 QP	46.00	-7.17	1.00 V	58	19.02	19.81
3	512.08	33.71 QP	46.00	-12.29	1.00 V	223	13.38	20.33
4	539.30	35.28 QP	46.00	-10.72	1.50 V	313	14.36	20.93
5	570.40	33.97 QP	46.00	-12.03	1.00 V	241	12.27	21.70
6	599.56	38.35 QP	46.00	-7.65	1.00 V	205	15.87	22.48
7	642.32	33.04 QP	46.00	-12.96	1.00 V	277	10.09	22.94
8	681.20	38.58 QP	46.00	-7.42	2.00 V	40	14.86	23.72
9	698.70	35.75 QP	46.00	-10.25	1.00 V	205	11.64	24.11
10	939.74	32.59 QP	46.00	-13.41	1.00 V	169	3.65	28.94

- REMARKS:**
1. Emission level (dBuV/m) = Raw Value (dBuV) + Correction Factor (dB/m).
 2. Correction Factor (dB/m) = Antenna Factor (dB/m) + Cable Factor (dB).
 3. The other emission levels were very low against the limit.
 4. Margin value = Emission level – Limit value.

DRAFT 802.11n (40MHz) OFDM MODULATION – DUAL TX:

EUT TEST CONDITION		MEASUREMENT DETAIL	
CHANNEL	Channel 1	FREQUENCY RANGE	Below 1000MHz
MODULATION TYPE	BPSK for draft 802.11n (40MHz)	INPUT POWER (SYSTEM)	120Vac, 60 Hz
TRANSFER RATE	15.0Mbps	DETECTOR FUNCTION	Quasi-Peak
ENVIRONMENTAL CONDITIONS	27deg. C, 68% RH, 991hPa	TESTED BY	Match Tsui

ANTENNA POLARITY & TEST DISTANCE: HORIZONTAL AT 3 M								
NO.	FREQ. (MHz)	EMISSION LEVEL (dBuV/m)	LIMIT (dBuV/m)	MARGIN (dB)	ANTENNA HEIGHT (m)	TABLE ANGLE (Degree)	RAW VALUE (dBuV)	CORRECTION FACTOR (dB/m)
1	399.34	32.17 QP	46.00	-13.83	1.00 H	160	14.26	17.92
2	480.98	33.54 QP	46.00	-12.46	1.00 H	49	13.89	19.64
3	539.30	32.57 QP	46.00	-13.43	1.50 H	340	11.64	20.93
4	572.34	34.01 QP	46.00	-11.99	1.50 H	340	12.26	21.75
5	599.56	38.97 QP	46.00	-7.03	1.00 H	322	16.50	22.48
6	638.44	33.02 QP	46.00	-12.98	1.50 H	340	10.11	22.90
7	681.20	37.74 QP	46.00	-8.26	2.50 H	61	14.02	23.72

- REMARKS:**
1. Emission level (dBuV/m) = Raw Value (dBuV) + Correction Factor (dB/m).
 2. Correction Factor (dB/m) = Antenna Factor (dB/m) + Cable Factor (dB).
 3. The other emission levels were very low against the limit.
 4. Margin value = Emission level – Limit value.

EUT TEST CONDITION		MEASUREMENT DETAIL	
CHANNEL	Channel 1	FREQUENCY RANGE	Below 1000MHz
MODULATION TYPE	BPSK for draft 802.11n (40MHz)	INPUT POWER (SYSTEM)	120Vac, 60 Hz
TRANSFER RATE	15.0Mbps	DETECTOR FUNCTION	Quasi-Peak
ENVIRONMENTAL CONDITIONS	27deg. C, 68% RH, 991hPa	TESTED BY	Match Tsui

ANTENNA POLARITY & TEST DISTANCE: VERTICAL AT 3 M								
NO.	FREQ. (MHz)	EMISSION LEVEL (dBuV/m)	LIMIT (dBuV/m)	MARGIN (dB)	ANTENNA HEIGHT (m)	TABLE ANGLE (Degree)	RAW VALUE (dBuV)	CORRECTION FACTOR (dB/m)
1	399.34	36.00 QP	46.00	-10.00	1.00 V	118	18.08	17.92
2	480.98	36.06 QP	46.00	-9.94	1.00 V	103	16.42	19.64
3	496.53	36.39 QP	46.00	-9.61	1.00 V	253	16.40	19.99
4	537.35	33.11 QP	46.00	-12.89	1.00 V	208	12.23	20.88
5	572.34	35.48 QP	46.00	-10.52	1.00 V	340	13.73	21.75
6	599.56	38.47 QP	46.00	-7.53	1.00 V	103	16.00	22.48
7	642.32	32.89 QP	46.00	-13.11	1.00 V	337	9.95	22.94
8	681.20	38.67 QP	46.00	-7.33	1.00 V	103	14.95	23.72
9	690.92	35.65 QP	46.00	-10.35	1.00 V	169	11.72	23.94
10	949.46	33.87 QP	46.00	-12.13	1.50 V	319	4.48	29.39

- REMARKS:**
1. Emission level (dBuV/m) = Raw Value (dBuV) + Correction Factor (dB/m).
 2. Correction Factor (dB/m) = Antenna Factor (dB/m) + Cable Factor (dB).
 3. The other emission levels were very low against the limit.
 4. Margin value = Emission level – Limit value.

802.11b DSSS MODULATION – DUAL TX:

EUT TEST CONDITION		MEASUREMENT DETAIL	
CHANNEL	Channel 1	FREQUENCY RANGE	1 ~ 25GHz
MODULATION TYPE	DBPSK	INPUT POWER (SYSTEM)	120Vac, 60 Hz
TRANSFER RATE	1.0Mbps	DETECTOR FUNCTION	Peak(PK) Average (AV)
ENVIRONMENTAL CONDITIONS	27deg. C, 61% RH, 991hPa	TESTED BY	Match Tsui

ANTENNA POLARITY & TEST DISTANCE: HORIZONTAL AT 3 M

NO.	FREQ. (MHz)	EMISSION LEVEL (dBuV/m)	LIMIT (dBuV/m)	MARGIN (dB)	ANTENNA HEIGHT (m)	TABLE ANGLE (Degree)	RAW VALUE (dBuV)	CORRECTION FACTOR (dB/m)
1	2386.00	53.44 PK	74.00	-20.56	1.00 H	300	22.07	31.37
1	2386.00	45.68 AV	54.00	-8.32	1.00 H	300	14.31	31.37
2	*2412.00	101.19 PK			1.00 H	300	69.73	31.46
2	*2412.00	98.35 AV			1.00 H	300	66.89	31.46
3	4824.00	48.00 PK	74.00	-26.00	1.05 H	37	10.87	37.13
3	4824.00	39.45 AV	54.00	-14.55	1.05 H	37	2.32	37.13

ANTENNA POLARITY & TEST DISTANCE: VERTICAL AT 3 M

NO.	FREQ. (MHz)	EMISSION LEVEL (dBuV/m)	LIMIT (dBuV/m)	MARGIN (dB)	ANTENNA HEIGHT (m)	TABLE ANGLE (Degree)	RAW VALUE (dBuV)	CORRECTION FACTOR (dB/m)
1	2386.00	60.14 PK	74.00	-13.86	1.31 V	6	28.77	31.37
1	2386.00	51.74 AV	54.00	-2.26	1.31 V	5	20.37	31.37
2	*2412.00	110.91 PK			1.04 V	33	79.45	31.46
2	*2412.00	106.81 AV			1.04 V	33	75.35	31.46
3	4824.00	48.36 PK	74.00	-25.64	1.13 V	360	11.23	37.13
3	4824.00	40.66 AV	54.00	-13.34	1.13 V	360	3.53	37.13
4	7236.00	56.26 PK	90.91	-34.65	1.09 V	29	11.72	44.54
4	7236.00	47.31 AV	86.81	-39.50	1.09 V	29	2.77	44.54
5	9648.00	57.72 PK	90.91	-33.19	1.27 V	171	10.15	47.57
5	9648.00	49.70 AV	86.81	-37.11	1.27 V	171	2.13	47.57

- REMARKS:**
1. Emission level (dBuV/m) = Raw Value (dBuV) + Correction Factor (dB/m).
 2. Correction Factor (dB/m) = Antenna Factor (dB/m) + Cable Factor (dB).
 3. The other emission levels were very low against the limit.
 4. Margin value = Emission level – Limit value.
 5. The limit value is defined as per 15.247.
 6. “ * “: Fundamental frequency.

EUT TEST CONDITION		MEASUREMENT DETAIL	
CHANNEL	Channel 6	FREQUENCY RANGE	1 ~ 25GHz
MODULATION TYPE	DBPSK	INPUT POWER (SYSTEM)	120Vac, 60 Hz
TRANSFER RATE	1.0Mbps	DETECTOR FUNCTION	Peak(PK) Average (AV)
ENVIRONMENTAL CONDITIONS	27deg. C, 61% RH, 991hPa	TESTED BY	Match Tsui

ANTENNA POLARITY & TEST DISTANCE: HORIZONTAL AT 3 M								
NO.	FREQ. (MHz)	EMISSION LEVEL (dBuV/m)	LIMIT (dBuV/m)	MARGIN (dB)	ANTENNA HEIGHT (m)	TABLE ANGLE (Degree)	RAW VALUE (dBuV)	CORRECTION FACTOR (dB/m)
1	*2437.00	105.62 PK			1.49 H	284	74.08	31.54
1	*2437.00	102.76 AV			1.49 H	284	71.22	31.54
2	4874.00	46.31 PK	74.00	-27.69	1.09 H	331	9.02	37.29
2	4874.00	36.70 AV	54.00	-17.30	1.09 H	331	-0.59	37.29

ANTENNA POLARITY & TEST DISTANCE: VERTICAL AT 3 M								
NO.	FREQ. (MHz)	EMISSION LEVEL (dBuV/m)	LIMIT (dBuV/m)	MARGIN (dB)	ANTENNA HEIGHT (m)	TABLE ANGLE (Degree)	RAW VALUE (dBuV)	CORRECTION FACTOR (dB/m)
1	*2437.00	114.50 PK			1.00 V	49	82.96	31.54
1	*2437.00	110.53 AV			1.00 V	49	78.99	31.54
2	4874.00	48.48 PK	74.00	-25.52	1.18 V	18	11.19	37.29
2	4874.00	41.00 AV	54.00	-13.00	1.18 V	18	3.71	37.29
3	7311.00	60.40 PK	74.00	-13.60	1.21 V	286	15.62	44.79
3	7311.00	52.92 AV	54.00	-1.08	1.21 V	286	8.13	44.79
4	9748.00	62.21 PK	94.50	-32.29	1.19 V	10	14.39	47.82
4	9748.00	57.67 AV	90.53	-32.86	1.19 V	10	9.85	47.82

- REMARKS:**
1. Emission level (dBuV/m) = Raw Value (dBuV) + Correction Factor (dB/m).
 2. Correction Factor (dB/m) = Antenna Factor (dB/m) + Cable Factor (dB).
 3. The other emission levels were very low against the limit.
 4. Margin value = Emission level – Limit value.
 5. The limit value is defined as per 15.247.
 6. “ * “: Fundamental frequency.

EUT TEST CONDITION		MEASUREMENT DETAIL	
CHANNEL	Channel 11	FREQUENCY RANGE	1 ~ 25GHz
MODULATION TYPE	DBPSK	INPUT POWER (SYSTEM)	120Vac, 60 Hz
TRANSFER RATE	1.0Mbps	DETECTOR FUNCTION	Peak(PK) Average (AV)
ENVIRONMENTAL CONDITIONS	27deg. C, 61% RH, 991hPa	TESTED BY	Match Tsui

ANTENNA POLARITY & TEST DISTANCE: HORIZONTAL AT 3 M								
NO.	FREQ. (MHz)	EMISSION LEVEL (dBuV/m)	LIMIT (dBuV/m)	MARGIN (dB)	ANTENNA HEIGHT (m)	TABLE ANGLE (Degree)	RAW VALUE (dBuV)	CORRECTION FACTOR (dB/m)
1	*2462.00	103.56 PK			1.50 H	301	71.94	31.62
1	*2462.00	100.47 AV			1.50 H	301	68.85	31.62
2	2488.00	56.24 PK	74.00	-17.76	1.50 H	301	24.53	31.71
2	2488.00	48.13 AV	54.00	-5.87	1.50 H	301	16.42	31.71
3	4924.00	44.75 PK	74.00	-29.25	1.22 H	294	7.31	37.44
3	4924.00	33.49 AV	54.00	-20.51	1.22 H	294	-3.95	37.44

ANTENNA POLARITY & TEST DISTANCE: VERTICAL AT 3 M								
NO.	FREQ. (MHz)	EMISSION LEVEL (dBuV/m)	LIMIT (dBuV/m)	MARGIN (dB)	ANTENNA HEIGHT (m)	TABLE ANGLE (Degree)	RAW VALUE (dBuV)	CORRECTION FACTOR (dB/m)
1	*2462.00	110.15 PK			1.22 V	29	78.53	31.62
1	*2462.00	106.13 AV			1.22 V	29	74.51	31.62
2	2487.50	59.77 PK	74.00	-14.23	1.25 V	43	28.06	31.71
2	2487.50	52.60 AV	54.00	-1.40	1.25 V	43	20.89	31.71
3	4924.00	47.44 PK	74.00	-26.56	1.23 V	198	10.00	37.44
3	4924.00	36.59 AV	54.00	-17.41	1.23 V	198	-0.85	37.44
4	7386.00	58.57 PK	74.00	-15.43	1.02 V	337	13.67	44.90
4	7386.00	52.26 AV	54.00	-1.74	1.02 V	337	7.36	44.90
5	9848.00	61.51 PK	90.15	-28.64	1.11 V	12	13.45	48.06
5	9848.00	55.34 AV	86.13	-30.79	1.11 V	12	7.28	48.06

- REMARKS:**
1. Emission level (dBuV/m) = Raw Value (dBuV) + Correction Factor (dB/m).
 2. Correction Factor (dB/m) = Antenna Factor (dB/m) + Cable Factor (dB).
 3. The other emission levels were very low against the limit.
 4. Margin value = Emission level – Limit value.
 5. The limit value is defined as per 15.247.
 6. “ * “: Fundamental frequency.

802.11g OFDM MODULATION – DUAL TX:

EUT TEST CONDITION		MEASUREMENT DETAIL	
CHANNEL	Channel 1	FREQUENCY RANGE	1 ~ 25GHz
MODULATION TYPE	BPSK	INPUT POWER (SYSTEM)	120Vac, 60 Hz
TRANSFER RATE	6.0Mbps	DETECTOR FUNCTION	Peak(PK) Average (AV)
ENVIRONMENTAL CONDITIONS	27deg. C, 61% RH, 991hPa	TESTED BY	Match Tsui

ANTENNA POLARITY & TEST DISTANCE: HORIZONTAL AT 3 M								
NO.	FREQ. (MHz)	EMISSION LEVEL (dBuV/m)	LIMIT (dBuV/m)	MARGIN (dB)	ANTENNA HEIGHT (m)	TABLE ANGLE (Degree)	RAW VALUE (dBuV)	CORRECTION FACTOR (dB/m)
1	2390.00	61.65 PK	74.00	-12.35	1.00 H	36	30.26	31.39
1	2390.00	48.06 AV	54.00	-5.94	1.00 H	36	16.67	31.39
2	*2412.00	102.04 PK			1.00 H	27	70.58	31.46
2	*2412.00	91.00 AV			1.00 H	27	59.54	31.46
3	4824.00	45.46 PK	74.00	-28.54	1.04 H	360	8.33	37.13
3	4824.00	33.29 AV	54.00	-20.71	1.04 H	360	-3.84	37.13

ANTENNA POLARITY & TEST DISTANCE: VERTICAL AT 3 M								
NO.	FREQ. (MHz)	EMISSION LEVEL (dBuV/m)	LIMIT (dBuV/m)	MARGIN (dB)	ANTENNA HEIGHT (m)	TABLE ANGLE (Degree)	RAW VALUE (dBuV)	CORRECTION FACTOR (dB/m)
1	2390.00	70.10 PK	74.00	-3.90	1.31 V	28	38.71	31.39
1	2390.00	52.31 AV	54.00	-1.69	1.31 V	28	20.92	31.39
2	*2412.00	112.14 PK			1.04 V	32	80.68	31.46
2	*2412.00	100.29 AV			1.04 V	32	68.83	31.46
3	4824.00	45.73 PK	74.00	-28.27	1.04 V	1	8.60	37.13
3	4824.00	33.36 AV	54.00	-20.64	1.04 V	1	-3.77	37.13

- REMARKS:**
1. Emission level (dBuV/m) = Raw Value (dBuV) + Correction Factor (dB/m).
 2. Correction Factor (dB/m) = Antenna Factor (dB/m) + Cable Factor (dB).
 3. The other emission levels were very low against the limit.
 4. Margin value = Emission level – Limit value.
 5. The limit value is defined as per 15.247.
 6. “ * “: Fundamental frequency.

EUT TEST CONDITION		MEASUREMENT DETAIL	
CHANNEL	Channel 6	FREQUENCY RANGE	1 ~ 25GHz
MODULATION TYPE	BPSK	INPUT POWER (SYSTEM)	120Vac, 60 Hz
TRANSFER RATE	6.0Mbps	DETECTOR FUNCTION	Peak(PK) Average (AV)
ENVIRONMENTAL CONDITIONS	27deg. C, 61% RH, 991hPa	TESTED BY	Match Tsui

ANTENNA POLARITY & TEST DISTANCE: HORIZONTAL AT 3 M								
NO.	FREQ. (MHz)	EMISSION LEVEL (dBuV/m)	LIMIT (dBuV/m)	MARGIN (dB)	ANTENNA HEIGHT (m)	TABLE ANGLE (Degree)	RAW VALUE (dBuV)	CORRECTION FACTOR (dB/m)
1	*2437.00	106.27 PK			1.00 H	302	74.73	31.54
1	*2437.00	95.40 AV			1.00 H	302	63.86	31.54
2	4874.00	46.18 PK	74.00	-27.82	1.21 H	0	8.89	37.29
2	4874.00	32.85 AV	54.00	-21.15	1.21 H	0	-4.44	37.29

ANTENNA POLARITY & TEST DISTANCE: VERTICAL AT 3 M								
NO.	FREQ. (MHz)	EMISSION LEVEL (dBuV/m)	LIMIT (dBuV/m)	MARGIN (dB)	ANTENNA HEIGHT (m)	TABLE ANGLE (Degree)	RAW VALUE (dBuV)	CORRECTION FACTOR (dB/m)
1	*2437.00	114.90 PK			1.48 V	152	83.36	31.54
1	*2437.00	102.95 AV			1.48 V	152	71.41	31.54
2	2483.50	57.82 PK	74.00	-16.18	1.48 V	152	26.12	31.70
2	2483.50	48.60 AV	54.00	-5.40	1.48 V	152	16.90	31.70
3	4874.00	45.99 PK	74.00	-28.01	1.48 V	360	8.70	37.29
3	4874.00	33.28 AV	54.00	-20.72	1.48 V	360	-4.01	37.29

- REMARKS:**
1. Emission level (dBuV/m) = Raw Value (dBuV) + Correction Factor (dB/m).
 2. Correction Factor (dB/m) = Antenna Factor (dB/m) + Cable Factor (dB).
 3. The other emission levels were very low against the limit.
 4. Margin value = Emission level – Limit value.
 5. The limit value is defined as per 15.247.
 6. “ * “: Fundamental frequency.

EUT TEST CONDITION		MEASUREMENT DETAIL	
CHANNEL	Channel 11	FREQUENCY RANGE	1 ~ 25GHz
MODULATION TYPE	BPSK	INPUT POWER (SYSTEM)	120Vac, 60 Hz
TRANSFER RATE	6.0Mbps	DETECTOR FUNCTION	Peak(PK) Average (AV)
ENVIRONMENTAL CONDITIONS	27deg. C, 68% RH, 991hPa	TESTED BY	Match Tsui

ANTENNA POLARITY & TEST DISTANCE: HORIZONTAL AT 3 M								
NO.	FREQ. (MHz)	EMISSION LEVEL (dBuV/m)	LIMIT (dBuV/m)	MARGIN (dB)	ANTENNA HEIGHT (m)	TABLE ANGLE (Degree)	RAW VALUE (dBuV)	CORRECTION FACTOR (dB/m)
1	*2462.00	101.01 PK			1.52 H	301	69.39	31.62
1	*2462.00	91.72 AV			1.52 H	301	60.10	31.62
2	2483.50	64.54 PK	74.00	-9.46	1.52 H	301	32.84	31.70
2	2483.50	49.45 AV	54.00	-4.55	1.52 H	301	17.75	31.70
3	4924.00	46.69 PK	74.00	-27.31	1.00 H	360	9.25	37.44
3	4924.00	33.33 AV	54.00	-20.67	1.00 H	360	-4.11	37.44

ANTENNA POLARITY & TEST DISTANCE: VERTICAL AT 3 M								
NO.	FREQ. (MHz)	EMISSION LEVEL (dBuV/m)	LIMIT (dBuV/m)	MARGIN (dB)	ANTENNA HEIGHT (m)	TABLE ANGLE (Degree)	RAW VALUE (dBuV)	CORRECTION FACTOR (dB/m)
1	*2462.00	110.47 PK			1.03 V	17	78.85	31.62
1	*2462.00	99.40 AV			1.03 V	17	67.78	31.62
2	2483.50	71.65 PK	74.00	-2.35	1.03 V	7	39.95	31.70
2	2483.50	52.32 AV	54.00	-1.68	1.03 V	7	20.62	31.70
3	4924.00	46.44 PK	74.00	-27.56	1.03 V	0	9.00	37.44
3	4924.00	33.66 AV	54.00	-20.34	1.03 V	0	-3.78	37.44

- REMARKS:**
1. Emission level (dBuV/m) = Raw Value (dBuV) + Correction Factor (dB/m).
 2. Correction Factor (dB/m) = Antenna Factor (dB/m) + Cable Factor (dB).
 3. The other emission levels were very low against the limit.
 4. Margin value = Emission level – Limit value.
 5. The limit value is defined as per 15.247.
 6. “ * “: Fundamental frequency.

DRAFT 802.11n (20MHz) OFDM MODULATION – DUAL TX:

EUT TEST CONDITION		MEASUREMENT DETAIL	
CHANNEL	Channel 1	FREQUENCY RANGE	1 ~ 25GHz
MODULATION TYPE	BPSK	INPUT POWER (SYSTEM)	120Vac, 60 Hz
TRANSFER RATE	7.2Mbps	DETECTOR FUNCTION	Peak(PK) Average (AV)
ENVIRONMENTAL CONDITIONS	27deg. C, 61% RH, 991hPa	TESTED BY	Match Tsui

ANTENNA POLARITY & TEST DISTANCE: HORIZONTAL AT 3 M								
NO.	FREQ. (MHz)	EMISSION LEVEL (dBuV/m)	LIMIT (dBuV/m)	MARGIN (dB)	ANTENNA HEIGHT (m)	TABLE ANGLE (Degree)	RAW VALUE (dBuV)	CORRECTION FACTOR (dB/m)
1	2390.00	59.81 PK	74.00	-14.19	1.53 H	301	28.42	31.39
1	2390.00	47.54 AV	54.00	-6.46	1.53 H	301	16.15	31.39
2	*2412.00	101.79 PK			1.53 H	301	70.33	31.46
2	*2412.00	92.44 AV			1.53 H	301	60.98	31.46
3	4824.00	46.10 PK	74.00	-27.90	1.20 H	0	8.97	37.13
3	4824.00	32.99 AV	54.00	-21.01	1.20 H	0	-4.14	37.13

ANTENNA POLARITY & TEST DISTANCE: VERTICAL AT 3 M								
NO.	FREQ. (MHz)	EMISSION LEVEL (dBuV/m)	LIMIT (dBuV/m)	MARGIN (dB)	ANTENNA HEIGHT (m)	TABLE ANGLE (Degree)	RAW VALUE (dBuV)	CORRECTION FACTOR (dB/m)
1	2390.00	66.29 PK	74.00	-7.71	1.04 V	32	34.90	31.39
1	2390.00	52.53 AV	54.00	-1.47	1.04 V	32	21.14	31.39
2	*2412.00	110.08 PK			1.04 V	31	78.62	31.46
2	*2412.00	99.01 AV			1.04 V	31	67.55	31.46
3	4824.00	46.71 PK	74.00	-27.29	1.23 V	360	9.58	37.13
3	4824.00	33.66 AV	54.00	-20.34	1.23 V	360	-3.47	37.13

- REMARKS:**
1. Emission level (dBuV/m) = Raw Value (dBuV) + Correction Factor (dB/m).
 2. Correction Factor (dB/m) = Antenna Factor (dB/m) + Cable Factor (dB).
 3. The other emission levels were very low against the limit.
 4. Margin value = Emission level – Limit value.
 5. The limit value is defined as per 15.247.
 6. “ * “: Fundamental frequency.

EUT TEST CONDITION		MEASUREMENT DETAIL	
CHANNEL	Channel 6	FREQUENCY RANGE	1 ~ 25GHz
MODULATION TYPE	BPSK	INPUT POWER (SYSTEM)	120Vac, 60 Hz
TRANSFER RATE	7.2Mbps	DETECTOR FUNCTION	Peak(PK) Average (AV)
ENVIRONMENTAL CONDITIONS	27deg. C, 61% RH, 991hPa	TESTED BY	Match Tsui

ANTENNA POLARITY & TEST DISTANCE: HORIZONTAL AT 3 M								
NO.	FREQ. (MHz)	EMISSION LEVEL (dBuV/m)	LIMIT (dBuV/m)	MARGIN (dB)	ANTENNA HEIGHT (m)	TABLE ANGLE (Degree)	RAW VALUE (dBuV)	CORRECTION FACTOR (dB/m)
1	*2437.00	106.86 PK			1.53 H	300	75.32	31.54
1	*2437.00	97.28 AV			1.53 H	300	65.74	31.54
2	4874.00	45.81 PK	74.00	-28.19	1.04 H	360	8.52	37.29
2	4874.00	33.85 AV	54.00	-20.15	1.04 H	360	-3.44	37.29

ANTENNA POLARITY & TEST DISTANCE: VERTICAL AT 3 M								
NO.	FREQ. (MHz)	EMISSION LEVEL (dBuV/m)	LIMIT (dBuV/m)	MARGIN (dB)	ANTENNA HEIGHT (m)	TABLE ANGLE (Degree)	RAW VALUE (dBuV)	CORRECTION FACTOR (dB/m)
1	*2437.00	113.85 PK			1.04 V	17	82.31	31.54
1	*2437.00	101.62 AV			1.04 V	17	70.08	31.54
2	4874.00	47.09 PK	74.00	-26.91	1.00 V	360	9.80	37.29
2	4874.00	33.85 AV	54.00	-20.15	1.00 V	360	-3.44	37.29

- REMARKS:**
1. Emission level (dBuV/m) = Raw Value (dBuV) + Correction Factor (dB/m).
 2. Correction Factor (dB/m) = Antenna Factor (dB/m) + Cable Factor (dB).
 3. The other emission levels were very low against the limit.
 4. Margin value = Emission level – Limit value.
 5. The limit value is defined as per 15.247.
 6. “ * “: Fundamental frequency.

EUT TEST CONDITION		MEASUREMENT DETAIL	
CHANNEL	Channel 11	FREQUENCY RANGE	1 ~ 25GHz
MODULATION TYPE	BPSK	INPUT POWER (SYSTEM)	120Vac, 60 Hz
TRANSFER RATE	7.2Mbps	DETECTOR FUNCTION	Peak(PK) Average (AV)
ENVIRONMENTAL CONDITIONS	27deg. C, 61% RH, 991hPa	TESTED BY	Match Tsui

ANTENNA POLARITY & TEST DISTANCE: HORIZONTAL AT 3 M								
NO.	FREQ. (MHz)	EMISSION LEVEL (dBuV/m)	LIMIT (dBuV/m)	MARGIN (dB)	ANTENNA HEIGHT (m)	TABLE ANGLE (Degree)	RAW VALUE (dBuV)	CORRECTION FACTOR (dB/m)
1	*2462.00	101.43 PK			1.75 H	300	69.81	31.62
1	*2462.00	92.61 AV			1.75 H	300	60.99	31.62
2	2483.50	64.37 PK	74.00	-9.63	1.75 H	300	32.67	31.70
2	2483.50	49.29 AV	54.00	-4.71	1.75 H	300	17.59	31.70
3	4924.00	46.36 PK	74.00	-27.64	1.00 H	0	8.92	37.44
3	4924.00	33.03 AV	54.00	-20.97	1.00 H	0	-4.41	37.44

ANTENNA POLARITY & TEST DISTANCE: VERTICAL AT 3 M								
NO.	FREQ. (MHz)	EMISSION LEVEL (dBuV/m)	LIMIT (dBuV/m)	MARGIN (dB)	ANTENNA HEIGHT (m)	TABLE ANGLE (Degree)	RAW VALUE (dBuV)	CORRECTION FACTOR (dB/m)
1	*2462.00	108.75 PK			1.04 V	1	77.13	31.62
1	*2462.00	97.10 AV			1.04 V	1	65.48	31.62
2	2483.50	71.23 PK	74.00	-2.77	1.03 V	27	39.53	31.70
2	2483.50	52.68 AV	54.00	-1.32	1.03 V	27	20.98	31.70
3	4924.00	47.36 PK	74.00	-26.64	1.10 V	359	9.92	37.44
3	4924.00	34.03 AV	54.00	-19.97	1.10 V	359	-3.41	37.44

- REMARKS:**
1. Emission level (dBuV/m) = Raw Value (dBuV) + Correction Factor (dB/m).
 2. Correction Factor (dB/m) = Antenna Factor (dB/m) + Cable Factor (dB).
 3. The other emission levels were very low against the limit.
 4. Margin value = Emission level – Limit value.
 5. The limit value is defined as per 15.247.
 6. “ * “: Fundamental frequency.

DRAFT 802.11n (40MHz) OFDM MODULATION – DUAL TX:

EUT TEST CONDITION		MEASUREMENT DETAIL	
CHANNEL	Channel 1	FREQUENCY RANGE	1 ~ 25GHz
MODULATION TYPE	BPSK	INPUT POWER (SYSTEM)	120Vac, 60 Hz
TRANSFER RATE	15.0Mbps	DETECTOR FUNCTION	Peak(PK) Average (AV)
ENVIRONMENTAL CONDITIONS	27deg. C, 61% RH, 991hPa	TESTED BY	Match Tsui

ANTENNA POLARITY & TEST DISTANCE: HORIZONTAL AT 3 M								
NO.	FREQ. (MHz)	EMISSION LEVEL (dBuV/m)	LIMIT (dBuV/m)	MARGIN (dB)	ANTENNA HEIGHT (m)	TABLE ANGLE (Degree)	RAW VALUE (dBuV)	CORRECTION FACTOR (dB/m)
1	2390.00	57.83 PK	74.00	-16.17	1.24 H	287	26.44	31.39
1	2390.00	46.93 AV	54.00	-7.07	1.24 H	287	15.54	31.39
2	*2422.00	97.31 PK			1.24 H	287	65.82	31.49
2	*2422.00	87.54 AV			1.24 H	287	56.05	31.49
3	4844.00	45.77 PK	74.00	-28.23	1.10 H	1	8.58	37.19
3	4844.00	32.64 AV	54.00	-21.36	1.10 H	1	-4.55	37.19

ANTENNA POLARITY & TEST DISTANCE: VERTICAL AT 3 M								
NO.	FREQ. (MHz)	EMISSION LEVEL (dBuV/m)	LIMIT (dBuV/m)	MARGIN (dB)	ANTENNA HEIGHT (m)	TABLE ANGLE (Degree)	RAW VALUE (dBuV)	CORRECTION FACTOR (dB/m)
1	2390.00	66.35 PK	74.00	-7.65	1.00 V	50	34.96	31.39
1	2390.00	51.81 AV	54.00	-2.19	1.00 V	50	20.42	31.39
2	*2422.00	103.83 PK			1.00 V	8	72.34	31.49
2	*2422.00	90.63 AV			1.00 V	8	59.14	31.49
3	4844.00	46.07 PK	74.00	-27.93	1.02 V	360	8.88	37.19
3	4844.00	33.62 AV	54.00	-20.38	1.02 V	360	-3.57	37.19

- REMARKS:**
1. Emission level (dBuV/m) = Raw Value (dBuV) + Correction Factor (dB/m).
 2. Correction Factor (dB/m) = Antenna Factor (dB/m) + Cable Factor (dB).
 3. The other emission levels were very low against the limit.
 4. Margin value = Emission level – Limit value.
 5. The limit value is defined as per 15.247.
 6. “ * “: Fundamental frequency.

EUT TEST CONDITION		MEASUREMENT DETAIL	
CHANNEL	Channel 4	FREQUENCY RANGE	1 ~ 25GHz
MODULATION TYPE	BPSK	INPUT POWER (SYSTEM)	120Vac, 60 Hz
TRANSFER RATE	15.0Mbps	DETECTOR FUNCTION	Peak(PK) Average (AV)
ENVIRONMENTAL CONDITIONS	27deg. C, 61% RH, 991hPa	TESTED BY	Match Tsui

ANTENNA POLARITY & TEST DISTANCE: HORIZONTAL AT 3 M								
NO.	FREQ. (MHz)	EMISSION LEVEL (dBuV/m)	LIMIT (dBuV/m)	MARGIN (dB)	ANTENNA HEIGHT (m)	TABLE ANGLE (Degree)	RAW VALUE (dBuV)	CORRECTION FACTOR (dB/m)
1	2390.00	56.64 PK	74.00	-17.36	1.51 H	302	25.25	31.39
1	2390.00	47.19 AV	54.00	-6.81	1.51 H	302	15.80	31.39
2	*2437.00	100.15 PK			1.51 H	302	68.61	31.54
2	*2437.00	90.55 AV			1.51 H	302	59.01	31.54
3	2483.50	61.64 PK	74.00	-12.36	1.51 H	302	29.94	31.70
3	2483.50	50.57 AV	54.00	-3.43	1.51 H	302	18.87	31.70
4	4874.00	37.19 PK	74.00	-36.81	1.21 H	360	-0.10	37.29
4	4874.00	32.89 AV	54.00	-21.11	1.21 H	360	-4.40	37.29

ANTENNA POLARITY & TEST DISTANCE: VERTICAL AT 3 M								
NO.	FREQ. (MHz)	EMISSION LEVEL (dBuV/m)	LIMIT (dBuV/m)	MARGIN (dB)	ANTENNA HEIGHT (m)	TABLE ANGLE (Degree)	RAW VALUE (dBuV)	CORRECTION FACTOR (dB/m)
1	2390.00	66.03 PK	74.00	-7.97	1.09 V	29	34.64	31.39
1	2390.00	51.24 AV	54.00	-2.76	1.09 V	29	19.85	31.39
2	*2437.00	106.36 PK			1.00 V	5	74.82	31.54
2	*2437.00	93.68 AV			1.00 V	5	62.14	31.54
3	2483.50	66.50 PK	74.00	-7.50	1.00 V	7	34.80	31.70
3	2483.50	52.51 AV	54.00	-1.49	1.00 V	7	20.81	31.70
4	4874.00	46.67 PK	74.00	-27.33	1.00 V	360	9.38	37.29
4	4874.00	33.85 AV	54.00	-20.15	1.00 V	360	-3.44	37.29

- REMARKS:**
1. Emission level (dBuV/m) = Raw Value (dBuV) + Correction Factor (dB/m).
 2. Correction Factor (dB/m) = Antenna Factor (dB/m) + Cable Factor (dB).
 3. The other emission levels were very low against the limit.
 4. Margin value = Emission level – Limit value.
 5. The limit value is defined as per 15.247.
 6. “ * “: Fundamental frequency.

EUT TEST CONDITION		MEASUREMENT DETAIL	
CHANNEL	Channel 7	FREQUENCY RANGE	1 ~ 25GHz
MODULATION TYPE	BPSK	INPUT POWER (SYSTEM)	120Vac, 60 Hz
TRANSFER RATE	15.0Mbps	DETECTOR FUNCTION	Peak(PK) Average (AV)
ENVIRONMENTAL CONDITIONS	27deg. C, 61% RH, 991hPa	TESTED BY	Match Tsui

ANTENNA POLARITY & TEST DISTANCE: HORIZONTAL AT 3 M								
NO.	FREQ. (MHz)	EMISSION LEVEL (dBuV/m)	LIMIT (dBuV/m)	MARGIN (dB)	ANTENNA HEIGHT (m)	TABLE ANGLE (Degree)	RAW VALUE (dBuV)	CORRECTION FACTOR (dB/m)
1	*2452.00	94.73 PK			1.52 H	301	63.14	31.59
1	*2452.00	82.66 AV			1.52 H	301	51.07	31.59
2	2483.50	57.33 PK	74.00	-16.67	1.52 H	301	25.63	31.70
2	2483.50	48.76 AV	54.00	-5.24	1.52 H	301	17.06	31.70
3	4904.00	46.29 PK	74.00	-27.71	1.11 H	0	8.91	37.38
3	4904.00	33.56 AV	54.00	-20.44	1.11 H	0	-3.82	37.38

ANTENNA POLARITY & TEST DISTANCE: VERTICAL AT 3 M								
NO.	FREQ. (MHz)	EMISSION LEVEL (dBuV/m)	LIMIT (dBuV/m)	MARGIN (dB)	ANTENNA HEIGHT (m)	TABLE ANGLE (Degree)	RAW VALUE (dBuV)	CORRECTION FACTOR (dB/m)
1	*2452.00	102.04 PK			1.03 V	360	70.45	31.59
1	*2452.00	89.44 AV			1.03 V	360	57.85	31.59
2	2483.50	64.90 PK	74.00	-9.10	1.02 V	360	33.20	31.70
2	2483.50	52.07 AV	54.00	-1.93	1.02 V	360	20.37	31.70
3	4904.00	47.00 PK	74.00	-27.00	1.07 V	360	9.62	37.38
3	4904.00	33.96 AV	54.00	-20.04	1.07 V	360	-3.42	37.38

- REMARKS:**
1. Emission level (dBuV/m) = Raw Value (dBuV) + Correction Factor (dB/m).
 2. Correction Factor (dB/m) = Antenna Factor (dB/m) + Cable Factor (dB).
 3. The other emission levels were very low against the limit.
 4. Margin value = Emission level – Limit value.
 5. The limit value is defined as per 15.247.
 6. “ * “: Fundamental frequency.



4.3 6dB BANDWIDTH MEASUREMENT

4.3.1 LIMITS OF 6dB BANDWIDTH MEASUREMENT

The minimum of 6dB Bandwidth Measurement is 0.5 MHz.

4.3.2 TEST INSTRUMENTS

DESCRIPTION & MANUFACTURER	MODEL NO.	SERIAL NO.	CALIBRATED UNTIL
SPECTRUM ANALYZER	FSEK 30	100049	Aug. 14, 2006

NOTE: The calibration interval of the above test instruments is 12 months and the calibrations are traceable to NML/ROC and NIST/USA.

4.3.3 TEST PROCEDURE

The transmitter output was connected to the spectrum analyzer through an attenuator. The bandwidth of the fundamental frequency was measured by spectrum analyzer with 100kHz RBW and 100kHz VBW. The 6dB bandwidth is defined as the total spectrum the power of which is higher than peak power minus 6dB.

4.3.4 DEVIATION FROM TEST STANDARD

No deviation

4.3.5 TEST SETUP

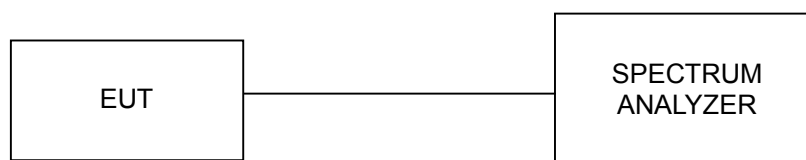

4.3.6 EUT OPERATING CONDITIONS

The software provided by client to enable the EUT under transmission condition continuously at lowest, middle and highest channel frequencies individually.

4.3.7 TEST RESULTS

802.11b DSSS MODULATION – DUAL TX:

MODULATION TYPE	DBPSK	TRANSFER RATE	1.0Mbps
INPUT POWER (SYSTEM)	120Vac, 60 Hz	ENVIRONMENTAL CONDITIONS	27deg.C, 61% RH, 991hPa
TESTED BY	Match Tsui		

CHANNEL	CHANNEL FREQUENCY (MHz)	6dB BANDWIDTH (MHz)		MINIMUM LIMIT (MHz)	PASS / FAIL
		CHAIN 0	CHAIN 1		
1	2412	12.04	12.08	0.5	PASS
6	2437	12.00	12.00	0.5	PASS
11	2462	12.04	12.04	0.5	PASS

FOR CHAIN 0: CH 1

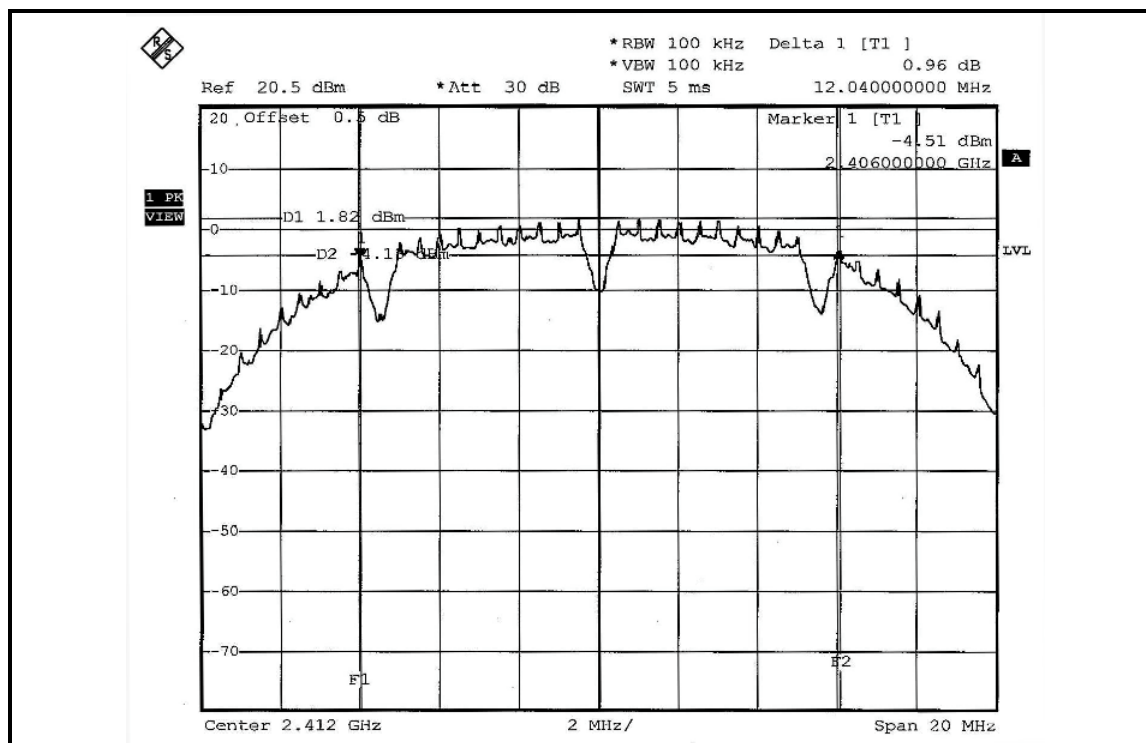

CH 6

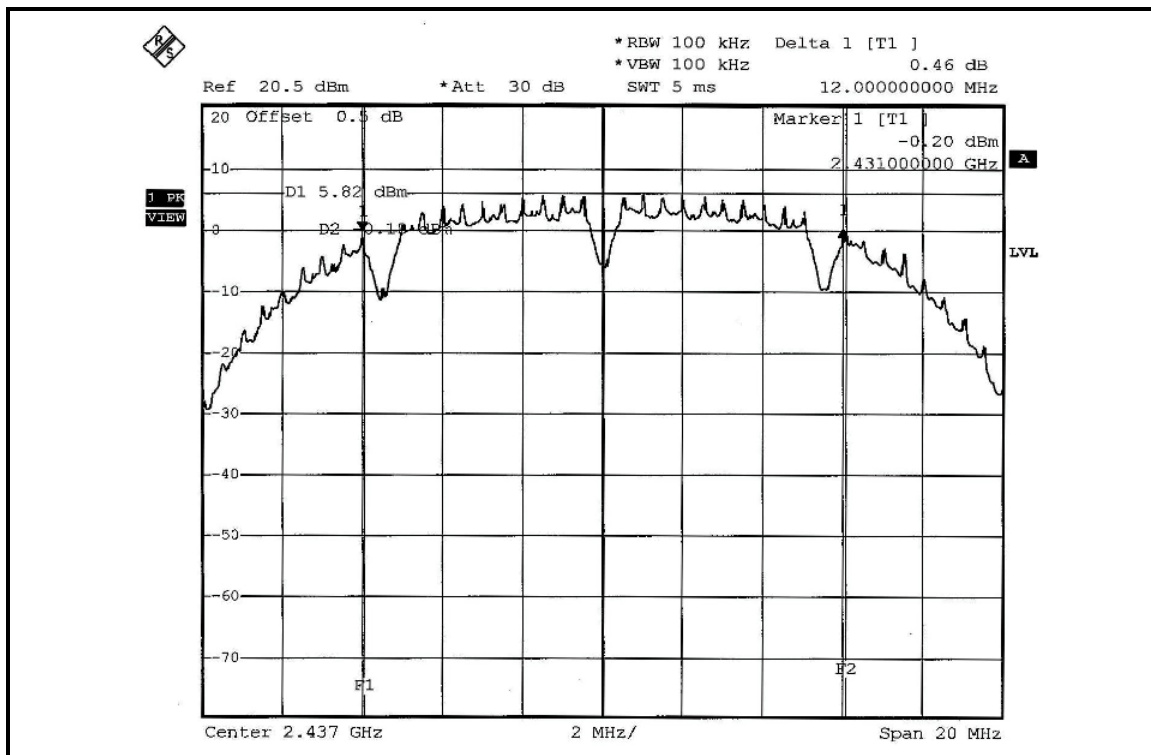

CH 11

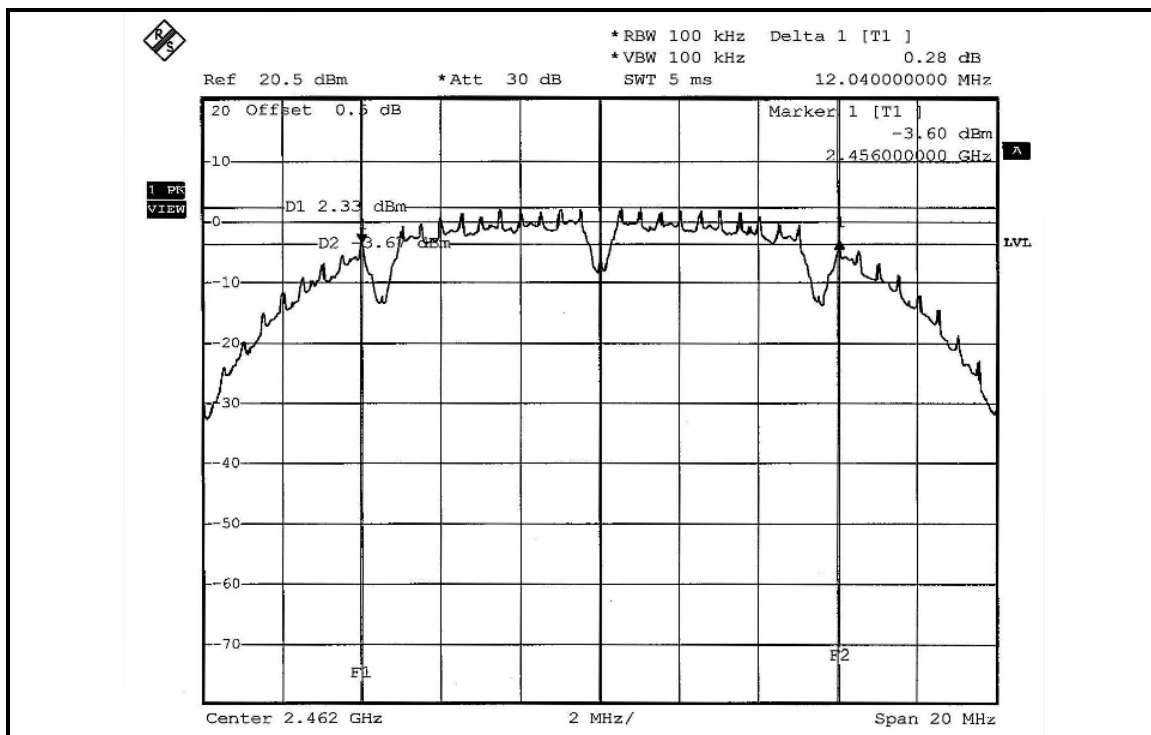

FOR CHAIN 1: CH 1

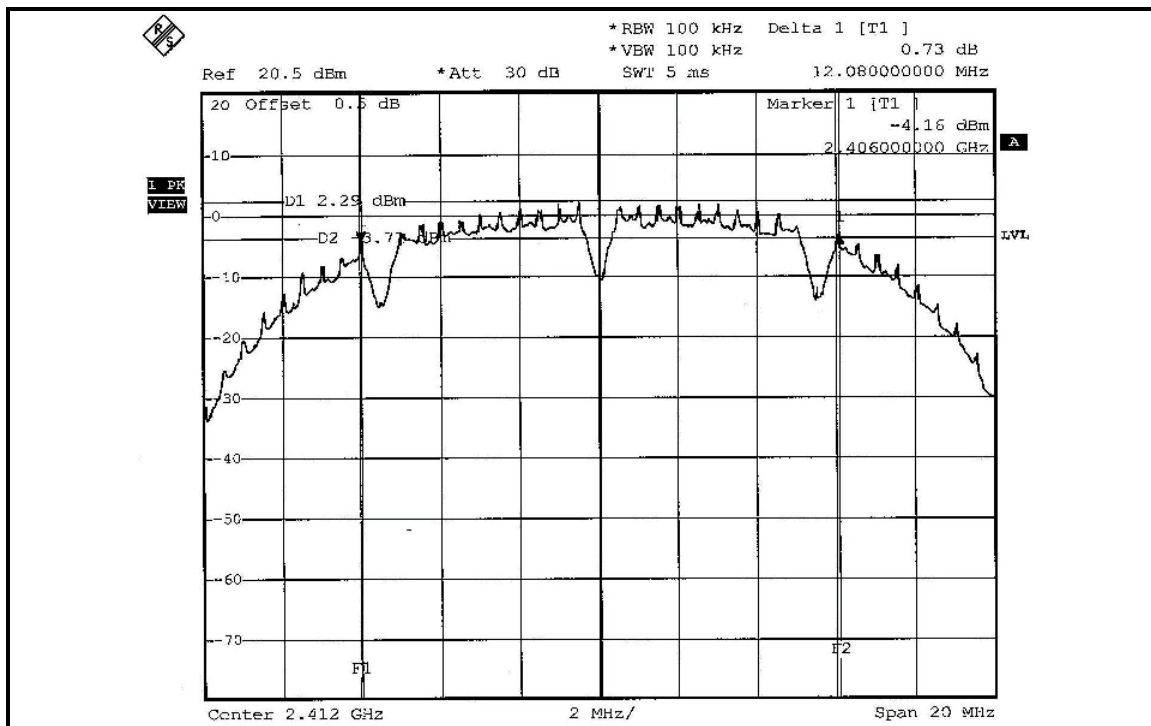

CH 6

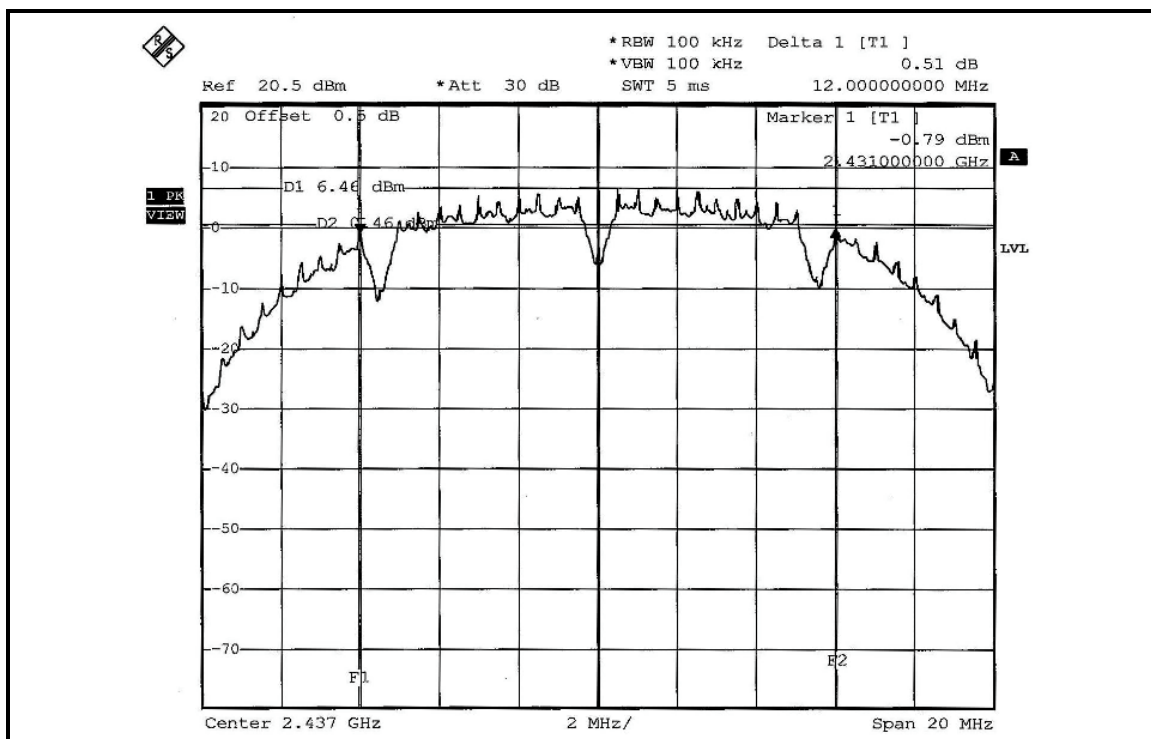

CH 11

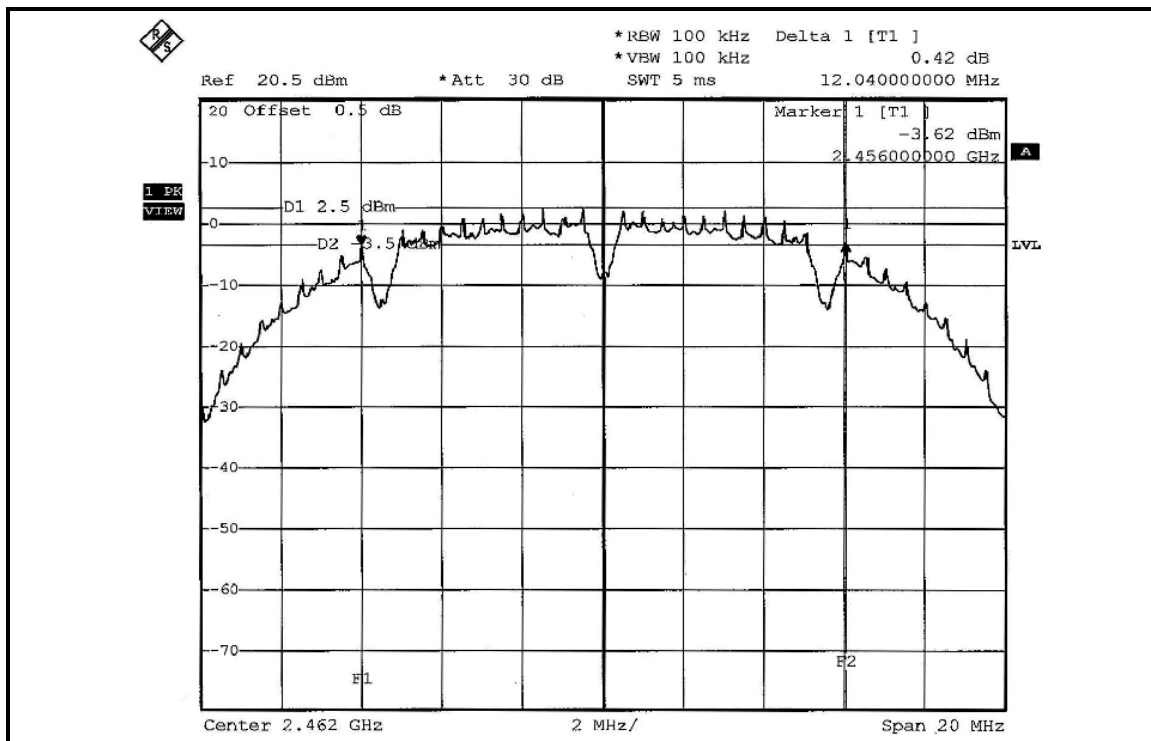

802.11g OFDM MODULATION – DUAL TX:

MODULATION TYPE	BPSK	TRANSFER RATE	6.0Mbps
INPUT POWER (SYSTEM)	120Vac, 60 Hz	ENVIRONMENTAL CONDITIONS	27deg.C, 61% RH, 991hPa
TESTED BY	Match Tsui		

CHANNEL	CHANNEL FREQUENCY (MHz)	6dB BANDWIDTH (MHz)		MINIMUM LIMIT (MHz)	PASS / FAIL
		CHAIN 0	CHAIN 1		
1	2412	16.40	16.40	0.5	PASS
6	2437	16.40	16.40	0.5	PASS
11	2462	16.40	16.40	0.5	PASS

FOR CHAIN 0: CH 1

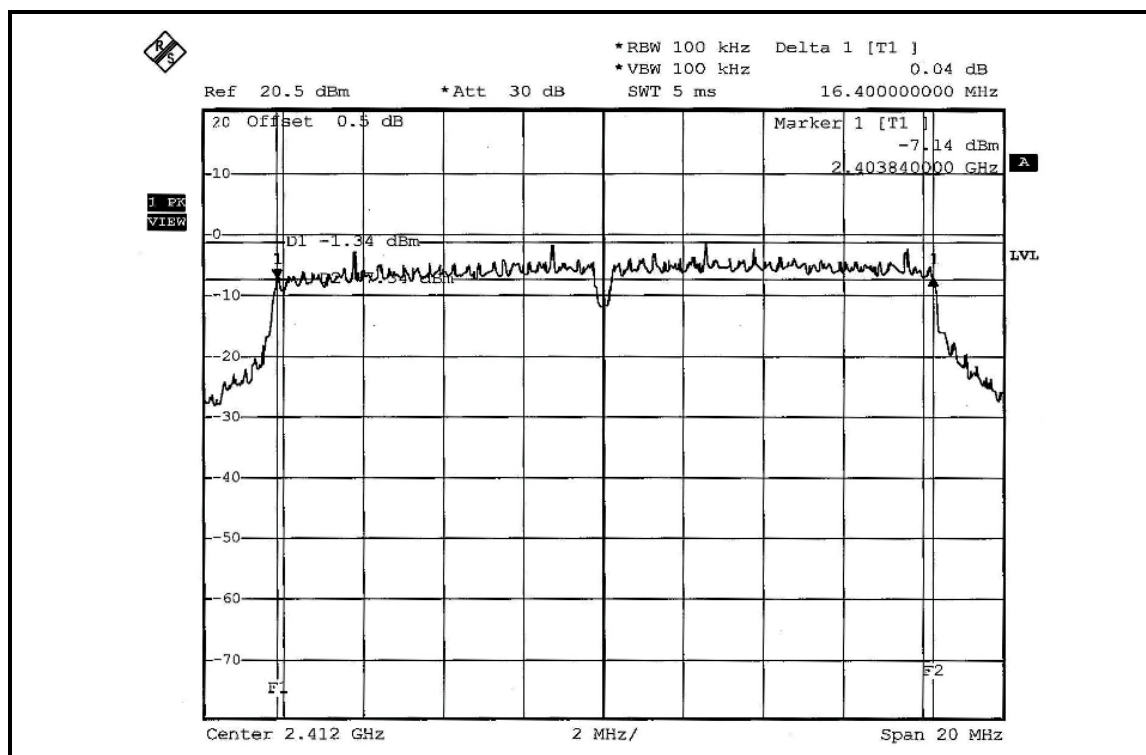

CH 6

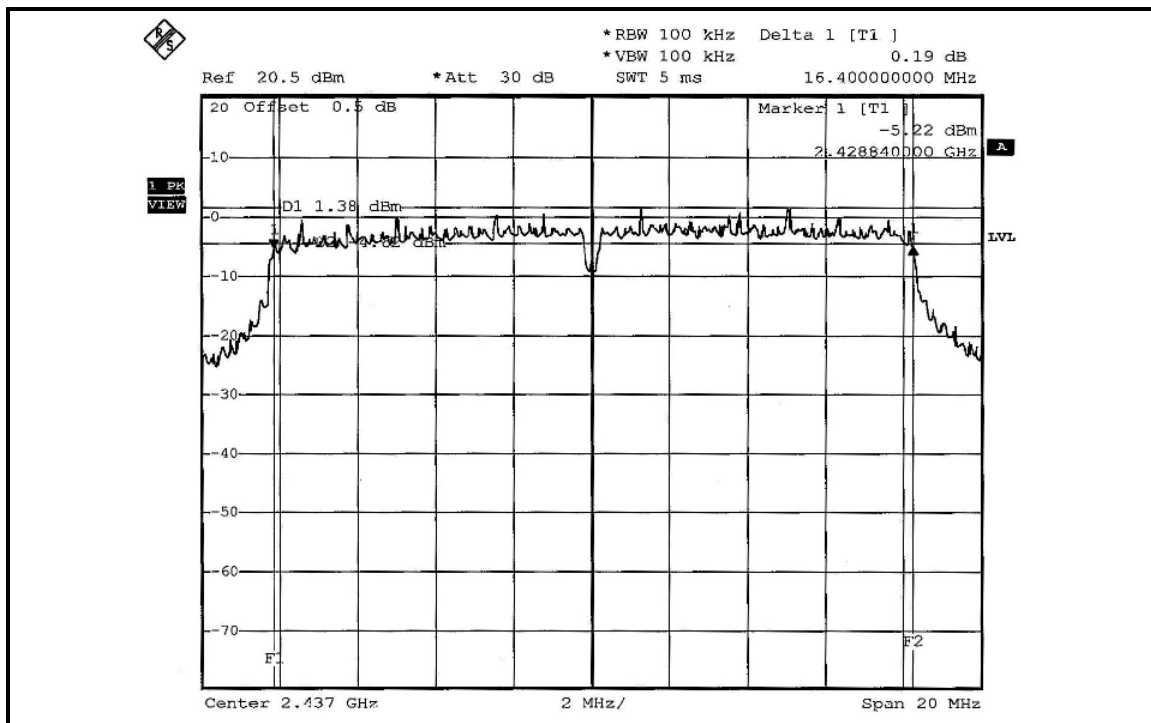

CH 11

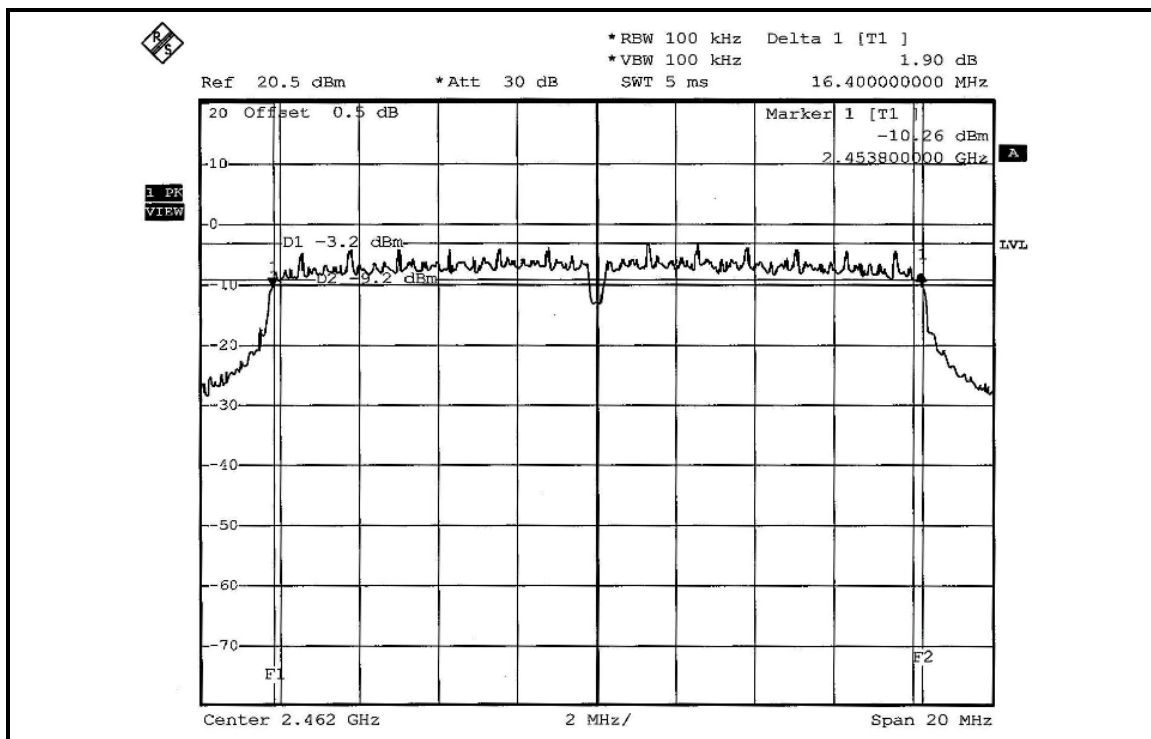

FOR CHAIN 1: CH 1

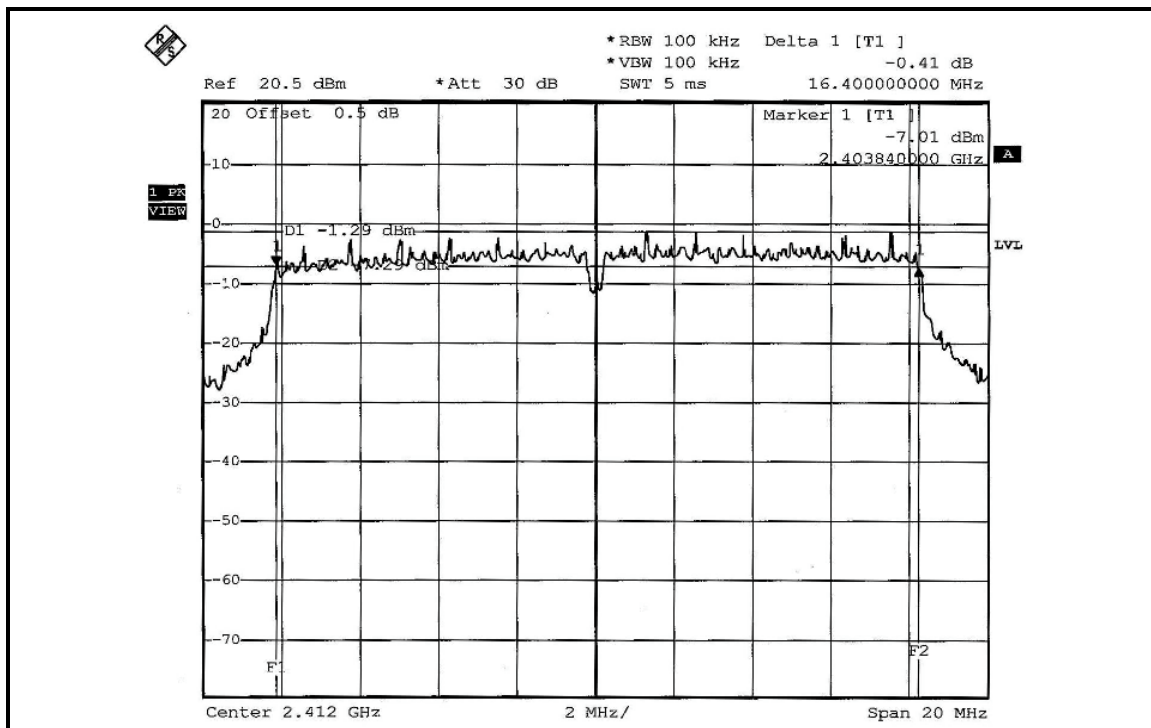

CH 6

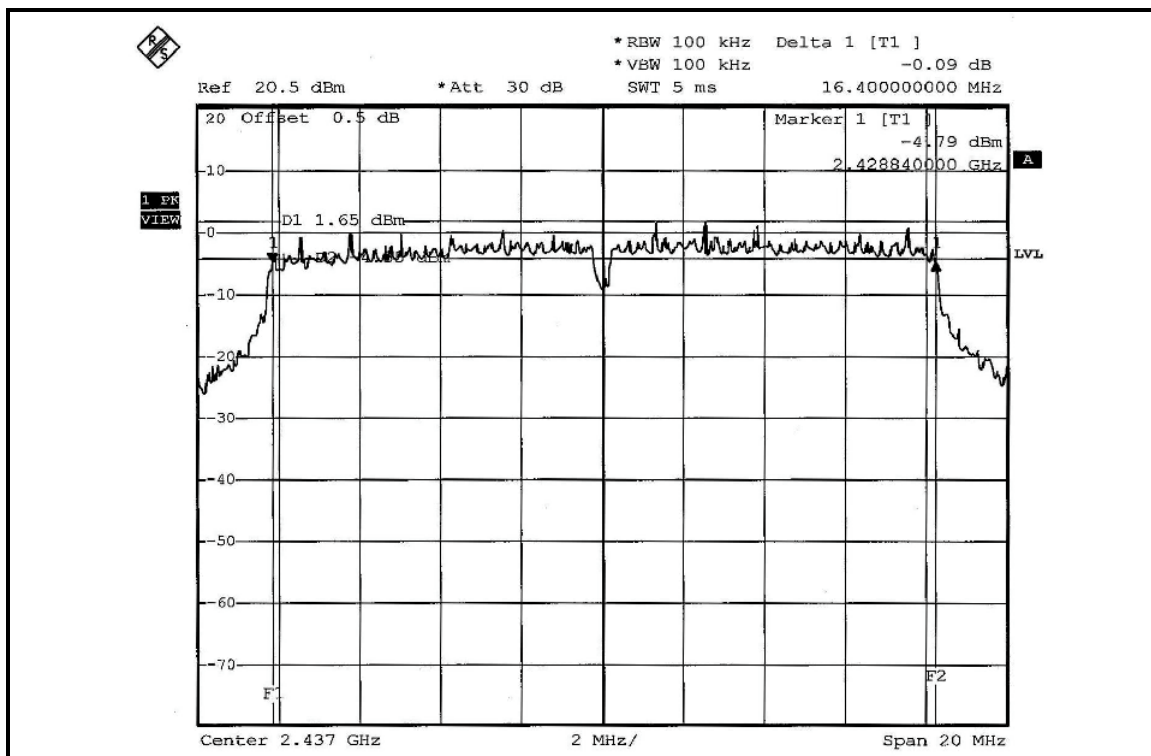

CH 11

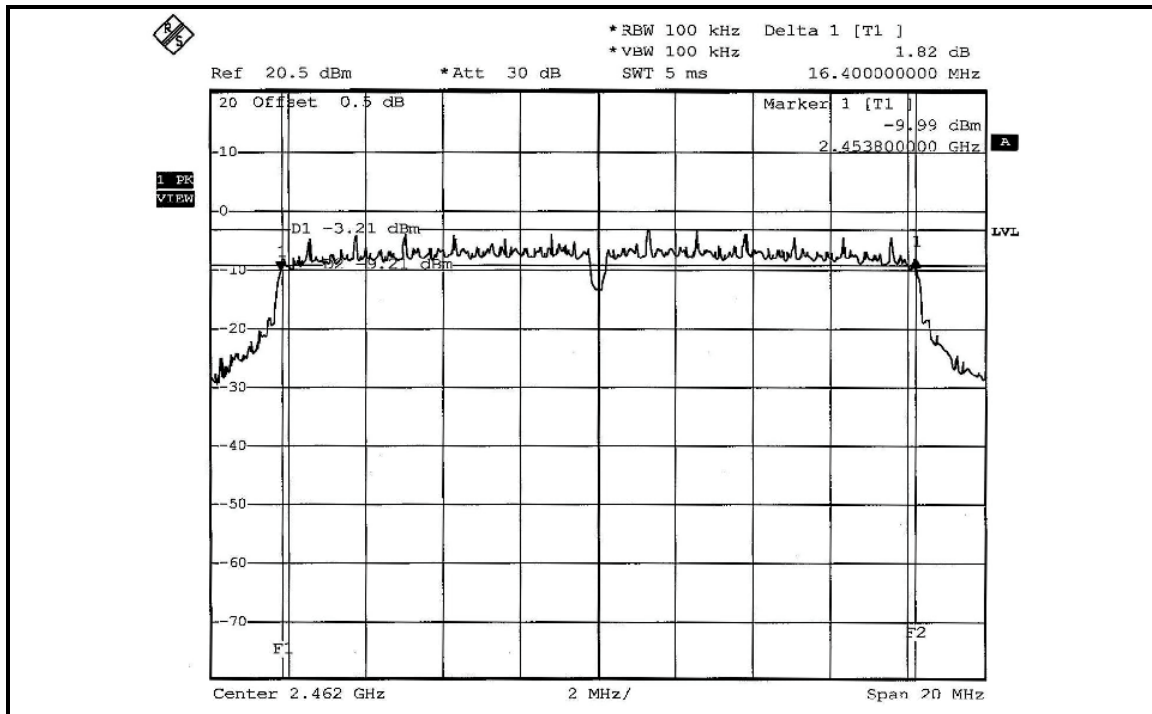



DRAFT 802.11n (20MHz) OFDM MODULATION – DUAL TX:

MODULATION TYPE	BPSK	TRANSFER RATE	7.2Mbps
INPUT POWER (SYSTEM)	120Vac, 60 Hz	ENVIRONMENTAL CONDITIONS	27deg.C, 61% RH, 991hPa
TESTED BY	Match Tsui		

CHANNEL	CHANNEL FREQUENCY (MHz)	6dB BANDWIDTH (MHz)		MINIMUM LIMIT (MHz)	PASS / FAIL
		CHAIN 0	CHAIN 1		
1	2412	17.36	17.64	0.5	PASS
6	2437	17.60	17.60	0.5	PASS
11	2462	17.64	17.64	0.5	PASS

FOR CHAIN 0: CH 1

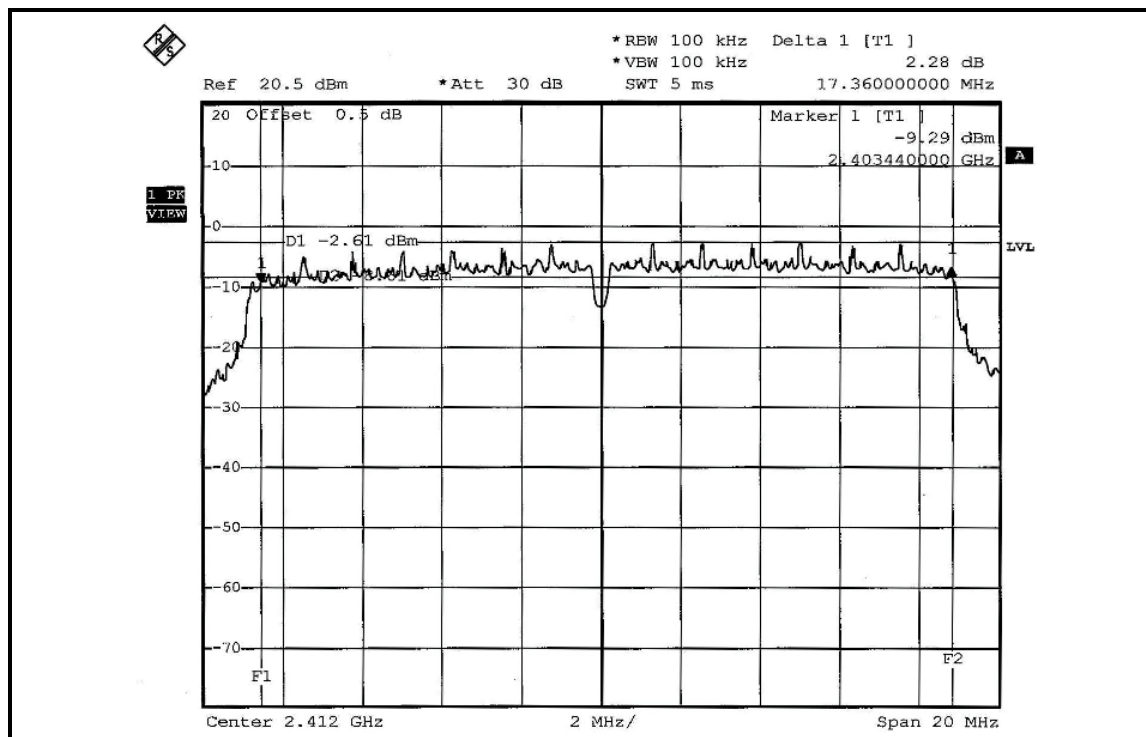

FOR CHAIN 1: CH 1

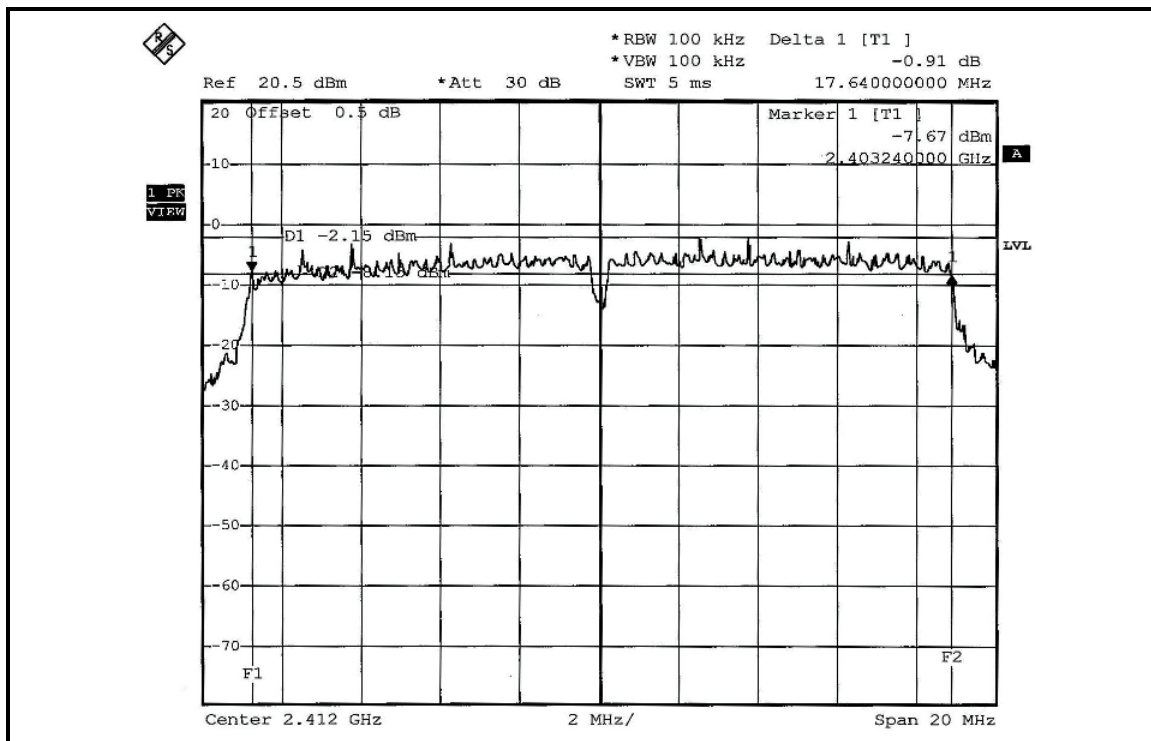

CH 6

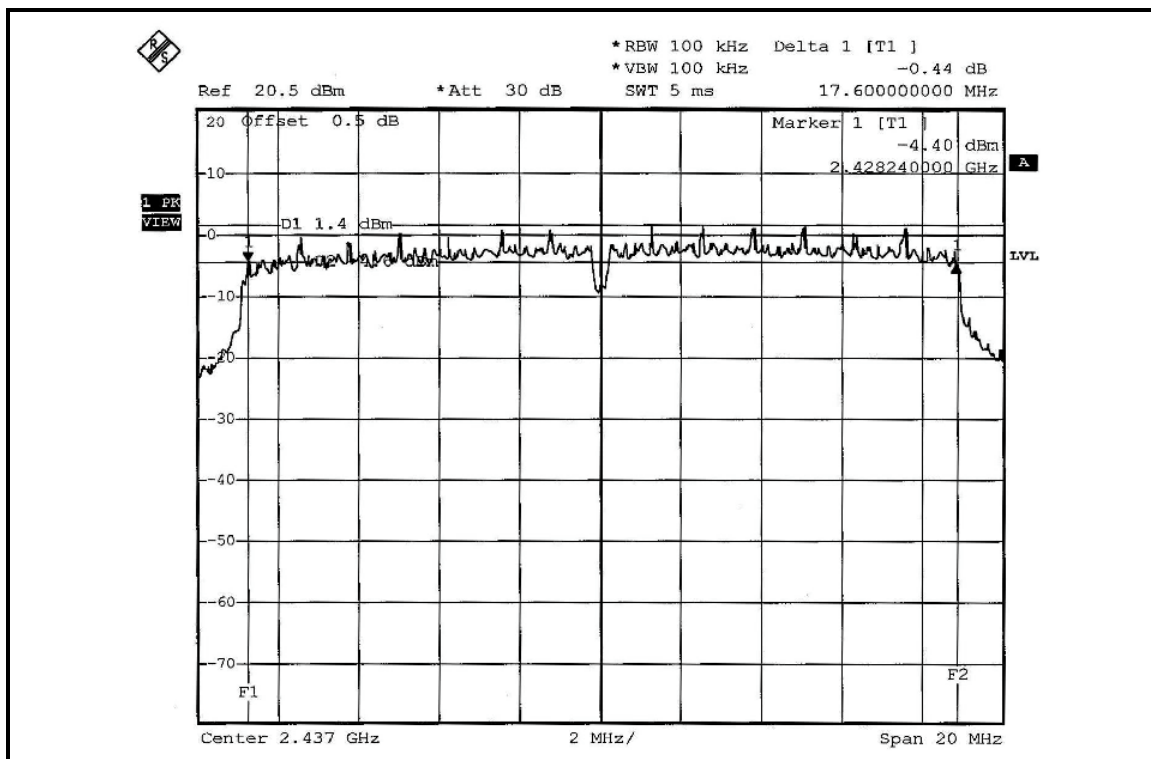

CH 11

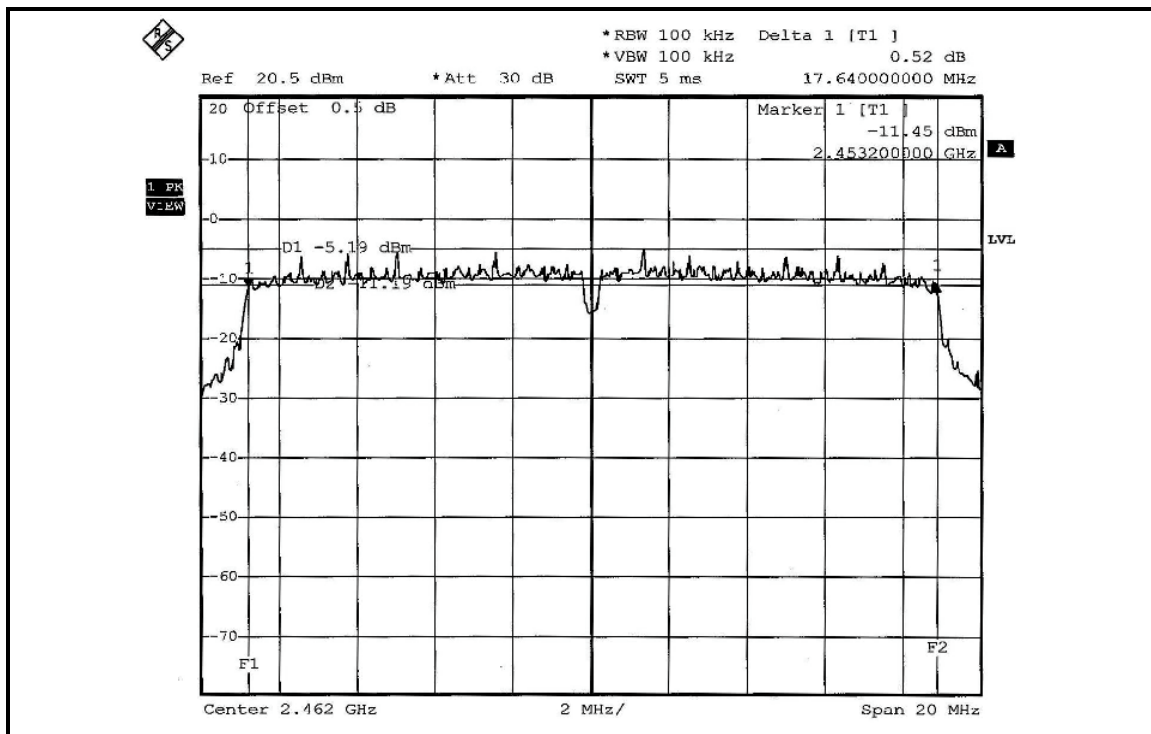



DRAFT 802.11n (40MHz) OFDM MODULATION – DUAL TX:

MODULATION TYPE	BPSK	TRANSFER RATE	15.0Mbps
INPUT POWER (SYSTEM)	120Vac, 60 Hz	ENVIRONMENTAL CONDITIONS	27deg.C, 61% RH, 991hPa
TESTED BY	Match Tsui		

CHANNEL	CHANNEL FREQUENCY (MHz)	6dB BANDWIDTH (MHz)		MINIMUM LIMIT (MHz)	PASS / FAIL
		CHAIN 0	CHAIN 1		
1	2422	35.84	35.92	0.5	PASS
4	2437	35.92	35.92	0.5	PASS
7	2452	36.40	36.32	0.5	PASS

FOR CHAIN 0: CH 1

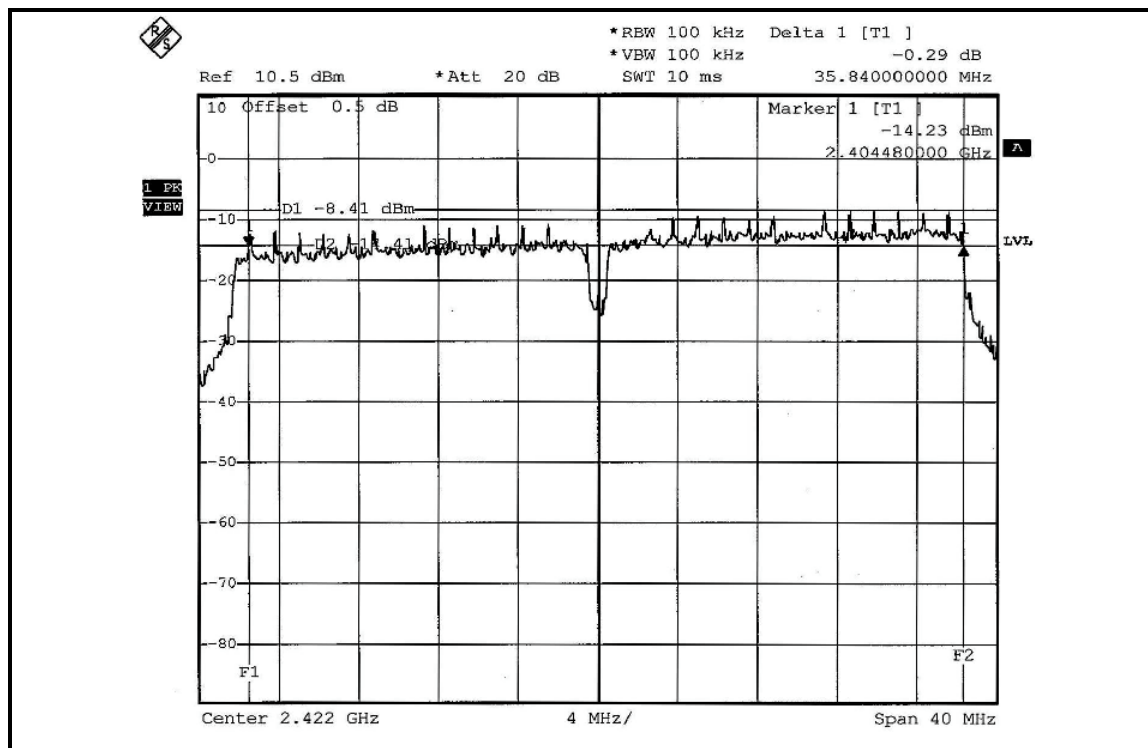

CH 4

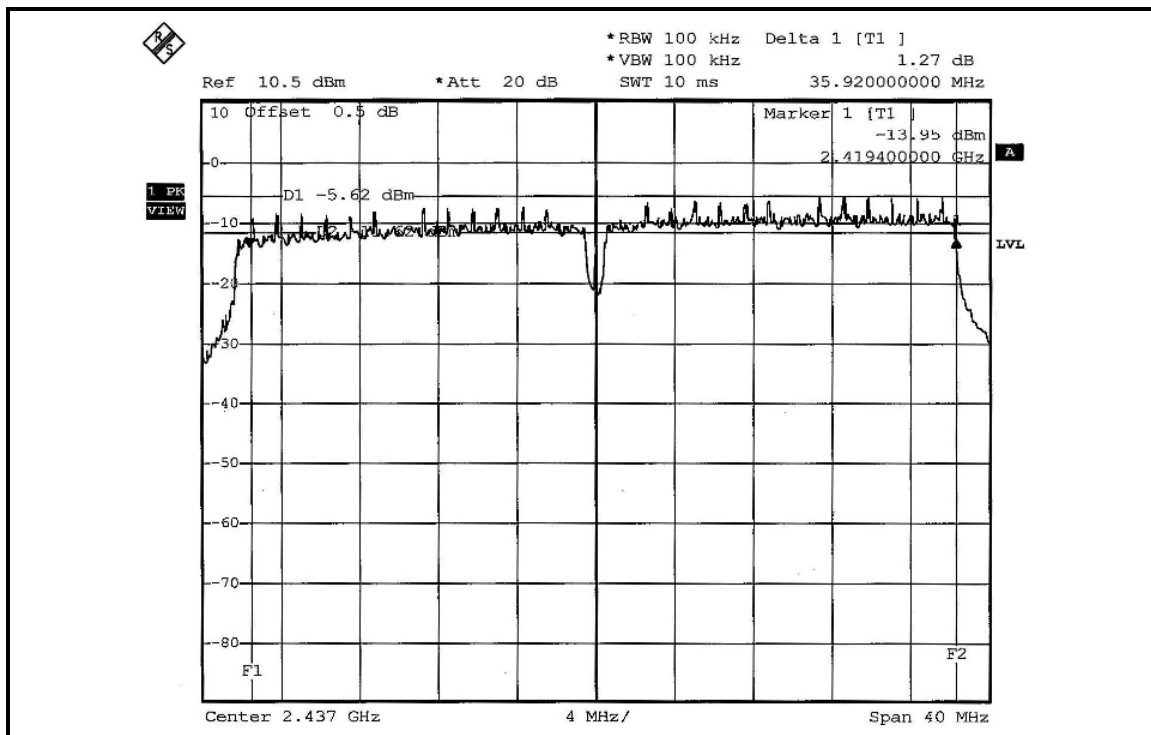

CH 7

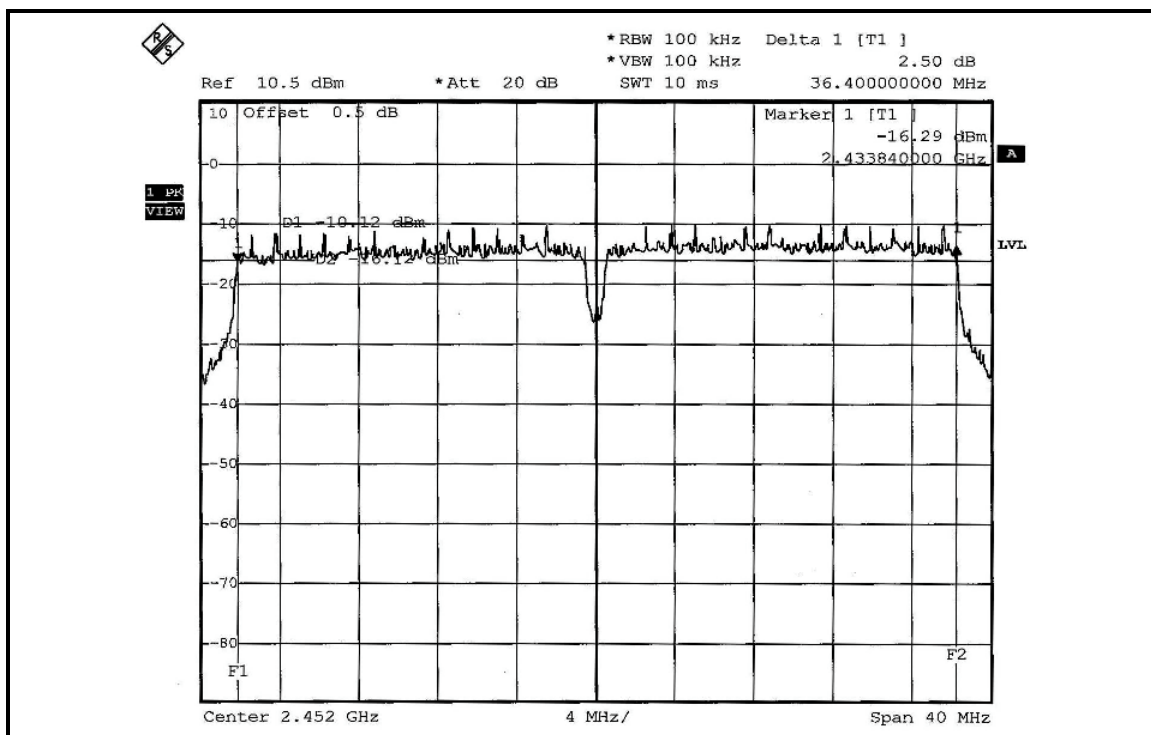

FOR CHAIN 1: CH 1

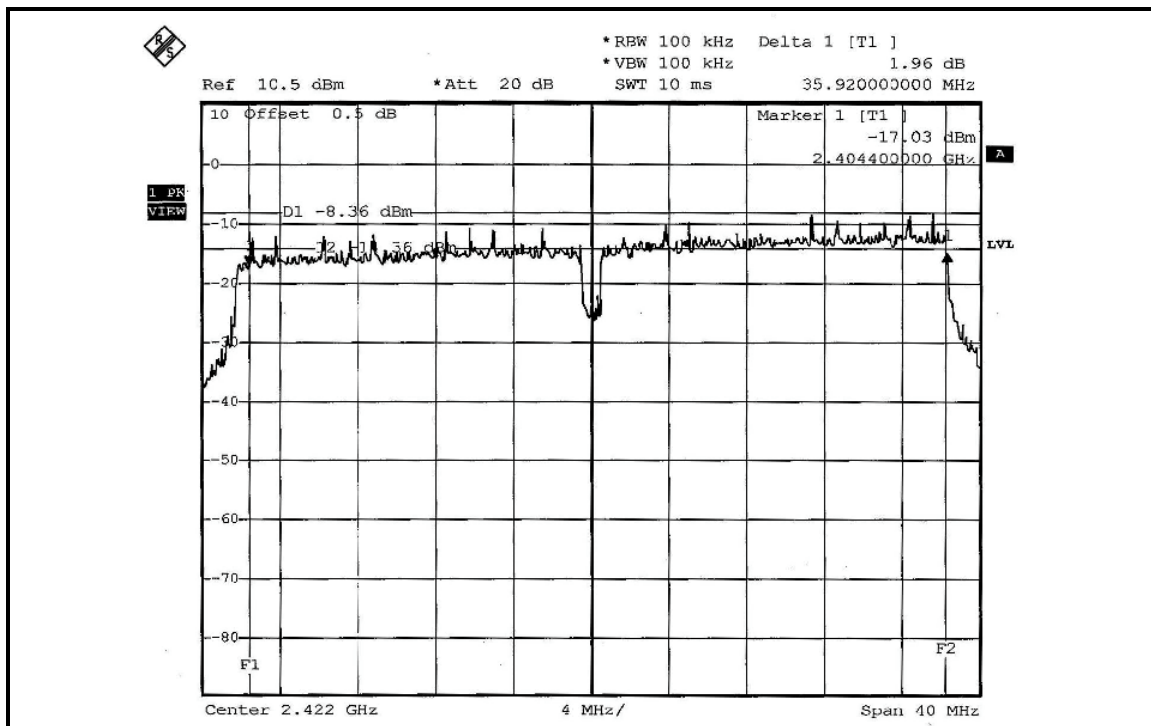

CH 4

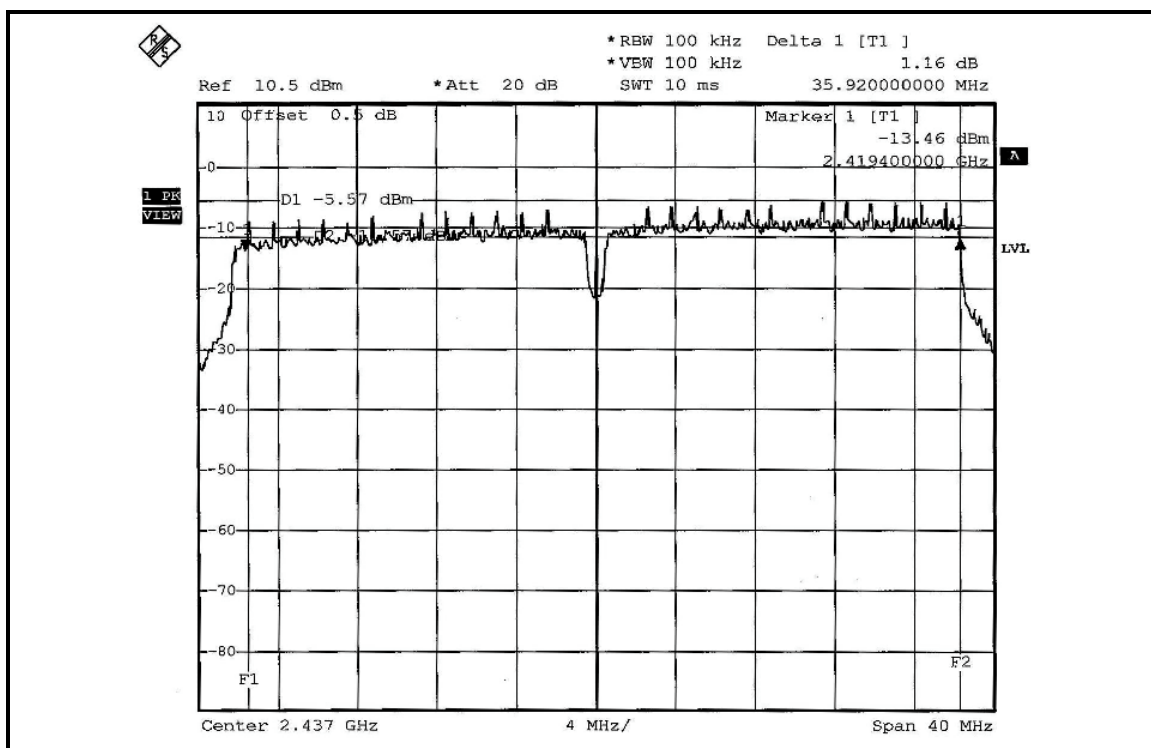

CH 7

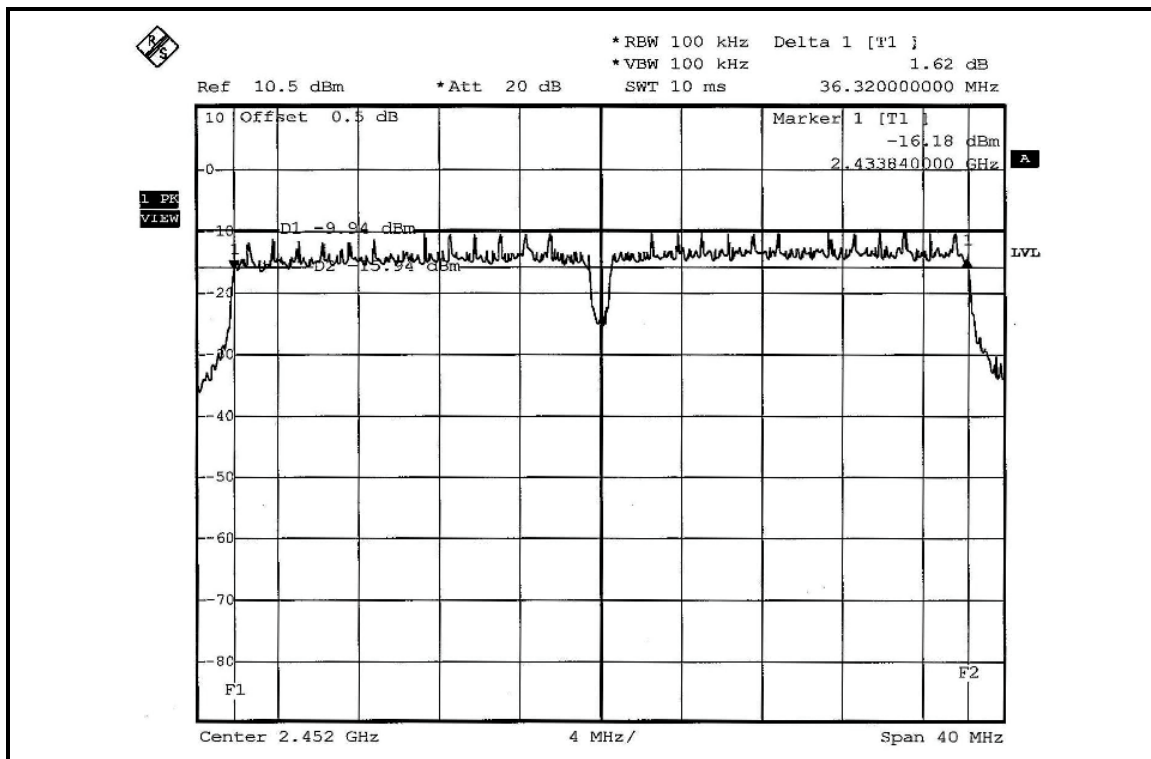

4.4 MAXIMUM PEAK OUTPUT POWER

4.4.1 LIMITS OF MAXIMUM PEAK OUTPUT POWER MEASUREMENT

The Maximum Peak Output Power Measurement is 30dBm.

4.4.2 INSTRUMENTS

DESCRIPTION & MANUFACTURER	MODEL NO.	SERIAL NO.	CALIBRATED UNTIL
R&S SPECTRUM ANALYZER	FSEK30	100049	Aug. 14, 2006
AGILENT SIGNAL GENERATOR	E8257C	MY43320668	Dec. 07, 2006
DIGITAL RT OSCILLOSCOPE	TDS1012	C037299	Nov. 28, 2006
NARDA DETECTOR	4503A	FSCM99899	NA

NOTE: The calibration interval of the above test instruments is 12 months and the calibrations are traceable to NML/ROC and NIST/USA.

4.4.3 TEST PROCEDURES

1. A detector was used on the output port of the EUT. An oscilloscope was used to read the response of the detector.
2. Replaced the EUT by the signal generator. The center frequency of the S.G was adjusted to the center frequency of the measured channel.
3. Adjusted the power to have the same reading on oscilloscope. Record the power level.

4.4.4 DEVIATION FROM TEST STANDARD

No deviation

4.4.5 TEST SETUP

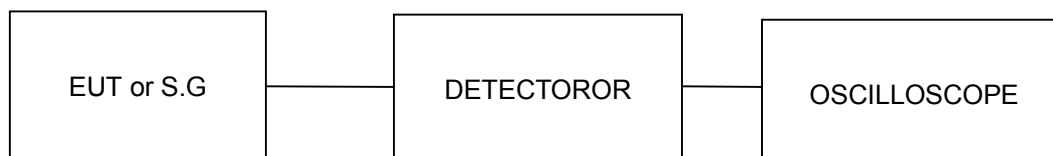

4.4.6 EUT OPERATING CONDITIONS

Same as Item 4.3.6

4.4.7 TEST RESULTS

802.11b DSSS MODULATION – DUAL TX:

MODULATION TYPE	DBPSK	TRANSFER RATE	1.0Mbps
INPUT POWER (SYSTEM)	120Vac, 60 Hz	ENVIRONMENTAL CONDITIONS	27deg.C, 61% RH, 991hPa
TESTED BY	Match Tsui		

CHAN.	CHANNEL FREQUENCY (MHz)	PEAK POWER OUTPUT (mW)		PEAK POWER OUTPUT (dBm)		TOTAL PEAK POWER (mW)	TOTAL PEAK POWER (dBm)	PEAK POWER LIMIT (dBm)	PASS / FAIL
		CHAIN 0	CHAIN 1	CHAIN 0	CHAIN 1				
1	2412	25.468	25.586	14.06	14.08	51.054	17.08	30	PASS
6	2437	64.121	64.417	18.07	18.09	128.538	21.09	30	PASS
11	2462	25.293	25.351	14.03	14.04	50.644	17.05	30	PASS

802.11g OFDM MODULATION – DUAL TX:

MODULATION TYPE	BPSK	TRANSFER RATE	6.0Mbps
INPUT POWER (SYSTEM)	120Vac, 60 Hz	ENVIRONMENTAL CONDITIONS	27deg.C, 61% RH, 991hPa
TESTED BY	Match Tsui		

CHAN.	CHANNEL FREQUENCY (MHz)	PEAK POWER OUTPUT (mW)		PEAK POWER OUTPUT (dBm)		TOTAL PEAK POWER (mW)	TOTAL PEAK POWER (dBm)	PEAK POWER LIMIT (dBm)	PASS / FAIL
		CHAIN 0	CHAIN 1	CHAIN 0	CHAIN 1				
1	2412	35.727	35.975	15.53	15.56	71.702	18.56	30	PASS
6	2437	63.826	64.121	18.05	18.07	127.947	21.07	30	PASS
11	2462	22.491	22.646	13.52	13.55	45.137	16.55	30	PASS



DRAFT 802.11n (20MHz) OFDM MODULATION – DUAL TX:

MODULATION TYPE	BPSK	TRANSFER RATE	7.2Mbps
INPUT POWER (SYSTEM)	120Vac, 60 Hz	ENVIRONMENTAL CONDITIONS	27deg.C, 61% RH, 991hPa
TESTED BY	Match Tsui		

CHAN.	CHANNEL FREQUENCY (MHz)	PEAK POWER OUTPUT (mW)		PEAK POWER OUTPUT (dBm)		TOTAL PEAK POWER (mW)	TOTAL PEAK POWER (dBm)	PEAK POWER LIMIT (dBm)	PASS / FAIL
		CHAIN 0	CHAIN 1	CHAIN 0	CHAIN 1				
1	2412	28.314	28.510	14.52	14.55	56.824	17.55	30	PASS
6	2437	63.387	63.826	18.02	18.05	127.213	21.05	30	PASS
11	2462	19.953	20.137	13.00	13.04	40.090	16.03	30	PASS

DRAFT 802.11n (40MHz) OFDM MODULATION – DUAL TX:

MODULATION TYPE	BPSK	TRANSFER RATE	15.0Mbps
INPUT POWER (SYSTEM)	120Vac, 60 Hz	ENVIRONMENTAL CONDITIONS	27deg.C, 61% RH, 991hPa
TESTED BY	Match Tsui		

CHAN.	CHANNEL FREQUENCY (MHz)	PEAK POWER OUTPUT (mW)		PEAK POWER OUTPUT (dBm)		TOTAL PEAK POWER (mW)	TOTAL PEAK POWER (dBm)	PEAK POWER LIMIT (dBm)	PASS / FAIL
		CHAIN 0	CHAIN 1	CHAIN 0	CHAIN 1				
1	2422	14.125	14.322	11.50	11.56	28.447	14.54	30	PASS
4	2437	25.119	25.410	14.00	14.05	50.529	17.04	30	PASS
7	2452	10.000	10.116	10.00	10.05	20.116	13.04	30	PASS



4.5 POWER SPECTRAL DENSITY MEASUREMENT

4.5.1 LIMITS OF POWER SPECTRAL DENSITY MEASUREMENT

The Maximum of Power Spectral Density Measurement is 8dBm.

4.5.2 TEST INSTRUMENTS

DESCRIPTION & MANUFACTURER	MODEL NO.	SERIAL NO.	CALIBRATED UNTIL
R&S SPECTRUM ANALYZER	FSEK30	100049	Aug. 14, 2006

NOTE: The calibration interval of the above test instruments is 12 months and the calibrations are traceable to NML/ROC and NIST/USA.

4.5.3 TEST PROCEDURE

The transmitter output was connected to the spectrum analyzer through an attenuator, the bandwidth of the fundamental frequency was measured with the spectrum analyzer using 3kHz RBW and 30kHz VBW, set sweep time = span/3kHz. The power spectral density was measured and recorded.

The sweep time is allowed to be longer than span/3kHz for a full response of the mixer in the spectrum analyzer.

4.5.4 DEVIATION FROM TEST STANDARD

No deviation

4.5.5 TEST SETUP

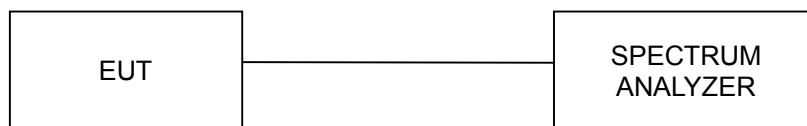

4.5.6 EUT OPERATING CONDITION

Same as Item 4.3.6

4.5.7 TEST RESULTS

802.11b DSSS MODULATION – DUAL TX:

MODULATION TYPE	DBPSK	TRANSFER RATE	1.0Mbps
INPUT POWER (SYSTEM)	120Vac, 60 Hz	ENVIRONMENTAL CONDITIONS	27deg.C, 61% RH, 991hPa
TESTED BY	Match Tsui		

CHANNEL	CHANNEL FREQUENCY (MHz)	RF POWER LEVEL IN 3kHz BW (mW)		RF POWER LEVEL IN 3kHz BW (dBm)		TOTAL POWER DENSITY (mW)	TOTAL POWER DENSITY (dBm)	MAX. LIMIT (dBm)	PASS / FAIL
		CHAIN 0	CHAIN 1	CHAIN 0	CHAIN 1				
1	2412	0.059	0.062	-12.26	-12.11	0.121	-9.17	8	PASS
6	2437	0.151	0.156	-8.20	-8.07	0.307	-5.12	8	PASS
11	2462	0.060	0.061	-12.22	-12.12	0.121	-9.16	8	PASS

FOR CHAIN 0: CH 1

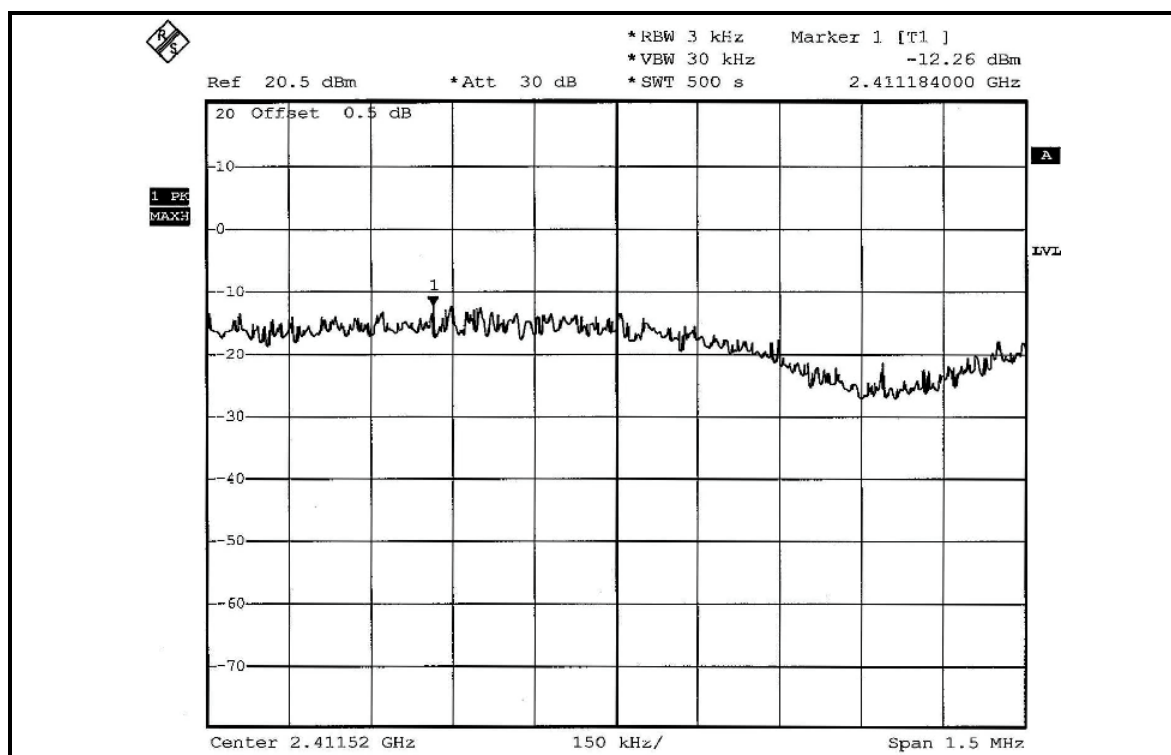

CH 6

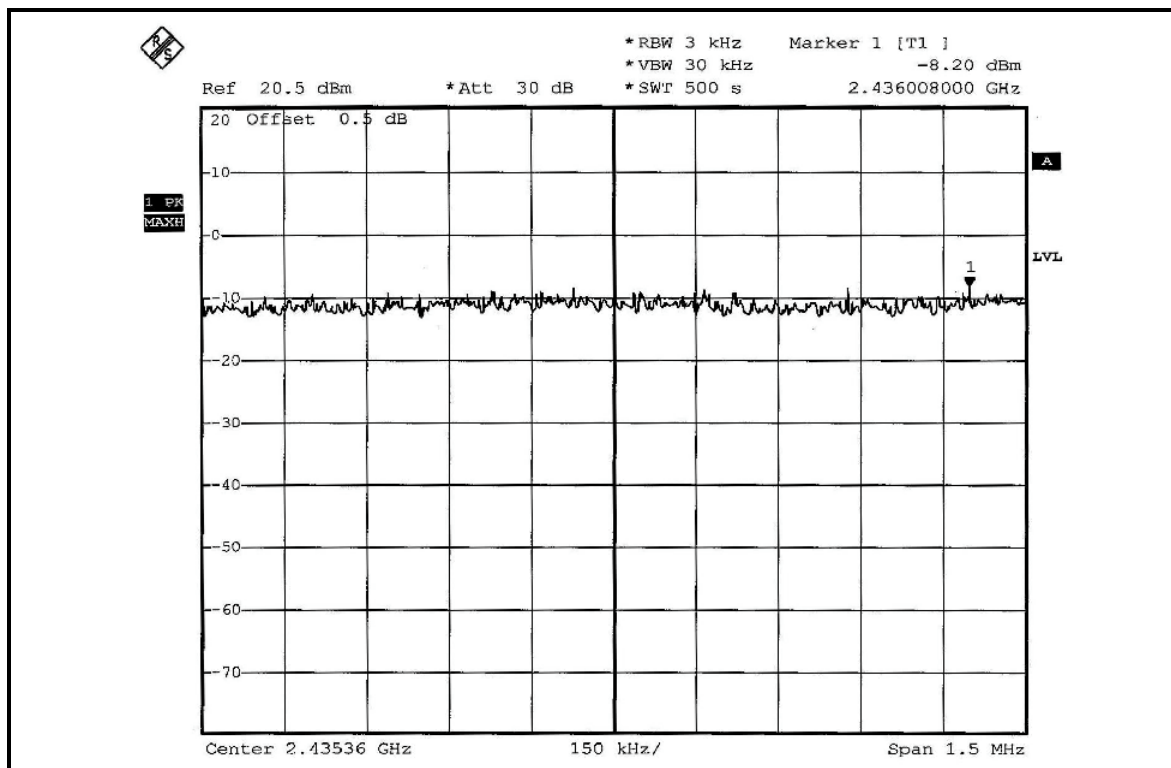

CH 11

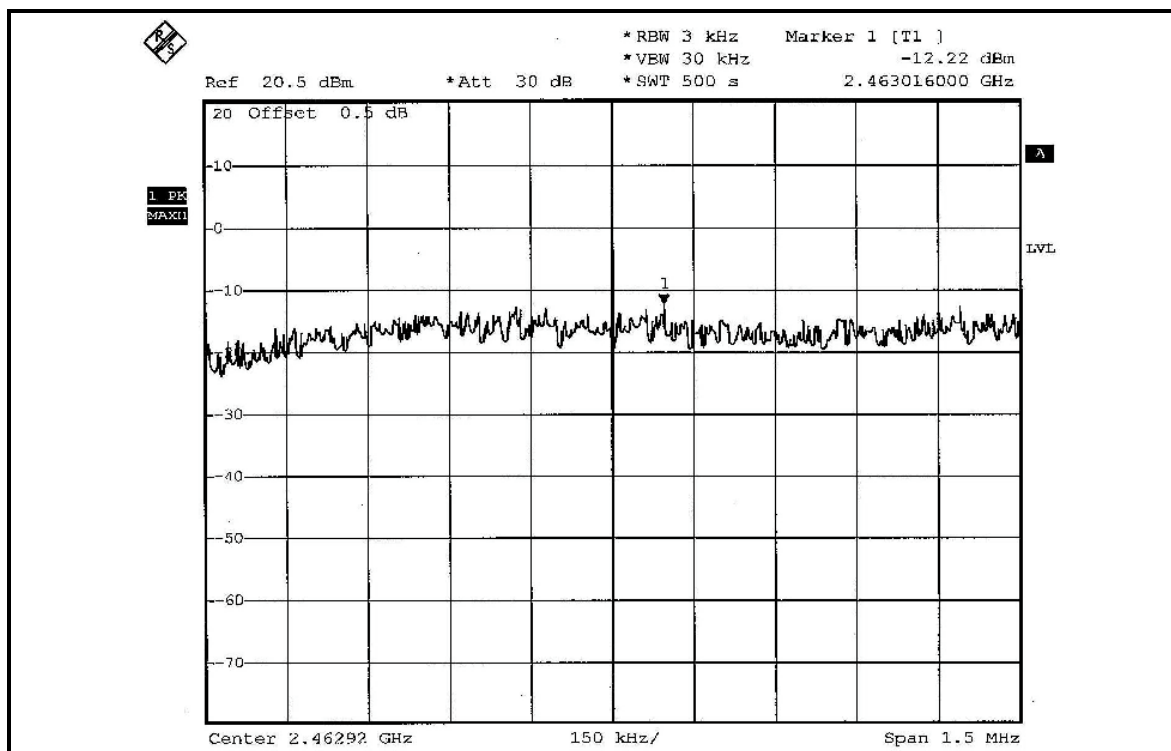

FOR CHAIN 1: CH 1

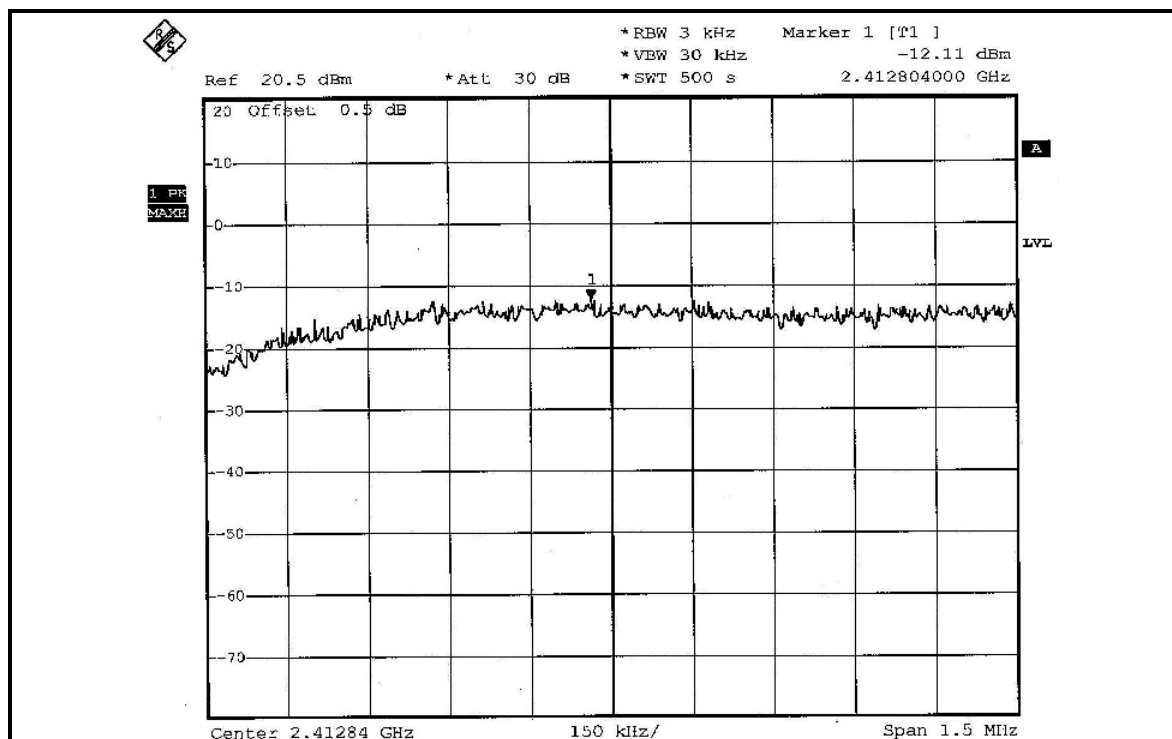

CH 6

