



FCC TEST REPORT

REPORT NO.: RF940310L13

MODEL NO.: WCB-210A

RECEIVED: Mar. 10, 2005

TESTED: Mar. 10 ~ Mar. 12, 2005

ISSUED: Mar. 15, 2005

APPLICANT: U-MEDIA Communications, Inc.

ADDRESS: 9F, No. 1, Jin-shan 7th St., Hsinchu 300, Taiwan,
R.O.C.

ISSUED BY: Advance Data Technology Corporation

LAB ADDRESS: No. 47, 14th Ling, Chia Pau Tsuen, Lin Kou
Hsiang 244, Taipei Hsien, Taiwan, R.O.C.

TEST LOCATION: No. 19, Hwa Ya 2nd Rd., Wen Hwa Tsuen, Kwei
Shan Hsiang, Taoyuan Hsien 333, Taiwan,
R.O.C.

This test report consists of 62 pages in total. It may be duplicated completely for legal use with the approval of the applicant. It should not be reproduced except in full, without the written approval of our laboratory. The client should not use it to claim product endorsement by CNLA, A2LA or any government agencies. The test results in the report only apply to the tested sample.



0528
ILAC MRA



No. 2177-01



Table of Contents

1.	CERTIFICATION	4
2.	SUMMARY OF TEST RESULTS	5
2.1	MEASUREMENT UNCERTAINTY	5
3.	GENERAL INFORMATION.....	6
3.1	GENERAL DESCRIPTION OF EUT	6
3.2	DESCRIPTION OF TEST MODES.....	7
3.2.1	CONFIGURATION OF SYSTEM UNDER TEST	7
3.2.2	TEST MODE APPLICABILITY AND TESTED CHANNEL DETAIL:.....	8
3.3	GENERAL DESCRIPTION OF APPLIED STANDARDS	10
3.4	DESCRIPTION OF SUPPORT UNITS	10
4.	TEST TYPES AND RESULTS	11
4.1	CONDUCTED EMISSION MEASUREMENT	11
4.1.1	LIMITS OF CONDUCTED EMISSION MEASUREMENT.....	11
4.1.2	TEST INSTRUMENTS.....	11
4.1.3	TEST PROCEDURES	12
4.1.4	DEVIATION FROM TEST STANDARD	12
4.1.5	TEST SETUP	13
4.1.6	EUT OPERATING CONDITIONS	13
4.1.7	TEST RESULTS	14
4.2	RADIATED EMISSION MEASUREMENT	20
4.2.1	LIMITS OF RADIATED EMISSION MEASUREMENT.....	20
4.2.2	TEST INSTRUMENTS.....	21
4.2.3	TEST PROCEDURES	22
4.2.4	DEVIATION FROM TEST STANDARD	22
4.2.5	TEST SETUP	23
4.2.6	EUT OPERATING CONDITIONS	23
4.2.7	TEST RESULTS	24
4.3	6dB BANDWIDTH MEASUREMENT	32
4.3.1	LIMITS OF 6dB BANDWIDTH MEASUREMENT	32
4.3.2	TEST INSTRUMENTS.....	32
4.3.3	TEST PROCEDURE.....	32
4.3.4	DEVIATION FROM TEST STANDARD	32
4.3.5	TEST SETUP	32
4.3.6	EUT OPERATING CONDITIONS	32
4.3.7	TEST RESULTS	33
4.4	MAXIMUM PEAK OUTPUT POWER	39
4.4.1	LIMITS OF MAXIMUM PEAK OUTPUT POWER MEASUREMENT.....	39
4.4.2	INSTRUMENTS.....	39
4.4.3	TEST PROCEDURES	40
4.4.4	DEVIATION FROM TEST STANDARD	40
4.4.5	TEST SETUP	40
4.4.6	EUT OPERATING CONDITIONS	40
4.4.7	TEST RESULTS	41



4.5	POWER SPECTRAL DENSITY MEASUREMENT	42
4.5.1	LIMITS OF POWER SPECTRAL DENSITY MEASUREMENT	42
4.5.2	TEST INSTRUMENTS.....	42
4.5.3	TEST PROCEDURE.....	43
4.5.4	DEVIATION FROM TEST STANDARD	43
4.5.5	TEST SETUP	43
4.5.6	EUT OPERATING CONDITION	43
4.5.7	TEST RESULTS	44
4.6	BAND EDGES MEASUREMENT	50
4.6.1	LIMITS OF BAND EDGES MEASUREMENT	50
4.6.2	TEST INSTRUMENTS.....	50
4.6.3	TEST PROCEDURE.....	50
4.6.4	DEVIATION FROM TEST STANDARD	50
4.6.5	EUT OPERATING CONDITION	50
4.6.6	TEST RESULTS	51
4.6.7	TEST RESULTS	51
4.7	ANTENNA REQUIREMENT	59
4.7.1	STANDARD APPLICABLE	59
4.7.2	ANTENNA CONNECTED CONSTRUCTION.....	59
5.	PHOTOGRAPHS OF THE TEST CONFIGURATION.....	60
6.	INFORMATION ON THE TESTING LABORATORIES	62



1. CERTIFICATION

PRODUCT: Wireless 802.11g Cardbus Card
BRAND NAME: U-MEDIA
MODEL NO.: WCB-210A
TEST SAMPLE: ENGINEERING SAMPLE
TESTED: Mar. 10 ~ Mar. 12, 2005
APPLICANT: U-MEDIA Communications, Inc.
STANDARDS: FCC Part 15, Subpart C (Section 15.247),
ANSI C63.4-2003

The above equipment have been tested by **Advance Data Technology Corporation**, and found compliance with the requirement of the above standards. The test record, data evaluation & Equipment Under Test (EUT) configurations represented herein are true and accurate accounts of the measurements of the sample's EMC characteristics under the conditions specified in this report.

PREPARED BY : Andrea Hsia , **DATE:** Mar. 15, 2005
(Andrea Hsia)

TECHNICAL
ACCEPTANCE : Gary Chang , **DATE:** Mar. 15, 2005
Responsible for RF (Gary Chang)

APPROVED BY : Cody Chang , **DATE:** Mar. 15, 2005
(Cody Chang, Deputy Manager)

2. SUMMARY OF TEST RESULTS

The EUT has been tested according to the following specifications:

APPLIED STANDARD: FCC Part 15, Subpart C			
Standard Section	Test Type and Limit	Result	Remark
15.207	AC Power Conducted Emission	PASS	Meet the requirement of limit. Minimum passing margin is -18.63dB at 0.560MHz
15.247(a)(2)	Spectrum Bandwidth of a Direct Sequence Spread Spectrum System Limit: min. 500kHz	PASS	Meet the requirement of limit.
15.247(b)	Maximum Peak Output Power Limit: max. 30dBm	PASS	Meet the requirement of limit.
15.247(d)	Radiated Emissions Limit: Table 15.209	PASS	Meet the requirement of limit. Minimum passing margin is -3.70dB at 9648.00MHz
15.247(e)	Power Spectral Density Limit: max. 8dBm	PASS	Meet the requirement of limit.
15.247(d)	Band Edge Measurement Limit: 20dB less than the peak value of fundamental frequency	PASS	Meet the requirement of limit.

2.1 MEASUREMENT UNCERTAINTY

Where relevant, the following measurement uncertainty levels have been estimated for tests performed on the EUT as specified in CISPR 16-4:

Measurement	Frequency	Uncertainty
Conducted emissions	9kHz~30MHz	2.44 dB
Radiated emissions	30MHz ~ 200MHz	3.63 dB
	200MHz ~ 1000MHz	3.65 dB
	1GHz ~ 18GHz	2.20 dB
	18GHz ~ 40GHz	1.88 dB



3. GENERAL INFORMATION

3.1 GENERAL DESCRIPTION OF EUT

EUT	Wireless 802.11g Cardbus Card
MODEL NO.	WCB-210A
POWER SUPPLY	3.3Vdc from host equipment
MODULATION TYPE	CCK, DQPSK, DBPSK for DSSS 64QAM, 16QAM, QPSK, BPSK for OFDM
RADIO TECHNOLOGY	DSSS, OFDM
TRANSFER RATE	802.11b: 11/5.5/2/1Mbps 802.11g: 54/48/36/24/18/12/9/6Mbps
FREQUENCY RANGE	2412MHz ~ 2462MHz
NUMBER OF CHANNEL	11
OUTPUT POWER	66.988mW
ANTENNA TYPE	Printed antenna with 0dBi gain
DATA CABLE	NA
I/O PORTS	NA
ASSOCIATED DEVICES	NA

NOTE:

1. The EUT complies with IEEE 802.11g standards and backwards compatible with IEEE 802.11b products.
2. The EUT operates in the 2.4GHz frequency spectrum with throughput of up to 54Mbps.
3. The above EUT information was declared by manufacturer and for more detailed features description, please refer to the manufacturer's specifications or User's Manual.

3.2 DESCRIPTION OF TEST MODES

Eleven channels are provided to this EUT.

Channel	Frequency	Channel	Frequency
1	2412 MHz	7	2442 MHz
2	2417 MHz	8	2447 MHz
3	2422 MHz	9	2452 MHz
4	2427 MHz	10	2457 MHz
5	2432 MHz	11	2462 MHz
6	2437 MHz		

3.2.1 CONFIGURATION OF SYSTEM UNDER TEST

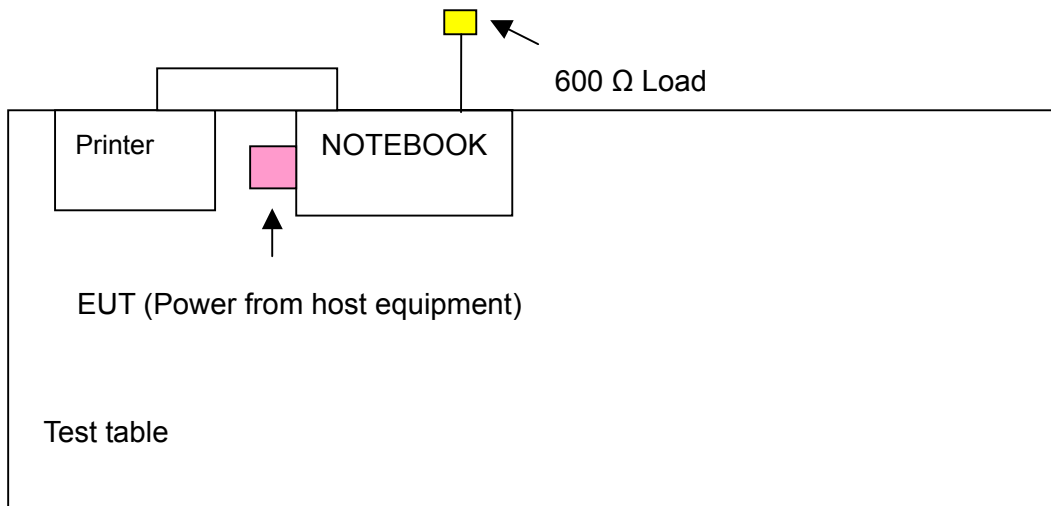



3.2.2 TEST MODE APPLICABILITY AND TESTED CHANNEL DETAIL:

EUT configure mode	Applicable to				Description
	PLC	RE<1G	RE≥1G	APCM	
-	X	X	X	X	NA

Where PLC: Power Line Conducted Emission RE<1G RE: Radiated Emission below 1GHz
 RE≥1G: Radiated Emission above 1GHz APCM: Antenna Port Conducted Measurement

Power Line Conducted Emission Test:

- Pre-Scan has been conducted to determine the worst-case mode from all possible combinations between available modulations, data rates and antenna ports (if EUT with antenna diversity architecture).
- Following channel(s) was (were) selected for the final test as listed below.

Mode	Available Channel	Tested Channel	Modulation Technology	Modulation Type	Data Rate (Mbps)
802.11g	1 to 11	1, 6, 11	OFDM	BPSK	6

Radiated Emission Test (Below 1 GHz):

- Pre-Scan has been conducted to determine the worst-case mode from all possible combinations between available modulations, data rates and antenna ports (if EUT with antenna diversity architecture).
- Following channel(s) was (were) selected for the final test as listed below.

Mode	Available Channel	Tested Channel	Modulation Technology	Modulation Type	Data Rate (Mbps)
802.11g	1 to 11	1	OFDM	BPSK	6

Radiated Emission Test (Above 1 GHz):

- Pre-Scan has been conducted to determine the worst-case mode from all possible combinations between available modulations, data rates and antenna ports (if EUT with antenna diversity architecture).
- Following channel(s) was (were) selected for the final test as listed below.

Mode	Available Channel	Tested Channel	Modulation Technology	Modulation Type	Data Rate (Mbps)
802.11b	1 to 11	1, 6, 11	DSSS	CCK	11
802.11g	1 to 11	1, 6, 11	OFDM	BPSK	6



Bandedge Measurement:

- Pre-Scan has been conducted to determine the worst-case mode from all possible combinations between available modulations, data rates and antenna ports (if EUT with antenna diversity architecture).
- Following channel(s) was (were) selected for the final test as listed below.

Mode	Available Channel	Tested Channel	Modulation Technology	Modulation Type	Data Rate (Mbps)
802.11b	1 to 11	1, 11	DSSS	CCK	11
802.11g	1 to 11	1, 11	OFDM	BPSK	6

Antenna Port Conducted Measurement:

- Pre-Scan has been conducted to determine the worst-case mode from all possible combinations between available modulations, data rates and antenna ports (if EUT with antenna diversity architecture).
- Following channel(s) was (were) selected for the final test as listed below.

Mode	Available Channel	Tested Channel	Modulation Technology	Modulation Type	Data Rate (Mbps)
802.11b	1 to 11	1, 6, 11	DSSS	CCK	11
802.11g	1 to 11	1, 6, 11	OFDM	BPSK	6



3.3 GENERAL DESCRIPTION OF APPLIED STANDARDS

The EUT is a Wireless 802.11g Cardbus Card. According to the specifications of the manufacturer, it must comply with the requirements of the following standards:

FCC Part 15, Subpart C. (15.247)

ANSI C63.4- 2003

All test items have been performed and recorded as per the above standards.

NOTE: The EUT is also considered as a kind of computer peripheral, because the connection to computer is necessary for typical use. It has been verified to comply with the requirements of FCC Part 15, Subpart B, Class B (DoC). The test report has been issued separately.

3.4 DESCRIPTION OF SUPPORT UNITS

The EUT has been tested as an independent unit together with other necessary accessories or support units. The following support units or accessories were used to form a representative test configuration during the tests.

NO.	PRODUCT	BRAND	MODEL NO.	SERIAL NO.	FCC ID
1	NOTEBOOK	Compaq	N800C	470048-515	FCC DoC Approved
2	PRINTER	EPSON	LQ-300+	DCGY047265	FCC DoC Approved
3	600 Ω LOAD	NA	NA	NA	NA

NO.	SIGNAL CABLE DESCRIPTION OF THE ABOVE SUPPORT UNITS
1	NA
2	1.2m shielded cable without core.
3	NA

NOTE: All power cords of the above support units are non shielded (1.8m).



4. TEST TYPES AND RESULTS

4.1 CONDUCTED EMISSION MEASUREMENT

4.1.1 LIMITS OF CONDUCTED EMISSION MEASUREMENT

FREQUENCY OF EMISSION (MHz)	CONDUCTED LIMIT (dB μ V)	
	Quasi-peak	Average
0.15-0.5	66 to 56	56 to 46
0.5-5	56	46
5-30	60	50

- NOTE:**
1. The lower limit shall apply at the transition frequencies.
 2. The limit decreases in line with the logarithm of the frequency in the range of 0.15 to 0.50 MHz.
 3. All emanations from a class A/B digital device or system, including any network of conductors and apparatus connected thereto, shall not exceed the level of field strengths specified above.

4.1.2 TEST INSTRUMENTS

DESCRIPTION & MANUFACTURER	MODEL NO.	SERIAL NO.	CALIBRATED UNTIL
Test Receiver ROHDE & SCHWARZ	ESCS30	100291	Nov. 16, 2005
RF signal cable Woken	5D-FB	Cable-HYC01-01	Jan. 09, 2006
LISN ROHDE & SCHWARZ	ESH3-Z5	100312	Feb. 15, 2006
LISN ROHDE & SCHWARZ	ESH2-Z5	100104	Feb. 15, 2006
Software ADT	ADT_Cond_V3	NA	NA

- NOTE:**
1. The calibration interval of the above test instruments is 12 months and the calibrations are traceable to NML/ROC and NIST/USA.
 2. The test was performed in HwaYa Shielded Room 1.
 3. The VCCI Site Registration No. is C-2040.



4.1.3 TEST PROCEDURES

- a. The EUT was placed 0.4 meters from the conducting wall of the shielded room with EUT being connected to the power mains through a line impedance stabilization network (LISN). Other support units were connected to the power mains through another LISN. The two LISNs provide 50 ohm/ 50uH of coupling impedance for the measuring instrument.
- b. Both lines of the power mains connected to the EUT were checked for maximum conducted interference.
- c. The frequency range from 150kHz to 30MHz was searched. Emission levels under (Limit - 20dB) was not recorded.

4.1.4 DEVIATION FROM TEST STANDARD

No deviation

4.1.5 TEST SETUP

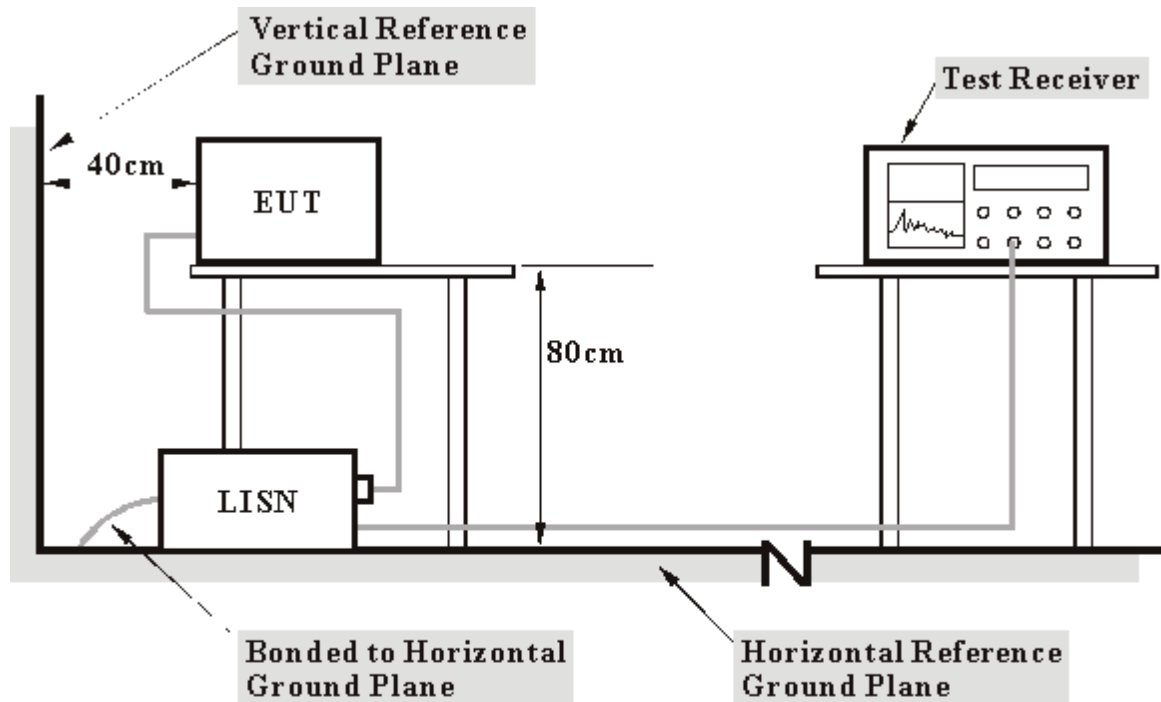

- Note:**
1. Support units were connected to second LISN.
 2. Both of LISNs (AMN) 80 cm from EUT and at the least 80 cm from other units and other metal planes support units.

For the actual test configuration, please refer to the related item – Photographs of the Test Configuration.

4.1.6 EUT OPERATING CONDITIONS

- a. Connected the EUT to a notebook system placed on a testing table.
- b. The notebook system ran a test program (provided by manufacturer) to enable EUT under transmission/receiving condition continuously at specific channel frequency.
- c. The notebook system sent "H" messages to its screen.
- d. The notebook system sent "H" messages to printer, and the printer prints them on paper.
- e. Item c ~ d were repeated.



4.1.7 TEST RESULTS

Conducted Worst-Case Data

EUT	Wireless 802.11g Cardbus Card	MODEL	WCB-210A
CHANNEL	Channel 1	6dB BANDWIDTH	9 kHz
MODULATION TYPE	BPSK	TRANSFER RATE	6Mbps
INPUT POWER (SYSTEM)	120Vac, 60 Hz	PHASE	Line (L)
ENVIRONMENTAL CONDITIONS	22deg. C, 62%RH, 991hPa	TESTED BY	Brad Wu

No	Freq. [MHz]	Corr. Factor (dB)	Reading Value [dB (uV)]		Emission Level [dB (uV)]		Limit [dB (uV)]		Margin (dB)	
			Q.P.	AV.	Q.P.	AV.	Q.P.	AV.	Q.P.	AV.
			1	0.209	0.11	40.93	-	41.04	-	63.26
2	0.283	0.11	36.24	-	36.35	-	60.73	50.73	-24.38	-
3	0.420	0.12	37.07	-	37.19	-	57.46	47.46	-20.27	-
4	0.845	0.16	31.38	-	31.54	-	56.00	46.00	-24.46	-
5	16.289	0.71	29.40	-	30.11	-	60.00	50.00	-29.89	-
6	20.418	0.95	35.19	-	36.14	-	60.00	50.00	-23.86	-

- REMARKS:**
1. Q.P. and AV. are abbreviations of quasi-peak and average individually.
 2. "-": The Quasi-peak reading value also meets average limit and measurement with the average detector is unnecessary.
 3. The emission levels of other frequencies were very low against the limit.
 4. Margin value = Emission level - Limit value
 5. Correction factor = Insertion loss + Cable loss
 6. Emission Level = Correction Factor + Reading Value.

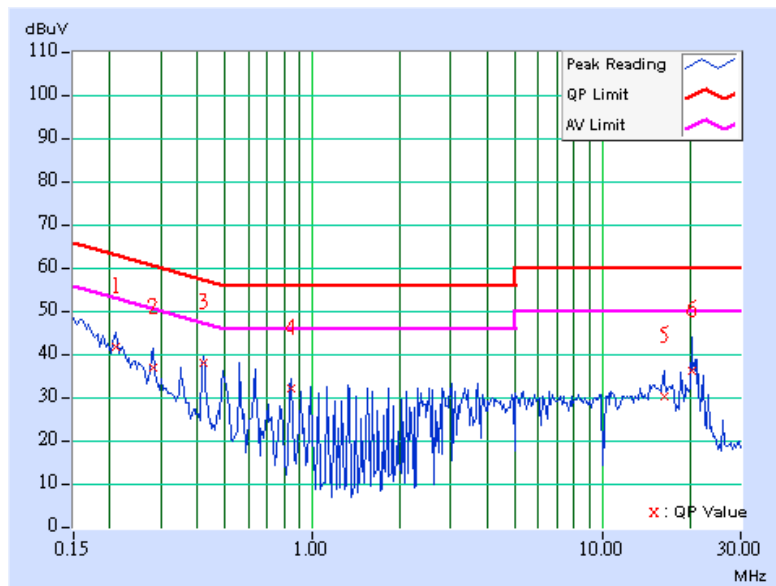



EUT	Wireless 802.11g Cardbus Card	MODEL	WCB-210A
CHANNEL	Channel 1	6dB BANDWIDTH	9 kHz
MODULATION TYPE	BPSK	TRANSFER RATE	6Mbps
INPUT POWER (SYSTEM)	120Vac, 60 Hz	PHASE	Neutral (N)
ENVIRONMENTAL CONDITIONS	22deg. C, 62%RH, 991hPa	TESTED BY	Brad Wu

No	Freq. [MHz]	Corr. Factor (dB)	Reading Value [dB (uV)]		Emission Level [dB (uV)]		Limit [dB (uV)]		Margin (dB)	
			Q.P.	AV.	Q.P.	AV.	Q.P.	AV.	Q.P.	AV.
			1	0.213	0.10	41.14	-	41.24	-	63.11
2	0.420	0.11	38.14	-	38.25	-	57.46	47.46	-19.21	-
3	0.560	0.12	37.21	-	37.33	-	56.00	46.00	-18.67	-
4	0.841	0.16	33.61	-	33.77	-	56.00	46.00	-22.23	-
5	16.438	0.53	29.83	-	30.36	-	60.00	50.00	-29.64	-
6	20.707	0.63	31.24	-	31.87	-	60.00	50.00	-28.13	-

- REMARKS:**
1. Q.P. and AV. are abbreviations of quasi-peak and average individually.
 2. "-": The Quasi-peak reading value also meets average limit and measurement with the average detector is unnecessary.
 3. The emission levels of other frequencies were very low against the limit.
 4. Margin value = Emission level - Limit value
 5. Correction factor = Insertion loss + Cable loss
 6. Emission Level = Correction Factor + Reading Value.

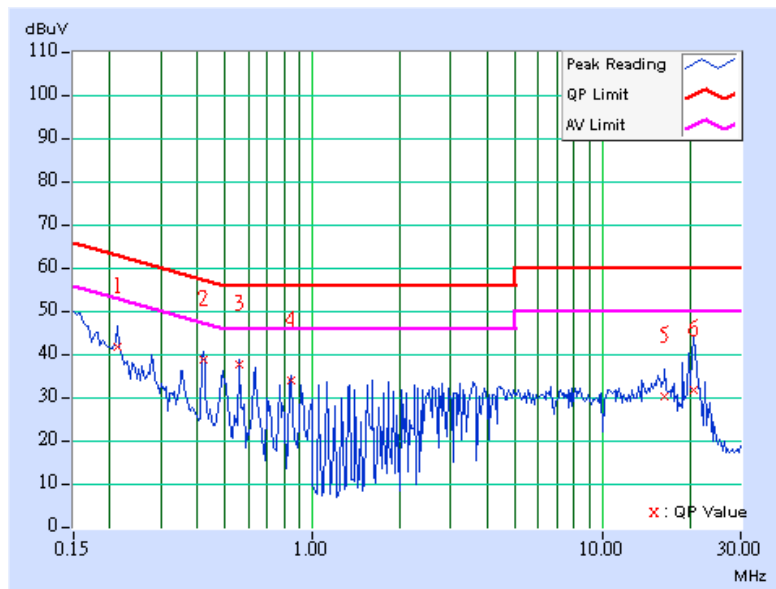



EUT	Wireless 802.11g Cardbus Card	MODEL	WCB-210A
CHANNEL	Channel 6	6dB BANDWIDTH	9 kHz
MODULATION TYPE	BPSK	TRANSFER RATE	6Mbps
INPUT POWER (SYSTEM)	120Vac, 60 Hz	PHASE	Line (L)
ENVIRONMENTAL CONDITIONS	22deg. C, 62%RH, 991hPa	TESTED BY	Brad Wu

No	Freq. [MHz]	Corr. Factor (dB)	Reading Value [dB (uV)]		Emission Level [dB (uV)]		Limit [dB (uV)]		Margin (dB)	
			Q.P.	AV.	Q.P.	AV.	Q.P.	AV.	Q.P.	AV.
			1	0.173	0.10	37.05	-	37.15	-	64.79
2	0.353	0.12	35.45	-	35.57	-	58.89	48.89	-23.32	-
3	0.560	0.13	36.94	-	37.07	-	56.00	46.00	-18.93	-
4	3.543	0.27	26.93	-	27.20	-	56.00	46.00	-28.80	-
5	16.398	0.72	29.00	-	29.72	-	60.00	50.00	-30.28	-
6	20.039	0.94	35.19	-	36.13	-	60.00	50.00	-23.87	-

- REMARKS:**
1. Q.P. and AV. are abbreviations of quasi-peak and average individually.
 2. "-": The Quasi-peak reading value also meets average limit and measurement with the average detector is unnecessary.
 3. The emission levels of other frequencies were very low against the limit.
 4. Margin value = Emission level - Limit value
 5. Correction factor = Insertion loss + Cable loss
 6. Emission Level = Correction Factor + Reading Value.

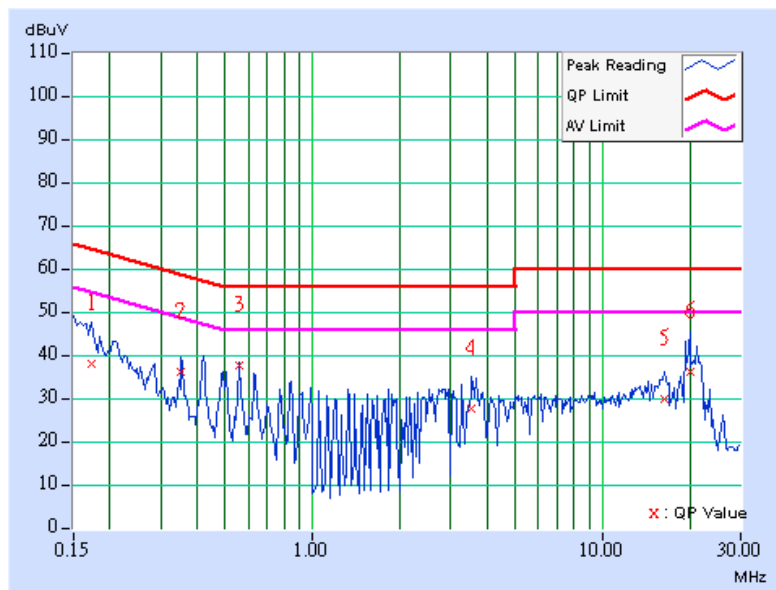



EUT	Wireless 802.11g Cardbus Card	MODEL	WCB-210A
CHANNEL	Channel 6	6dB BANDWIDTH	9 kHz
MODULATION TYPE	BPSK	TRANSFER RATE	6Mbps
INPUT POWER (SYSTEM)	120Vac, 60 Hz	PHASE	Neutral (N)
ENVIRONMENTAL CONDITIONS	22deg. C, 62%RH, 991hPa	TESTED BY	Brad Wu

No	Freq. [MHz]	Corr. Factor (dB)	Reading Value [dB (uV)]		Emission Level [dB (uV)]		Limit [dB (uV)]		Margin (dB)	
			Q.P.	AV.	Q.P.	AV.	Q.P.	AV.	Q.P.	AV.
			1	0.209	0.10	41.45	-	41.55	-	63.26
2	0.420	0.11	38.24	-	38.35	-	57.46	47.46	-19.11	-
3	0.560	0.12	37.25	-	37.37	-	56.00	46.00	-18.63	-
4	3.355	0.26	30.57	-	30.83	-	56.00	46.00	-25.17	-
5	16.117	0.52	29.69	-	30.21	-	60.00	50.00	-29.79	-
6	20.961	0.63	32.97	-	33.60	-	60.00	50.00	-26.40	-

- REMARKS:**
1. Q.P. and AV. are abbreviations of quasi-peak and average individually.
 2. "-": The Quasi-peak reading value also meets average limit and measurement with the average detector is unnecessary.
 3. The emission levels of other frequencies were very low against the limit.
 4. Margin value = Emission level - Limit value
 5. Correction factor = Insertion loss + Cable loss
 6. Emission Level = Correction Factor + Reading Value.

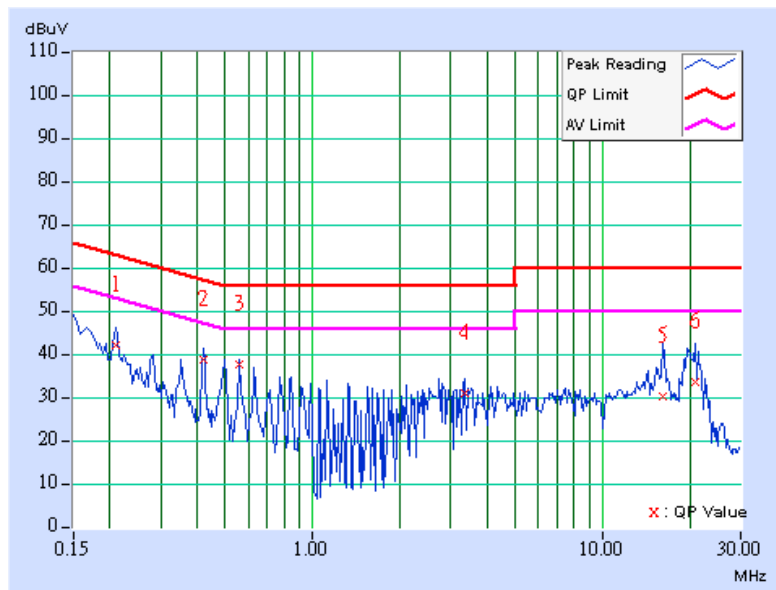



EUT	Wireless 802.11g Cardbus Card	MODEL	WCB-210A
CHANNEL	Channel 11	6dB BANDWIDTH	9 kHz
MODULATION TYPE	BPSK	TRANSFER RATE	6Mbps
INPUT POWER (SYSTEM)	120Vac, 60 Hz	PHASE	Line (L)
ENVIRONMENTAL CONDITIONS	22deg. C, 62%RH, 991hPa	TESTED BY	Brad Wu

No	Freq. [MHz]	Corr. Factor (dB)	Reading Value		Emission Level		Limit		Margin	
			[dB (uV)]		[dB (uV)]		[dB (uV)]		(dB)	
			Q.P.	AV.	Q.P.	AV.	Q.P.	AV.	Q.P.	AV.
1	0.209	0.11	41.47	-	41.58	-	63.26	53.26	-21.68	-
2	0.420	0.12	38.04	-	38.16	-	57.46	47.46	-19.30	-
3	0.634	0.14	33.93	-	34.07	-	56.00	46.00	-21.93	-
4	1.336	0.19	30.83	-	31.02	-	56.00	46.00	-24.98	-
5	14.645	0.62	28.18	-	28.80	-	60.00	50.00	-31.20	-
6	20.645	0.96	34.38	-	35.34	-	60.00	50.00	-24.66	-

- REMARKS:**
1. Q.P. and AV. are abbreviations of quasi-peak and average individually.
 2. "-": The Quasi-peak reading value also meets average limit and measurement with the average detector is unnecessary.
 3. The emission levels of other frequencies were very low against the limit.
 4. Margin value = Emission level - Limit value
 5. Correction factor = Insertion loss + Cable loss
 6. Emission Level = Correction Factor + Reading Value.

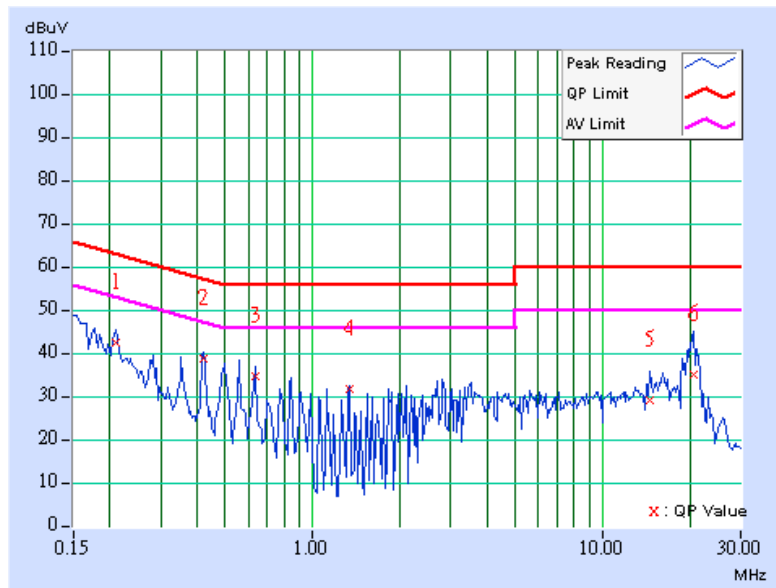



EUT	Wireless 802.11g Cardbus Card	MODEL	WCB-210A
CHANNEL	Channel 11	6dB BANDWIDTH	9 kHz
MODULATION TYPE	BPSK	TRANSFER RATE	6Mbps
INPUT POWER (SYSTEM)	120Vac, 60 Hz	PHASE	Neutral (N)
ENVIRONMENTAL CONDITIONS	22deg. C, 62%RH, 991hPa	TESTED BY	Brad Wu

No	Freq. [MHz]	Corr. Factor (dB)	Reading Value [dB (uV)]		Emission Level [dB (uV)]		Limit [dB (uV)]		Margin (dB)	
			Q.P.	AV.	Q.P.	AV.	Q.P.	AV.	Q.P.	AV.
			1	0.213	0.10	41.20	-	41.30	-	63.11
2	0.420	0.11	38.18	-	38.29	-	57.46	47.46	-19.17	-
3	0.560	0.12	37.23	-	37.35	-	56.00	46.00	-18.65	-
4	1.332	0.19	32.44	-	32.63	-	56.00	46.00	-23.37	-
5	15.699	0.51	28.87	-	29.38	-	60.00	50.00	-30.62	-
6	20.375	0.63	36.20	-	36.83	-	60.00	50.00	-23.17	-

- REMARKS:**
1. Q.P. and AV. are abbreviations of quasi-peak and average individually.
 2. "-": The Quasi-peak reading value also meets average limit and measurement with the average detector is unnecessary.
 3. The emission levels of other frequencies were very low against the limit.
 4. Margin value = Emission level - Limit value
 5. Correction factor = Insertion loss + Cable loss
 6. Emission Level = Correction Factor + Reading Value.

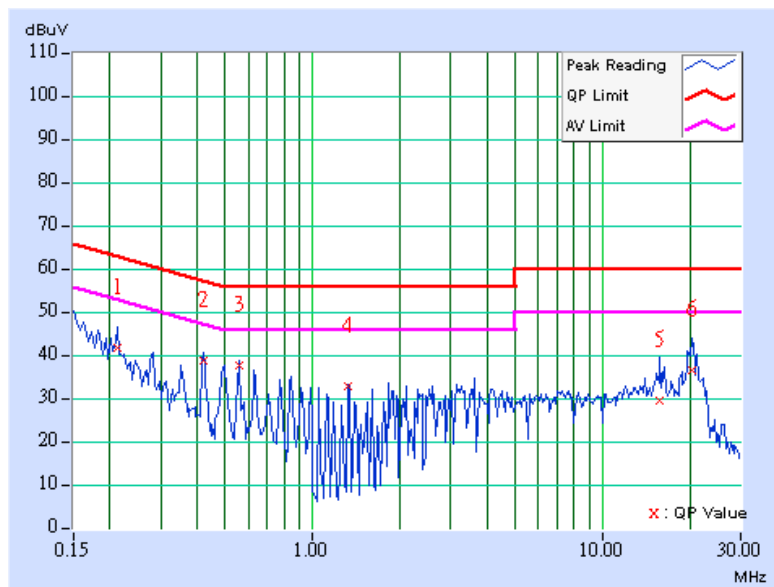



4.2 RADIATED EMISSION MEASUREMENT

4.2.1 LIMITS OF RADIATED EMISSION MEASUREMENT

Emissions radiated outside of the specified bands, shall be according to the general radiated limits in 15.209 as following:

Frequencies (MHz)	Field strength (microvolts/meter)	Measurement distance (meters)
0.009-0.490	2400/F(kHz)	300
0.490-1.705	24000/F(kHz)	30
1.705-30.0	30	30
30-88	100	3
88-216	150	3
216-960	200	3
Above 960	500	3

NOTE:

1. The lower limit shall apply at the transition frequencies.
2. Emission level (dBuV/m) = 20 log Emission level (uV/m).
3. As shown in 15.35(b), for frequencies above 1000MHz, the field strength limits are based on average detector, however, the peak field strength of any emission shall not exceed the maximum permitted average limits, specified above by more than 20dB under any condition of modulation.



4.2.2 TEST INSTRUMENTS

DESCRIPTION & MANUFACTURER	MODEL NO.	SERIAL NO.	CALIBRATED UNTIL
Test Receiver ROHDE & SCHWARZ	ESI7	838496/016	Jan. 07, 2006
Spectrum Analyzer ROHDE & SCHWARZ	FSP40	100041	Nov. 29, 2005
BILOG Antenna SCHWARZBECK	VULB9168	9168-155	Jan. 22, 2006
HORN Antenna SCHWARZBECK	BBHA 9120D	9120D-404	Jan. 05, 2006
HORN Antenna SCHWARZBECK	BBHA 9170	BBHA 9170242	Jan. 23, 2006
Preamplifier Agilent	8447D	2944A10631	Nov. 17, 2005
Preamplifier Agilent	8449B	3008A01960	Nov. 14, 2005
RF signal cable HUBER+SUHNNER	SUCOFLEX 104	219272/4	Jan. 26, 2006
RF signal cable HUBER+SUHNNER	SUCOFLEX 104	219275/4	Jan. 26, 2006
Software ADT.	ADT_Radiated_V5.14	NA	NA
Antenna Tower inn-co GmbH	MA 4000	010303	NA
Antenna Tower Controller inn-co GmbH	CO2000	019303	NA
Turn Table ADT.	TT100.	TT93021704	NA
Turn Table Controller ADT.	SC100.	SC93021704	NA

- NOTE:**
1. The calibration interval of the above test instruments is 12 months and the calibrations are traceable to NML/ROC and NIST/USA.
 2. The test was performed in HwaYa Chamber 3.
 3. The horn antenna and HP preamplifier (model: 8449B) are used only for the measurement of emission frequency above 1GHz if tested.
 4. The IC Site Registration No. is IC4924-4.

4.2.3 TEST PROCEDURES

- a. The EUT was placed on the top of a rotating table 0.8 meters above the ground at a 3 meter semi-anechoic chamber. The table was rotated 360 degrees to determine the position of the highest radiation.
- b. The EUT was set 3 meters away from the interference-receiving antenna, which was mounted on the top of a variable-height antenna tower.
- c. The antenna is a broadband antenna, and its height is varied from one meter to four meters above the ground to determine the maximum value of the field strength. Both horizontal and vertical polarizations of the antenna are set to make the measurement.
- d. For each suspected emission, the EUT was arranged to its worst case and then the antenna was tuned to heights from 1 meter to 4 meters and the rotatable table was turned from 0 degrees to 360 degrees to find the maximum reading.
- e. The test-receiver system was set to Peak Detect Function and Specified Bandwidth with Maximum Hold Mode.
- f. If the emission level of the EUT in peak mode was 10 dB lower than the limit specified, then testing could be stopped and the peak values of the EUT would be reported. Otherwise the emissions that did not have 10 dB margin would be re-tested one by one using the quasi-peak method or average method as specified and then reported in Data sheet peak mode and QP mode.

NOTE:

1. The resolution bandwidth and video bandwidth of test receiver/spectrum analyzer is 120kHz for Quasi-peak detection at frequency below 1GHz.
2. The resolution bandwidth and video bandwidth of test receiver/spectrum analyzer is 1 MHz for Peak detection (PK) at frequency above 1GHz.
3. The resolution bandwidth of test receiver/spectrum analyzer is 1 MHz and the video bandwidth is 10 Hz for Average detection (AV) at frequency above 1GHz.

4.2.4 DEVIATION FROM TEST STANDARD

No deviation

4.2.5 TEST SETUP

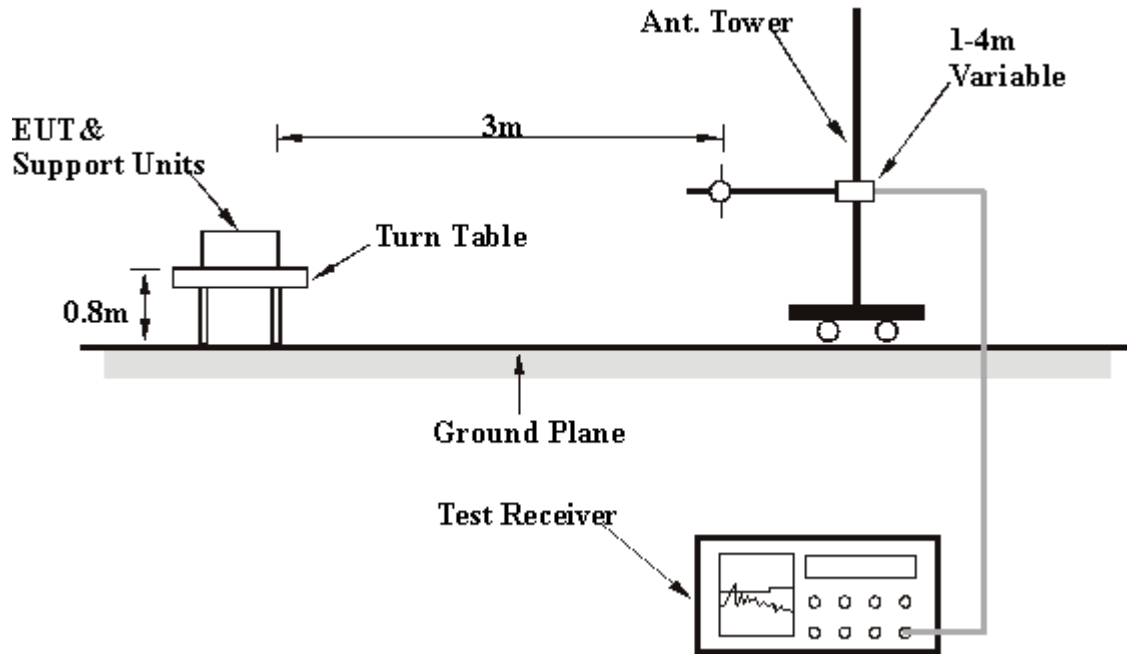

For the actual test configuration, please refer to the related item – Photographs of the Test Configuration.

4.2.6 EUT OPERATING CONDITIONS

Same as 4.1.6



4.2.7 TEST RESULTS

Below 1GHz Worst-Case Data

EUT	Wireless 802.11g Cardbus Card	MODEL	WCB-210A
CHANNEL	Channel 1	FREQUENCY RANGE	Below 1000MHz
MODULATION TYPE	BPSK	TRANSFER RATE	6Mbps
INPUT POWER (SYSTEM)	120Vac, 60 Hz	DETECTOR FUNCTION	Quasi-Peak
ENVIRONMENTAL CONDITIONS	23deg. C, 65%RH, 991hPa	TESTED BY	Brad Wu

ANTENNA POLARITY & TEST DISTANCE: HORIZONTAL AT 3 M

No.	Freq. (MHz)	Emission Level (dBuV/m)	Limit (dBuV/m)	Margin (dB)	Antenna Height (m)	Table Angle (Degree)	Raw Value (dBuV)	Correction Factor (dB/m)
1	146.63	30.08 QP	43.50	-13.42	2.00 H	232	15.48	14.61
2	179.68	28.60 QP	43.50	-14.90	2.00 H	85	15.67	12.93
3	399.34	36.60 QP	46.00	-9.40	1.00 H	325	19.89	16.71
4	531.52	30.69 QP	46.00	-15.31	2.00 H	163	11.56	19.13
5	702.59	36.92 QP	46.00	-9.08	2.00 H	64	14.84	22.07
6	945.57	31.04 QP	46.00	-14.96	2.00 H	178	5.76	25.28

ANTENNA POLARITY & TEST DISTANCE: VERTICAL AT 3 M

No.	Freq. (MHz)	Emission Level (dBuV/m)	Limit (dBuV/m)	Margin (dB)	Antenna Height (m)	Table Angle (Degree)	Raw Value (dBuV)	Correction Factor (dB/m)
1	41.66	32.71 QP	40.00	-7.29	1.00 V	247	17.37	15.34
2	78.60	23.48 QP	40.00	-16.52	1.00 V	235	13.25	10.24
3	133.03	32.04 QP	43.50	-11.46	1.00 V	331	18.15	13.89
4	173.85	30.04 QP	43.50	-13.46	1.00 V	25	16.51	13.53
5	397.39	34.75 QP	46.00	-11.25	1.00 V	34	18.08	16.67
6	521.80	29.33 QP	46.00	-16.67	1.00 V	346	10.37	18.96

- REMARKS:**
1. Emission level(dBuV/m)=Raw Value(dBuV) + Correction Factor(dB/m)
 2. Correction Factor(dB/m) = Antenna Factor (dB/m) + Cable Factor (dB)
 3. The other emission levels were very low against the limit.
 4. Margin value = Emission level – Limit value.

**802.11b DSSS modulation**

EUT	Wireless 802.11g Cardbus Card	MODEL	WCB-210A
CHANNEL	Channel 1	FREQUENCY RANGE	1 ~ 25GHz
MODULATION TYPE	CCK	TRANSFER RATE	11Mbps
INPUT POWER (SYSTEM)	120Vac, 60 Hz	DETECTOR FUNCTION	Peak(PK) Average (AV)
ENVIRONMENTAL CONDITIONS	23deg. C, 65%RH, 991hPa	TESTED BY	Brad Wu

ANTENNA POLARITY & TEST DISTANCE: HORIZONTAL AT 3 M

No.	Freq. (MHz)	Emission Level (dBuV/m)	Limit (dBuV/m)	Margin (dB)	Antenna Height (m)	Table Angle (Degree)	Raw Value (dBuV)	Correction Factor (dB/m)
1	1608.00	41.58 PK	74.00	-32.42	1.06 H	148	12.22	29.36
1	1608.00	33.56 AV	54.00	-20.44	1.06 H	148	4.20	29.36
2	2386.00	53.59 PK	74.00	-20.41	1.00 H	159	21.73	31.86
2	2386.00	45.37 AV	54.00	-8.63	1.00 H	159	13.51	31.86
3	*2412.00	107.60 PK			1.00 H	159	75.64	31.96
3	*2412.00	99.38 AV			1.00 H	159	67.42	31.96
4	3216.00	46.37 PK	74.00	-27.63	1.01 H	317	12.40	33.96
4	3216.00	38.28 AV	54.00	-15.72	1.01 H	317	4.31	33.96
5	4824.00	53.48 PK	74.00	-20.52	1.64 H	326	15.65	37.83
5	4824.00	38.44 AV	54.00	-15.56	1.64 H	326	0.61	37.83
6	7236.00	56.11 PK	74.00	-17.89	1.40 H	283	11.82	44.29
6	7236.00	43.76 AV	54.00	-10.24	1.40 H	283	-0.53	44.29
7	9648.00	56.23 PK	74.00	-17.77	1.25 H	256	8.46	47.77
7	9648.00	48.12 AV	54.00	-5.88	1.25 H	256	0.35	47.77

- REMARKS:**
1. Emission level(dBuV/m)=Raw Value(dBuV) + Correction Factor(dB/m)
 2. Correction Factor(dB/m) = Antenna Factor (dB/m) + Cable Factor (dB)
 3. The other emission levels were very low against the limit.
 4. Margin value = Emission level – Limit value.
 5. “ * ” : Fundamental frequency



EUT	Wireless 802.11g Cardbus Card	MODEL	WCB-210A
CHANNEL	Channel 1	FREQUENCY RANGE	1 ~ 25GHz
MODULATION TYPE	CCK	TRANSFER RATE	11Mbps
INPUT POWER (SYSTEM)	120Vac, 60 Hz	DETECTOR FUNCTION	Peak(PK) Average (AV)
ENVIRONMENTAL CONDITIONS	23deg. C, 65%RH, 991hPa	TESTED BY	Brad Wu

ANTENNA POLARITY & TEST DISTANCE: VERTICAL AT 3 M

No.	Freq. (MHz)	Emission Level (dBuV/m)	Limit (dBuV/m)	Margin (dB)	Antenna Height (m)	Table Angle (Degree)	Raw Value (dBuV)	Correction Factor (dB/m)
1	1608.00	41.72 PK	74.00	-32.28	1.08 V	132	12.36	29.36
1	1608.00	34.03 AV	54.00	-19.97	1.08 V	132	4.67	29.36
2	2386.00	51.18 PK	74.00	-22.82	1.17 V	357	19.32	31.86
2	2386.00	43.09 AV	54.00	-10.91	1.17 V	357	11.23	31.86
3	*2412.00	105.19 PK			1.17 V	357	73.23	31.96
3	*2412.00	97.10 AV			1.17 V	357	65.14	31.96
4	3216.00	46.39 PK	74.00	-27.61	1.29 V	20	12.42	33.96
4	3216.00	37.01 AV	54.00	-16.99	1.29 V	20	3.04	33.96
5	4824.00	55.90 PK	74.00	-18.10	1.09 V	9	18.07	37.83
5	4824.00	41.32 AV	54.00	-12.68	1.09 V	9	3.49	37.83
6	7236.00	59.05 PK	74.00	-14.95	1.41 V	258	14.76	44.29
6	7236.00	47.97 AV	54.00	-6.03	1.41 V	258	3.68	44.29
7	9648.00	58.86 PK	74.00	-15.14	1.38 V	231	11.09	47.77
7	9648.00	50.30 AV	54.00	-3.70	1.38 V	231	2.53	47.77

- REMARKS:**
1. Emission level(dBuV/m)=Raw Value(dBuV) + Correction Factor(dB/m)
 2. Correction Factor(dB/m) = Antenna Factor (dB/m) + Cable Factor (dB)
 3. The other emission levels were very low against the limit.
 4. Margin value = Emission level – Limit value.
 5. “ * “ : Fundamental frequency



EUT	Wireless 802.11g Cardbus Card	MODEL	WCB-210A
CHANNEL	Channel 6	FREQUENCY RANGE	1 ~ 25GHz
MODULATION TYPE	CCK	TRANSFER RATE	11Mbps
INPUT POWER (SYSTEM)	120Vac, 60 Hz	DETECTOR FUNCTION	Peak(PK) Average (AV)
ENVIRONMENTAL CONDITIONS	23deg. C, 65%RH, 991hPa	TESTED BY	Brad Wu

ANTENNA POLARITY & TEST DISTANCE: HORIZONTAL AT 3 M

No.	Freq. (MHz)	Emission Level (dBuV/m)	Limit (dBuV/m)	Margin (dB)	Antenna Height (m)	Table Angle (Degree)	Raw Value (dBuV)	Correction Factor (dB/m)
1	1624.00	41.56 PK	74.00	-32.44	1.09 H	320	12.16	29.40
1	1624.00	34.21 AV	54.00	-19.79	1.09 H	320	4.81	29.40
2	*2437.00	108.30 PK			1.45 H	312	76.24	32.06
2	*2437.00	100.05 AV			1.45 H	312	67.99	32.06
3	3248.00	47.68 PK	74.00	-26.32	1.24 H	332	13.69	33.99
3	3248.00	37.87 AV	54.00	-16.13	1.24 H	332	3.88	33.99
4	4874.00	51.23 PK	74.00	-22.77	1.19 H	64	13.25	37.98
4	4874.00	36.95 AV	54.00	-17.05	1.19 H	64	-1.03	37.98
5	7311.00	56.38 PK	74.00	-17.62	1.05 H	211	11.87	44.51
5	7311.00	46.25 AV	54.00	-7.75	1.05 H	211	1.74	44.51
6	9748.00	54.23 PK	74.00	-19.77	1.14 H	266	6.20	48.03
6	9748.00	46.59 AV	54.00	-7.41	1.14 H	266	-1.44	48.03

ANTENNA POLARITY & TEST DISTANCE: VERTICAL AT 3 M

No.	Freq. (MHz)	Emission Level (dBuV/m)	Limit (dBuV/m)	Margin (dB)	Antenna Height (m)	Table Angle (Degree)	Raw Value (dBuV)	Correction Factor (dB/m)
1	1624.00	40.35 PK	74.00	-33.65	1.05 V	189	10.95	29.40
1	1624.00	33.26 AV	54.00	-20.74	1.05 V	189	3.86	29.40
2	*2437.00	105.62 PK			1.14 V	357	73.56	32.06
2	*2437.00	97.50 AV			1.14 V	357	65.44	32.06
3	3248.00	49.21 PK	74.00	-24.79	1.16 V	208	15.22	33.99
3	3248.00	39.32 AV	54.00	-14.68	1.16 V	208	5.33	33.99
4	4874.00	53.46 PK	74.00	-20.54	1.07 V	65	15.48	37.98
4	4874.00	39.06 AV	54.00	-14.94	1.07 V	65	1.08	37.98
5	7311.00	57.68 PK	74.00	-16.32	1.26 V	331	13.17	44.51
5	7311.00	47.36 AV	54.00	-6.64	1.26 V	331	2.85	44.51
6	9748.00	55.47 PK	74.00	-18.53	1.19 V	263	7.44	48.03
6	9748.00	47.83 AV	54.00	-6.17	1.19 V	263	-0.20	48.03

- REMARKS:**
1. Emission level(dBuV/m)=Raw Value(dBuV) + Correction Factor(dB/m)
 2. Correction Factor(dB/m) = Antenna Factor (dB/m) + Cable Factor (dB)
 3. The other emission levels were very low against the limit.
 4. Margin value = Emission level – Limit value.
 5. " * " : Fundamental frequency



EUT	Wireless 802.11g Cardbus Card	MODEL	WCB-210A
CHANNEL	Channel 11	FREQUENCY RANGE	1 ~ 25GHz
MODULATION TYPE	CCK	TRANSFER RATE	11Mbps
INPUT POWER (SYSTEM)	120Vac, 60 Hz	DETECTOR FUNCTION	Peak(PK) Average (AV)
ENVIRONMENTAL CONDITIONS	23deg. C, 65%RH, 991hPa	TESTED BY	Brad Wu

ANTENNA POLARITY & TEST DISTANCE: HORIZONTAL AT 3 M

No.	Freq. (MHz)	Emission Level (dBuV/m)	Limit (dBuV/m)	Margin (dB)	Antenna Height (m)	Table Angle (Degree)	Raw Value (dBuV)	Correction Factor (dB/m)
1	1641.00	41.26 PK	74.00	-32.74	1.15 H	257	11.81	29.45
1	1641.00	33.89 AV	54.00	-20.11	1.15 H	257	4.44	29.45
2	*2462.00	107.28 PK			1.00 H	179	75.12	32.16
2	*2462.00	99.15 AV			1.00 H	179	66.99	32.16
3	2500.00	47.21 PK	74.00	-26.79	1.00 H	179	14.90	32.31
4	3282.00	46.57 PK	74.00	-27.43	1.05 H	213	12.55	34.02
4	3282.00	37.20 AV	54.00	-16.80	1.05 H	213	3.18	34.02
5	4924.00	50.16 PK	74.00	-23.84	1.16 H	89	12.02	38.14
5	4924.00	35.82 AV	54.00	-18.18	1.16 H	89	-2.32	38.14
6	7386.00	56.89 PK	74.00	-17.11	1.34 H	163	12.21	44.68
6	7386.00	46.28 AV	54.00	-7.72	1.34 H	163	1.60	44.68
7	9848.00	54.16 PK	74.00	-19.84	1.09 H	128	5.84	48.32
7	9848.00	46.38 AV	54.00	-7.62	1.09 H	128	-1.94	48.32

ANTENNA POLARITY & TEST DISTANCE: VERTICAL AT 3 M

No.	Freq. (MHz)	Emission Level (dBuV/m)	Limit (dBuV/m)	Margin (dB)	Antenna Height (m)	Table Angle (Degree)	Raw Value (dBuV)	Correction Factor (dB/m)
1	1641.00	41.88 PK	74.00	-32.12	1.07 V	166	12.43	29.45
1	1641.00	34.25 AV	54.00	-19.75	1.07 V	166	4.80	29.45
2	*2462.00	104.73 PK			1.13 V	356	72.57	32.16
2	*2462.00	96.74 AV			1.13 V	356	64.58	32.16
3	2500.00	44.66 PK	74.00	-29.34	1.13 V	356	12.35	32.31
4	3282.00	46.51 PK	74.00	-27.49	1.05 V	148	12.49	34.02
4	3282.00	37.16 AV	54.00	-16.84	1.05 V	148	3.14	34.02
5	4924.00	51.05 PK	74.00	-22.95	1.38 V	4	12.91	38.14
5	4924.00	36.64 AV	54.00	-17.36	1.38 V	4	-1.50	38.14
6	7386.00	57.21 PK	74.00	-16.79	1.25 V	206	12.53	44.68
6	7386.00	47.35 AV	54.00	-6.65	1.25 V	206	2.67	44.68
7	9848.00	56.23 PK	74.00	-17.77	1.05 V	84	7.91	48.32
7	9848.00	48.51 AV	54.00	-5.49	1.05 V	84	0.19	48.32

- REMARKS:**
1. Emission level(dBuV/m)=Raw Value(dBuV) + Correction Factor(dB/m)
 2. Correction Factor(dB/m) = Antenna Factor (dB/m) + Cable Factor (dB)
 3. The other emission levels were very low against the limit.
 4. Margin value = Emission level – Limit value.
 5. “ * ” : Fundamental frequency



802.11g OFDM modulation

EUT	Wireless 802.11g Cardbus Card	MODEL	WCB-210A
CHANNEL	Channel 1	FREQUENCY RANGE	1 ~ 25GHz
MODULATION TYPE	BPSK	TRANSFER RATE	6Mbps
INPUT POWER (SYSTEM)	120Vac, 60 Hz	DETECTOR FUNCTION	Peak(PK) Average (AV)
ENVIRONMENTAL CONDITIONS	23deg. C, 65%RH, 991hPa	TESTED BY	Brad Wu

ANTENNA POLARITY & TEST DISTANCE: HORIZONTAL AT 3 M

No.	Freq. (MHz)	Emission Level (dBuV/m)	Limit (dBuV/m)	Margin (dB)	Antenna Height (m)	Table Angle (Degree)	Raw Value (dBuV)	Correction Factor (dB/m)
1	1608.00	46.33 PK	74.00	-27.67	1.00 H	133	16.97	29.36
1	1608.00	41.47 AV	54.00	-12.53	1.00 H	133	12.11	29.36
2	2390.00	60.04 PK	74.00	-13.96	1.00 H	157	28.17	31.87
2	2390.00	48.46 AV	54.00	-5.54	1.00 H	157	16.59	31.87
3	*2412.00	104.80 PK			1.00 H	157	72.84	31.96
3	*2412.00	93.22 AV			1.00 H	157	61.26	31.96
4	3216.00	46.75 PK	74.00	-27.25	1.06 H	231	12.79	33.96
4	3216.00	39.88 AV	54.00	-14.12	1.06 H	231	5.92	33.96
5	4824.00	51.26 PK	74.00	-22.74	1.15 H	106	13.43	37.83
5	4824.00	36.07 AV	54.00	-17.93	1.15 H	106	-1.76	37.83
6	7236.00	58.69 PK	74.00	-15.31	1.56 H	203	14.40	44.29
6	7236.00	42.76 AV	54.00	-11.24	1.56 H	203	-1.53	44.29

ANTENNA POLARITY & TEST DISTANCE: VERTICAL AT 3 M

No.	Freq. (MHz)	Emission Level (dBuV/m)	Limit (dBuV/m)	Margin (dB)	Antenna Height (m)	Table Angle (Degree)	Raw Value (dBuV)	Correction Factor (dB/m)
1	1608.00	43.80 PK	74.00	-30.20	1.95 V	203	14.44	29.36
1	1608.00	37.77 AV	54.00	-16.23	1.95 V	203	8.41	29.36
2	2390.00	53.80 PK	74.00	-20.20	1.04 V	61	21.93	31.87
2	2390.00	42.82 AV	54.00	-11.18	1.04 V	61	10.95	31.87
3	*2412.00	98.56 PK			1.04 V	61	66.60	31.96
3	*2412.00	87.58 AV			1.04 V	61	55.62	31.96
4	3216.00	48.55 PK	74.00	-25.45	1.54 V	188	14.58	33.96
4	3216.00	41.69 AV	54.00	-12.31	1.54 V	188	7.72	33.96
5	4824.00	52.18 PK	74.00	-21.82	1.20 V	252	14.35	37.83
5	4824.00	37.21 AV	54.00	-16.79	1.20 V	252	-0.62	37.83
6	7236.00	59.39 PK	74.00	-14.61	1.82 V	71	15.10	44.29
6	7236.00	43.82 AV	54.00	-10.18	1.82 V	71	-0.47	44.29

- REMARKS:**
1. Emission level(dBuV/m)=Raw Value(dBuV) + Correction Factor(dB/m)
 2. Correction Factor(dB/m) = Antenna Factor (dB/m) + Cable Factor (dB)
 3. The other emission levels were very low against the limit.
 4. Margin value = Emission level – Limit value.

5. " * " : Fundamental frequency

EUT	Wireless 802.11g Cardbus Card	MODEL	WCB-210A
CHANNEL	Channel 6	FREQUENCY RANGE	1 ~ 25GHz
MODULATION TYPE	BPSK	TRANSFER RATE	6Mbps
INPUT POWER (SYSTEM)	120Vac, 60 Hz	DETECTOR FUNCTION	Peak(PK) Average (AV)
ENVIRONMENTAL CONDITIONS	23deg. C, 65%RH, 991hPa	TESTED BY	Brad Wu

ANTENNA POLARITY & TEST DISTANCE: HORIZONTAL AT 3 M

No.	Freq. (MHz)	Emission Level (dBuV/m)	Limit (dBuV/m)	Margin (dB)	Antenna Height (m)	Table Angle (Degree)	Raw Value (dBuV)	Correction Factor (dB/m)
1	1624.00	44.13 PK	74.00	-29.87	1.16 H	277	14.73	29.40
1	1624.00	38.26 AV	54.00	-15.74	1.16 H	277	8.86	29.40
2	*2437.00	104.72 PK			1.48 H	155	72.66	32.06
2	*2437.00	93.79 AV			1.48 H	155	61.73	32.06
3	3248.00	49.16 PK	74.00	-24.84	1.16 H	326	15.17	33.99
3	3248.00	42.39 AV	54.00	-11.61	1.16 H	326	8.40	33.99
4	4874.00	52.34 PK	74.00	-21.66	1.06 H	94	14.36	37.98
4	4874.00	37.62 AV	54.00	-16.38	1.06 H	94	-0.36	37.98
5	7311.00	59.47 PK	74.00	-14.53	1.14 H	268	14.96	44.51
5	7311.00	43.26 AV	54.00	-10.74	1.14 H	268	-1.25	44.51

ANTENNA POLARITY & TEST DISTANCE: VERTICAL AT 3 M

No.	Freq. (MHz)	Emission Level (dBuV/m)	Limit (dBuV/m)	Margin (dB)	Antenna Height (m)	Table Angle (Degree)	Raw Value (dBuV)	Correction Factor (dB/m)
1	1624.00	43.26 PK	74.00	-30.74	1.05 V	204	13.86	29.40
1	1624.00	37.51 AV	54.00	-16.49	1.05 V	204	8.11	29.40
2	*2437.00	100.11 PK			1.15 V	176	68.05	32.06
2	*2437.00	90.43 AV			1.15 V	176	58.37	32.06
3	3248.00	49.23 PK	74.00	-24.77	1.19 V	286	15.24	33.99
3	3248.00	42.51 AV	54.00	-11.49	1.19 V	286	8.52	33.99
4	4874.00	53.61 PK	74.00	-20.39	1.25 V	203	15.63	37.98
4	4874.00	38.49 AV	54.00	-15.51	1.25 V	203	0.51	37.98
5	7311.00	60.23 PK	74.00	-13.77	1.06 V	85	15.72	44.51
5	7311.00	44.92 AV	54.00	-9.08	1.06 V	85	0.41	44.51

- REMARKS:**
1. Emission level(dBuV/m)=Raw Value(dBuV) + Correction Factor(dB/m)
 2. Correction Factor(dB/m) = Antenna Factor (dB/m) + Cable Factor (dB)
 3. The other emission levels were very low against the limit.
 4. Margin value = Emission level – Limit value.
 5. " * " : Fundamental frequency



EUT	Wireless 802.11g Cardbus Card	MODEL	WCB-210A
CHANNEL	Channel 11	FREQUENCY RANGE	1 ~ 25GHz
MODULATION TYPE	BPSK	TRANSFER RATE	6Mbps
INPUT POWER (SYSTEM)	120Vac, 60 Hz	DETECTOR FUNCTION	Peak(PK) Average (AV)
ENVIRONMENTAL CONDITIONS	23deg. C, 65%RH, 991hPa	TESTED BY	Brad Wu

ANTENNA POLARITY & TEST DISTANCE: HORIZONTAL AT 3 M

No.	Freq. (MHz)	Emission Level (dBuV/m)	Limit (dBuV/m)	Margin (dB)	Antenna Height (m)	Table Angle (Degree)	Raw Value (dBuV)	Correction Factor (dB/m)
1	1641.00	44.53 PK	74.00	-29.47	1.12 H	153	15.08	29.45
1	1641.00	36.81 AV	54.00	-17.19	1.12 H	153	7.36	29.45
2	*2462.00	103.31 PK			1.00 H	180	71.15	32.16
2	*2462.00	92.73 AV			1.00 H	180	60.57	32.16
3	2483.50	58.77 PK	74.00	-15.23	1.00 H	180	26.53	32.24
3	2483.50	48.19 AV	54.00	-5.81	1.00 H	180	15.95	32.24
4	3282.00	48.25 PK	74.00	-25.75	1.06 H	214	14.23	34.02
4	3282.00	39.30 AV	54.00	-14.70	1.06 H	214	5.28	34.02
5	4924.00	49.31 PK	74.00	-24.69	1.17 H	50	11.17	38.14
5	4924.00	34.87 AV	54.00	-19.13	1.17 H	50	-3.27	38.14
6	7386.00	54.71 PK	74.00	-19.29	1.06 H	233	10.03	44.68
6	7386.00	44.16 AV	54.00	-9.84	1.06 H	233	-0.52	44.68

ANTENNA POLARITY & TEST DISTANCE: VERTICAL AT 3 M

No.	Freq. (MHz)	Emission Level (dBuV/m)	Limit (dBuV/m)	Margin (dB)	Antenna Height (m)	Table Angle (Degree)	Raw Value (dBuV)	Correction Factor (dB/m)
1	1641.00	45.05 PK	74.00	-28.95	1.06 V	224	15.60	29.45
1	1641.00	37.51 AV	54.00	-16.49	1.06 V	224	8.06	29.45
2	*2462.00	100.36 PK			1.00 V	80	68.20	32.16
2	*2462.00	90.36 AV			1.00 V	80	58.20	32.16
3	2483.50	55.82 PK	74.00	-18.18	1.00 V	80	23.58	32.24
3	2483.50	45.82 AV	54.00	-8.18	1.00 V	80	13.58	32.24
4	3282.00	49.21 PK	74.00	-24.79	1.06 V	92	15.19	34.02
4	3282.00	40.13 AV	54.00	-13.87	1.06 V	92	6.11	34.02
5	4924.00	48.76 PK	74.00	-25.24	1.15 V	109	10.62	38.14
5	4924.00	34.15 AV	54.00	-19.85	1.15 V	109	-3.99	38.14
6	7386.00	53.22 PK	74.00	-20.78	1.26 V	23	8.54	44.68
6	7386.00	42.86 AV	54.00	-11.14	1.26 V	23	-1.82	44.68

- REMARKS:**
1. Emission level(dBuV/m)=Raw Value(dBuV) + Correction Factor(dB/m)
 2. Correction Factor(dB/m) = Antenna Factor (dB/m) + Cable Factor (dB)
 3. The other emission levels were very low against the limit.
 4. Margin value = Emission level – Limit value.
 5. “ * “ : Fundamental frequency

4.3 6dB BANDWIDTH MEASUREMENT

4.3.1 LIMITS OF 6dB BANDWIDTH MEASUREMENT

The minimum of 6dB Bandwidth Measurement is 0.5 MHz.

4.3.2 TEST INSTRUMENTS

Description & Manufacturer	Model No.	Serial No.	Calibrated Until
SPECTRUM ANALYZER	FSEK 30	100049	Aug. 12, 2005

NOTE: The calibration interval of the above test instruments is 12 months and the calibrations are traceable to NML/ROC and NIST/USA.

4.3.3 TEST PROCEDURE

The transmitter output was connected to the spectrum analyzer through an attenuator. The bandwidth of the fundamental frequency was measured by spectrum analyzer with 100kHz RBW and 100kHz VBW. The 6dB bandwidth is defined as the total spectrum the power of which is higher than peak power minus 6dB.

4.3.4 DEVIATION FROM TEST STANDARD

No deviation

4.3.5 TEST SETUP



4.3.6 EUT OPERATING CONDITIONS

The software provided by client to enable the EUT under transmission condition continuously at lowest, middle and highest channel frequencies individually.



4.3.7 TEST RESULTS

802.11b DSSS modulation

EUT	Wireless 802.11g Cardbus Card	MODEL	WCB-210A
MODULATION TYPE	CCK	TRANSFER RATE	11Mbps
INPUT POWER (SYSTEM)	120Vac, 60 Hz	ENVIRONMENTAL CONDITIONS	25deg. C, 52%RH, 991hPa
TESTED BY	Gary Chang		

CHANNEL	CHANNEL FREQUENCY (MHz)	6dB BANDWIDTH (MHz)	MINIMUM LIMIT (MHz)	PASS/FAIL
1	2412	12.38	0.5	PASS
6	2437	12.32	0.5	PASS
11	2462	12.28	0.5	PASS



CH1

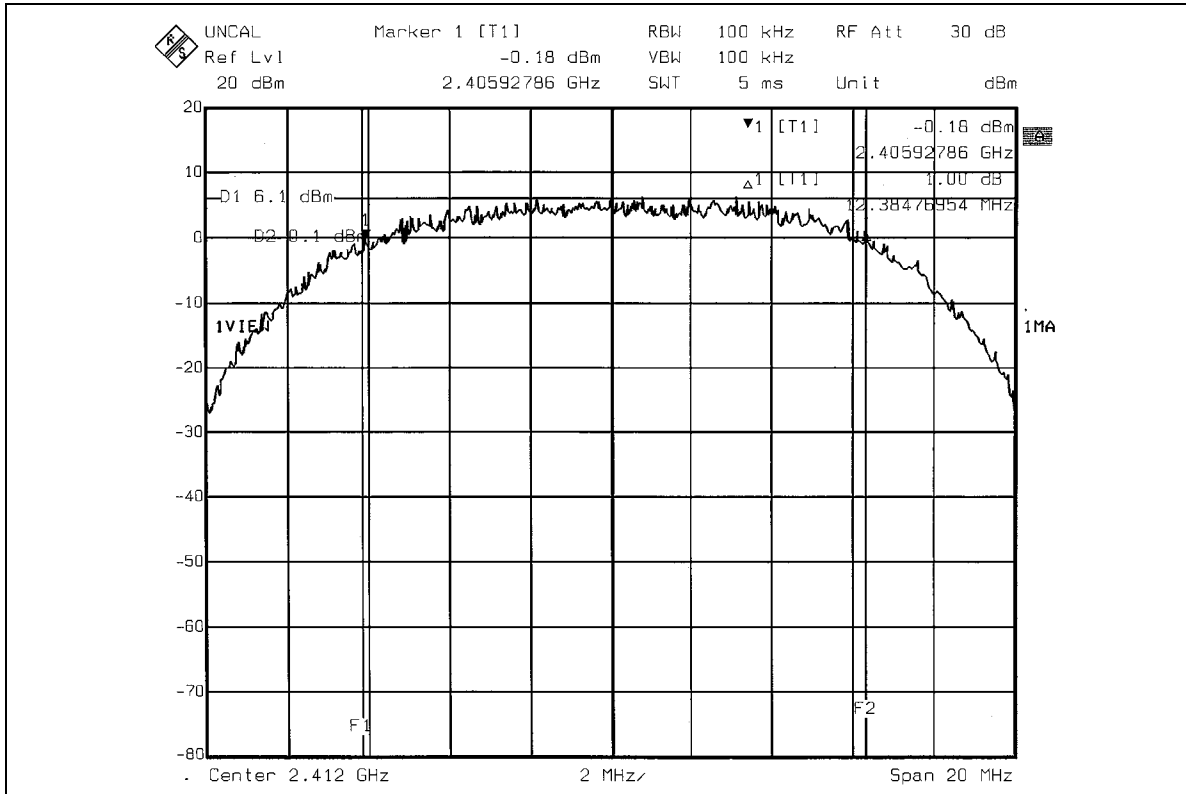

CH6

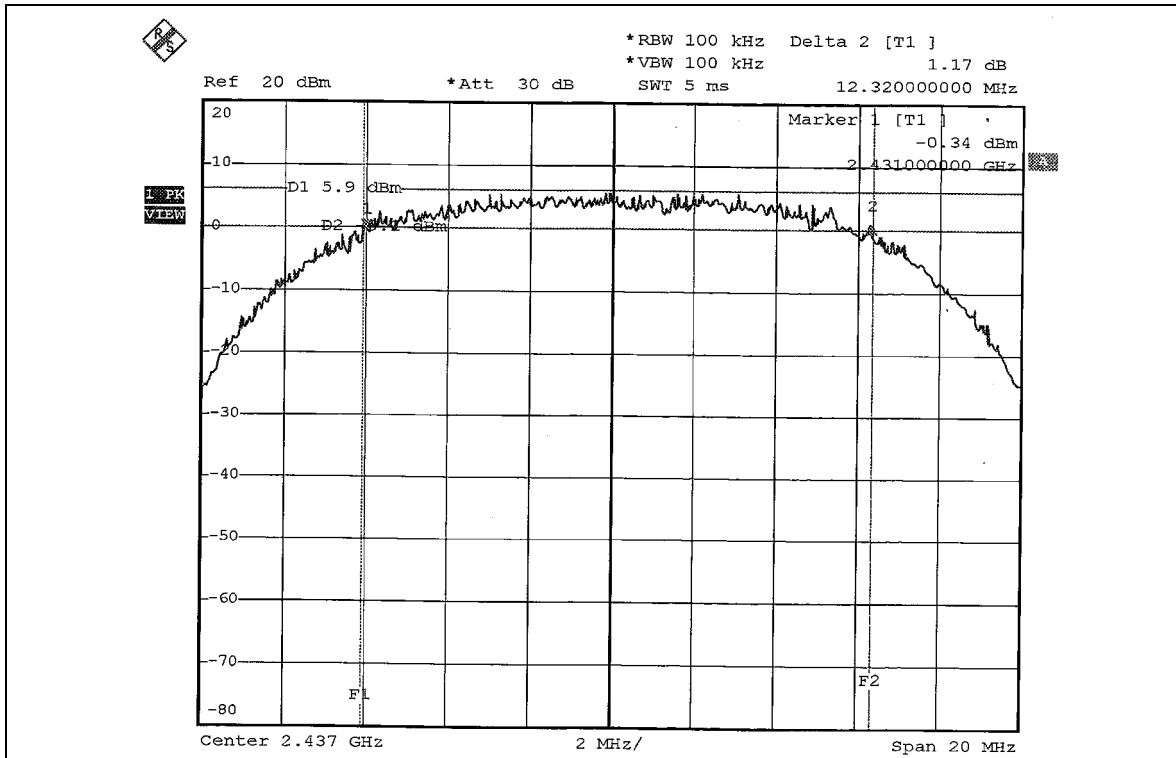



CH11

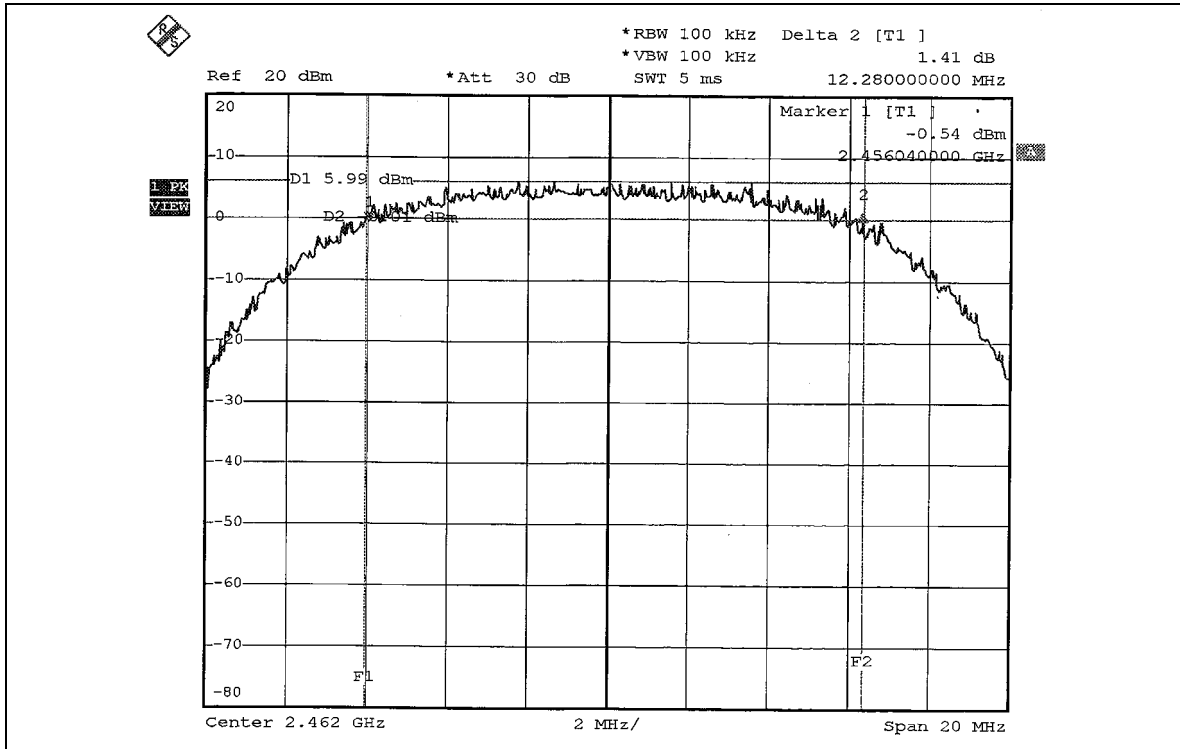



802.11g OFDM modulation

EUT	Wireless 802.11g Cardbus Card	MODEL	WCB-210A
MODULATION TYPE	BPSK	TRANSFER RATE	6Mbps
INPUT POWER (SYSTEM)	120Vac, 60 Hz	ENVIRONMENTAL CONDITIONS	25deg. C, 52%RH, 991hPa
TESTED BY	Gary Chang		

CHANNEL	CHANNEL FREQUENCY (MHz)	6dB BANDWIDTH (MHz)	MINIMUM LIMIT (MHz)	PASS/FAIL
1	2412	16.40	0.5	PASS
6	2437	16.44	0.5	PASS
11	2462	16.40	0.5	PASS



CH1

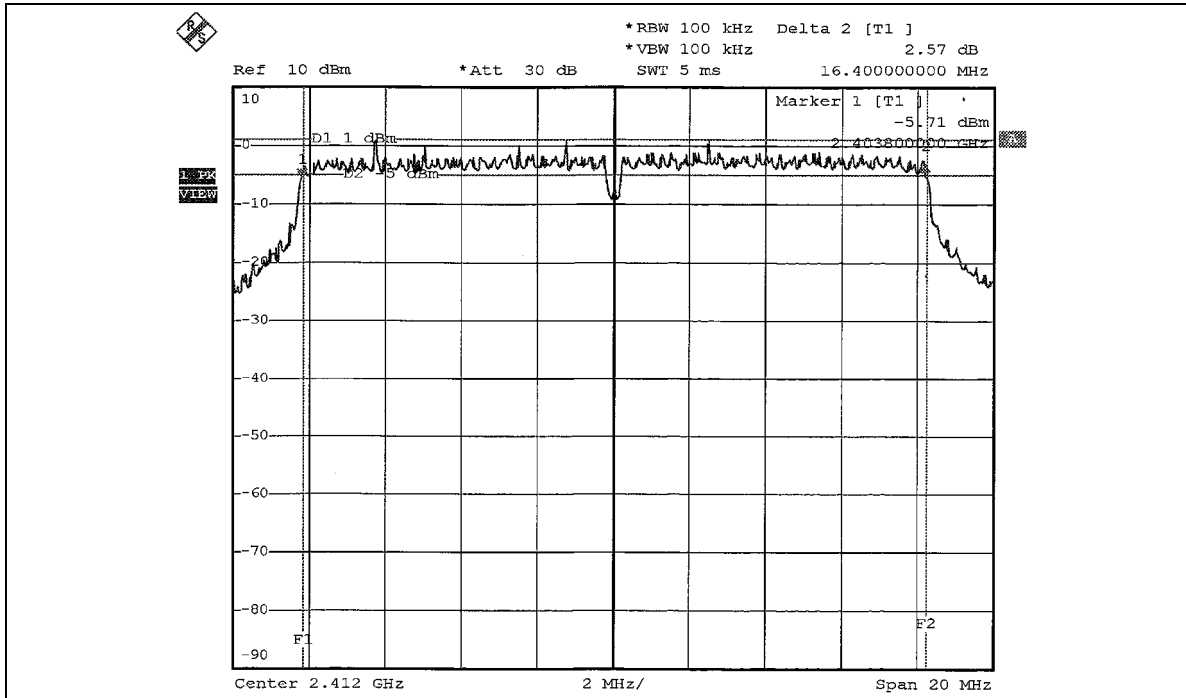

CH6

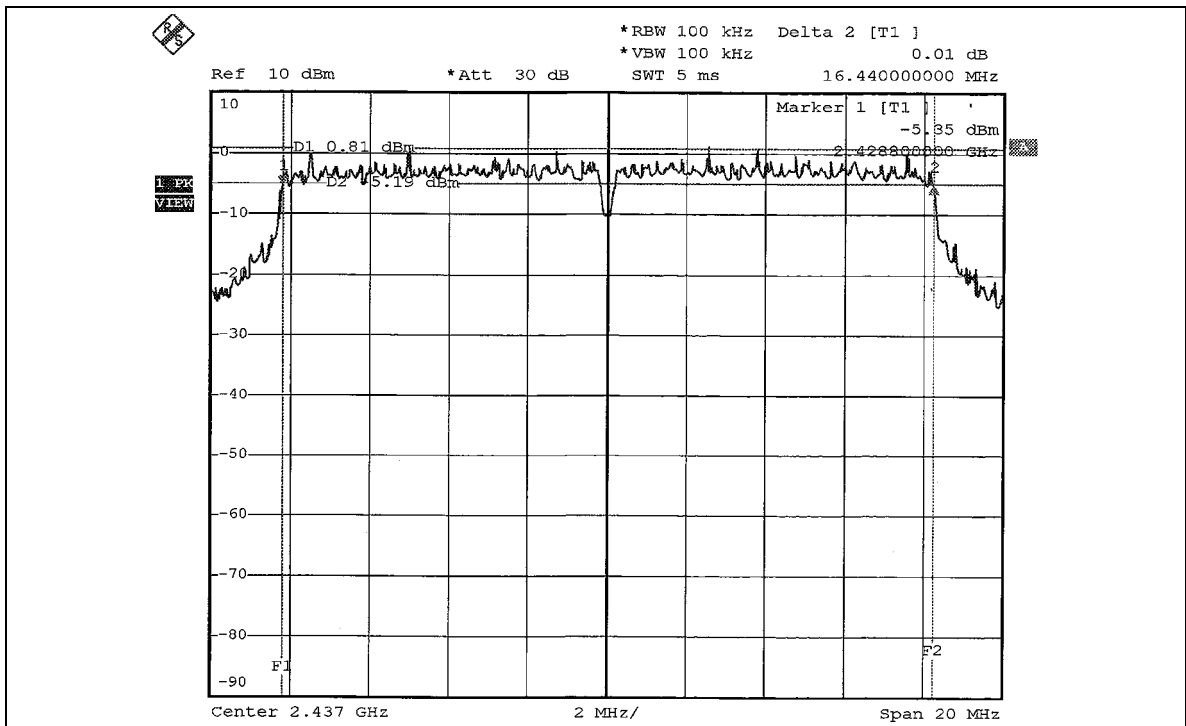



CH11

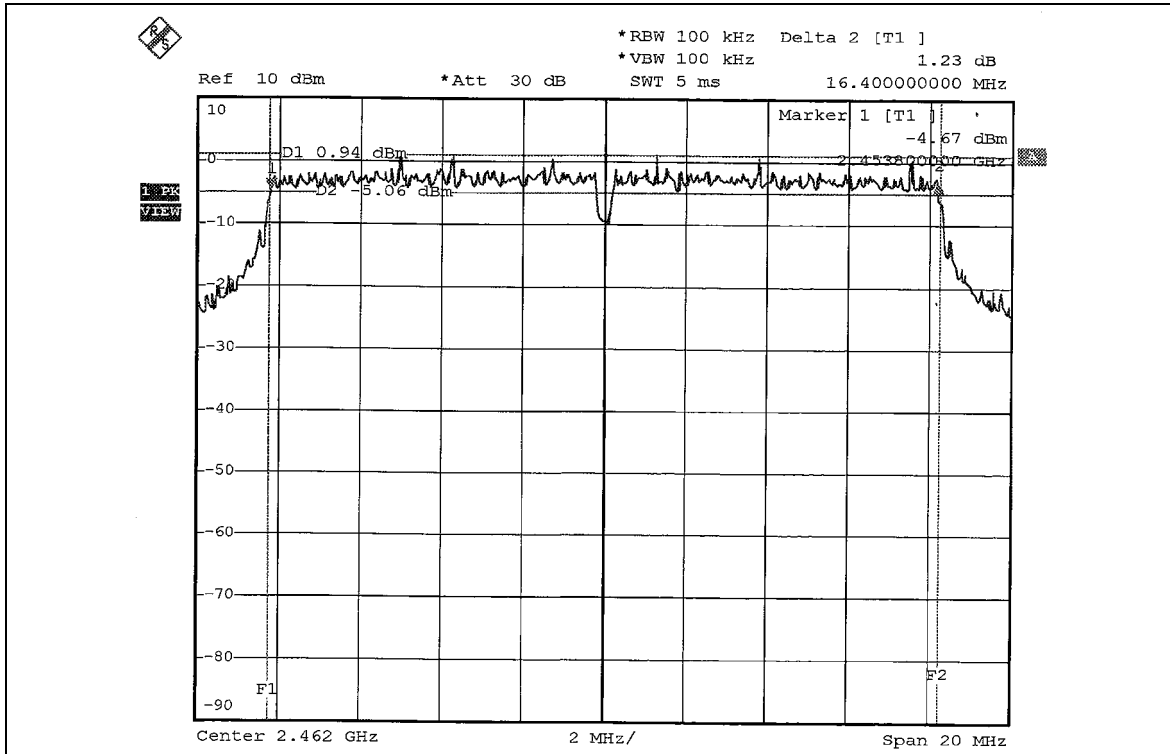



4.4 MAXIMUM PEAK OUTPUT POWER

4.4.1 LIMITS OF MAXIMUM PEAK OUTPUT POWER MEASUREMENT

The Maximum Peak Output Power Measurement is 30dBm.

4.4.2 INSTRUMENTS

Description & Manufacturer	Model No.	Serial No.	Calibrated Until
R&S SPECTRUM ANALYZER	FSEK30	100049	Aug. 12, 2005
AGILENT SIGNAL GENERATOR	E8257C	MY43320668	Dec. 06, 2005
DIGITAL RT OSCILLOSCOPE	TDS1012	C037299	Dec. 07, 2005
NARDA DETECTOR	4503A	FSCM99899	NA

NOTE:

The calibration interval of the above test instruments is 12 months and the calibrations are traceable to NML/ROC and NIST/USA..

4.4.3 TEST PROCEDURES

1. A detector was used on the output port of the EUT. An oscilloscope was used to read the response of the detector.
2. Replaced the EUT by the signal generator. The center frequency of the S.G was adjusted to the center frequency of the measured channel.
3. Adjusted the power to have the same reading on oscilloscope. Record the power level.

4.4.4 DEVIATION FROM TEST STANDARD

No deviation

4.4.5 TEST SETUP



4.4.6 EUT OPERATING CONDITIONS

Same as Item 4.3.6



4.4.7 TEST RESULTS

802.11b DSSS modulation

EUT	Wireless 802.11g Cardbus Card	MODEL	WCB-210A
MODULATION TYPE	CCK	TRANSFER RATE	11Mbps
INPUT POWER (SYSTEM)	120Vac, 60 Hz	ENVIRONMENTAL CONDITIONS	25deg. C, 52%RH, 991hPa
TESTED BY	Gary Chang		

CHANNEL	CHANNEL FREQUENCY (MHz)	PEAK POWER OUTPUT (mW)	PEAK POWER OUTPUT (dBm)	PEAK POWER LIMIT (dBm)	PASS/FAIL
1	2412	66.069	18.20	30	PASS
6	2437	66.988	18.26	30	PASS
11	2462	66.527	18.23	30	PASS

802.11g OFDM modulation

EUT	Wireless 802.11g Cardbus Card	MODEL	WCB-210A
MODULATION TYPE	BPSK	TRANSFER RATE	6Mbps
INPUT POWER (SYSTEM)	120Vac, 60 Hz	ENVIRONMENTAL CONDITIONS	25deg. C, 52%RH, 991hPa
TESTED BY	Gary Chang		

CHANNEL	CHANNEL FREQUENCY (MHz)	PEAK POWER OUTPUT (mW)	PEAK POWER OUTPUT (dBm)	PEAK POWER LIMIT (dBm)	PASS/FAIL
1	2412	57.280	17.58	30	PASS
6	2437	58.076	17.64	30	PASS
11	2462	58.479	17.67	30	PASS



4.5 POWER SPECTRAL DENSITY MEASUREMENT

4.5.1 LIMITS OF POWER SPECTRAL DENSITY MEASUREMENT

The Maximum of Power Spectral Density Measurement is 8dBm.

4.5.2 TEST INSTRUMENTS

Description & Manufacturer	Model No.	Serial No.	Calibrated Until
R&S SPECTRUM ANALYZER	FSEK30	100049	Aug. 12, 2005

NOTE:

The calibration interval of the above test instruments is 12 months and the calibrations are traceable to NML/ROC and NIST/USA.

4.5.3 TEST PROCEDURE

The transmitter output was connected to the spectrum analyzer through an attenuator, the bandwidth of the fundamental frequency was measured with the spectrum analyzer using 3kHz RBW and 30kHz VBW, set sweep time = span/3kHz. The power spectral density was measured and recorded. The sweep time is allowed to be longer than span/3kHz for a full response of the mixer in the spectrum analyzer.

4.5.4 DEVIATION FROM TEST STANDARD

No deviation

4.5.5 TEST SETUP

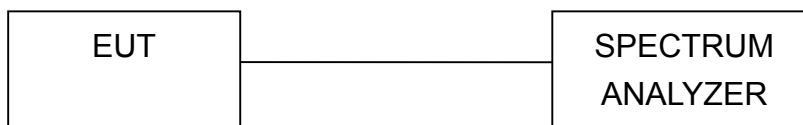

4.5.6 EUT OPERATING CONDITION

Same as Item 4.3.6



4.5.7 TEST RESULTS

802.11b DSSS modulation

EUT	Wireless 802.11g Cardbus Card	MODEL	WCB-210A
MODULATION TYPE	CCK	TRANSFER RATE	11Mbps
INPUT POWER (SYSTEM)	120Vac, 60 Hz	ENVIRONMENTAL CONDITIONS	25deg. C, 52%RH, 991hPa
TESTED BY	Gary Chang		

CHANNEL	CHANNEL FREQUENCY (MHz)	RF POWER LEVEL IN 3kHz BW (dBm)	MAXIMUM LIMIT (dBm)	PASS/FAIL
1	2412	-7.53	8	PASS
6	2437	-7.65	8	PASS
11	2462	-7.58	8	PASS



CH1

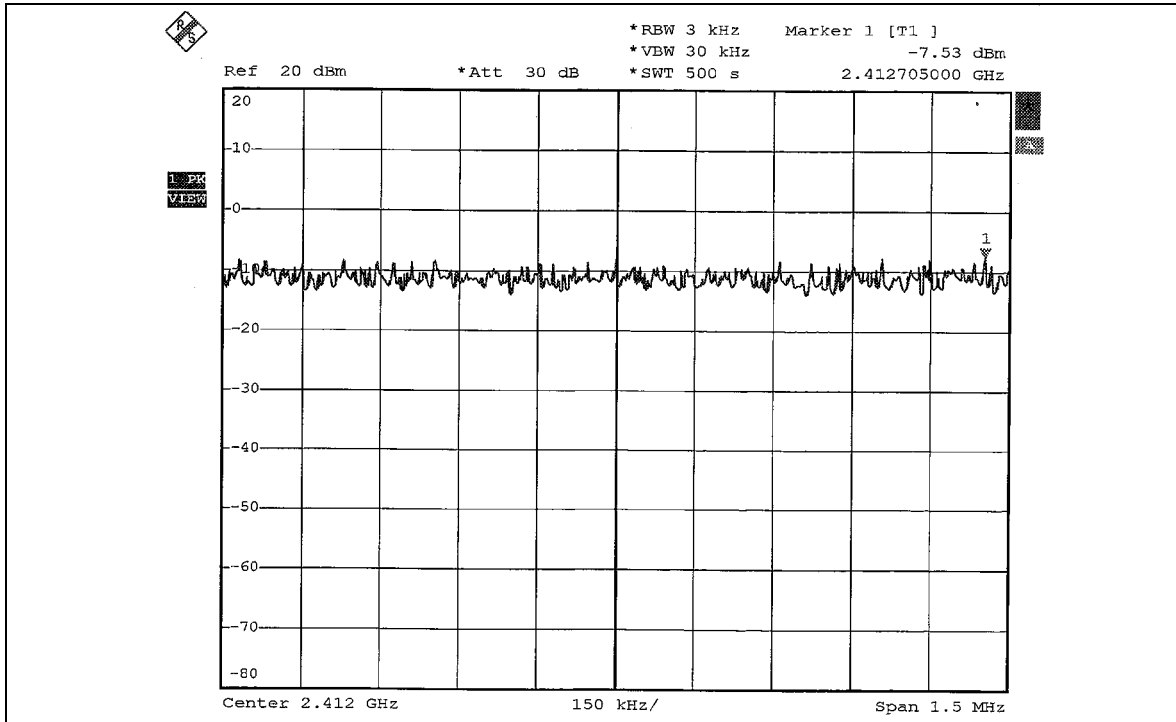

CH6

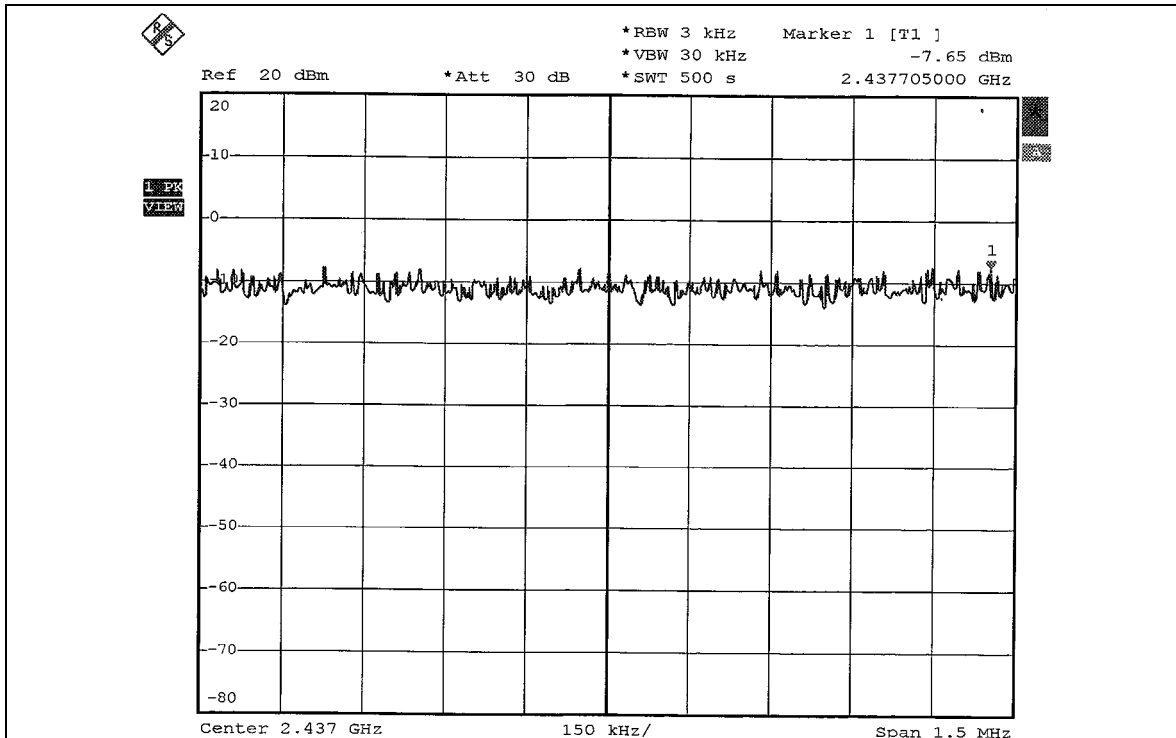



CH11

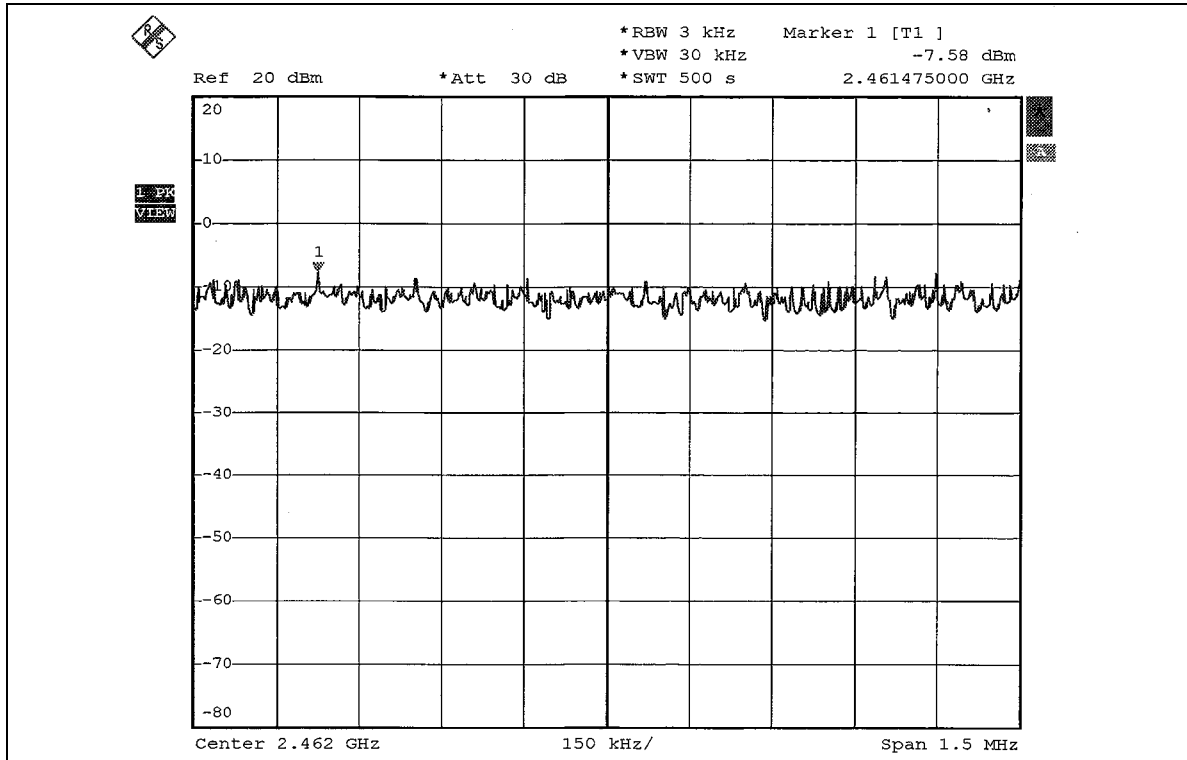

**802.11g OFDM modulation**

EUT	Wireless 802.11g Cardbus Card	MODEL	WCB-210A
MODULATION TYPE	BPSK	TRANSFER RATE	6Mbps
INPUT POWER (SYSTEM)	120Vac, 60 Hz	ENVIRONMENTAL CONDITIONS	25deg. C, 52%RH, 991hPa
TESTED BY	Gary Chang		

CHANNEL	CHANNEL FREQUENCY (MHz)	RF POWER LEVEL IN 3kHz BW (dBm)	MAXIMUM LIMIT (dBm)	PASS/FAIL
1	2412	-12.77	8	PASS
6	2437	-12.36	8	PASS
11	2462	-12.72	8	PASS



CH1

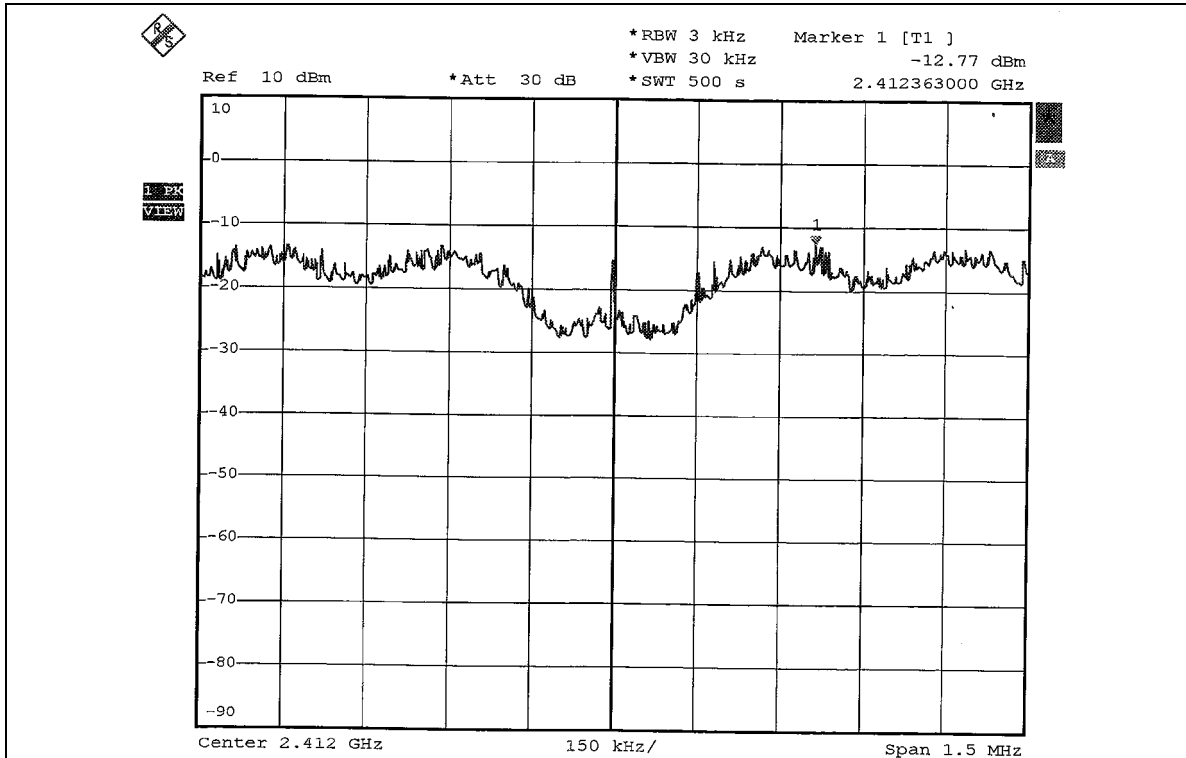

CH6

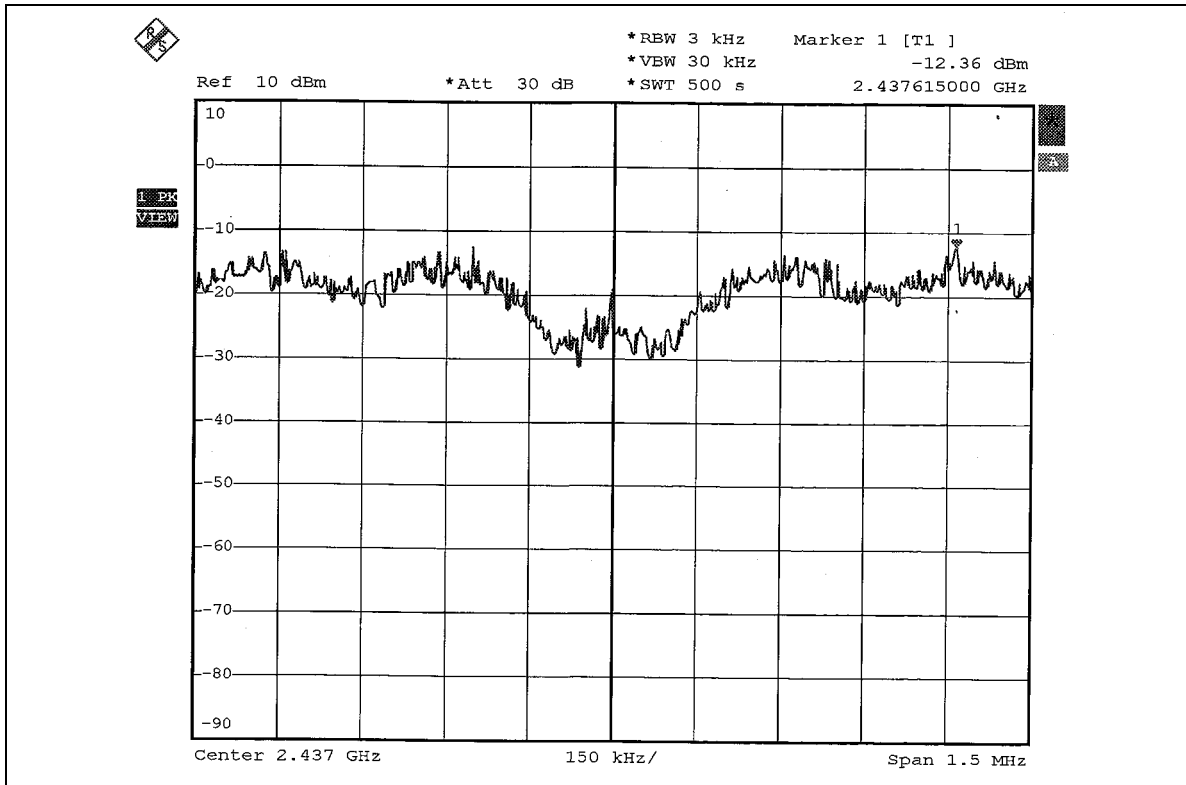



CH11

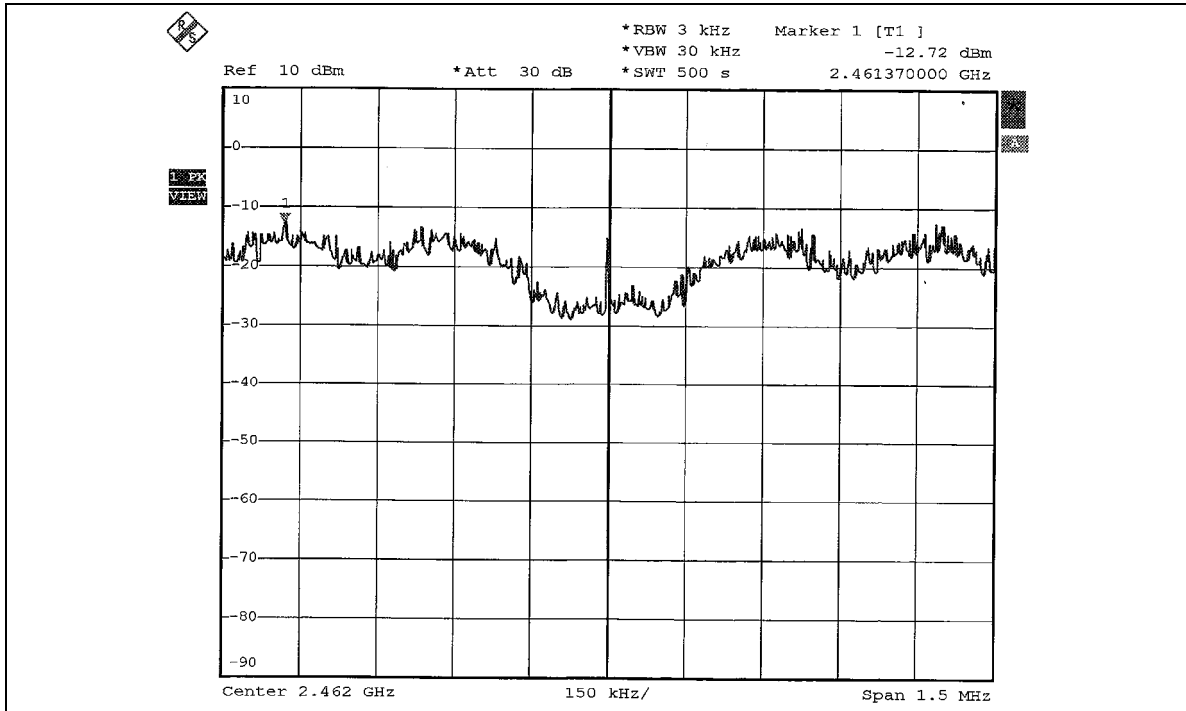



4.6 BAND EDGES MEASUREMENT

4.6.1 LIMITS OF BAND EDGES MEASUREMENT

Below -20dB of the highest emission level of operating band (in 100kHz Resolution Bandwidth).

4.6.2 TEST INSTRUMENTS

Description & Manufacturer	Model No.	Serial No.	Calibrated Until
R&S SPECTRUM ANALYZER	FSEK30	100049	Aug. 12, 2005

NOTE: The calibration interval of the above test instruments is 12 months and the calibrations are traceable to NML/ROC and NIST/USA.

4.6.3 TEST PROCEDURE

The transmitter output was connected to the spectrum analyzer via a low lose cable. Set both RBW and VBW of spectrum analyzer to 100 kHz and 100 kHz with suitable frequency span including 100 MHz bandwidth from band edge. The band edges was measured and recorded.

The spectrum plots (Peak RBW=VBW=100kHz ; Average RBW=1MHz, VBW=10Hz) are attached on the following pages.

4.6.4 DEVIATION FROM TEST STANDARD

No deviation

4.6.5 EUT OPERATING CONDITION

Same as Item 4.3.6

4.6.6 TEST RESULTS

The spectrum plots are attached on the following 12 images. D2 line indicates the highest level, and D1 line indicates the 20dB offset below D2. It shows compliance with the requirement in part 15.247(d).

4.6.7 TEST RESULTS

802.11b DSSS modulation

NOTE 1: The band edge emission plot on page 53 show 53.44dBc delta between carrier maximum power and local maximum emission in restrict band (2.3886GHz). The emission of carrier strength list in the test result of channel 1 at the item 4.2.7 is 107.60dBuV/m (Peak), so the maximum field strength in restrict band is $107.60 - 53.44 = 54.16$ dBuV/m which is under 74dBuV/m limit.

The band edge emission plot on page 53 show 60.04dBc delta between carrier maximum power and local maximum emission in restrict band (2.3600GHz). The emission of carrier strength list in the test result of channel 1 at the item 4.2.7 is 99.38dBuV/m (Average), so the maximum field strength in restrict band is $99.38 - 60.04 = 39.34$ dBuV/m which is under 54dBuV/m limit.

NOTE 2: The band edge emission plot on the page 54 show 54.55dBc delta between carrier maximum power and local maximum emission in restrict band (2.4998GHz). The emission of carrier strength list in the test result of channel 11 at the item 4.2.7 is 107.28dBuV/m (Peak), so the maximum field strength in restrict band is $107.28 - 54.55 = 52.73$ dBuV/m which is under 74dBuV/m limit.

The band edge emission plot on the page 55 show 60.28dBc delta between carrier maximum power and local maximum emission in restrict band (2.5000GHz). The emission of carrier strength list in the test result of channel 11 at the item 4.2.7 is 99.15dBuV/m (Average), so the maximum field strength in restrict band is $99.15 - 60.28 = 38.87$ dBuV/m which is under 54dBuV/m limit.

**802.11g OFDM modulation**

NOTE 1: The band edge emission plot on page 56 show 50.95dBc delta between carrier maximum power and local maximum emission in restrict band (2.3890GHz). The emission of carrier strength list in the test result of channel 1 at the item 4.2.7 is 104.80dBuV/m (Peak), so the maximum field strength in restrict band is $104.80 - 50.95 = 53.85$ dBuV/m which is under 74dBuV/m limit.

The band edge emission plot on page 56 show 51.63dBc delta between carrier maximum power and local maximum emission in restrict band (2.3900GHz). The emission of carrier strength list in the test result of channel 1 at the item 4.2.7 is 93.22dBuV/m (Average), so the maximum field strength in restrict band is $93.22 - 51.63 = 41.59$ dBuV/m which is under 54dBuV/m limit.

NOTE 2: The band edge emission plot on page 57 show 53.43dBc delta between carrier maximum power and local maximum emission in restrict band (2.4835GHz). The emission of carrier strength list in the test result of channel 11 at the item 4.2.7 is 103.31dBuV/m (Peak), so the maximum field strength in restrict band is $103.31 - 53.43 = 49.88$ dBuV/m which is under 74dBuV/m limit.

The band edge emission plot on page 58 show 54.00dBc delta between carrier maximum power and local maximum emission in restrict band (2.4835GHz). The emission of carrier strength list in the test result of channel 11 at the item 4.2.7 is 92.73dBuV/m (Average), so the maximum field strength in restrict band is $92.73 - 54.00 = 38.73$ dBuV/m which is under 54dBuV/m limit.



802.11b DSSS modulation

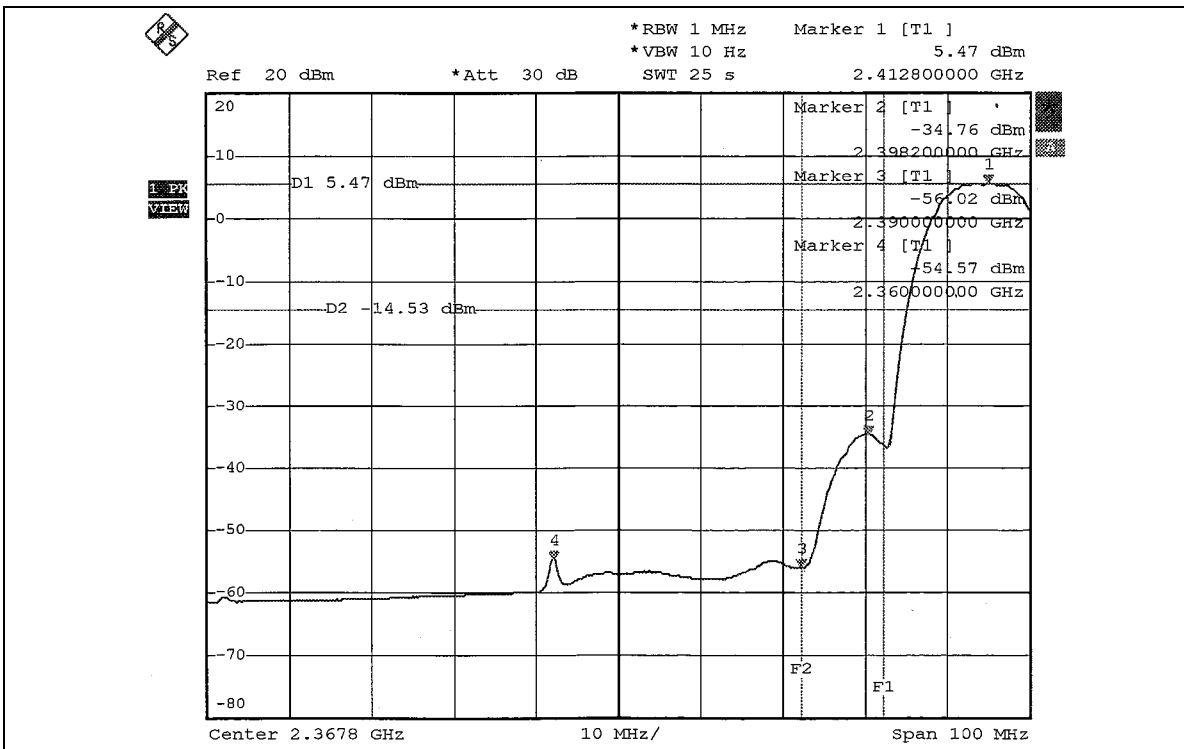
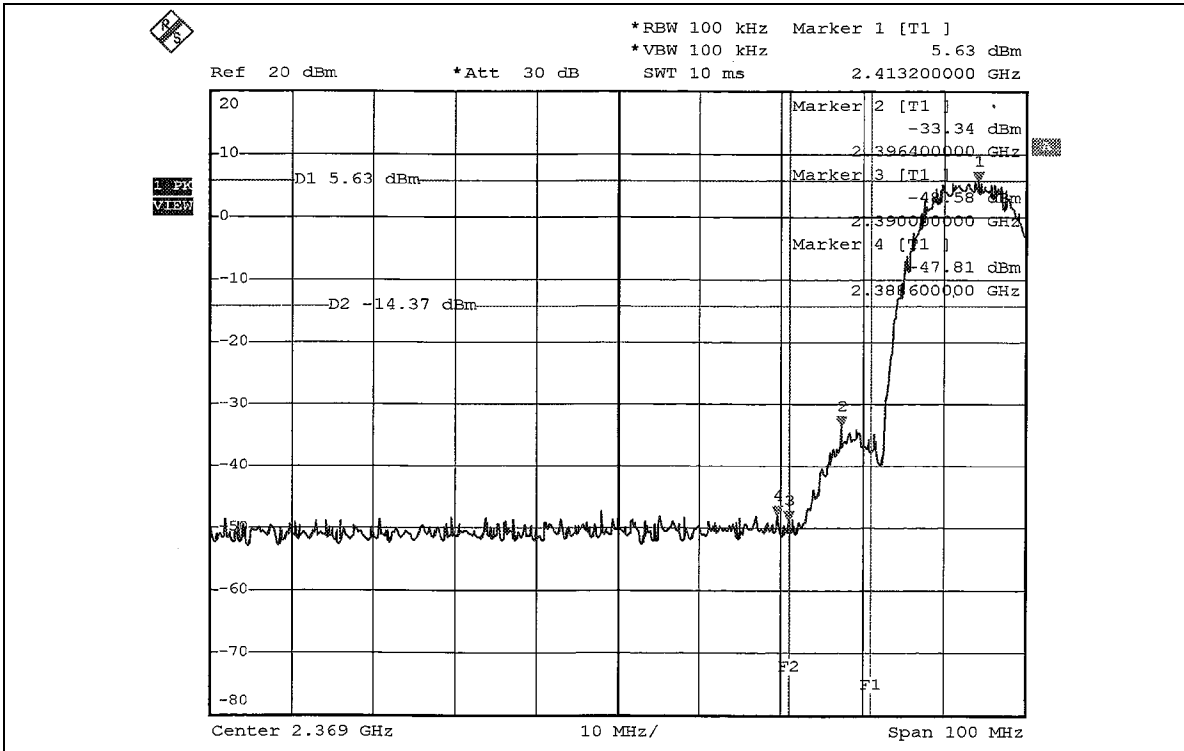

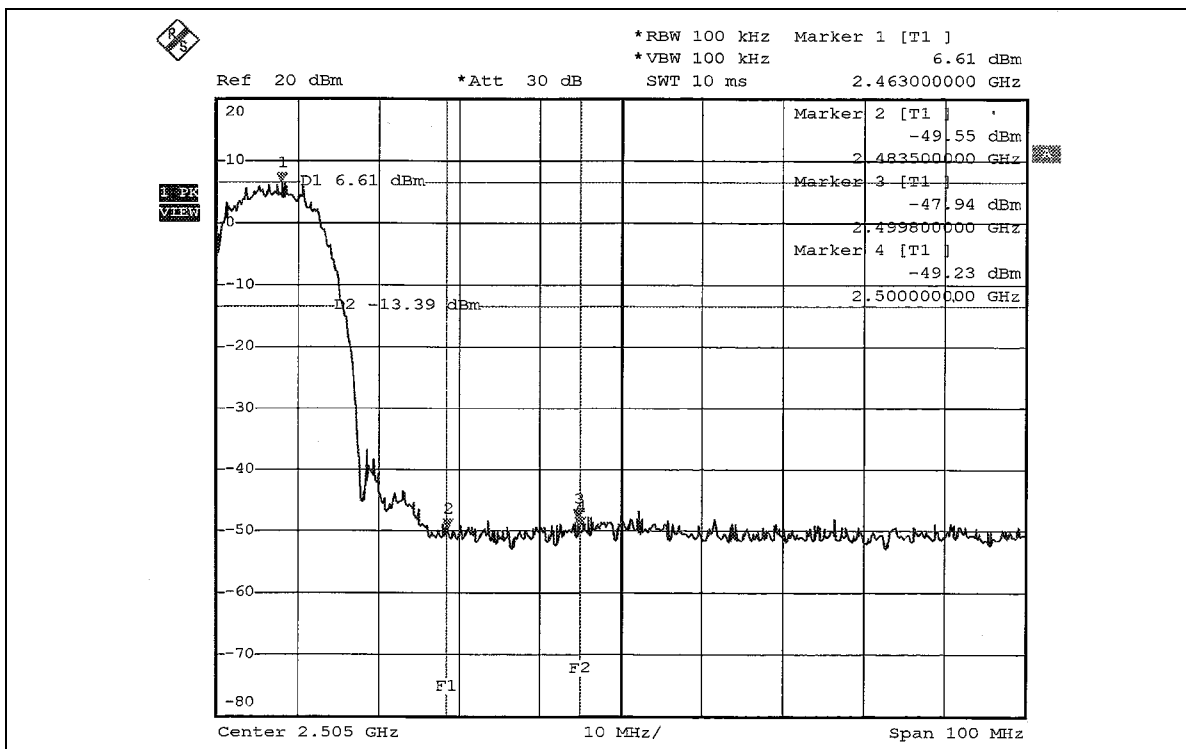
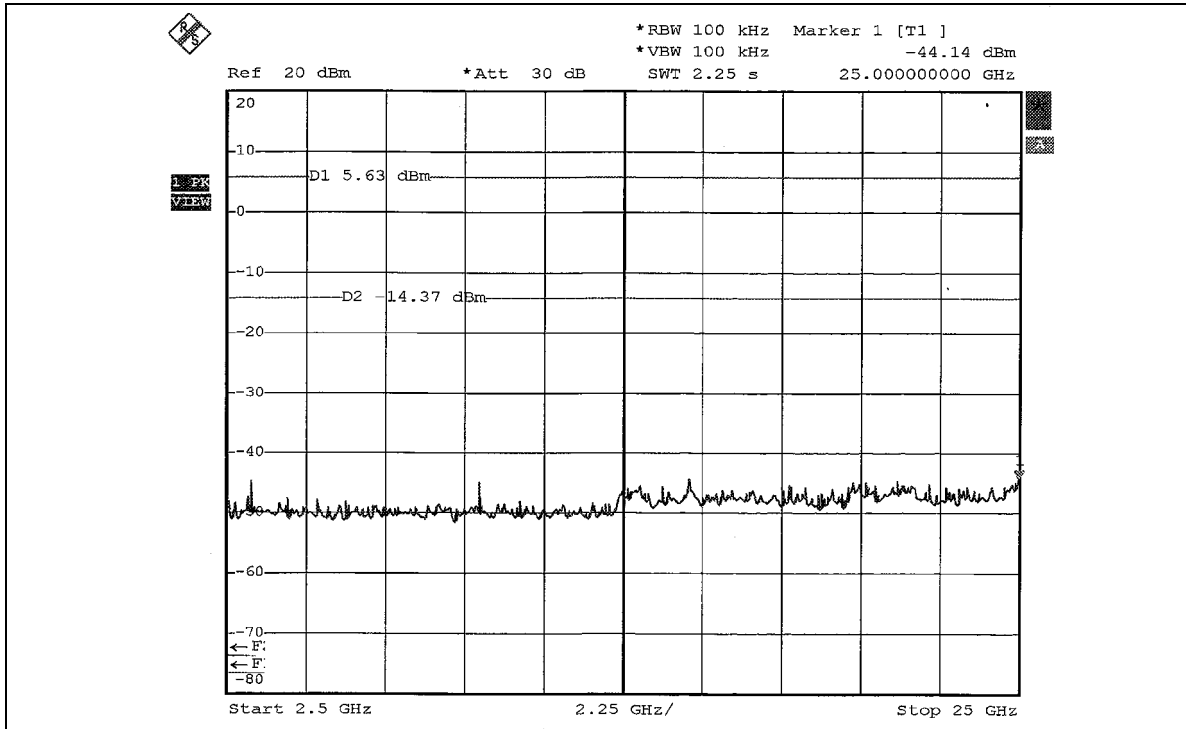

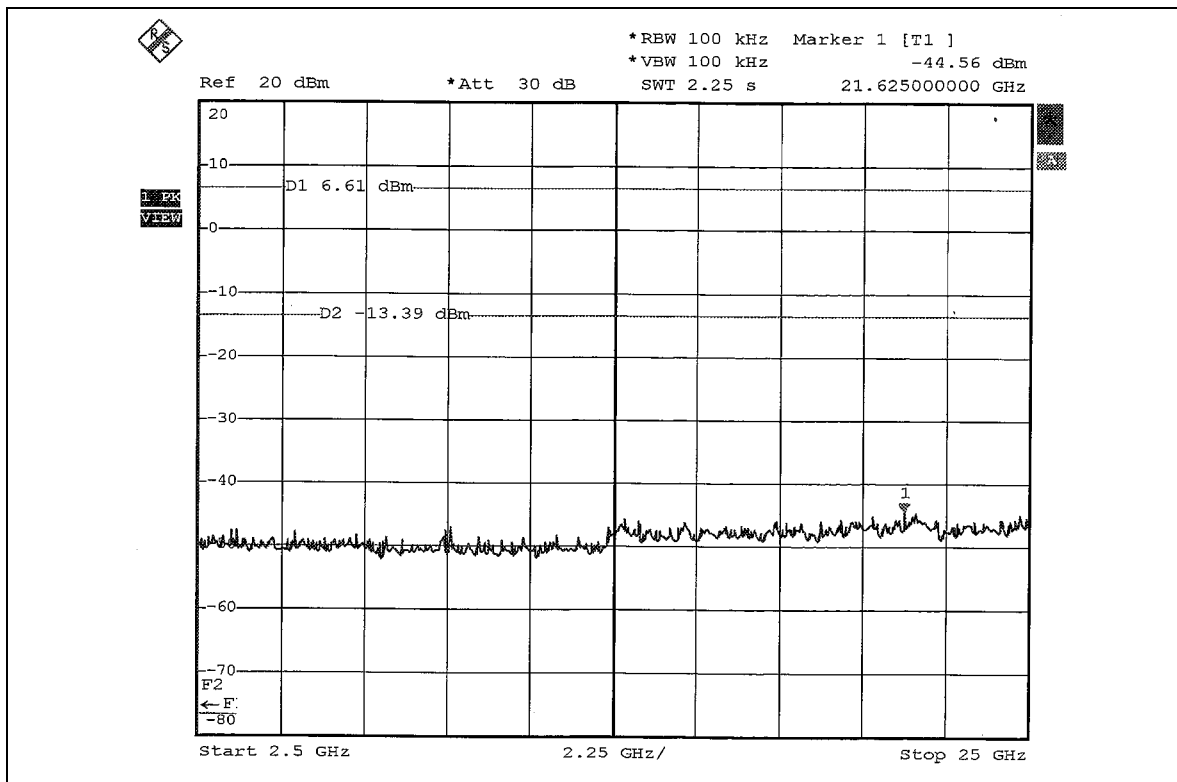
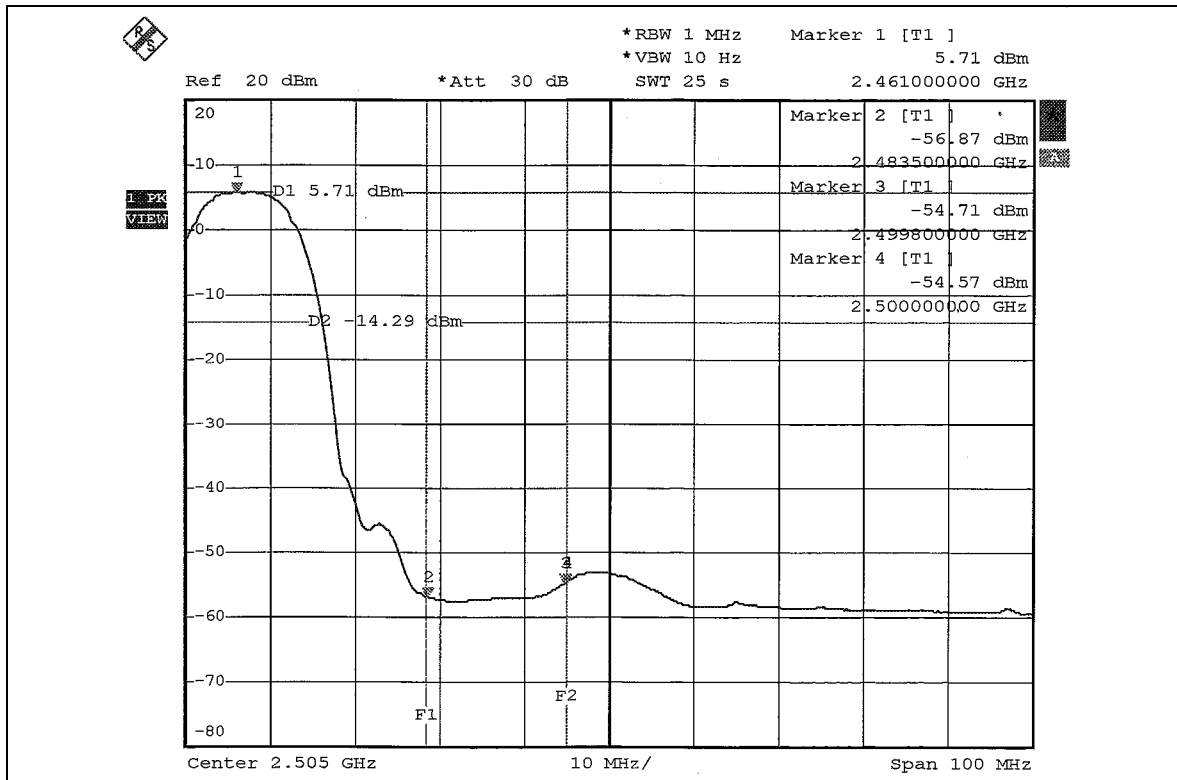



802.11g OFDM modulation

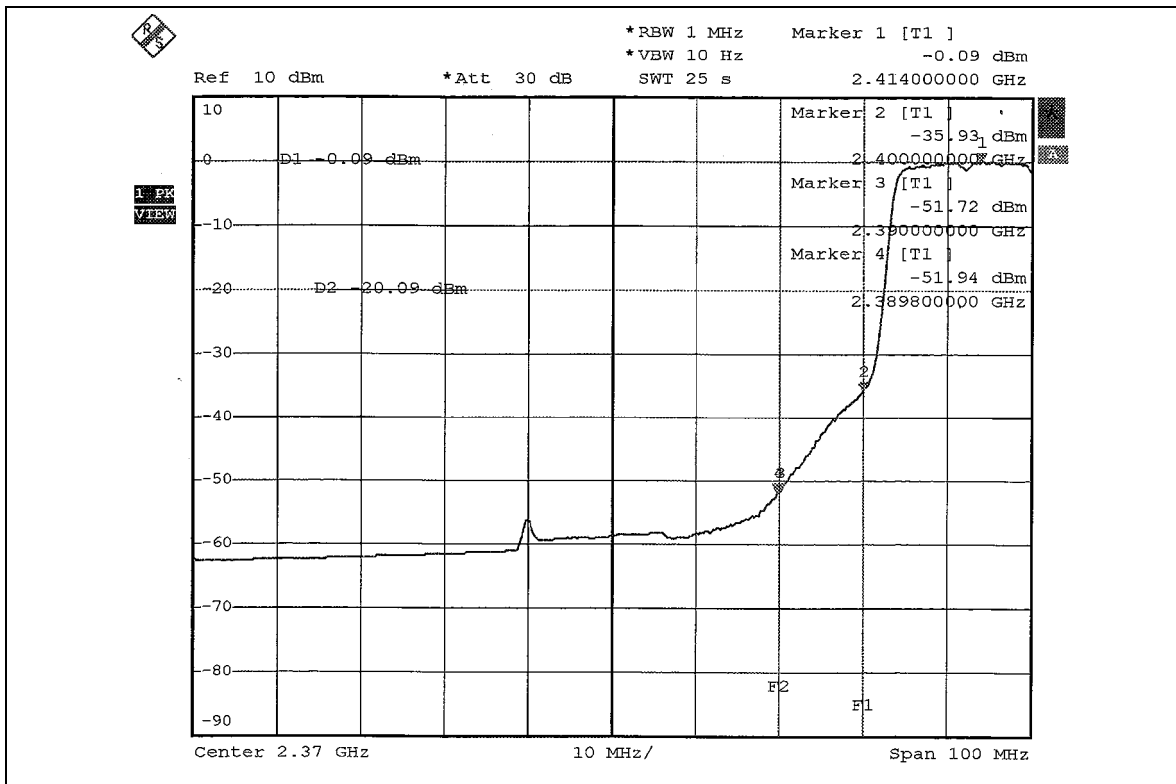
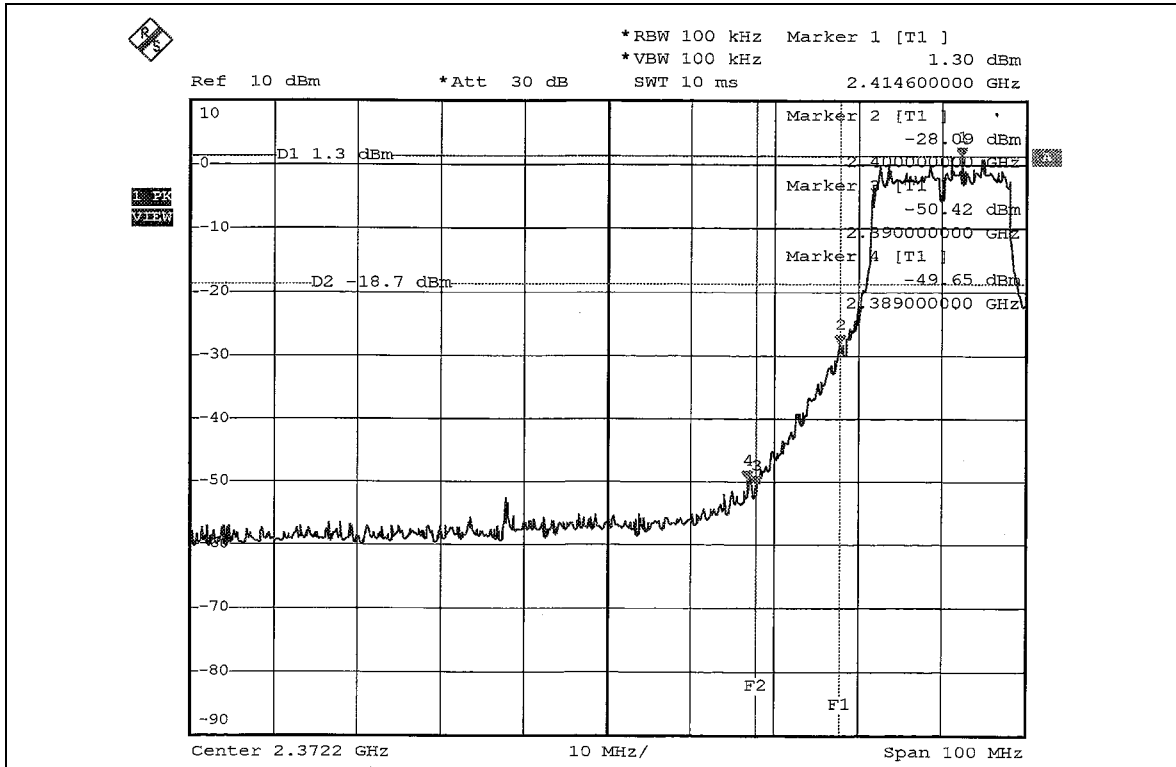

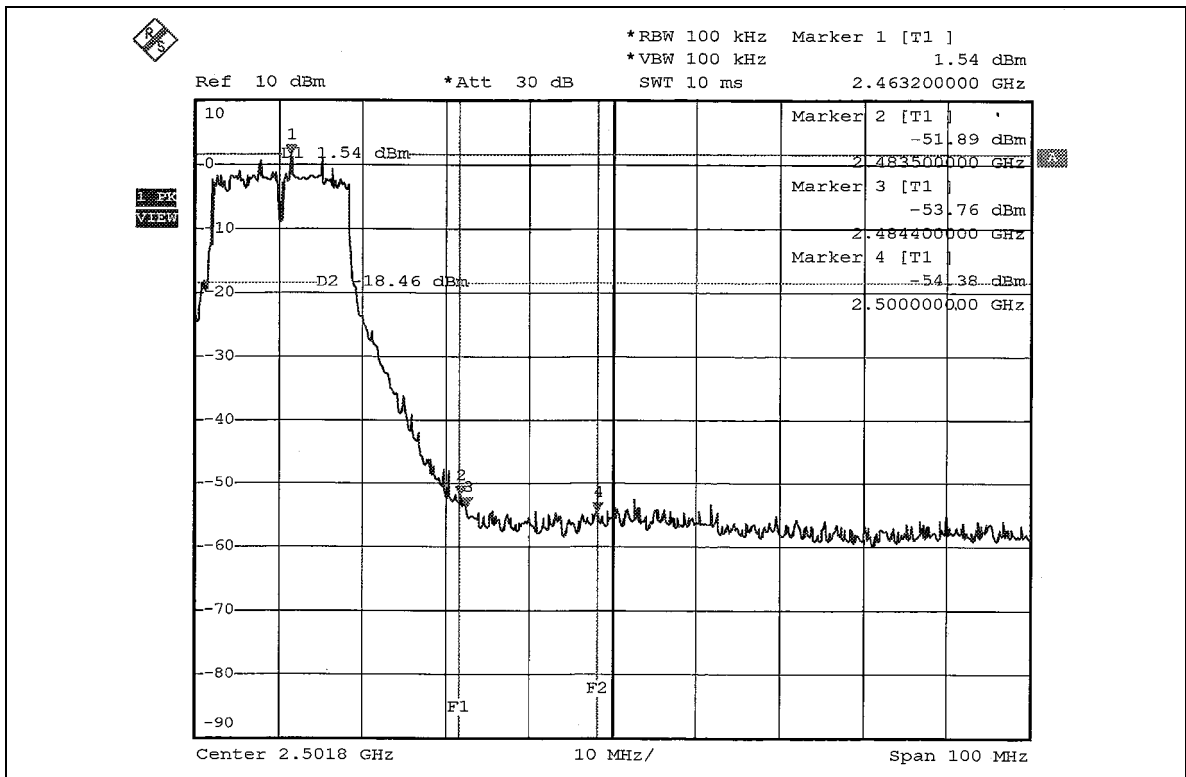
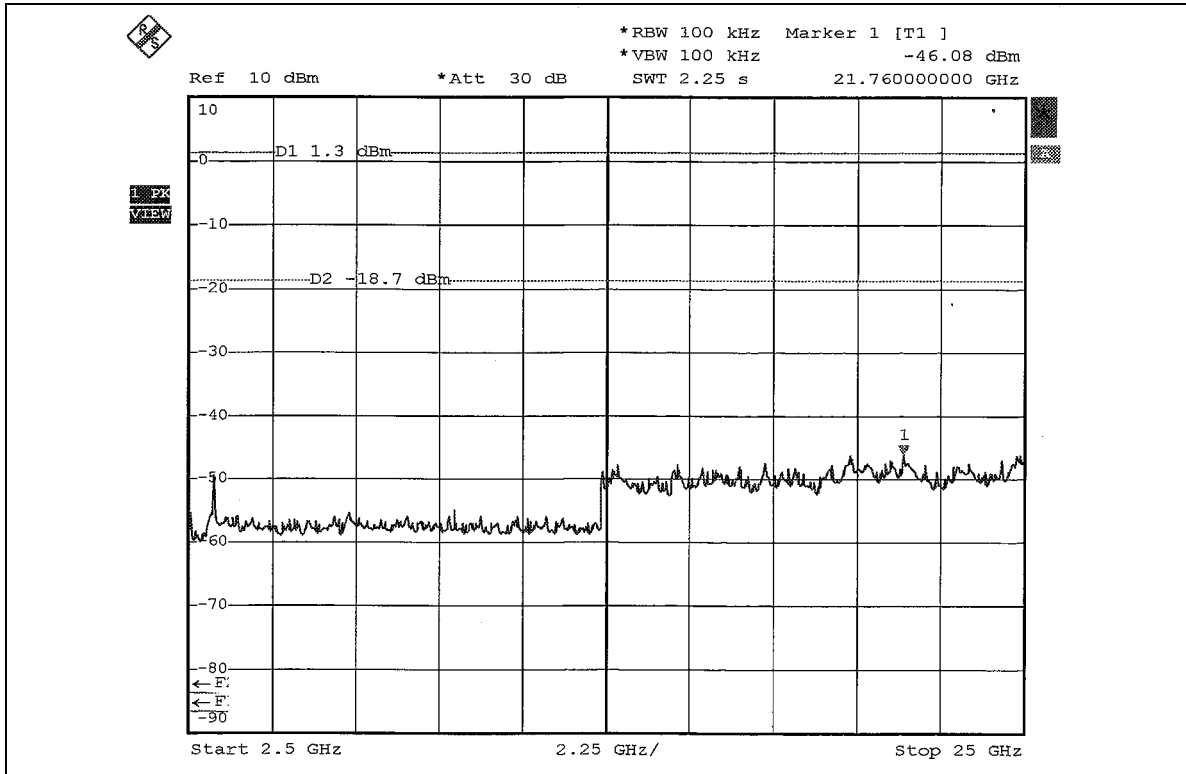

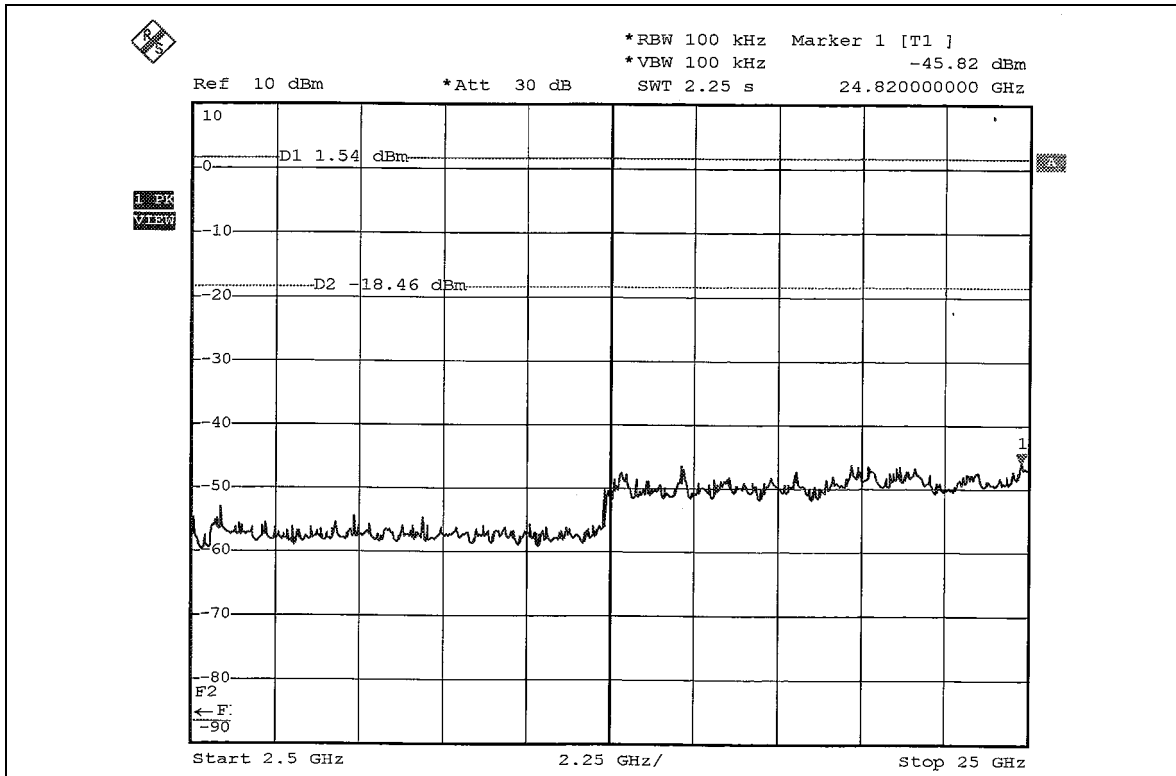
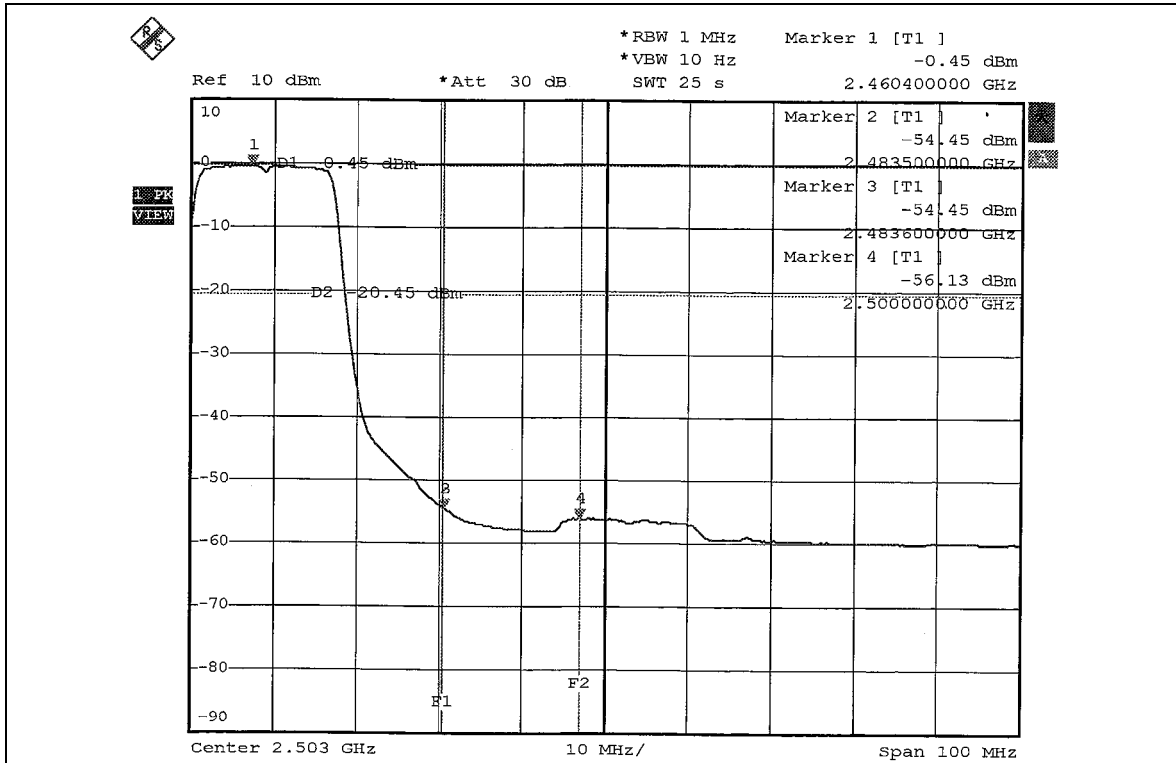



4.7 ANTENNA REQUIREMENT

4.7.1 STANDARD APPLICABLE

For intentional device, according to FCC 47 CFR Section 15.203, an intentional radiator shall be designed to ensure that no antenna other than that furnished by the responsible party shall be used with the device. And according to FCC 47 CFR Section 15.247 (b), if transmitting antennas of directional gain greater than 6dBi are used, the power shall be reduced by the amount in dB that the directional gain of the antenna exceeds 6dBi.

4.7.2 ANTENNA CONNECTED CONSTRUCTION

The antenna used in this product is Printed antenna without antenna connector. The maximum Gain of the antenna is 0dBi.

5. PHOTOGRAPHS OF THE TEST CONFIGURATION

CONDUCTED EMISSION TEST



RADIATED EMISSION TEST

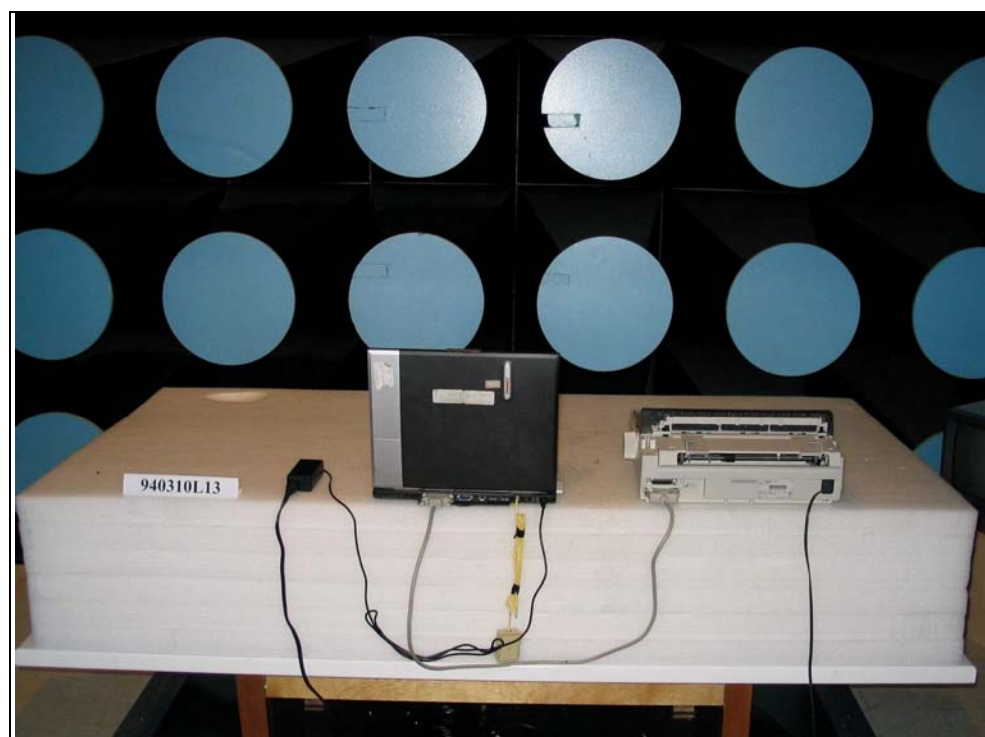



6. INFORMATION ON THE TESTING LABORATORIES

We, ADT Corp., were founded in 1988 to provide our best service in EMC, Radio, Telecom and Safety consultation. Our laboratories are accredited and approved by the following approval agencies according to ISO/IEC 17025.

USA	FCC, NVLAP, UL, A2LA
Germany	TUV Rheinland
Japan	VCCI
Norway	NEMKO
Canada	INDUSTRY CANADA , CSA
R.O.C.	CNLA, BSMI, DGT
Netherlands	Telefication
Singapore	PSB , GOST-ASIA(MOU)
Russia	CERTIS(MOU)

Copies of accreditation certificates of our laboratories obtained from approval agencies can be downloaded from our web site:

www.adt.com.tw/index.5/phtml. If you have any comments, please feel free to contact us at the following:

Linko EMC/RF Lab:

Tel: 886-2-26052180

Fax: 886-2-26052943

Hsin Chu EMC/RF Lab:

Tel: 886-3-5935343

Fax: 886-3-5935342

Hwa Ya EMC/RF/Safety Telecom Lab:

Tel: 886-3-3183232

Fax: 886-3-3185050

Linko RF Lab.

Tel: 886-3-3270910

Fax: 886-3-3270892

Web Site: www.adt.com.tw

The address and road map of all our labs can be found in our web site also