



FCC TEST REPORT

REPORT NO.: RF970102L12

MODEL NO.: WAP-372L

RECEIVED: Jan. 02, 2008

TESTED: Jan. 03 ~ Jan. 07, 2008

ISSUED: Jan. 09, 2008

APPLICANT: U-MEDIA Communications, Inc.

ADDRESS: 9F, No.1, Jin-shan 7th St., Hsinchu 300, Taiwan, R.O.C.

ISSUED BY: Advance Data Technology Corporation

LAB ADDRESS: No.47, 14th Ling, Chia Pau Tsuen, Linko Hsiang 244, Taipei Hsien, Taiwan, R.O.C.

TEST LOCATION: No. 19, Hwa Ya 2nd Rd, Wen Hwa Tsuen, Kwei Shan Hsiang, Taoyuan Hsien 333, Taiwan, R.O.C.

This test report consists of 92 pages in total. It may be duplicated completely for legal use with the approval of the applicant. It should not be reproduced except in full, without the written approval of our laboratory. The client should not use it to claim product endorsement by TAF, A2LA or any government agencies. The test results in the report only apply to the tested sample.





TABLE OF CONTENTS

1.	CERTIFICATION	4
2.	SUMMARY OF TEST RESULTS	5
2.1	MEASUREMENT UNCERTAINTY	5
3.	GENERAL INFORMATION	6
3.1	GENERAL DESCRIPTION OF EUT	6
3.2	DESCRIPTION OF TEST MODES	7
3.2.1	CONFIGURATION OF SYSTEM UNDER TEST	7
3.2.2	TEST MODE APPLICABILITY AND TESTED CHANNEL DETAIL	8
3.3	GENERAL DESCRIPTION OF APPLIED STANDARDS	10
3.4	DESCRIPTION OF SUPPORT UNITS	10
4.	TEST TYPES AND RESULTS	11
4.1	RADIATED EMISSION MEASUREMENT	11
4.1.1	LIMITS OF RADIATED EMISSION MEASUREMENT	11
4.1.2	TEST INSTRUMENTS	12
4.1.3	TEST PROCEDURES	13
4.1.4	DEVIATION FROM TEST STANDARD	13
4.1.5	TEST SETUP	14
4.1.6	EUT OPERATING CONDITIONS	14
4.1.7	TEST RESULTS	15
4.2	CONDUCTED EMISSION MEASUREMENT	30
4.2.1	LIMITS OF CONDUCTED EMISSION MEASUREMENT	30
4.2.2	TEST INSTRUMENTS	30
4.2.3	TEST PROCEDURES	31
4.2.4	DEVIATION FROM TEST STANDARD	31
4.2.5	TEST SETUP	32
4.2.6	EUT OPERATING CONDITIONS	32
4.2.7	TEST RESULTS	33
4.3	6dB BANDWIDTH MEASUREMENT	35
4.3.1	LIMITS OF 6dB BANDWIDTH MEASUREMENT	35
4.3.2	TEST INSTRUMENTS	35
4.3.3	TEST PROCEDURE	35
4.3.4	DEVIATION FROM TEST STANDARD	35
4.3.5	TEST SETUP	36
4.3.6	EUT OPERATING CONDITIONS	36
4.3.7	TEST RESULTS	37
4.4	MAXIMUM PEAK OUTPUT POWER	51
4.4.1	LIMITS OF MAXIMUM PEAK OUTPUT POWER MEASUREMENT	51
4.4.2	INSTRUMENTS	51
4.4.3	TEST PROCEDURES	51
4.4.4	DEVIATION FROM TEST STANDARD	51
4.4.5	TEST SETUP	52
4.4.6	EUT OPERATING CONDITIONS	52
4.4.7	TEST RESULTS	53
4.5	POWER SPECTRAL DENSITY MEASUREMENT	55
4.5.1	LIMITS OF POWER SPECTRAL DENSITY MEASUREMENT	55
4.5.2	TEST INSTRUMENTS	55
4.5.3	TEST PROCEDURE	55
4.5.4	DEVIATION FROM TEST STANDARD	55



4.5.5	TEST SETUP.....	56
4.5.6	EUT OPERATING CONDITION	56
4.5.7	TEST RESULTS	57
4.6	BAND EDGES MEASUREMENT	71
4.6.1	LIMITS OF BAND EDGES MEASUREMENT.....	71
4.6.2	TEST INSTRUMENTS.....	71
4.6.3	TEST PROCEDURE.....	72
4.6.4	DEVIATION FROM TEST STANDARD	72
4.6.5	EUT OPERATING CONDITION	72
4.6.6	TEST RESULTS	73
4.7	ANTENNA REQUIREMENT	89
4.7.1	STANDARD APPLICABLE	89
4.7.2	ANTENNA CONNECTED CONSTRUCTION.....	89
5.	PHOTOGRAPHS OF THE TEST CONFIGURATION.....	90
6.	INFORMATION ON THE TESTING LABORATORIES	91
7.	APPENDIX A - MODIFICATIONS RECORDERS FOR ENGINEERING CHANGES TO THE EUT BY THE LAB.....	92



1. CERTIFICATION

PRODUCT: 2.4GHz 802.11n (draft 2.0) Wireless Access Point

MODEL: WAP-372L

BRAND: U-MEDIA

APPLICANT: U-MEDIA Communications, Inc.

TESTED: Jan. 03 ~ Jan. 07, 2008

TEST SAMPLE: ENGINEERING SAMPLE

STANDARDS: **FCC Part 15, Subpart C (Section 15.247)**

ANSI C63.4-2003

The above equipment (model: WAP-372L) has been tested by **Advance Data Technology Corporation**, and found compliance with the requirement of the above standards. The test record, data evaluation & Equipment Under Test (EUT) configurations represented herein are true and accurate accounts of the measurements of the sample's EMC characteristics under the conditions specified in this report.

PREPARED BY : Andrea Hsia , **DATE:** Jan. 09, 2008
Andrea Hsia / Specialist

TECHNICAL ACCEPTANCE : Long Chen , **DATE:** Jan. 09, 2008
Responsible for RF Long Chen / Senior Engineer

APPROVED BY : Gary Chang , **DATE:** Jan. 09, 2008
Gary Chang / Assistant Manager

2. SUMMARY OF TEST RESULTS

The EUT has been tested according to the following specifications:

APPLIED STANDARD: FCC Part 15, Subpart C			
STANDARD SECTION	TEST TYPE AND LIMIT	RESULT	REMARK
15.207	AC Power Conducted Emission	PASS	Meet the requirement of limit. Minimum passing margin is -9.95dB at 0.564MHz.
15.247(a)(2)	Spectrum Bandwidth of a Direct Sequence Spread Spectrum System Limit : min. 500kHz	PASS	Meet the requirement of limit.
15.247(b)	Maximum Peak Output Power Limit: max. 30dBm	PASS	Meet the requirement of limit.
15.247(d)	Transmitter Radiated Emissions Limit: Table 15.209	PASS	Meet the requirement of limit. Minimum passing margin is -1.10dB at 2319.00MHz.
15.247(e)	Power Spectral Density Limit: max. 8dBm	PASS	Meet the requirement of limit.
15.247(d)	Band Edge Measurement Limit: 20dB less than the peak value of fundamental frequency	PASS	Meet the requirement of limit.

2.1 MEASUREMENT UNCERTAINTY

Where relevant, the following measurement uncertainty levels have been estimated for tests performed on the EUT as specified in CISPR 16-4-2:

MEASUREMENT	FREQUENCY	UNCERTAINTY
Conducted emissions	9kHz~30MHz	2.44dB
Radiated emissions	30MHz ~ 200MHz	2.93dB
	200MHz ~1000MHz	2.95dB
	1GHz ~ 18GHz	2.26dB
	18GHz ~ 40GHz	1.94dB

This uncertainty represents an expanded uncertainty expressed at approximately the 95% confidence level using a coverage factor of $k = 2$.

3. GENERAL INFORMATION

3.1 GENERAL DESCRIPTION OF EUT

PRODUCT	2.4GHz 802.11n (draft 2.0) Wireless Access Point
MODEL NO.	WAP-372L
FCC ID	SI5WAP372L
POWER SUPPLY	12Vdc from AC adapter
MODULATION TYPE	CCK, DQPSK, DBPSK for DSSS 64QAM, 16QAM, QPSK, BPSK for OFDM
MODULATION TECHNOLOGY	DSSS, OFDM
TRANSFER RATE	802.11b: 11.0/ 5.5/ 2.0/ 1.0Mbps 802.11g: 54.0/ 48.0/ 36.0/ 24.0/ 18.0/ 12.0/ 9.0/ 6.0Mbps Draft 802.11n: up to 300Mbps
FREQUENCY RANGE	2412MHz ~ 2462MHz
NUMBER OF CHANNEL	11 for 802.11b, 802.11g, Draft 802.11n (20MHz) 7 for Draft 802.11n (40MHz)
MAXIMUM OUTPUT POWER	64.644mW
ANTENNA TYPE	Dipole antenna with 2dBi gain
DATA CABLE	0.6m non-shielded RJ45 cable without core
I/O PORTS	RJ45
ACCESSORY DEVICES	Adapter

NOTE:

1. The EUT was powered by the following adapter:

BRAND:	LEI
MODEL:	MT12-4120100-A1
INPUT:	120Vac, 50/60Hz, 0.3A
OUTPUT:	12Vdc, 1A MAX
POWER LINE:	1.8m non-shielded cable without core

2. For the EUT, there are two difference appearances.
3. The EUT incorporates a MIMO function. Physically, the EUT provides two completed transmitters and two receivers.
4. The EUT is 2 * 2 spatial MIMO (2Tx & 2Rx) without beam forming function.
5. When the EUT operating in 802.11b is for single Tx and when the EUT operating in 802.11g, the software operation, which is defined by manufacturer, only set dual Tx.
6. When the EUT operating in draft 802.11n, the software operation, which is defined by manufacturer, only set 0 ~ 15 of "MCS" (MCS: Modulation and Coding Schemes) for dual Tx.
7. The EUT complies with draft 802.11n standards and backwards compatible with 802.11b, 802.11g products.
8. The EUT operates in the 2.4GHz frequency spectrum with throughput of up to 300Mbps.
9. The above EUT information was declared by manufacturer and for more detailed features description, please refer to the manufacturer's specifications or user's manual.

3.2 DESCRIPTION OF TEST MODES

Eleven channels are provided for 802.11b, 802.11g and draft 802.11n (20MHz):

CHANNEL	FREQUENCY	CHANNEL	FREQUENCY
1	2412MHz	7	2442MHz
2	2417MHz	8	2447MHz
3	2422MHz	9	2452MHz
4	2427MHz	10	2457MHz
5	2432MHz	11	2462MHz
6	2437MHz		

Seven channels are provided for draft 802.11n (40MHz):

CHANNEL	FREQUENCY	CHANNEL	FREQUENCY
1	2422MHz	5	2442MHz
2	2427MHz	6	2447MHz
3	2432MHz	7	2452MHz
4	2437MHz		

3.2.1 CONFIGURATION OF SYSTEM UNDER TEST

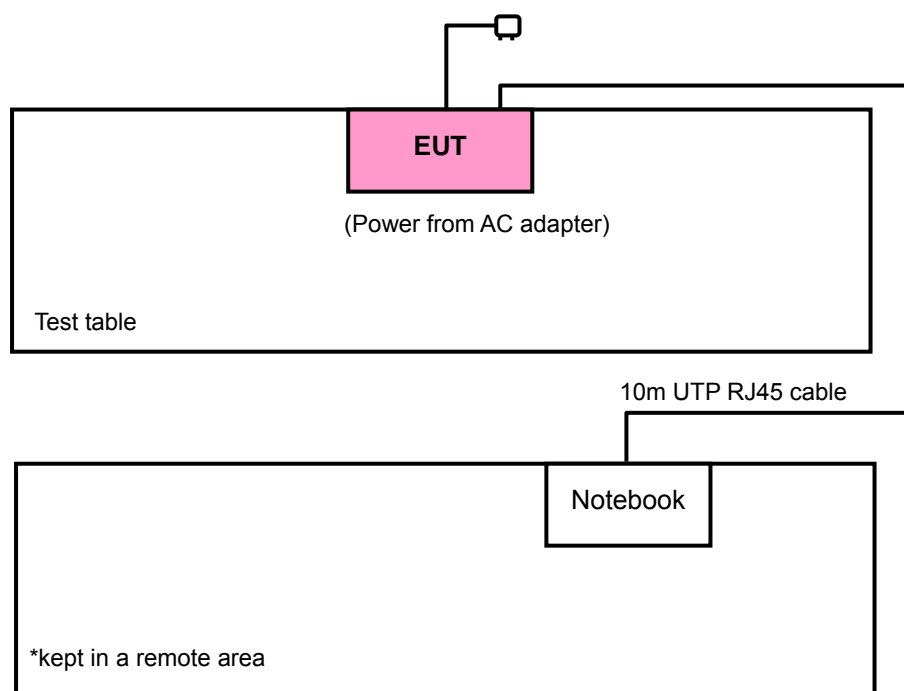

3.2.2 TEST MODE APPLICABILITY AND TESTED CHANNEL DETAIL

EUT CONFIGURE MODE	APPLICABLE TO				DESCRIPTION
	RE ≥ 1G	RE < 1G	PLC	APCM	
A	-	√	-	-	Large appearance
B	√	√	√	√	Small appearance

Where **RE ≥ 1G**: Radiated Emission above 1GHz **RE < 1G**: Radiated Emission below 1GHz
PLC: Power Line Conducted Emission **APCM**: Antenna Port Conducted Measurement

RADIATED EMISSION TEST (ABOVE 1 GHz):

- Pre-Scan has been conducted to determine the worst-case mode from all possible combinations between available modulations, data rates, XYZ axis, antenna ports (if EUT with antenna diversity architecture) and packet type.
- Following channel(s) was (were) selected for the final test as listed below.

EUT CONFIGURE MODE	MODE	AVAILABLE CHANNEL	TESTED CHANNEL	MODULATION TECHNOLOGY	MODULATION TYPE	DATA RATE (Mbps)	AXIS
B	802.11b	1 to 11	1, 6, 11	DSSS	DBPSK	1.0	X
B	802.11g	1 to 11	1, 6, 11	OFDM	BPSK	6.0	X
B	Draft 802.11n (20MHz)	1 to 11	1, 6, 11	OFDM	BPSK	7.2	X
B	Draft 802.11n (40MHz)	1 to 7	1, 4, 7	OFDM	BPSK	15.0	X

RADIATED EMISSION TEST (BELOW 1 GHz):

- Pre-Scan has been conducted to determine the worst-case mode from all possible combinations between available modulations, data rates, XYZ axis, antenna ports (if EUT with antenna diversity architecture) and packet type.
- Following channel(s) was (were) selected for the final test as listed below.

EUT CONFIGURE MODE	MODE	AVAILABLE CHANNEL	TESTED CHANNEL	MODULATION TECHNOLOGY	MODULATION TYPE	DATA RATE (Mbps)	AXIS
A	802.11b	1 to 11	6	DSSS	DBPSK	1.0	X
B	802.11b	1 to 11	6	DSSS	DBPSK	1.0	X



POWER LINE CONDUCTED EMISSION TEST:

- Pre-Scan has been conducted to determine the worst-case mode from all possible combinations between available modulations, data rates and antenna ports (if EUT with antenna diversity architecture).
- Following channel(s) was (were) selected for the final test as listed below.

EUT CONFIGURE MODE	MODE	AVAILABLE CHANNEL	TESTED CHANNEL	MODULATION TECHNOLOGY	MODULATION TYPE	DATA RATE (Mbps)
B	802.11b	1 to 11	6	DSSS	DBPSK	1.0

BANDEDGE MEASUREMENT:

- Pre-Scan has been conducted to determine the worst-case mode from all possible combinations between available modulations, data rates and antenna ports (if EUT with antenna diversity architecture).
- Following channel(s) was (were) selected for the final test as listed below.

EUT CONFIGURE MODE	MODE	AVAILABLE CHANNEL	TESTED CHANNEL	MODULATION TECHNOLOGY	MODULATION TYPE	DATA RATE (Mbps)
B	802.11b	1 to 11	1, 11	DSSS	DBPSK	1.0
B	802.11g	1 to 11	1, 11	OFDM	BPSK	6.0
B	Draft 802.11n (20MHz)	1 to 11	1, 11	OFDM	BPSK	7.2
B	Draft 802.11n (40MHz)	1 to 7	1, 7	OFDM	BPSK	15.0

ANTENNA PORT CONDUCTED MEASUREMENT:

- Pre-Scan has been conducted to determine the worst-case mode from all possible combinations between available modulations, data rates and antenna ports (if EUT with antenna diversity architecture).
- Following channel(s) was (were) selected for the final test as listed below.

EUT CONFIGURE MODE	MODE	AVAILABLE CHANNEL	TESTED CHANNEL	MODULATION TECHNOLOGY	MODULATION TYPE	DATA RATE (Mbps)
B	802.11b	1 to 11	1, 6, 11	DSSS	DBPSK	1.0
B	802.11g	1 to 11	1, 6, 11	OFDM	BPSK	6.0
B	Draft 802.11n (20MHz)	1 to 11	1, 6, 11	OFDM	BPSK	7.2
B	Draft 802.11n (40MHz)	1 to 7	1, 4, 7	OFDM	BPSK	15.0



3.3 GENERAL DESCRIPTION OF APPLIED STANDARDS

The EUT is a RF product. According to the specifications of the manufacturer, it must comply with the requirements of the following standards:

FCC Part 15, Subpart C. (15.247)

ANSI C63.4-2003

All test items have been performed and recorded as per the above standards.

NOTE: The EUT is also considered as a kind of computer peripheral, because the connection to computer is necessary for typical use. It has been verified to comply with the requirements of FCC Part 15, Subpart B, Class B (DoC). The test report has been issued separately.

3.4 DESCRIPTION OF SUPPORT UNITS

The EUT has been tested as an independent unit together with other necessary accessories or support units. The following support units or accessories were used to form a representative test configuration during the tests.

NO.	PRODUCT	BRAND	MODEL NO.	SERIAL NO.	FCC ID
1	NOTEBOOK COMPUTER	DELL	PP05L	12130898320	E2K24CLNS

NO.	SIGNAL CABLE DESCRIPTION OF THE ABOVE SUPPORT UNITS
1	10m UTP RJ45 cable

NOTE:

1. All power cords of the above support units are non shielded (1.8m).
2. Item 1 acted as communication partners to transfer data.

4. TEST TYPES AND RESULTS

4.1 RADIATED EMISSION MEASUREMENT

4.1.1 LIMITS OF RADIATED EMISSION MEASUREMENT

Emissions radiated outside of the specified bands, shall be according to the general radiated limits in 15.209 as following:

FREQUENCIES (MHz)	FIELD STRENGTH (microvolts/meter)	MEASUREMENT DISTANCE (meters)
0.009 ~ 0.490	2400 / F(kHz)	300
0.490 ~ 1.705	24000 / F(kHz)	30
1.705 ~ 30.0	30	30
30 ~ 88	100	3
88 ~ 216	150	3
216 ~ 960	200	3
Above 960	500	3

NOTE:

1. The lower limit shall apply at the transition frequencies.
2. Emission level (dBuV/m) = 20 log Emission level (uV/m).
3. As shown in 15.35(b), for frequencies above 1000MHz, the field strength limits are based on average detector, however, the peak field strength of any emission shall not exceed the maximum permitted average limits, specified above by more than 20dB under any condition of modulation.



4.1.2 TEST INSTRUMENTS

DESCRIPTION & MANUFACTURER	MODEL NO.	SERIAL NO.	CALIBRATED UNTIL
Test Receiver ROHDE & SCHWARZ	ESCI	100424	Jul. 27, 2008
Spectrum Analyzer ROHDE & SCHWARZ	FSP40	100269	Aug. 05, 2008
BILOG Antenna SCHWARZBECK	VULB9168	9168-153	Jan. 03, 2009
HORN Antenna SCHWARZBECK	BBHA 9120 D	9120D-563	Jul. 30, 2008
HORN Antenna SCHWARZBECK	BBHA 9170	BBHA9170242	Jan. 16, 2008
Preamplifier Agilent	8449B	3008A01910	Sep. 19, 2008
Preamplifier Agilent	8447D	2944A10638	Dec. 19, 2008
RF signal cable HUBER+SUHNNER	SUCOFLEX 104	274039/223650	Nov. 07, 2008
RF signal cable Worken	8D-FB	Cable-HYCH9-01	Aug. 09, 2008
Software	ADT_Radiated_V7.6	NA	NA
Antenna Tower EMCO	2070/2080	512.835.4684	NA
Turn Table EMCO	2087-2.03	NA	NA
Antenna Tower & Turn Table Controller EMCO	2090	NA	NA

- NOTE:**
1. The calibration interval of the above test instruments is 12 months and the calibrations are traceable to NML/ROC and NIST/USA.
 2. The test was performed in HwaYa Chamber 9.
 3. The horn antenna and HP preamplifier (model: 8449B) are used only for the measurement of emission frequency above 1GHz if tested.
 4. The IC Site Registration No. is IC3789B-9.

4.1.3 TEST PROCEDURES

- a. The EUT was placed on the top of a rotating table 0.8 meters above the ground at a 3 meters semi-anechoic chamber. The table was rotated 360 degrees to determine the position of the highest radiation.
- b. The EUT was set 3 meters away from the interference-receiving antenna, which was mounted on the top of a variable-height antenna tower.
- c. The antenna is a broadband antenna, and its height is varied from one meter to four meters above the ground to determine the maximum value of the field strength. Both horizontal and vertical polarizations of the antenna are set to make the measurement.
- d. For each suspected emission, the EUT was arranged to its worst case and then the antenna was tuned to heights from 1 meter to 4 meters and the rotatable table was turned from 0 degrees to 360 degrees to find the maximum reading.
- e. The test-receiver system was set to Peak Detect Function and Specified Bandwidth with Maximum Hold Mode.
- f. If the emission level of the EUT in peak mode was lower than the limit specified, then testing could be stopped and the peak values of the EUT would be reported. Otherwise the emissions would be re-tested one by one using peak, quasi-peak or average method as specified and then reported in a data sheet.

NOTE:

1. The resolution bandwidth and video bandwidth of test receiver/spectrum analyzer is 120kHz for Peak detection (PK) and Quasi-peak detection (QP) at frequency below 1GHz.
2. The resolution bandwidth of test receiver/spectrum analyzer is 1MHz and video bandwidth is 3MHz for Peak detection at frequency above 1GHz.
3. The resolution bandwidth of test receiver/spectrum analyzer is 1MHz and the video bandwidth is 10Hz for Average detection (AV) at frequency above 1GHz.
4. All modes of operation were investigated and the worst-case emissions are reported.

4.1.4 DEVIATION FROM TEST STANDARD

No deviation

4.1.5 TEST SETUP

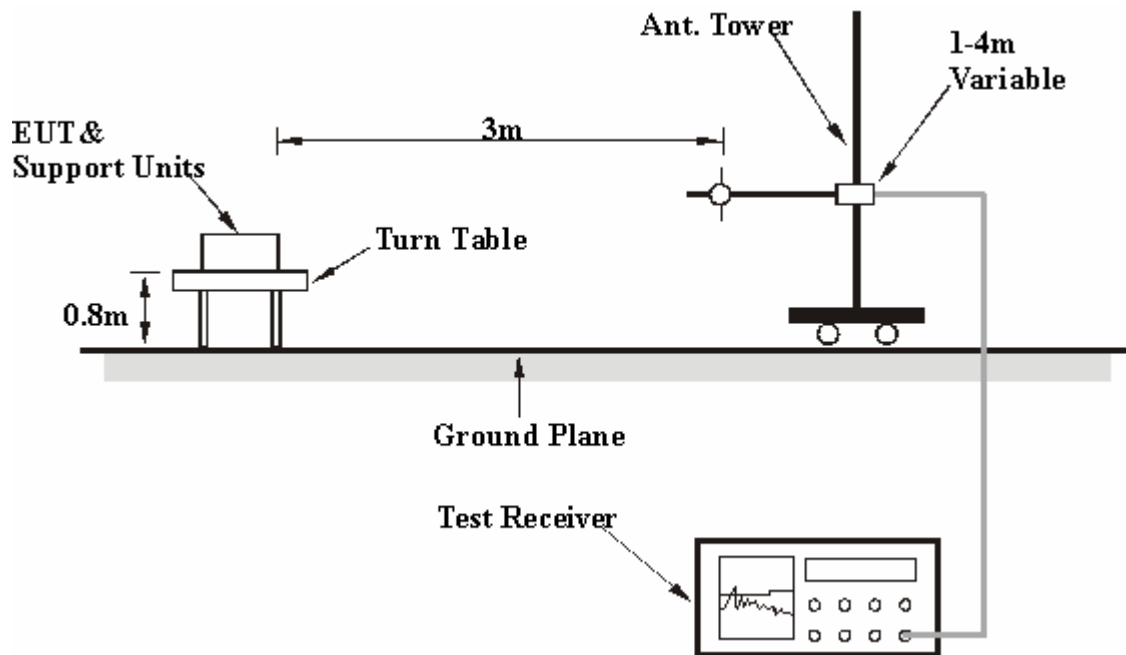

For the actual test configuration, please refer to the attached file (Test Setup Photo).

4.1.6 EUT OPERATING CONDITIONS

- Placed the EUT on the testing table.
- Prepared other notebook systems to act as a communication partners and placed them outside of testing area.
- The communication partners run a test program (provided by manufacturer) to enable EUT under transmission condition continuously at specific channel frequency via an RJ45 cable.
- The communication partner sent data to EUT by command "PING".



4.1.7 TEST RESULTS
 Above 1GHz Worst-Case Data
 802.11b DSSS MODULATION

EUT TEST CONDITION		MEASUREMENT DETAIL	
CHANNEL	Channel 1	FREQUENCY RANGE	1 ~ 25GHz
INPUT POWER (SYSTEM)	120Vac, 60 Hz	DETECTOR FUNCTION	Peak (PK) Average (AV)
ENVIRONMENTAL CONDITIONS	25deg. C, 65%RH 999hPa	TESTED BY	Match Tsui

ANTENNA POLARITY & TEST DISTANCE: HORIZONTAL AT 3 M								
NO.	FREQ. (MHz)	EMISSION LEVEL (dBuV/m)	LIMIT (dBuV/m)	MARGIN (dB)	ANTENNA HEIGHT (m)	TABLE ANGLE (Degree)	RAW VALUE (dBuV)	CORRECTION FACTOR (dB/m)
1	1608.00	51.45 PK	74.00	-22.55	1.14 H	180	22.54	28.91
2	1608.00	50.63 AV	54.00	-3.37	1.14 H	180	21.72	28.91
3	2386.00	57.54 PK	74.00	-16.46	1.32 H	306	25.22	32.32
4	2386.00	48.56 AV	54.00	-5.44	1.32 H	306	16.24	32.32
5	*2412.00	101.91 PK			1.32 H	306	69.59	32.32
6	*2412.00	98.01 AV			1.32 H	306	65.69	32.32
7	4824.00	47.51 PK	74.00	-26.49	1.11 H	177	9.51	38.00
8	4824.00	38.61 AV	54.00	-15.39	1.11 H	177	0.61	38.00
ANTENNA POLARITY & TEST DISTANCE: VERTICAL AT 3 M								
NO.	FREQ. (MHz)	EMISSION LEVEL (dBuV/m)	LIMIT (dBuV/m)	MARGIN (dB)	ANTENNA HEIGHT (m)	TABLE ANGLE (Degree)	RAW VALUE (dBuV)	CORRECTION FACTOR (dB/m)
1	1608.00	50.44 PK	74.00	-23.56	1.00 V	100	21.53	28.91
2	1608.00	50.01 AV	54.00	-3.99	1.00 V	100	21.10	28.91
3	2390.00	61.56 PK	74.00	-12.44	1.14 V	92	29.24	32.32
4	2390.00	52.49 AV	54.00	-1.51	1.14 V	92	20.17	32.32
5	*2412.00	109.03 PK			1.13 V	89	76.71	32.32
6	*2412.00	104.74 AV			1.13 V	89	72.42	32.32
7	4824.00	51.88 PK	74.00	-22.12	1.09 V	179	13.88	38.00
8	4824.00	47.31 AV	54.00	-6.69	1.09 V	179	9.31	38.00

- REMARKS:**
1. Emission level (dBuV/m) = Raw Value (dBuV) + Correction Factor (dB/m).
 2. Correction Factor (dB/m) = Antenna Factor (dB/m) + Cable Factor (dB).
 3. The other emission levels were very low against the limit.
 4. Margin value = Emission level – Limit value.
 5. “ * “: Fundamental frequency.

EUT TEST CONDITION		MEASUREMENT DETAIL	
CHANNEL	Channel 6	FREQUENCY RANGE	1 ~ 25GHz
INPUT POWER (SYSTEM)	120Vac, 60 Hz	DETECTOR FUNCTION	Peak (PK) Average (AV)
ENVIRONMENTAL CONDITIONS	25deg. C, 65%RH 999hPa	TESTED BY	Match Tsui

ANTENNA POLARITY & TEST DISTANCE: HORIZONTAL AT 3 M								
NO.	FREQ. (MHz)	EMISSION LEVEL (dBuV/m)	LIMIT (dBuV/m)	MARGIN (dB)	ANTENNA HEIGHT (m)	TABLE ANGLE (Degree)	RAW VALUE (dBuV)	CORRECTION FACTOR (dB/m)
1	1624.00	51.92 PK	74.00	-22.08	1.18 H	172	23.03	28.89
2	1624.00	50.79 AV	54.00	-3.21	1.18 H	172	21.90	28.89
3	*2437.00	102.50 PK			1.02 H	290	70.16	32.34
4	*2437.00	99.06 AV			1.02 H	290	66.72	32.34
5	4874.00	47.75 PK	74.00	-26.25	1.01 H	186	9.63	38.12
6	4874.00	37.77 AV	54.00	-16.23	1.01 H	186	-0.35	38.12
ANTENNA POLARITY & TEST DISTANCE: VERTICAL AT 3 M								
NO.	FREQ. (MHz)	EMISSION LEVEL (dBuV/m)	LIMIT (dBuV/m)	MARGIN (dB)	ANTENNA HEIGHT (m)	TABLE ANGLE (Degree)	RAW VALUE (dBuV)	CORRECTION FACTOR (dB/m)
1	1624.00	51.90 PK	74.00	-22.10	1.00 V	77	23.01	28.89
2	1624.00	50.76 AV	54.00	-3.24	1.00 V	77	21.87	28.89
3	2312.00	60.20 PK	74.00	-13.80	1.17 V	7	27.81	32.39
4	2312.00	51.41 AV	54.00	-2.59	1.17 V	7	19.02	32.39
5	*2437.00	110.50 PK			1.17 V	7	78.16	32.34
6	*2437.00	107.07 AV			1.17 V	7	74.73	32.34
7	2563.50	59.09 PK	90.50	-31.41	1.17 V	7	26.54	32.55
8	2563.50	51.18 AV	87.07	-35.89	1.17 V	7	18.63	32.55
9	4874.00	50.17 PK	74.00	-23.83	1.35 V	183	12.05	38.12
10	4874.00	43.84 AV	54.00	-10.16	1.35 V	183	5.72	38.12
11	7311.00	54.83 PK	74.00	-19.17	1.18 V	182	9.87	44.97
12	7311.00	44.69 AV	54.00	-9.31	1.18 V	182	-0.27	44.97

- REMARKS:**
1. Emission level (dBuV/m) = Raw Value (dBuV) + Correction Factor (dB/m).
 2. Correction Factor (dB/m) = Antenna Factor (dB/m) + Cable Factor (dB).
 3. The other emission levels were very low against the limit.
 4. Margin value = Emission level – Limit value.
 5. “ * “: Fundamental frequency.

EUT TEST CONDITION		MEASUREMENT DETAIL	
CHANNEL	Channel 11	FREQUENCY RANGE	1 ~ 25GHz
INPUT POWER (SYSTEM)	120Vac, 60 Hz	DETECTOR FUNCTION	Peak (PK) Average (AV)
ENVIRONMENTAL CONDITIONS	25deg. C, 65%RH 999hPa	TESTED BY	Match Tsui

ANTENNA POLARITY & TEST DISTANCE: HORIZONTAL AT 3 M								
NO.	FREQ. (MHz)	EMISSION LEVEL (dBuV/m)	LIMIT (dBuV/m)	MARGIN (dB)	ANTENNA HEIGHT (m)	TABLE ANGLE (Degree)	RAW VALUE (dBuV)	CORRECTION FACTOR (dB/m)
1	1641.00	45.57 PK	81.10	-35.53	1.01 H	100	16.70	28.87
2	1641.00	44.59 AV	76.80	-32.21	1.01 H	100	15.72	28.87
3	*2462.00	101.10 PK			1.32 H	291	68.73	32.37
4	*2462.00	96.80 AV			1.32 H	291	64.43	32.37
5	2487.50	57.08 PK	74.00	-16.92	1.32 H	291	24.69	32.39
6	2487.50	47.20 AV	54.00	-6.80	1.32 H	291	14.81	32.39
7	4924.00	46.44 PK	74.00	-27.56	1.08 H	342	8.21	38.23
8	4924.00	35.98 AV	54.00	-18.02	1.08 H	342	-2.25	38.23
ANTENNA POLARITY & TEST DISTANCE: VERTICAL AT 3 M								
NO.	FREQ. (MHz)	EMISSION LEVEL (dBuV/m)	LIMIT (dBuV/m)	MARGIN (dB)	ANTENNA HEIGHT (m)	TABLE ANGLE (Degree)	RAW VALUE (dBuV)	CORRECTION FACTOR (dB/m)
1	1641.00	46.85 PK	89.91	-43.06	1.00 V	65	17.98	28.87
2	1641.00	45.22 AV	85.85	-40.63	1.00 V	65	16.35	28.87
3	*2462.00	109.91 PK			1.11 V	91	77.54	32.37
4	*2462.00	105.85 AV			1.11 V	91	73.48	32.37
5	2483.50	62.71 PK	74.00	-11.29	1.10 V	94	30.32	32.39
6	2483.50	52.56 AV	54.00	-1.44	1.10 V	94	20.17	32.39
7	4924.00	46.46 PK	74.00	-27.54	1.00 V	315	8.23	38.23
8	4924.00	36.21 AV	54.00	-17.79	1.00 V	315	-2.02	38.23

- REMARKS:**
1. Emission level (dBuV/m) = Raw Value (dBuV) + Correction Factor (dB/m).
 2. Correction Factor (dB/m) = Antenna Factor (dB/m) + Cable Factor (dB).
 3. The other emission levels were very low against the limit.
 4. Margin value = Emission level – Limit value.
 5. “ * “: Fundamental frequency.

802.11g OFDM MODULATION

EUT TEST CONDITION		MEASUREMENT DETAIL	
CHANNEL	Channel 1	FREQUENCY RANGE	1 ~ 25GHz
INPUT POWER (SYSTEM)	120Vac, 60 Hz	DETECTOR FUNCTION	Peak (PK) Average (AV)
ENVIRONMENTAL CONDITIONS	25deg. C, 65%RH 999hPa	TESTED BY	Dean Wang

ANTENNA POLARITY & TEST DISTANCE: HORIZONTAL AT 3 M								
NO.	FREQ. (MHz)	EMISSION LEVEL (dBuV/m)	LIMIT (dBuV/m)	MARGIN (dB)	ANTENNA HEIGHT (m)	TABLE ANGLE (Degree)	RAW VALUE (dBuV)	CORRECTION FACTOR (dB/m)
1	1734.00	41.71 PK	83.97	-42.26	1.09 H	301	12.80	28.92
2	1734.00	34.26 AV	73.52	-39.26	1.09 H	301	5.35	28.92
3	2232.00	61.56 PK	74.00	-12.44	1.18 H	327	29.21	32.35
4	2232.00	49.84 AV	54.00	-4.16	1.18 H	327	17.49	32.35
5	2280.00	63.02 PK	74.00	-10.98	1.11 H	326	30.63	32.39
6	2280.00	51.81 AV	54.00	-2.19	1.11 H	326	19.42	32.39
7	2390.00	58.73 PK	74.00	-15.27	1.05 H	326	26.41	32.32
8	2390.00	47.67 AV	54.00	-6.33	1.05 H	326	15.35	32.32
9	*2412.00	103.97 PK			1.05 H	326	71.65	32.32
10	*2412.00	93.52 AV			1.05 H	326	61.20	32.32
11	3216.00	45.38 PK	83.97	-38.59	1.00 H	145	11.81	33.57
12	3216.00	36.35 AV	73.52	-37.17	1.00 H	145	2.78	33.57
13	4824.00	46.16 PK	74.00	-27.84	1.00 H	28	8.16	38.00
14	4824.00	33.23 AV	54.00	-20.77	1.00 H	28	-4.77	38.00

- REMARKS:**
1. Emission level (dBuV/m) = Raw Value (dBuV) + Correction Factor (dB/m).
 2. Correction Factor (dB/m) = Antenna Factor (dB/m) + Cable Factor (dB).
 3. The other emission levels were very low against the limit.
 4. Margin value = Emission level – Limit value.
 5. “ * “: Fundamental frequency.

EUT TEST CONDITION		MEASUREMENT DETAIL	
CHANNEL	Channel 1	FREQUENCY RANGE	1 ~ 25GHz
INPUT POWER (SYSTEM)	120Vac, 60 Hz	DETECTOR FUNCTION	Peak (PK) Average (AV)
ENVIRONMENTAL CONDITIONS	25deg. C, 65%RH 999hPa	TESTED BY	Dean Wang

ANTENNA POLARITY & TEST DISTANCE: VERTICAL AT 3 M								
NO.	FREQ. (MHz)	EMISSION LEVEL (dBuV/m)	LIMIT (dBuV/m)	MARGIN (dB)	ANTENNA HEIGHT (m)	TABLE ANGLE (Degree)	RAW VALUE (dBuV)	CORRECTION FACTOR (dB/m)
1	1734.00	46.53 PK	90.90	-44.37	1.00 V	101	17.62	28.92
2	1734.00	42.83 AV	80.73	-37.90	1.00 V	101	13.92	28.92
3	2232.00	61.71 PK	74.00	-12.29	1.00 V	0	29.36	32.35
4	2232.00	51.17 AV	54.00	-2.83	1.00 V	0	18.82	32.35
5	2280.00	64.83 PK	74.00	-9.17	1.00 V	342	32.44	32.39
6	2280.00	52.87 AV	54.00	-1.13	1.00 V	342	20.48	32.39
7	2390.00	61.86 PK	74.00	-12.14	1.17 V	24	29.54	32.32
8	2390.00	49.38 AV	54.00	-4.62	1.17 V	24	17.06	32.32
9	*2412.00	110.90 PK			1.17 V	24	78.58	32.32
10	*2412.00	100.73 AV			1.17 V	24	68.41	32.32
11	3216.00	47.52 PK	90.90	-43.38	1.04 V	46	13.95	33.57
12	3216.00	42.09 AV	80.73	-38.64	1.04 V	46	8.52	33.57
13	4824.00	48.08 PK	74.00	-25.92	1.05 V	214	10.08	38.00
14	4824.00	35.31 AV	54.00	-18.69	1.05 V	214	-2.69	38.00

- REMARKS:**
1. Emission level (dBuV/m) = Raw Value (dBuV) + Correction Factor (dB/m).
 2. Correction Factor (dB/m) = Antenna Factor (dB/m) + Cable Factor (dB).
 3. The other emission levels were very low against the limit.
 4. Margin value = Emission level – Limit value.
 5. “ * “: Fundamental frequency.

EUT TEST CONDITION		MEASUREMENT DETAIL	
CHANNEL	Channel 6	FREQUENCY RANGE	1 ~ 25GHz
INPUT POWER (SYSTEM)	120Vac, 60 Hz	DETECTOR FUNCTION	Peak (PK) Average (AV)
ENVIRONMENTAL CONDITIONS	25deg. C, 65%RH 999hPa	TESTED BY	Dean Wang

ANTENNA POLARITY & TEST DISTANCE: HORIZONTAL AT 3 M								
NO.	FREQ. (MHz)	EMISSION LEVEL (dBuV/m)	LIMIT (dBuV/m)	MARGIN (dB)	ANTENNA HEIGHT (m)	TABLE ANGLE (Degree)	RAW VALUE (dBuV)	CORRECTION FACTOR (dB/m)
1	2319.00	63.23 PK	74.00	-10.77	1.00 H	251	30.85	32.38
2	2319.00	51.67 AV	54.00	-2.33	1.00 H	251	19.29	32.38
3	*2437.00	106.27 PK			1.31 H	317	73.93	32.34
4	*2437.00	95.97 AV			1.31 H	317	63.63	32.34
5	4824.00	46.04 PK	74.00	-27.96	1.00 H	291	8.04	38.00
6	4824.00	33.44 AV	54.00	-20.56	1.00 H	291	-4.56	38.00
ANTENNA POLARITY & TEST DISTANCE: VERTICAL AT 3 M								
NO.	FREQ. (MHz)	EMISSION LEVEL (dBuV/m)	LIMIT (dBuV/m)	MARGIN (dB)	ANTENNA HEIGHT (m)	TABLE ANGLE (Degree)	RAW VALUE (dBuV)	CORRECTION FACTOR (dB/m)
1	2319.00	64.46 PK	74.00	-9.54	1.00 V	348	32.08	32.38
2	2319.00	52.90 AV	54.00	-1.10	1.00 V	348	20.52	32.38
3	*2437.00	112.76 PK			1.11 V	219	80.42	32.34
4	*2437.00	102.68 AV			1.11 V	219	70.34	32.34
5	4874.00	48.46 PK	74.00	-25.54	1.00 V	192	10.34	38.12
6	4874.00	35.09 AV	54.00	-18.91	1.00 V	192	-3.03	38.12

- REMARKS:**
1. Emission level (dBuV/m) = Raw Value (dBuV) + Correction Factor (dB/m).
 2. Correction Factor (dB/m) = Antenna Factor (dB/m) + Cable Factor (dB).
 3. The other emission levels were very low against the limit.
 4. Margin value = Emission level – Limit value.
 5. “ * “: Fundamental frequency.

EUT TEST CONDITION		MEASUREMENT DETAIL	
CHANNEL	Channel 11	FREQUENCY RANGE	1 ~ 25GHz
INPUT POWER (SYSTEM)	120Vac, 60 Hz	DETECTOR FUNCTION	Peak (PK) Average (AV)
ENVIRONMENTAL CONDITIONS	25deg. C, 65%RH 999hPa	TESTED BY	Dean Wang

ANTENNA POLARITY & TEST DISTANCE: HORIZONTAL AT 3 M								
NO.	FREQ. (MHz)	EMISSION LEVEL (dBuV/m)	LIMIT (dBuV/m)	MARGIN (dB)	ANTENNA HEIGHT (m)	TABLE ANGLE (Degree)	RAW VALUE (dBuV)	CORRECTION FACTOR (dB/m)
1	2336.00	62.35 PK	74.00	-11.65	1.00 H	256	29.98	32.37
2	2336.00	51.66 AV	54.00	-2.34	1.00 H	256	19.29	32.37
3	*2462.00	105.69 PK			1.28 H	318	73.32	32.37
4	*2462.00	95.46 AV			1.28 H	318	63.09	32.37
5	2483.50	60.61 PK	74.00	-13.39	1.28 H	317	28.22	32.39
6	2483.50	48.77 AV	54.00	-5.23	1.28 H	317	16.38	32.39
7	4924.00	47.87 PK	74.00	-26.13	1.00 H	136	9.64	38.23
8	4924.00	33.63 AV	54.00	-20.37	1.00 H	136	-4.60	38.23
ANTENNA POLARITY & TEST DISTANCE: VERTICAL AT 3 M								
NO.	FREQ. (MHz)	EMISSION LEVEL (dBuV/m)	LIMIT (dBuV/m)	MARGIN (dB)	ANTENNA HEIGHT (m)	TABLE ANGLE (Degree)	RAW VALUE (dBuV)	CORRECTION FACTOR (dB/m)
1	2336.00	63.58 PK	74.00	-10.42	1.00 V	22	31.21	32.37
2	2336.00	52.82 AV	54.00	-1.18	1.00 V	22	20.45	32.37
3	*2462.00	112.86 PK			1.09 V	209	80.49	32.37
4	*2462.00	102.83 AV			1.09 V	209	70.46	32.37
5	2483.50	67.09 PK	74.00	-6.91	1.09 V	209	34.70	32.39
6	2483.50	52.53 AV	54.00	-1.47	1.09 V	209	20.14	32.39
7	4924.00	48.10 PK	74.00	-25.90	1.00 V	331	9.87	38.23
8	4924.00	35.55 AV	54.00	-18.45	1.00 V	331	-2.68	38.23

- REMARKS:**
1. Emission level (dBuV/m) = Raw Value (dBuV) + Correction Factor (dB/m).
 2. Correction Factor (dB/m) = Antenna Factor (dB/m) + Cable Factor (dB).
 3. The other emission levels were very low against the limit.
 4. Margin value = Emission level – Limit value.
 5. “ * “: Fundamental frequency.

DRAFT 802.11n (20MHz) OFDM MODULATION

EUT TEST CONDITION		MEASUREMENT DETAIL	
CHANNEL	Channel 1	FREQUENCY RANGE	1 ~ 25GHz
INPUT POWER (SYSTEM)	120Vac, 60 Hz	DETECTOR FUNCTION	Peak (PK) Average (AV)
ENVIRONMENTAL CONDITIONS	25deg. C, 65%RH 999hPa	TESTED BY	Dean Wang

ANTENNA POLARITY & TEST DISTANCE: HORIZONTAL AT 3 M								
NO.	FREQ. (MHz)	EMISSION LEVEL (dBuV/m)	LIMIT (dBuV/m)	MARGIN (dB)	ANTENNA HEIGHT (m)	TABLE ANGLE (Degree)	RAW VALUE (dBuV)	CORRECTION FACTOR (dB/m)
1	2280.00	62.15 PK	74.00	-11.85	1.00 H	49	29.76	32.39
2	2280.00	50.50 AV	54.00	-3.50	1.00 H	49	18.11	32.39
3	2390.00	59.85 PK	74.00	-14.15	1.33 H	317	27.53	32.32
4	2390.00	47.54 AV	54.00	-6.46	1.33 H	317	15.22	32.32
5	*2412.00	103.17 PK			1.27 H	138	70.85	32.32
6	*2412.00	92.97 AV			1.27 H	138	60.65	32.32
7	4824.00	46.44 PK	74.00	-27.56	1.03 H	115	8.44	38.00
8	4824.00	33.59 AV	54.00	-20.41	1.03 H	115	-4.41	38.00

ANTENNA POLARITY & TEST DISTANCE: VERTICAL AT 3 M								
NO.	FREQ. (MHz)	EMISSION LEVEL (dBuV/m)	LIMIT (dBuV/m)	MARGIN (dB)	ANTENNA HEIGHT (m)	TABLE ANGLE (Degree)	RAW VALUE (dBuV)	CORRECTION FACTOR (dB/m)
1	2280.00	63.30 PK	74.00	-10.70	1.00 V	37	30.91	32.39
2	2280.00	51.62 AV	54.00	-2.38	1.00 V	37	19.23	32.39
3	2390.00	61.41 PK	74.00	-12.59	1.20 V	30	29.09	32.32
4	2390.00	48.89 AV	54.00	-5.11	1.20 V	30	16.57	32.32
5	*2412.00	108.28 PK			1.20 V	30	75.96	32.32
6	*2412.00	98.03 AV			1.20 V	30	65.71	32.32
7	4824.00	48.13 PK	74.00	-25.87	1.00 V	213	10.13	38.00
8	4824.00	35.08 AV	54.00	-18.92	1.00 V	213	-2.92	38.00

- REMARKS:**
1. Emission level (dBuV/m) = Raw Value (dBuV) + Correction Factor (dB/m).
 2. Correction Factor (dB/m) = Antenna Factor (dB/m) + Cable Factor (dB).
 3. The other emission levels were very low against the limit.
 4. Margin value = Emission level – Limit value.
 5. “ * “: Fundamental frequency.



EUT TEST CONDITION		MEASUREMENT DETAIL	
CHANNEL	Channel 6	FREQUENCY RANGE	1 ~ 25GHz
INPUT POWER (SYSTEM)	120Vac, 60 Hz	DETECTOR FUNCTION	Peak (PK) Average (AV)
ENVIRONMENTAL CONDITIONS	25deg. C, 65%RH 999hPa	TESTED BY	Dean Wang

ANTENNA POLARITY & TEST DISTANCE: HORIZONTAL AT 3 M								
NO.	FREQ. (MHz)	EMISSION LEVEL (dBuV/m)	LIMIT (dBuV/m)	MARGIN (dB)	ANTENNA HEIGHT (m)	TABLE ANGLE (Degree)	RAW VALUE (dBuV)	CORRECTION FACTOR (dB/m)
1	2319.00	61.48 PK	74.00	-12.52	1.00 H	115	29.10	32.38
2	2319.00	49.32 AV	54.00	-4.68	1.00 H	115	16.94	32.38
3	*2437.00	103.69 PK			1.21 H	311	71.35	32.34
4	*2437.00	93.25 AV			1.21 H	311	60.91	32.34
5	4874.00	46.89 PK	74.00	-27.11	1.00 H	118	8.77	38.12
6	4874.00	33.46 AV	54.00	-20.54	1.00 H	118	-4.66	38.12
ANTENNA POLARITY & TEST DISTANCE: VERTICAL AT 3 M								
NO.	FREQ. (MHz)	EMISSION LEVEL (dBuV/m)	LIMIT (dBuV/m)	MARGIN (dB)	ANTENNA HEIGHT (m)	TABLE ANGLE (Degree)	RAW VALUE (dBuV)	CORRECTION FACTOR (dB/m)
1	2319.00	62.63 PK	74.00	-11.37	1.00 V	349	30.25	32.38
2	2319.00	50.47 AV	54.00	-3.53	1.00 V	349	18.09	32.38
3	*2437.00	108.75 PK			1.10 V	198	76.41	32.34
4	*2437.00	98.41 AV			1.10 V	198	66.07	32.34
5	4874.00	48.05 PK	74.00	-25.95	1.00 V	215	9.93	38.12
6	4874.00	34.68 AV	54.00	-19.32	1.00 V	215	-3.44	38.12

- REMARKS:**
1. Emission level (dBuV/m) = Raw Value (dBuV) + Correction Factor (dB/m).
 2. Correction Factor (dB/m) = Antenna Factor (dB/m) + Cable Factor (dB).
 3. The other emission levels were very low against the limit.
 4. Margin value = Emission level – Limit value.
 5. “ * “: Fundamental frequency.

EUT TEST CONDITION		MEASUREMENT DETAIL	
CHANNEL	Channel 11	FREQUENCY RANGE	1 ~ 25GHz
INPUT POWER (SYSTEM)	120Vac, 60 Hz	DETECTOR FUNCTION	Peak (PK) Average (AV)
ENVIRONMENTAL CONDITIONS	25deg. C, 65%RH 999hPa	TESTED BY	Dean Wang

ANTENNA POLARITY & TEST DISTANCE: HORIZONTAL AT 3 M								
NO.	FREQ. (MHz)	EMISSION LEVEL (dBuV/m)	LIMIT (dBuV/m)	MARGIN (dB)	ANTENNA HEIGHT (m)	TABLE ANGLE (Degree)	RAW VALUE (dBuV)	CORRECTION FACTOR (dB/m)
1	2336.00	60.62 PK	74.00	-13.38	1.00 H	65	28.25	32.37
2	2336.00	49.35 AV	54.00	-4.65	1.00 H	65	16.98	32.37
3	*2462.00	103.72 PK			1.26 H	315	71.35	32.37
4	*2462.00	93.46 AV			1.26 H	315	61.09	32.37
5	2483.50	58.97 PK	74.00	-15.03	1.25 H	315	26.58	32.39
6	2483.50	47.60 AV	54.00	-6.40	1.25 H	315	15.21	32.39
7	4924.00	46.59 PK	74.00	-27.41	1.00 H	314	8.36	38.23
8	4924.00	34.08 AV	54.00	-19.92	1.00 H	314	-4.15	38.23
ANTENNA POLARITY & TEST DISTANCE: VERTICAL AT 3 M								
NO.	FREQ. (MHz)	EMISSION LEVEL (dBuV/m)	LIMIT (dBuV/m)	MARGIN (dB)	ANTENNA HEIGHT (m)	TABLE ANGLE (Degree)	RAW VALUE (dBuV)	CORRECTION FACTOR (dB/m)
1	2336.00	61.71 PK	74.00	-12.29	1.00 V	20	29.34	32.37
2	2336.00	50.43 AV	54.00	-3.57	1.00 V	20	18.06	32.37
3	*2462.00	108.61 PK			1.09 V	205	76.24	32.37
4	*2462.00	98.30 AV			1.09 V	205	65.93	32.37
5	2483.50	61.90 PK	74.00	-12.10	1.09 V	205	29.51	32.39
6	2483.50	49.39 AV	54.00	-4.61	1.09 V	205	17.00	32.39
7	4924.00	47.85 PK	74.00	-26.15	1.00 V	246	9.62	38.23
8	4924.00	35.29 AV	54.00	-18.71	1.00 V	246	-2.94	38.23

- REMARKS:**
1. Emission level (dBuV/m) = Raw Value (dBuV) + Correction Factor (dB/m).
 2. Correction Factor (dB/m) = Antenna Factor (dB/m) + Cable Factor (dB).
 3. The other emission levels were very low against the limit.
 4. Margin value = Emission level – Limit value.
 5. “ * “: Fundamental frequency.



DRAFT 802.11n (40MHz) OFDM MODULATION

EUT TEST CONDITION		MEASUREMENT DETAIL	
CHANNEL	Channel 1	FREQUENCY RANGE	1 ~ 25GHz
INPUT POWER (SYSTEM)	120Vac, 60 Hz	DETECTOR FUNCTION	Peak (PK) Average (AV)
ENVIRONMENTAL CONDITIONS	25deg. C, 65%RH 999hPa	TESTED BY	Dean Wang

ANTENNA POLARITY & TEST DISTANCE: HORIZONTAL AT 3 M								
NO.	FREQ. (MHz)	EMISSION LEVEL (dBuV/m)	LIMIT (dBuV/m)	MARGIN (dB)	ANTENNA HEIGHT (m)	TABLE ANGLE (Degree)	RAW VALUE (dBuV)	CORRECTION FACTOR (dB/m)
1	2384.00	60.42 PK	74.00	-13.58	1.35 H	317	28.10	32.32
2	2384.00	48.72 AV	54.00	-5.28	1.35 H	317	16.40	32.32
3	*2422.00	100.49 PK			1.35 H	317	68.16	32.33
4	*2422.00	90.83 AV			1.35 H	317	58.50	32.33
5	4844.00	45.47 PK	74.00	-28.53	1.00 H	116	7.43	38.05
6	4844.00	32.80 AV	54.00	-21.20	1.00 H	116	-5.24	38.05
ANTENNA POLARITY & TEST DISTANCE: VERTICAL AT 3 M								
NO.	FREQ. (MHz)	EMISSION LEVEL (dBuV/m)	LIMIT (dBuV/m)	MARGIN (dB)	ANTENNA HEIGHT (m)	TABLE ANGLE (Degree)	RAW VALUE (dBuV)	CORRECTION FACTOR (dB/m)
1	2384.00	61.92 PK	74.00	-12.08	1.09 V	198	29.60	32.32
2	2384.00	50.28 AV	54.00	-3.72	1.09 V	198	17.96	32.32
3	*2422.00	106.46 PK			1.11 V	204	74.13	32.33
4	*2422.00	96.62 AV			1.11 V	204	64.29	32.33
5	4844.00	46.79 PK	74.00	-27.21	1.00 V	214	8.75	38.05
6	4844.00	34.47 AV	54.00	-19.53	1.00 V	214	-3.57	38.05

- REMARKS:**
1. Emission level (dBuV/m) = Raw Value (dBuV) + Correction Factor (dB/m).
 2. Correction Factor (dB/m) = Antenna Factor (dB/m) + Cable Factor (dB).
 3. The other emission levels were very low against the limit.
 4. Margin value = Emission level – Limit value.
 5. “ * “: Fundamental frequency.



EUT TEST CONDITION		MEASUREMENT DETAIL	
CHANNEL	Channel 4	FREQUENCY RANGE	1 ~ 25GHz
INPUT POWER (SYSTEM)	120Vac, 60 Hz	DETECTOR FUNCTION	Peak (PK) Average (AV)
ENVIRONMENTAL CONDITIONS	25deg. C, 65%RH 999hPa	TESTED BY	Dean Wang

ANTENNA POLARITY & TEST DISTANCE: HORIZONTAL AT 3 M								
NO.	FREQ. (MHz)	EMISSION LEVEL (dBuV/m)	LIMIT (dBuV/m)	MARGIN (dB)	ANTENNA HEIGHT (m)	TABLE ANGLE (Degree)	RAW VALUE (dBuV)	CORRECTION FACTOR (dB/m)
1	*2437.00	100.61 PK			1.30 H	320	68.27	32.34
2	*2437.00	91.03 AV			1.30 H	320	58.69	32.34
3	4874.00	45.92 PK	74.00	-28.08	1.00 H	213	7.80	38.12
4	4874.00	33.13 AV	54.00	-20.87	1.00 H	213	-4.99	38.12
ANTENNA POLARITY & TEST DISTANCE: VERTICAL AT 3 M								
NO.	FREQ. (MHz)	EMISSION LEVEL (dBuV/m)	LIMIT (dBuV/m)	MARGIN (dB)	ANTENNA HEIGHT (m)	TABLE ANGLE (Degree)	RAW VALUE (dBuV)	CORRECTION FACTOR (dB/m)
1	*2437.00	106.55 PK			1.10 V	216	74.21	32.34
2	*2437.00	96.71 AV			1.10 V	216	64.37	32.34
3	4874.00	47.02 PK	74.00	-26.98	1.00 V	341	8.90	38.12
4	4874.00	34.89 AV	54.00	-19.11	1.00 V	341	-3.23	38.12

- REMARKS:**
1. Emission level (dBuV/m) = Raw Value (dBuV) + Correction Factor (dB/m).
 2. Correction Factor (dB/m) = Antenna Factor (dB/m) + Cable Factor (dB).
 3. The other emission levels were very low against the limit.
 4. Margin value = Emission level – Limit value.
 5. “ * “: Fundamental frequency.

EUT TEST CONDITION		MEASUREMENT DETAIL	
CHANNEL	Channel 7	FREQUENCY RANGE	1 ~ 25GHz
INPUT POWER (SYSTEM)	120Vac, 60 Hz	DETECTOR FUNCTION	Peak (PK) Average (AV)
ENVIRONMENTAL CONDITIONS	25deg. C, 65%RH 999hPa	TESTED BY	Dean Wang

ANTENNA POLARITY & TEST DISTANCE: HORIZONTAL AT 3 M								
NO.	FREQ. (MHz)	EMISSION LEVEL (dBuV/m)	LIMIT (dBuV/m)	MARGIN (dB)	ANTENNA HEIGHT (m)	TABLE ANGLE (Degree)	RAW VALUE (dBuV)	CORRECTION FACTOR (dB/m)
1	*2452.00	100.87 PK			1.32 H	332	68.51	32.36
2	*2452.00	91.21 AV			1.32 H	332	58.85	32.36
3	2487.00	60.12 PK	74.00	-13.88	1.32 H	332	27.73	32.39
4	2487.00	49.28 AV	54.00	-4.72	1.32 H	332	16.89	32.39
5	4904.00	46.12 PK	74.00	-27.88	1.00 H	271	7.93	38.19
6	4904.00	34.16 AV	54.00	-19.84	1.00 H	271	-4.03	38.19
ANTENNA POLARITY & TEST DISTANCE: VERTICAL AT 3 M								
NO.	FREQ. (MHz)	EMISSION LEVEL (dBuV/m)	LIMIT (dBuV/m)	MARGIN (dB)	ANTENNA HEIGHT (m)	TABLE ANGLE (Degree)	RAW VALUE (dBuV)	CORRECTION FACTOR (dB/m)
1	*2452.00	106.68 PK			1.12 V	345	74.32	32.36
2	*2452.00	96.83 AV			1.12 V	345	64.47	32.36
3	2487.00	63.93 PK	74.00	-10.07	1.08 V	8	31.54	32.39
4	2487.00	52.44 AV	54.00	-1.56	1.08 V	8	20.05	32.39
5	4904.00	47.08 PK	74.00	-26.92	1.00 V	158	8.89	38.19
6	4904.00	34.96 AV	54.00	-19.04	1.00 V	158	-3.23	38.19

- REMARKS:**
1. Emission level (dBuV/m) = Raw Value (dBuV) + Correction Factor (dB/m).
 2. Correction Factor (dB/m) = Antenna Factor (dB/m) + Cable Factor (dB).
 3. The other emission levels were very low against the limit.
 4. Margin value = Emission level – Limit value.
 5. “ * “: Fundamental frequency.



BELOW 1GHz WORST-CASE DATA : 802.11b DSSS MODULATION

EUT TEST CONDITION		MEASUREMENT DETAIL	
CHANNEL	Channel 6	FREQUENCY RANGE	Below 1000MHz
INPUT POWER (SYSTEM)	120Vac, 60 Hz	DETECTOR FUNCTION	Quasi-Peak
ENVIRONMENTAL CONDITIONS	25deg. C, 65%RH 999hPa	TEST MODE	A
TESTED BY	Match Tsui		

ANTENNA POLARITY & TEST DISTANCE: HORIZONTAL AT 3 M								
NO.	FREQ. (MHz)	EMISSION LEVEL (dBuV/m)	LIMIT (dBuV/m)	MARGIN (dB)	ANTENNA HEIGHT (m)	TABLE ANGLE (Degree)	RAW VALUE (dBuV)	CORRECTION FACTOR (dB/m)
1	249.60	36.49 QP	46.00	-9.51	1.00 H	151	23.95	12.54
2	267.10	35.83 QP	46.00	-10.17	1.00 H	229	23.01	12.82
3	500.42	40.05 QP	46.00	-5.95	1.50 H	232	21.28	18.76
4	624.85	36.97 QP	46.00	-9.03	1.00 H	205	15.65	21.32
5	751.23	35.93 QP	46.00	-10.07	2.00 H	271	12.71	23.22
6	955.38	36.88 QP	46.00	-9.12	2.00 H	160	11.13	25.75
ANTENNA POLARITY & TEST DISTANCE: VERTICAL AT 3 M								
NO.	FREQ. (MHz)	EMISSION LEVEL (dBuV/m)	LIMIT (dBuV/m)	MARGIN (dB)	ANTENNA HEIGHT (m)	TABLE ANGLE (Degree)	RAW VALUE (dBuV)	CORRECTION FACTOR (dB/m)
1	96.01	32.56 QP	43.50	-10.94	1.00 V	268	23.47	9.10
2	249.60	37.50 QP	46.00	-8.50	1.00 V	175	24.97	12.54
3	500.42	38.06 QP	46.00	-7.94	1.50 V	166	19.30	18.76
4	751.23	35.27 QP	46.00	-10.73	1.50 V	187	12.05	23.22
5	799.84	36.04 QP	46.00	-9.96	1.50 V	106	11.68	24.36
6	949.55	38.13 QP	46.00	-7.87	1.00 V	184	12.41	25.72

- REMARKS:**
1. Emission level (dBuV/m) = Raw Value (dBuV) + Correction Factor (dB/m).
 2. Correction Factor (dB/m) = Antenna Factor (dB/m) + Cable Factor (dB).
 3. The other emission levels were very low against the limit.
 4. Margin value = Emission level – Limit value.

EUT TEST CONDITION		MEASUREMENT DETAIL	
CHANNEL	Channel 6	FREQUENCY RANGE	Below 1000MHz
INPUT POWER (SYSTEM)	120Vac, 60 Hz	DETECTOR FUNCTION	Quasi-Peak
ENVIRONMENTAL CONDITIONS	25deg. C, 65%RH 999hPa	TEST MODE	B
TESTED BY	Match Tsui		

ANTENNA POLARITY & TEST DISTANCE: HORIZONTAL AT 3 M								
NO.	FREQ. (MHz)	EMISSION LEVEL (dBuV/m)	LIMIT (dBuV/m)	MARGIN (dB)	ANTENNA HEIGHT (m)	TABLE ANGLE (Degree)	RAW VALUE (dBuV)	CORRECTION FACTOR (dB/m)
1	169.89	32.67 QP	43.50	-10.83	1.50 H	124	19.92	12.75
2	249.60	40.53 QP	46.00	-5.47	1.00 H	121	28.00	12.54
3	267.10	42.30 QP	46.00	-3.70	1.50 H	319	29.48	12.82
4	327.38	40.44 QP	46.00	-5.56	1.50 H	340	26.43	14.01
5	399.31	36.33 QP	46.00	-9.67	1.00 H	70	20.64	15.69
6	624.85	39.73 QP	46.00	-6.27	1.00 H	205	18.41	21.32
7	799.84	44.71 QP	46.00	-1.29	1.00 H	163	20.35	24.36
8	933.99	38.54 QP	46.00	-7.46	1.50 H	193	12.94	25.60
ANTENNA POLARITY & TEST DISTANCE: VERTICAL AT 3 M								
NO.	FREQ. (MHz)	EMISSION LEVEL (dBuV/m)	LIMIT (dBuV/m)	MARGIN (dB)	ANTENNA HEIGHT (m)	TABLE ANGLE (Degree)	RAW VALUE (dBuV)	CORRECTION FACTOR (dB/m)
1	249.60	38.95 QP	46.00	-7.05	1.50 V	163	26.41	12.54
2	284.60	40.89 QP	46.00	-5.11	1.00 V	121	27.78	13.10
3	331.26	39.06 QP	46.00	-6.94	1.50 V	19	24.95	14.11
4	500.42	41.12 QP	46.00	-4.88	1.00 V	217	22.36	18.76
5	751.23	37.05 QP	46.00	-8.95	1.00 V	181	13.83	23.22
6	799.84	41.48 QP	46.00	-4.52	1.00 V	181	17.12	24.36
7	951.49	37.26 QP	46.00	-8.74	1.00 V	250	11.52	25.73

- REMARKS:**
1. Emission level (dBuV/m) = Raw Value (dBuV) + Correction Factor (dB/m).
 2. Correction Factor (dB/m) = Antenna Factor (dB/m) + Cable Factor (dB).
 3. The other emission levels were very low against the limit.
 4. Margin value = Emission level – Limit value.

4.2 CONDUCTED EMISSION MEASUREMENT

4.2.1 LIMITS OF CONDUCTED EMISSION MEASUREMENT

FREQUENCY OF EMISSION (MHz)	CONDUCTED LIMIT (dB μ V)	
	Quasi-peak	Average
0.15-0.5	66 to 56	56 to 46
0.5-5	56	46
5-30	60	50

- NOTE:**
1. The lower limit shall apply at the transition frequencies.
 2. The limit decreases in line with the logarithm of the frequency in the range of 0.15 to 0.50 MHz.
 3. All emanations from a class A/B digital device or system, including any network of conductors and apparatus connected thereto, shall not exceed the level of field strengths specified above.

4.2.2 TEST INSTRUMENTS

DESCRIPTION & MANUFACTURER	MODEL NO.	SERIAL NO.	CALIBRATED UNTIL
Test Receiver ROHDE & SCHWARZ	ESCS30	100289	Dec. 06, 2008
RF signal cable Woken	5D-FB	Cable-HYC01-01	Jan. 06, 2009
LISN ROHDE & SCHWARZ	ESH3-Z5	100312	Feb. 13, 2008
LISN ROHDE & SCHWARZ	NNBL 8226-2	8226-142	May 07, 2008
Software ADT	ADT_Cond_V3	NA	NA

- NOTE:**
1. The calibration interval of the above test instruments is 12 months and the calibrations are traceable to NML/ROC and NIST/USA.
 2. The test was performed in HwaYa Shielded Room 1.
 3. The VCCI Site Registration No. is C-2040.

4.2.3 TEST PROCEDURES

- a. The EUT was placed 0.4 meters from the conducting wall of the shielded room with EUT being connected to the power mains through a line impedance stabilization network (LISN). Other support units were connected to the power mains through another LISN. The two LISNs provide 50 ohm/ 50uH of coupling impedance for the measuring instrument.
- b. Both lines of the power mains connected to the EUT were checked for maximum conducted interference.
- c. The frequency range from 150kHz to 30MHz was searched. Emission levels under (Limit - 20dB) was not recorded.

4.2.4 DEVIATION FROM TEST STANDARD

No deviation

4.2.5 TEST SETUP

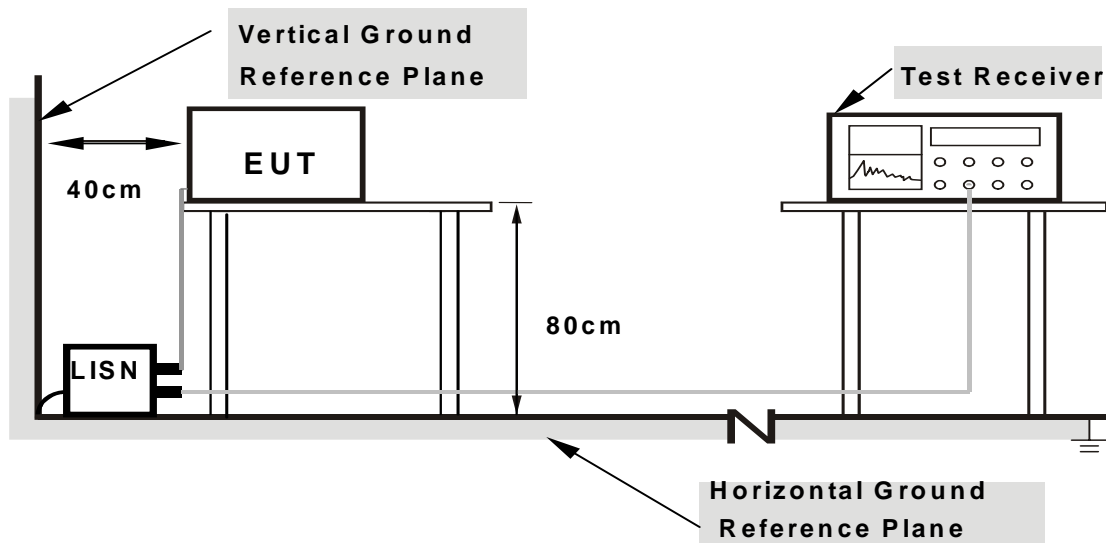

- Note:**
1. Support units were connected to second LISN.
 2. Both of LISNs (AMN) are 80 cm from EUT and at least 80 from other units and other metal planes

For the actual test configuration, please refer to the attached file (Test Setup Photo).

4.2.6 EUT OPERATING CONDITIONS

Same as 4.1.6

4.2.7 TEST RESULTS

CONDUCTED WORST-CASE DATA 802.11b OFDM MODULATION

EUT TEST CONDITION		MEASUREMENT DETAIL	
CHANNEL	Channel 6	PHASE	Line 1
ENVIRONMENTAL CONDITIONS	20deg. C, 60% RH, 991hPa	6dB BANDWIDTH	9 kHz
INPUT POWER (SYSTEM)	120Vac, 60 Hz	TESTED BY	Match Tsui

No	Freq. [MHz]	Corr. Factor (dB)	Reading Value [dB (uV)]		Emission Level [dB (uV)]		Limit [dB (uV)]		Margin (dB)	
			Q.P.	AV.	Q.P.	AV.	Q.P.	AV.	Q.P.	AV.
1	0.420	0.21	43.94	-	44.15	-	57.46	47.46	-13.31	-
2	0.517	0.22	44.26	-	44.48	-	56.00	46.00	-11.52	-
3	0.880	0.23	41.91	-	42.14	-	56.00	46.00	-13.86	-
4	1.963	0.26	41.62	-	41.88	-	56.00	46.00	-14.12	-
5	4.668	0.41	34.84	-	35.25	-	56.00	46.00	-20.75	-
6	14.449	0.73	32.06	-	32.79	-	60.00	50.00	-27.21	-

- REMARKS:**
1. Q.P. and AV. are abbreviations of quasi-peak and average individually.
 2. "-": The Quasi-peak reading value also meets average limit and measurement with the average detector is unnecessary.
 3. The emission levels of other frequencies were very low against the limit.
 4. Margin value = Emission level - Limit value
 5. Correction factor = Insertion loss + Cable loss
 6. Emission Level = Correction Factor + Reading Value.

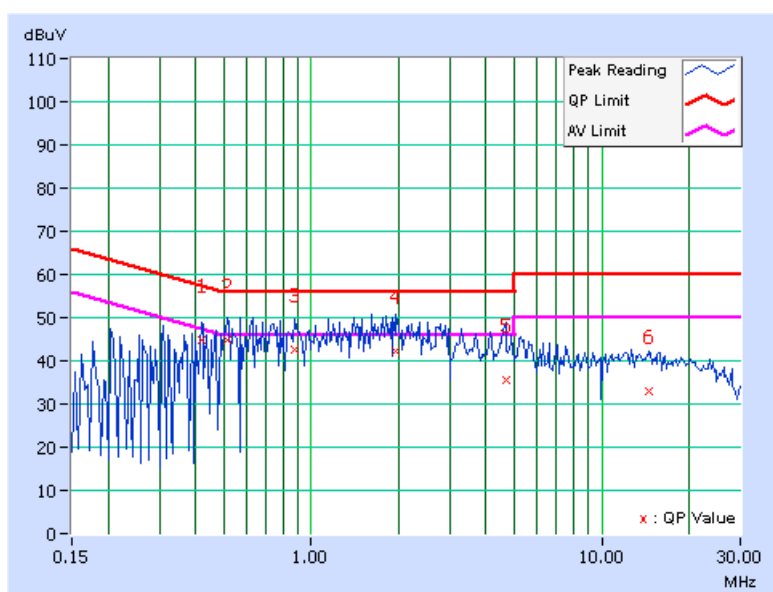

EUT TEST CONDITION		MEASUREMENT DETAIL	
CHANNEL	Channel 6	PHASE	Line 2
ENVIRONMENTAL CONDITIONS	20deg. C, 60% RH, 991hPa	6dB BANDWIDTH	9 kHz
INPUT POWER (SYSTEM)	120Vac, 60 Hz	TESTED BY	Match Tsui

No	Freq. [MHz]	Corr. Factor [dB]	Reading Value [dB (uV)]		Emission Level [dB (uV)]		Limit [dB (uV)]		Margin (dB)	
			Q.P.	AV.	Q.P.	AV.	Q.P.	AV.	Q.P.	AV.
1	0.361	0.21	46.41	-	46.62	-	58.71	48.71	-12.09	-
2	0.564	0.22	45.83	26.32	46.05	26.54	56.00	46.00	-9.95	-19.46
3	1.029	0.24	40.73	-	40.97	-	56.00	46.00	-15.03	-
4	1.646	0.25	38.63	-	38.88	-	56.00	46.00	-17.12	-
5	2.716	0.31	35.12	-	35.43	-	56.00	46.00	-20.57	-
6	14.387	0.46	30.56	-	31.02	-	60.00	50.00	-28.98	-

- REMARKS:**
1. Q.P. and AV. are abbreviations of quasi-peak and average individually.
 2. "-": The Quasi-peak reading value also meets average limit and measurement with the average detector is unnecessary.
 3. The emission levels of other frequencies were very low against the limit.
 4. Margin value = Emission level - Limit value
 5. Correction factor = Insertion loss + Cable loss
 6. Emission Level = Correction Factor + Reading Value.

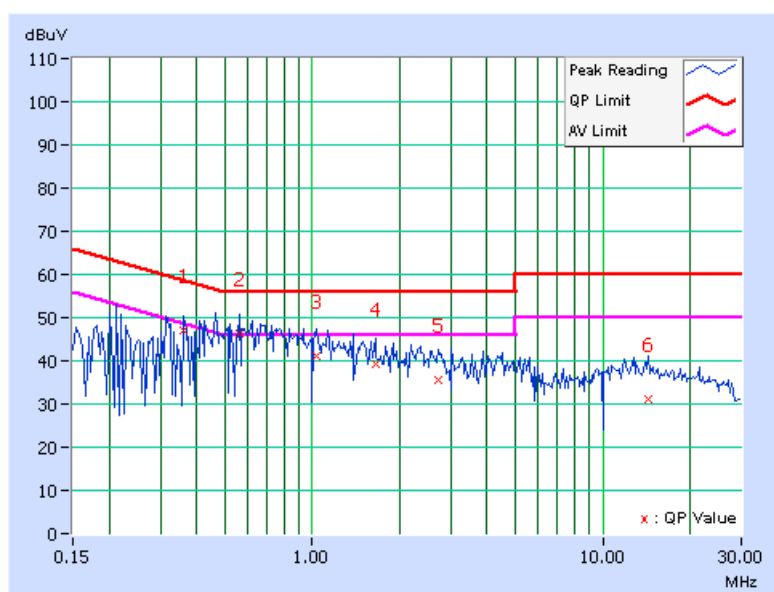



4.3 6dB BANDWIDTH MEASUREMENT

4.3.1 LIMITS OF 6dB BANDWIDTH MEASUREMENT

The minimum of 6dB Bandwidth Measurement is 0.5 MHz.

4.3.2 TEST INSTRUMENTS

DESCRIPTION & MANUFACTURER	MODEL NO.	SERIAL NO.	CALIBRATED UNTIL
SPECTRUM ANALYZER	FSP40	100040	Jun. 28, 2008

NOTE: The calibration interval of the above test instruments is 12 months and the calibrations are traceable to NML/ROC and NIST/USA.

4.3.3 TEST PROCEDURE

The transmitter output was connected to the spectrum analyzer through an attenuator. The bandwidth of the fundamental frequency was measured by spectrum analyzer with 100kHz RBW and 300kHz VBW. The 6dB bandwidth is defined as the total spectrum the power of which is higher than peak power minus 6dB.

4.3.4 DEVIATION FROM TEST STANDARD

No deviation

4.3.5 TEST SETUP

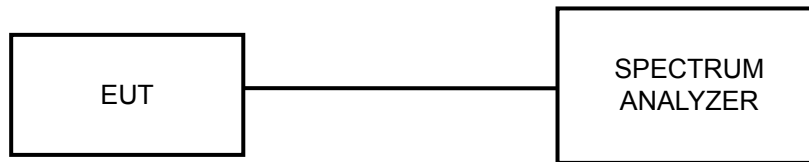

4.3.6 EUT OPERATING CONDITIONS

The software provided by client to enable the EUT under transmission condition continuously at lowest, middle and highest channel frequencies individually.



4.3.7 TEST RESULTS

802.11b DSSS MODULATION

INPUT POWER (SYSTEM)	120Vac, 60 Hz	ENVIRONMENTAL CONDITIONS	25deg.C, 65% RH, 991hPa
TESTED BY	Brad Wu		

CHANNEL	CHANNEL FREQUENCY (MHz)	6dB BANDWIDTH (MHz)	MINIMUM LIMIT (MHz)	PASS / FAIL
1	2412	12.18	0.5	PASS
6	2437	12.16	0.5	PASS
11	2462	12.16	0.5	PASS

CH 1

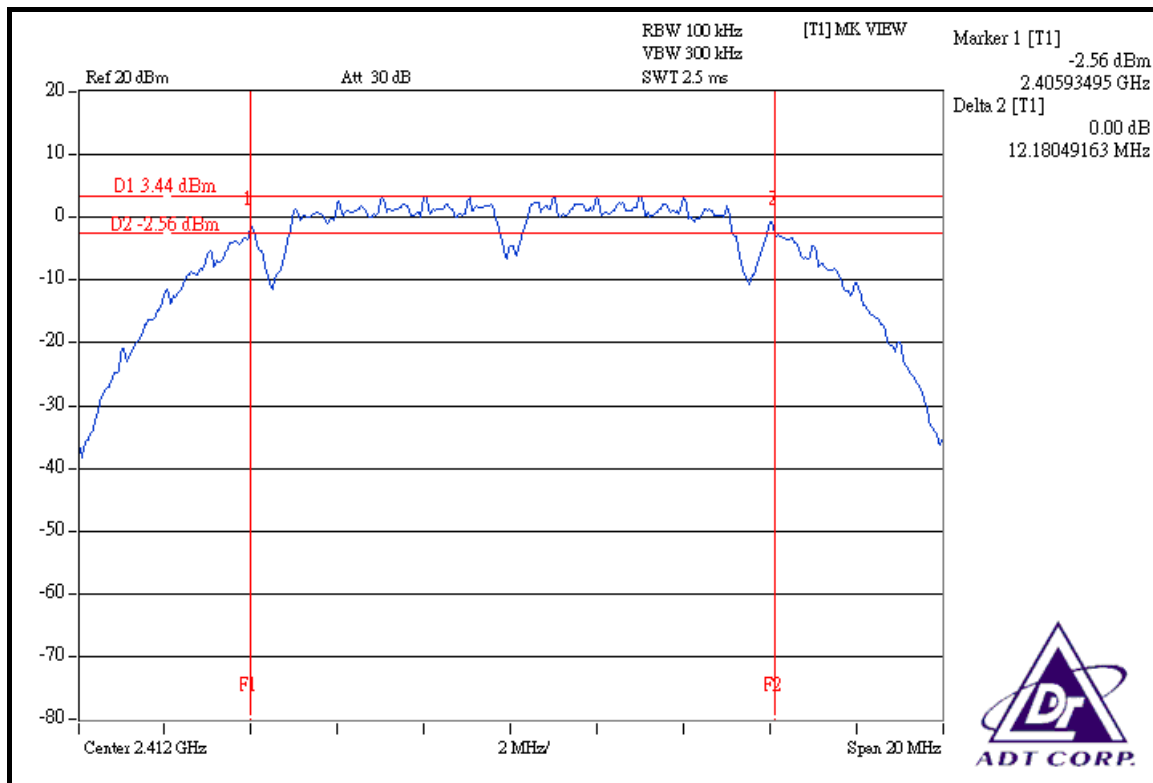

CH 6

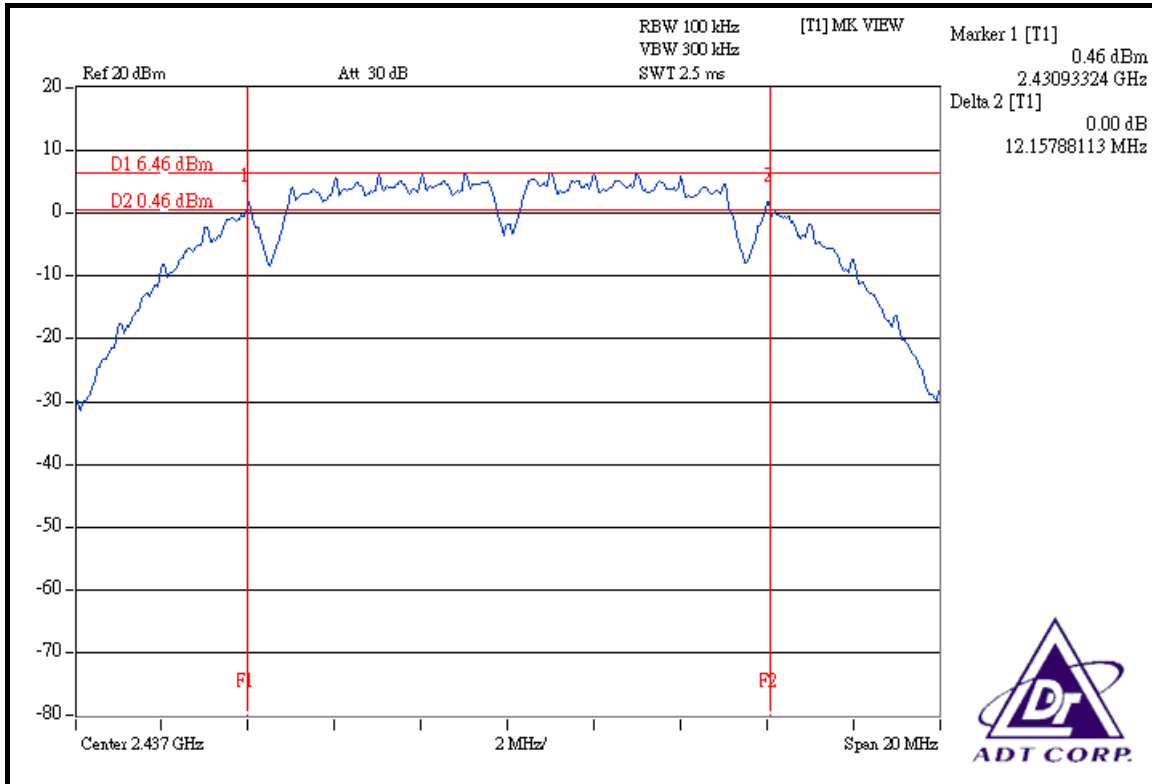

CH 11

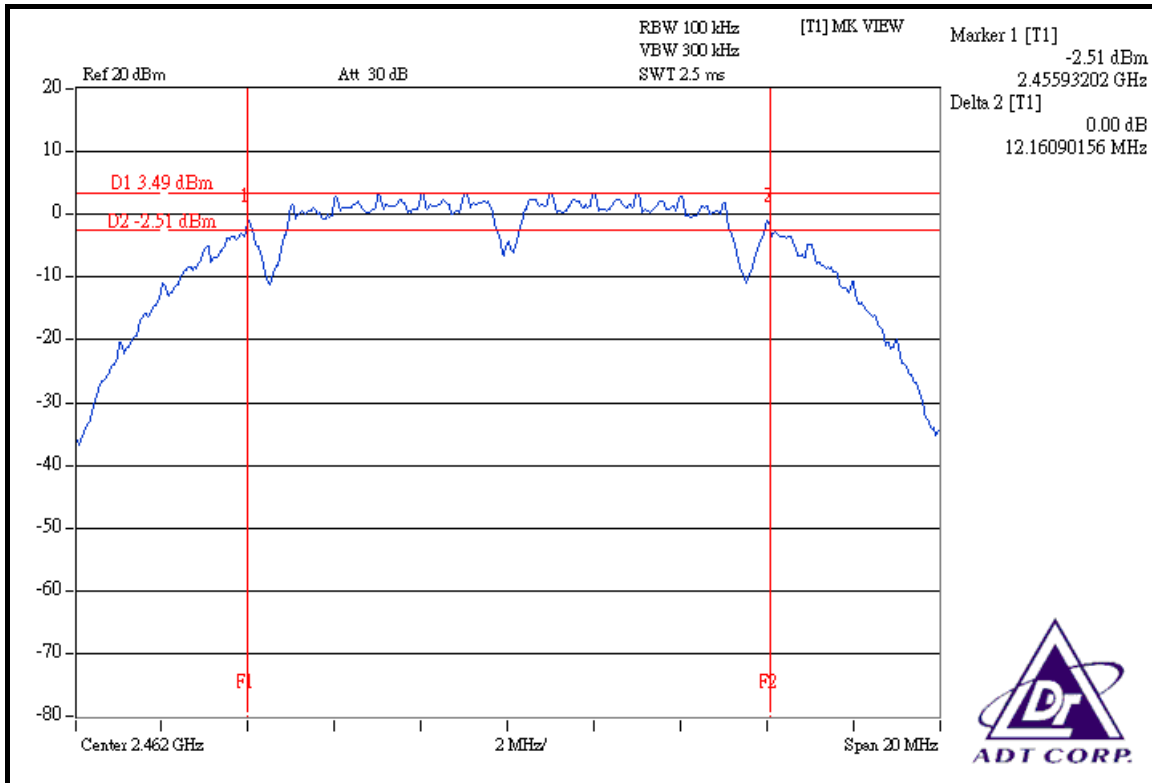



802.11g OFDM MODULATION

INPUT POWER (SYSTEM)	120Vac, 60 Hz	ENVIRONMENTAL CONDITIONS	25deg.C, 65% RH, 991hPa
TESTED BY	Brad Wu		

CHANNEL	CHANNEL FREQUENCY (MHz)	6dB BANDWIDTH (MHz)		MINIMUM LIMIT (MHz)	PASS / FAIL
		CHAIN 0	CHAIN 1		
1	2412	16.61	16.61	0.5	PASS
6	2437	16.61	16.58	0.5	PASS
11	2462	16.61	16.62	0.5	PASS



FOR CHAIN 0: CH 1

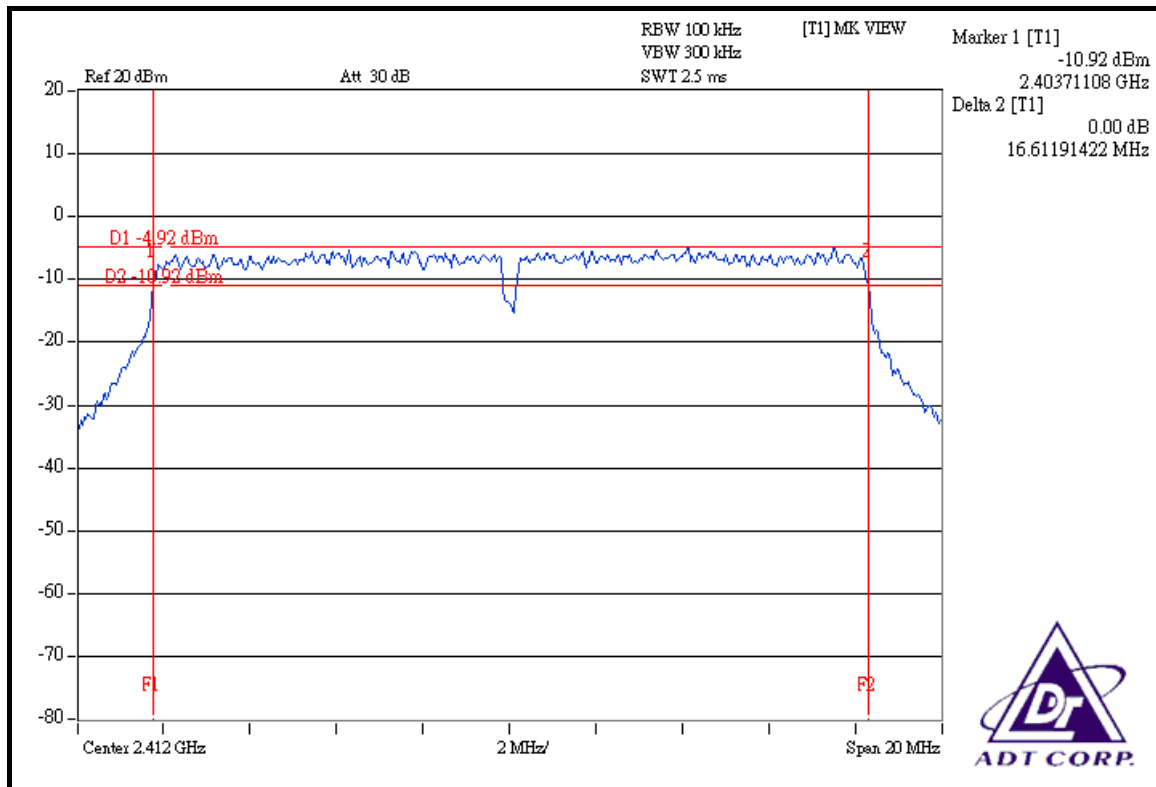

CH 6

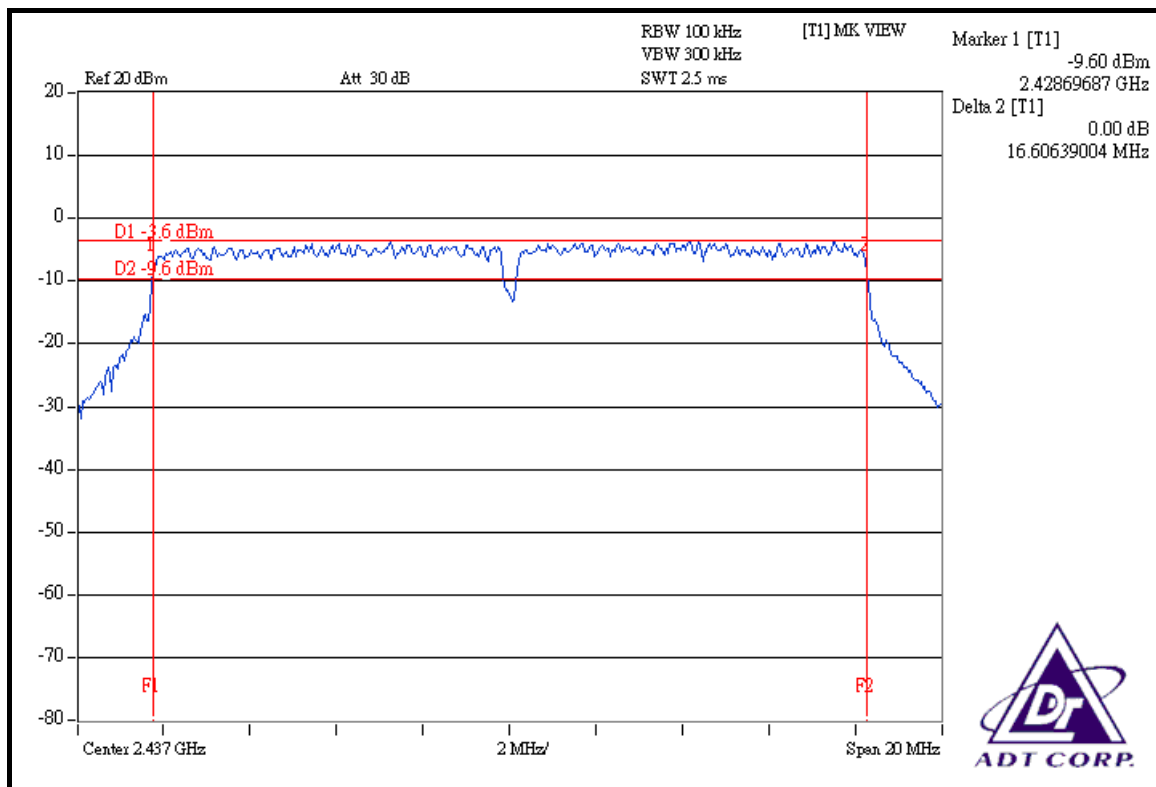

CH 11

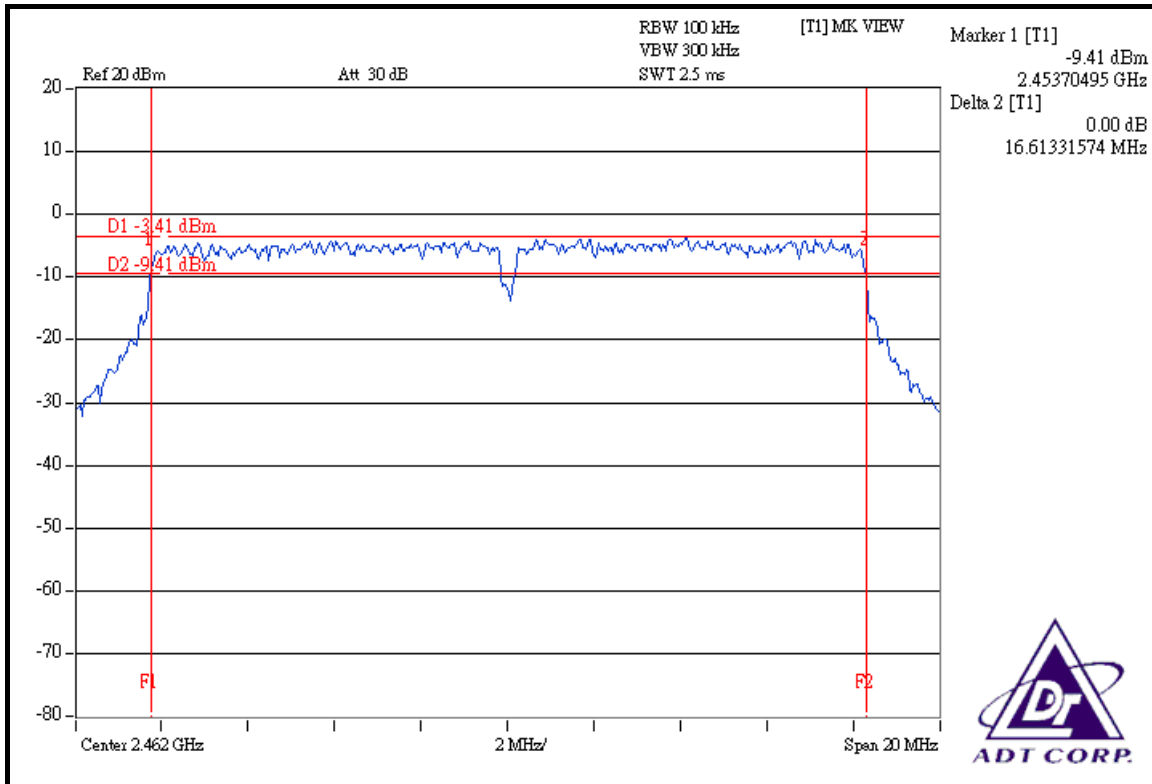

FOR CHAIN 1: CH 1

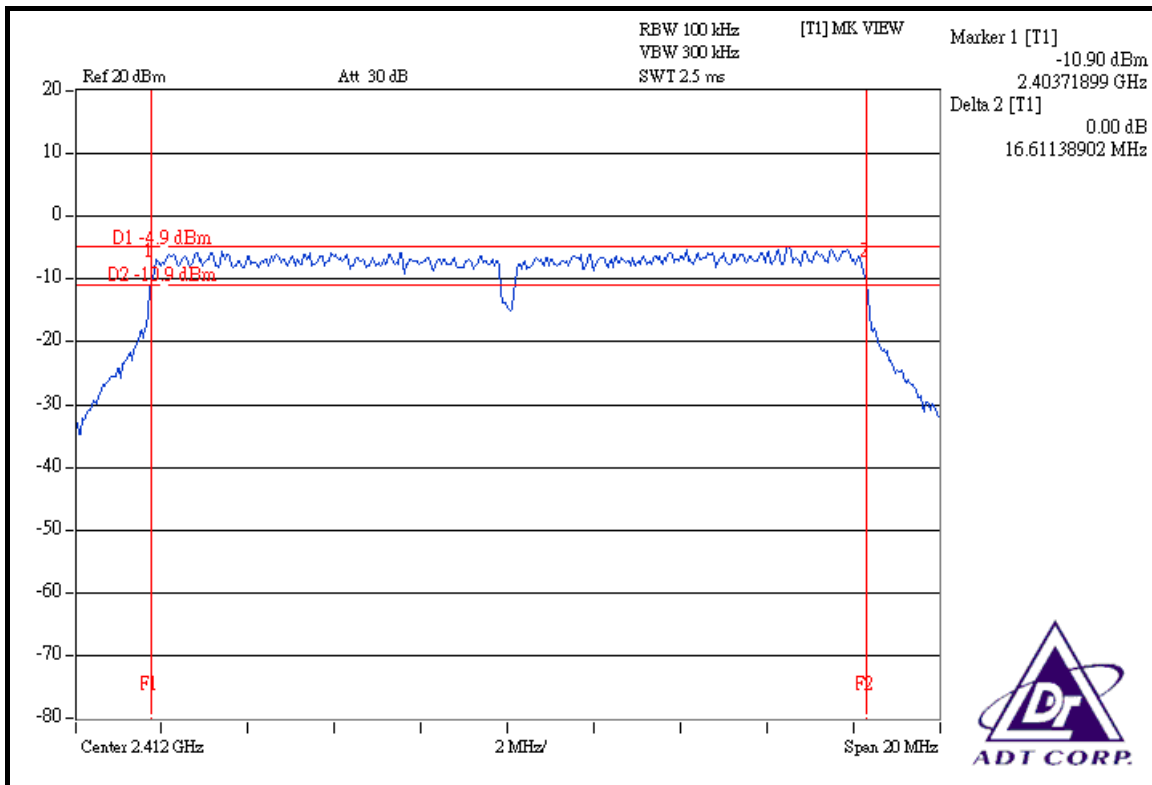

CH 6

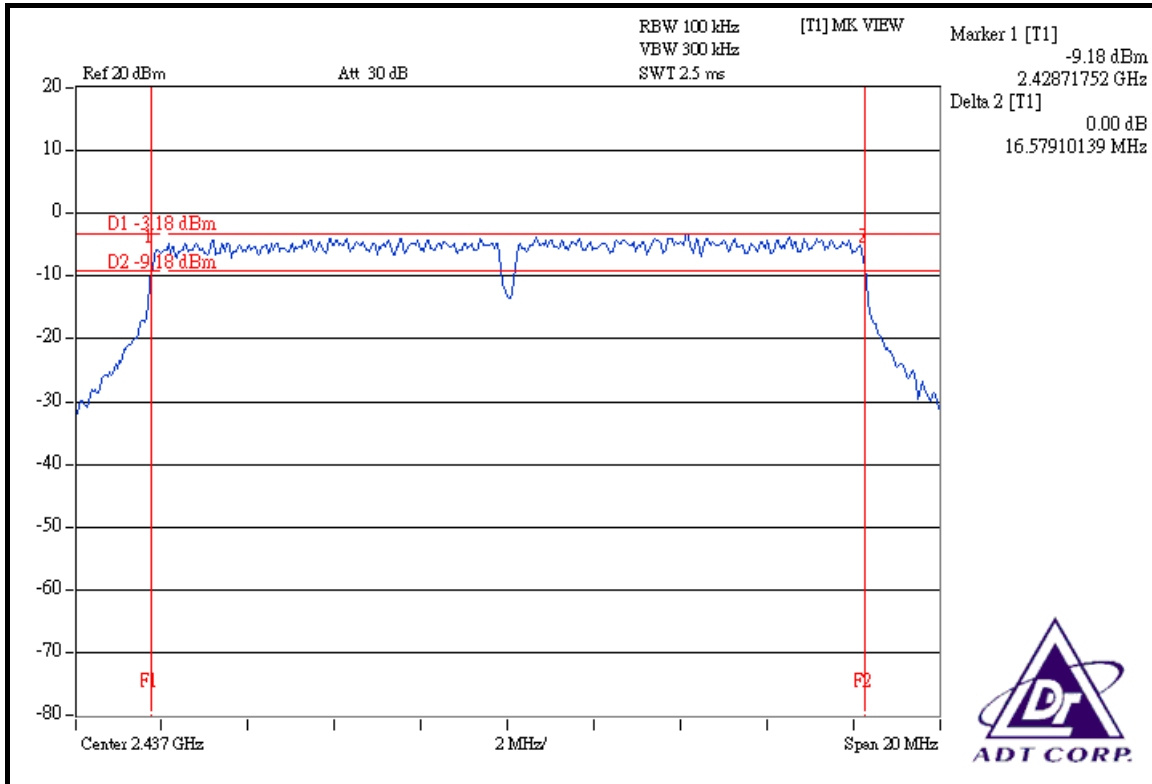

CH 11

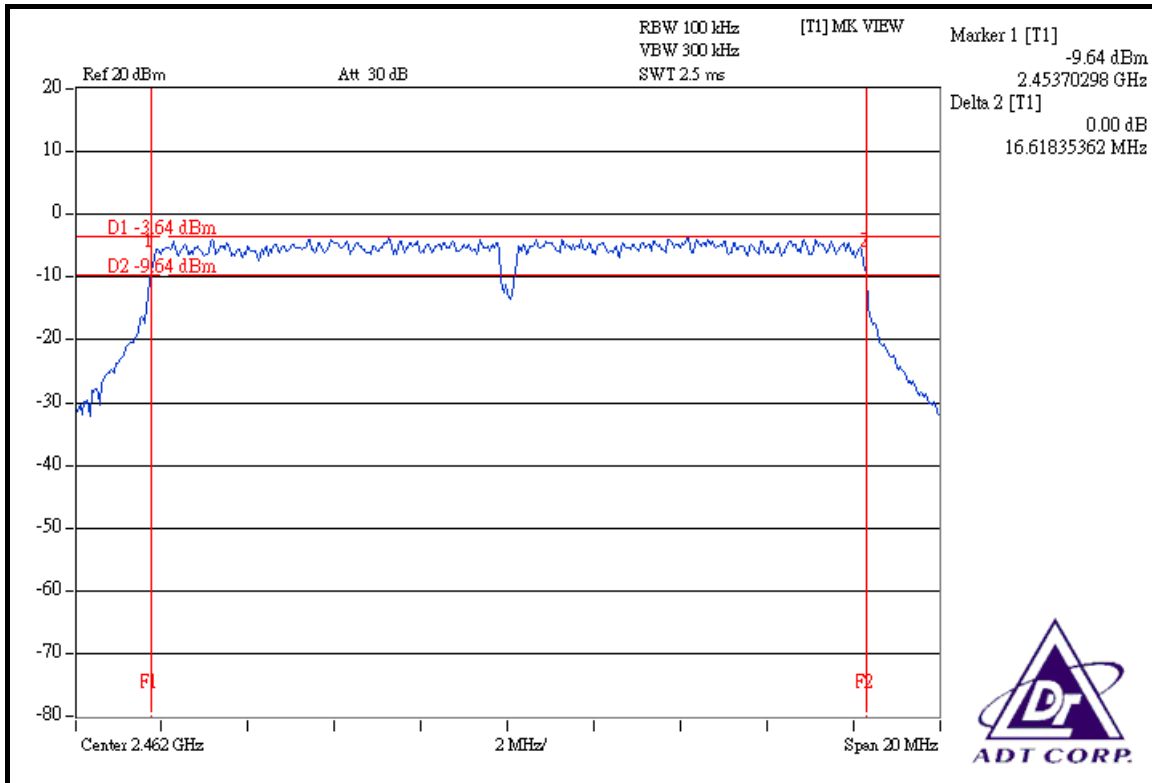



DRAFT 802.11n (20MHz) OFDM MODULATION

INPUT POWER (SYSTEM)	120Vac, 60 Hz	ENVIRONMENTAL CONDITIONS	25deg.C, 65% RH, 991hPa
TESTED BY	Brad Wu		

CHANNEL	CHANNEL FREQUENCY (MHz)	6dB BANDWIDTH (MHz)		MINIMUM LIMIT (MHz)	PASS / FAIL
		CHAIN 0	CHAIN 1		
1	2412	17.69	17.69	0.5	PASS
6	2437	17.80	17.82	0.5	PASS
11	2462	17.70	17.71	0.5	PASS

FOR CHAIN 0: CH 1

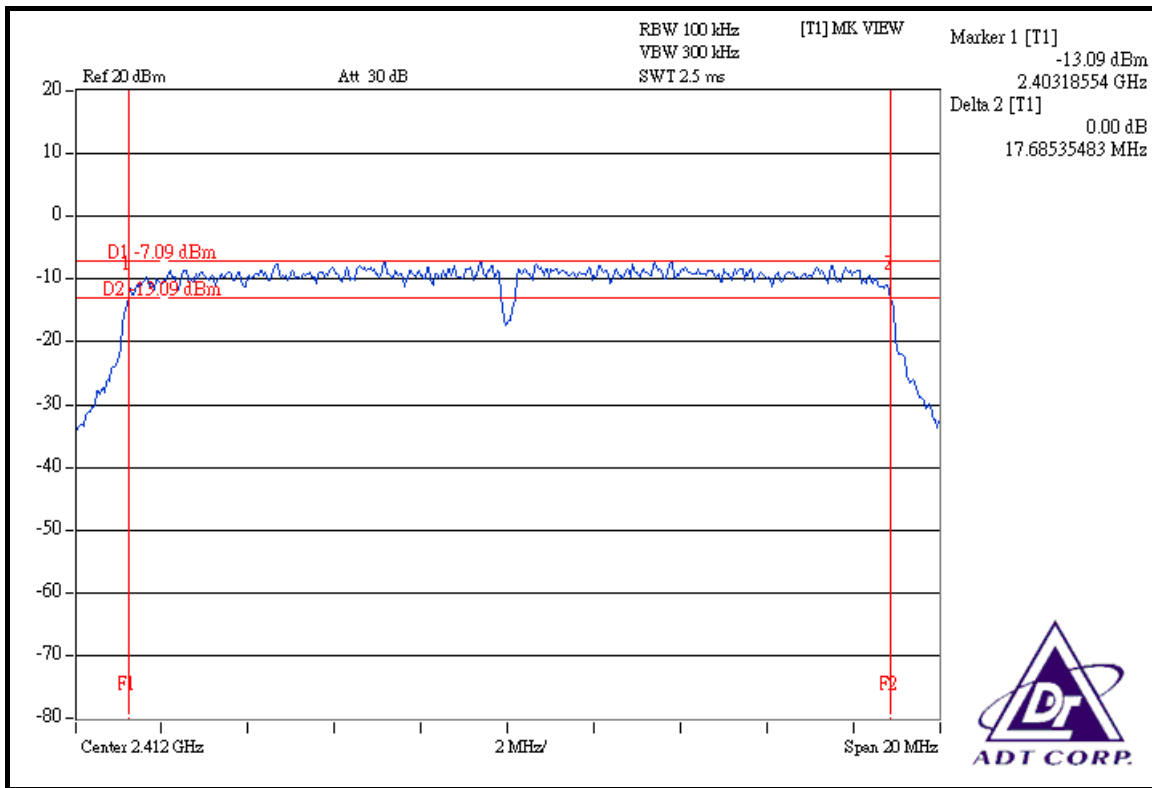

CH 6

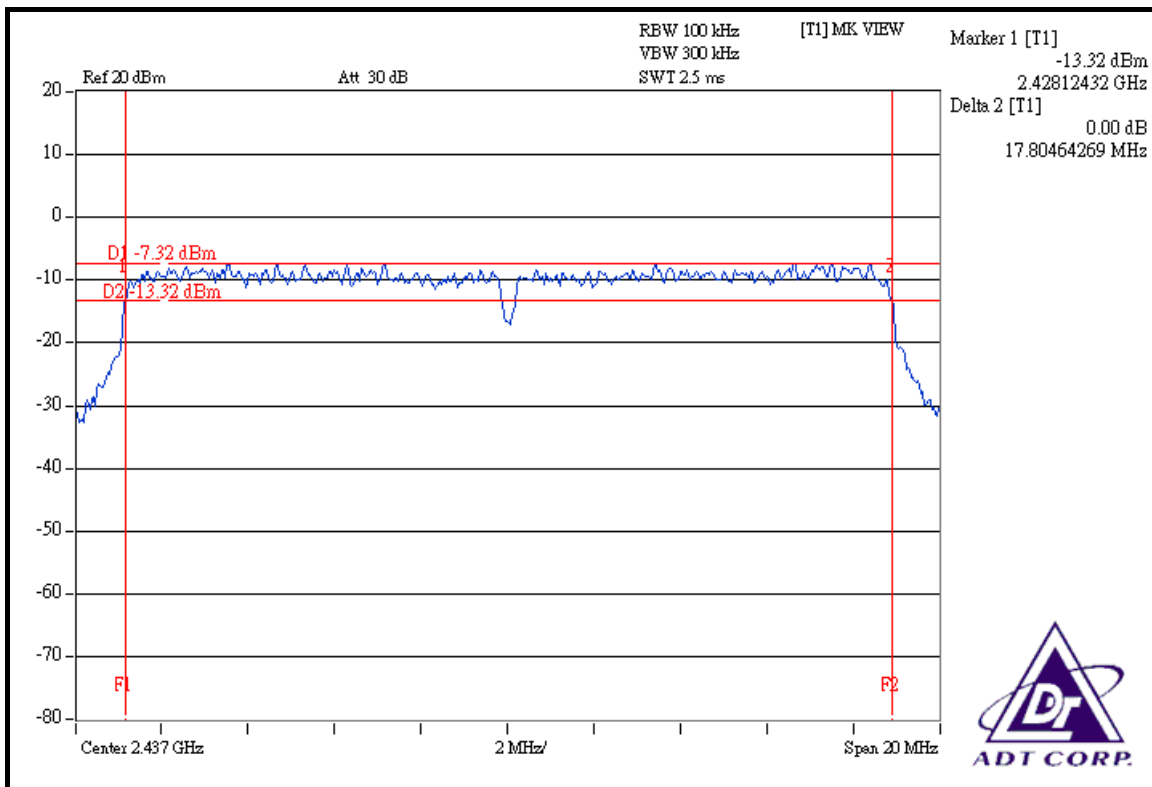

CH 11

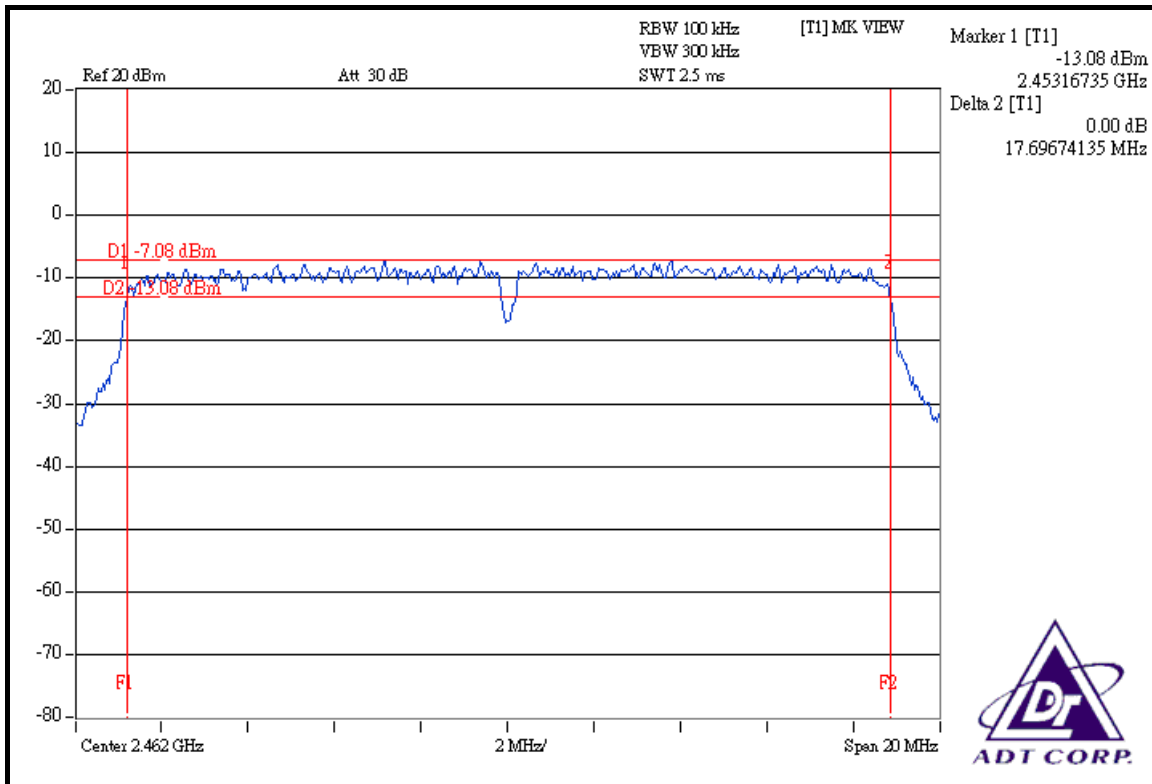

FOR CHAIN 1: CH 1

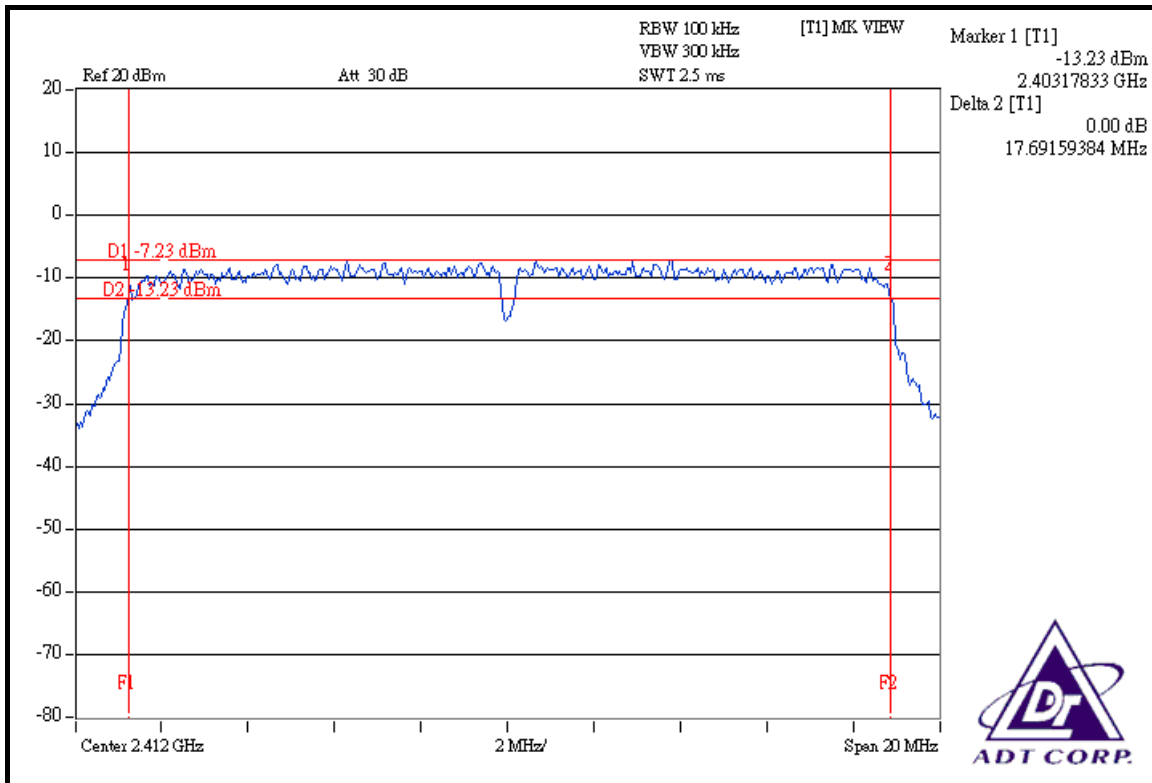

CH 6

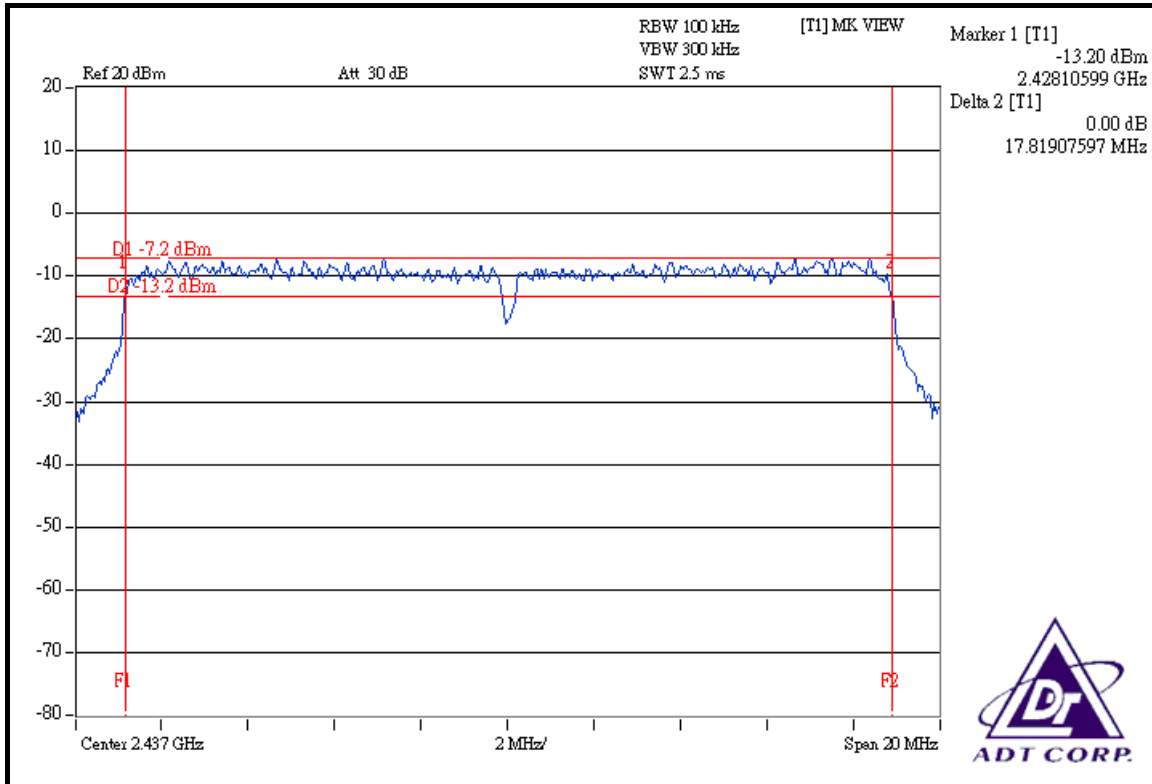

CH 11

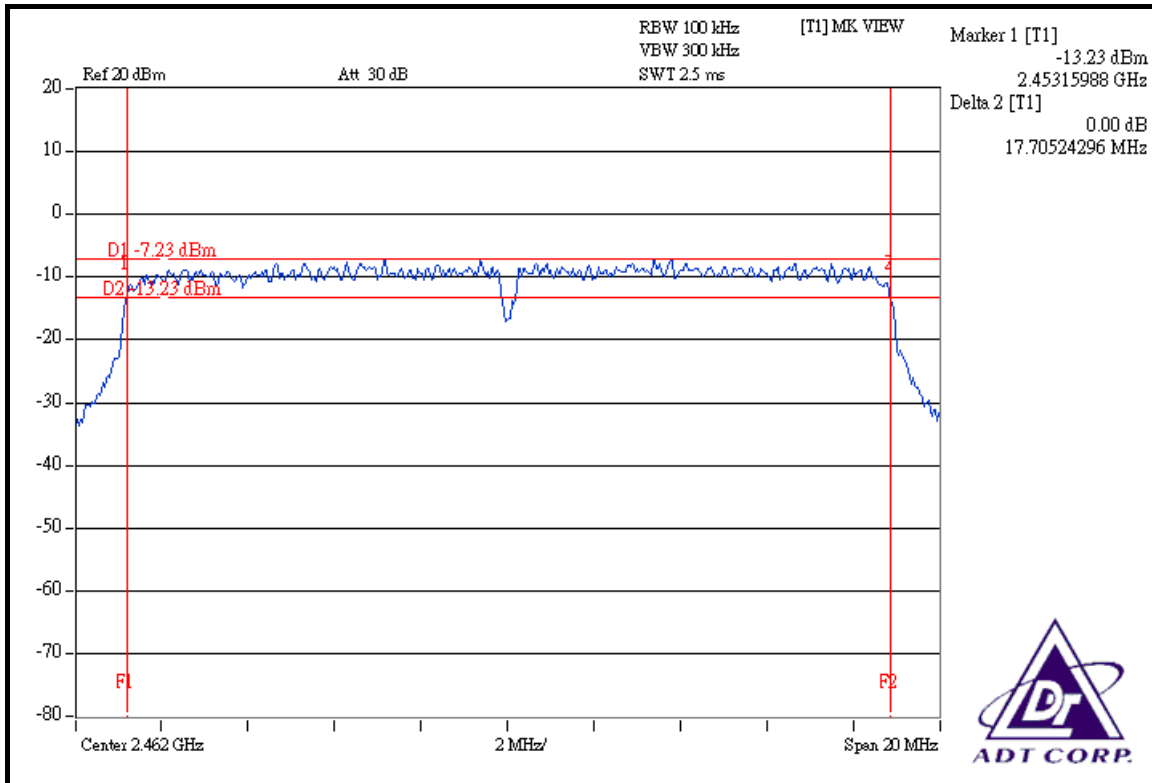



DRAFT 802.11n (40MHz) OFDM MODULATION

INPUT POWER (SYSTEM)	120Vac, 60 Hz	ENVIRONMENTAL CONDITIONS	25deg.C, 65% RH, 991hPa
TESTED BY	Brad Wu		

CHANNEL	CHANNEL FREQUENCY (MHz)	6dB BANDWIDTH (MHz)		MINIMUM LIMIT (MHz)	PASS / FAIL
		CHAIN 0	CHAIN 1		
1	2422	36.47	36.43	0.5	PASS
4	2437	36.52	36.48	0.5	PASS
7	2452	36.55	36.55	0.5	PASS

FOR CHAIN 0: CH 1

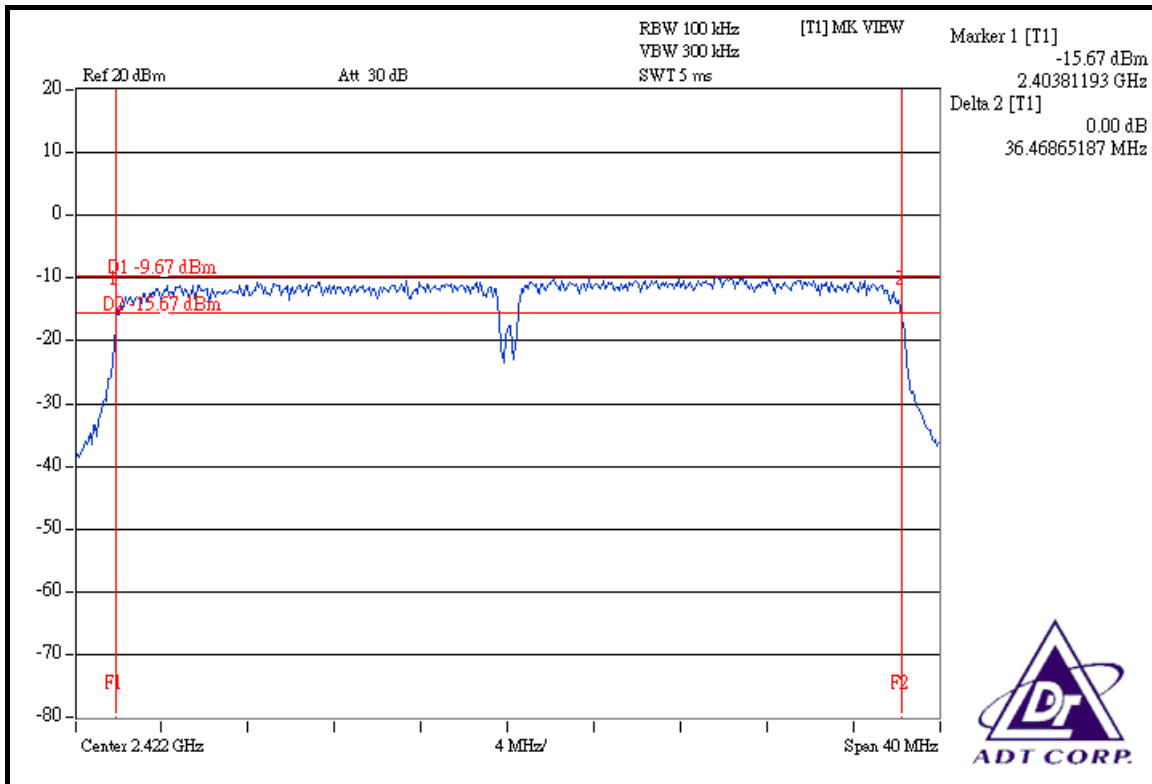

CH 4

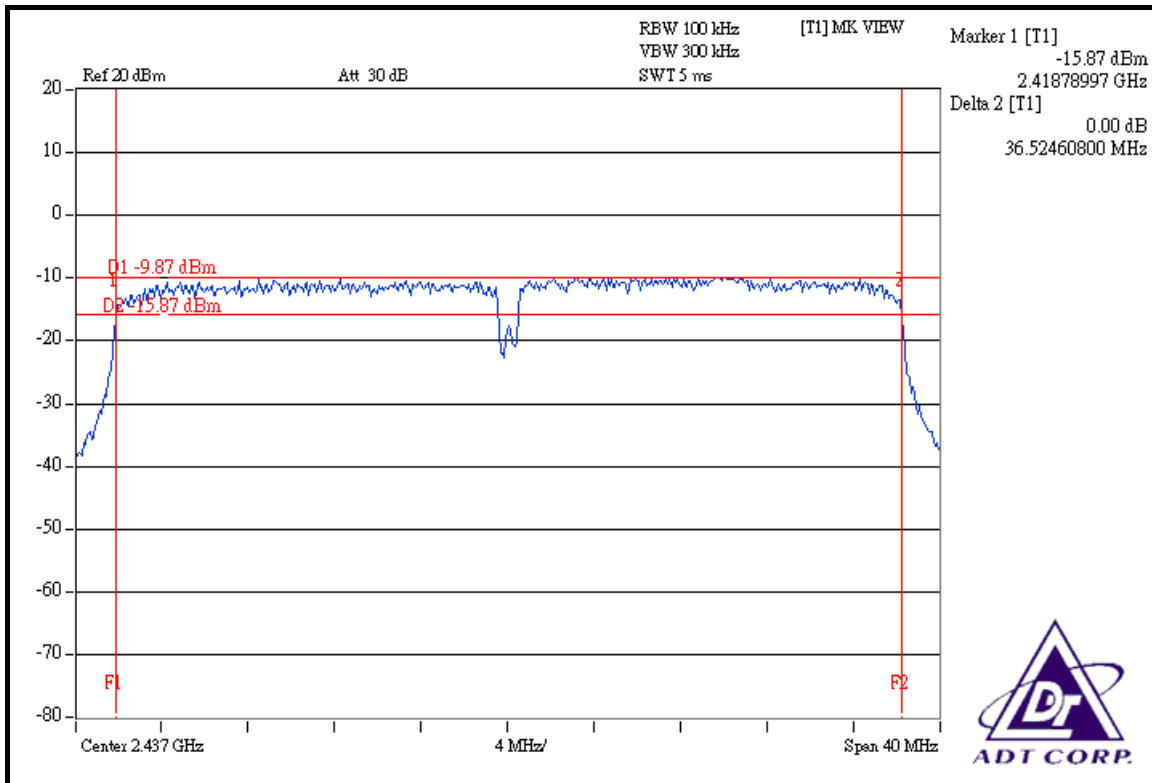

CH 7

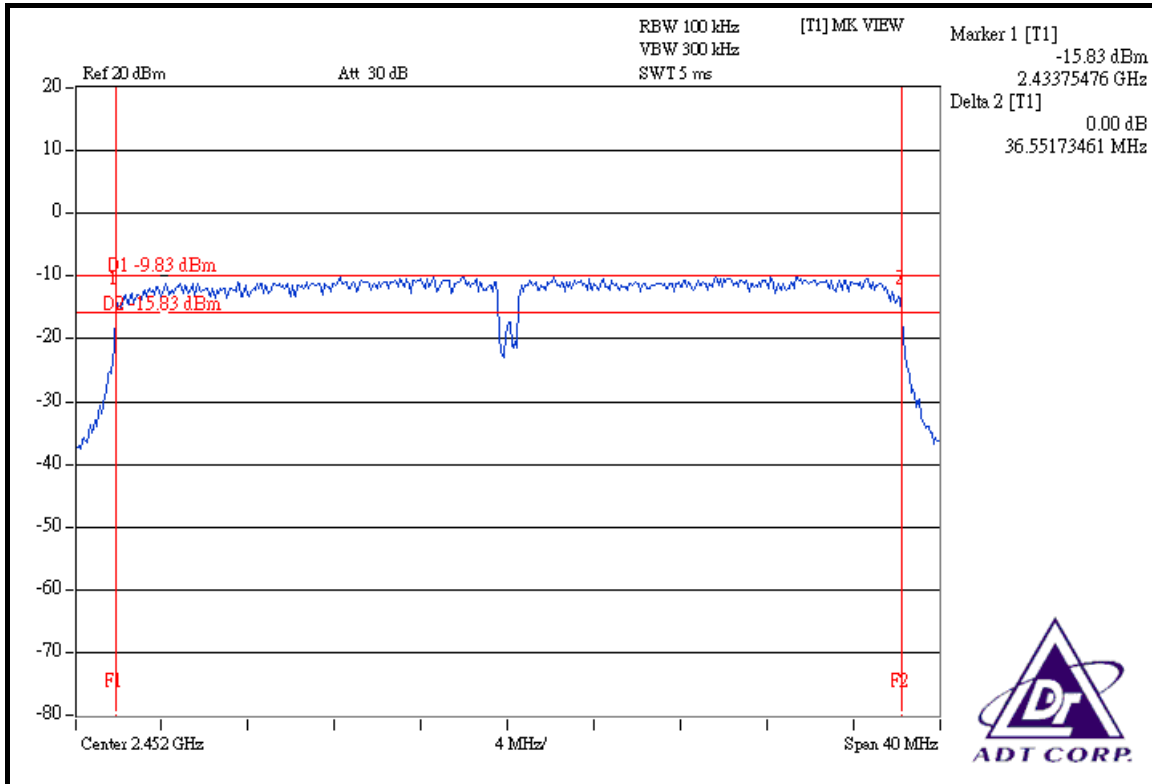

FOR CHAIN 1: CH 1

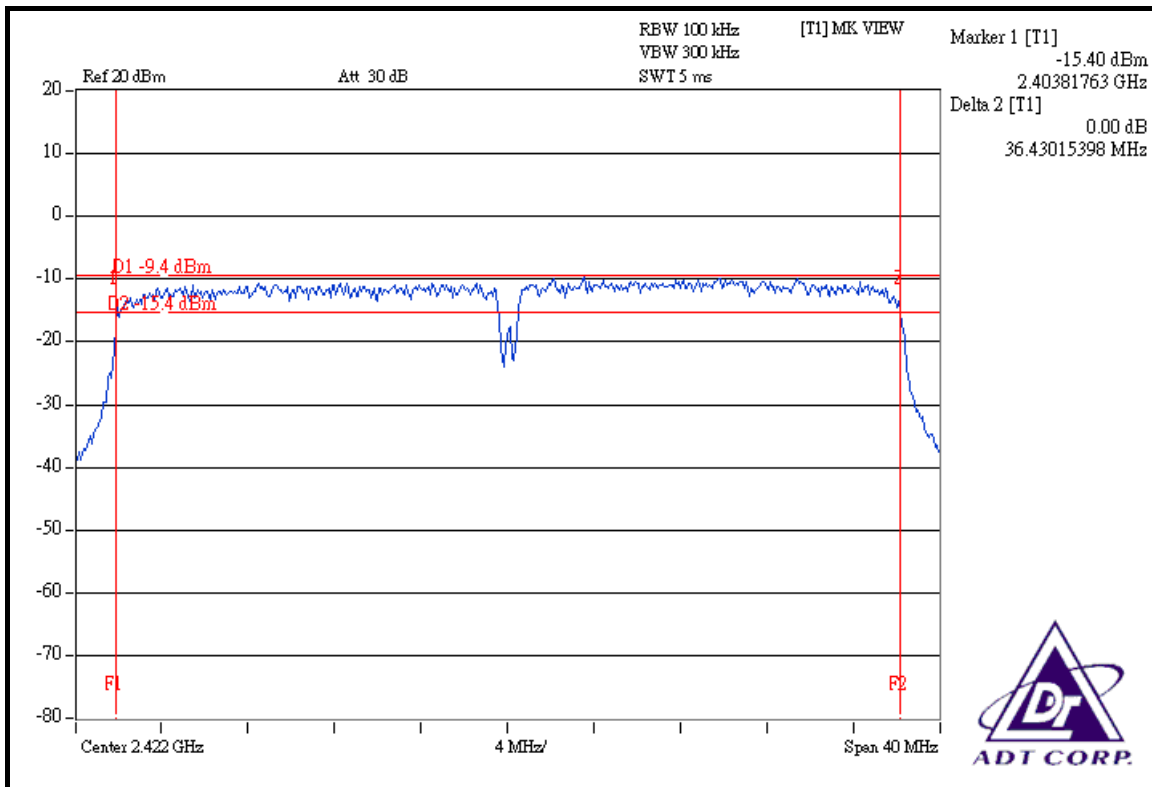

CH 4

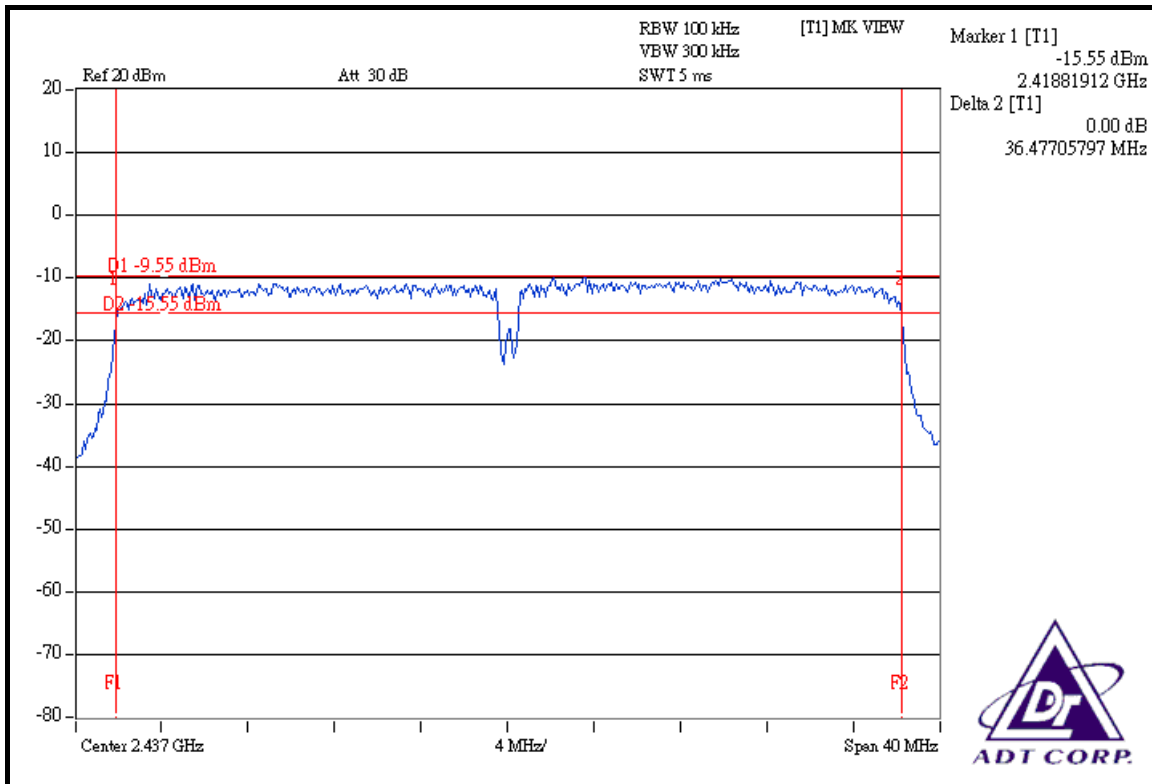

CH 7

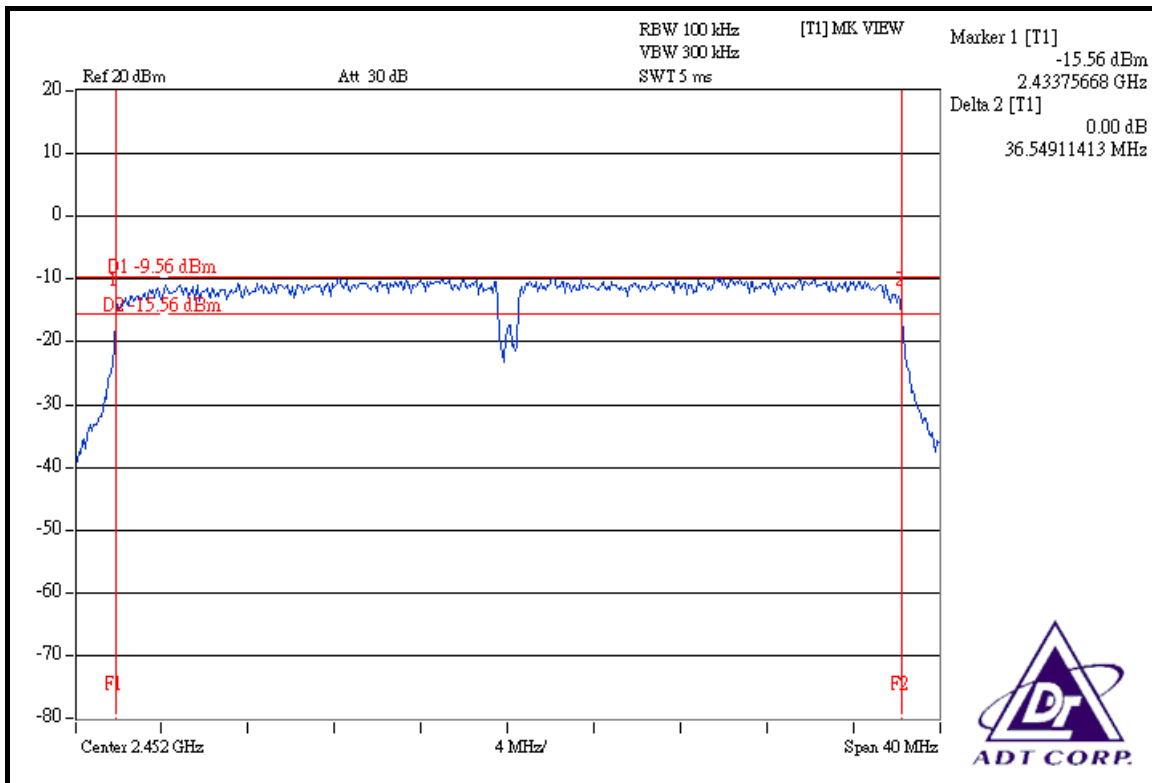



4.4 MAXIMUM PEAK OUTPUT POWER

4.4.1 LIMITS OF MAXIMUM PEAK OUTPUT POWER MEASUREMENT

The Maximum Peak Output Power Measurement is 30dBm.

4.4.2 INSTRUMENTS

DESCRIPTION & MANUFACTURER	MODEL NO.	SERIAL NO.	CALIBRATED UNTIL
R&S SPECTRUM ANALYZER	FSP40	100040	Jun. 28, 2008
AGILENT SYNTHESIZED SIGNAL GENERATOR	E8257C	MY43320668	Jan. 09, 2008
DIGITAL RT OSCILLOSCOPE	TDS1012	C037299	Nov. 21, 2008
NARDA DETECTOR	4503A	FSCM99899	NA

NOTE: The calibration interval of the above test instruments is 12 months and the calibrations are traceable to NML/ROC and NIST/USA.

4.4.3 TEST PROCEDURES

- a. A detector was used on the output port of the EUT. An oscilloscope was used to read the response of the detector.
- b. Replaced the EUT by the signal generator. The center frequency of the S.G was adjusted to the center frequency of the measured channel.
- c. Adjusted the power to have the same reading on oscilloscope. Record the power level.

4.4.4 DEVIATION FROM TEST STANDARD

No deviation

4.4.5 TEST SETUP



4.4.6 EUT OPERATING CONDITIONS

Same as Item 4.3.6



4.4.7 TEST RESULTS

802.11b DSSS MODULATION

INPUT POWER (SYSTEM)	120Vac, 60 Hz	ENVIRONMENTAL CONDITIONS	25deg.C, 65% RH, 991hPa
TESTED BY	Brad Wu		

CHANNEL	CHANNEL FREQUENCY (MHz)	PEAK POWER OUTPUT (mW)	PEAK POWER OUTPUT (dBm)	PEAK POWER LIMIT (dBm)	PASS / FAIL
1	2412	32.285	15.09	30	PASS
6	2437	63.387	18.02	30	PASS
11	2462	31.915	15.04	30	PASS

802.11g OFDM MODULATION

INPUT POWER (SYSTEM)	120Vac, 60 Hz	ENVIRONMENTAL CONDITIONS	25deg.C, 65% RH, 991hPa
TESTED BY	Brad Wu		

CHAN.	CHANNEL FREQUENCY (MHz)	PEAK POWER OUTPUT (mW)		PEAK POWER OUTPUT (dBm)		TOTAL PEAK POWER (mW)	TOTAL PEAK POWER (dBm)	PEAK POWER LIMIT (dBm)	PASS / FAIL
		CHAIN 0	CHAIN 1	CHAIN 0	CHAIN 1				
1	2412	22.542	22.439	13.53	13.51	44.981	16.53	30	PASS
6	2437	32.359	32.285	15.10	15.09	64.644	18.11	30	PASS
11	2462	31.696	32.285	15.01	15.09	63.981	18.06	30	PASS



DRAFT 802.11n (20MHz) OFDM MODULATION

INPUT POWER (SYSTEM)	120Vac, 60 Hz	ENVIRONMENTAL CONDITIONS	25deg.C, 65% RH, 991hPa
TESTED BY	Brad Wu		

CHAN.	CHANNEL FREQUENCY (MHz)	PEAK POWER OUTPUT (mW)		PEAK POWER OUTPUT (dBm)		TOTAL PEAK POWER (mW)	TOTAL PEAK POWER (dBm)	PEAK POWER LIMIT (dBm)	PASS / FAIL
		CHAIN 0	CHAIN 1	CHAIN 0	CHAIN 1				
1	2412	12.677	12.735	11.03	11.05	25.412	14.05	30	PASS
6	2437	12.677	12.764	11.03	11.06	25.441	14.06	30	PASS
11	2462	12.677	12.589	11.03	11.00	25.266	14.03	30	PASS

DRAFT 802.11n (40MHz) OFDM MODULATION

INPUT POWER (SYSTEM)	120Vac, 60 Hz	ENVIRONMENTAL CONDITIONS	25deg.C, 65% RH, 991hPa
TESTED BY	Brad Wu		

CHAN.	CHANNEL FREQUENCY (MHz)	PEAK POWER OUTPUT (mW)		PEAK POWER OUTPUT (dBm)		TOTAL PEAK POWER (mW)	TOTAL PEAK POWER (dBm)	PEAK POWER LIMIT (dBm)	PASS / FAIL
		CHAIN 0	CHAIN 1	CHAIN 0	CHAIN 1				
1	2422	12.706	12.972	11.04	11.13	25.678	14.10	30	PASS
4	2437	12.647	12.882	11.02	11.10	25.530	14.07	30	PASS
7	2452	12.794	12.942	11.07	11.12	25.736	14.11	30	PASS



4.5 POWER SPECTRAL DENSITY MEASUREMENT

4.5.1 LIMITS OF POWER SPECTRAL DENSITY MEASUREMENT

The Maximum of Power Spectral Density Measurement is 8dBm.

4.5.2 TEST INSTRUMENTS

DESCRIPTION & MANUFACTURER	MODEL NO.	SERIAL NO.	CALIBRATED UNTIL
R&S SPECTRUM ANALYZER	FSP40	100040	Jun. 28, 2008

NOTE: The calibration interval of the above test instruments is 12 months and the calibrations are traceable to NML/ROC and NIST/USA.

4.5.3 TEST PROCEDURE

The transmitter output was connected to the spectrum analyzer through an attenuator, the bandwidth of the fundamental frequency was measured with the spectrum analyzer using 3kHz RBW and 30kHz VBW, set sweep time = span/3kHz. The power spectral density was measured and recorded.

The sweep time is allowed to be longer than span/3kHz for a full response of the mixer in the spectrum analyzer.

4.5.4 DEVIATION FROM TEST STANDARD

No deviation

4.5.5 TEST SETUP

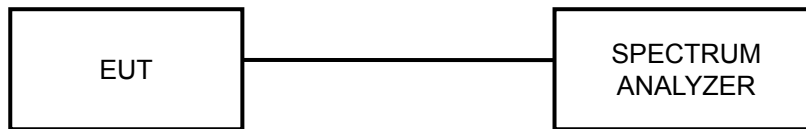

4.5.6 EUT OPERATING CONDITION

Same as Item 4.3.6

4.5.7 TEST RESULTS

802.11b DSSS MODULATION

INPUT POWER (SYSTEM)	120Vac, 60 Hz	ENVIRONMENTAL CONDITIONS	25deg.C, 65% RH, 991hPa
TESTED BY	Brad Wu		

CHANNEL	CHANNEL FREQUENCY (MHz)	RF POWER LEVEL IN 3kHz BW (dBm)	MAXIMUM LIMIT (dBm)	PASS / FAIL
1	2412	-14.88	8	PASS
6	2437	-11.85	8	PASS
11	2462	-14.80	8	PASS

CH 1

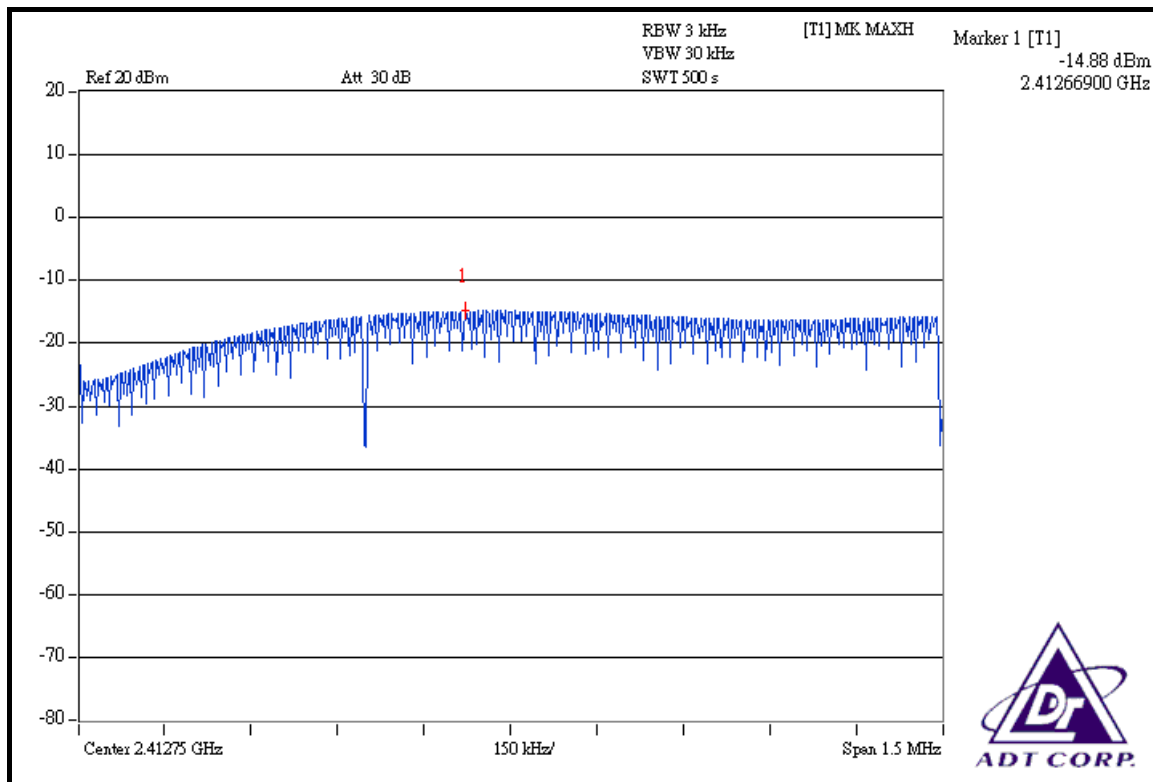

CH 6

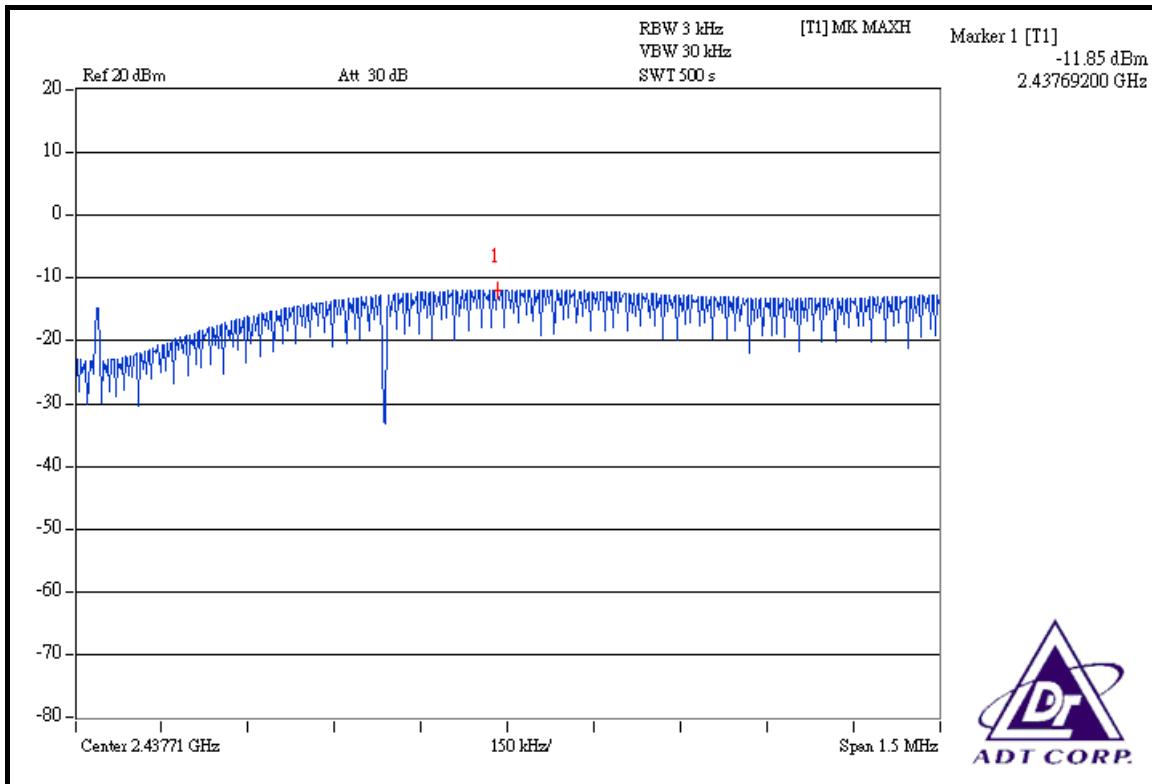

CH 11

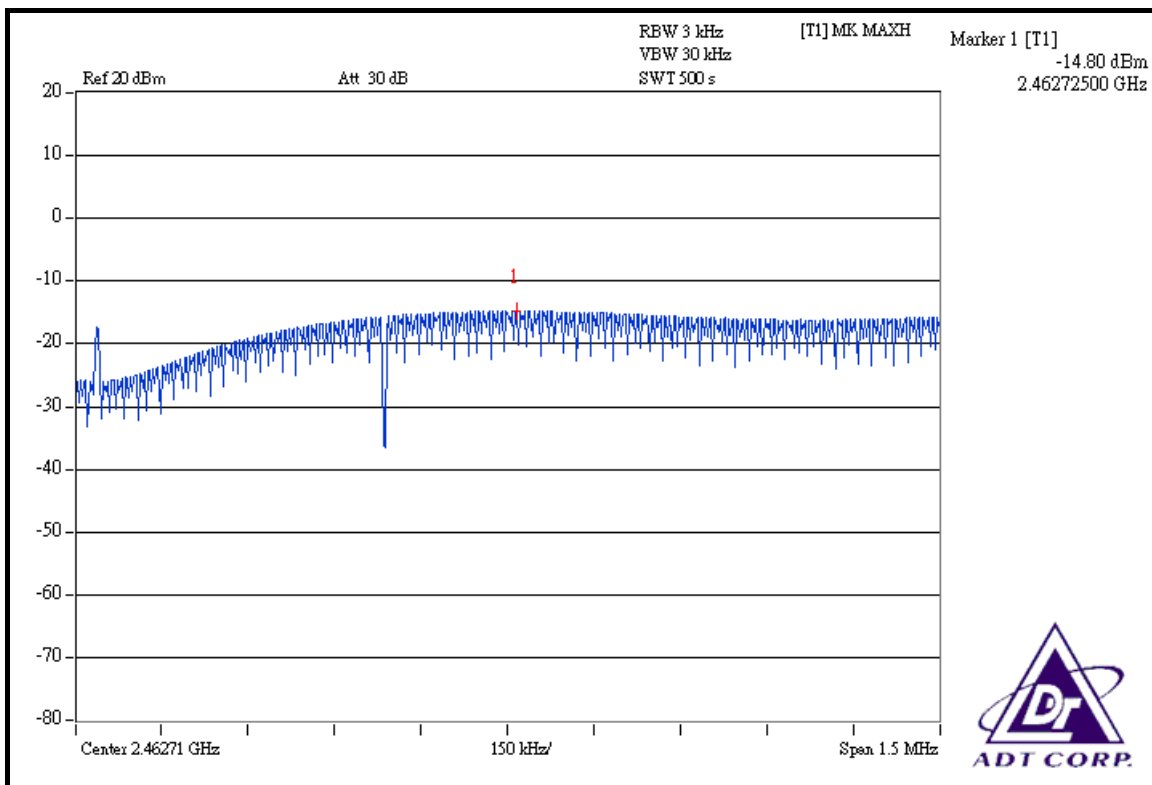



802.11g OFDM MODULATION

INPUT POWER (SYSTEM)	120Vac, 60 Hz	ENVIRONMENTAL CONDITIONS	25deg.C, 65% RH, 991hPa
TESTED BY	Brad Wu		

CHANNEL CHANNEL	CHANNEL FREQUENCY (MHz)	RF POWER LEVEL IN 3kHz BW (mW)		RF POWER LEVEL IN 3kHz BW (dBm)		TOTAL POWER DENSITY (mW)	TOTAL POWER DENSITY (dBm)	MAX. LIMIT (dBm)	PASS / FAIL
		CHAIN 0	CHAIN 1	CHAIN 0	CHAIN 1				
1	2412	0.011	0.012	-19.41	-19.12	0.023	-16.38	8	PASS
6	2437	0.016	0.016	-17.96	-17.86	0.032	-14.95	8	PASS
11	2462	0.016	0.017	-17.98	-17.71	0.033	-14.81	8	PASS



FOR CHAIN 0: CH 1

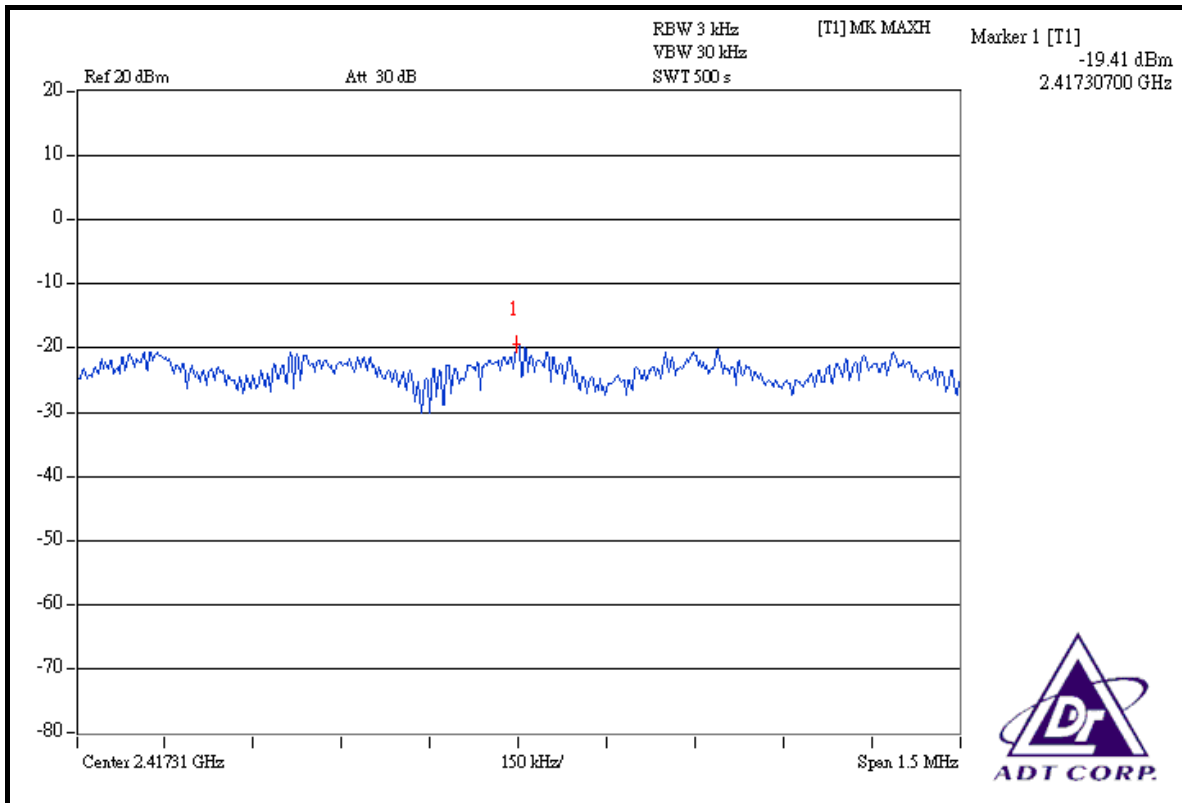

CH 6

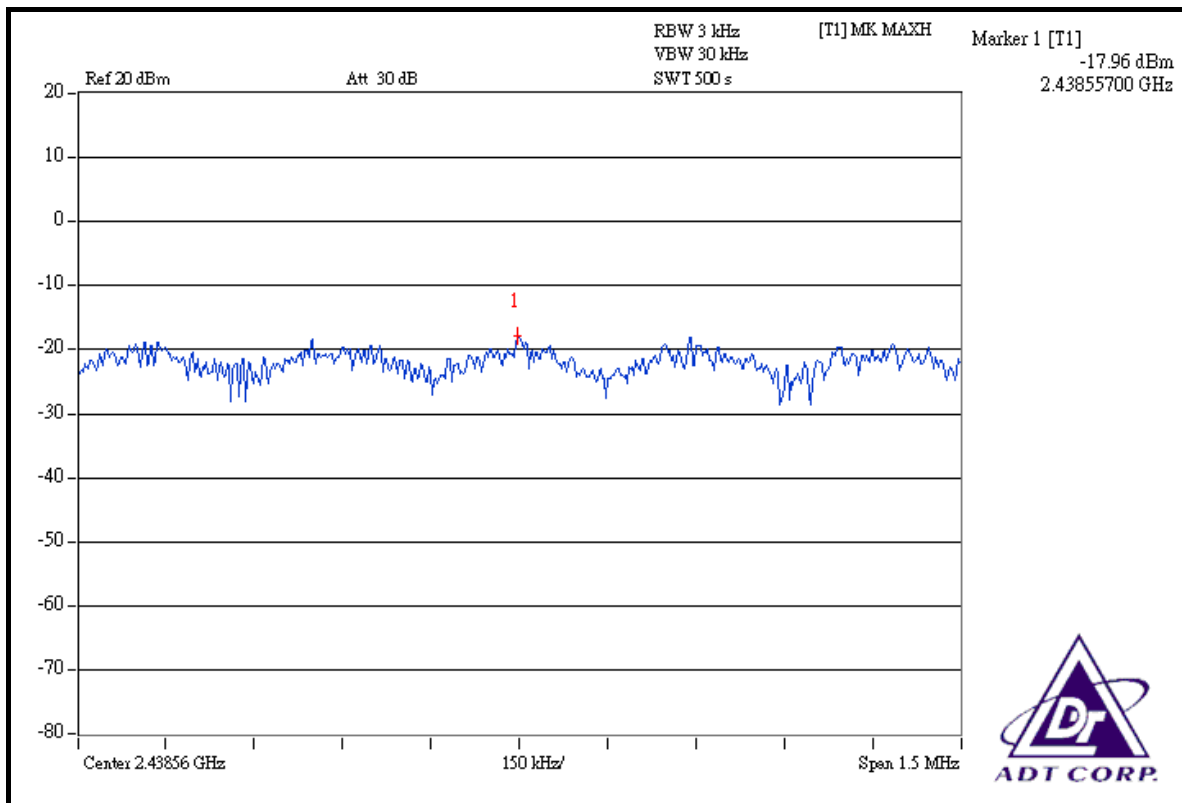



CH 11

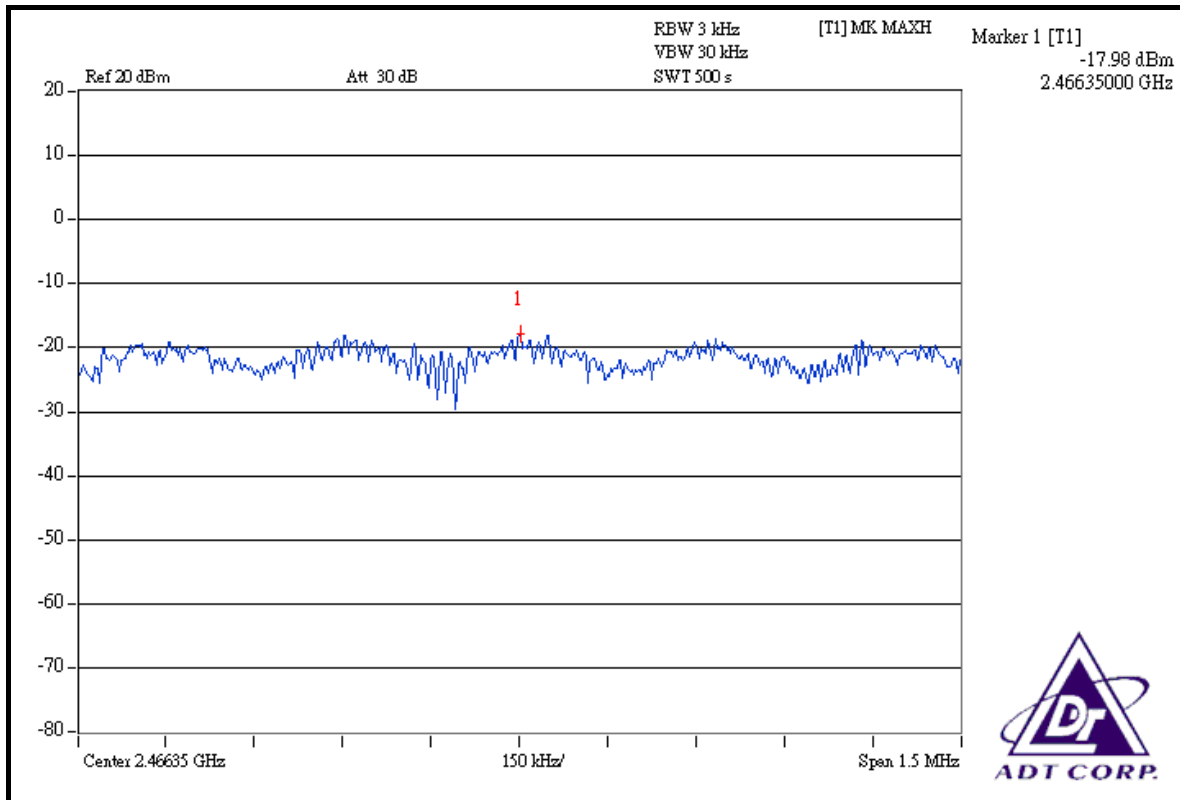

FOR CHAIN 1: CH 1

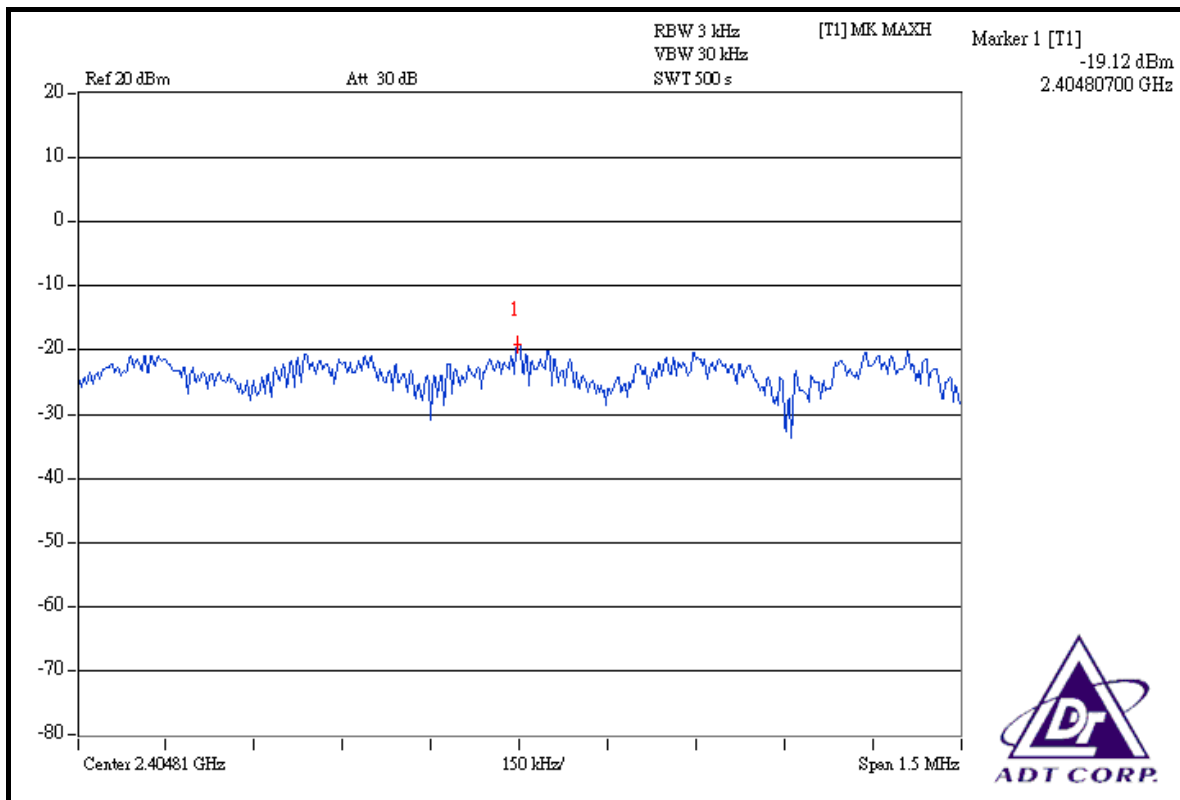



CH 6

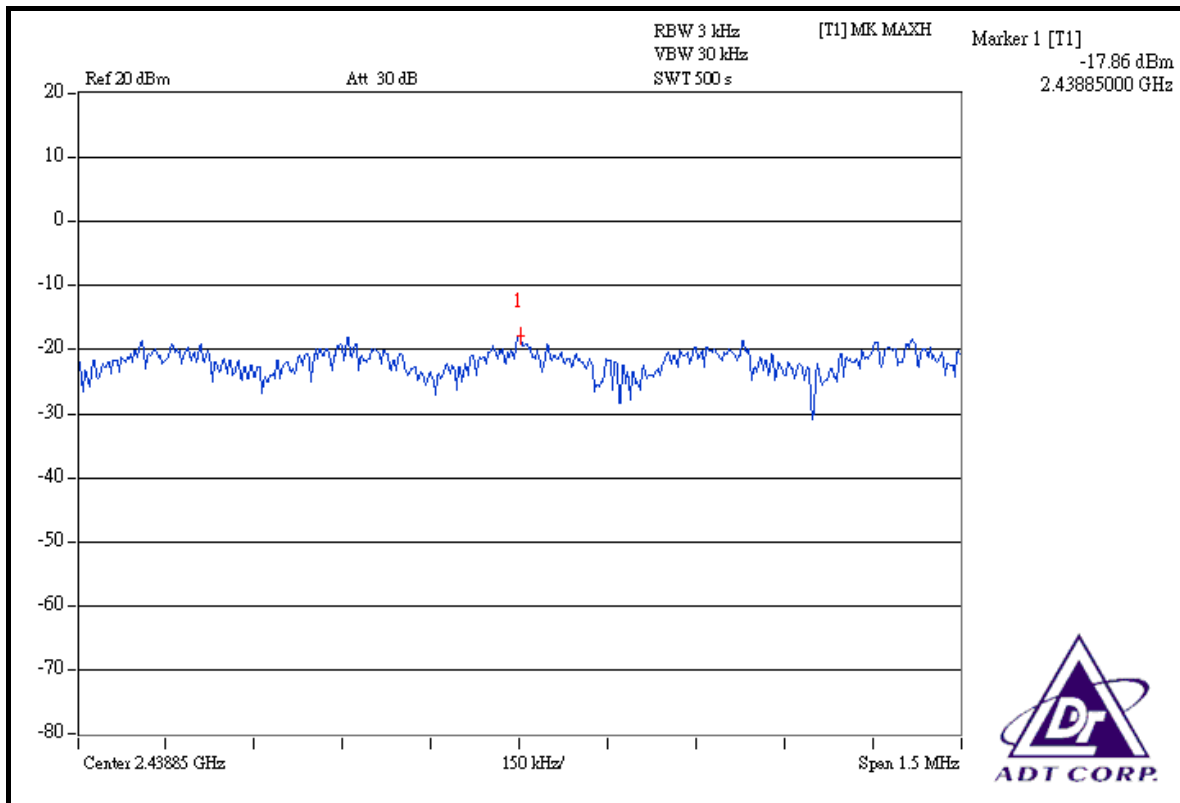

CH 11

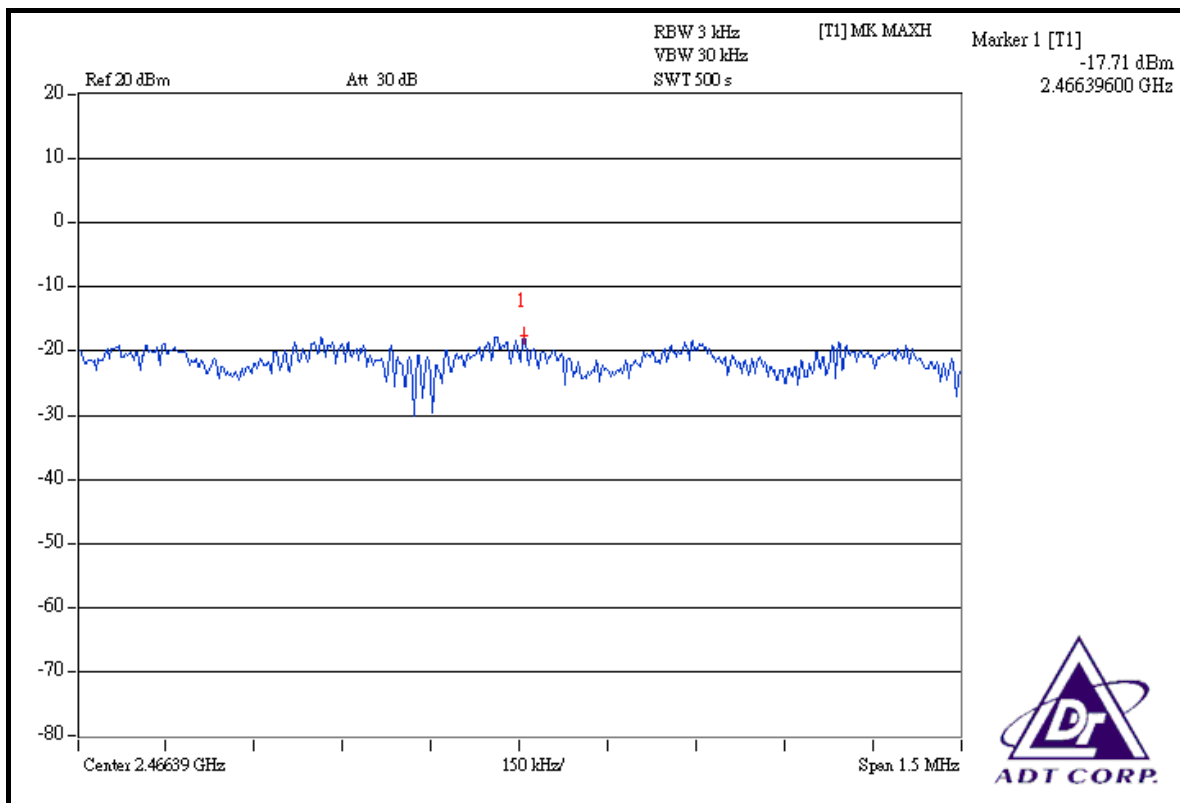



DRAFT 802.11n (20MHz) OFDM MODULATION

INPUT POWER (SYSTEM)	120Vac, 60 Hz	ENVIRONMENTAL CONDITIONS	25deg.C, 65% RH, 991hPa
TESTED BY	Brad Wu		

CHANNEL	CHANNEL FREQUENCY (MHz)	RF POWER LEVEL IN 3kHz BW (mW)		RF POWER LEVEL IN 3kHz BW (dBm)		TOTAL POWER DENSITY (mW)	TOTAL POWER DENSITY (dBm)	MAX. LIMIT (dBm)	PASS / FAIL
		CHAIN 0	CHAIN 1	CHAIN 0	CHAIN 1				
1	2412	0.007	0.008	-21.59	-21.18	0.015	-18.24	8	PASS
6	2437	0.007	0.008	-21.40	-21.12	0.015	-18.24	8	PASS
11	2462	0.007	0.008	-21.63	-21.03	0.015	-18.24	8	PASS



FOR CHAIN 0: CH 1

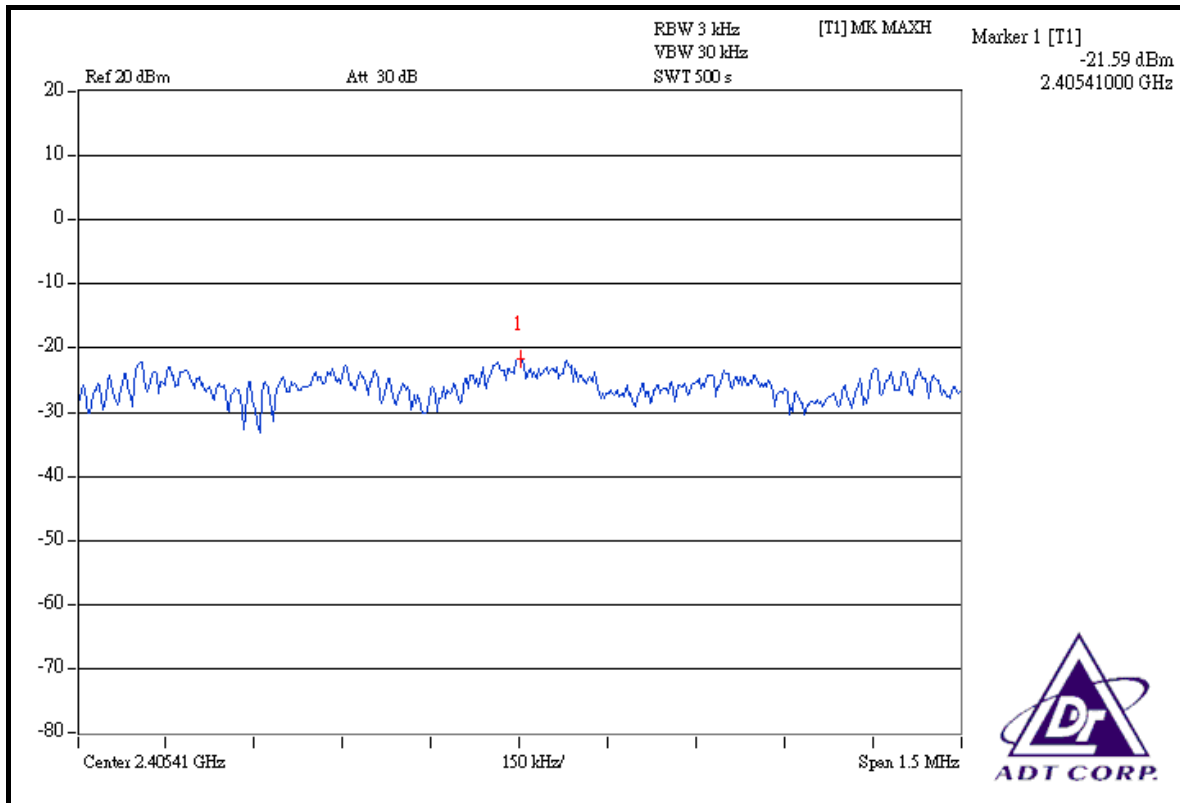

CH 6

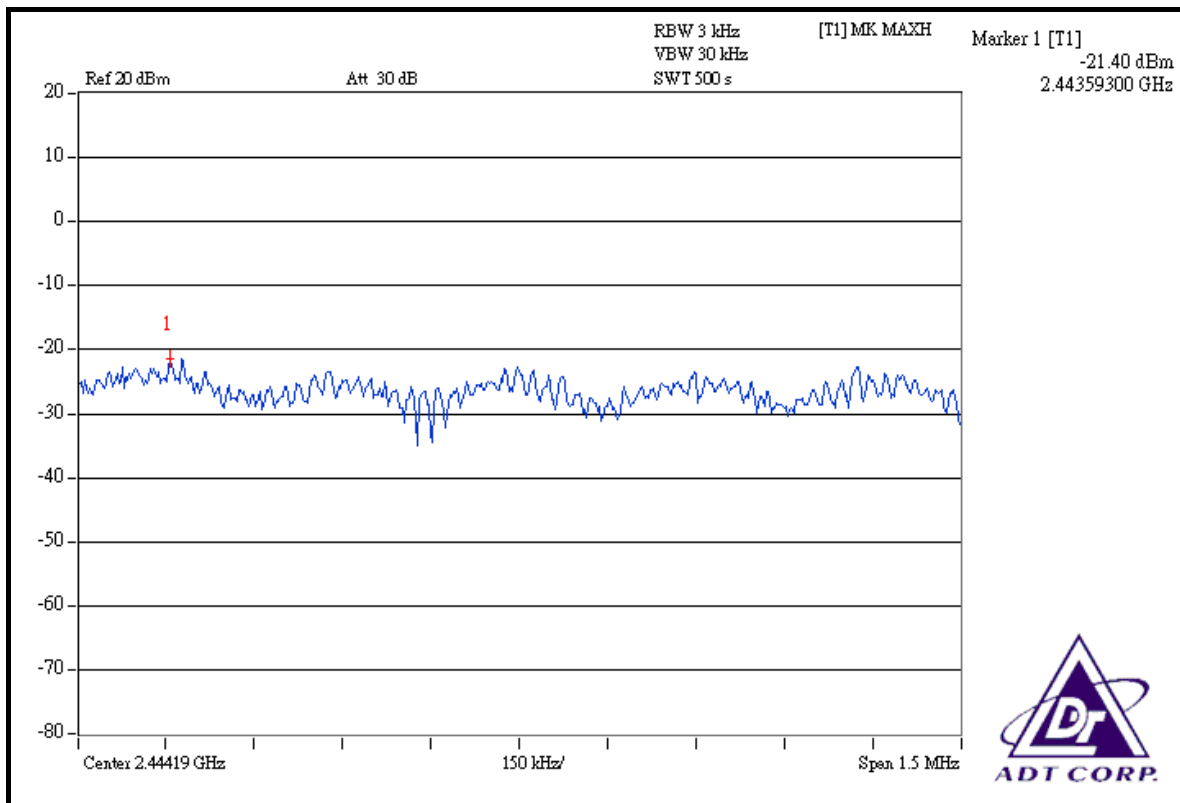



CH 11

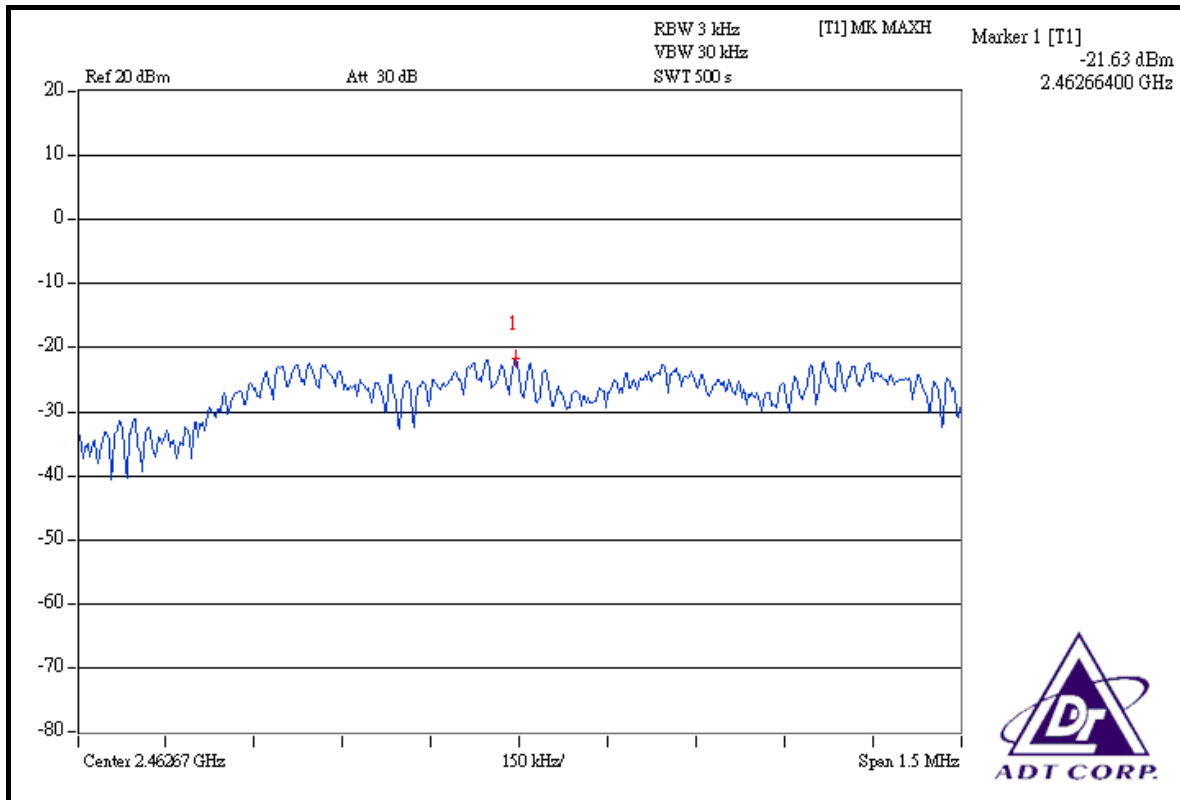

FOR CHAIN 1: CH 1

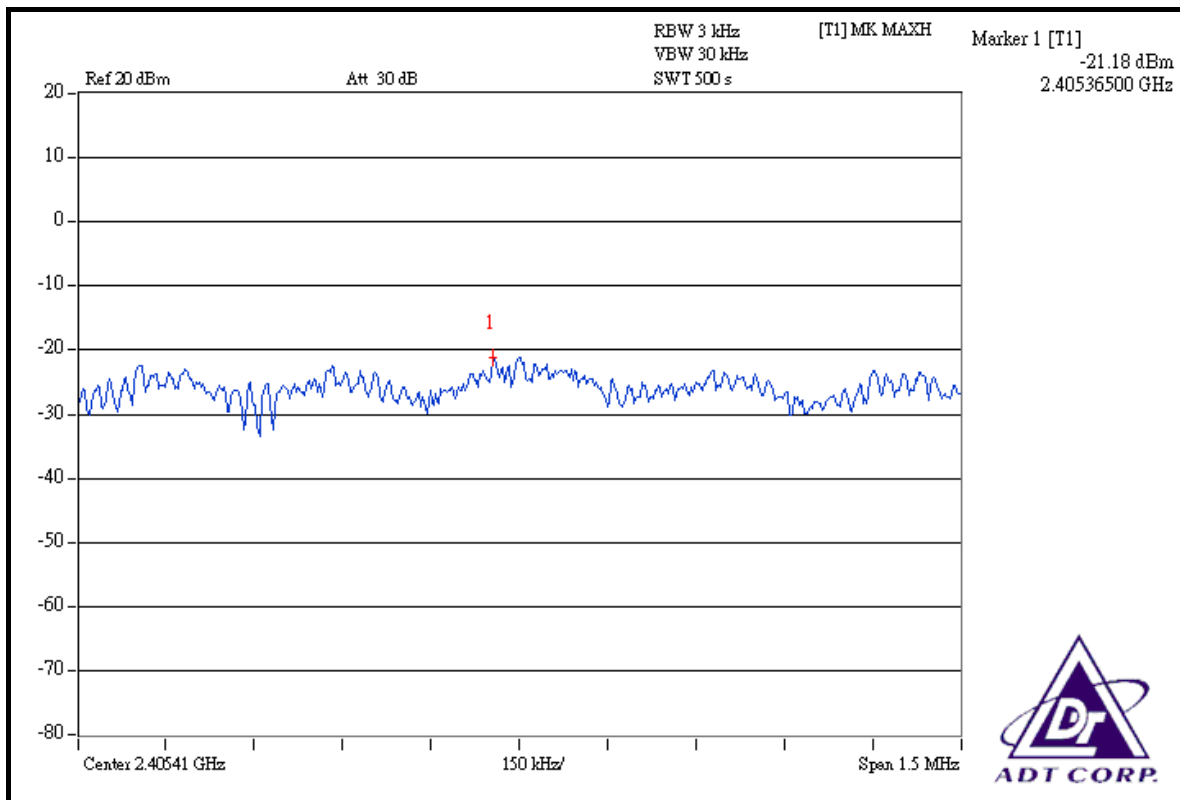



CH 6

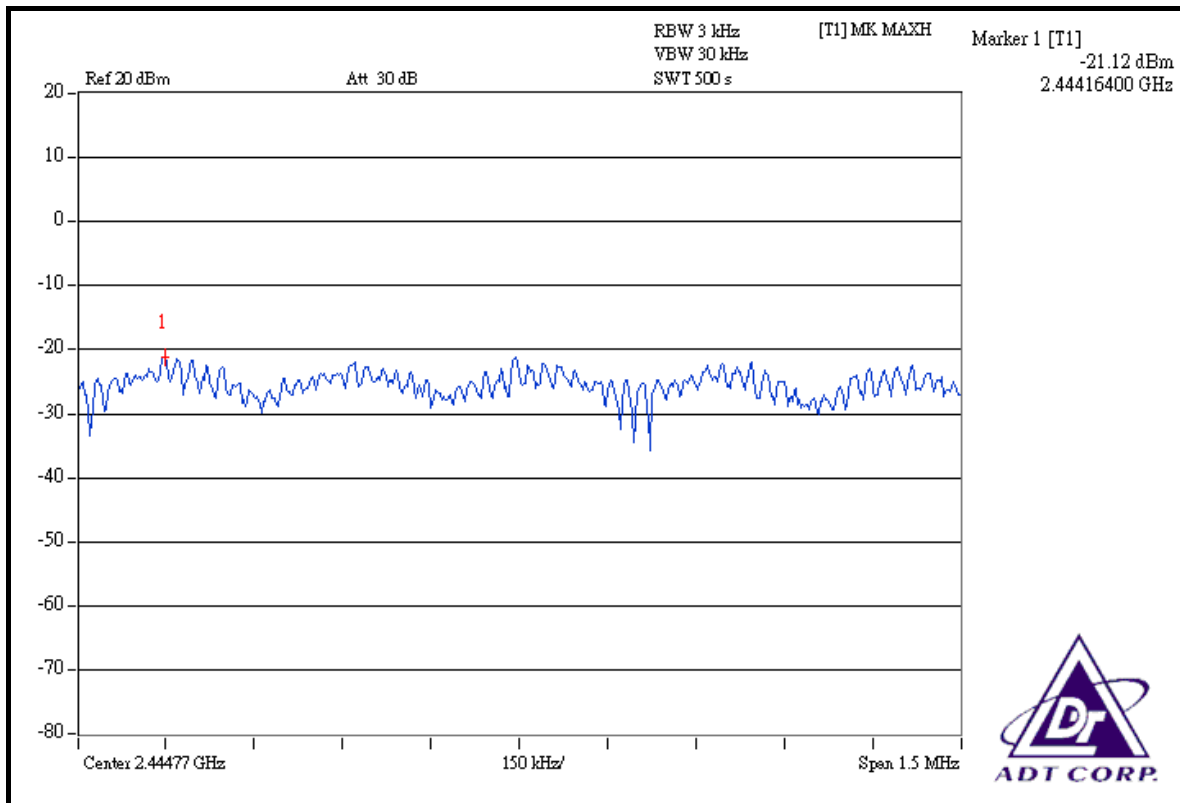

CH 11

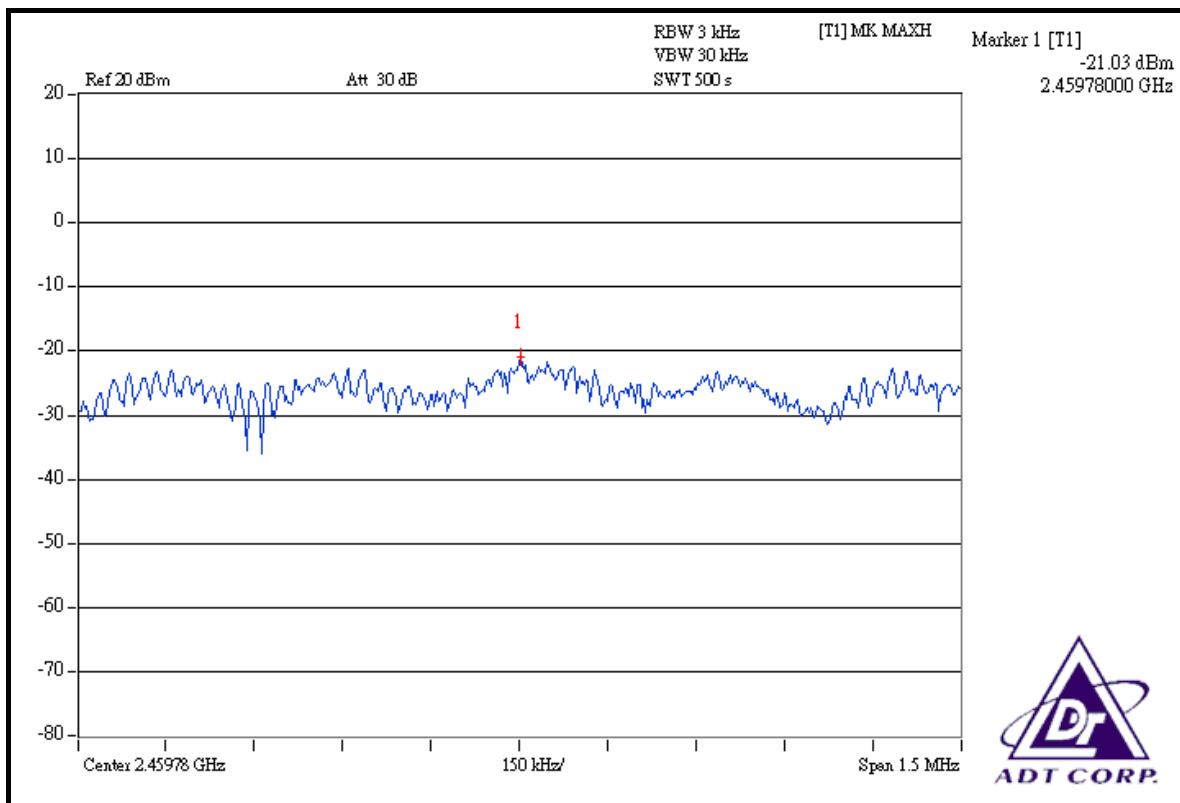



DRAFT 802.11n (40MHz) OFDM MODULATION

INPUT POWER (SYSTEM)	120Vac, 60 Hz	ENVIRONMENTAL CONDITIONS	25deg.C, 65% RH, 991hPa
TESTED BY	Brad Wu		

CHANNEL CHANNEL	CHANNEL FREQUENCY (MHz)	RF POWER LEVEL IN 3kHz BW (mW)		RF POWER LEVEL IN 3kHz BW (dBm)		TOTAL POWER DENSITY (mW)	TOTAL POWER DENSITY (dBm)	MAX. LIMIT (dBm)	PASS / FAIL
		CHAIN 0	CHAIN 1	CHAIN 0	CHAIN 1				
1	2422	0.006	0.007	-22.21	-21.38	0.013	-18.86	8	PASS
4	2437	0.006	0.007	-22.05	-21.54	0.013	-18.86	8	PASS
7	2452	0.006	0.007	-22.04	-21.37	0.013	-18.86	8	PASS



FOR CHAIN 0: CH 1

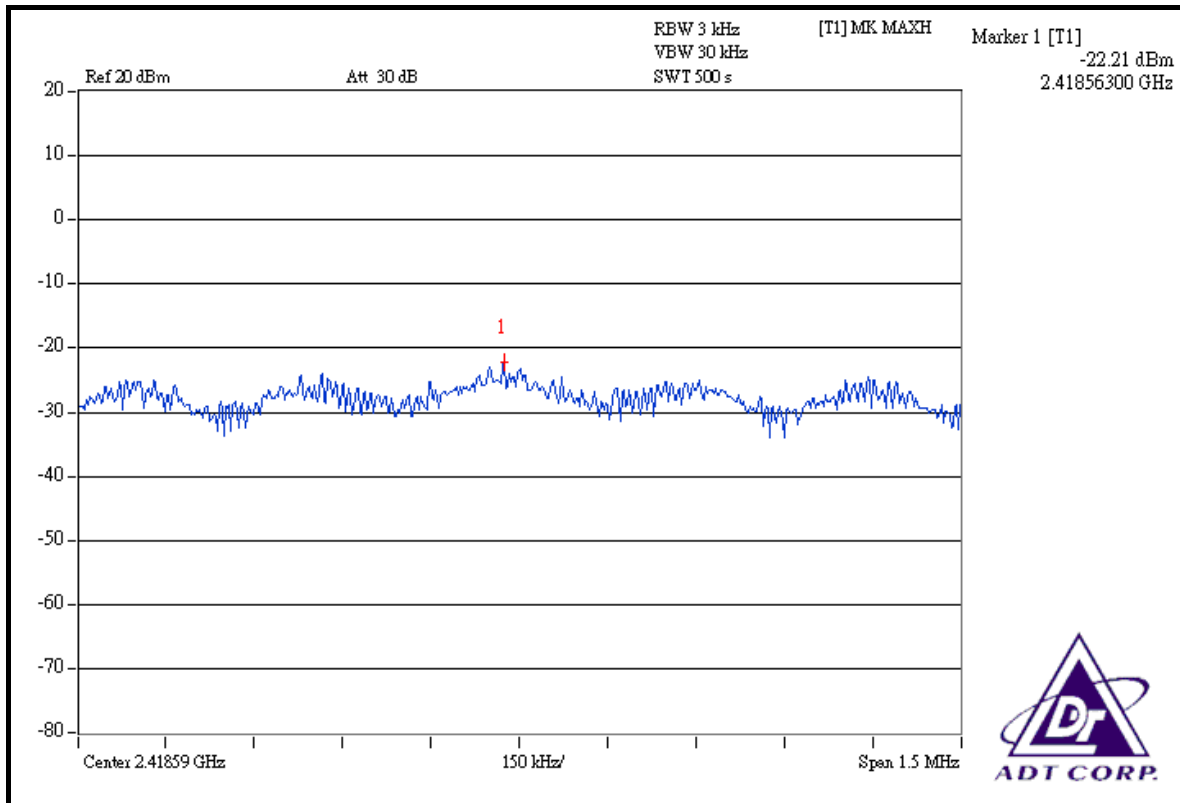

CH 4

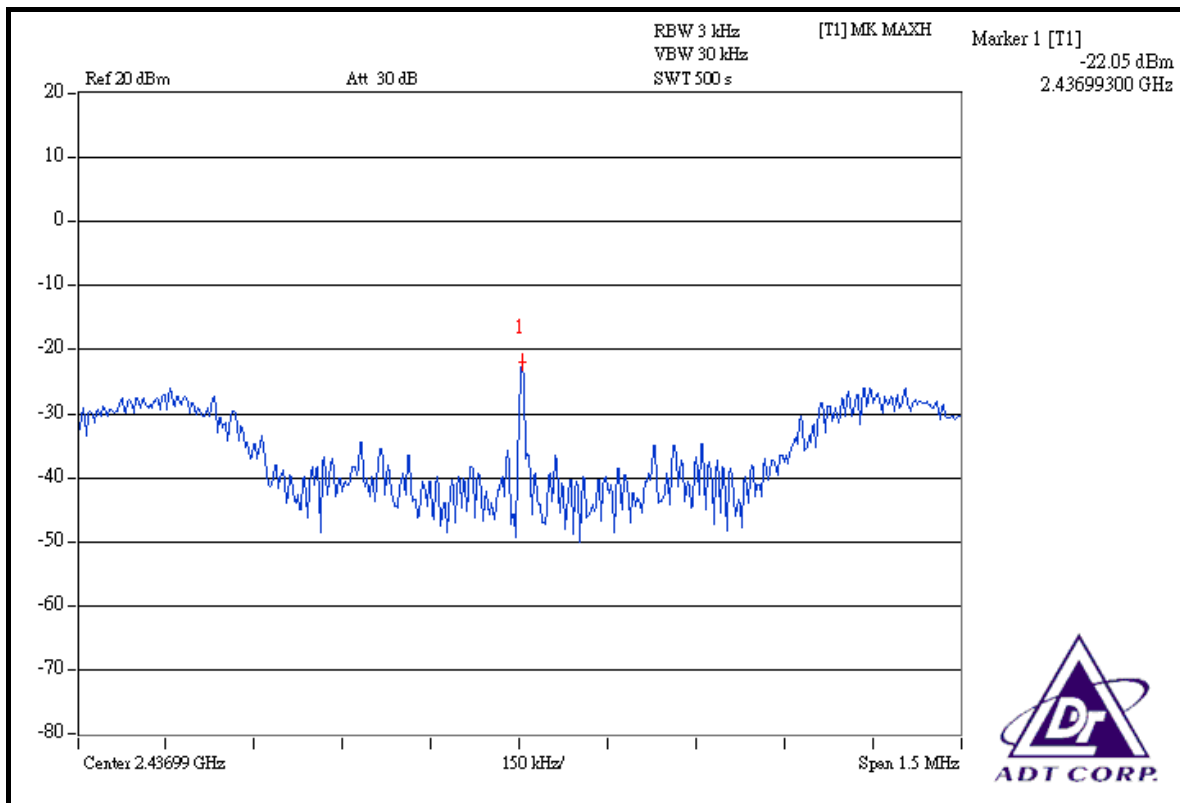



CH 7

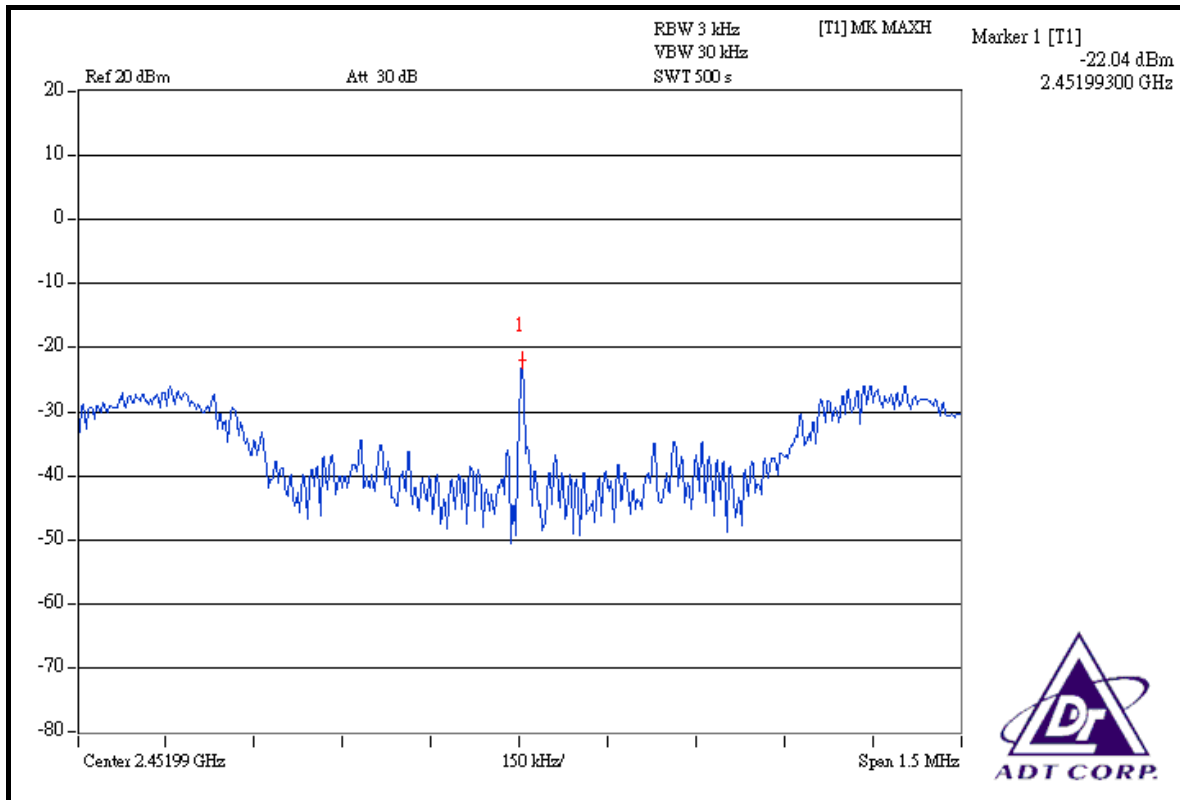

FOR CHAIN 1: CH 1

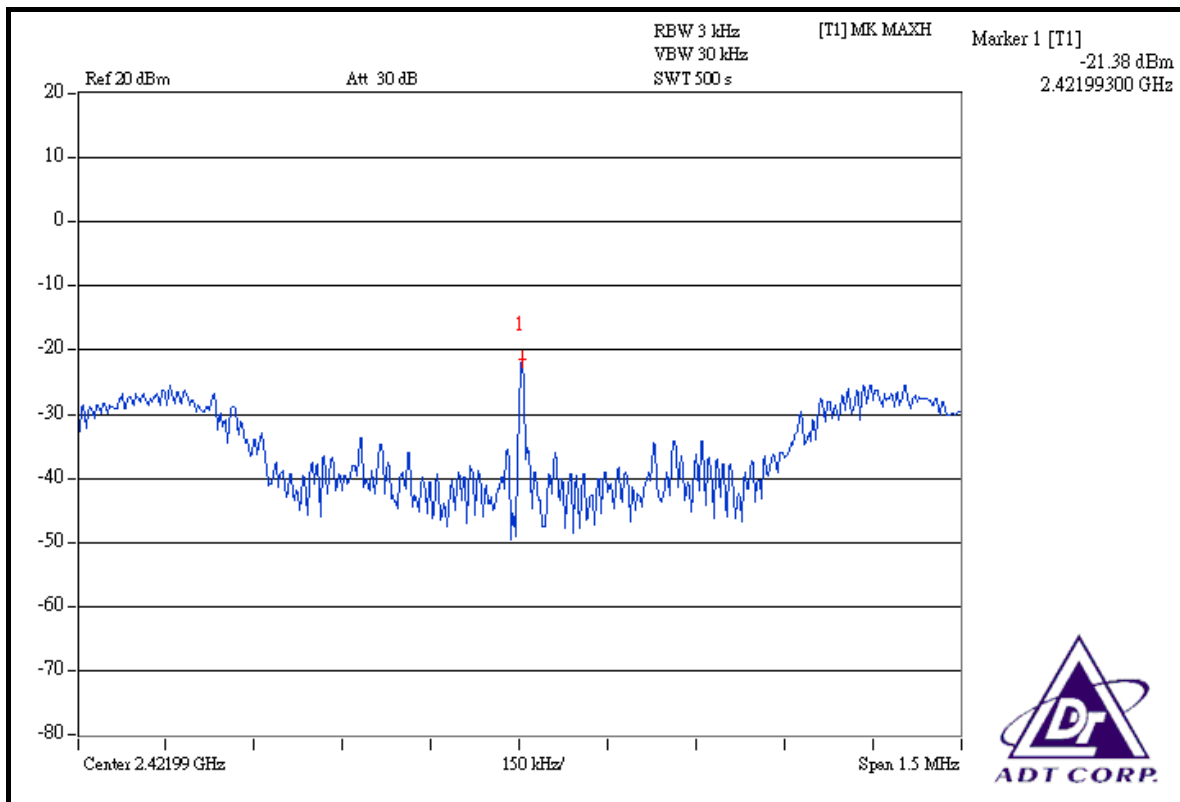



CH 4

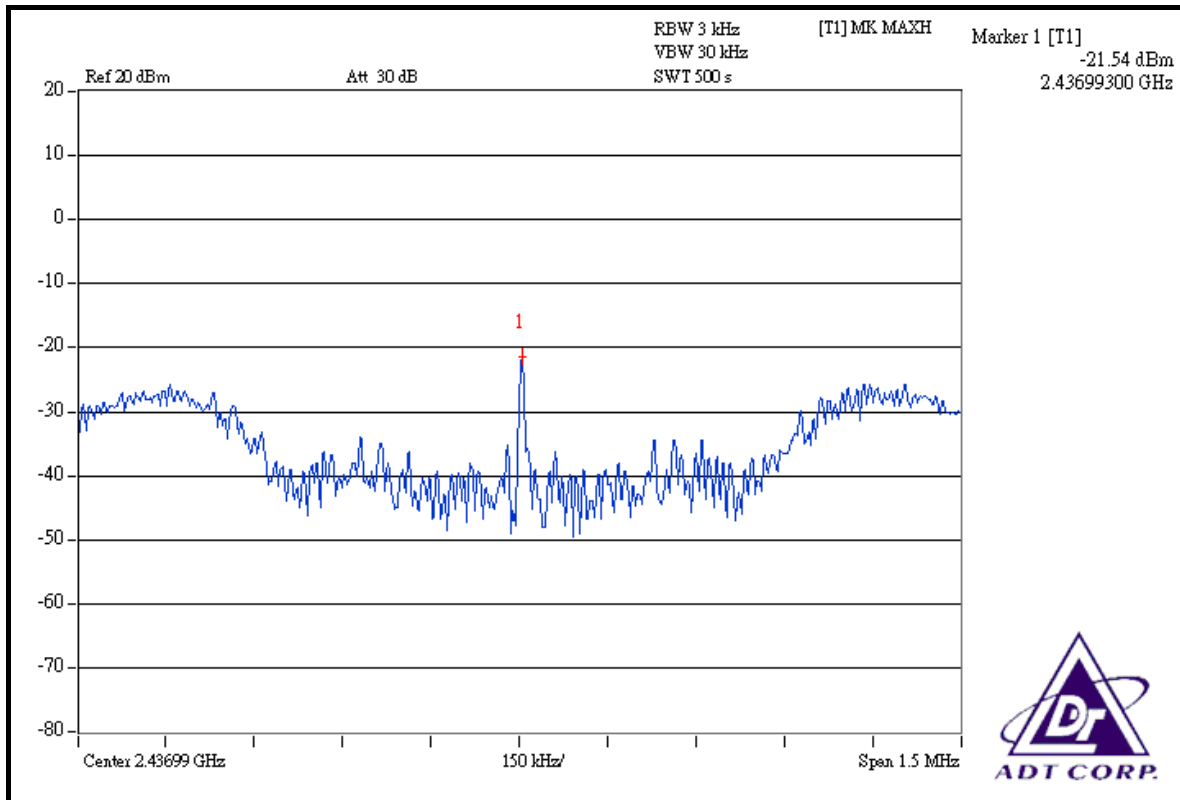

CH 7

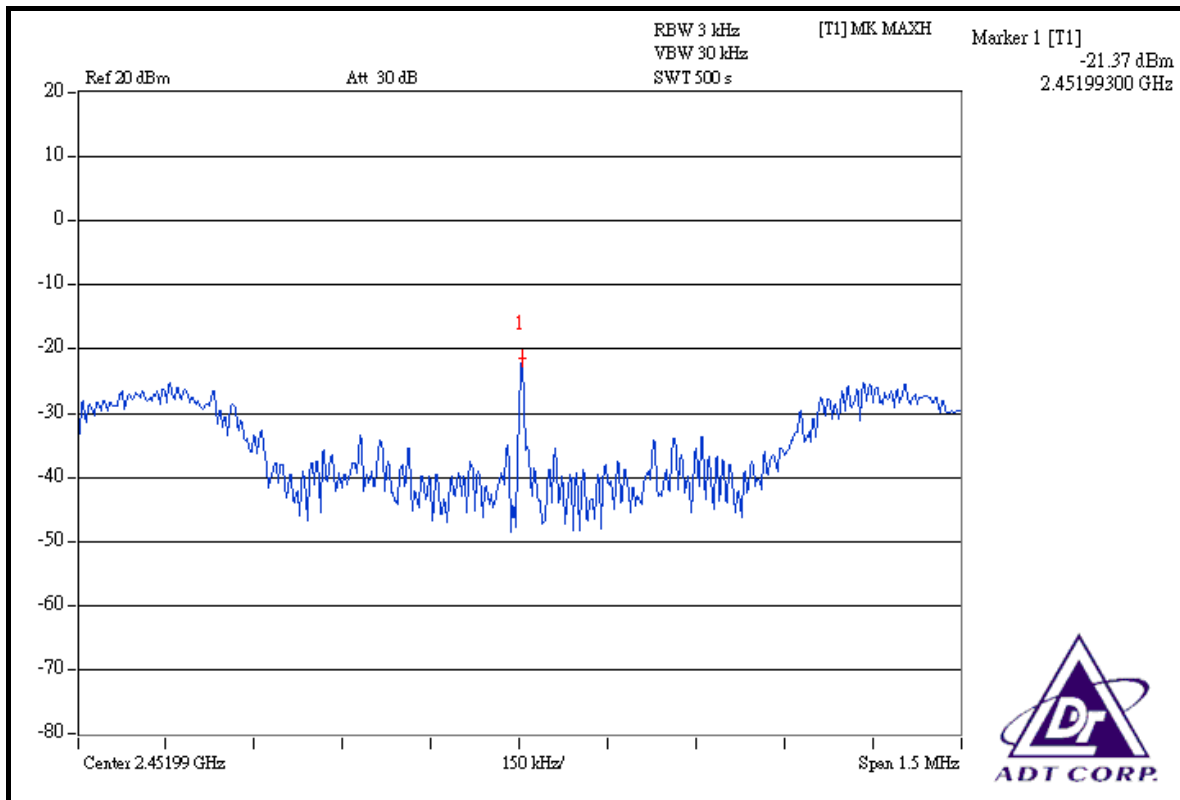



4.6 BAND EDGES MEASUREMENT

4.6.1 LIMITS OF BAND EDGES MEASUREMENT

Below -20dB of the highest emission level of operating band (in 100kHz Resolution Bandwidth).

4.6.2 TEST INSTRUMENTS

For Single TX:

DESCRIPTION & MANUFACTURER	MODEL NO.	SERIAL NO.	CALIBRATED UNTIL
R&S SPECTRUM ANALYZER	FSP40	100040	Jun. 28, 2008

NOTE: The calibration interval of the above test instruments is 12 months and the calibrations are traceable to NML/ROC and NIST/USA.

For Dual TX:

DESCRIPTION & MANUFACTURER	MODEL NO.	SERIAL NO.	CALIBRATED UNTIL
Spectrum Analyzer ROHDE & SCHWARZ	FSP40	100269	Aug. 05, 2008
BILOG Antenna SCHWARZBECK	VULB9168	9168-153	Jan. 03, 2009
HORN Antenna SCHWARZBECK	BBHA 9120 D	9120D-563	Jul. 30, 2008
HORN Antenna SCHWARZBECK	BBHA 9170	BBHA9170242	Jan. 16, 2008
RF signal cable HUBER+SUHNNER	SUCOFLEX 104	274039/223650	Nov. 07, 2008
RF signal cable Worken	8D-FB	Cable-HYCH9-01	Aug. 09, 2008
Software	ADT_Radiated_V7.6	NA	NA
Antenna Tower EMCO	2070/2080	512.835.4684	NA
Turn Table EMCO	2087-2.03	NA	NA
Antenna Tower & Turn Table Controller EMCO	2090	NA	NA

NOTE: The calibration interval of the above test instruments is 12 months and the calibrations are traceable to NML/ROC and NIST/USA.

4.6.3 TEST PROCEDURE

For Single TX:

The transmitter output was connected to the spectrum analyzer via a low lose cable. Set both RBW and VBW of spectrum analyzer to 100kHz with suitable frequency span including 10Hz bandwidth from band edge. The band edges was measured and recorded.

The spectrum plots (Peak RBW = 100 kHz, VBW = 300kHz; Average RBW = 1MHz, VBW = 10Hz) are attached on the following pages.

For Dual TX:

- a. The EUT was placed on the top of a rotating table 0.8 meters above the ground at a 3 meter semi-anechoic chamber. The table was rotated 360 degrees to determine the position of the highest radiation.
- b. The EUT was set 3 meters away from the interference-receiving antenna, which was mounted on the top of a variable-height antenna tower.
- c. The antenna is a broadband antenna, and its height is varied from one meter to four meters above the ground to determine the maximum value of the field strength. Both horizontal and vertical polarizations of the antenna are set to make the measurement.
- d. For each suspected emission, the EUT was arranged to its worst case and then the antenna was tuned to heights from 1 meter to 4 meters and the rotatable table was turned from 0 degrees to 360 degrees to find the maximum reading.
- e. Set both RBW and VBW of spectrum analyzer to 100kHz with suitable frequency span including 100MHz bandwidth from band edge. The band edges was measured and recorded.

The spectrum plots (Peak RBW = 100kHz, VBW = 300kHz; Average RBW = 1MHz, VBW = 10Hz)

4.6.4 DEVIATION FROM TEST STANDARD

No deviation

4.6.5 EUT OPERATING CONDITION

Same as Item 4.3.6

4.6.6 TEST RESULTS

The spectrum plots are attached on the following 24 images. D1 line indicates the highest level, and D2 line indicates the 20dB offset below D1. It shows compliance with the requirement in part 15.247(d).

802.11b DSSS MODULATION

NOTE 1:

The band edge emission plot on the next page shows 48.76dBc between carrier maximum power and local maximum emission in restrict band (2.38640GHz). The emission of carrier strength list in the test result of channel 1 at the item 4.2.7 is 109.03dBuV/m (Peak), so the maximum field strength in restrict band is $109.03 - 48.76 = 60.27$ dBuV/m which is under 74dBuV/m limit.

The band edge emission plot on the next page shows 52.83dBc between carrier maximum power and local maximum emission in restrict band (2.38640GHz). The emission of carrier strength list in the test result of channel 1 at the item 4.2.7 is 104.74dBuV/m (Average), so the maximum field strength in restrict band is $104.74 - 52.83 = 51.91$ dBuV/m which is under 54dBuV/m limit.

NOTE 2:

The band edge emission plot on the next second page shows 49.45dBc between carrier maximum power and local maximum emission in restrict band (2.48800GHz). The emission of carrier strength list in the test result of channel 11 at the item 4.2.7 is 109.91dBuV/m (Peak), so the maximum field strength in restrict band is $109.91 - 49.45 = 60.46$ dBuV/m which is under 74dBuV/m limit.

The band edge emission plot on the next third page shows 53.03dBc between carrier maximum power and local maximum emission in restrict band (2.48780GHz). The emission of carrier strength list in the test result of channel 11 at the item 4.2.7 is 105.85dBuV/m (Average), so the maximum field strength in restrict band is $105.85 - 53.03 = 52.82$ dBuV/m which is under 54dBuV/m limit.

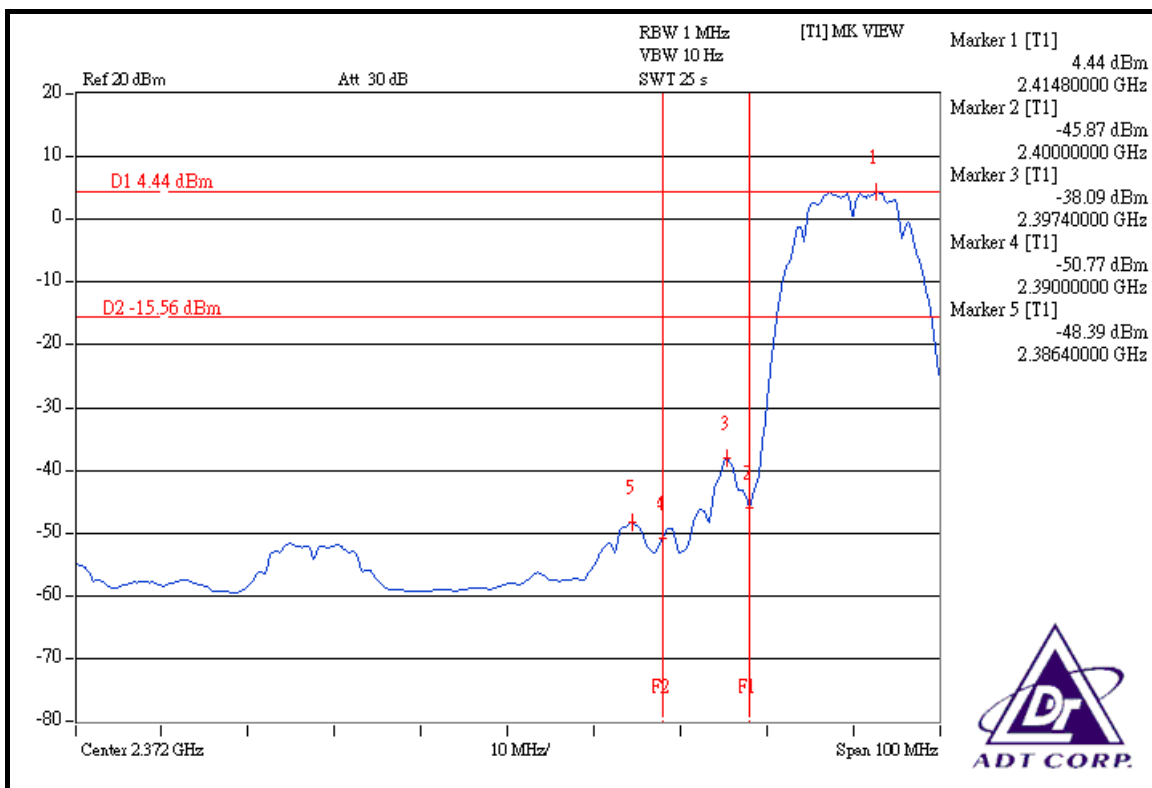
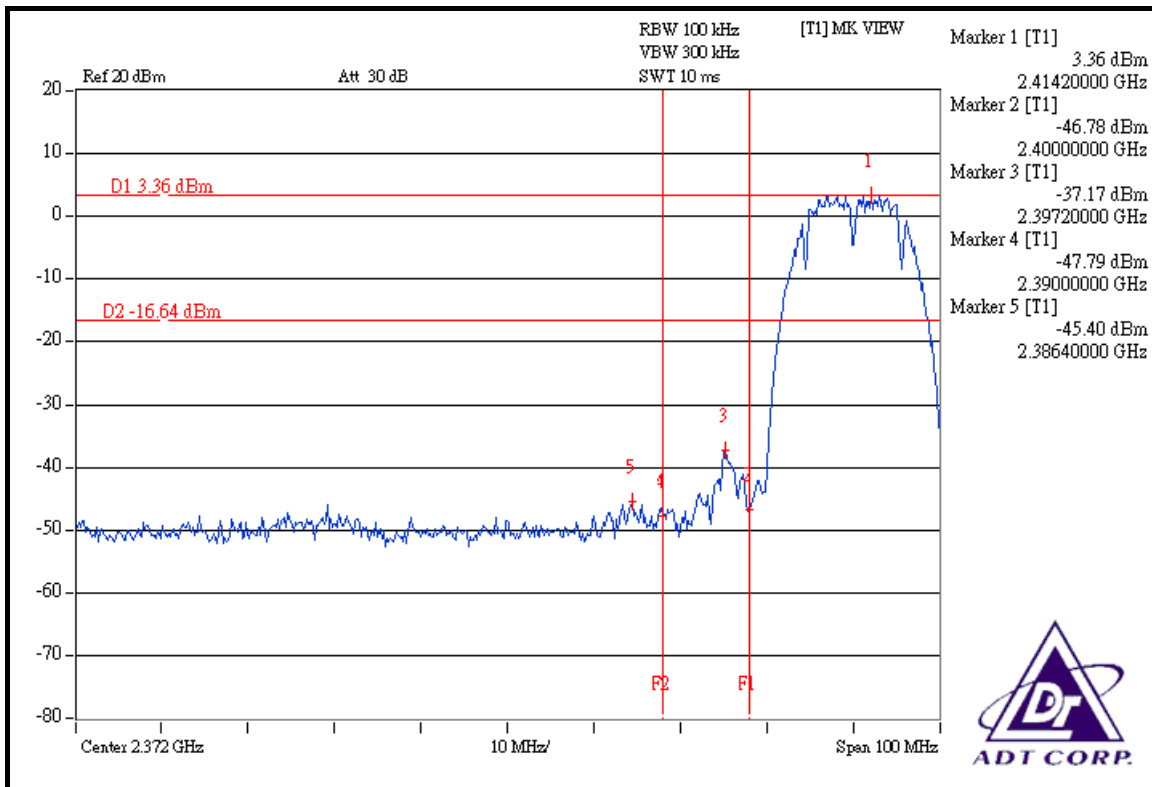

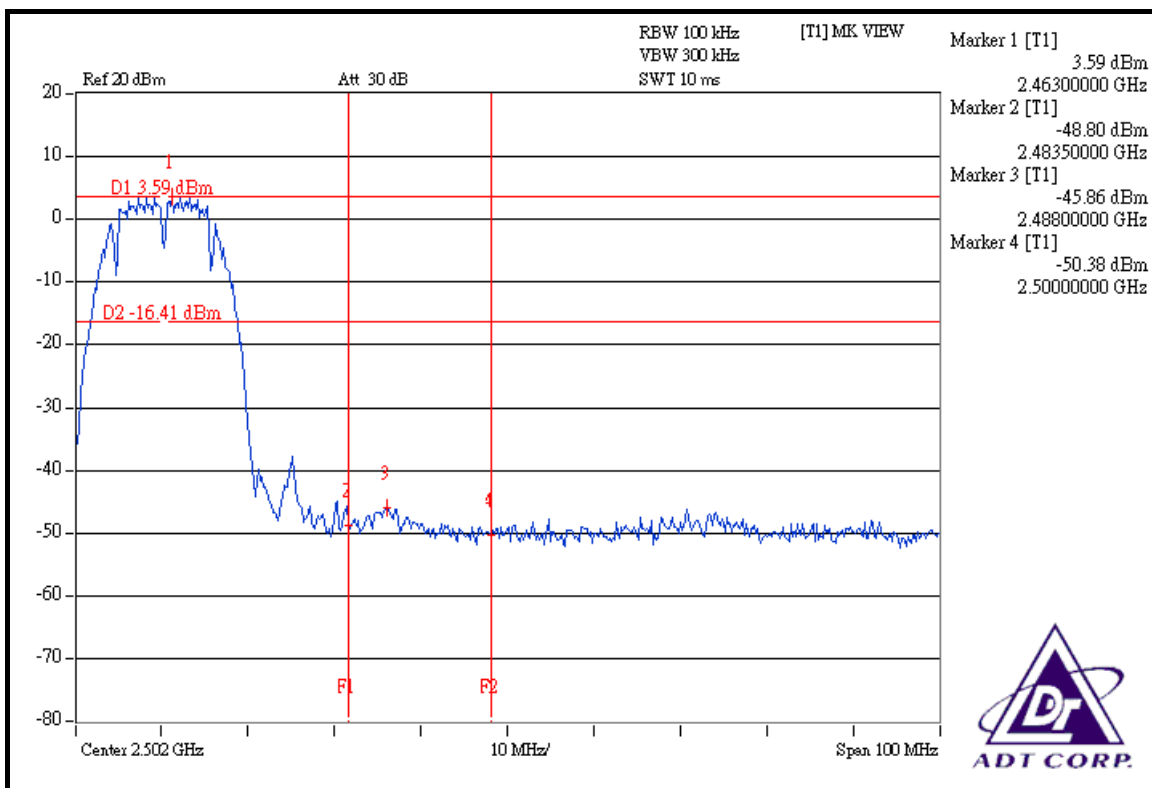
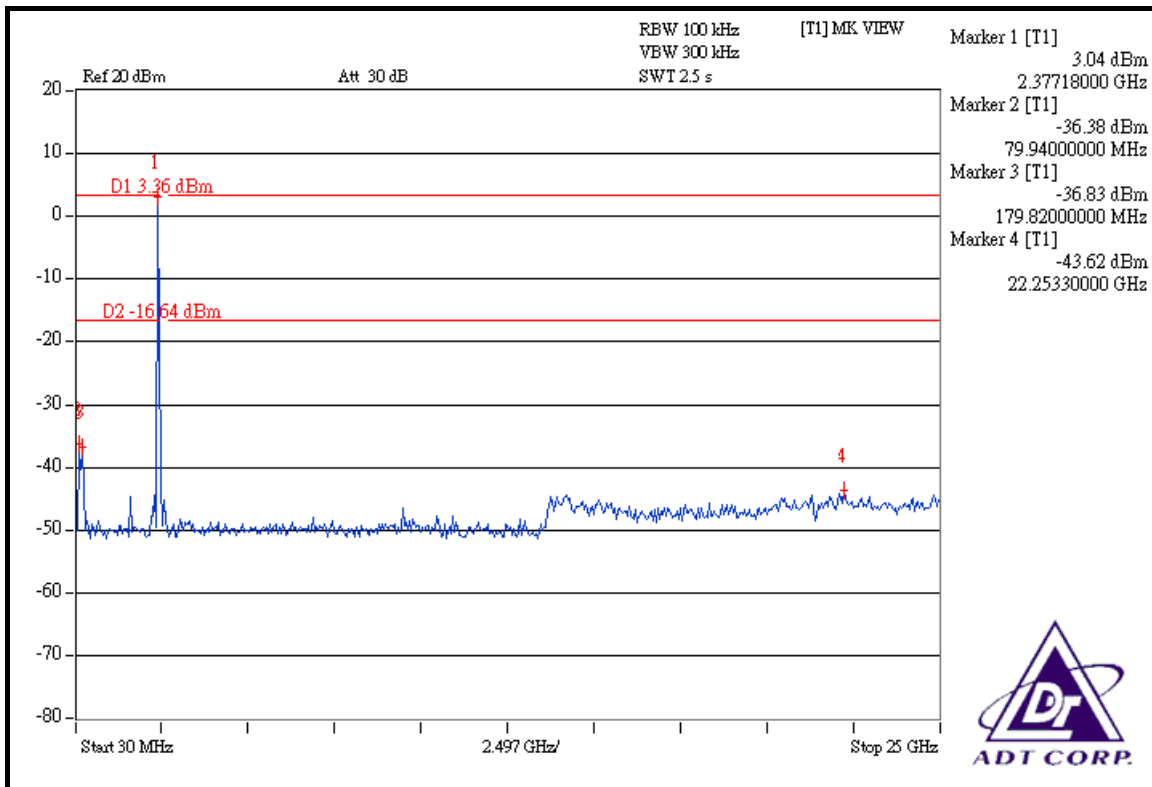

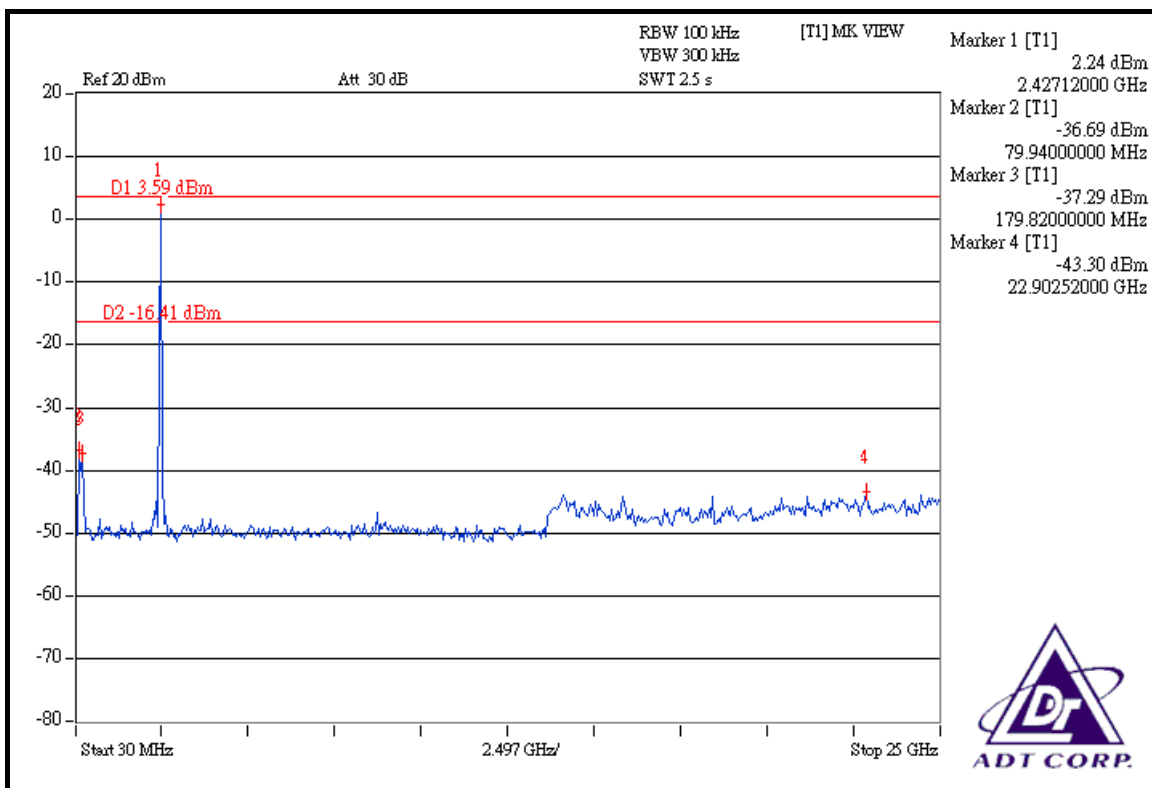
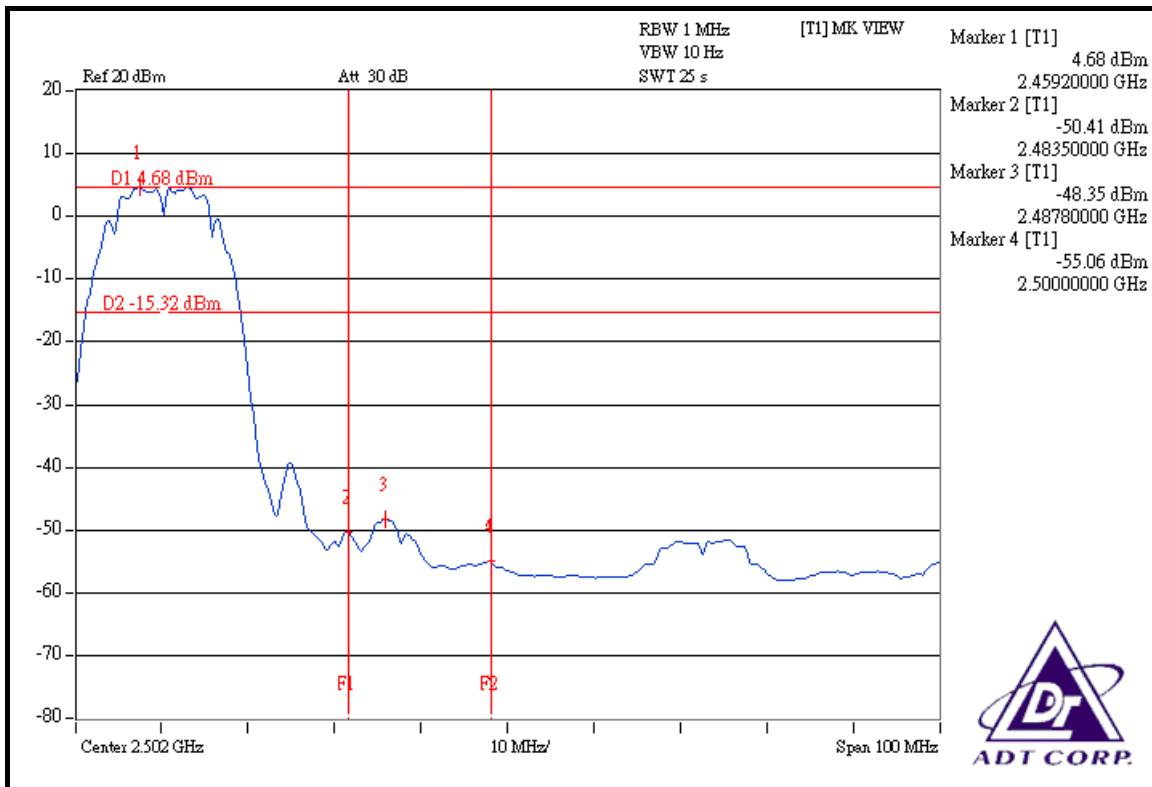

802.11g OFDM MODULATION

NOTE 1:

The band edge emission plot on the next page shows 43.21dBc between carrier maximum power and local maximum emission in restrict band (2.38560GHz). The emission of carrier strength list in the test result of channel 1 at the item 4.2.7 is 110.90dBuV/m (Peak), so the maximum field strength in restrict band is $110.90 - 43.21 = 67.69$ dBuV/m which is under 74dBuV/m limit.

The band edge emission plot on the next page shows 53.17dBc between carrier maximum power and local maximum emission in restrict band (2.39000GHz). The emission of carrier strength list in the test result of channel 1 at the item 4.2.7 is 100.73dBuV/m (Average), so the maximum field strength in restrict band is $100.73 - 53.17 = 47.56$ dBuV/m which is under 54dBuV/m limit.

NOTE 2:

The band edge emission plot on the next second page shows 43.85dBc between carrier maximum power and local maximum emission in restrict band (2.48380GHz). The emission of carrier strength list in the test result of channel 11 at the item 4.2.7 is 112.86dBuV/m (Peak), so the maximum field strength in restrict band is $112.86 - 43.85 = 69.01$ dBuV/m which is under 74dBuV/m limit.

The band edge emission plot on the next third page shows 51.08dBc between carrier maximum power and local maximum emission in restrict band (2.48350GHz). The emission of carrier strength list in the test result of channel 11 at the item 4.2.7 is 102.83dBuV/m (Average), so the maximum field strength in restrict band is $102.83 - 51.08 = 51.75$ dBuV/m which is under 54dBuV/m limit.

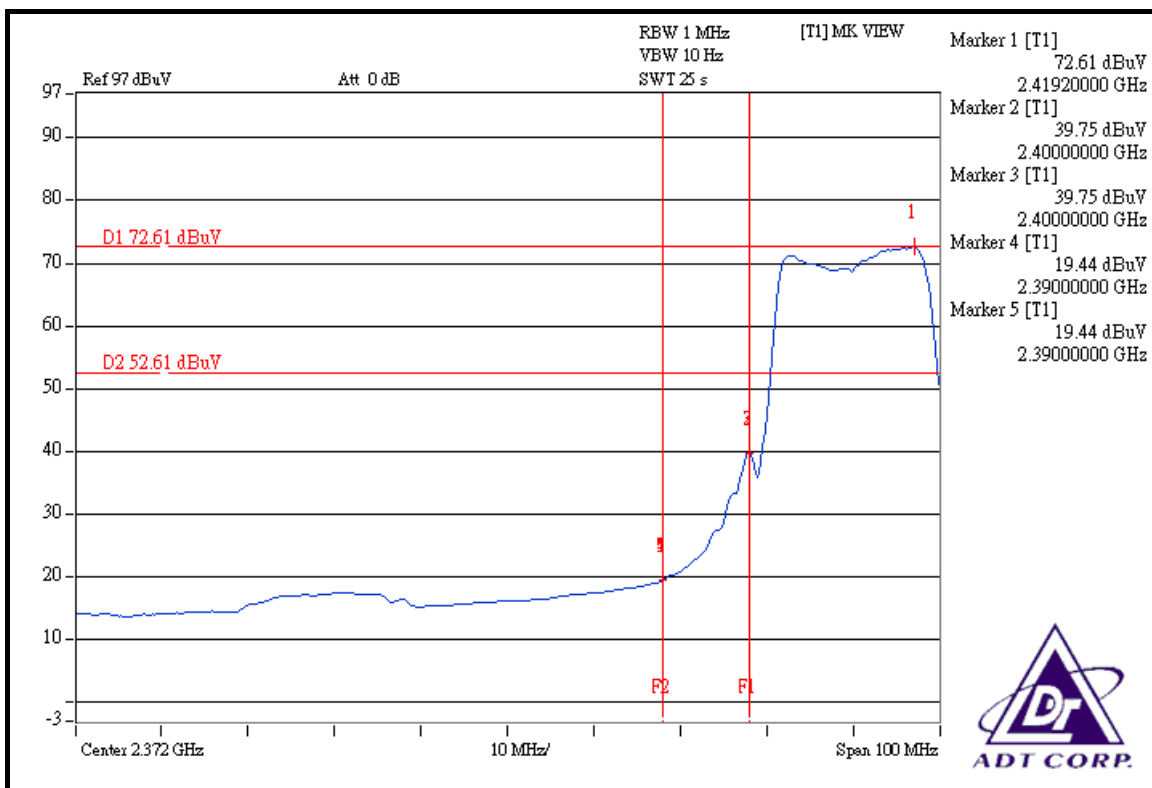
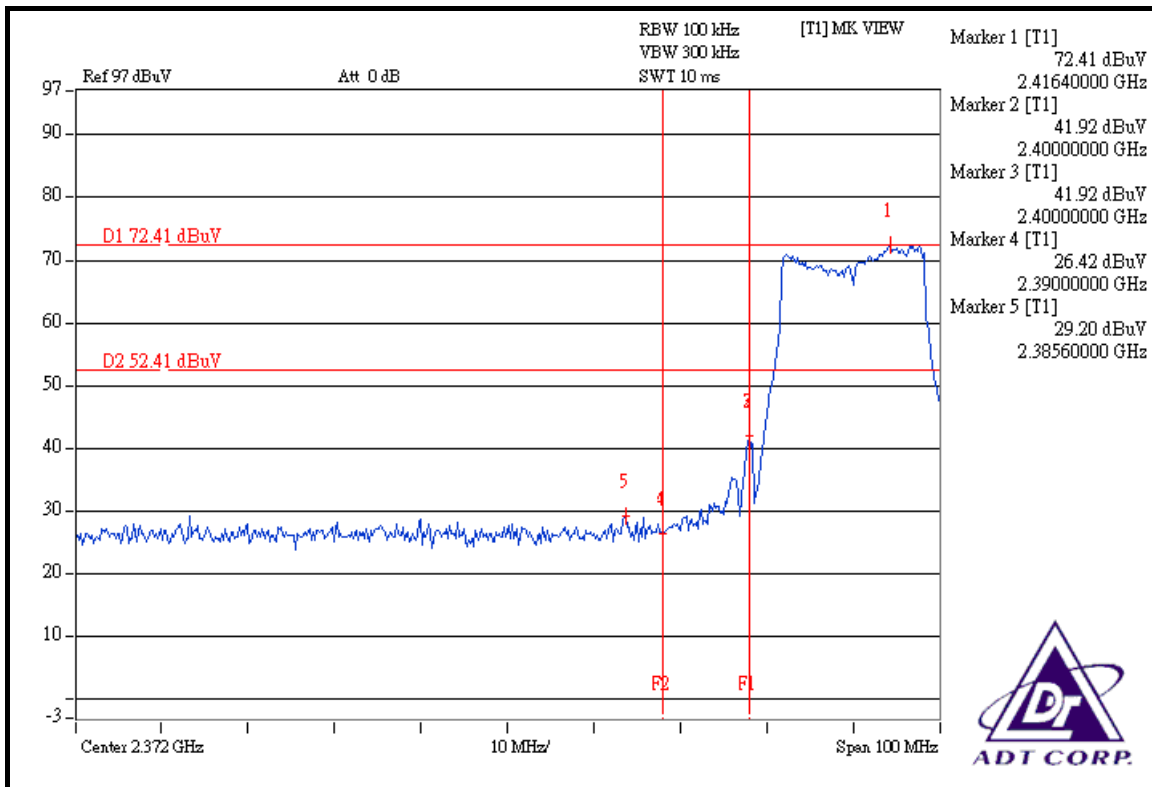

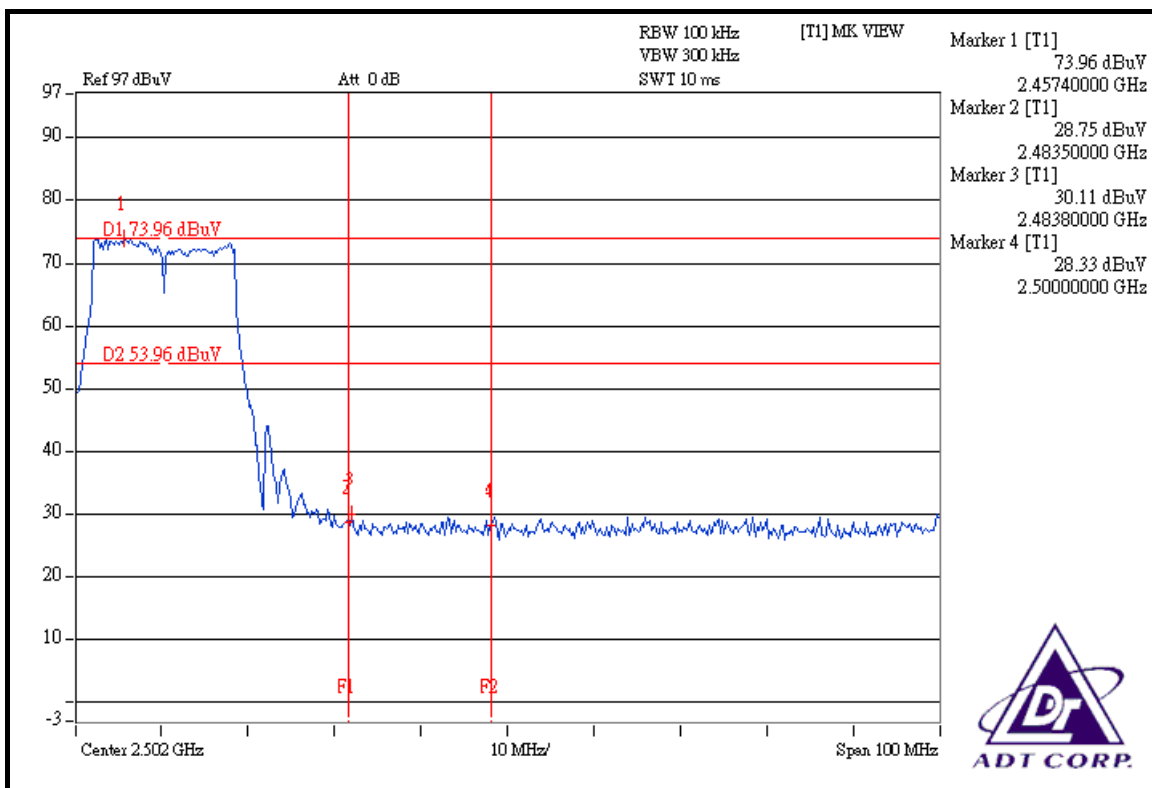
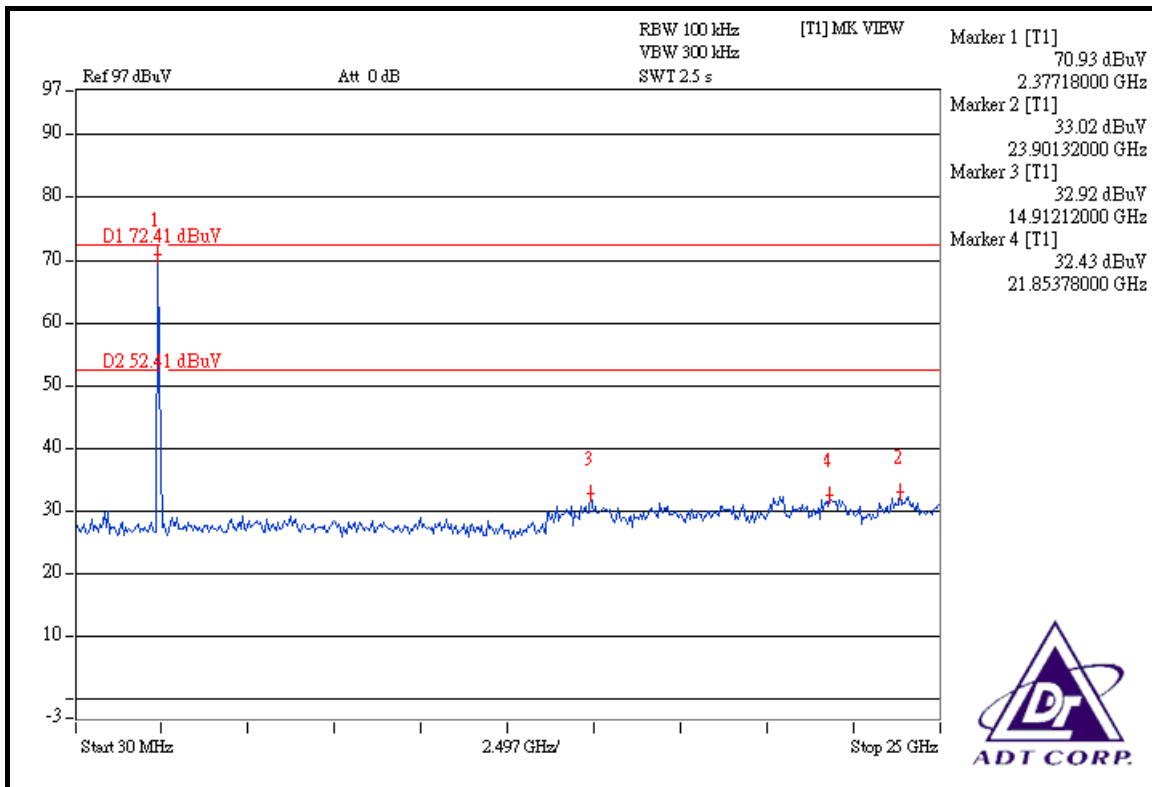

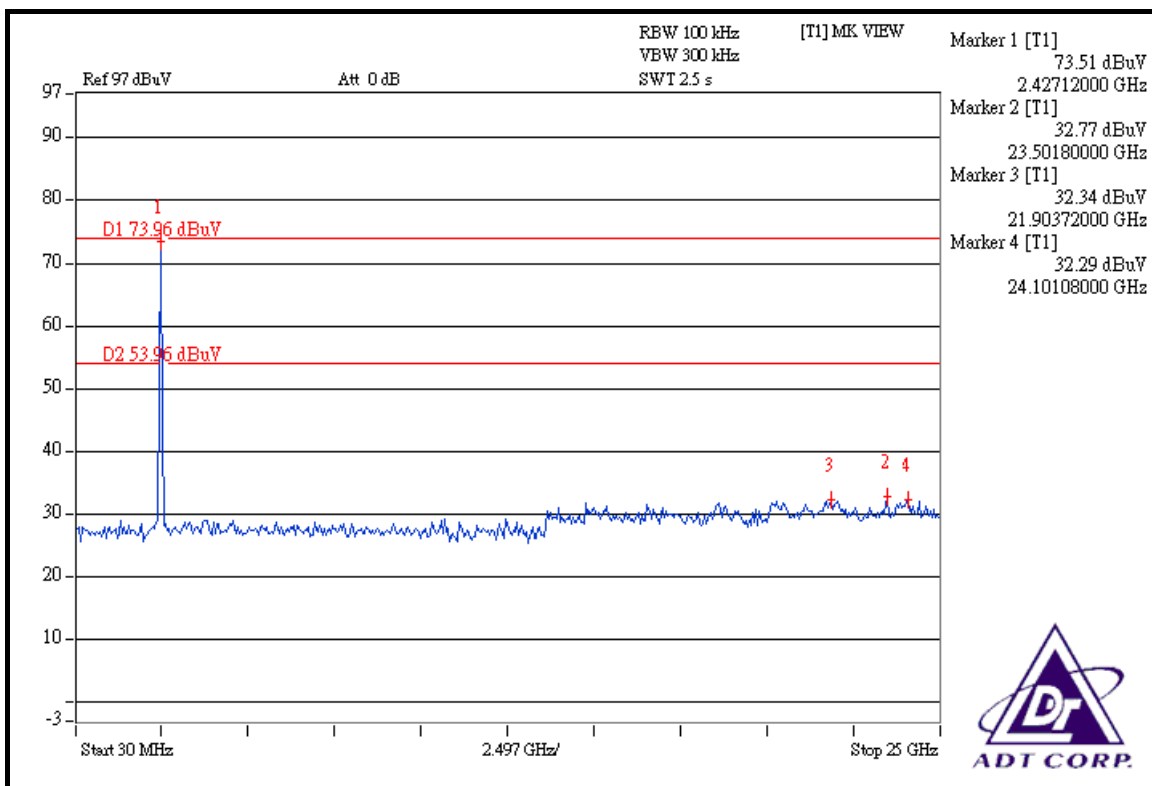
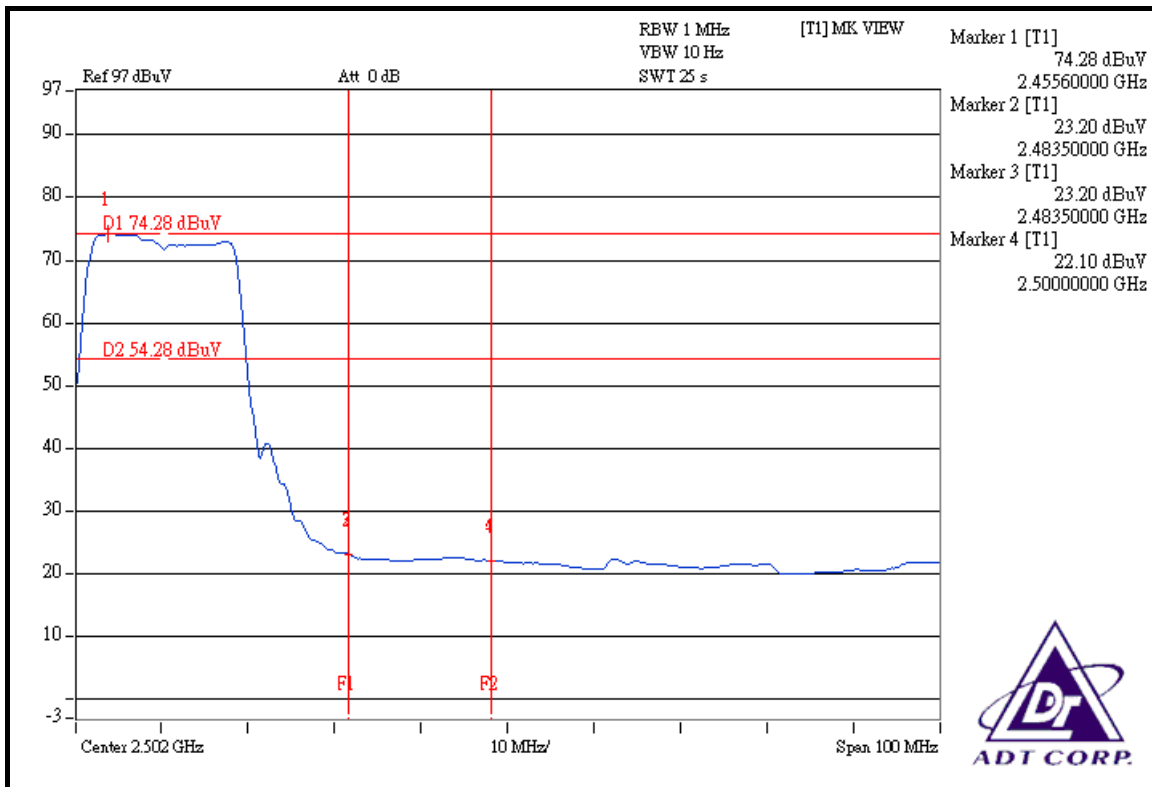

DRAFT 802.11n (20MHz) OFDM MODULATION

NOTE 1:

The band edge emission plot on the next page shows 43.83dBc between carrier maximum power and local maximum emission in restrict band (2.34540GHz). The emission of carrier strength list in the test result of channel 1 at the item 4.2.7 is 108.28dBuV/m (Peak), so the maximum field strength in restrict band is $108.28 - 43.83 = 64.45$ dBuV/m which is under 74dBuV/m limit.

The band edge emission plot on the next page shows 50.47dBc between carrier maximum power and local maximum emission in restrict band (2.39000GHz). The emission of carrier strength list in the test result of channel 1 at the item 4.2.7 is 98.03dBuV/m (Average), so the maximum field strength in restrict band is $98.03 - 50.47 = 47.56$ dBuV/m which is under 54dBuV/m limit.

NOTE 2:

The band edge emission plot on the next second page shows 43.86dBc between carrier maximum power and local maximum emission in restrict band (2.49100GHz). The emission of carrier strength list in the test result of channel 11 at the item 4.2.7 is 108.61dBuV/m (Peak), so the maximum field strength in restrict band is $108.61 - 43.86 = 64.75$ dBuV/m which is under 74dBuV/m limit.

The band edge emission plot on the next third page shows 50.54dBc between carrier maximum power and local maximum emission in restrict band (2.48350GHz). The emission of carrier strength list in the test result of channel 11 at the item 4.2.7 is 98.30dBuV/m (Average), so the maximum field strength in restrict band is $98.30 - 50.54 = 47.76$ dBuV/m which is under 54dBuV/m limit.

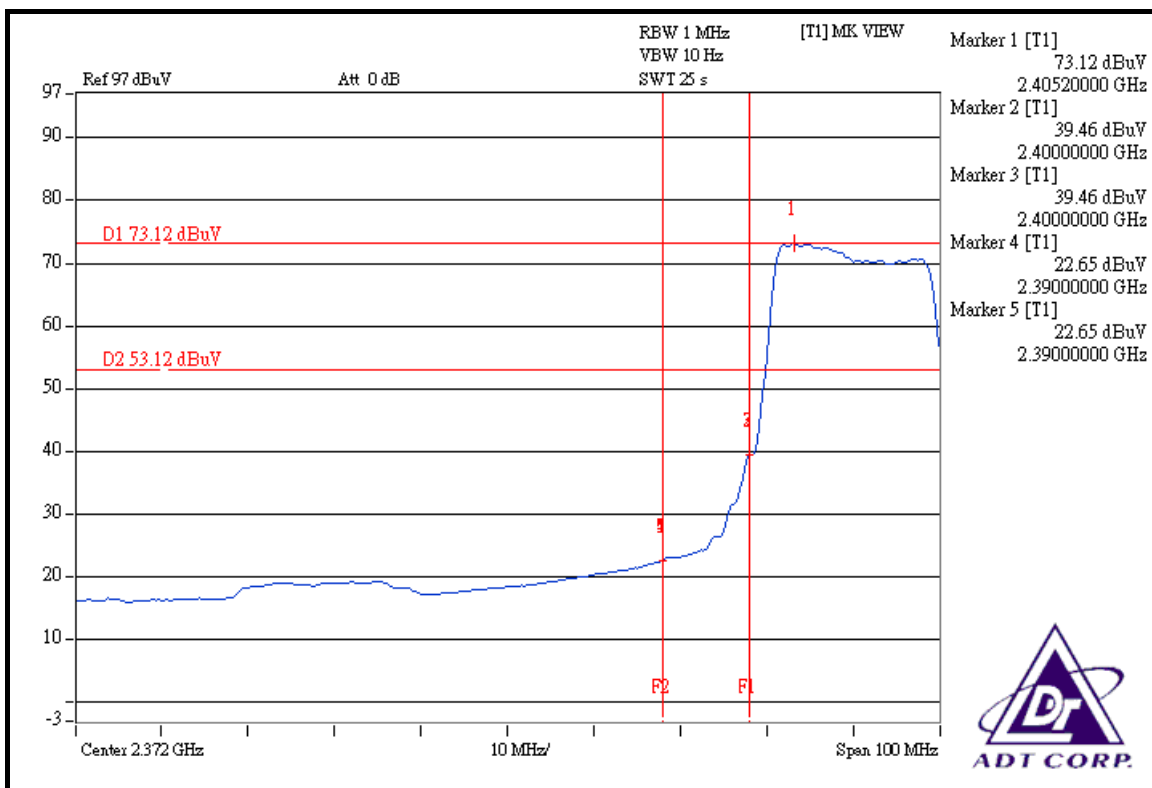
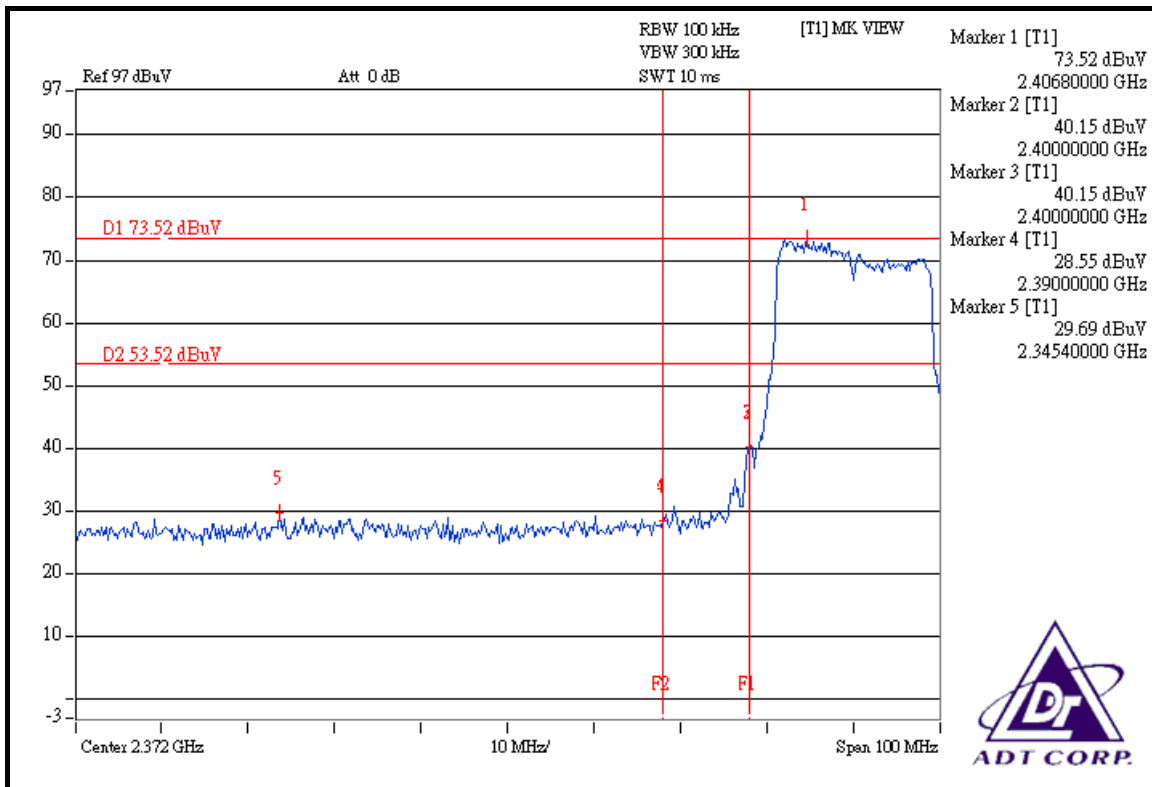

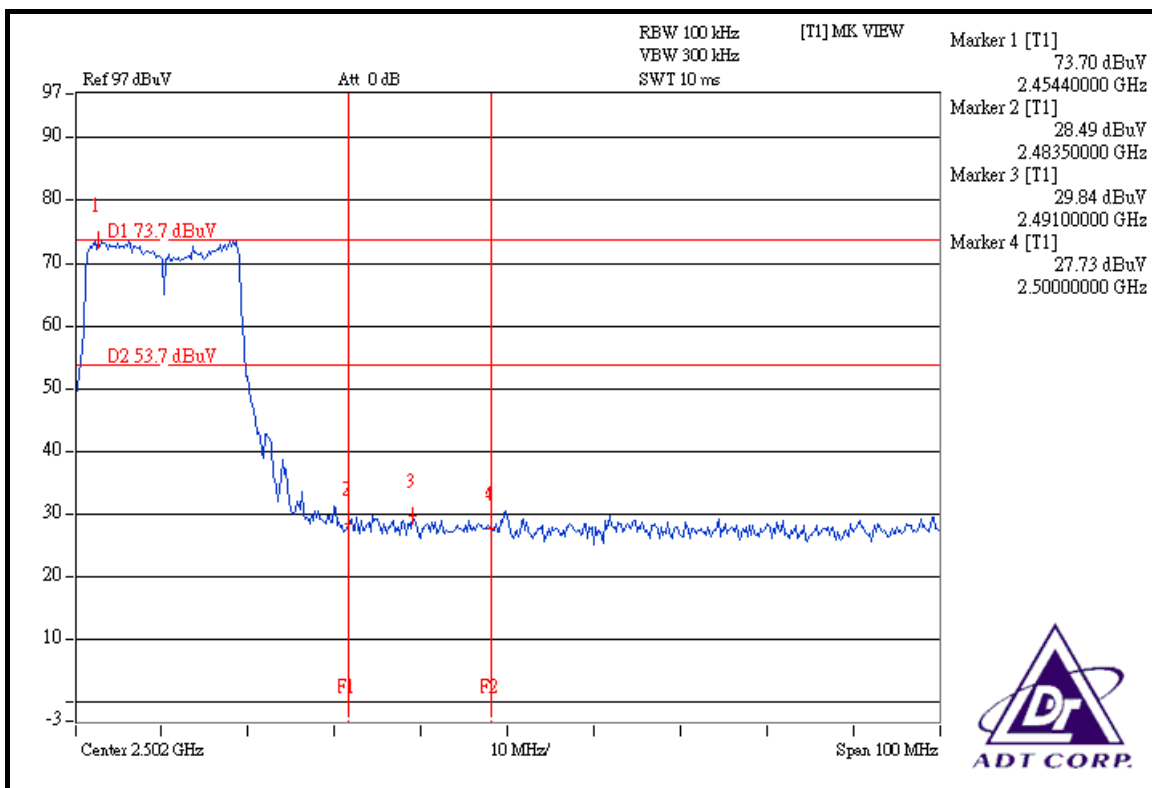
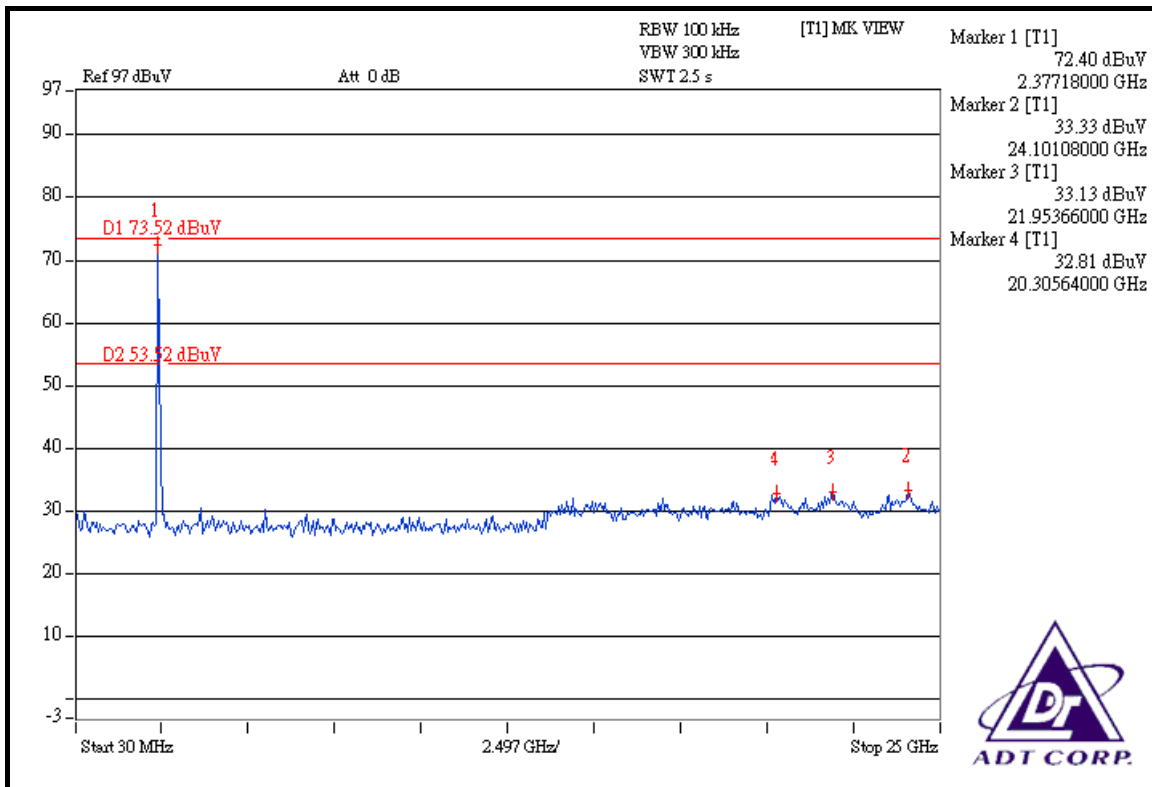

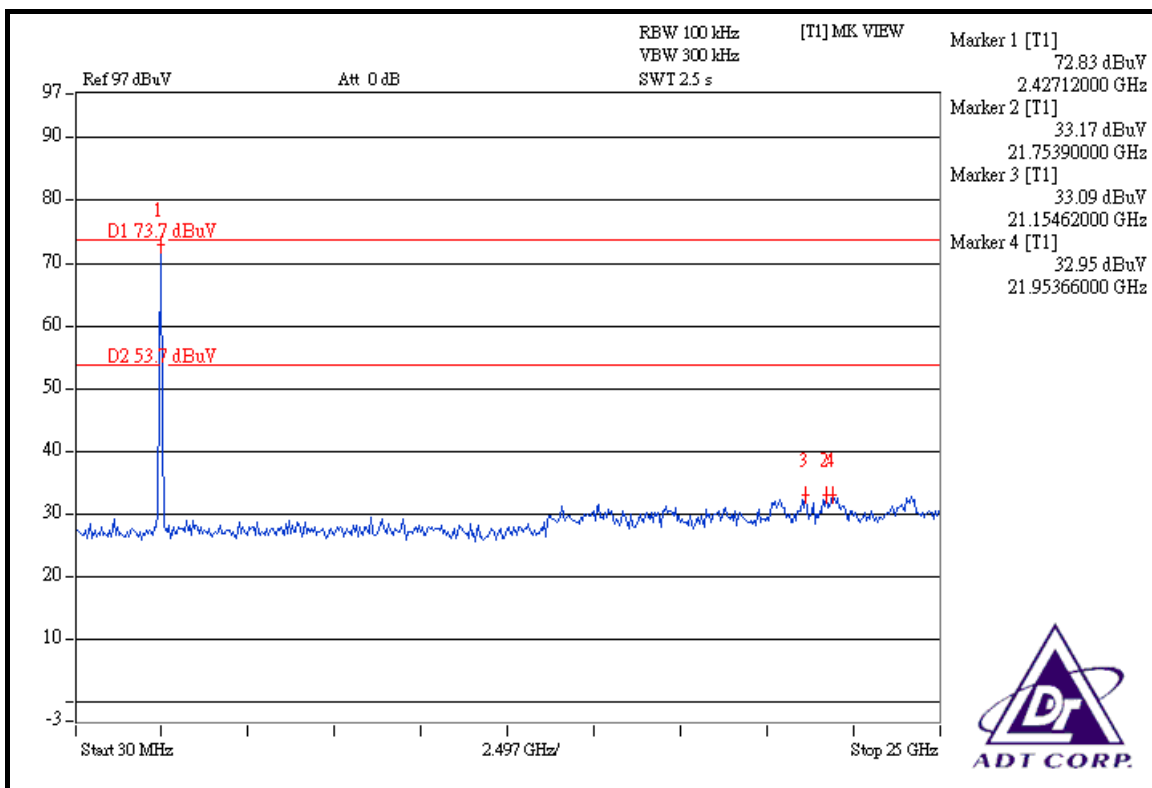
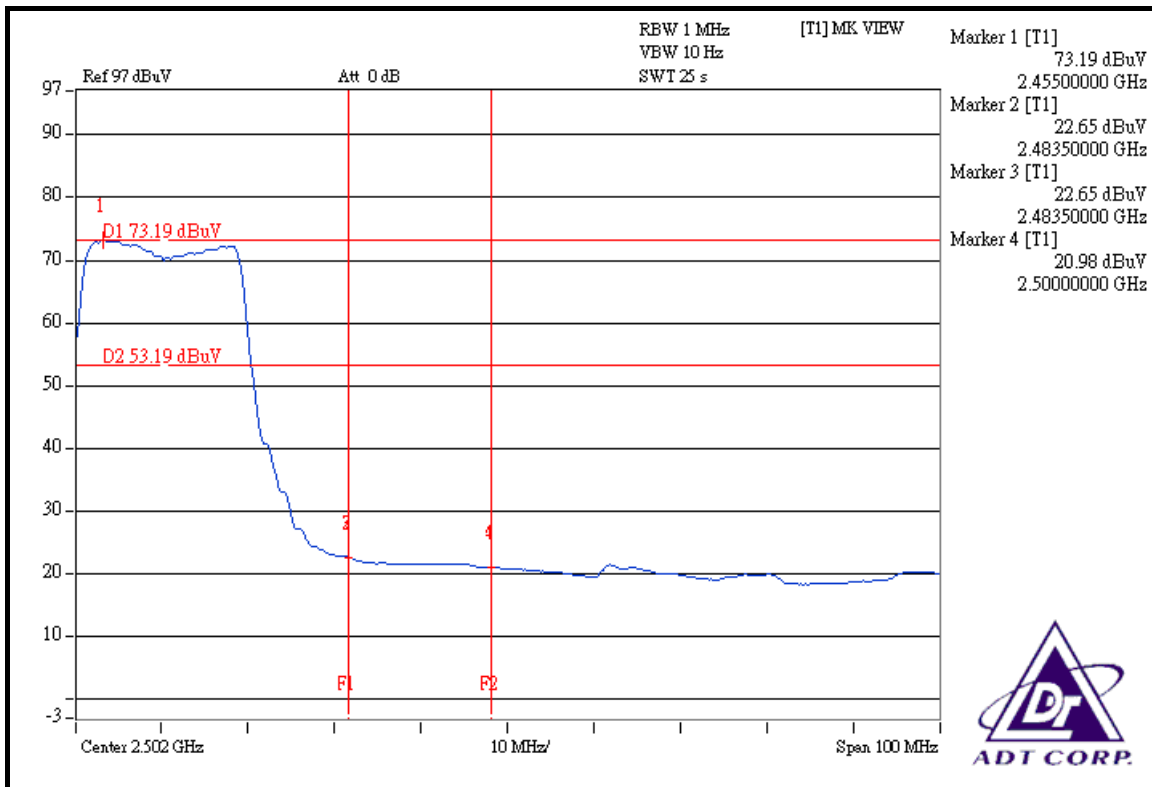

DRAFT 802.11n (40MHz) OFDM MODULATION

NOTE 1:

The band edge emission plot on the next page shows 40.58dBc between carrier maximum power and local maximum emission in restrict band (2.38920GHz). The emission of carrier strength list in the test result of channel 1 at the item 4.2.7 is 106.46dBuV/m (Peak), so the maximum field strength in restrict band is $106.46 - 40.58 = 65.88$ dBuV/m which is under 74dBuV/m limit.

The band edge emission plot on the next page shows 44.43dBc between carrier maximum power and local maximum emission in restrict band (2.39000GHz). The emission of carrier strength list in the test result of channel 1 at the item 4.2.7 is 96.62dBuV/m (Average), so the maximum field strength in restrict band is $96.62 - 44.43 = 52.19$ dBuV/m which is under 54dBuV/m limit.

NOTE 2:

The band edge emission plot on the next second page shows 38.78dBc between carrier maximum power and local maximum emission in restrict band (2.48440GHz). The emission of carrier strength list in the test result of channel 7 at the item 4.2.7 is 106.68dBuV/m (Peak), so the maximum field strength in restrict band is $106.68 - 38.78 = 67.90$ dBuV/m which is under 74dBuV/m limit.

The band edge emission plot on the next third page shows 43.99dBc between carrier maximum power and local maximum emission in restrict band (2.48400GHz). The emission of carrier strength list in the test result of channel 7 at the item 4.2.7 is 96.83dBuV/m (Average), so the maximum field strength in restrict band is $96.83 - 43.99 = 52.84$ dBuV/m which is under 54dBuV/m limit.

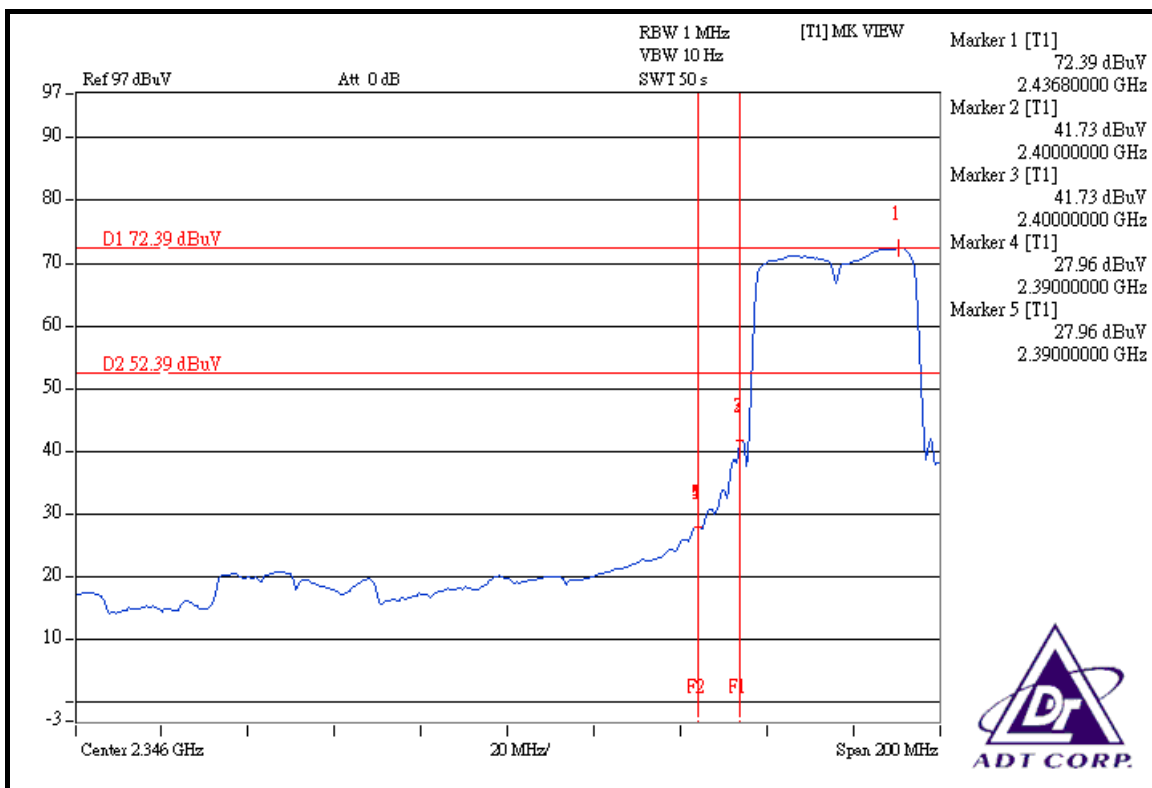
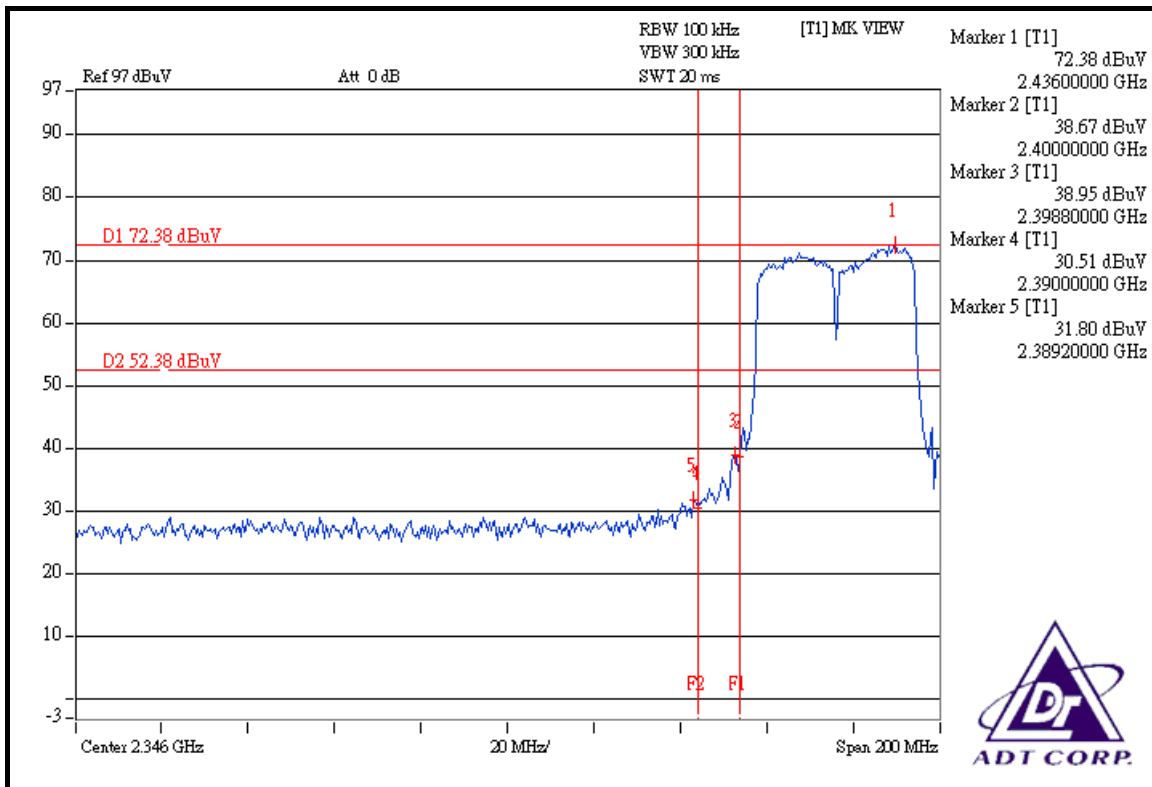

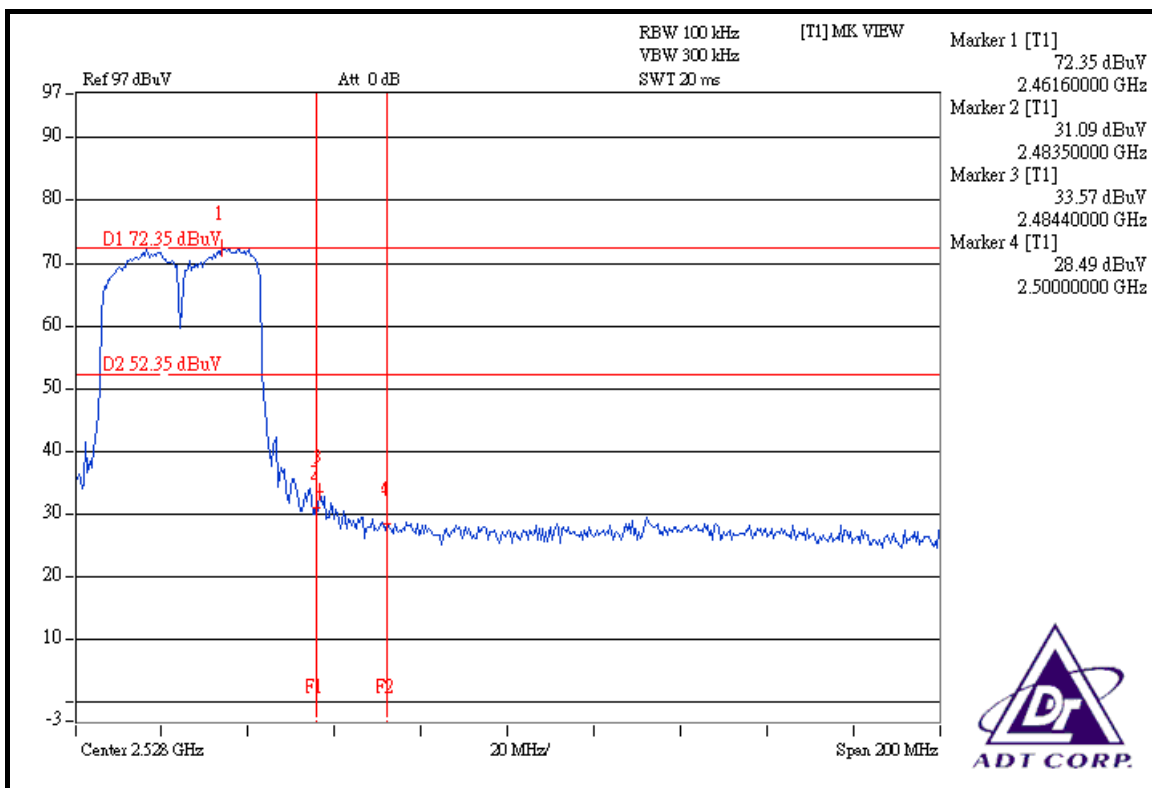
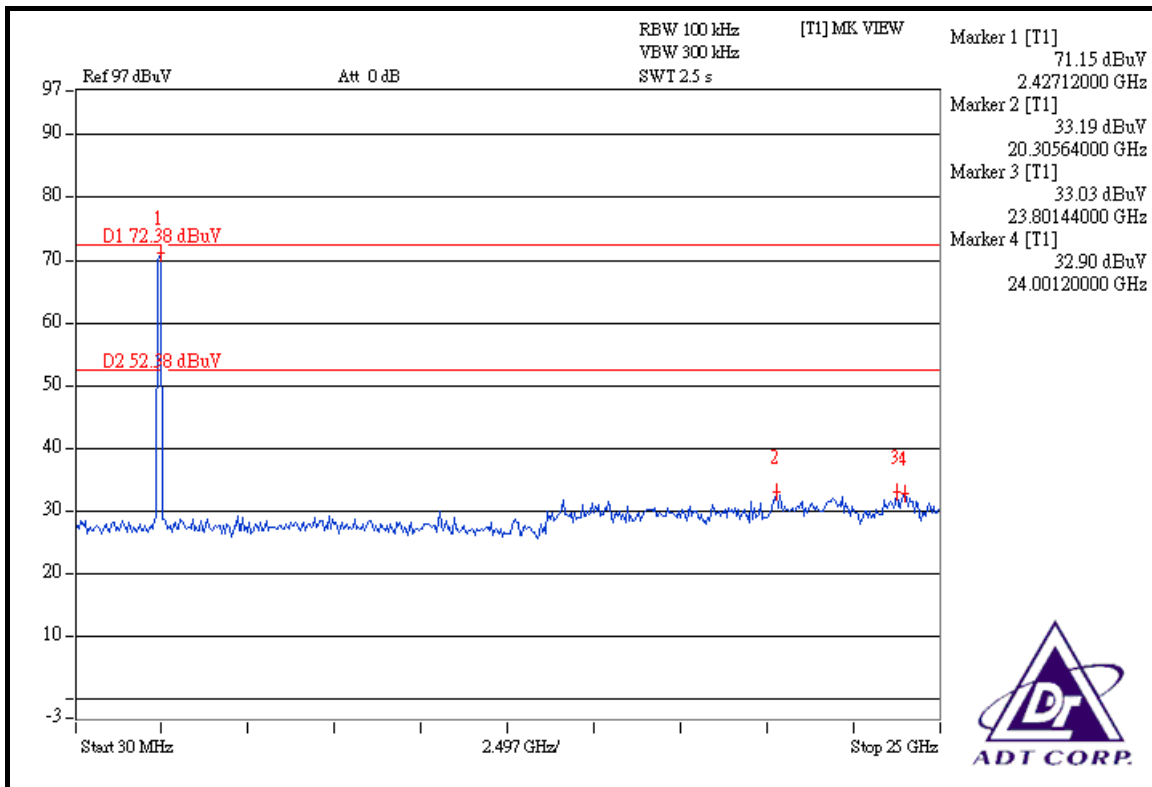

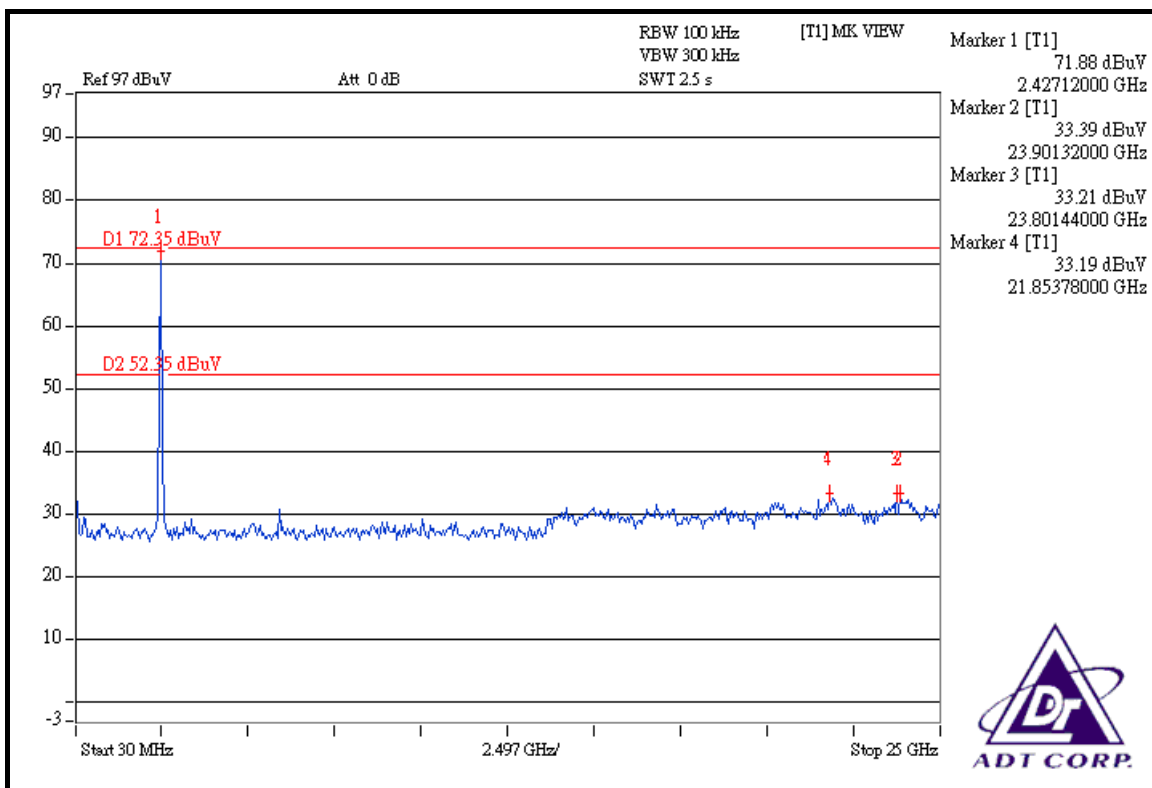
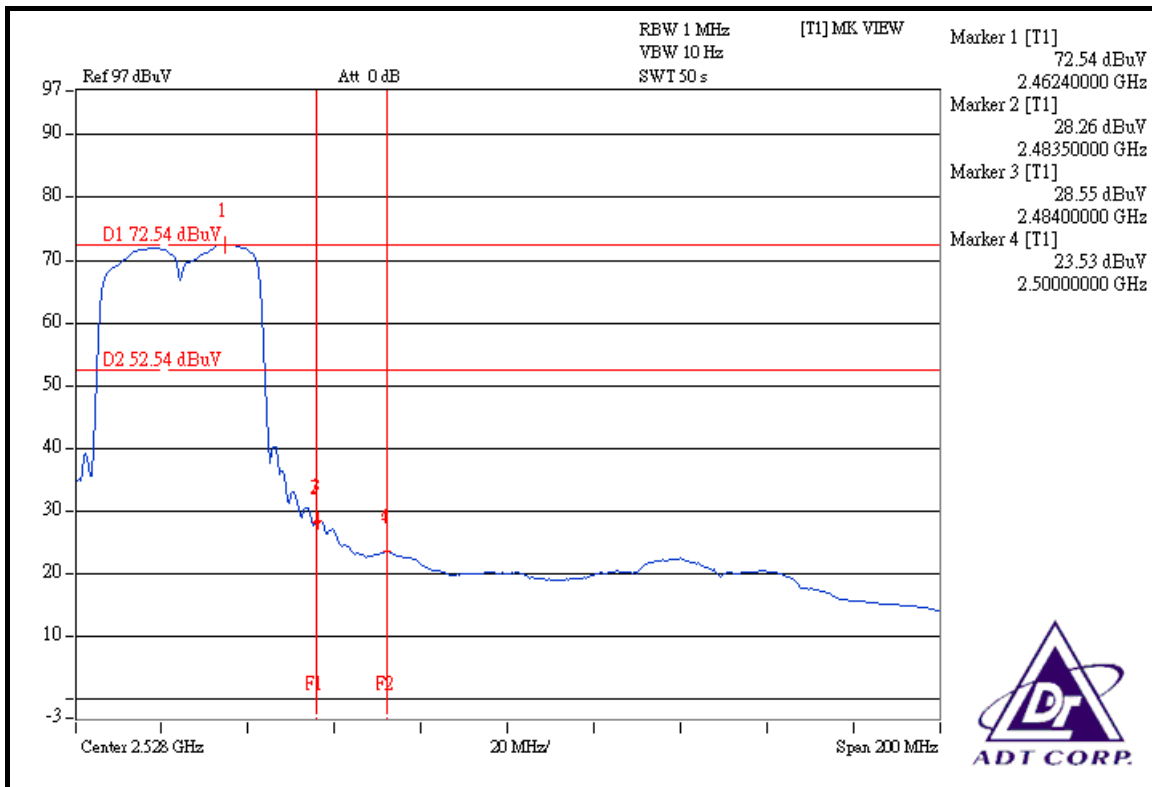



4.7 ANTENNA REQUIREMENT

4.7.1 STANDARD APPLICABLE

For intentional device, according to FCC 47 CFR Section 15.203, an intentional radiator shall be designed to ensure that no antenna other than that furnished by the responsible party shall be used with the device. And according to FCC 47 CFR Section 15.247 (b), if transmitting antennas of directional gain greater than 6dBi are used, the power shall be reduced by the amount in dB that the directional gain of the antenna exceeds 6dBi.

4.7.2 ANTENNA CONNECTED CONSTRUCTION

The antenna used in this product is Dipole antenna with UFL connector. The maximum gain of the antenna is 2dBi.



5. PHOTOGRAPHS OF THE TEST CONFIGURATION

Please refer to the attached file (Test Setup Photo).



6. INFORMATION ON THE TESTING LABORATORIES

We, ADT Corp., were founded in 1988 to provide our best service in EMC, Radio, Telecom and Safety consultation. Our laboratories are accredited and approved by the following approval agencies according to ISO/IEC 17025.

USA	FCC, UL, A2LA
Germany	TUV Rheinland
Japan	VCCI
Norway	NEMKO
Canada	INDUSTRY CANADA, CSA
R.O.C.	TAF, BSMI, NCC
Netherlands	Telefication
Singapore	GOST-ASIA(MOU)
Russia	CERTIS(MOU)

Copies of accreditation certificates of our laboratories obtained from approval agencies can be downloaded from our web site:

www.adt.com.tw/index.5/phtml. If you have any comments, please feel free to contact us at the following:

Linko EMC/RF Lab:

Tel: 886-2-26052180

Fax: 886-2-26051924

Hsin Chu EMC/RF Lab:

Tel: 886-3-5935343

Fax: 886-3-5935342

Hwa Ya EMC/RF/Safety Telecom Lab:

Tel: 886-3-3183232

Fax: 886-3-3185050

Web Site: www.adt.com.tw

The address and road map of all our labs can be found in our web site also.



7. APPENDIX A - MODIFICATIONS RECORDERS FOR ENGINEERING CHANGES TO THE EUT BY THE LAB

No any modifications are made to the EUT by the lab during the test.