



FCC TEST REPORT

REPORT NO.: RF950505L14

MODEL NO.: WAP-200A

RECEIVED: May 08, 2006

TESTED: May 16 ~ 22, 2006

ISSUED: May 23, 2006

APPLICANT: U-MEDIA Communications, Inc.

ADDRESS: 9F, No.1, Jin-shan 7th St., Hsinchu 300, Taiwan,
R.O.C.

ISSUED BY: Advance Data Technology Corporation

LAB ADDRESS: No. 47, 14th Ling, Chia Pau Tsuen, Lin Kou Hsiang
244, Taipei Hsien, Taiwan, R.O.C.

TEST LOCATION: No. 19, Hwa Ya 2nd Rd., Wen Hwa Tsuen, Kwei
Shan Hsiang, Taoyuan Hsien 333, Taiwan, R.O.C.

This test report consists of 77 pages in total. It may be duplicated completely for legal use with the approval of the applicant. It should not be reproduced except in full, without the written approval of our laboratory. The client should not use it to claim product endorsement by CNLA, A2LA or any government agencies. The test results in the report only apply to the tested sample.



TABLE OF CONTENTS

1.	CERTIFICATION.....	4
2.	SUMMARY OF TEST RESULTS.....	5
2.1	MEASUREMENT UNCERTAINTY	6
3.	GENERAL INFORMATION	7
3.1	GENERAL DESCRIPTION OF EUT	7
3.2	DESCRIPTION OF TEST MODES	8
3.2.1	CONFIGURATION OF SYSTEM UNDER TEST	8
3.2.2	TEST MODE APPLICABILITY AND TESTED CHANNEL DETAIL	10
3.2.3	GENERAL DESCRIPTION OF APPLIED STANDARDS	12
3.2.4	DESCRIPTION OF SUPPORT UNITS.....	12
4.	TEST TYPES AND RESULTS.....	13
4.1	CONDUCTED EMISSION MEASUREMENT	13
4.1.1	LIMITS OF CONDUCTED EMISSION MEASUREMENT	13
4.1.2	TEST INSTRUMENTS.....	13
4.1.3	TEST PROCEDURES	14
4.1.4	DEVIATION FROM TEST STANDARD	14
4.1.5	TEST SETUP	15
4.1.6	EUT OPERATING CONDITIONS.....	15
4.1.7	TEST RESULTS	15
4.2	RADIATED EMISSION MEASUREMENT	28
4.2.1	LIMITS OF RADIATED EMISSION MEASUREMENT	28
4.2.2	TEST INSTRUMENTS.....	29
4.2.3	TEST PROCEDURES	30
4.2.4	DEVIATION FROM TEST STANDARD	31
4.2.5	TEST SETUP	31
4.2.6	EUT OPERATING CONDITIONS.....	31
4.2.7	TEST RESULTS	32
4.3	6dB BANDWIDTH MEASUREMENT	43
4.3.1	LIMITS OF 6dB BANDWIDTH MEASUREMENT	43
4.3.2	TEST INSTRUMENTS.....	43
4.3.3	TEST PROCEDURE.....	44
4.3.4	DEVIATION FROM TEST STANDARD	44
4.3.5	TEST SETUP	44
4.3.6	EUT OPERATING CONDITIONS.....	44
4.3.7	TEST RESULTS	45
4.4	MAXIMUM PEAK OUTPUT POWER.....	51
4.4.1	LIMITS OF MAXIMUM PEAK OUTPUT POWER MEASUREMENT	51
4.4.2	INSTRUMENTS.....	51
4.4.3	TEST PROCEDURES	52
4.4.4	DEVIATION FROM TEST STANDARD	52
4.4.5	TEST SETUP	52
4.4.6	EUT OPERATING CONDITIONS.....	52



4.4.7	TEST RESULTS	53
4.5	POWER SPECTRAL DENSITY MEASUREMENT	54
4.5.1	LIMITS OF POWER SPECTRAL DENSITY MEASUREMENT	54
4.5.2	TEST INSTRUMENTS	54
4.5.3	TEST PROCEDURE	55
4.5.4	DEVIATION FROM TEST STANDARD	55
4.5.5	TEST SETUP	55
4.5.6	EUT OPERATING CONDITION	55
4.5.7	TEST RESULTS	56
4.6	BAND EDGES MEASUREMENT	62
4.6.1	LIMITS OF BAND EDGES MEASUREMENT	62
4.6.2	TEST INSTRUMENTS	62
4.6.3	TEST PROCEDURE	62
4.6.4	DEVIATION FROM TEST STANDARD	62
4.6.5	EUT OPERATING CONDITION	62
4.6.6	TEST RESULTS	63
4.7	ANTENNA REQUIREMENT	71
4.7.1	STANDARD APPLICABLE	71
4.7.2	ANTENNA CONNECTED CONSTRUCTION	71
5.	PHOTOGRAPHS OF THE TEST CONFIGURATION	72
6.	INFORMATION ON THE TESTING LABORATORIES	76
	APPENDIX-A	A-1



1. CERTIFICATION

PRODUCT: 11g High Power Wireless AP/Bridge
MODEL: WAP-200A
BRAND: U-MEDIA
APPLICANT: U-MEDIA Communications, Inc.
TESTED: May 16 ~ 22, 2006
TEST SAMPLE: ENGINEERING SAMPLE
STANDARDS: FCC Part 15, Subpart C (Section 15.247),
ANSI C63.4-2003

The above equipment have been tested by **Advance Data Technology Corporation**, and found compliance with the requirement of the above standards. The test record, data evaluation & Equipment Under Test (EUT) configurations represented herein are true and accurate accounts of the measurements of the sample's EMC characteristics under the conditions specified in this report.

PREPARED BY : Rennie Wang , **DATE:** May 23, 2006
Rennie Wang

TECHNICAL ACCEPTANCE : Long Chen , **DATE:** May 23, 2006
Responsible for RF Long Chen

APPROVED BY : Gary Chang , **DATE:** May 23, 2006
Gary Chang / Supervisor

2. SUMMARY OF TEST RESULTS

The EUT has been tested according to the following specifications:

APPLIED STANDARD: FCC Part 15, Subpart C			
STANDARD SECTION	TEST TYPE AND LIMIT	RESULT	REMARK
15.207	AC Power Conducted Emission	PASS	Meet the requirement of limit. Minimum passing margin is -1.60dB at 23.129MHz
15.247(a)(2)	Spectrum Bandwidth of a Direct Sequence Spread Spectrum System Limit: min. 500kHz	PASS	Meet the requirement of limit.
15.247(b)	Maximum Peak Output Power Limit: max. 30dBm	PASS	Meet the requirement of limit.
15.247(d)	Radiated Emissions Limit: Table 15.209	PASS	Meet the requirement of limit. Minimum passing margin is -1.00dB at 2499.00MHz
15.247(e)	Power Spectral Density Limit: max. 8dBm	PASS	Meet the requirement of limit.
15.247(d)	Band Edge Measurement Limit: 20dB less than the peak value of fundamental frequency	PASS	Meet the requirement of limit.

2.1 MEASUREMENT UNCERTAINTY

Where relevant, the following measurement uncertainty levels have been estimated for tests performed on the EUT as specified in CISPR 16-4:

MEASUREMENT	FREQUENCY	UNCERTAINTY
Conducted emissions	9kHz~30MHz	2.44 dB
Radiated emissions	30MHz ~ 200MHz	3.71 dB
	200MHz ~1000MHz	3.73 dB
	1GHz ~ 18GHz	2.26 dB
	18GHz ~ 40GHz	1.94 dB

This uncertainty represents an expanded uncertainty expressed at approximately the 95% confidence level using a coverage factor of $k=2$.

3. GENERAL INFORMATION

3.1 GENERAL DESCRIPTION OF EUT

EUT	11g High Power Wireless AP/Bridge
MODEL NO.	WAP-200A
FCC ID	SI5WAP200A
POWER SUPPLY	48Vdc from POE 5Vdc from AC adapter
MODULATION TYPE	CCK, DQPSK, DBPSK for DSSS 64QAM, 16QAM, QPSK, BPSK for OFDM
RADIO TECHNOLOGY	DSSS, OFDM
TRANSFER RATE	802.11b: 11/5.5/2/1Mbps 802.11g: 54/48/36/24/18/12/9/6Mbps
FREQUENCY RANGE	2412MHz ~ 2462MHz
NUMBER OF CHANNEL	11
OUTPUT POWER	80.538mW
ANTENNA TYPE	Dipole antenna with 4dBi gain Printed antenna with 0dBi gain
DATA CABLE	NA
I/O PORTS	RJ45
ASSOCIATED DEVICES	NA

NOTE:

1. The EUT was powered with following adapter:

Brand	DVE
Model	DSA-12W-05 FUS
Input Power	100-240Vac, 50-60Hz, 0.3A
Output Power	5Vdc, 2A
Power Line	1.8m non-shielded cable without core

2. The POE is for support unit only.

3. The EUT, operates in the 2.4GHz frequency range, lets you connect IEEE 802.11g or IEEE 802.11b devices to the network. With its high-speed data transmissions of up to 54Mbps.

4. The above EUT information was declared by manufacturer and for more detailed features description, please refer to the manufacturer's specifications or User's Manual.

3.2 DESCRIPTION OF TEST MODES

Eleven channels are provided to this EUT.

CHANNEL	FREQUENCY	CHANNEL	FREQUENCY
1	2412 MHz	7	2442 MHz
2	2417 MHz	8	2447 MHz
3	2422 MHz	9	2452 MHz
4	2427 MHz	10	2457 MHz
5	2432 MHz	11	2462 MHz
6	2437 MHz		

3.2.1 CONFIGURATION OF SYSTEM UNDER TEST

Test mode A (adapter mode):

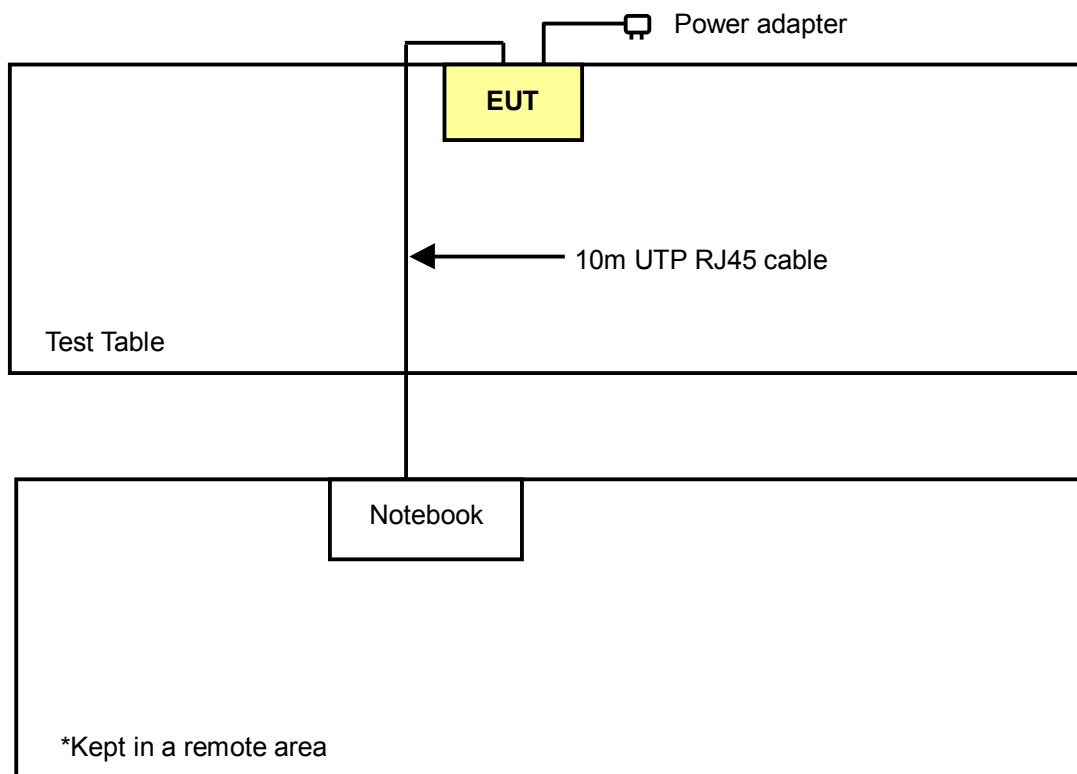

Test mode B (POE mode):

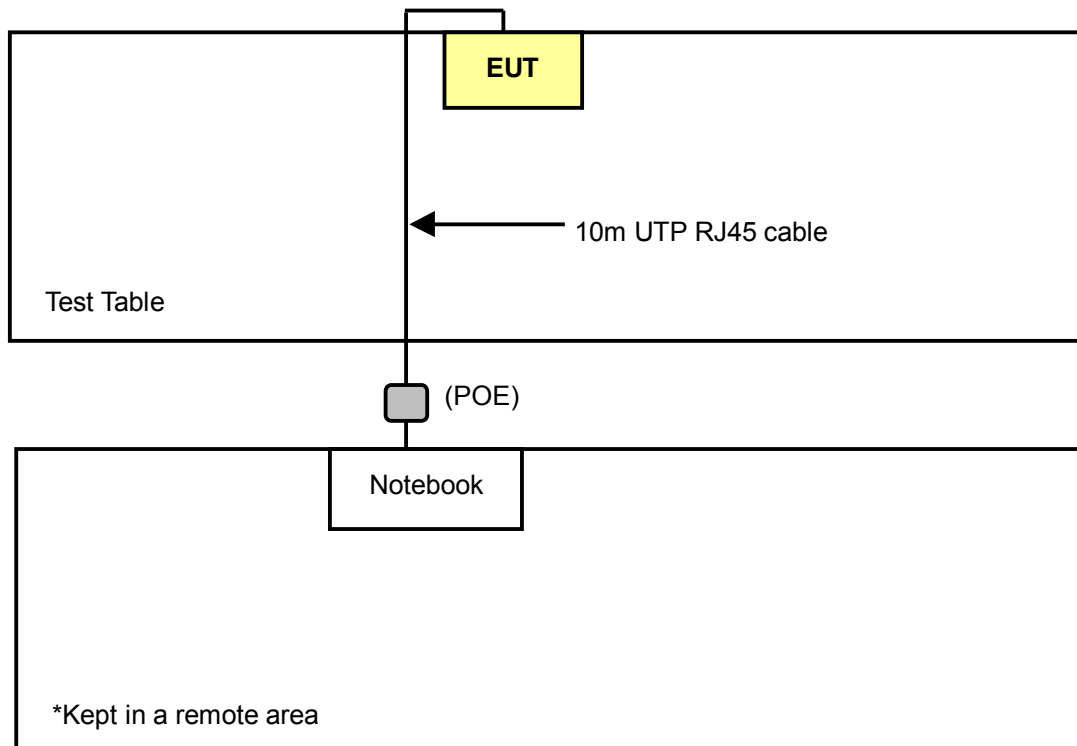

3.2.2 TEST MODE APPLICABILITY AND TESTED CHANNEL DETAIL

EUT CONFIGURE MODE	APPLICABLE TO				DESCRIPTION
	PLC	RE<1G	RE≥1G	APCM	
A	√	√	-	-	Adapter mode with Dipole antenna
B	√	√	√	√	POE mode with Dipole antenna
C	-	-	√	-	POE mode with Printed antenna

Where **PLC**: Power Line Conducted Emission **RE<1G**: Radiated Emission below 1GHz
RE≥1G: Radiated Emission above 1GHz **APCM**: Antenna Port Conducted Measurement
NOTE: “-“ means no effect.

POWER LINE CONDUCTED EMISSION TEST:

- Pre-Scan has been conducted to determine the worst-case mode from all possible combinations between available modulations, data rates and antenna ports (if EUT with antenna diversity architecture).
- Following channel(s) was (were) selected for the final test as listed below.

EUT CONFIGURE MODE	MODE	AVAILABLE CHANNEL	TESTED CHANNEL	MODULATION TECHNOLOGY	MODULATION TYPE	DATA RATE (Mbps)
A	802.11g	1 to 11	1, 6, 11	OFDM	BPSK	6
B	802.11g	1 to 11	1, 6, 11	OFDM	BPSK	6

RADIATED EMISSION TEST (BELOW 1 GHz):

- Pre-Scan has been conducted to determine the worst-case mode from all possible combinations between available modulations, data rates and antenna ports (if EUT with antenna diversity architecture).
- Following channel(s) was (were) selected for the final test as listed below.

EUT CONFIGURE MODE	MODE	AVAILABLE CHANNEL	TESTED CHANNEL	MODULATION TECHNOLOGY	MODULATION TYPE	DATA RATE (Mbps)
A	802.11g	1 to 11	11	OFDM	BPSK	6
B	802.11g	1 to 11	11	OFDM	BPSK	6

RADIATED EMISSION TEST (ABOVE 1 GHz):

- Pre-Scan has been conducted to determine the worst-case mode from all possible combinations between available modulations, data rates and antenna ports (if EUT with antenna diversity architecture).
- Following channel(s) was (were) selected for the final test as listed below.

EUT CONFIGURE MODE	MODE	AVAILABLE CHANNEL	TESTED CHANNEL	MODULATION TECHNOLOGY	MODULATION TYPE	DATA RATE (Mbps)
B	802.11b	1 to 11	1, 6, 11	DSSS	DBPSK	1
B	802.11g	1 to 11	1, 6, 11	OFDM	BPSK	6
C	802.11b	1 to 11	6	DSSS	DBPSK	1

BANDEDGE MEASUREMENT:

- Pre-Scan has been conducted to determine the worst-case mode from all possible combinations between available modulations, data rates and antenna ports (if EUT with antenna diversity architecture).
- Following channel(s) was (were) selected for the final test as listed below.

EUT CONFIGURE MODE	MODE	AVAILABLE CHANNEL	TESTED CHANNEL	MODULATION TECHNOLOGY	MODULATION TYPE	DATA RATE (Mbps)
B	802.11b	1 to 11	1, 11	DSSS	DBPSK	1
B	802.11g	1 to 11	1, 11	OFDM	BPSK	6

ANTENNA PORT CONDUCTED MEASUREMENT:

- Pre-Scan has been conducted to determine the worst-case mode from all possible combinations between available modulations, data rates and antenna ports (if EUT with antenna diversity architecture).
- Following channel(s) was (were) selected for the final test as listed below.

EUT CONFIGURE MODE	MODE	AVAILABLE CHANNEL	TESTED CHANNEL	MODULATION TECHNOLOGY	MODULATION TYPE	DATA RATE (Mbps)
B	802.11b	1 to 11	1, 6, 11	DSSS	DBPSK	1
B	802.11g	1 to 11	1, 6, 11	OFDM	BPSK	6

3.2.3 GENERAL DESCRIPTION OF APPLIED STANDARDS

The EUT is an RF product. According to the specifications of the manufacturer, it must comply with the requirements of the following standards:

FCC Part 15, Subpart C. (15.247)

ANSI C63.4- 2003

All test items have been performed and recorded as per the above standards.

NOTE: The EUT is also considered as a kind of computer peripheral, because the connection to computer is necessary for typical use. It has been verified to comply with the requirements of FCC Part 15, Subpart B, Class B (DoC). The test report has been issued separately.

3.2.4 DESCRIPTION OF SUPPORT UNITS

The EUT has been tested as an independent unit together with other necessary accessories or support units. The following support units or accessories were used to form a representative test configuration during the tests.

NO.	PRODUCT	BRAND	MODEL NO.	SERIAL NO.	FCC ID
1	NOTEBOOK COMPUTER	DELL	PP05L	20838027664	E2K24CLNS
2	POE	BUFFALO	BIJ-POE-4P	NA	NA

NO.	SIGNAL CABLE DESCRIPTION OF THE ABOVE SUPPORT UNITS
1	NA
2	NA

NOTE 1: All power cords of the above support units are non shielded (1.8m).

NOTE 2: Item 1 is acted as a communication partner to transfer data.

4. TEST TYPES AND RESULTS

4.1 CONDUCTED EMISSION MEASUREMENT

4.1.1 LIMITS OF CONDUCTED EMISSION MEASUREMENT

FREQUENCY OF EMISSION (MHz)	CONDUCTED LIMIT (dB μ V)	
	Quasi-peak	Average
0.15-0.5	66 to 56	56 to 46
0.5-5	56	46
5-30	60	50

- NOTE:**
1. The lower limit shall apply at the transition frequencies.
 2. The limit decreases in line with the logarithm of the frequency in the range of 0.15 to 0.50 MHz.
 3. All emanations from a class A/B digital device or system, including any network of conductors and apparatus connected thereto, shall not exceed the level of field strengths specified above.

4.1.2 TEST INSTRUMENTS

DESCRIPTION & MANUFACTURER	MODEL NO.	SERIAL NO.	CALIBRATED UNTIL
Test Receiver ROHDE & SCHWARZ	ESCS30	100291	Nov. 11, 2006
RF signal cable Woken	5D-FB	Cable-HYC01-01	Jan. 06, 2007
LISN ROHDE & SCHWARZ	ESH3-Z5	100312	Feb. 15, 2007
LISN ROHDE & SCHWARZ	ESH2-Z5	100104	Feb. 07, 2007
Software ADT	ADT_Cond_V3	NA	NA

- NOTE:**
1. The calibration interval of the above test instruments is 12 months and the calibrations are traceable to NML/ROC and NIST/USA.
 2. The test was performed in HwaYa Shielded Room 1.
 3. The VCCI Site Registration No. is C-2040.

4.1.3 TEST PROCEDURES

- a. The EUT was placed 0.4 meters from the conducting wall of the shielded room with EUT being connected to the power mains through a line impedance stabilization network (LISN). Other support units were connected to the power mains through another LISN. The two LISNs provide 50 ohm/ 50uH of coupling impedance for the measuring instrument.
- b. Both lines of the power mains connected to the EUT were checked for maximum conducted interference.
- c. The frequency range from 150kHz to 30MHz was searched. Emission levels under (Limit - 20dB) was not recorded.

4.1.4 DEVIATION FROM TEST STANDARD

No deviation

4.1.5 TEST SETUP

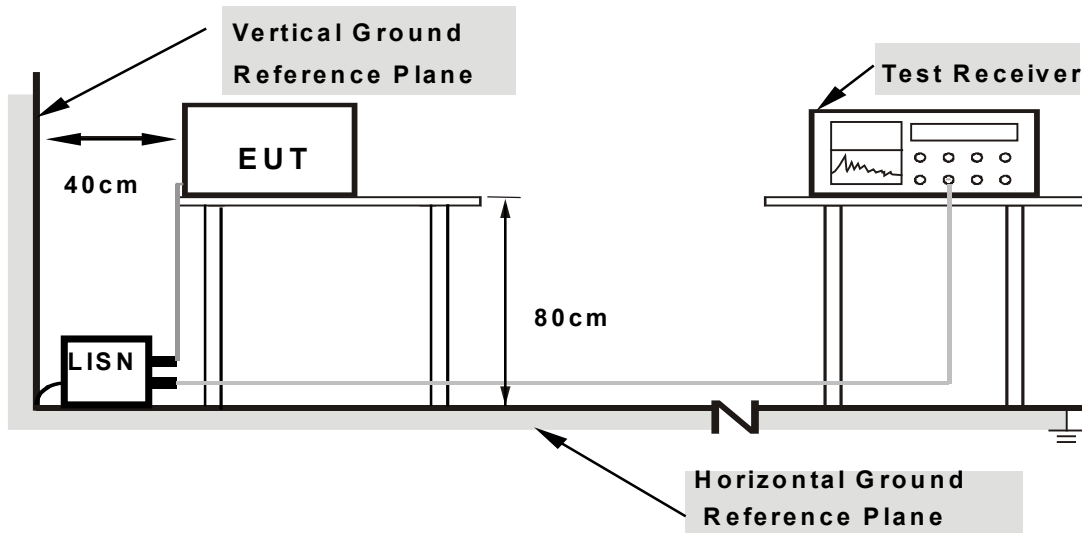

Note: 1.Support units were connected to second LISN.

2.Both of LISNs (AMN) are 80 cm from EUT and at least 80 from other units and other metal planes

For the actual test configuration, please refer to the related item – Photographs of the Test Configuration.

4.1.6 EUT OPERATING CONDITIONS

- a. Placed the EUT on the testing table.
- b. Prepared another notebook system to act as a communication partner and placed it outside of testing area.
- c. The communication partner connected with EUT via a UTP cable and run a test program (provided by manufacturer) to enable EUT under transmission/receiving condition continuously at specific channel frequency via an RJ45 cable.
- d. The communication partner sent data to EUT by command "PING".

4.1.7 TEST RESULTS

CONDUCTED WORST-CASE DATA FOR ADAPTER MODE:

EUT TEST CONDITION		MEASUREMENT DETAIL	
CHANNEL	Channel 1	PHASE	Line 1
MODULATION TYPE	BPSK	6dB BANDWIDTH	9 kHz
TRANSFER RATE	6Mbps	ENVIRONMENTAL CONDITIONS	23deg. C, 65%RH, 991hPa
TESTED BY	Whisky Chang	INPUT POWER (SYSTEM)	120Vac, 60 Hz
TEST MODE	A		

No	Freq. [MHz]	Corr. Factor (dB)	Reading Value [dB (uV)]		Emission Level [dB (uV)]		Limit [dB (uV)]		Margin (dB)	
			Q.P.	AV.	Q.P.	AV.	Q.P.	AV.	Q.P.	AV.
			1	0.220	0.10	51.70	-	51.80	-	62.81
2	0.435	0.11	43.59	-	43.70	-	57.15	47.15	-13.46	-
3	0.560	0.13	42.72	-	42.85	-	56.00	46.00	-13.15	-
4	0.651	0.14	44.91	-	45.05	-	56.00	46.00	-10.95	-
5	0.759	0.16	46.21	35.16	46.37	35.32	56.00	46.00	-9.63	-10.68
6	0.877	0.18	45.17	-	45.35	-	56.00	46.00	-10.65	-
7	0.978	0.20	43.30	-	43.50	-	56.00	46.00	-12.50	-
8	1.090	0.20	44.53	-	44.73	-	56.00	46.00	-11.27	-
9	1.734	0.20	41.51	-	41.71	-	56.00	46.00	-14.29	-
10	14.941	0.63	25.34	-	25.97	-	60.00	50.00	-34.03	-

- REMARKS:**
1. Q.P. and AV. are abbreviations of quasi-peak and average individually.
 2. "-": The Quasi-peak reading value also meets average limit and measurement with the average detector is unnecessary.
 3. The emission levels of other frequencies were very low against the limit.
 4. Margin value = Emission level - Limit value
 5. Correction factor = Insertion loss + Cable loss
 6. Emission Level = Correction Factor + Reading Value.

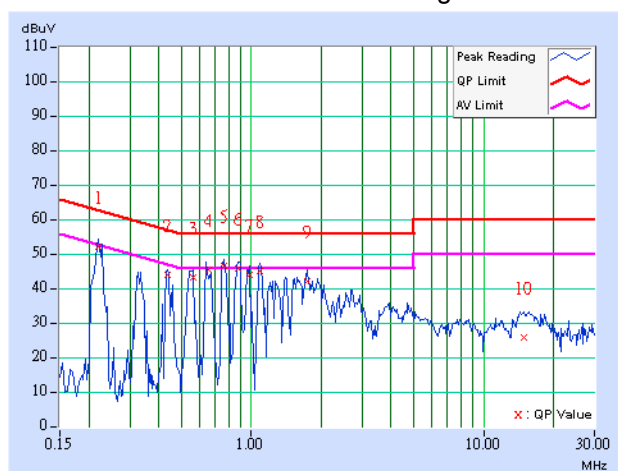

EUT TEST CONDITION		MEASUREMENT DETAIL	
CHANNEL	Channel 1	PHASE	Line 2
MODULATION TYPE	BPSK	6dB BANDWIDTH	9 kHz
TRANSFER RATE	6Mbps	ENVIRONMENTAL CONDITIONS	23deg. C, 65%RH, 991hPa
TESTED BY	Whisky Chang	INPUT POWER (SYSTEM)	120Vac, 60 Hz
TEST MODE	A		

No	Freq.	Corr.	Reading Value		Emission Level		Limit		Margin	
	[MHz]	Factor	[dB (uV)]		[dB (uV)]		[dB (uV)]		(dB)	
		(dB)	Q.P.	AV.	Q.P.	AV.	Q.P.	AV.	Q.P.	AV.
1	0.220	0.10	52.32	-	52.42	-	62.81	52.81	-10.39	-
2	0.447	0.10	42.60	-	42.70	-	56.93	46.93	-14.23	-
3	0.556	0.10	41.34	-	41.44	-	56.00	46.00	-14.56	-
4	0.666	0.10	39.41	-	39.51	-	56.00	46.00	-16.49	-
5	0.779	0.10	42.25	-	42.35	-	56.00	46.00	-13.65	-
6	0.896	0.10	41.66	-	41.76	-	56.00	46.00	-14.24	-
7	1.113	0.11	38.40	-	38.51	-	56.00	46.00	-17.49	-
8	15.012	0.53	23.92	-	24.45	-	60.00	50.00	-35.55	-

- REMARKS:**
1. Q.P. and AV. are abbreviations of quasi-peak and average individually.
 2. "-": The Quasi-peak reading value also meets average limit and measurement with the average detector is unnecessary.
 3. The emission levels of other frequencies were very low against the limit.
 4. Margin value = Emission level - Limit value
 5. Correction factor = Insertion loss + Cable loss
 6. Emission Level = Correction Factor + Reading Value.

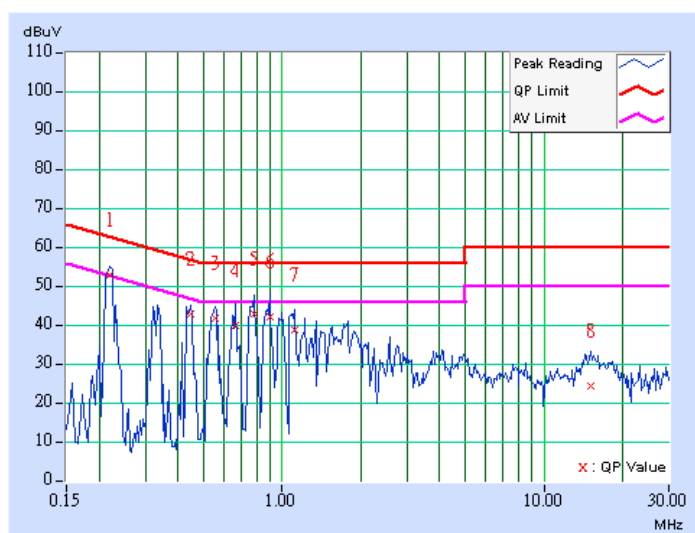

EUT TEST CONDITION		MEASUREMENT DETAIL	
CHANNEL	Channel 6	PHASE	Line 1
MODULATION TYPE	BPSK	6dB BANDWIDTH	9 kHz
TRANSFER RATE	6Mbps	ENVIRONMENTAL CONDITIONS	23deg. C, 65%RH, 991hPa
TESTED BY	Whisky Chang	INPUT POWER (SYSTEM)	120Vac, 60 Hz
TEST MODE	A		

No	Freq.	Corr.	Reading Value		Emission Level		Limit		Margin	
	[MHz]	Factor	[dB (uV)]		[dB (uV)]		[dB (uV)]		(dB)	
		(dB)	Q.P.	AV.	Q.P.	AV.	Q.P.	AV.	Q.P.	AV.
1	0.220	0.10	51.44	-	51.54	-	62.80	52.80	-11.26	-
2	0.431	0.11	43.40	-	43.51	-	57.23	47.23	-13.72	-
3	0.556	0.13	42.17	-	42.30	-	56.00	46.00	-13.70	-
4	0.646	0.14	44.50	-	44.64	-	56.00	46.00	-11.36	-
5	0.763	0.16	45.63	-	45.79	-	56.00	46.00	-10.21	-
6	0.861	0.18	44.74	-	44.92	-	56.00	46.00	-11.08	-
7	0.966	0.19	42.93	-	43.12	-	56.00	46.00	-12.88	-
8	1.086	0.20	44.29	-	44.49	-	56.00	46.00	-11.51	-
9	1.746	0.20	39.78	-	39.98	-	56.00	46.00	-16.02	-
10	15.613	0.65	25.12	-	25.77	-	60.00	50.00	-34.23	-

- REMARKS:**
1. Q.P. and AV. are abbreviations of quasi-peak and average individually.
 2. "-": The Quasi-peak reading value also meets average limit and measurement with the average detector is unnecessary.
 3. The emission levels of other frequencies were very low against the limit.
 4. Margin value = Emission level - Limit value
 5. Correction factor = Insertion loss + Cable loss
 6. Emission Level = Correction Factor + Reading Value.

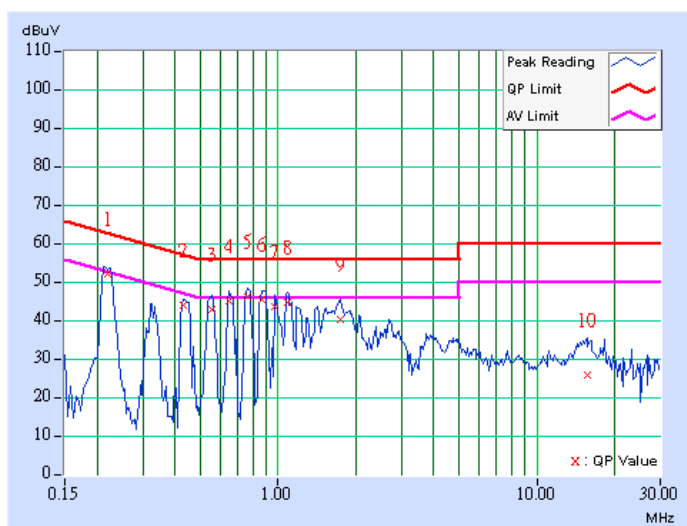

EUT TEST CONDITION		MEASUREMENT DETAIL	
CHANNEL	Channel 6	PHASE	Line 2
MODULATION TYPE	BPSK	6dB BANDWIDTH	9 kHz
TRANSFER RATE	6Mbps	ENVIRONMENTAL CONDITIONS	23deg. C, 65%RH, 991hPa
TESTED BY	Whisky Chang	INPUT POWER (SYSTEM)	120Vac, 60 Hz
TEST MODE	A		

No	Freq.	Corr.	Reading Value		Emission Level		Limit		Margin	
	[MHz]	Factor	[dB (uV)]		[dB (uV)]		[dB (uV)]		(dB)	
		(dB)	Q.P.	AV.	Q.P.	AV.	Q.P.	AV.	Q.P.	AV.
1	0.220	0.10	51.28	-	51.38	-	62.81	52.81	-11.43	-
2	0.435	0.10	40.15	-	40.25	-	57.15	47.15	-16.90	-
3	0.666	0.10	39.43	-	39.53	-	56.00	46.00	-16.47	-
4	0.783	0.10	42.17	-	42.27	-	56.00	46.00	-13.73	-
5	0.892	0.10	42.11	-	42.21	-	56.00	46.00	-13.79	-
6	1.539	0.15	32.97	-	33.12	-	56.00	46.00	-22.88	-
7	15.465	0.54	23.76	-	24.30	-	60.00	50.00	-35.70	-

- REMARKS:**
1. Q.P. and AV. are abbreviations of quasi-peak and average individually.
 2. "-": The Quasi-peak reading value also meets average limit and measurement with the average detector is unnecessary.
 3. The emission levels of other frequencies were very low against the limit.
 4. Margin value = Emission level - Limit value
 5. Correction factor = Insertion loss + Cable loss
 6. Emission Level = Correction Factor + Reading Value.

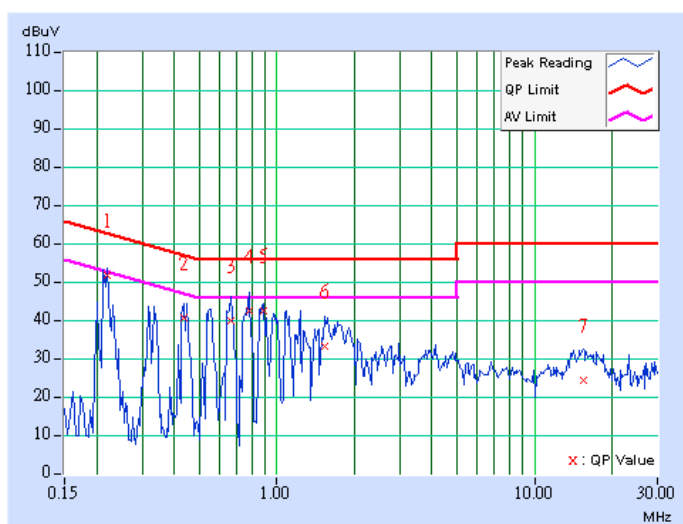

EUT TEST CONDITION		MEASUREMENT DETAIL	
CHANNEL	Channel 11	PHASE	Line 1
MODULATION TYPE	BPSK	6dB BANDWIDTH	9 kHz
TRANSFER RATE	6Mbps	ENVIRONMENTAL CONDITIONS	23deg. C, 65%RH, 991hPa
TESTED BY	Whisky Chang	INPUT POWER (SYSTEM)	120Vac, 60 Hz
TEST MODE	A		

No	Freq. [MHz]	Corr. Factor [dB]	Reading Value [dB (uV)]		Emission Level [dB (uV)]		Limit [dB (uV)]		Margin (dB)	
			Q.P.	AV.	Q.P.	AV.	Q.P.	AV.	Q.P.	AV.
			1	0.216	0.10	50.98	-	51.08	-	62.96
2	0.435	0.11	43.83	-	43.94	-	57.15	47.15	-13.22	-
3	0.560	0.13	42.64	-	42.77	-	56.00	46.00	-13.23	-
4	0.670	0.14	40.85	-	40.99	-	56.00	46.00	-15.01	-
5	0.767	0.16	46.24	34.83	46.40	34.99	56.00	46.00	-9.60	-11.01
6	0.869	0.18	45.09	-	45.27	-	56.00	46.00	-10.73	-
7	0.970	0.20	42.23	-	42.43	-	56.00	46.00	-13.57	-
8	1.090	0.20	44.07	-	44.27	-	56.00	46.00	-11.73	-
9	1.734	0.20	41.21	-	41.41	-	56.00	46.00	-14.59	-
10	15.254	0.64	27.46	-	28.10	-	60.00	50.00	-31.90	-

- REMARKS:**
1. Q.P. and AV. are abbreviations of quasi-peak and average individually.
 2. "-": The Quasi-peak reading value also meets average limit and measurement with the average detector is unnecessary.
 3. The emission levels of other frequencies were very low against the limit.
 4. Margin value = Emission level - Limit value
 5. Correction factor = Insertion loss + Cable loss
 6. Emission Level = Correction Factor + Reading Value.

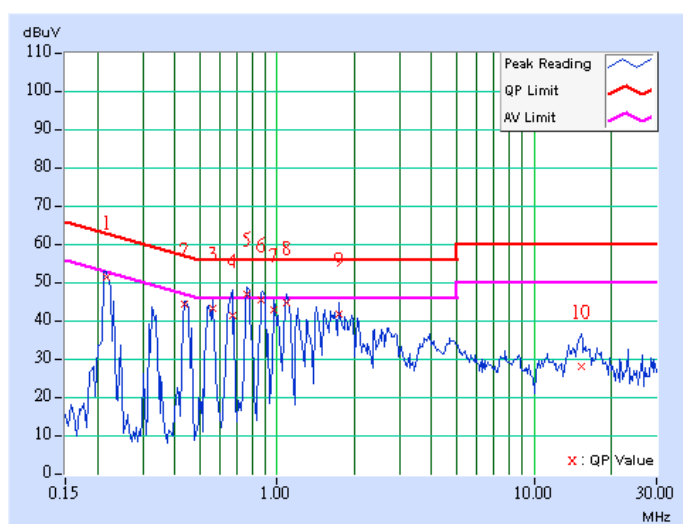

EUT TEST CONDITION		MEASUREMENT DETAIL	
CHANNEL	Channel 11	PHASE	Line 2
MODULATION TYPE	BPSK	6dB BANDWIDTH	9 kHz
TRANSFER RATE	6Mbps	ENVIRONMENTAL CONDITIONS	23deg. C, 65%RH, 991hPa
TESTED BY	Whisky Chang	INPUT POWER (SYSTEM)	120Vac, 60 Hz
TEST MODE	A		

No	Freq. [MHz]	Corr. Factor (dB)	Reading Value [dB (uV)]		Emission Level [dB (uV)]		Limit [dB (uV)]		Margin (dB)	
			Q.P.	AV.	Q.P.	AV.	Q.P.	AV.	Q.P.	AV.
1	0.216	0.10	51.18	-	51.28	-	62.96	52.96	-11.68	-
2	0.447	0.10	41.89	-	41.99	-	56.93	46.93	-14.94	-
3	0.556	0.10	40.59	-	40.69	-	56.00	46.00	-15.31	-
4	0.666	0.10	38.59	-	38.69	-	56.00	46.00	-17.31	-
5	0.783	0.10	42.41	-	42.51	-	56.00	46.00	-13.49	-
6	0.892	0.10	41.54	-	41.64	-	56.00	46.00	-14.36	-
7	1.012	0.10	36.81	-	36.91	-	56.00	46.00	-19.09	-
8	1.906	0.19	34.91	-	35.10	-	56.00	46.00	-20.90	-
9	14.879	0.53	24.60	-	25.13	-	60.00	50.00	-34.87	-

- REMARKS:**
1. Q.P. and AV. are abbreviations of quasi-peak and average individually.
 2. "-": The Quasi-peak reading value also meets average limit and measurement with the average detector is unnecessary.
 3. The emission levels of other frequencies were very low against the limit.
 4. Margin value = Emission level - Limit value
 5. Correction factor = Insertion loss + Cable loss
 6. Emission Level = Correction Factor + Reading Value.

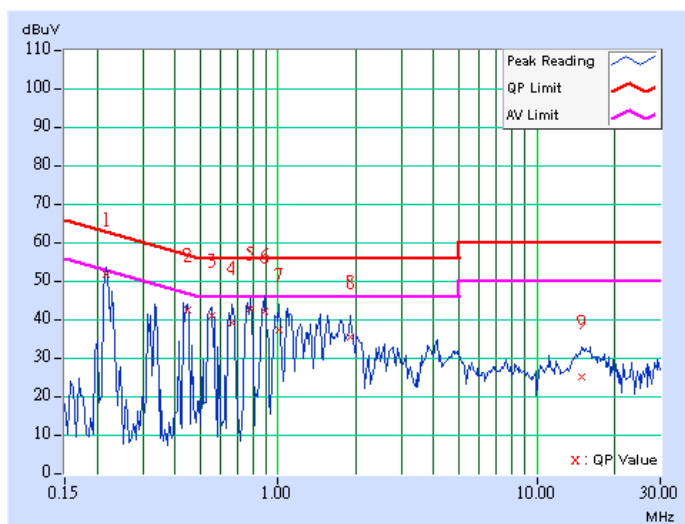

FOR POE MODE:

EUT TEST CONDITION		MEASUREMENT DETAIL	
CHANNEL	Channel 1	PHASE	Line 1
MODULATION TYPE	BPSK	6dB BANDWIDTH	9 kHz
TRANSFER RATE	6Mbps	ENVIRONMENTAL CONDITIONS	23deg. C, 65%RH, 991hPa
TESTED BY	Whisky Chang	INPUT POWER (SYSTEM)	120Vac, 60 Hz
TEST MODE	B		

No	Freq. [MHz]	Corr. Factor [dB]	Reading Value [dB (uV)]		Emission Level [dB (uV)]		Limit [dB (uV)]		Margin (dB)	
			Q.P.	AV.	Q.P.	AV.	Q.P.	AV.	Q.P.	AV.
			1	0.293	0.10	45.94	-	46.04	-	60.43
2	0.585	0.10	45.23	-	45.33	-	56.00	46.00	-10.67	-
3	1.168	0.10	42.78	-	42.88	-	56.00	46.00	-13.12	-
4	16.230	0.95	44.82	-	45.77	-	60.00	50.00	-14.23	-
5	18.246	0.99	46.37	-	47.36	-	60.00	50.00	-12.64	-
6	19.711	1.02	45.92	-	46.94	-	60.00	50.00	-13.06	-
7	21.664	1.06	46.85	-	47.91	-	60.00	50.00	-12.09	-
8	23.129	1.09	49.41	47.31	50.50	48.40	60.00	50.00	-9.50	-1.60
9	26.611	1.13	47.11	-	48.24	-	60.00	50.00	-11.76	-
10	28.688	1.13	45.26	-	46.39	-	60.00	50.00	-13.61	-

- REMARKS:**
1. Q.P. and AV. are abbreviations of quasi-peak and average individually.
 2. "-": The Quasi-peak reading value also meets average limit and measurement with the average detector is unnecessary.
 3. The emission levels of other frequencies were very low against the limit.
 4. Margin value = Emission level - Limit value
 5. Correction factor = Insertion loss + Cable loss
 6. Emission Level = Correction Factor + Reading Value.

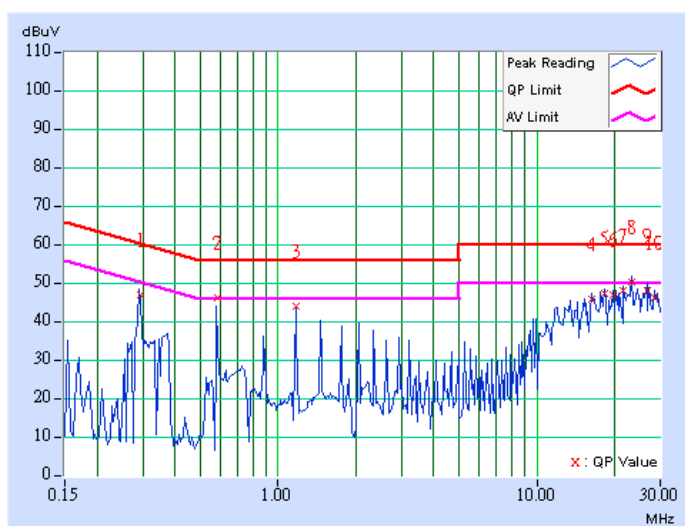

EUT TEST CONDITION		MEASUREMENT DETAIL	
CHANNEL	Channel 1	PHASE	Line 2
MODULATION TYPE	BPSK	6dB BANDWIDTH	9 kHz
TRANSFER RATE	6Mbps	ENVIRONMENTAL CONDITIONS	23deg. C, 65%RH, 991hPa
TESTED BY	Whisky Chang	INPUT POWER (SYSTEM)	120Vac, 60 Hz
TEST MODE	B		

No	Freq. [MHz]	Corr. Factor (dB)	Reading Value		Emission Level		Limit		Margin	
			[dB (uV)]		[dB (uV)]		[dB (uV)]		(dB)	
			Q.P.	AV.	Q.P.	AV.	Q.P.	AV.	Q.P.	AV.
1	0.291	0.10	46.99	-	47.09	-	60.51	50.51	-13.42	-
2	0.584	0.10	46.03	39.35	46.13	39.45	56.00	46.00	-9.87	-6.55
3	1.165	0.10	44.51	-	44.61	-	56.00	46.00	-11.39	-
4	1.457	0.10	41.66	-	41.76	-	56.00	46.00	-14.24	-
5	11.953	0.57	41.32	-	41.89	-	60.00	50.00	-18.11	-
6	18.246	0.73	45.57	-	46.30	-	60.00	50.00	-13.70	-
7	19.711	0.73	45.42	-	46.15	-	60.00	50.00	-13.85	-
8	21.664	0.76	46.63	-	47.39	-	60.00	50.00	-12.61	-
9	23.130	0.79	49.33	46.98	50.12	47.77	60.00	50.00	-9.88	-2.23
10	26.609	0.80	46.61	-	47.41	-	60.00	50.00	-12.59	-

- REMARKS:**
1. Q.P. and AV. are abbreviations of quasi-peak and average individually.
 2. "-": The Quasi-peak reading value also meets average limit and measurement with the average detector is unnecessary.
 3. The emission levels of other frequencies were very low against the limit.
 4. Margin value = Emission level - Limit value
 5. Correction factor = Insertion loss + Cable loss
 6. Emission Level = Correction Factor + Reading Value.

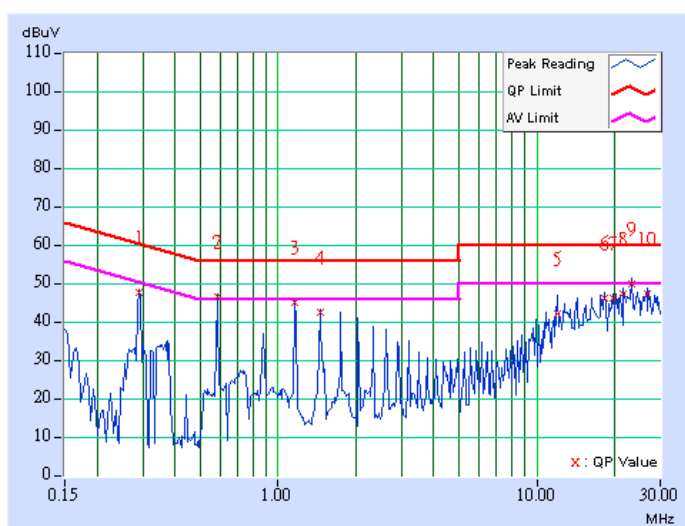

EUT TEST CONDITION		MEASUREMENT DETAIL	
CHANNEL	Channel 6	PHASE	Line 1
MODULATION TYPE	BPSK	6dB BANDWIDTH	9 kHz
TRANSFER RATE	6Mbps	ENVIRONMENTAL CONDITIONS	23deg. C, 65%RH, 991hPa
TESTED BY	Whisky Chang	INPUT POWER (SYSTEM)	120Vac, 60 Hz
TEST MODE	B		

No	Freq. [MHz]	Corr. Factor (dB)	Reading Value [dB (uV)]		Emission Level [dB (uV)]		Limit [dB (uV)]		Margin (dB)	
			Q.P.	AV.	Q.P.	AV.	Q.P.	AV.	Q.P.	AV.
1	0.291	0.10	46.22	-	46.32	-	60.51	50.51	-14.19	-
2	0.581	0.10	45.55	-	45.65	-	56.00	46.00	-10.35	-
3	1.160	0.10	42.36	-	42.46	-	56.00	46.00	-13.54	-
4	13.418	0.81	42.85	-	43.66	-	60.00	50.00	-16.34	-
5	16.230	0.95	44.84	-	45.79	-	60.00	50.00	-14.21	-
6	18.246	0.99	46.37	-	47.36	-	60.00	50.00	-12.64	-
7	19.711	1.02	45.92	-	46.94	-	60.00	50.00	-13.06	-
8	21.664	1.06	46.83	-	47.89	-	60.00	50.00	-12.11	-
9	23.129	1.09	49.39	47.31	50.48	48.40	60.00	50.00	-9.52	-1.60
10	26.609	1.13	46.85	-	47.98	-	60.00	50.00	-12.02	-

- REMARKS:**
1. Q.P. and AV. are abbreviations of quasi-peak and average individually.
 2. "-": The Quasi-peak reading value also meets average limit and measurement with the average detector is unnecessary.
 3. The emission levels of other frequencies were very low against the limit.
 4. Margin value = Emission level - Limit value
 5. Correction factor = Insertion loss + Cable loss
 6. Emission Level = Correction Factor + Reading Value.

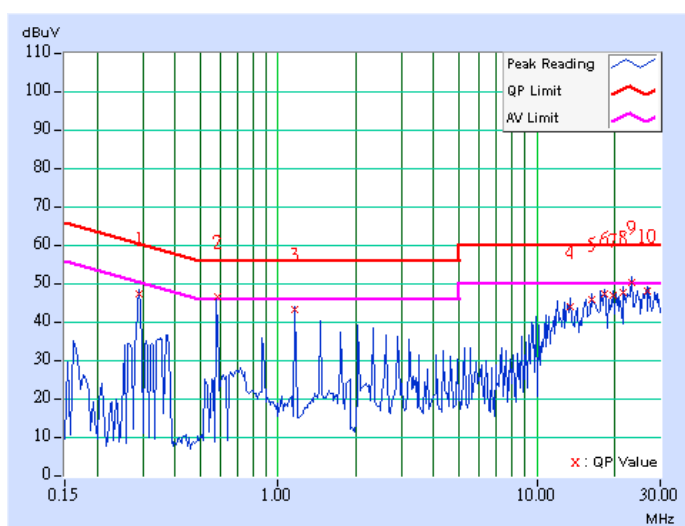

EUT TEST CONDITION		MEASUREMENT DETAIL	
CHANNEL	Channel 6	PHASE	Line 2
MODULATION TYPE	BPSK	6dB BANDWIDTH	9 kHz
TRANSFER RATE	6Mbps	ENVIRONMENTAL CONDITIONS	23deg. C, 65%RH, 991hPa
TESTED BY	Whisky Chang	INPUT POWER (SYSTEM)	120Vac, 60 Hz
TEST MODE	B		

No	Freq. [MHz]	Corr. Factor (dB)	Reading Value [dB (uV)]		Emission Level [dB (uV)]		Limit [dB (uV)]		Margin (dB)	
			Q.P.	AV.	Q.P.	AV.	Q.P.	AV.	Q.P.	AV.
1	0.291	0.10	46.99	-	47.09	-	60.51	50.51	-13.42	-
2	0.584	0.10	45.71	-	45.81	-	56.00	46.00	-10.19	-
3	1.164	0.10	44.47	-	44.57	-	56.00	46.00	-11.43	-
4	1.746	0.10	40.93	-	41.03	-	56.00	46.00	-14.97	-
5	11.957	0.57	42.29	-	42.86	-	60.00	50.00	-17.14	-
6	18.246	0.73	45.57	-	46.30	-	60.00	50.00	-13.70	-
7	21.664	0.76	46.59	-	47.35	-	60.00	50.00	-12.65	-
8	23.130	0.79	49.27	46.90	50.06	47.69	60.00	50.00	-9.94	-2.31
9	26.609	0.80	46.57	-	47.37	-	60.00	50.00	-12.63	-

- REMARKS:**
1. Q.P. and AV. are abbreviations of quasi-peak and average individually.
 2. "-": The Quasi-peak reading value also meets average limit and measurement with the average detector is unnecessary.
 3. The emission levels of other frequencies were very low against the limit.
 4. Margin value = Emission level - Limit value
 5. Correction factor = Insertion loss + Cable loss
 6. Emission Level = Correction Factor + Reading Value.

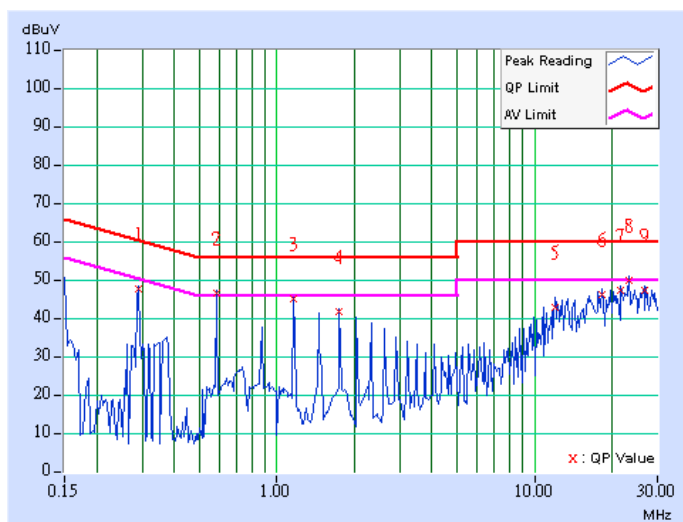

EUT TEST CONDITION		MEASUREMENT DETAIL	
CHANNEL	Channel 11	PHASE	Line 1
MODULATION TYPE	BPSK	6dB BANDWIDTH	9 kHz
TRANSFER RATE	6Mbps	ENVIRONMENTAL CONDITIONS	23deg. C, 65%RH, 991hPa
TESTED BY	Whisky Chang	INPUT POWER (SYSTEM)	120Vac, 60 Hz
TEST MODE	B		

No	Freq. [MHz]	Corr. Factor (dB)	Reading Value		Emission Level		Limit		Margin	
			[dB (uV)]		[dB (uV)]		[dB (uV)]		(dB)	
			Q.P.	AV.	Q.P.	AV.	Q.P.	AV.	Q.P.	AV.
1	0.291	0.10	46.14	-	46.24	-	60.51	50.51	-14.27	-
2	0.580	0.10	45.39	-	45.49	-	56.00	46.00	-10.51	-
3	1.164	0.10	42.40	-	42.50	-	56.00	46.00	-13.50	-
4	11.953	0.70	42.41	-	43.11	-	60.00	50.00	-16.89	-
5	13.418	0.81	41.50	-	42.31	-	60.00	50.00	-17.69	-
6	18.246	0.99	46.35	-	47.34	-	60.00	50.00	-12.66	-
7	21.664	1.06	46.79	-	47.85	-	60.00	50.00	-12.15	-
8	23.129	1.09	49.37	47.23	50.46	48.32	60.00	50.00	-9.54	-1.68
9	26.609	1.13	46.83	-	47.96	-	60.00	50.00	-12.04	-
10	28.688	1.13	45.24	-	46.37	-	60.00	50.00	-13.63	-

- REMARKS:**
1. Q.P. and AV. are abbreviations of quasi-peak and average individually.
 2. "-": The Quasi-peak reading value also meets average limit and measurement with the average detector is unnecessary.
 3. The emission levels of other frequencies were very low against the limit.
 4. Margin value = Emission level - Limit value
 5. Correction factor = Insertion loss + Cable loss
 6. Emission Level = Correction Factor + Reading Value.

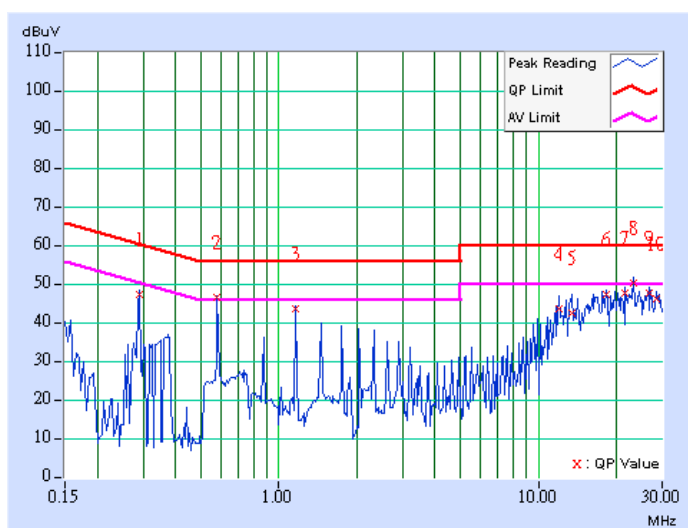

EUT TEST CONDITION		MEASUREMENT DETAIL	
CHANNEL	Channel 11	PHASE	Line 2
MODULATION TYPE	BPSK	6dB BANDWIDTH	9 kHz
TRANSFER RATE	6Mbps	ENVIRONMENTAL CONDITIONS	23deg. C, 65%RH, 991hPa
TESTED BY	Whisky Chang	INPUT POWER (SYSTEM)	120Vac, 60 Hz
TEST MODE	B		

No	Freq. [MHz]	Corr. Factor (dB)	Reading Value [dB (uV)]		Emission Level [dB (uV)]		Limit [dB (uV)]		Margin (dB)	
			Q.P.	AV.	Q.P.	AV.	Q.P.	AV.	Q.P.	AV.
1	0.291	0.10	46.57	-	46.67	-	60.51	50.51	-13.84	-
2	0.580	0.10	45.45	-	45.55	-	56.00	46.00	-10.45	-
3	1.160	0.10	43.79	-	43.89	-	56.00	46.00	-12.11	-
4	1.453	0.10	41.14	-	41.24	-	56.00	46.00	-14.76	-
5	11.953	0.57	41.84	-	42.41	-	60.00	50.00	-17.59	-
6	16.531	0.73	40.86	-	41.59	-	60.00	50.00	-18.41	-
7	18.246	0.73	45.75	-	46.48	-	60.00	50.00	-13.52	-
8	20.258	0.74	44.80	-	45.54	-	60.00	50.00	-14.46	-
9	21.664	0.76	46.04	-	46.80	-	60.00	50.00	-13.20	-
10	23.129	0.79	48.56	-	49.35	-	60.00	50.00	-10.65	-
11	26.488	0.80	45.90	-	46.70	-	60.00	50.00	-13.30	-

- REMARKS:**
1. Q.P. and AV. are abbreviations of quasi-peak and average individually.
 2. "-": The Quasi-peak reading value also meets average limit and measurement with the average detector is unnecessary.
 3. The emission levels of other frequencies were very low against the limit.
 4. Margin value = Emission level - Limit value
 5. Correction factor = Insertion loss + Cable loss
 6. Emission Level = Correction Factor + Reading Value.

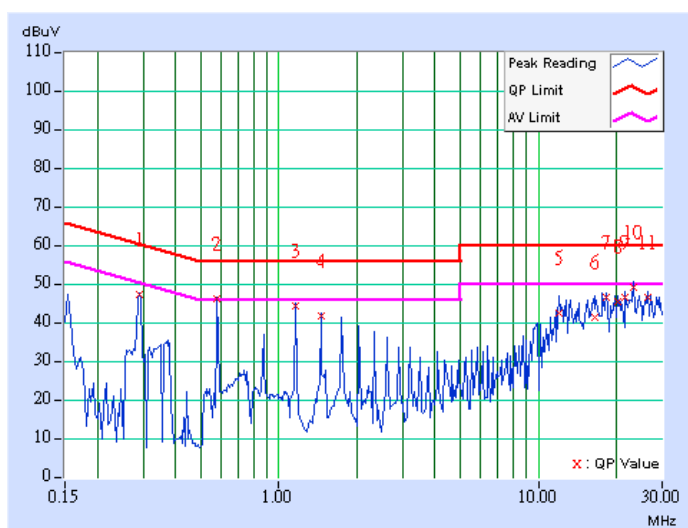

4.2 RADIATED EMISSION MEASUREMENT

4.2.1 LIMITS OF RADIATED EMISSION MEASUREMENT

Emissions radiated outside of the specified bands, shall be according to the general radiated limits in 15.209 as following:

FREQUENCIES (MHz)	FIELD STRENGTH (microvolts/meter)	MEASUREMENT DISTANCE (meters)
0.009 ~ 0.490	2400/F(kHz)	300
0.490 ~ 1.705	24000/F(kHz)	30
1.705 ~ 30.0	30	30
30 ~ 88	100	3
88 ~ 216	150	3
216 ~ 960	200	3
Above 960	500	3

NOTE:

1. The lower limit shall apply at the transition frequencies.
2. Emission level (dBuV/m) = 20 log Emission level (uV/m).
3. As shown in 15.35(b), for frequencies above 1000MHz, the field strength limits are based on average detector, however, the peak field strength of any emission shall not exceed the maximum permitted average limits, specified above by more than 20dB under any condition of modulation.



4.2.2 TEST INSTRUMENTS

DESCRIPTION & MANUFACTURER	MODEL NO.	SERIAL NO.	CALIBRATED UNTIL
Test Receiver ROHDE & SCHWARZ	ESI7	100033	May. 23, 2006
Spectrum Analyzer ROHDE & SCHWARZ	FSP40	100025	Dec. 05, 2006
BILOG Antenna SCHWARZBECK	VULB9168	9168-160	Jun. 01, 2006
HORN Antenna SCHWARZBECK	9120D	9120D-408	Jan. 08, 2007
HORN Antenna SCHWARZBECK	BBHA 9170	BBHA9170243	Jan. 19, 2007
Preamplifier Agilent	8447D	2944A10633	Nov. 04, 2006
Preamplifier Agilent	8449B	3008A01964	Oct. 30, 2006
RF signal cable HUBER+SUHNNER	SUCOFLEX 104	214377/4	Dec. 13, 2006
RF signal cable HUBER+SUHNNER	SUCOFLEX 104	219272/4	Dec. 13, 2006
Software ADT.	ADT_Radiated_V5.14	NA	NA
Antenna Tower inn-co GmbH	MA 4000	013303	NA
Antenna Tower Controller inn-co GmbH	CO2000	017303	NA
Turn Table ADT.	TT100.	TT93021703	NA
Turn Table Controller ADT.	SC100.	SC93021703	NA

- NOTE:**
1. The calibration interval of the above test instruments is 12 months and the calibrations are traceable to NML/ROC and NIST/USA.
 2. The test was performed in HwaYa Chamber 2.
 3. The horn antenna and HP preamplifier (model: 8449B) are used only for the measurement of emission frequency above 1GHz if tested.
 4. The VCCI Site Registration No. is R-237.
 5. The IC Site Registration No. is IC4924-3.

4.2.3 TEST PROCEDURES

- a. The EUT was placed on the top of a rotating table 0.8 meters above the ground at a 3 meter semi-anechoic chamber. The table was rotated 360 degrees to determine the position of the highest radiation.
- b. The EUT was set 3 meters away from the interference-receiving antenna, which was mounted on the top of a variable-height antenna tower.
- c. The antenna is a broadband antenna, and its height is varied from one meter to four meters above the ground to determine the maximum value of the field strength. Both horizontal and vertical polarizations of the antenna are set to make the measurement.
- d. For each suspected emission, the EUT was arranged to its worst case and then the antenna was tuned to heights from 1 meter to 4 meters and the rotatable table was turned from 0 degrees to 360 degrees to find the maximum reading.
- e. The test-receiver system was set to Peak Detect Function and Specified Bandwidth with Maximum Hold Mode.
- f. If the emission level of the EUT in peak mode was lower than the limit specified, then testing could be stopped and the peak values of the EUT would be reported. Otherwise the emissions would be re-tested one by one using peak, quasi-peak method or average method as specified and then reported in data sheet.

NOTE:

1. The resolution bandwidth and video bandwidth of test receiver/spectrum analyzer is 120kHz for Quasi-peak detection at frequency below 1GHz.
2. The resolution bandwidth and video bandwidth of test receiver/spectrum analyzer is 1 MHz for Peak detection (PK) at frequency above 1GHz.
3. The resolution bandwidth of test receiver/spectrum analyzer is 1 MHz and the video bandwidth is 10 Hz for Average detection (AV) at frequency above 1GHz.

4.2.4 DEVIATION FROM TEST STANDARD

No deviation

4.2.5 TEST SETUP

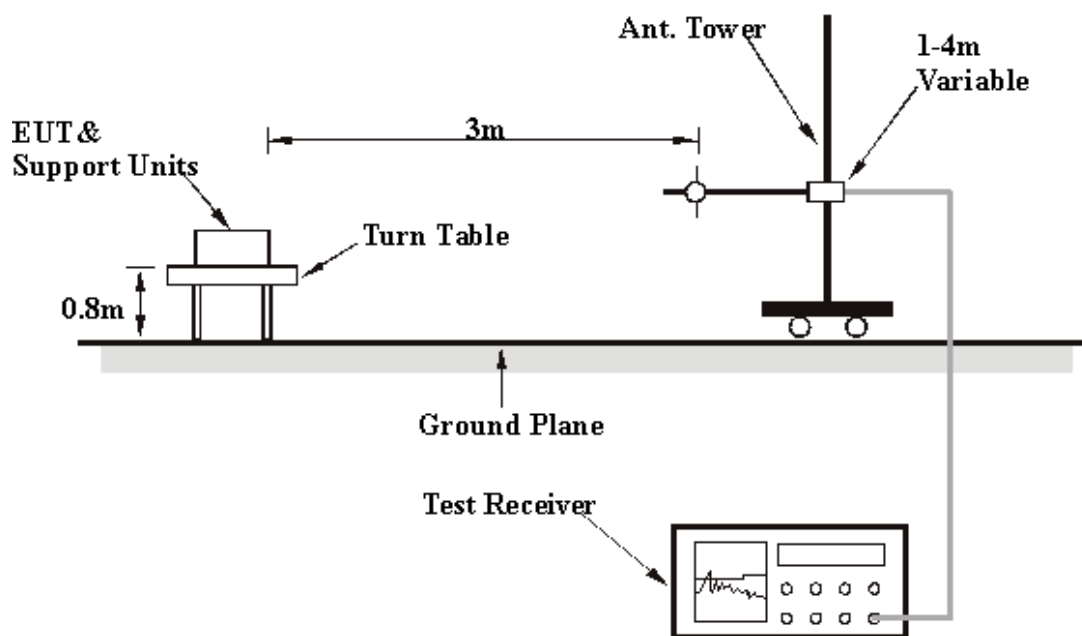

For the actual test configuration, please refer to the related item – Photographs of the Test Configuration.

4.2.6 EUT OPERATING CONDITIONS

Same as 4.1.6

4.2.7 TEST RESULTS

RADIATED WORST-CASE DATA: BELOW 1GHZ

For Adapter mode:

EUT TEST CONDITION		MEASUREMENT DETAIL	
CHANNEL	Channel 11	FREQUENCY RANGE	Below 1000MHz
MODULATION TYPE	BPSK	DETECTOR FUNCTION	Quasi-Peak
TRANSFER RATE	6Mbps	ENVIRONMENTAL CONDITIONS	25deg. C, 68%RH, 991hPa
TESTED BY	Morgan Chen	INPUT POWER (SYSTEM)	120Vac, 60 Hz
TEST MODE	A		

ANTENNA POLARITY & TEST DISTANCE: HORIZONTAL AT 3 M								
No.	Freq. (MHz)	Emission Level (dBuV/m)	Limit (dBuV/m)	Margin (dB)	Antenna Height (m)	Table Angle (Degree)	Raw Value (dBuV)	Correction Factor (dB/m)
1	47.49	27.22 QP	40.00	-12.78	1.00 H	247	12.67	14.56
2	142.75	26.27 QP	43.50	-17.23	1.00 H	154	12.91	13.35
3	183.57	34.13 QP	43.50	-9.37	1.00 H	127	22.16	11.98
4	249.66	37.82 QP	46.00	-8.18	1.00 H	127	25.16	12.66
5	274.93	33.20 QP	46.00	-12.80	1.00 H	154	18.60	14.60
6	368.24	30.76 QP	46.00	-15.24	1.25 H	40	13.49	17.27
7	459.60	28.34 QP	46.00	-17.66	1.25 H	43	8.91	19.43
8	624.83	33.68 QP	46.00	-12.32	1.25 H	43	10.33	23.35
9	720.08	28.39 QP	46.00	-17.61	1.00 H	196	3.29	25.10
10	751.18	38.93 QP	46.00	-7.07	1.00 H	196	12.64	26.30
11	828.94	34.54 QP	46.00	-11.46	1.00 H	154	7.60	26.94
12	854.21	28.34 QP	46.00	-17.66	1.25 H	40	1.17	27.17
13	920.30	30.27 QP	46.00	-15.73	1.00 H	262	2.38	27.89

- REMARKS:**
1. Emission level(dBuV/m)=Raw Value(dBuV) + Correction Factor(dB/m)
 2. Correction Factor(dB/m) = Antenna Factor (dB/m) + Cable Factor (dB)
 3. The other emission levels were very low against the limit.
 4. Margin value = Emission level – Limit value.

EUT TEST CONDITION		MEASUREMENT DETAIL	
CHANNEL	Channel 11	FREQUENCY RANGE	Below 1000MHz
MODULATION TYPE	BPSK	DETECTOR FUNCTION	Quasi-Peak
TRANSFER RATE	6Mbps	ENVIRONMENTAL CONDITIONS	25deg. C, 68%RH, 991hPa
TESTED BY	Morgan Chen	INPUT POWER (SYSTEM)	120Vac, 60 Hz
TEST MODE	A		

ANTENNA POLARITY & TEST DISTANCE: VERTICAL AT 3 M								
No.	Freq. (MHz)	Emission Level (dBuV/m)	Limit (dBuV/m)	Margin (dB)	Antenna Height (m)	Table Angle (Degree)	Raw Value (dBuV)	Correction Factor (dB/m)
1	47.49	38.20 QP	40.00	-1.80	4.00 V	355	23.64	14.56
2	63.05	30.22 QP	40.00	-9.78	4.00 V	316	17.09	13.13
3	142.75	25.84 QP	43.50	-17.66	4.00 V	4	12.49	13.35
4	183.57	26.13 QP	43.50	-17.37	4.00 V	292	14.15	11.98
5	249.66	29.32 QP	46.00	-16.68	4.00 V	292	16.66	12.66
6	368.24	28.46 QP	46.00	-17.54	4.00 V	277	11.19	17.27
7	624.83	29.60 QP	46.00	-16.40	4.00 V	316	6.25	23.35
8	751.18	33.72 QP	46.00	-12.28	4.00 V	124	7.42	26.30
9	828.94	30.09 QP	46.00	-15.91	4.00 V	4	3.16	26.94
10	875.59	29.06 QP	46.00	-16.94	4.00 V	124	1.70	27.36
11	945.57	29.52 QP	46.00	-16.48	4.00 V	283	1.25	28.27

- REMARKS:**
1. Emission level(dBuV/m)=Raw Value(dBuV) + Correction Factor(dB/m)
 2. Correction Factor(dB/m) = Antenna Factor (dB/m) + Cable Factor (dB)
 3. The other emission levels were very low against the limit.
 4. Margin value = Emission level – Limit value.

For POE mode:

EUT TEST CONDITION		MEASUREMENT DETAIL	
CHANNEL	Channel 11	FREQUENCY RANGE	Below 1000MHz
MODULATION TYPE	BPSK	DETECTOR FUNCTION	Quasi-Peak
TRANSFER RATE	6Mbps	ENVIRONMENTAL CONDITIONS	25deg. C, 68%RH, 991hPa
TESTED BY	Morgan Chen	INPUT POWER (SYSTEM)	120Vac, 60 Hz
TEST MODE	B		

ANTENNA POLARITY & TEST DISTANCE: HORIZONTAL AT 3 M								
No.	Freq. (MHz)	Emission Level (dBuV/m)	Limit (dBuV/m)	Margin (dB)	Antenna Height (m)	Table Angle (Degree)	Raw Value (dBuV)	Correction Factor (dB/m)
1	33.89	25.57 QP	40.00	-14.43	1.25 H	226	12.53	13.04
2	84.43	26.56 QP	40.00	-13.44	1.00 H	211	16.62	9.94
3	156.35	29.85 QP	43.50	-13.65	1.25 H	106	16.14	13.71
4	183.57	30.79 QP	43.50	-12.71	1.00 H	211	18.82	11.98
5	249.66	43.18 QP	46.00	-2.82	1.00 H	211	30.52	12.66
6	274.93	32.72 QP	46.00	-13.28	1.00 H	295	18.12	14.60
7	352.69	33.02 QP	46.00	-12.98	1.25 H	163	16.25	16.77
8	360.46	37.33 QP	46.00	-8.67	1.00 H	250	20.31	17.02
9	399.34	31.22 QP	46.00	-14.78	1.00 H	235	12.94	18.28
10	500.42	33.87 QP	46.00	-12.13	1.25 H	238	13.39	20.48
11	644.27	31.79 QP	46.00	-14.21	1.25 H	184	8.29	23.50
12	751.18	42.10 QP	46.00	-3.90	1.25 H	115	15.80	26.30
13	768.68	32.12 QP	46.00	-13.88	1.00 H	256	5.69	26.43
14	825.05	31.41 QP	46.00	-14.59	1.00 H	235	4.51	26.90
15	875.59	31.34 QP	46.00	-14.66	1.25 H	115	3.98	27.36
16	920.30	31.68 QP	46.00	-14.32	1.00 H	28	3.79	27.89

- REMARKS:**
1. Emission level(dBuV/m)=Raw Value(dBuV) + Correction Factor(dB/m)
 2. Correction Factor(dB/m) = Antenna Factor (dB/m) + Cable Factor (dB)
 3. The other emission levels were very low against the limit.
 4. Margin value = Emission level – Limit value.

EUT TEST CONDITION		MEASUREMENT DETAIL	
CHANNEL	Channel 11	FREQUENCY RANGE	Below 1000MHz
MODULATION TYPE	BPSK	DETECTOR FUNCTION	Quasi-Peak
TRANSFER RATE	6Mbps	ENVIRONMENTAL CONDITIONS	25deg. C, 68%RH, 991hPa
TESTED BY	Morgan Chen	INPUT POWER (SYSTEM)	120Vac, 60 Hz
TEST MODE	B		

ANTENNA POLARITY & TEST DISTANCE: VERTICAL AT 3 M								
No.	Freq. (MHz)	Emission Level (dBuV/m)	Limit (dBuV/m)	Margin (dB)	Antenna Height (m)	Table Angle (Degree)	Raw Value (dBuV)	Correction Factor (dB/m)
1	33.89	38.95 QP	40.00	-1.05	1.00 V	325	25.91	13.04
2	68.88	38.45 QP	40.00	-1.55	1.00 V	79	25.98	12.47
3	101.92	37.55 QP	43.50	-5.95	1.00 V	79	28.03	9.52
4	133.03	38.07 QP	43.50	-5.43	1.00 V	325	25.54	12.53
5	177.74	33.50 QP	43.50	-10.00	1.00 V	328	21.17	12.34
6	195.23	32.66 QP	43.50	-10.84	1.00 V	283	21.26	11.40
7	249.66	37.70 QP	46.00	-8.30	1.00 V	136	25.04	12.66
8	399.34	36.84 QP	46.00	-9.16	1.00 V	79	18.57	18.28
9	500.42	34.86 QP	46.00	-11.14	1.00 V	292	14.38	20.48
10	599.56	34.30 QP	46.00	-11.70	1.00 V	292	11.16	23.13
11	751.18	40.85 QP	46.00	-5.15	1.00 V	73	14.55	26.30
12	768.68	34.65 QP	46.00	-11.35	1.00 V	328	8.22	26.43

- REMARKS:**
1. Emission level(dBuV/m)=Raw Value(dBuV) + Correction Factor(dB/m)
 2. Correction Factor(dB/m) = Antenna Factor (dB/m) + Cable Factor (dB)
 3. The other emission levels were very low against the limit.
 4. Margin value = Emission level – Limit value.

802.11b DSSS MODULATION (DIPOLE ANTENNA)

EUT TEST CONDITION		MEASUREMENT DETAIL	
CHANNEL	Channel 1	FREQUENCY RANGE	1 ~ 25GHz
MODULATION TYPE	DBPSK	DETECTOR FUNCTION	Peak (PK) Average (AV)
TRANSFER RATE	1Mbps	ENVIRONMENTAL CONDITIONS	25deg. C, 68%RH, 991hPa
TESTED BY	Morgan Chen	INPUT POWER (SYSTEM)	120Vac, 60 Hz
TEST MODE	B		

ANTENNA POLARITY & TEST DISTANCE: HORIZONTAL AT 3 M								
No.	Freq. (MHz)	Emission Level (dBuV/m)	Limit (dBuV/m)	Margin (dB)	Antenna Height (m)	Table Angle (Degree)	Raw Value (dBuV)	Correction Factor (dB/m)
1	2386.00	58.98 PK	74.00	-15.02	1.02 H	182	27.09	31.89
2	2386.00	48.85 AV	54.00	-5.15	1.02 H	182	16.96	31.89
3	*2412.00	103.85 PK			1.03 H	189	71.81	32.04
4	*2412.00	99.80 AV			1.03 H	189	67.76	32.04
5	3216.00	46.58 PK	83.85	-37.27	1.07 H	315	13.03	33.55
6	3216.00	40.52 AV	79.80	-39.28	1.07 H	315	6.97	33.55
7	4824.00	48.59 PK	74.00	-25.41	1.07 H	315	11.08	37.51
8	4824.00	42.45 AV	54.00	-11.55	1.07 H	315	4.94	37.51

ANTENNA POLARITY & TEST DISTANCE: VERTICAL AT 3 M								
No.	Freq. (MHz)	Emission Level (dBuV/m)	Limit (dBuV/m)	Margin (dB)	Antenna Height (m)	Table Angle (Degree)	Raw Value (dBuV)	Correction Factor (dB/m)
1	2386.00	62.44 PK	74.00	-11.56	1.07 V	12	30.55	31.89
2	2386.00	52.15 AV	54.00	-1.85	1.07 V	12	20.26	31.89
3	*2412.00	111.28 PK			1.08 V	211	79.24	32.04
4	*2412.00	107.26 AV			1.08 V	211	75.22	32.04
5	3216.00	47.62 PK	91.28	-43.66	1.06 V	128	14.07	33.55
6	3216.00	41.58 AV	87.26	-45.68	1.06 V	128	8.03	33.55
7	4824.00	49.85 PK	74.00	-24.15	1.09 V	325	12.34	37.51
8	4824.00	43.46 AV	54.00	-10.54	1.09 V	325	5.95	37.51

- REMARKS:**
1. Emission level (dBuV/m) = Raw Value (dBuV) + Correction Factor (dB/m).
 2. Correction Factor (dB/m) = Antenna Factor (dB/m) + Cable Factor (dB).
 3. The other emission levels were very low against the limit.
 4. Margin value = Emission level – Limit value.
 5. “ * “: Fundamental frequency.

EUT TEST CONDITION		MEASUREMENT DETAIL	
CHANNEL	Channel 6	FREQUENCY RANGE	1 ~ 25GHz
MODULATION TYPE	DBPSK	DETECTOR FUNCTION	Peak (PK) Average (AV)
TRANSFER RATE	1Mbps	ENVIRONMENTAL CONDITIONS	25deg. C, 68%RH, 991hPa
TESTED BY	Morgan Chen	INPUT POWER (SYSTEM)	120Vac, 60 Hz
TEST MODE	B		

ANTENNA POLARITY & TEST DISTANCE: HORIZONTAL AT 3 M								
No.	Freq. (MHz)	Emission Level (dBuV/m)	Limit (dBuV/m)	Margin (dB)	Antenna Height (m)	Table Angle (Degree)	Raw Value (dBuV)	Correction Factor (dB/m)
1	*2437.00	105.88 PK			1.03 H	25	73.68	32.20
2	*2437.00	101.85 AV			1.03 H	25	69.65	32.20
3	3248.00	46.59 PK	85.88	-39.29	1.03 H	124	12.95	33.64
4	3248.00	40.48 AV	81.85	-41.37	1.03 H	124	6.84	33.64
5	4874.00	49.38 PK	74.00	-24.62	1.05 H	325	11.83	37.55
6	4874.00	42.79 AV	54.00	-11.21	1.05 H	325	5.24	37.55

ANTENNA POLARITY & TEST DISTANCE: VERTICAL AT 3 M								
No.	Freq. (MHz)	Emission Level (dBuV/m)	Limit (dBuV/m)	Margin (dB)	Antenna Height (m)	Table Angle (Degree)	Raw Value (dBuV)	Correction Factor (dB/m)
1	*2437.00	113.45 PK			1.09 V	12	81.25	32.20
2	*2437.00	109.43 AV			1.09 V	12	77.23	32.20
3	3248.00	47.65 PK	93.45	-45.80	1.07 V	128	14.01	33.64
4	3248.00	41.55 AV	89.43	-47.88	1.07 V	128	7.91	33.64
5	4874.00	50.45 PK	74.00	-23.55	1.00 V	336	12.90	37.55
6	4874.00	43.81 AV	54.00	-10.19	1.00 V	336	6.26	37.55

- REMARKS:**
1. Emission level (dBuV/m) = Raw Value (dBuV) + Correction Factor (dB/m).
 2. Correction Factor (dB/m) = Antenna Factor (dB/m) + Cable Factor (dB).
 3. The other emission levels were very low against the limit.
 4. Margin value = Emission level – Limit value.
 5. “ * “: Fundamental frequency.

EUT TEST CONDITION		MEASUREMENT DETAIL	
CHANNEL	Channel 11	FREQUENCY RANGE	1 ~ 25GHz
MODULATION TYPE	DBPSK	DETECTOR FUNCTION	Peak (PK) Average (AV)
TRANSFER RATE	1Mbps	ENVIRONMENTAL CONDITIONS	25deg. C, 68%RH, 991hPa
TESTED BY	Morgan Chen	INPUT POWER (SYSTEM)	120Vac, 60 Hz
TEST MODE	B		

ANTENNA POLARITY & TEST DISTANCE: HORIZONTAL AT 3 M								
No.	Freq. (MHz)	Emission Level (dBuV/m)	Limit (dBuV/m)	Margin (dB)	Antenna Height (m)	Table Angle (Degree)	Raw Value (dBuV)	Correction Factor (dB/m)
1	*2462.00	103.78 PK			1.05 H	197	71.43	32.35
2	*2462.00	99.70 AV			1.05 H	197	67.35	32.35
3	2483.50	58.91 PK	74.00	-15.09	1.04 H	12	26.42	32.49
4	2483.50	48.82 AV	54.00	-5.18	1.04 H	12	16.33	32.49
5	2499.00	58.21 PK	74.00	-15.79	1.05 H	197	25.63	32.58
6	2499.00	48.65 AV	54.00	-5.35	1.05 H	197	16.07	32.58
7	3282.00	46.45 PK	83.78	-37.33	1.25 H	325	12.71	33.74
8	3282.00	40.45 AV	79.70	-39.25	1.25 H	325	6.71	33.74
9	4924.00	48.55 PK	74.00	-25.45	1.08 H	325	10.97	37.58
10	4924.00	42.41 AV	54.00	-11.59	1.08 H	325	4.83	37.58

ANTENNA POLARITY & TEST DISTANCE: VERTICAL AT 3 M								
No.	Freq. (MHz)	Emission Level (dBuV/m)	Limit (dBuV/m)	Margin (dB)	Antenna Height (m)	Table Angle (Degree)	Raw Value (dBuV)	Correction Factor (dB/m)
1	*2462.00	111.01 PK			1.07 V	209	78.66	32.35
2	*2462.00	106.92 AV			1.07 V	209	74.57	32.35
3	2483.50	62.35 PK	74.00	-11.65	1.08 V	15	29.86	32.49
4	2483.50	52.09 AV	54.00	-1.91	1.08 V	15	19.60	32.49
5	2499.00	63.84 PK	74.00	-10.16	1.10 V	26	31.26	32.58
6	2499.00	53.00 AV	54.00	-1.00	1.10 V	26	20.42	32.58
7	3282.00	47.56 PK	91.01	-43.45	1.08 V	135	13.82	33.74
8	3282.00	41.56 AV	86.92	-45.36	1.08 V	135	7.82	33.74
9	4924.00	49.99 PK	74.00	-24.01	1.11 V	339	12.41	37.58
10	4924.00	43.54 AV	54.00	-10.46	1.11 V	339	5.96	37.58

- REMARKS:**
1. Emission level (dBuV/m) = Raw Value (dBuV) + Correction Factor (dB/m).
 2. Correction Factor (dB/m) = Antenna Factor (dB/m) + Cable Factor (dB).
 3. The other emission levels were very low against the limit.
 4. Margin value = Emission level – Limit value.
 5. “ * “: Fundamental frequency.

802.11b DSSS MODULATION (PRINTED ANTENNA)

EUT TEST CONDITION		MEASUREMENT DETAIL	
CHANNEL	Channel 6	FREQUENCY RANGE	1 ~ 25GHz
MODULATION TYPE	DBPSK	DETECTOR FUNCTION	Peak (PK) Average (AV)
TRANSFER RATE	1Mbps	ENVIRONMENTAL CONDITIONS	25deg. C, 68%RH, 991hPa
TESTED BY	Morgan Chen	INPUT POWER (SYSTEM)	120Vac, 60 Hz
TEST MODE	C		

ANTENNA POLARITY & TEST DISTANCE: HORIZONTAL AT 3 M								
No.	Freq. (MHz)	Emission Level (dBuV/m)	Limit (dBuV/m)	Margin (dB)	Antenna Height (m)	Table Angle (Degree)	Raw Value (dBuV)	Correction Factor (dB/m)
1	*2437.00	110.89 PK			1.44 H	22	78.69	32.20
2	*2437.00	99.86 AV			1.44 H	22	67.66	32.20
3	3248.00	45.85 PK	90.89	-45.04	1.05 H	132	12.21	33.64
4	3248.00	39.62 AV	79.86	-40.24	1.05 H	132	5.98	33.64
5	4874.00	49.12 PK	74.00	-24.88	1.02 H	22	11.57	37.55
6	4874.00	42.55 AV	54.00	-11.45	1.02 H	22	5.00	37.55

ANTENNA POLARITY & TEST DISTANCE: VERTICAL AT 3 M								
No.	Freq. (MHz)	Emission Level (dBuV/m)	Limit (dBuV/m)	Margin (dB)	Antenna Height (m)	Table Angle (Degree)	Raw Value (dBuV)	Correction Factor (dB/m)
1	*2437.00	103.88 PK			1.03 V	25	71.68	32.20
2	*2437.00	99.85 AV			1.03 V	25	67.65	32.20
3	3248.00	44.59 PK	83.88	-39.29	1.03 V	124	10.95	33.64
4	3248.00	38.48 AV	79.85	-41.37	1.03 V	124	4.84	33.64
5	4874.00	47.38 PK	74.00	-26.62	1.05 V	325	9.83	37.55
6	4874.00	40.79 AV	54.00	-13.21	1.05 V	325	3.24	37.55

- REMARKS:**
1. Emission level (dBuV/m) = Raw Value (dBuV) + Correction Factor (dB/m).
 2. Correction Factor (dB/m) = Antenna Factor (dB/m) + Cable Factor (dB).
 3. The other emission levels were very low against the limit.
 4. Margin value = Emission level – Limit value.
 5. “ * “: Fundamental frequency.

802.11g OFDM MODULATION

EUT TEST CONDITION		MEASUREMENT DETAIL	
CHANNEL	Channel 1	FREQUENCY RANGE	1 ~ 25GHz
MODULATION TYPE	BPSK	DETECTOR FUNCTION	Peak (PK) Average (AV)
TRANSFER RATE	6Mbps	ENVIRONMENTAL CONDITIONS	25deg. C, 68%RH, 991hPa
TESTED BY	Morgan Chen	INPUT POWER (SYSTEM)	120Vac, 60 Hz
TEST MODE	B		

ANTENNA POLARITY & TEST DISTANCE: HORIZONTAL AT 3 M								
No.	Freq. (MHz)	Emission Level (dBuV/m)	Limit (dBuV/m)	Margin (dB)	Antenna Height (m)	Table Angle (Degree)	Raw Value (dBuV)	Correction Factor (dB/m)
1	2390.00	63.75 PK	74.00	-10.25	1.07 H	26	31.84	31.91
2	2390.00	47.96 AV	54.00	-6.04	1.07 H	26	16.05	31.91
3	*2412.00	106.35 PK			1.05 H	238	74.31	32.04
4	*2412.00	95.42 AV			1.05 H	238	63.38	32.04
5	3216.00	46.88 PK	86.35	-39.47	1.03 H	155	13.33	33.55
6	3216.00	40.45 AV	75.42	-34.97	1.03 H	155	6.90	33.55
7	4824.00	45.69 PK	74.00	-28.31	1.03 H	22	8.18	37.51
8	4824.00	33.52 AV	54.00	-20.48	1.03 H	22	-3.99	37.51

ANTENNA POLARITY & TEST DISTANCE: VERTICAL AT 3 M								
No.	Freq. (MHz)	Emission Level (dBuV/m)	Limit (dBuV/m)	Margin (dB)	Antenna Height (m)	Table Angle (Degree)	Raw Value (dBuV)	Correction Factor (dB/m)
1	2390.00	68.82 PK	74.00	-5.18	1.09 V	19	36.91	31.91
2	2390.00	52.81 AV	54.00	-1.19	1.09 V	19	20.90	31.91
3	*2412.00	111.37 PK			1.35 V	18	79.33	32.04
4	*2412.00	100.40 AV			1.35 V	18	68.36	32.04
5	3216.00	47.68 PK	91.37	-43.69	1.05 V	132	14.13	33.55
6	3216.00	41.59 AV	80.40	-38.81	1.05 V	132	8.04	33.55
7	4824.00	46.75 PK	74.00	-27.25	1.05 V	18	9.24	37.51
8	4824.00	34.66 AV	54.00	-19.34	1.05 V	18	-2.85	37.51

- REMARKS:**
1. Emission level (dBuV/m) = Raw Value (dBuV) + Correction Factor (dB/m).
 2. Correction Factor (dB/m) = Antenna Factor (dB/m) + Cable Factor (dB).
 3. The other emission levels were very low against the limit.
 4. Margin value = Emission level – Limit value.
 5. “ * “: Fundamental frequency.

EUT TEST CONDITION		MEASUREMENT DETAIL	
CHANNEL	Channel 6	FREQUENCY RANGE	1 ~ 25GHz
MODULATION TYPE	BPSK	DETECTOR FUNCTION	Peak (PK) Average (AV)
TRANSFER RATE	6Mbps	ENVIRONMENTAL CONDITIONS	25deg. C, 68%RH, 991hPa
TESTED BY	Morgan Chen	INPUT POWER (SYSTEM)	120Vac, 60 Hz
TEST MODE	B		

ANTENNA POLARITY & TEST DISTANCE: HORIZONTAL AT 3 M								
No.	Freq. (MHz)	Emission Level (dBuV/m)	Limit (dBuV/m)	Margin (dB)	Antenna Height (m)	Table Angle (Degree)	Raw Value (dBuV)	Correction Factor (dB/m)
1	*2437.00	107.86 PK			1.03 H	246	75.66	32.20
2	*2437.00	96.95 AV			1.03 H	246	64.75	32.20
3	3248.00	46.53 PK	87.86	-41.33	1.02 H	15	12.89	33.64
4	3248.00	34.49 AV	76.95	-42.46	1.02 H	15	0.85	33.64
5	4874.00	46.55 PK	74.00	-27.45	1.08 H	12	9.00	37.55
6	4874.00	33.62 AV	54.00	-20.38	1.08 H	12	-3.93	37.55

ANTENNA POLARITY & TEST DISTANCE: VERTICAL AT 3 M								
No.	Freq. (MHz)	Emission Level (dBuV/m)	Limit (dBuV/m)	Margin (dB)	Antenna Height (m)	Table Angle (Degree)	Raw Value (dBuV)	Correction Factor (dB/m)
1	*2437.00	112.89 PK			1.32 V	12	80.69	32.20
2	*2437.00	101.86 AV			1.32 V	12	69.66	32.20
3	3248.00	47.85 PK	92.89	-45.04	1.03 V	122	14.21	33.64
4	3248.00	41.62 AV	81.86	-40.24	1.03 V	122	7.98	33.64
5	4874.00	46.82 PK	74.00	-27.18	1.02 V	12	9.27	37.55
6	4874.00	34.75 AV	54.00	-19.25	1.02 V	12	-2.80	37.55

- REMARKS:**
1. Emission level (dBuV/m) = Raw Value (dBuV) + Correction Factor (dB/m).
 2. Correction Factor (dB/m) = Antenna Factor (dB/m) + Cable Factor (dB).
 3. The other emission levels were very low against the limit.
 4. Margin value = Emission level – Limit value.
 5. “ * “: Fundamental frequency.

EUT TEST CONDITION		MEASUREMENT DETAIL	
CHANNEL	Channel 11	FREQUENCY RANGE	1 ~ 25GHz
MODULATION TYPE	BPSK	DETECTOR FUNCTION	Peak (PK) Average (AV)
TRANSFER RATE	6Mbps	ENVIRONMENTAL CONDITIONS	25deg. C, 68%RH, 991hPa
TESTED BY	Morgan Chen	INPUT POWER (SYSTEM)	120Vac, 60 Hz
TEST MODE	B		

ANTENNA POLARITY & TEST DISTANCE: HORIZONTAL AT 3 M								
No.	Freq. (MHz)	Emission Level (dBuV/m)	Limit (dBuV/m)	Margin (dB)	Antenna Height (m)	Table Angle (Degree)	Raw Value (dBuV)	Correction Factor (dB/m)
1	*2462.00	106.42 PK			1.08 H	241	74.07	32.35
2	*2462.00	95.53 AV			1.08 H	241	63.18	32.35
3	2483.50	63.89 PK	74.00	-10.11	1.05 H	16	31.40	32.49
4	2483.50	47.99 AV	54.00	-6.01	1.05 H	16	15.50	32.49
5	3282.00	46.95 PK	86.42	-39.47	1.02 H	145	13.21	33.74
6	3282.00	40.52 AV	75.53	-35.01	1.02 H	145	6.78	33.74
7	4924.00	45.75 PK	74.00	-28.25	1.08 H	15	8.17	37.58
8	4924.00	33.62 AV	54.00	-20.38	1.08 H	15	-3.96	37.58

ANTENNA POLARITY & TEST DISTANCE: VERTICAL AT 3 M								
No.	Freq. (MHz)	Emission Level (dBuV/m)	Limit (dBuV/m)	Margin (dB)	Antenna Height (m)	Table Angle (Degree)	Raw Value (dBuV)	Correction Factor (dB/m)
1	*2462.00	111.26 PK			1.08 V	319	78.91	32.35
2	*2462.00	100.30 AV			1.08 V	319	67.95	32.35
3	2483.50	71.49 PK	74.00	-2.51	1.06 V	214	39.00	32.49
4	2483.50	52.21 AV	54.00	-1.79	1.06 V	214	19.72	32.49
5	3282.00	47.71 PK	91.26	-43.55	1.03 V	142	13.97	33.74
6	3282.00	41.62 AV	80.30	-38.68	1.03 V	142	7.88	33.74
7	4924.00	46.82 PK	74.00	-27.18	1.03 V	12	9.24	37.58
8	4924.00	34.75 AV	54.00	-19.25	1.03 V	12	-2.83	37.58

- REMARKS:**
1. Emission level (dBuV/m) = Raw Value (dBuV) + Correction Factor (dB/m).
 2. Correction Factor (dB/m) = Antenna Factor (dB/m) + Cable Factor (dB).
 3. The other emission levels were very low against the limit.
 4. Margin value = Emission level – Limit value.
 5. “ * “: Fundamental frequency.



4.3 6dB BANDWIDTH MEASUREMENT

4.3.1 LIMITS OF 6dB BANDWIDTH MEASUREMENT

The minimum of 6dB Bandwidth Measurement is 0.5 MHz.

4.3.2 TEST INSTRUMENTS

DESCRIPTION & MANUFACTURER	MODEL NO.	SERIAL NO.	CALIBRATED UNTIL
SPECTRUM ANALYZER	FSEK 30	100049	Aug. 14, 2006

NOTE: The calibration interval of the above test instruments is 12 months and the calibrations are traceable to NML/ROC and NIST/USA.

4.3.3 TEST PROCEDURE

The transmitter output was connected to the spectrum analyzer through an attenuator. The bandwidth of the fundamental frequency was measured by spectrum analyzer with 100kHz RBW and 100kHz VBW. The 6dB bandwidth is defined as the total spectrum the power of which is higher than peak power minus 6dB.

4.3.4 DEVIATION FROM TEST STANDARD

No deviation

4.3.5 TEST SETUP

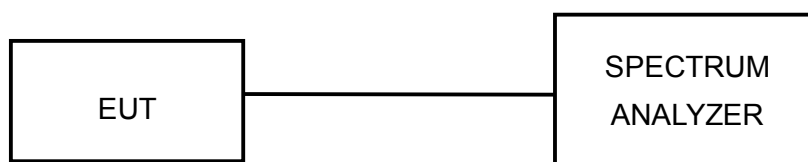

4.3.6 EUT OPERATING CONDITIONS

The software provided by client to enable the EUT under transmission condition continuously at lowest, middle and highest channel frequencies individually.



4.3.7 TEST RESULTS

802.11b DSSS MODULATION

MODULATION TYPE	DBPSK	TRANSFER RATE	1Mbps
INPUT POWER (SYSTEM)	120Vac, 60 Hz	ENVIRONMENTAL CONDITIONS	26deg. C, 66%RH, 991hPa
TESTED BY	Morgan Chen		

CHANNEL	CHANNEL FREQUENCY (MHz)	6dB BANDWIDTH (MHz)	MINIMUM LIMIT (MHz)	PASS/FAIL
1	2412	12.04	0.5	PASS
6	2437	12.04	0.5	PASS
11	2462	12.08	0.5	PASS

CH1

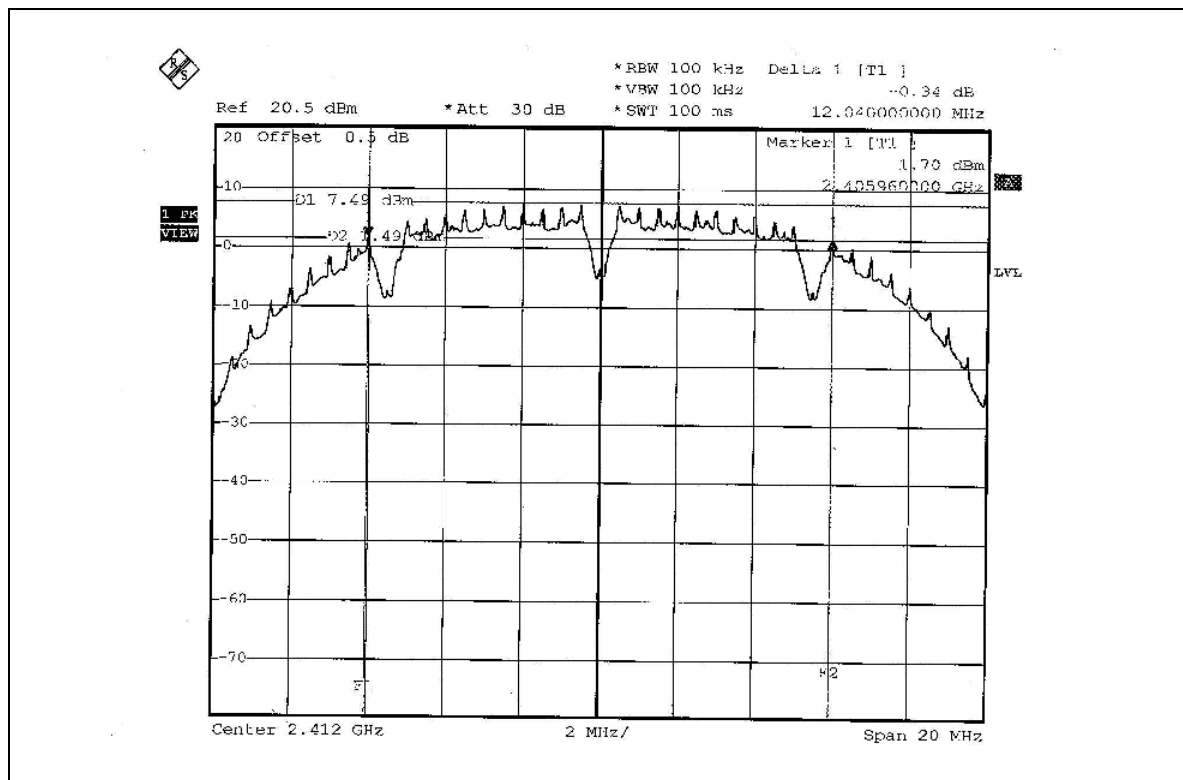

CH6

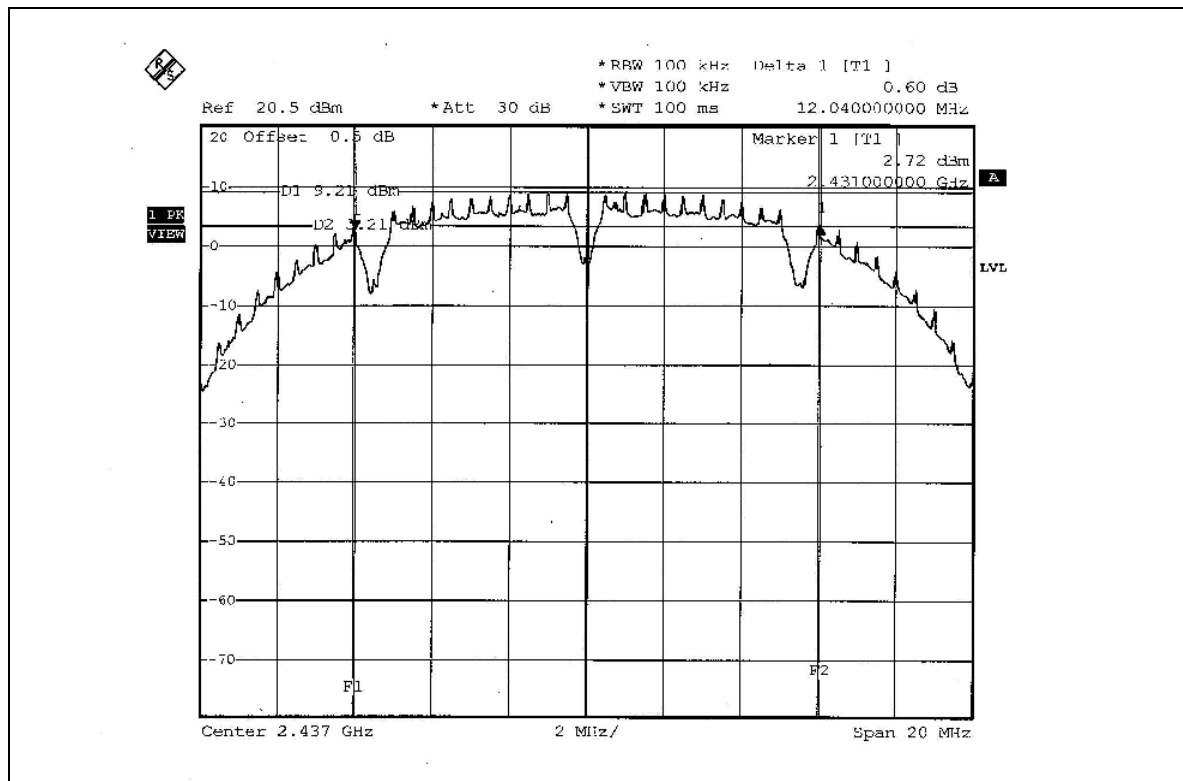

CH11

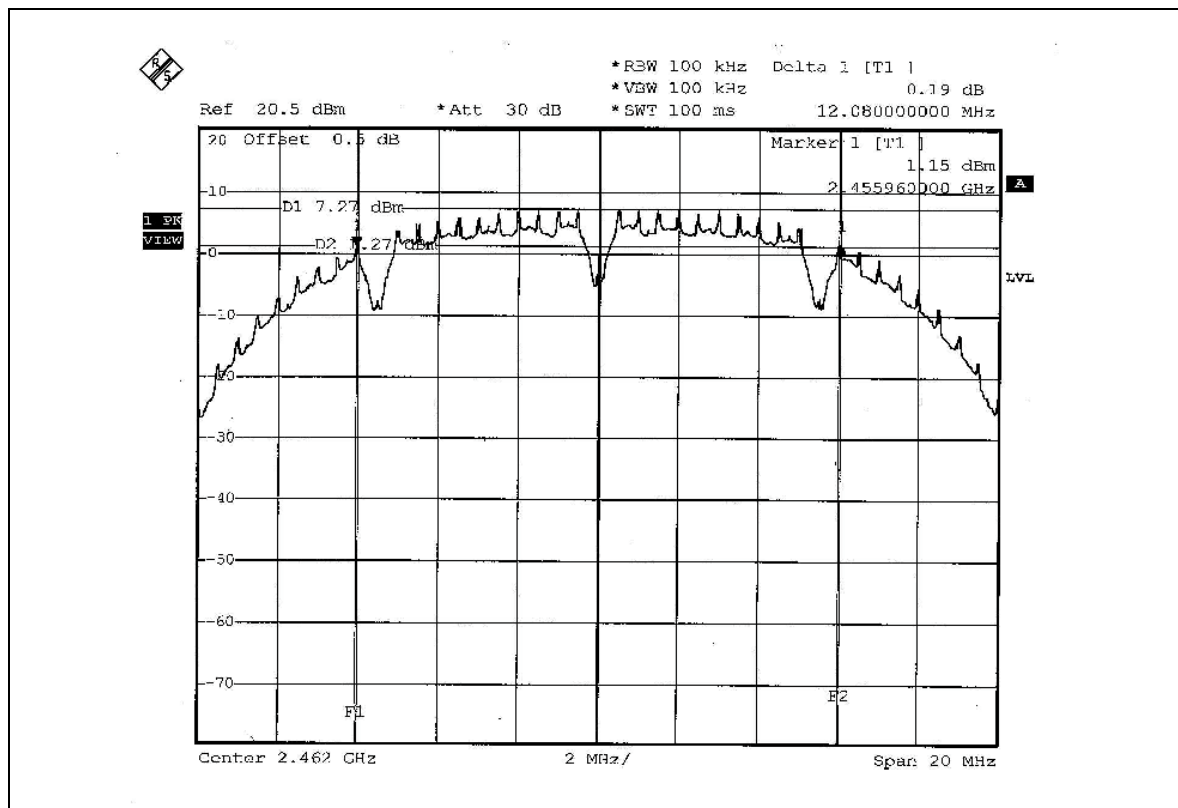



802.11g OFDM MODULATION

MODULATION TYPE	BPSK	TRANSFER RATE	6Mbps
INPUT POWER (SYSTEM)	120Vac, 60 Hz	ENVIRONMENTAL CONDITIONS	26deg. C, 66%RH, 991hPa
TESTED BY	Morgan Chen		

CHANNEL	CHANNEL FREQUENCY (MHz)	6dB BANDWIDTH (MHz)	MINIMUM LIMIT (MHz)	PASS/FAIL
1	2412	16.44	0.5	PASS
6	2437	16.44	0.5	PASS
11	2462	16.44	0.5	PASS

CH1

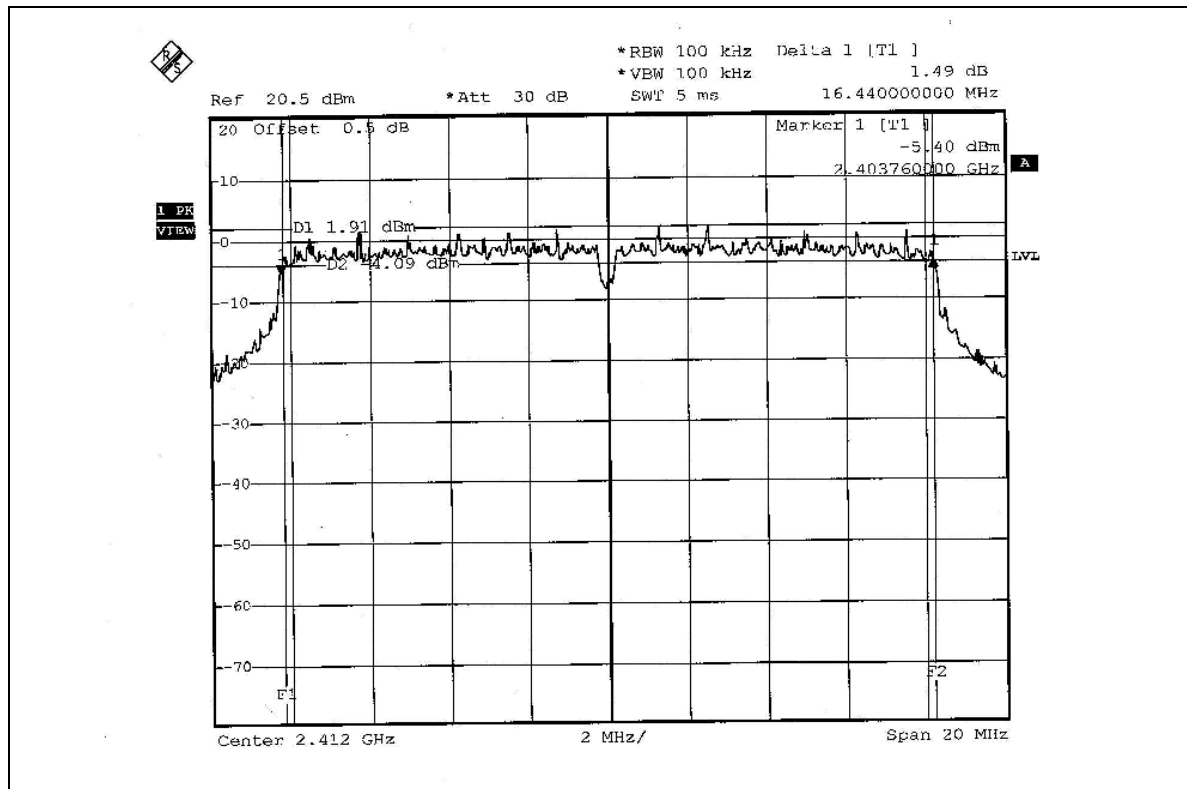

CH6

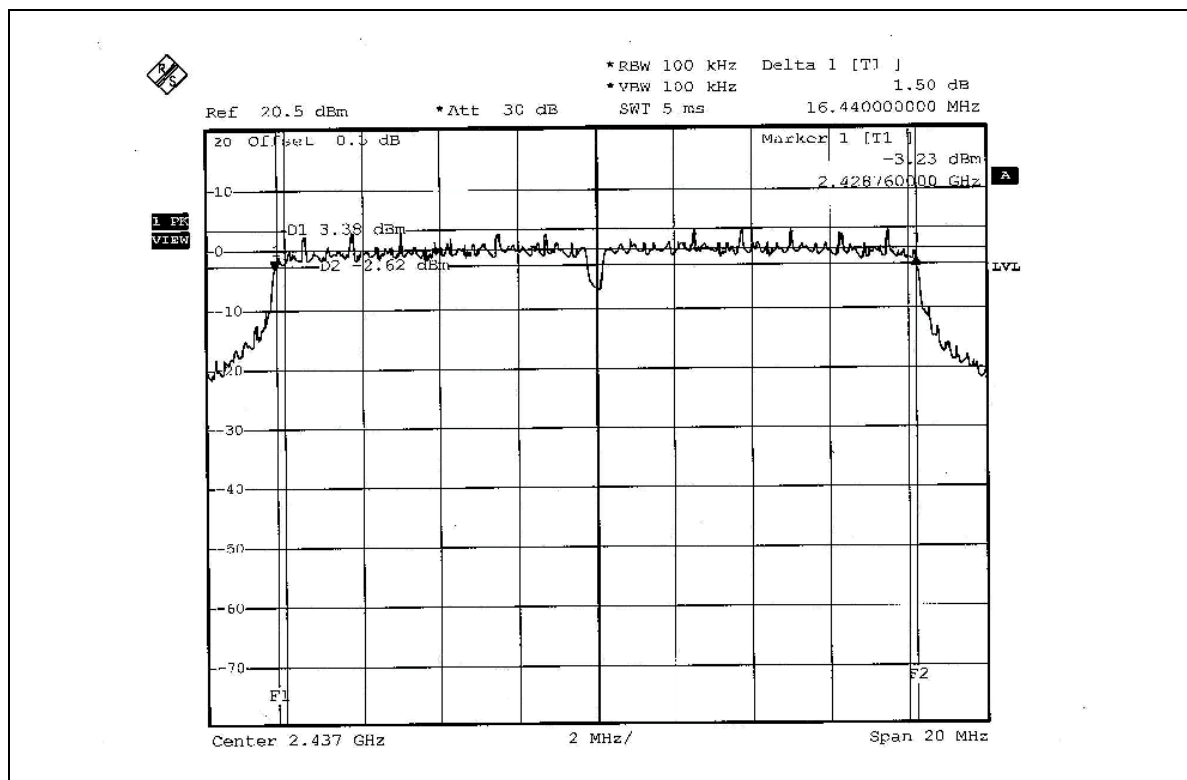

CH11

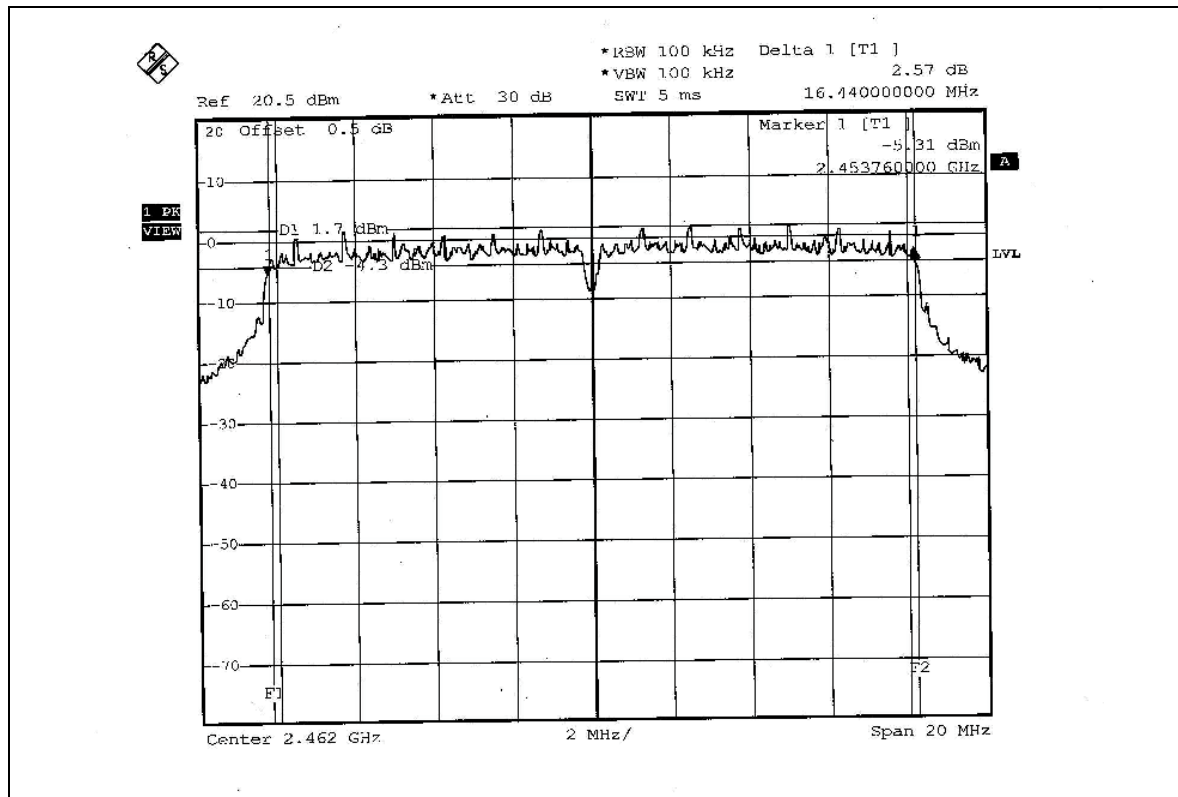



4.4 MAXIMUM PEAK OUTPUT POWER

4.4.1 LIMITS OF MAXIMUM PEAK OUTPUT POWER MEASUREMENT

The Maximum Peak Output Power Measurement is 30dBm.

4.4.2 INSTRUMENTS

DESCRIPTION & MANUFACTURER	MODEL NO.	SERIAL NO.	CALIBRATED UNTIL
R&S SPECTRUM ANALYZER	FSEK30	100049	Aug. 14, 2006
AGILENT SIGNAL GENERATOR	E8257C	MY43320668	Dec. 06, 2006
DIGITAL RT OSCILLOSCOPE	TDS1012	C037299	Dec. 07, 2006
NARDA DETECTOR	4503A	FSCM99899	NA

NOTE: The calibration interval of the above test instruments is 12 months and the calibrations are traceable to NML/ROC and NIST/USA.

4.4.3 TEST PROCEDURES

1. A detector was used on the output port of the EUT. An oscilloscope was used to read the response of the detector.
2. Replaced the EUT by the signal generator. The center frequency of the S.G was adjusted to the center frequency of the measured channel.
3. Adjusted the power to have the same reading on oscilloscope. Record the power level.

4.4.4 DEVIATION FROM TEST STANDARD

No deviation

4.4.5 TEST SETUP



4.4.6 EUT OPERATING CONDITIONS

Same as Item 4.3.6

4.4.7 TEST RESULTS

802.11b DSSS MODULATION

MODULATION TYPE	DBPSK	TRANSFER RATE	1Mbps
INPUT POWER (SYSTEM)	120Vac, 60 Hz	ENVIRONMENTAL CONDITIONS	26deg. C, 66%RH, 991hPa
TESTED BY	Morgan Chen		

CHANNEL	CHANNEL FREQUENCY (MHz)	PEAK POWER OUTPUT (mW)	PEAK POWER OUTPUT (dBm)	PEAK POWER LIMIT (dBm)	PASS/FAIL
1	2412	50.234	17.01	30	PASS
6	2437	80.353	19.05	30	PASS
11	2462	50.350	17.02	30	PASS

802.11g OFDM MODULATION

MODULATION TYPE	BPSK	TRANSFER RATE	6Mbps
INPUT POWER (SYSTEM)	120Vac, 60 Hz	ENVIRONMENTAL CONDITIONS	26deg. C, 66%RH, 991hPa
TESTED BY	Morgan Chen		

CHANNEL	CHANNEL FREQUENCY (MHz)	PEAK POWER OUTPUT (mW)	PEAK POWER OUTPUT (dBm)	PEAK POWER LIMIT (dBm)	PASS/FAIL
1	2412	56.494	17.52	30	PASS
6	2437	80.538	19.06	30	PASS
11	2462	56.494	17.52	30	PASS



4.5 POWER SPECTRAL DENSITY MEASUREMENT

4.5.1 LIMITS OF POWER SPECTRAL DENSITY MEASUREMENT

The Maximum of Power Spectral Density Measurement is 8dBm.

4.5.2 TEST INSTRUMENTS

DESCRIPTION & MANUFACTURER	MODEL NO.	SERIAL NO.	CALIBRATED UNTIL
R&S SPECTRUM ANALYZER	FSEK30	100049	Aug. 14, 2006

NOTE: The calibration interval of the above test instruments is 12 months and the calibrations are traceable to NML/ROC and NIST/USA.

4.5.3 TEST PROCEDURE

The transmitter output was connected to the spectrum analyzer through an attenuator, the bandwidth of the fundamental frequency was measured with the spectrum analyzer using 3kHz RBW and 30kHz VBW, set sweep time = span/3kHz. The power spectral density was measured and recorded.

The sweep time is allowed to be longer than span/3kHz for a full response of the mixer in the spectrum analyzer.

4.5.4 DEVIATION FROM TEST STANDARD

No deviation

4.5.5 TEST SETUP

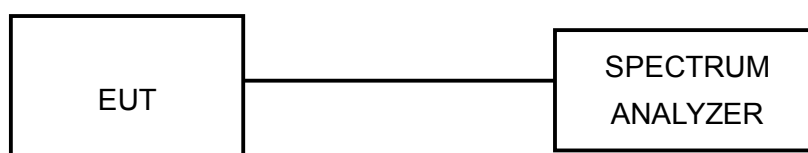

4.5.6 EUT OPERATING CONDITION

Same as Item 4.3.6



4.5.7 TEST RESULTS

802.11b DSSS MODULATION

MODULATION TYPE	DBPSK	TRANSFER RATE	1Mbps
INPUT POWER (SYSTEM)	120Vac, 60 Hz	ENVIRONMENTAL CONDITIONS	26deg. C, 66%RH, 991hPa
TESTED BY	Morgan Chen		

CHANNEL	CHANNEL FREQUENCY (MHz)	RF POWER LEVEL IN 3kHz BW (dBm)	MAXIMUM LIMIT (dBm)	PASS/FAIL
1	2412	-7.47	8	PASS
6	2437	-5.51	8	PASS
11	2462	-7.23	8	PASS

CH1

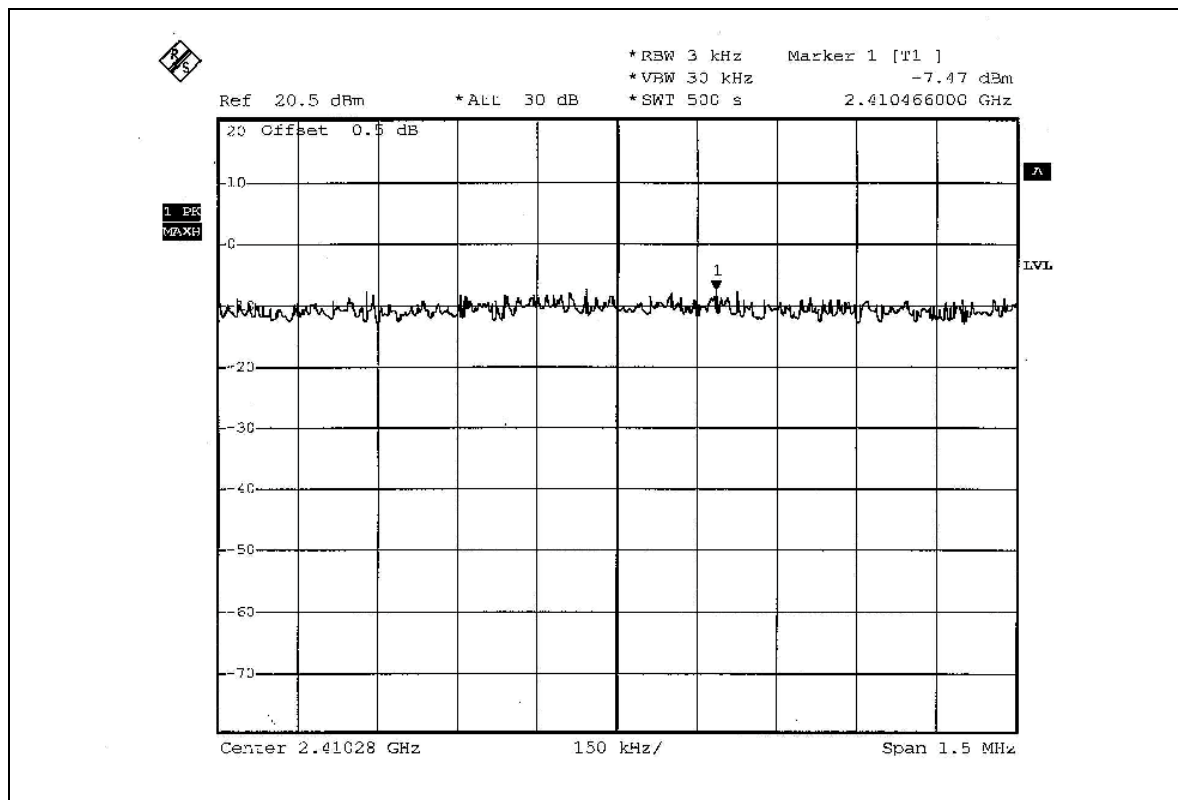

CH6

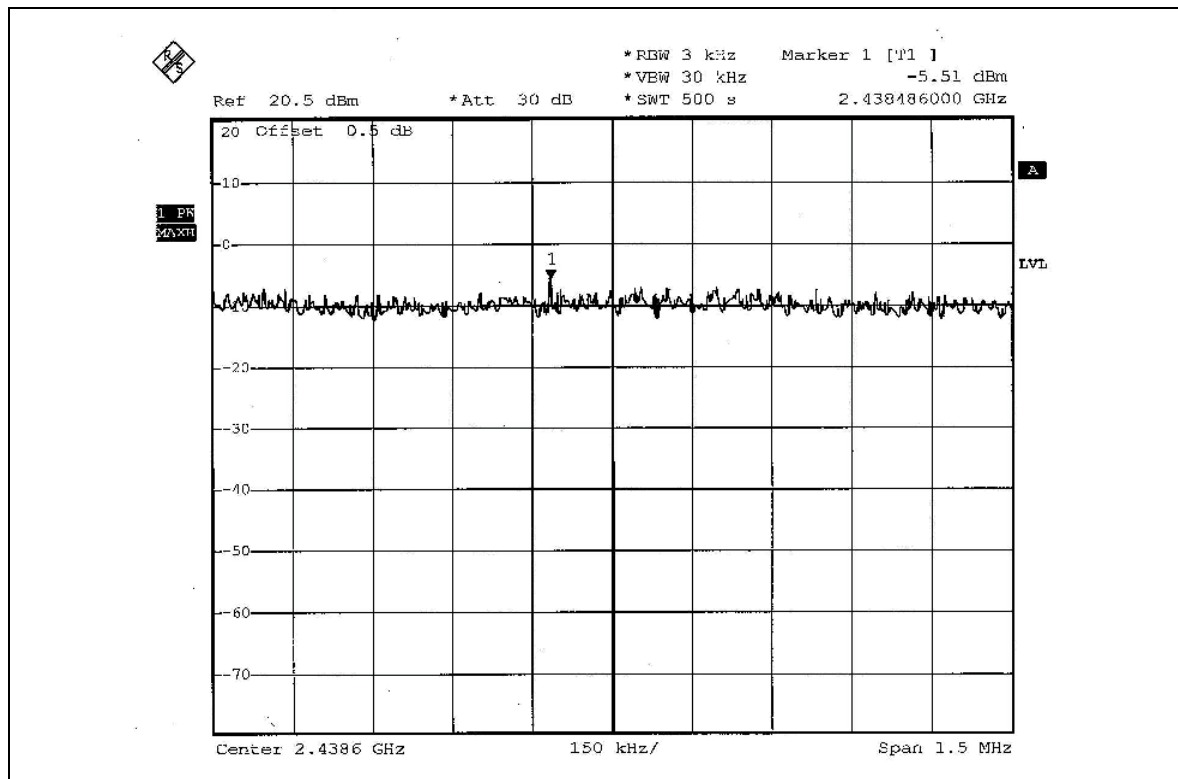

CH11

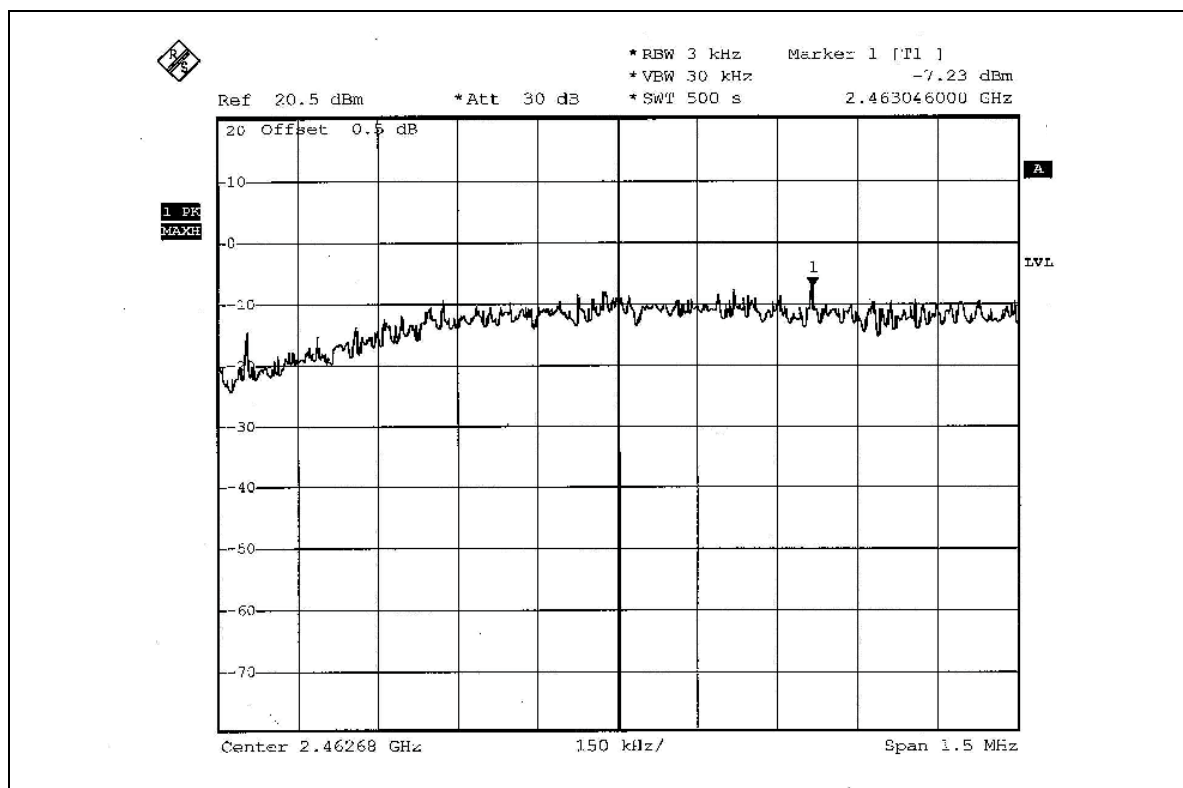



802.11g OFDM MODULATION

MODULATION TYPE	BPSK	TRANSFER RATE	6Mbps
INPUT POWER (SYSTEM)	120Vac, 60 Hz	ENVIRONMENTAL CONDITIONS	26deg. C, 66%RH, 991hPa
TESTED BY	Morgan Chen		

CHANNEL	CHANNEL FREQUENCY (MHz)	RF POWER LEVEL IN 3kHz BW (dBm)	MAXIMUM LIMIT (dBm)	PASS/FAIL
1	2412	-11.69	8	PASS
6	2437	-10.12	8	PASS
11	2462	-11.44	8	PASS

CH1

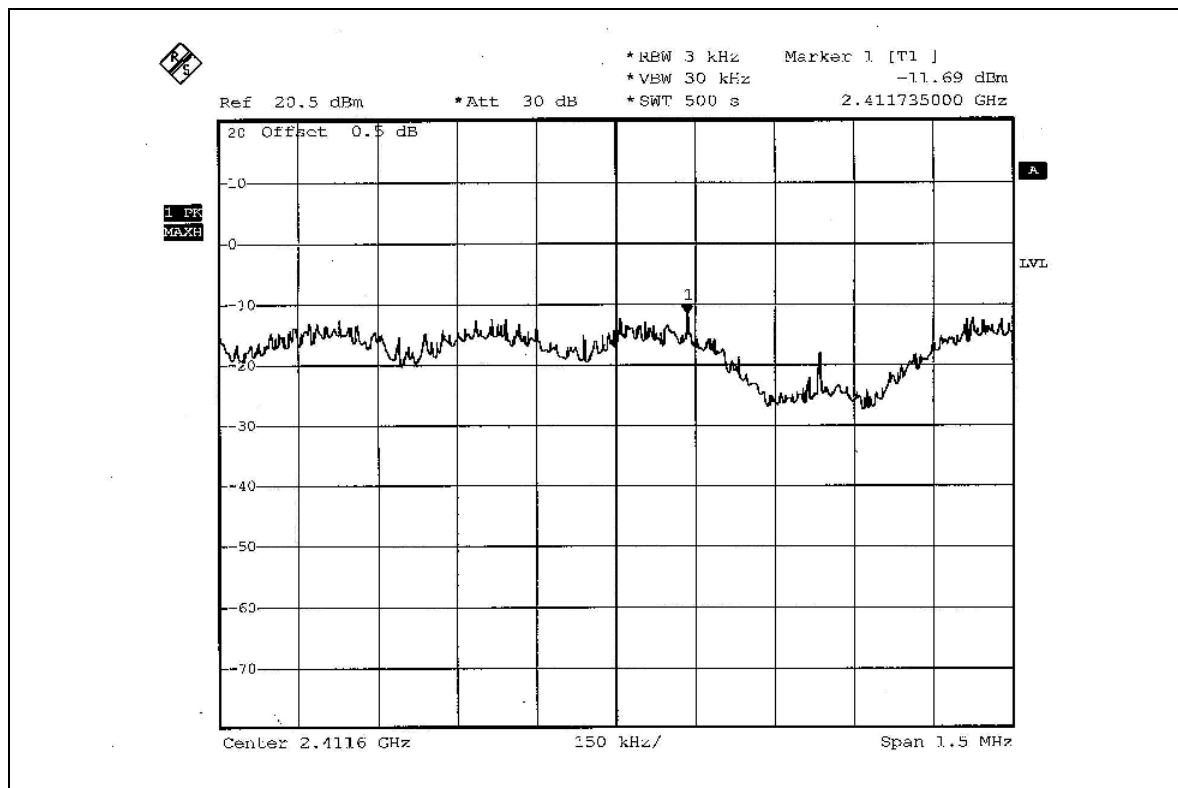

CH6

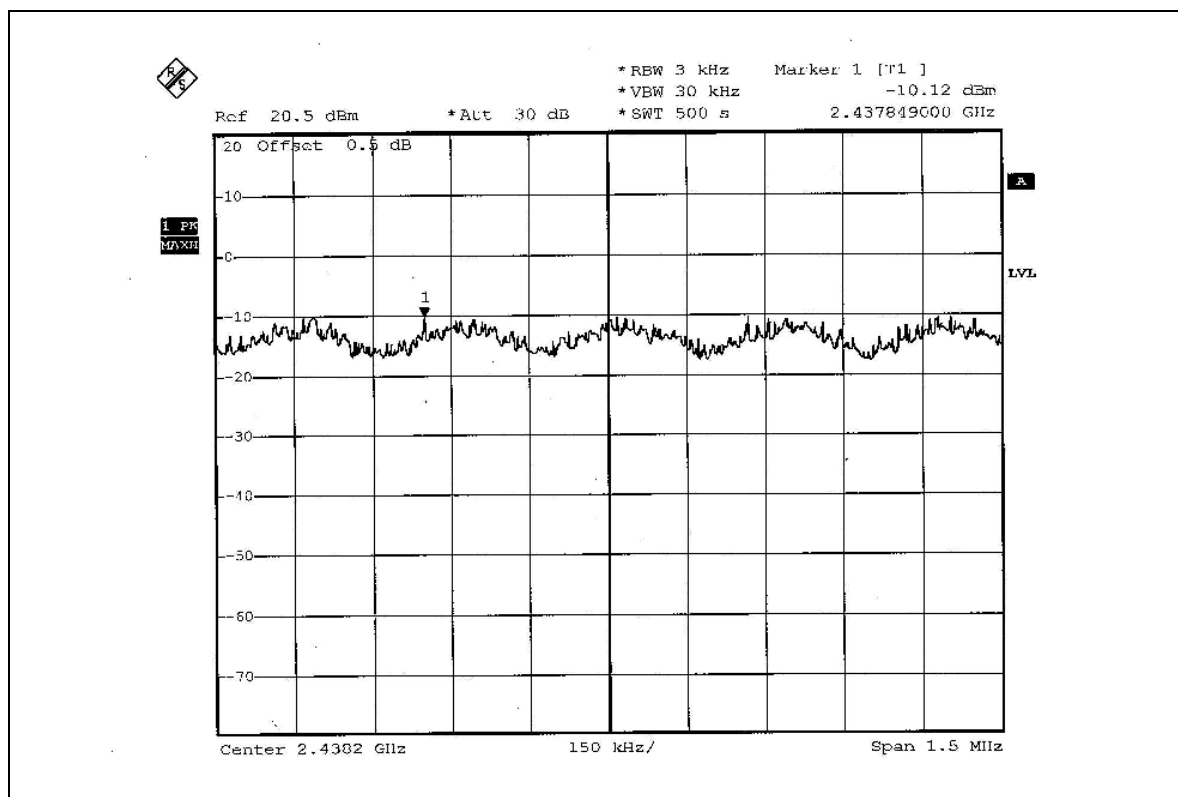

CH11

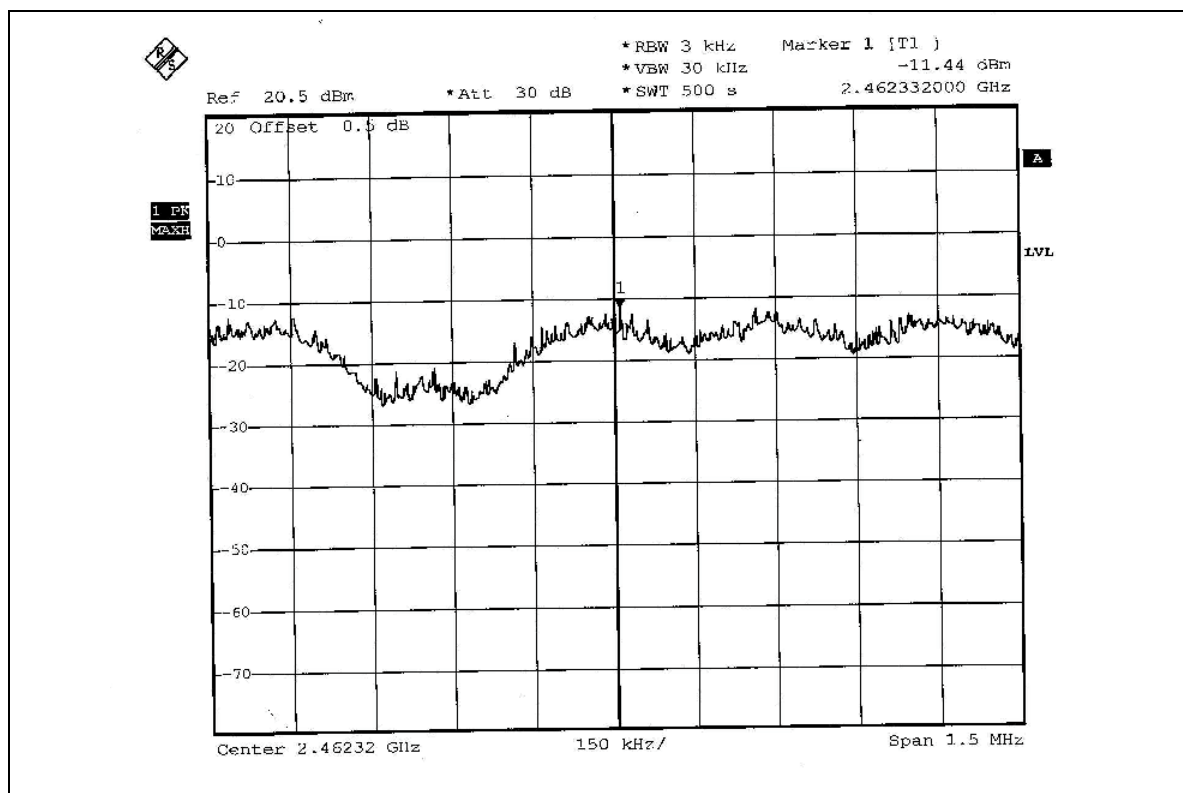

4.6 BAND EDGES MEASUREMENT

4.6.1 LIMITS OF BAND EDGES MEASUREMENT

Below –20dB of the highest emission level of operating band (in 100kHz Resolution Bandwidth).

4.6.2 TEST INSTRUMENTS

DESCRIPTION & MANUFACTURER	MODEL NO.	SERIAL NO.	CALIBRATED UNTIL
R&S SPECTRUM ANALYZER	FSEK30	100049	Aug. 14, 2006

NOTE: The calibration interval of the above test instruments is 12 months and the calibrations are traceable to NML/ROC and NIST/USA.

4.6.3 TEST PROCEDURE

The transmitter output was connected to the spectrum analyzer via a low lose cable. Set both RBW and VBW of spectrum analyzer to 100 kHz with suitable frequency span including 100 MHz bandwidth from band edge. The band edges was measured and recorded.

The spectrum plots (Peak RBW=VBW=100kHz; Average RBW=1MHz, VBW=10Hz) are attached on the following pages.

4.6.4 DEVIATION FROM TEST STANDARD

No deviation

4.6.5 EUT OPERATING CONDITION

Same as Item 4.3.6

4.6.6 TEST RESULTS

The spectrum plots are attached on the following 12 images. D1 line indicates the highest level, and D2 line indicates the 20dB offset below D1. It shows compliance with the requirement in part 15.247(d).

802.11b DSSS MODULATION

NOTE 1: The band edge emission plot on following page shows 53.40dBc delta between carrier maximum power and local maximum emission in restrict band (2.38900GHz). The emission of carrier strength list in the test result of channel 1 at the item 4.2.7 is 111.28dBuV/m (Peak), so the maximum field strength in restrict band is $111.28 - 53.40 = 57.88$ dBuV/m, which is under 74dBuV/m limit.

The band edge emission plot on following page shows 58.12dBc delta between carrier maximum power and local maximum emission in restrict band (2.38620GHz). The emission of carrier strength list in the test result of channel 1 at the item 4.2.7 is 107.26dBuV/m (Average), so the maximum field strength in restrict band is $107.26 - 58.12 = 49.14$ dBuV/m, which is under 54dBuV/m limit.

NOTE 2: The band edge emission plot on following second page shows 51.69dBc delta between carrier maximum power and local maximum emission in restrict band (2.49890GHz). The emission of carrier strength list in the test result of channel 11 at the item 4.2.7 is 111.01dBuV/m (Peak), so the maximum field strength in restrict band is $111.01 - 51.69 = 59.32$ dBuV/m, which is under 74dBuV/m limit.

The band edge emission plot on following third page shows 53.92dBc delta between carrier maximum power and local maximum emission in restrict band (2.49840GHz). The emission of carrier strength list in the test result of channel 11 at the item 4.2.7 is 106.92dBuV/m (Average), so the maximum field strength in restrict band is $106.92 - 53.92 = 53.00$ dBuV/m, which is under 54dBuV/m limit.

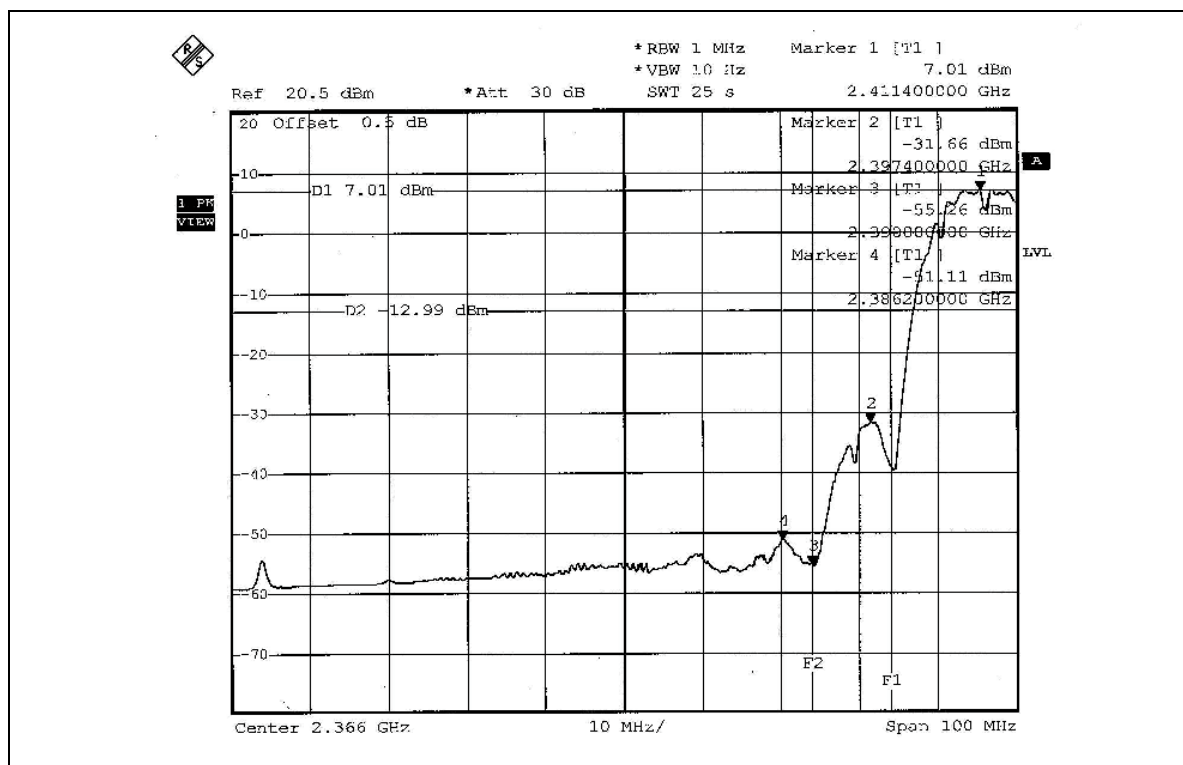
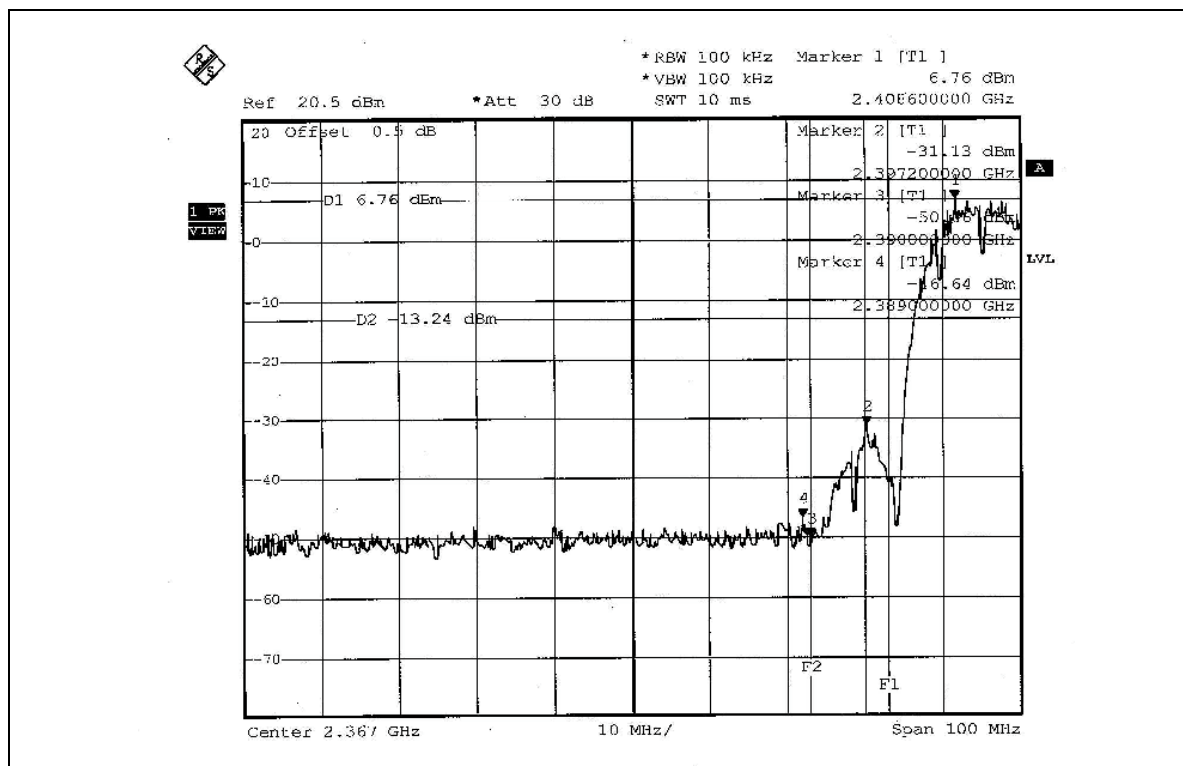

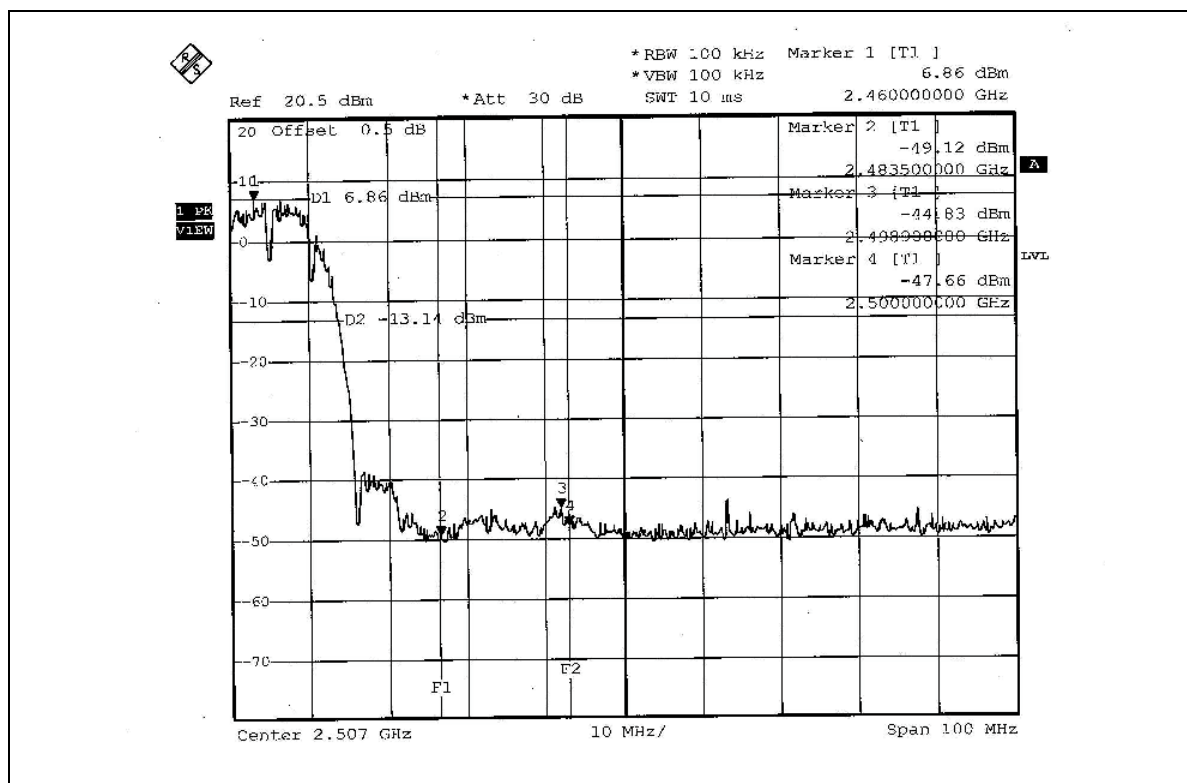
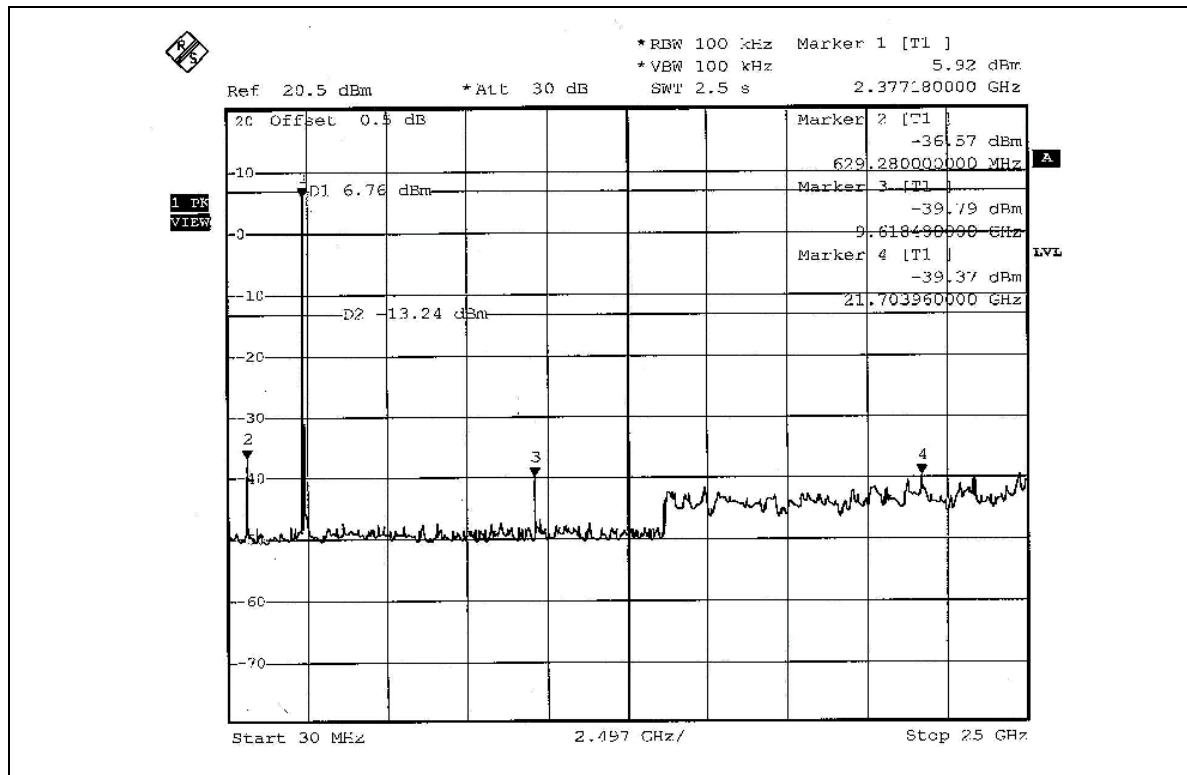

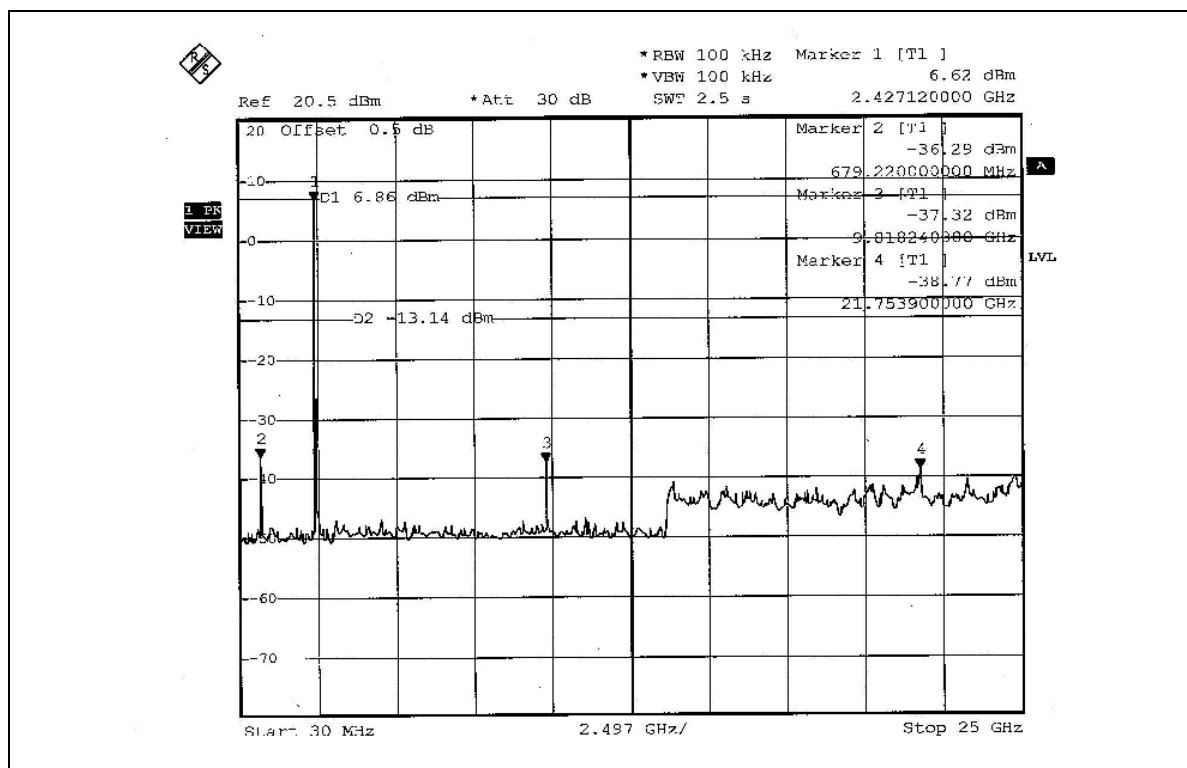
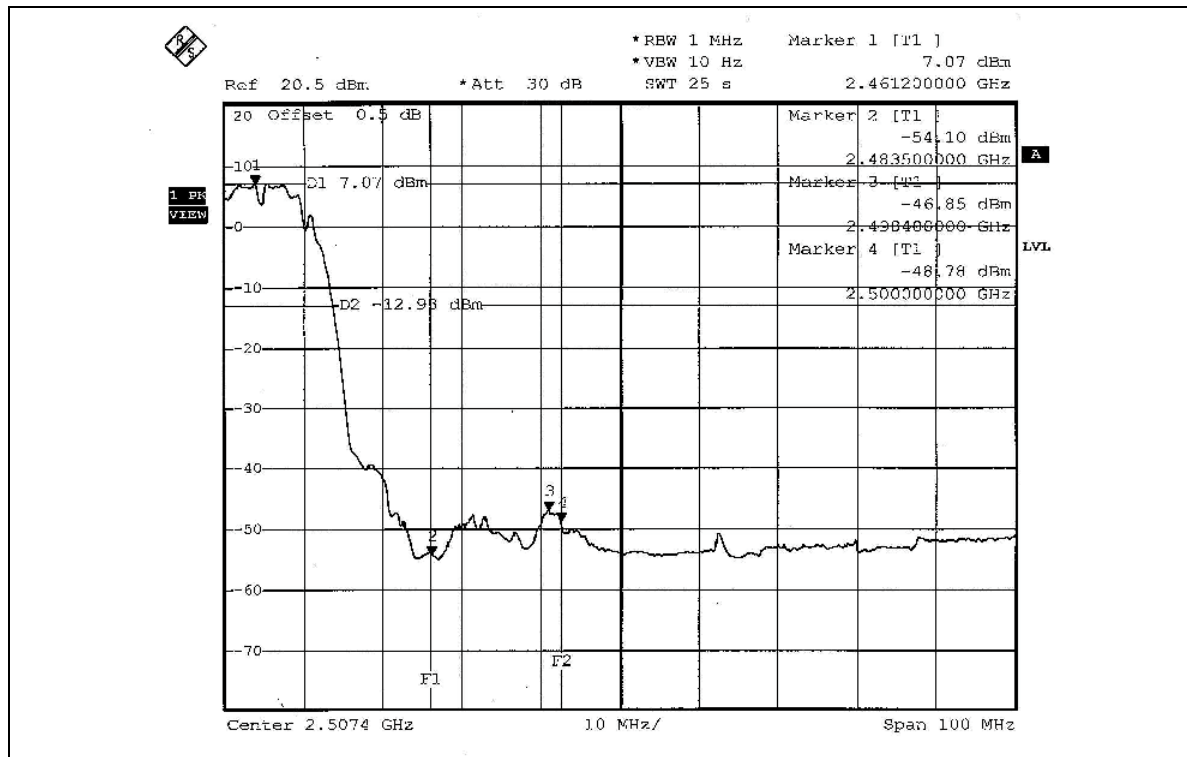

802.11g OFDM MODULATION

NOTE 1: The band edge emission plot on following page shows 45.27dBc delta between carrier maximum power and local maximum emission in restrict band (2.39000GHz). The emission of carrier strength list in the test result of channel 1 at the item 4.2.7 is 111.37dBuV/m (Peak), so the maximum field strength in restrict band is $111.37 - 45.27 = 66.10$ dBuV/m, which is under 74dBuV/m limit.

The band edge emission plot on following page shows 48.88dBc delta between carrier maximum power and local maximum emission in restrict band (2.39000GHz). The emission of carrier strength list in the test result of channel 1 at the item 4.2.7 is 100.40dBuV/m (Average), so the maximum field strength in restrict band is $100.40 - 48.88 = 51.52$ dBuV/m, which is under 54dBuV/m limit.

NOTE 2: The band edge emission plot on following second page shows 45.48dBc delta between carrier maximum power and local maximum emission in restrict band (2.48350GHz). The emission of carrier strength list in the test result of channel 11 at the item 4.2.7 is 111.26dBuV/m (Peak), so the maximum field strength in restrict band is $111.26 - 45.48 = 65.78$ dBuV/m, which is under 74dBuV/m limit.

The band edge emission plot on following third page shows 48.47dBc delta between carrier maximum power and local maximum emission in restrict band (2.50000GHz). The emission of carrier strength list in the test result of channel 11 at the item 4.2.7 is 100.30dBuV/m (Average), so the maximum field strength in restrict band is $100.30 - 48.47 = 51.83$ dBuV/m, which is under 54dBuV/m limit.

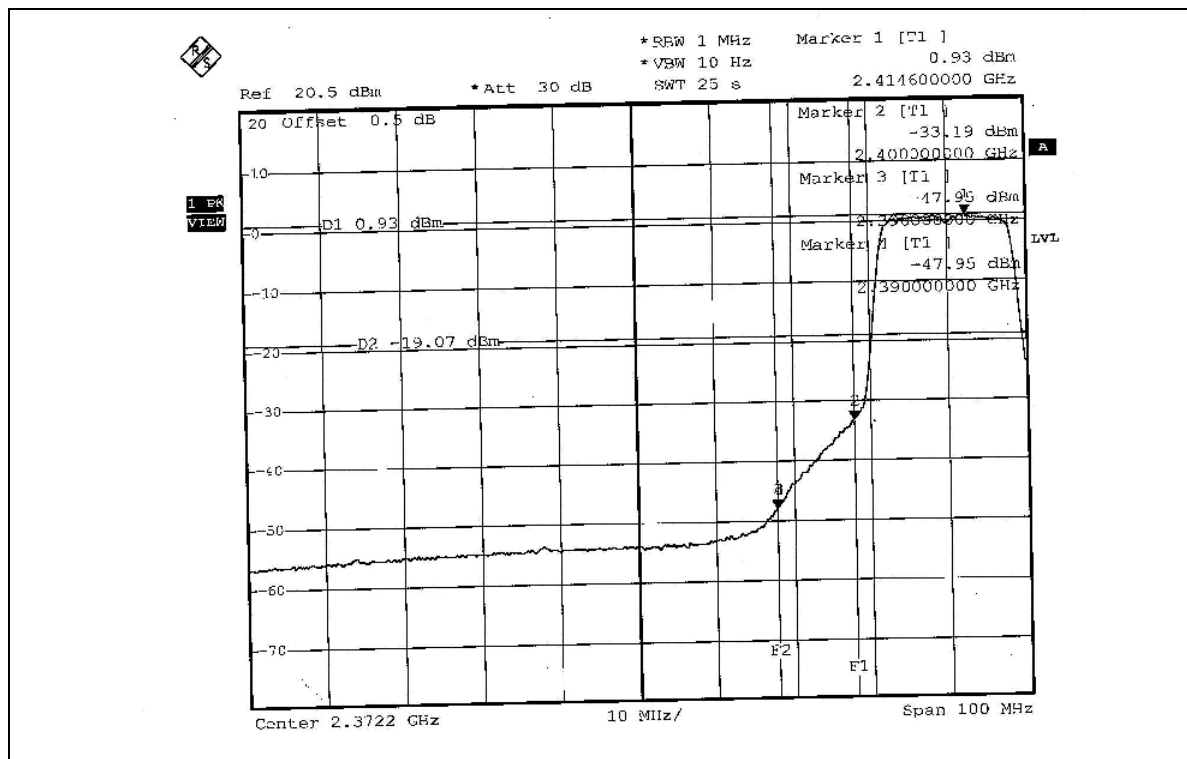
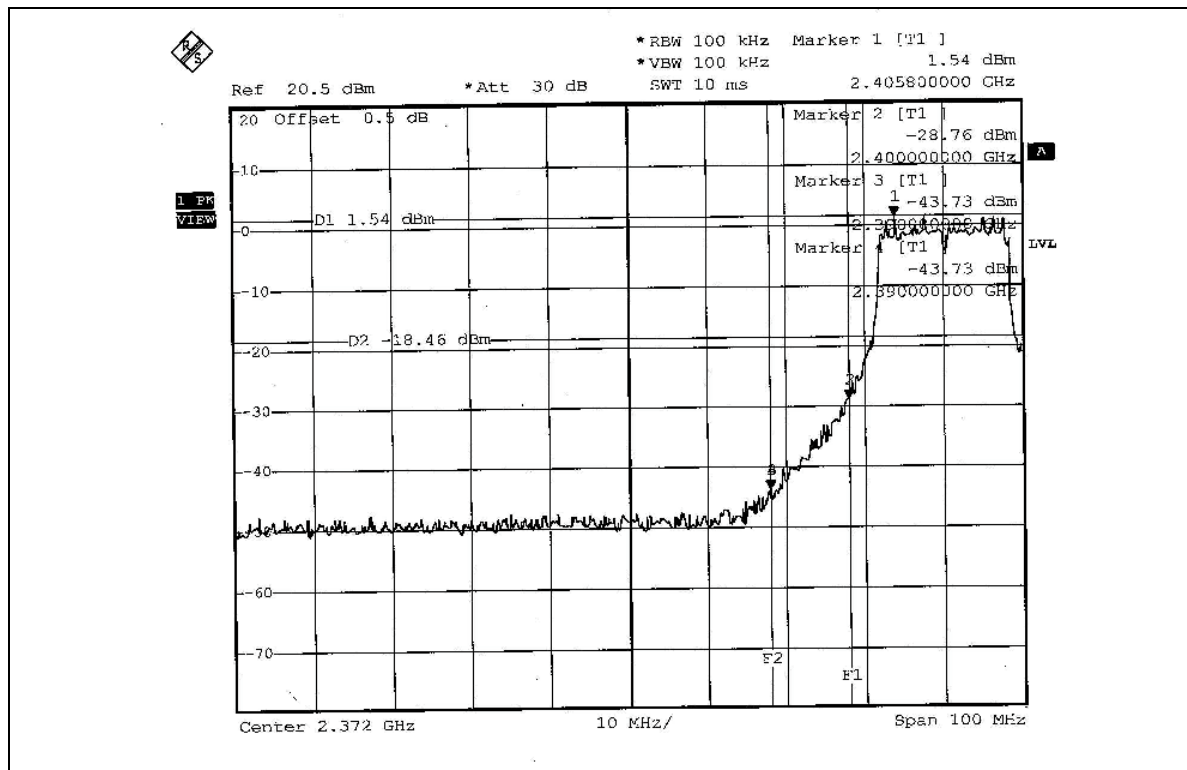

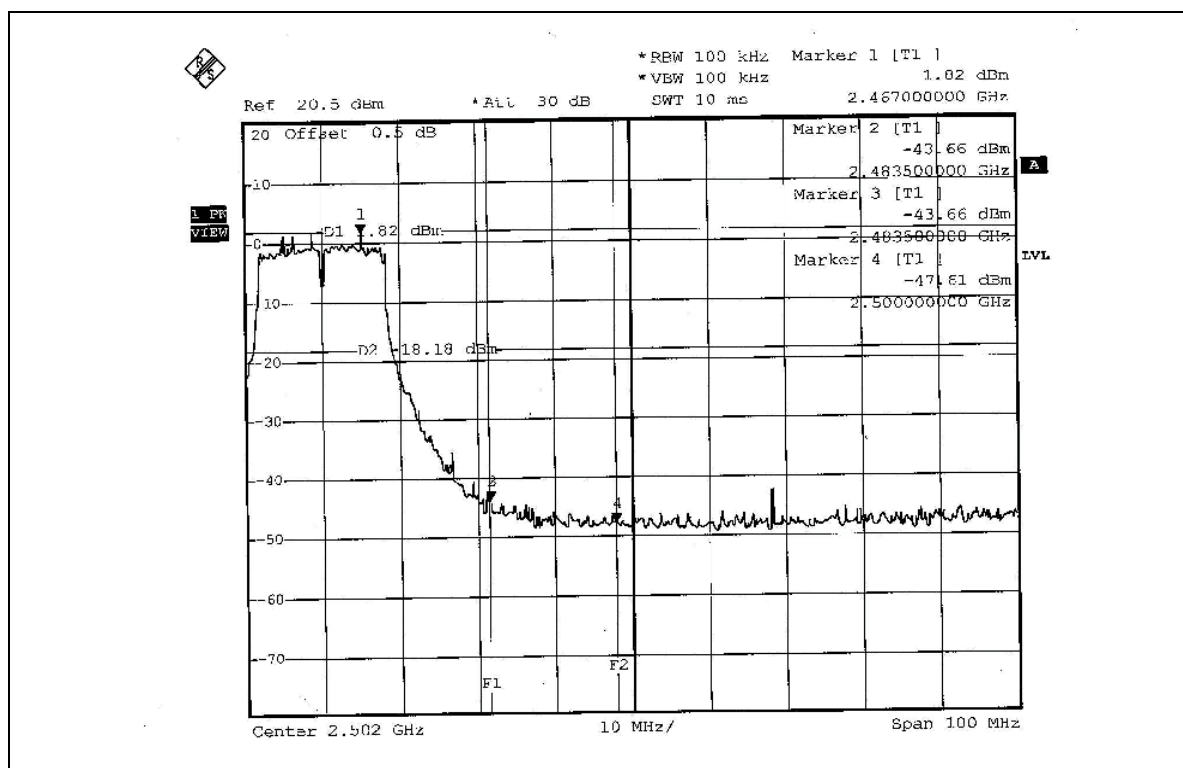
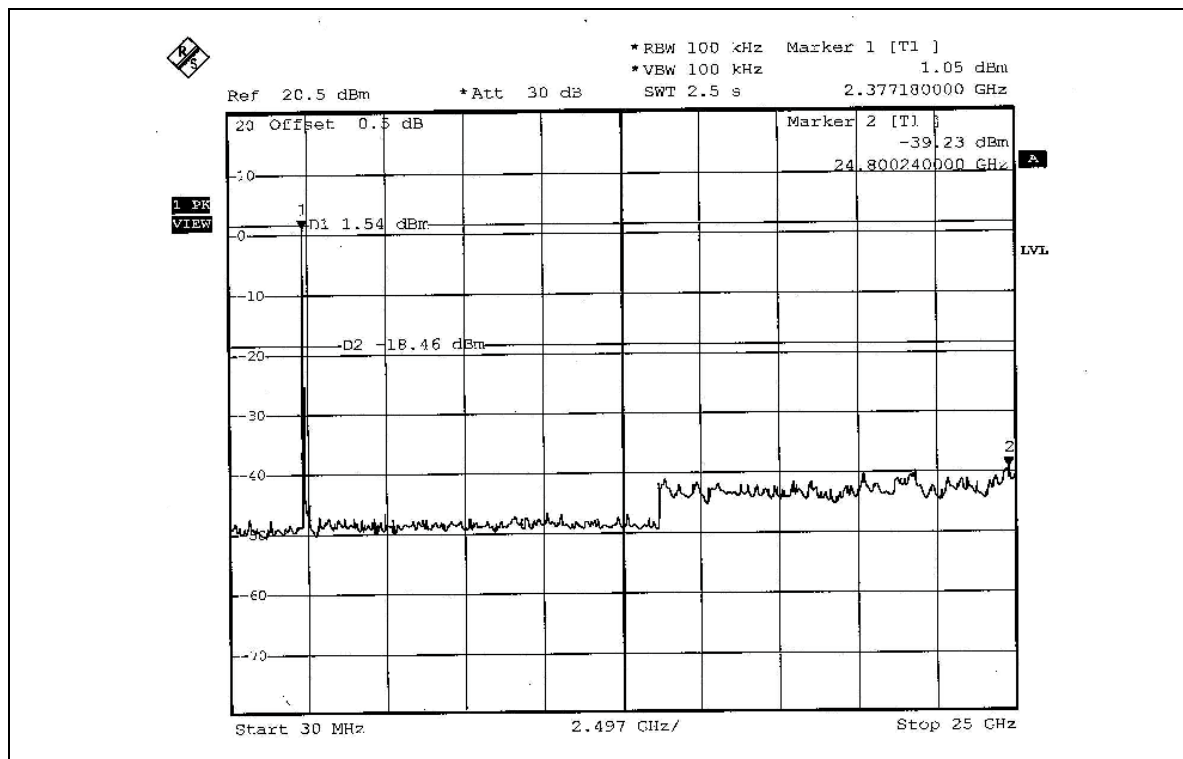

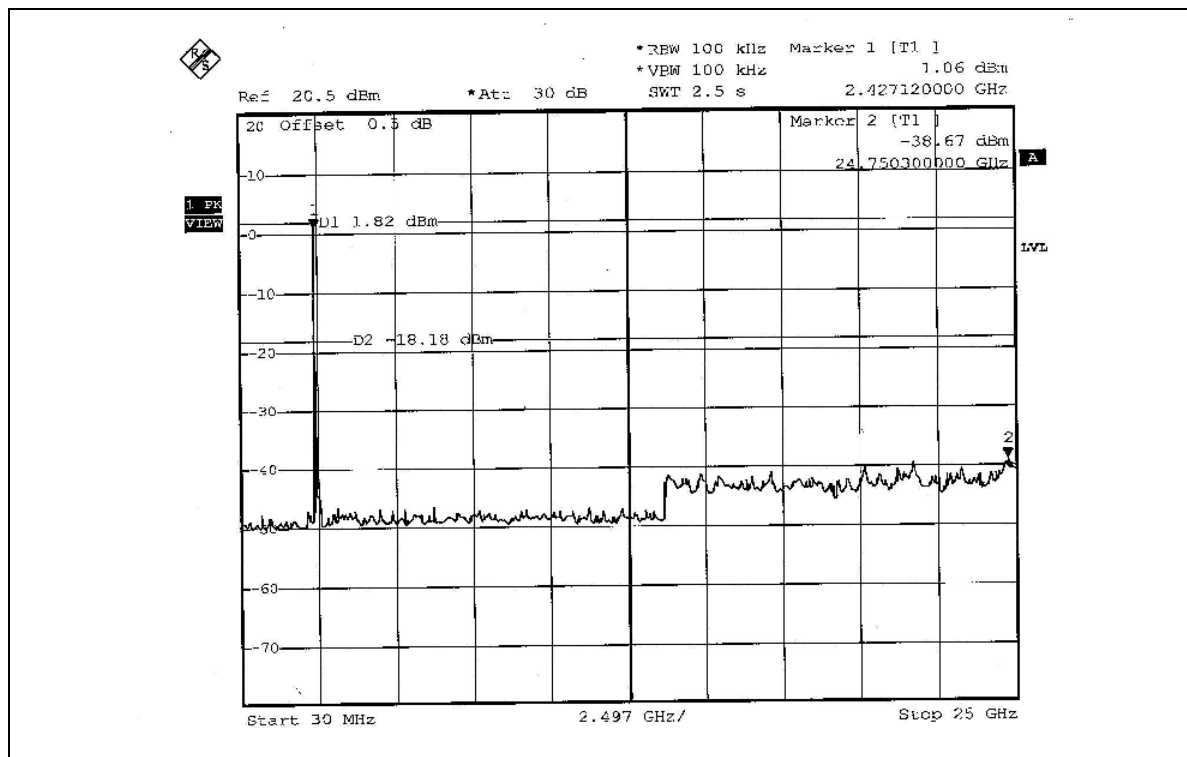
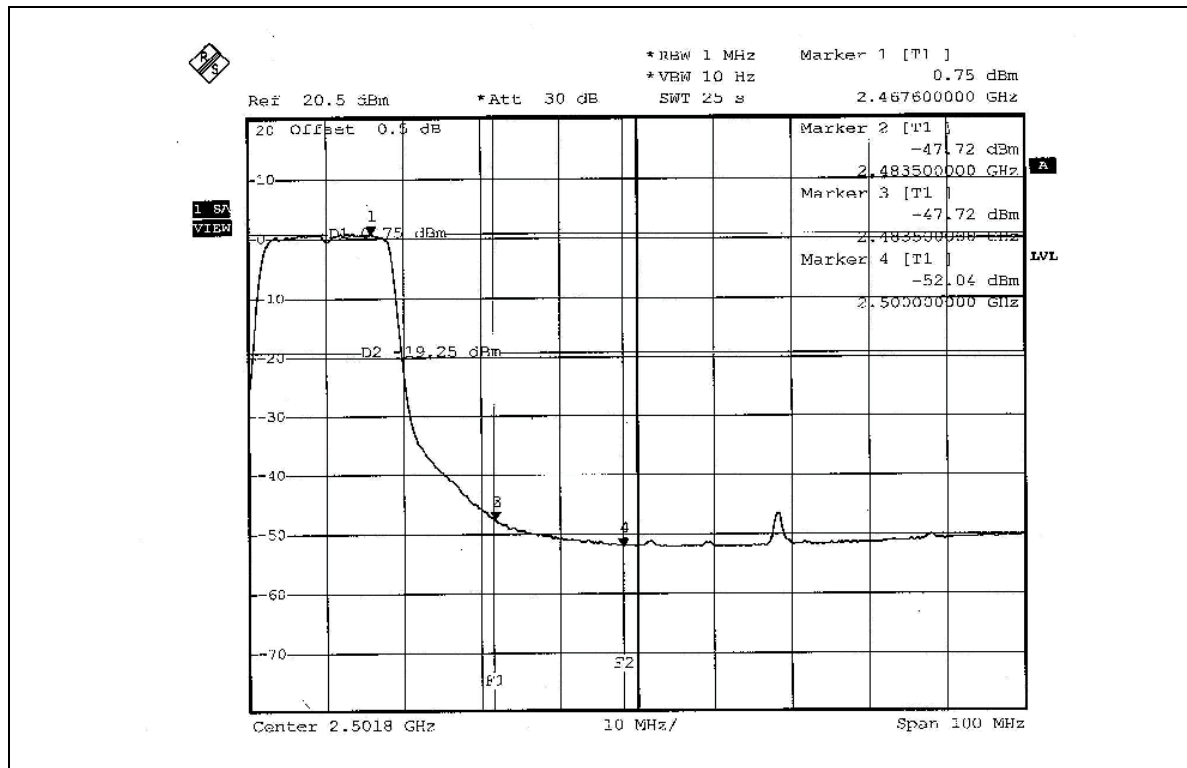

4.7 ANTENNA REQUIREMENT

4.7.1 STANDARD APPLICABLE

For intentional device, according to FCC 47 CFR Section 15.203, an intentional radiator shall be designed to ensure that no antenna other than that furnished by the responsible party shall be used with the device. And according to FCC 47 CFR Section 15.247 (b), if transmitting antennas of directional gain greater than 6dBi are used, the power shall be reduced by the amount in dB that the directional gain of the antenna exceeds 6dBi.

4.7.2 ANTENNA CONNECTED CONSTRUCTION

The antennas used in this product are Dipole antenna with R-SMA connector and Printed antenna without connector. The maximum Gain of the antenna is 4dBi.

5. PHOTOGRAPHS OF THE TEST CONFIGURATION

CONDUCTED EMISSION TEST (Test mode A)



CONDUCTED EMISSION TEST (Test mode B)



RADIATED EMISSION TEST (Test mode A)

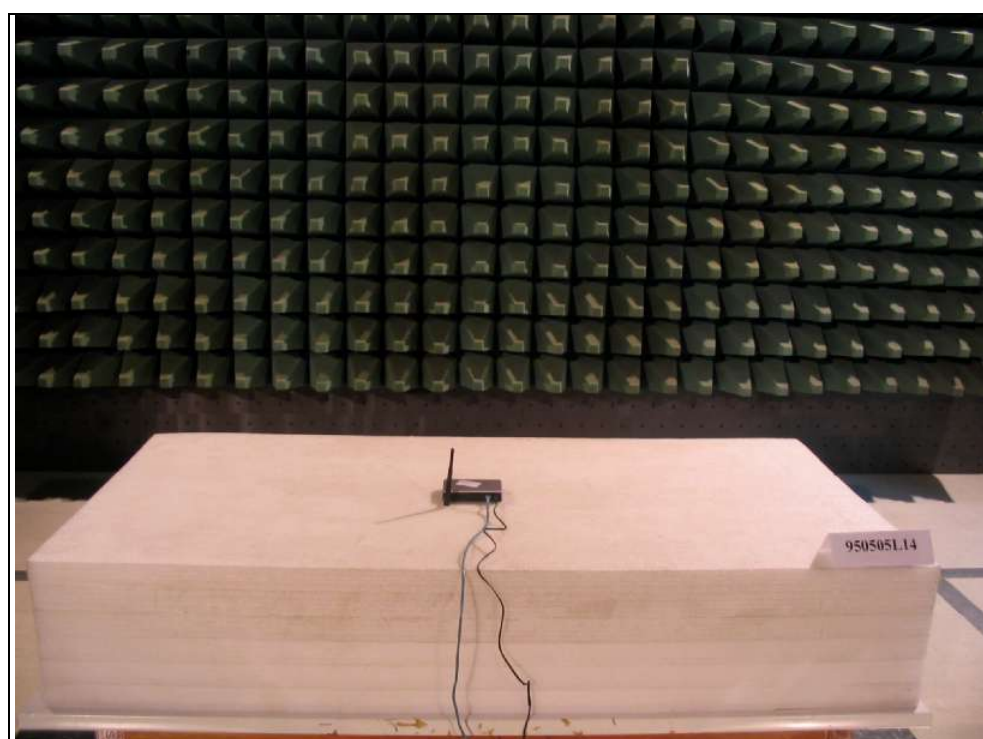
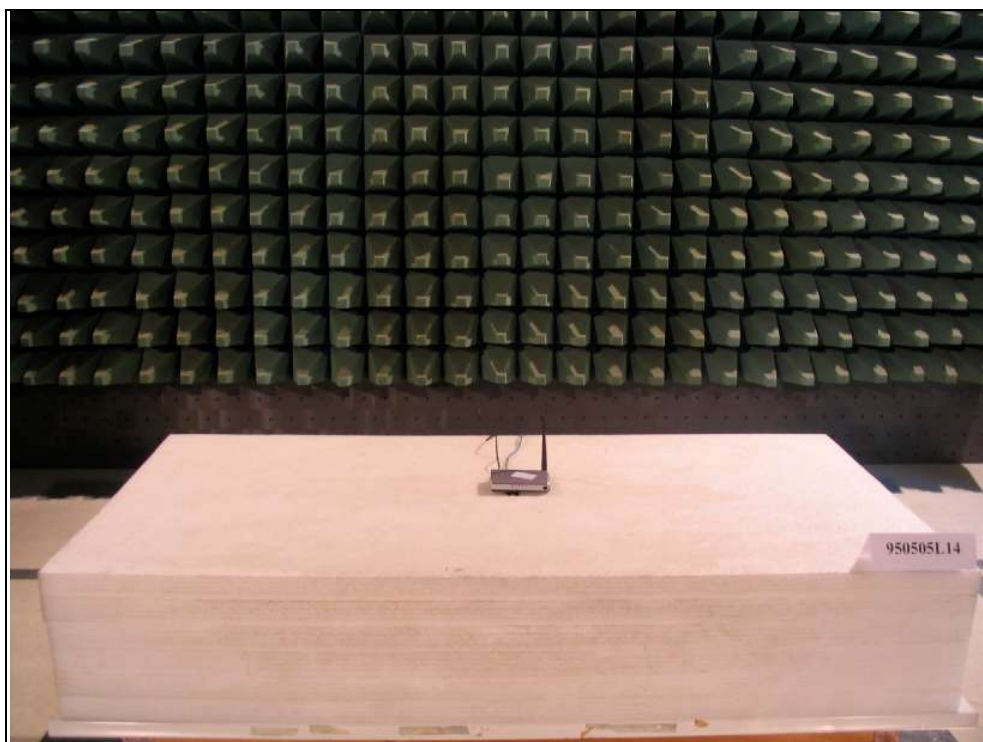

RADIATED EMISSION TEST (Test mode B)

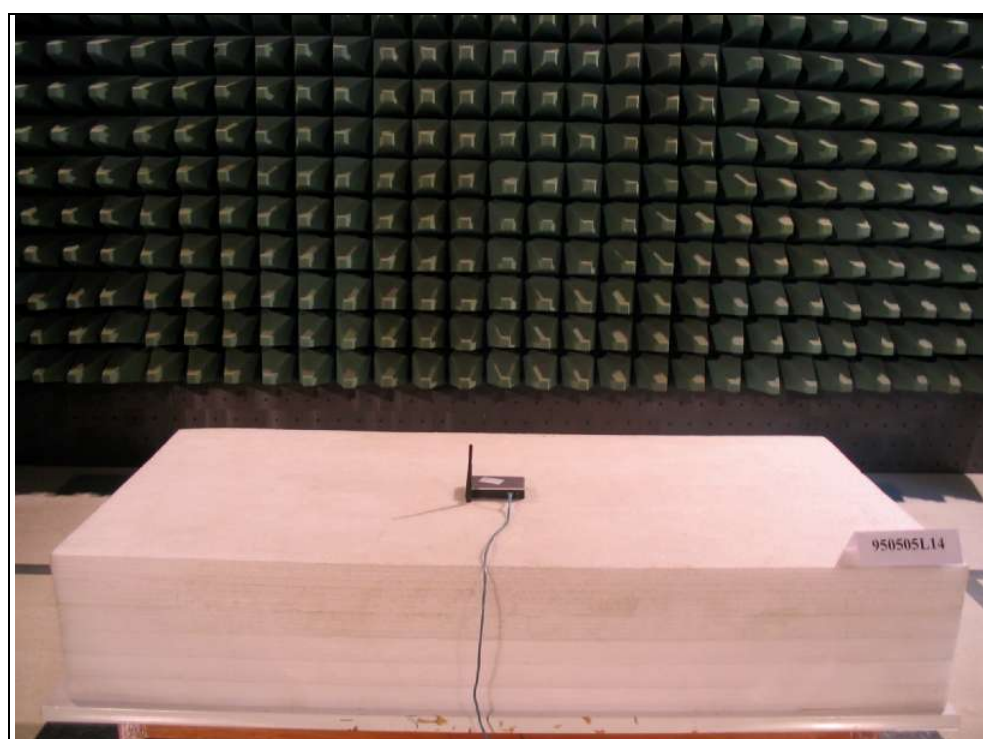
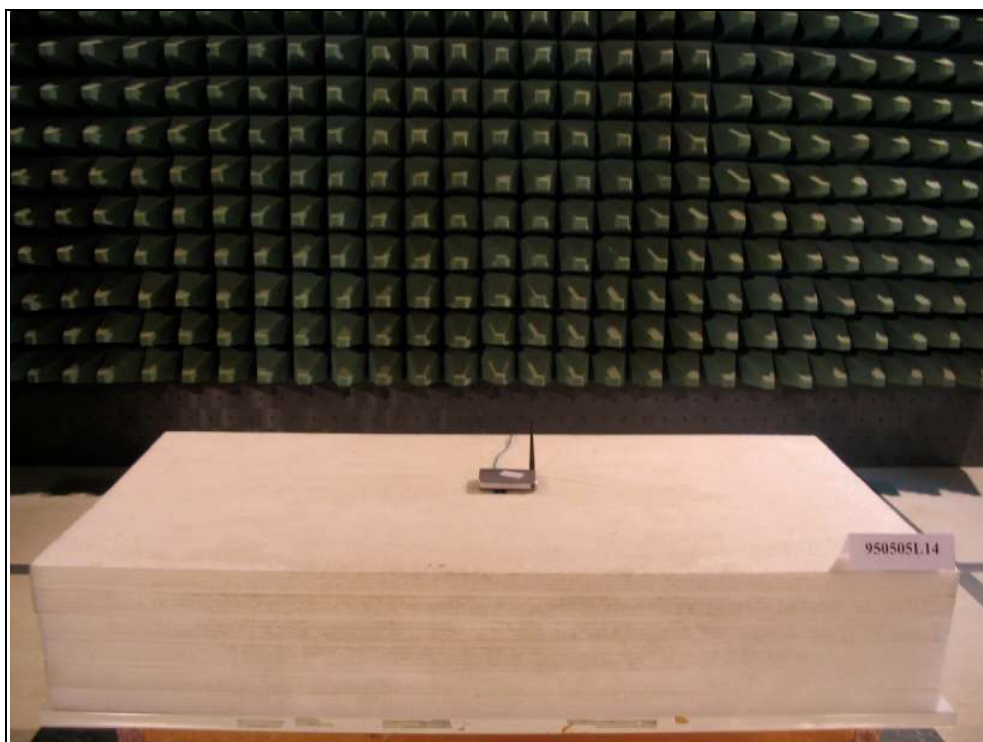



6. INFORMATION ON THE TESTING LABORATORIES

We, ADT Corp., were founded in 1988 to provide our best service in EMC, Radio, Telecom and Safety consultation. Our laboratories are accredited and approved by the following approval agencies according to ISO/IEC 17025.

USA	FCC, NVLAP, A2LA
Germany	TUV Rheinland
Japan	VCCI
Norway	NEMKO
Canada	INDUSTRY CANADA , CSA
R.O.C.	CNLA, BSMI, DGT
Netherlands	Telefication
Singapore	PSB , GOST-ASIA(MOU)
Russia	CERTIS(MOU)

Copies of accreditation certificates of our laboratories obtained from approval agencies can be downloaded from our web site:

www.adt.com.tw/index.5/phtml. If you have any comments, please feel free to contact us at the following:

Linko EMC/RF Lab:
Tel: 886-2-26052180
Fax: 886-2-26052943

Hsin Chu EMC/RF Lab:
Tel: 886-3-5935343
Fax: 886-3-5935342

Hwa Ya EMC/RF/Safety Telecom Lab:
Tel: 886-3-3183232
Fax: 886-3-3185050

Linko RF Lab.
Tel: 886-3-3270910
Fax: 886-3-3270892

Web Site: www.adt.com.tw

The address and road map of all our labs can be found in our web site also



APPENDIX-A

MODIFICATIONS RECORDERS FOR ENGINEERING CHANGES TO THE EUT BY THE LAB

No any modifications are made to the EUT by the lab during the test.