



SPORTON International Inc.

No. 52, Hwa Ya 1st Rd., Kwei-Shan Hsiang, TaoYuan Hsien, Taiwan, R.O.C.
Ph: 886-3-327-3456 / FAX: 886-3-327-0973 / www.sporton.com.tw

FCC RADIO TEST REPORT

Applicant's company	U-MEDIA Communications, Inc.
Applicant Address	9F, No. 1, Jin-Shan 7th St., Hsinchu 300, Taiwan, R.O.C.
FCC ID	SI5BRC220
Manufacturer's company	U-MEDIA Communications, Inc.
Manufacturer Address	9F, No. 1, Jin-Shan 7th St., Hsinchu 300, Taiwan, R.O.C.

Product Name	Bidirectional Remote Control
Brand Name	U-MEDIA
Model Name	BRC-220
Test Rule	47 CFR FCC Part 15 Subpart C § 15.247
Test Freq. Range	2400 ~ 2483.5MHz
Received Date	Nov. 15, 2006
Final Test Date	Dec. 4, 2006
Submission Type	Original Equipment



Statement

Test result included is only for the Bluetooth part of the product.

The test result in this report refers exclusively to the presented test model / sample.

Without written approval of SPORTON International Inc., the test report shall not be reproduced except in full.

The measurements and test results shown in this test report were made in accordance with the procedures and found in compliance with the limit given in **ANSI C63.4-2003** and **47 CFR FCC Part 15 Subpart C**.

The test equipment used to perform the test is calibrated and traceable to NML/ROC.

Table of Contents

1. CERTIFICATE OF COMPLIANCE	1
2. SUMMARY OF THE TEST RESULT	2
3. GENERAL INFORMATION	3
3.1. Product Details.....	3
3.2. Accessories.....	3
3.3. Table for Filed Antenna.....	3
3.4. Table for Carrier Frequencies	4
3.5. Table for Test Modes	4
3.6. Table for Testing Locations.....	5
3.7. Table for Supporting Units	5
3.8. Table for Parameters of Test Software Setting	5
3.9. Test Configurations	6
4. TEST RESULT	8
4.1. AC Power Line Conducted Emissions Measurement.....	8
4.2. Maximum Peak Output Power Measurement	13
4.3. Hopping Channel Separation Measurement	15
4.4. Number of Hopping Frequency Measurement.....	20
4.5. Dwell Time Measurement.....	22
4.6. Radiated Emissions Measurement	29
4.7. Band Edge Emissions Measurement	41
4.8. Antenna Requirements	45
5. LIST OF MEASURING EQUIPMENTS	46
6. TEST LOCATION.....	48
APPENDIX A. PHOTOGRAPHS OF EUT.....	A1 ~ A16
APPENDIX B. TEST PHOTOS.....	B1 ~ B5
APPENDIX C. MAXIMUM PERMISSIBLE EXPOSURE.....	C1 ~ C3



1. CERTIFICATE OF COMPLIANCE

Product Name : Bidirectional Remote Control
Brand Name : U-MEDIA
Model Name : BRC-220
Applicant : U-MEDIA Communications, Inc.
Test Rule Part(s) : 47 CFR FCC Part 15 Subpart C § 15.247

Sporston International as requested by the applicant to evaluate the EMC performance of the product sample received on Nov. 15, 2006 would like to declare that the tested sample has been evaluated and found to be in compliance with the tested rule parts. The data recorded as well as the test configuration specified is true and accurate for showing the sample's EMC nature.

Mandy Liang 12.12.2006
Prepared By:
Mandy Liang / Specialist

Steven Lu 12.12.06
Tested By:
Steven Lu / Engineer

Wayne Hsu 12.12.06
Reviewed By:
Wayne Hsu

2. SUMMARY OF THE TEST RESULT

Applied Standard: 47 CFR FCC Part 15 Subpart C				
Part	Rule Section	Description of Test	Result	Under Limit
4.1	15.207	AC Power Line Conducted Emissions	Complies	16.69 dB
4.2	15.247(b)(1)	Maximum Peak Conducted Output Power	Complies	15.67 dB
4.3	15.247(a)(1)	Hopping Channel Separation	Complies	-
4.4	15.247(b)(1)	Number of Hopping Frequency	Complies	-
4.5	15.247(a)(1)	Dwell Time	Complies	-
4.6	15.247(d)	Radiated Emissions	Complies	3.06 dB
4.7	15.247(d)	Band Edge Emissions	Complies	2.73 dB
4.8	15.203	Antenna Requirements	Complies	-

Test Items	Uncertainty	Remark
AC Power Line Conducted Emissions	±2.3dB	Confidence levels of 95%
Maximum Peak Conducted Output Power	±0.8dB	Confidence levels of 95%
Hopping Channel Separation	±8.5×10 ⁻⁸	Confidence levels of 95%
Radiated Emissions (9kHz~30MHz)	±0.8dB	Confidence levels of 95%
Radiated Emissions (30MHz~1000MHz)	±1.9dB	Confidence levels of 95%
Radiated / Band Edge Emissions (1GHz~18GHz)	±1.9dB	Confidence levels of 95%
Radiated Emissions (18GHz~40GHz)	±1.9dB	Confidence levels of 95%
Temperature	±0.7°C	Confidence levels of 95%
Humidity	±3.2%	Confidence levels of 95%
DC / AC Power Source	±1.4%	Confidence levels of 95%

3. GENERAL INFORMATION

3.1. Product Details

Items	Description
Power Type	Power Adapter / From host system / Li-ion Battery
Modulation	FHSS (GFSK / $\pi/4$ -DQPSK / 8DPSK)
Data Rate (Mbps)	GFSK: 1 ; $\pi/4$ -QPSK: 2 ; 8DPSK: 3
Frequency Range	2400 ~ 2483.5MHz
Channel Number	79
Channel Band Width (99%)	855.00 kHz
Conducted Output Power	13.31 dBm
Carrier Frequencies	Please refer to section 3.4
Antenna	Please refer to section 3.3

3.2. Accessories

Power	Brand	Model	Rating
Adapter 1	DVE	DSA-5P-05 FUS 050100	INPUT: 100-240VAC, 50/60Hz, 0.2A OUTPUT: +5VDC, 1A
Li-ion Battery	HECELL	H303482	Power: 3.7V

3.3. Table for Filed Antenna

Ant.	Brand	Model Name	Antenna Type	Connector	Gain (dBi)
1	-	-	Printed Antenna	NA	-0.81

3.4. Table for Carrier Frequencies

Frequency Band	Channel No.	Frequency
2400~2483.5MHz	0	2402 MHz
	1	2403 MHz
	:	:
	38	2440 MHz
	39	2441 MHz
	40	2442 MHz
	:	:
	77	2479 MHz
	78	2480 MHz

3.5. Table for Test Modes

Preliminary tests were performed in different data rate to find the worst radiated emission. The data rate shown in the table below is the worst-case rate with respect to the specific test item. Investigation has been done on all the possible configurations for searching the worst cases. The following table is a list of the test modes shown in this test report.

Test Items	Mode	Data Rate	Channel	Antenna
AC Power Conducted Emissions	Mode 2	3 Mbps	Hopping 0~78	1
Max. Conducted Output Power	8DPSK	3 Mbps	0/39/78	NA
Hopping Channel Separation	8DPSK	3 Mbps	0~1/39~40/77~78	NA
Number of Hopping Frequency	8DPSK	3 Mbps	0~78	NA
Dwell Time	DH1/DH3/DH5	3 Mbps	0/39/78	NA
Radiated Emissions Below 1GHz	8DPSK	3 Mbps	39	1
Radiated Emissions Above 1GHz	8DPSK	3 Mbps	0/39/78	1
Band Edge Emissions	8DPSK	3 Mbps	0/78	1

Note:

CTX1 =Continuously transmitting and audio modulating content a range of 100 to 5000 Hz.

Test Mode:

Mode 1: EUT+Adapter

Mode 2: EUT+Cradle

For AC Power Conducted Emissions, Mode 2 generated the worst test result, so it was recorded in this report.

3.6. Table for Testing Locations

Test Site No.	Site Category	Location	FCC Reg. No.	IC File No.	VCCI Reg. No
03CH03-HY	SAC	Hwa Ya	101377	IC 4088	-
CO04-HY	Conduction	Hwa Ya	101377	IC 4088	-
TH01-HY	OVEN Room	Hwa Ya	-	-	-

Open Area Test Site (OATS); Semi Anechoic Chamber (SAC); Fully Anechoic Chamber (FAC).

Please refer section 6 for Test Site Address.

3.7. Table for Supporting Units

Support Unit	Brand	Model	FCC ID
SPEAKER	DELL	A215	DoC
iPod	Apple	Shuffle	DoC
Wireless Audio Receiver	U-MEDIA	HCR-102	SI5HCR102

3.8. Table for Parameters of Test Software Setting

During testing, Channel & Power Controlling Software provided by the customer was used to control the operating channel as well as the output power level. The RF output power selection is for the setting of RF output power expected by the customer and is going to be fixed on the firmware of the final end product.

Power Parameters of Bluetooth

Test Software Version	Blue test		
Frequency	2402 MHz	2441 MHz	2480 MHz
Power Parameters	12	12	12

Executed "Bluetest" to control the EUT continuously transmit RF signal.

3.9. Test Configurations

3.9.1. Radiation Emissions Test Configuration

Test Configuration : 9kHz~1GHz

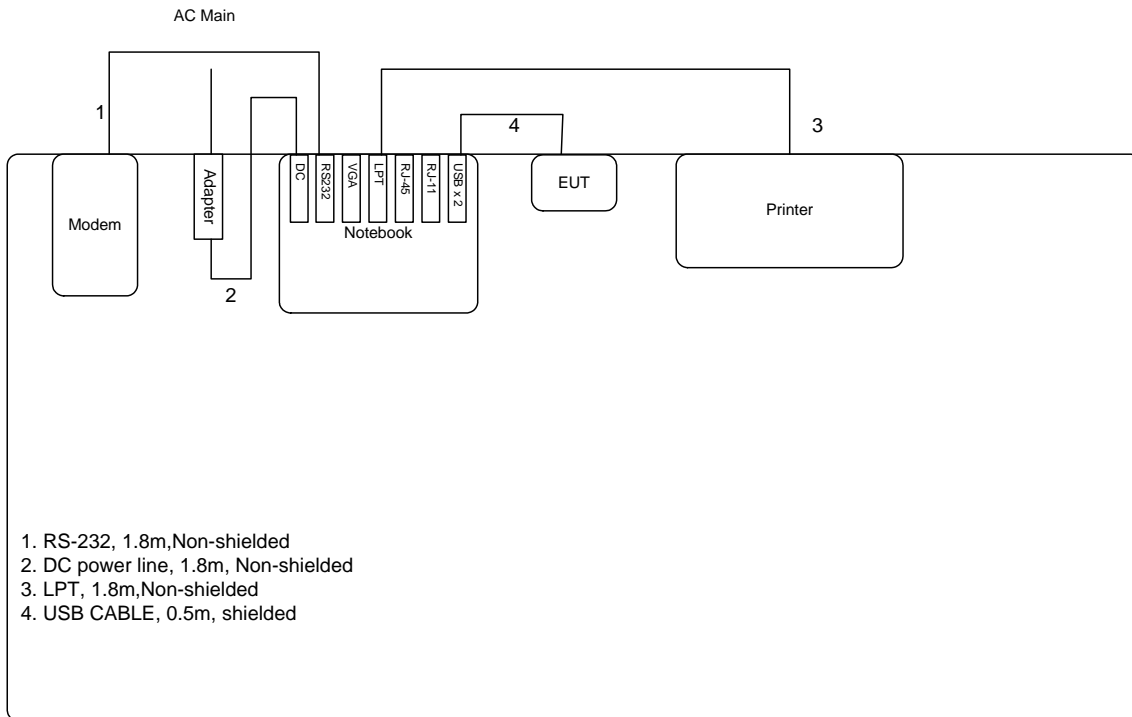

Test Configuration : Above 1GHz

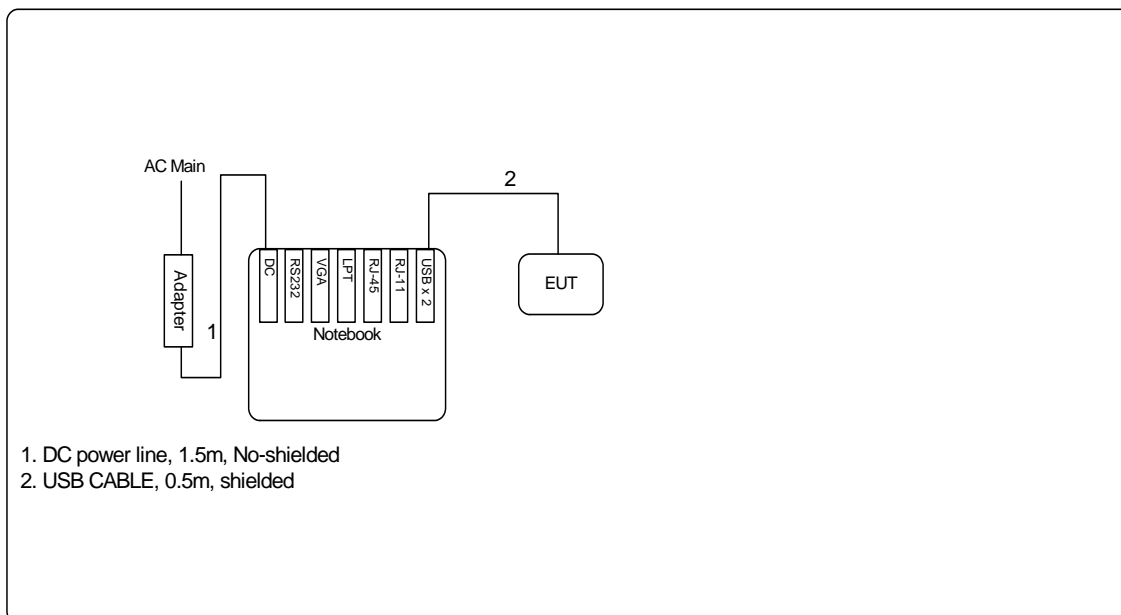

3.9.2. AC Power Line Conduction Emissions Test Configuration

Mode1

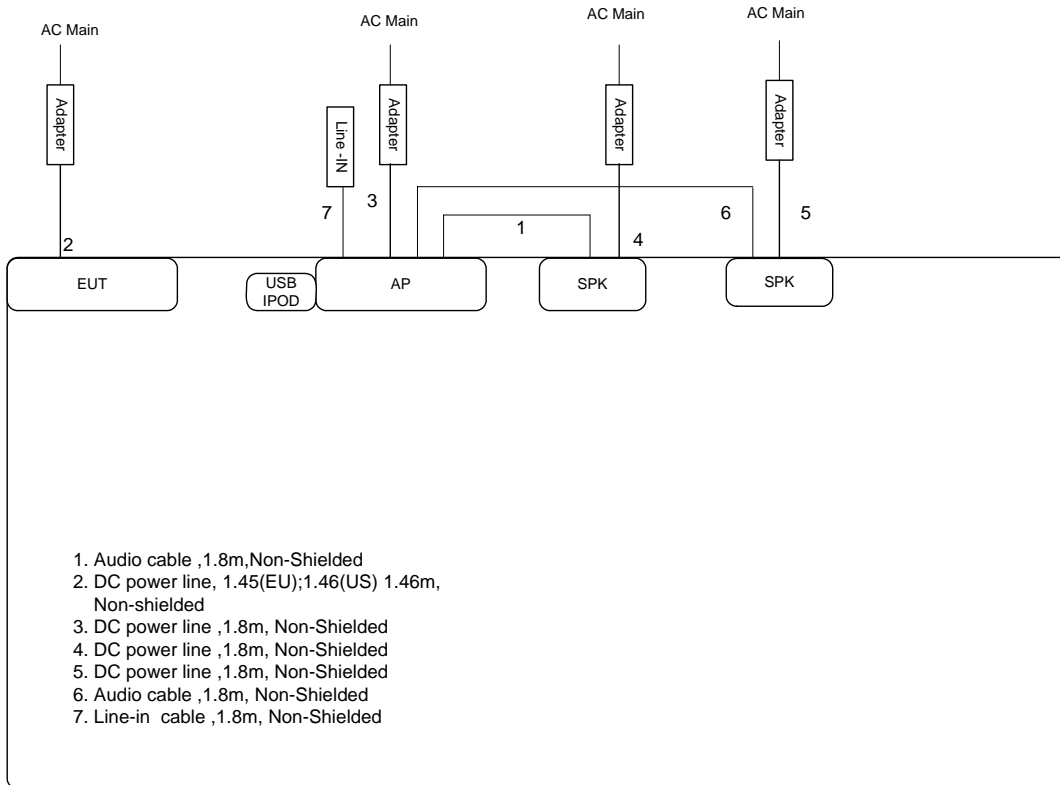

Mode2

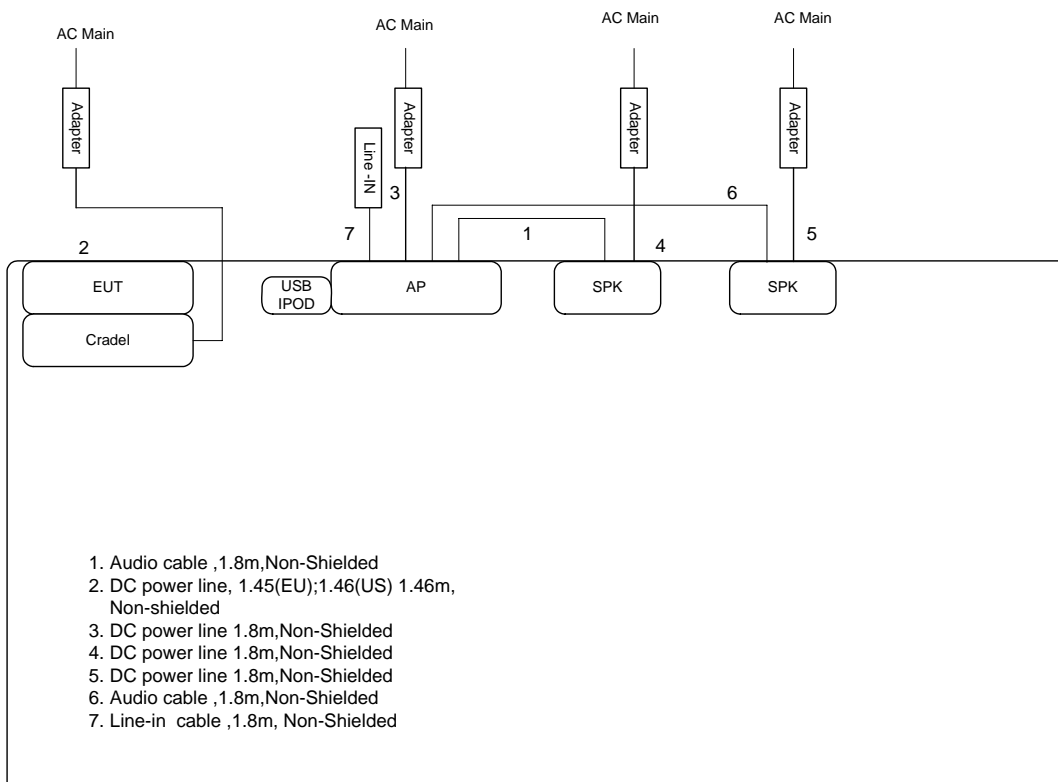

4. TEST RESULT

4.1. AC Power Line Conducted Emissions Measurement

4.1.1. Limit

For a Low-power Radio-frequency Device which is designed to be connected to the AC power line, the radio frequency voltage that is conducted back onto the AC power line on any frequency or frequencies within the band 150 kHz to 30 MHz shall not exceed below limits table.

Frequency (MHz)	QP Limit (dBuV)	AV Limit (dBuV)
0.15~0.5	66~56	56~46
0.5~5	56	46
5~30	60	50

4.1.2. Measuring Instruments and Setting

Please refer to section 5 of equipments list in this report. The following table is the setting of the receiver.

Receiver Parameters	Setting
Attenuation	10 dB
Start Frequency	0.15 MHz
Stop Frequency	30 MHz
IF Bandwidth	9 KHz

4.1.3. Test Procedures

1. Configure the EUT according to ANSI C63.4. The EUT or host of EUT has to be placed 0.4 meter far from the conducting wall of the shielding room and at least 80 centimeters from any other grounded conducting surface.
2. Connect EUT or host of EUT to the power mains through a line impedance stabilization network (LISN).
3. All the support units are connected to the other LISNs. The LISN should provide 50uH/50ohms coupling impedance.
4. The frequency range from 150 KHz to 30 MHz was searched.
5. Set the test-receiver system to Peak Detect Function and Specified Bandwidth with Maximum Hold Mode.
6. The measurement has to be done between each power line and ground at the power terminal.

4.1.5. Test Deviation

There is no deviation with the original standard.

4.1.6. EUT Operation during Test

The EUT was placed on the test table and programmed in normal function.

4.1.7. Results of AC Power Line Conducted Emissions Measurement

Temperature	24°C	Humidity	60%
Test Engineer	Johnson Chung	Phase	Line
Configuration	Normal Link / Mode 2		

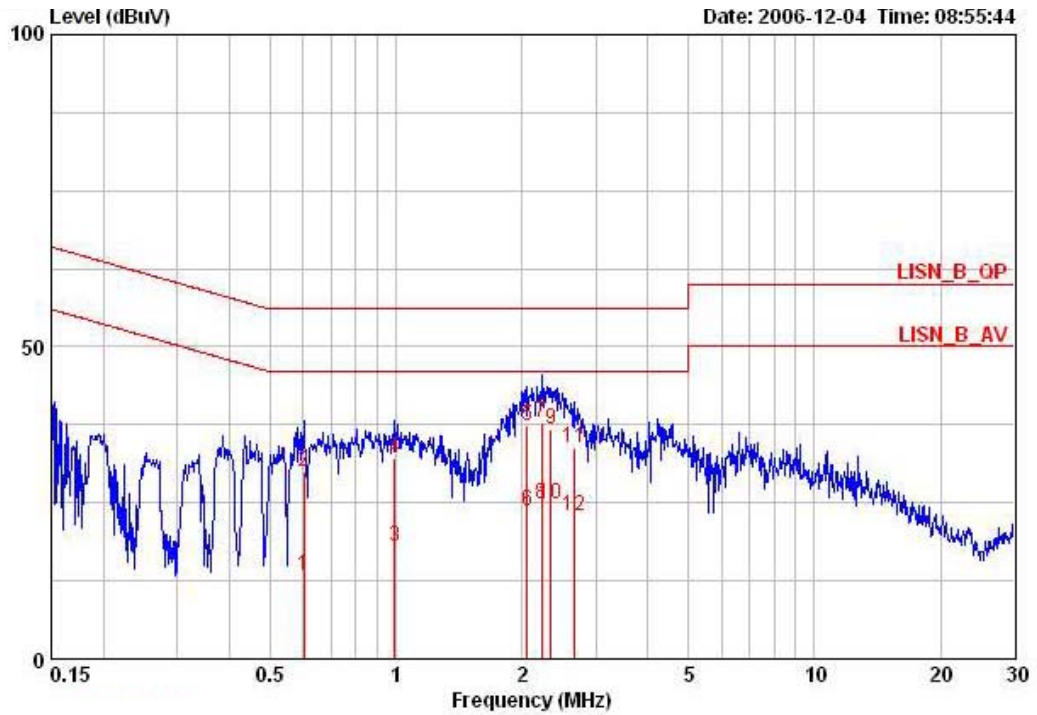

	Freq	Level	Over Limit	Limit Line	Read Level	LISN Factor	Cable Loss	Remark
	MHz	dBµV	dB	dBµV	dBµV	dB	dB	
1	0.60112	13.22	-32.78	46.00	13.02	0.00	0.20	AVERAGE
2	0.60112	30.10	-25.90	56.00	29.90	0.00	0.20	QP
3	0.99440	17.88	-28.12	46.00	17.68	0.00	0.20	AVERAGE
4	0.99440	32.12	-23.88	56.00	31.92	0.00	0.20	QP
5	2.055	37.37	-18.63	56.00	37.17	0.00	0.20	QP
6	2.055	23.81	-22.19	46.00	23.61	0.00	0.20	AVERAGE
7	2.225	37.80	-18.20	56.00	37.60	0.00	0.20	QP
8	2.225	24.78	-21.22	46.00	24.58	0.00	0.20	AVERAGE
9	2.346	36.85	-19.15	56.00	36.65	0.00	0.20	QP
10	2.346	24.70	-21.30	46.00	24.50	0.00	0.20	AVERAGE
11	2.664	33.86	-22.14	56.00	33.66	0.00	0.20	QP
12	2.664	22.95	-23.05	46.00	22.75	0.00	0.20	AVERAGE

Temperature	24°C	Humidity	60%
Test Engineer	Johnson Chung	Phase	Neutral
Configuration	Normal Link / Mode 2		

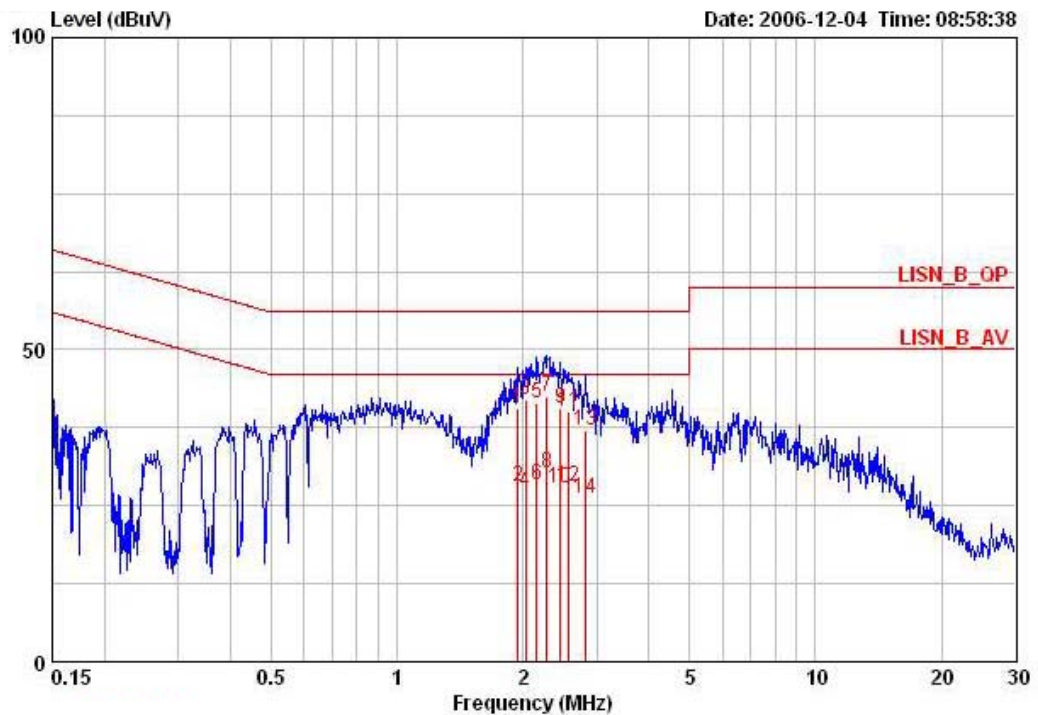

	Freq	Level	Over	Limit	Read	LISN	Cable	
	MHz	dBuV	Limit	Line	Level	Factor	Loss	Remark
			dB	dBuV	dBuV	dB	dB	
1	1.949	40.73	-15.27	56.00	40.54	0.00	0.19	QP
2	1.949	28.17	-17.83	46.00	27.98	0.00	0.19	AVERAGE
3	2.033	42.00	-14.00	56.00	41.80	0.00	0.20	QP
4	2.033	27.15	-18.85	46.00	26.95	0.00	0.20	AVERAGE
5	2.155	41.35	-14.65	56.00	41.15	0.00	0.20	QP
6	2.155	28.33	-17.67	46.00	28.13	0.00	0.20	AVERAGE
7	2.285	42.42	-13.58	56.00	42.22	0.00	0.20	QP
8	2.285	30.32	-15.68	46.00	30.12	0.00	0.20	AVERAGE
9	2.461	40.71	-15.29	56.00	40.51	0.00	0.20	QP
10	2.461	27.77	-18.23	46.00	27.57	0.00	0.20	AVERAGE
11	2.567	40.13	-15.87	56.00	39.93	0.00	0.20	QP
12	2.567	27.93	-18.07	46.00	27.73	0.00	0.20	AVERAGE
13	2.824	37.17	-18.83	56.00	36.97	0.00	0.20	QP
14	2.824	26.22	-19.78	46.00	26.02	0.00	0.20	AVERAGE

Note:

Level = Read Level + LISN Factor + Cable Loss.

4.2. Maximum Peak Output Power Measurement

4.2.1. Limit

For frequency hopping systems operating in the 2400-2483.5 MHz band employing at least 75 non-overlapping hopping channels, the limit for peak output power is 30dBm. The limited has to be reduced by the amount in dB that the gain of the antenna exceed 6dBi. In case of point-to-point operation, the limit has to be reduced by 1dB for every 3dB that the directional gain of the antenna exceeds 6dBi.

4.2.2. Measuring Instruments and Setting

Please refer to section 5 of equipments list in this report. The following table is the setting of the power meter.

Power Meter Parameter	Setting
Filter No.	Auto
Measurement time	0.135 s ~ 26 s
Used Peak Sensor	NRV-Z32 (model 04)

4.2.3. Test Procedures

1. The transmitter output (antenna port) was connected to the power meter.
2. Turn on the EUT and power meter and then record the peak power value.
3. Repeat above procedures on all channels needed to be tested.

4.2.4. Test Setup Layout

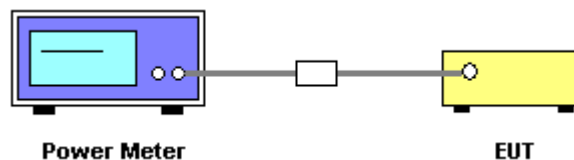

4.2.5. Test Deviation

There is no deviation with the original standard.

4.2.6. EUT Operation during Test

The EUT was programmed to be in continuously transmitting mode.

4.2.7. Test Result of Maximum Peak Output Power

Temperature	24°C	Humidity	58%
Test Engineer	Leo Hung	Configurations	8DPSK

Channel	Frequency	Conducted Power (dBm)	Max. Limit (dBm)	Result
0	2402 MHz	13.29	30.00	Complies
39	2441 MHz	13.31	30.00	Complies
78	2480 MHz	13.11	30.00	Complies

4.3. Hopping Channel Separation Measurement

4.3.1. Limit

Frequency hopping systems shall have hopping channel carrier frequencies separated by a minimum of 25 kHz or the 20 dB bandwidth of the hopping channel, whichever is greater.

4.3.2. Measuring Instruments and Setting

Please refer to section 5 of equipments list in this report. The following table is the setting of spectrum analyzer.

Spectrum Parameter	Setting
Attenuation	Auto
Span Frequency	> Measurement Bandwidth or Channel Separation
RB	30 kHz (20dB Bandwidth) / 100 kHz (Channel Separation)
VB	100 kHz (20dB Bandwidth) / 300 kHz (Channel Separation)
Detector	Peak
Trace	Max Hold
Sweep Time	Auto

4.3.3. Test Procedures

1. The transmitter output (antenna port) was connected to the spectrum analyser in peak hold mode.
2. The resolution bandwidth of 30 kHz and the video bandwidth of 100 kHz were utilised for 20 dB bandwidth measurement.
3. The resolution bandwidth of 100 kHz and the video bandwidth of 300 kHz were utilised for channel separation measurement.

4.3.4. Test Setup Layout

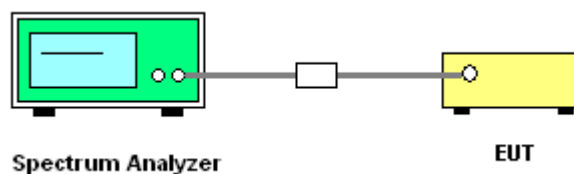

4.3.5. Test Deviation

There is no deviation with the original standard.

4.3.6. EUT Operation during Test

The EUT was programmed to be in continuously transmitting mode.

4.3.7. Test Result of Hopping Channel Separation

Temperature	24°C	Humidity	58%
Test Engineer	Leo Hung	Configurations	8DPSK

Frequency	Ch. Separation (MHz)	20dB Bandwidth (kHz)	99% Occupied Bandwidth (kHz)	Result
2402 MHz	1.00	810.00	852.00	Complies
2441 MHz	1.00	819.00	855.00	Complies
2480 MHz	1.00	825.00	855.00	Complies

Ch. Separation Limits: >20dB bandwidth or >2/3 of 20dB bandwidth

20 dB Bandwidth Plot on Channel 0 / 2402 MHz

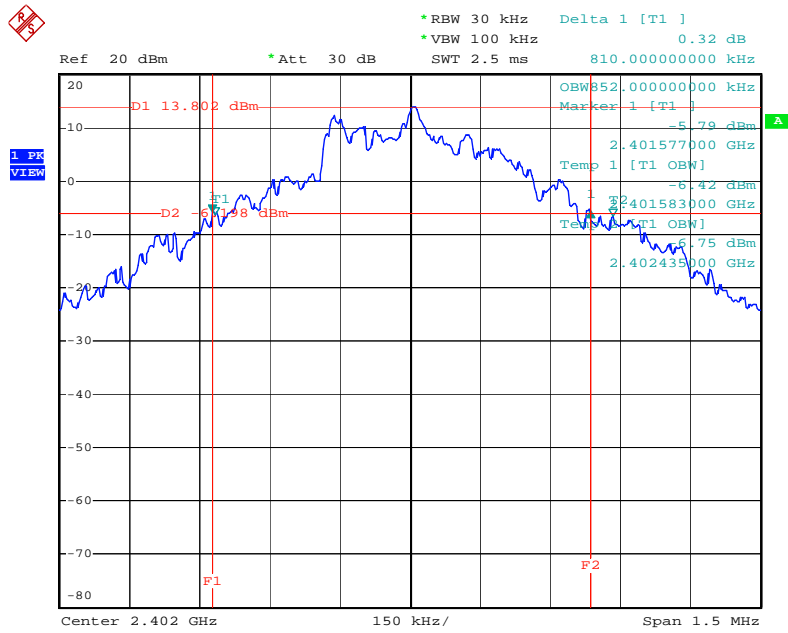

Date: 28.NOV.2006 20:04:00

20 dB Bandwidth Plot on Channel 39 / 2441 MHz



Date: 28.NOV.2006 20:07:09

20 dB Bandwidth Plot on Channel 78 / 2480 MHz

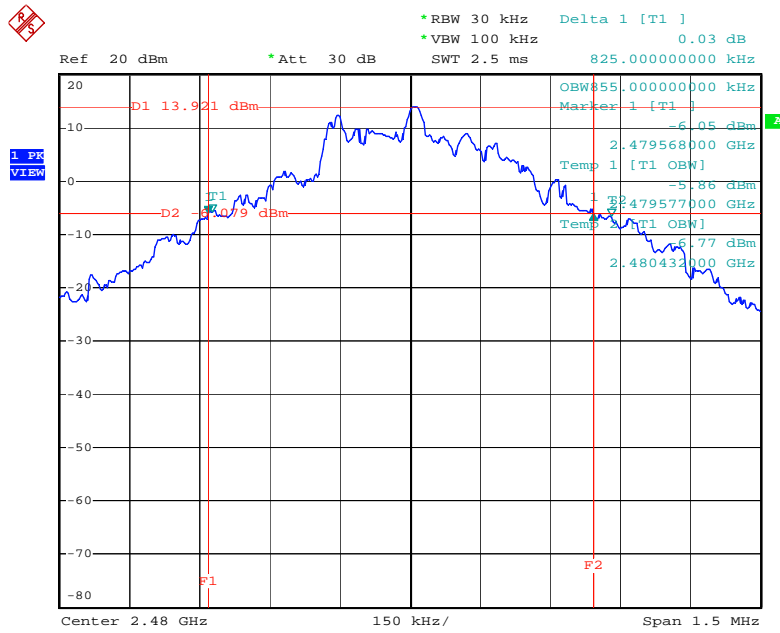

Date: 28.NOV.2006 20:08:54

Channel Separation Plot on Channel 0~1 / 2402 MHz ~ 2403 MHz

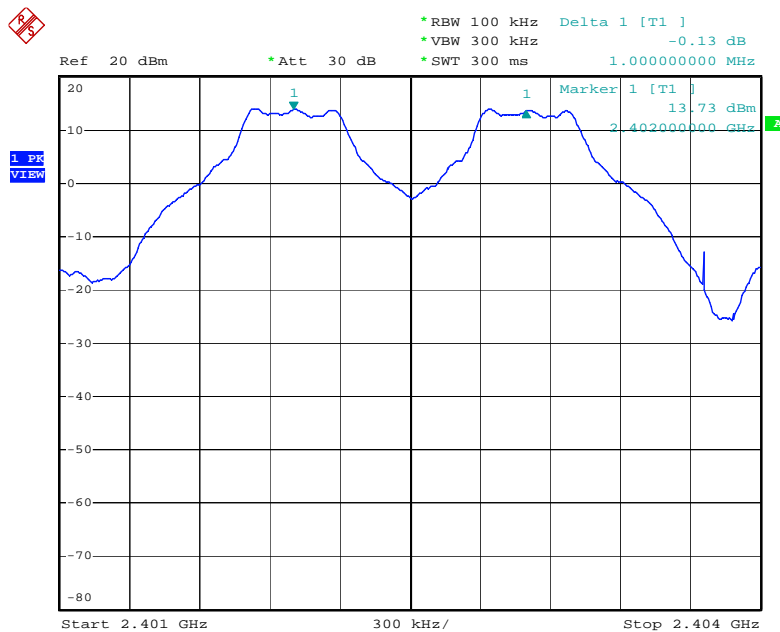

Date: 28.NOV.2006 20:03:52

Channel Separation Plot on Channel 39~40 / 2441 MHz ~ 2442 MHz

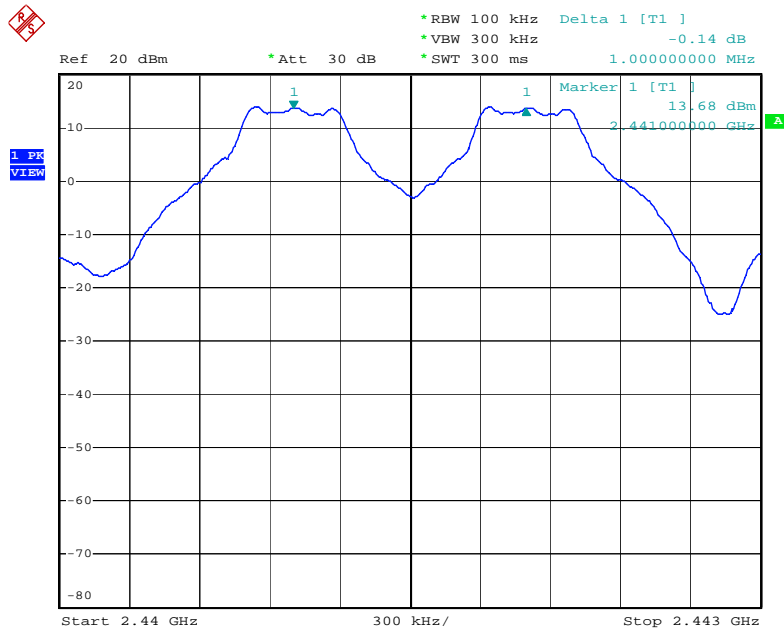

Date: 28.NOV.2006 20:07:01

Channel Separation Plot on Channel 77~78 / 2479 MHz ~ 2480 MHz

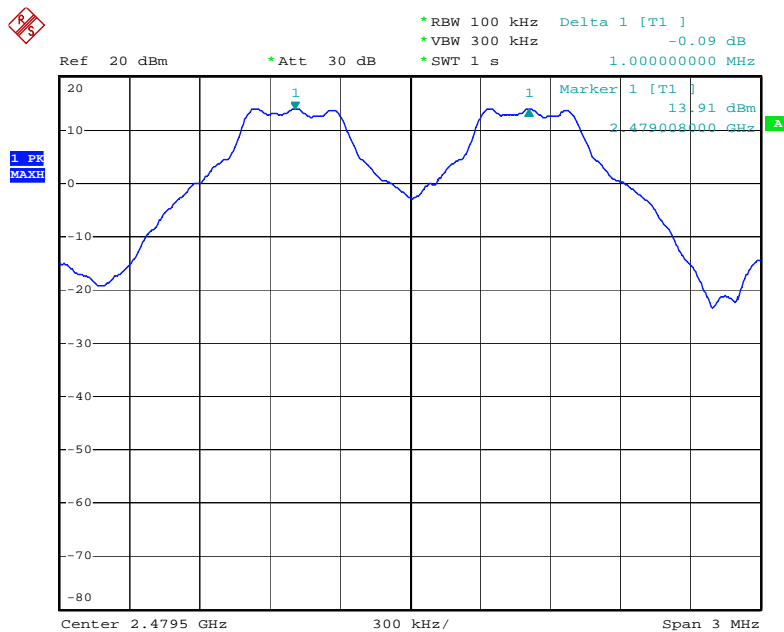

Date: 28.NOV.2006 20:11:10

4.4. Number of Hopping Frequency Measurement

4.4.1. Limit

For frequency hopping systems operating in the 2400-2483.5 MHz band employing at least 75 non-overlapping hopping channels.

4.4.2. Measuring Instruments and Setting

Please refer to section 5 of equipments list in this report. The following table is the setting of spectrum analyzer.

Spectrum Parameters	Setting
Attenuation	Auto
Span Frequency	> Operating Frequency Range
RB	100 kHz
VB	100 kHz
Detector	Peak
Trace	Max Hold
Sweep Time	Auto

4.4.3. Test Procedures

1. The transmitter output (antenna port) was connected to the spectrum analyser in peak hold mode.
2. The resolution bandwidth of 100 kHz and the video bandwidth of 100 kHz were utilised.
3. Observe frequency hopping in 2400MHz~2483.5MHz, there are at least 75 non-overlapping channels.

4.4.4. Test Setup Layout

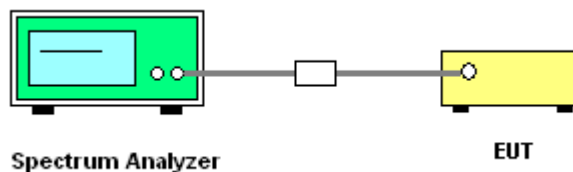

4.4.5. Test Deviation

There is no deviation with the original standard.

4.4.6. EUT Operation during Test

The EUT was programmed to be in continuously transmitting mode.

4.4.7. Test Result of Number of Hopping Frequency

Temperature	24°C	Humidity	58%
Test Engineer	Leo Hung	Configurations	8DPSK

Modulation Type	Channel No.	Frequency (MHz)	Hopping Ch. (Channels)	Min. Limit (Channels)	Test Result
GFSK	0 ~ 78	2402 ~ 2480	79	75	Complies

Number of Hopping Channel Plot on Channel 0~78 / 2402 MHz ~ 2480 MHz

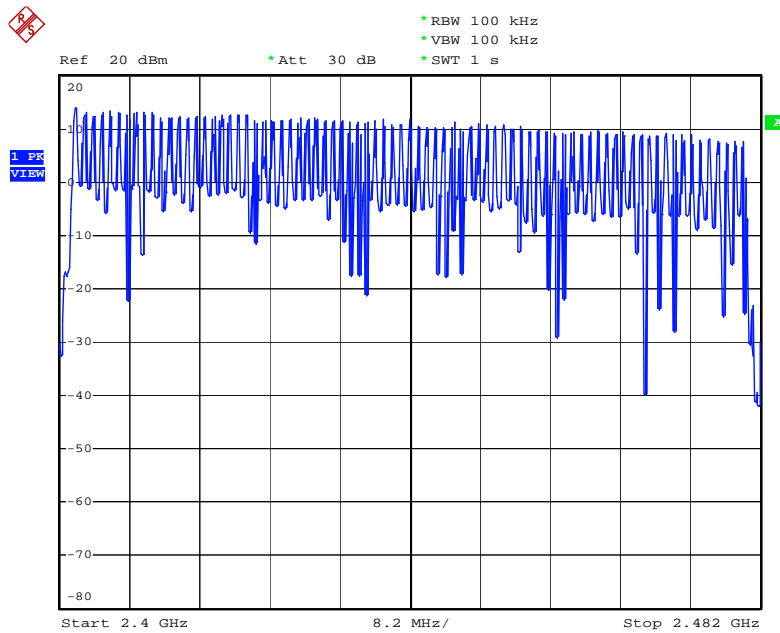

Date: 28.NOV.2006 20:05:46

4.5. Dwell Time Measurement

4.5.1. Limit

Frequency hopping systems in the 2400-2483.5 MHz band shall use at least 15 channels. The average time of occupancy on any channel shall not be greater than 0.4 seconds within a period of 0.4 seconds multiplied by the number of hopping channels employed.

4.5.2. Measuring Instruments and Setting

Please refer to section 5 of equipments list in this report. The following table is the setting of spectrum analyzer.

Spectrum Parameter	Setting
Attenuation	Auto
Span Frequency	0 MHz
RB	1000 kHz
VB	1000 kHz
Detector	Peak
Trace	Single Trigger

4.5.3. Test Procedures

1. The transmitter output (antenna port) was connected to the spectrum analyser
2. Set RBW of spectrum analyzer to 1000kHz and VBW to 1000kHz.
3. Use a video trigger with the trigger level set to enable triggering only on full pulses.
4. Sweep Time is more than once pulse time.
5. Set the center frequency on any frequency would be measure and set the frequency span to zero span.
6. Measure the maximum time duration of one single pulse.
7. Set the EUT for DH5, DH3 and DH1 packet transmitting.
8. Measure the maximum time duration of one single pulse.
9. DH5 Packet permit maximum $1600 / 79 / 6 = 3.37$ hops per second in each channel (5 time slots RX, 1 time slot TX). So, the dwell time is the time duration of the pulse times $3.37 \times 31.6 = 106.6$ within 31.6 seconds
10. DH3 Packet permit maximum $1600 / 79 / 4 = 5.06$ hops per second in each channel (3 time slots RX, 1 time slot TX). So, the dwell time is the time duration of the pulse times $5.06 \times 31.6 = 160$ within 31.6 seconds.
11. DH1 Packet permit maximum $1600 / 79 / 2 = 10.12$ hops per second in each channel (1 time slot RX, 1 time slot TX). So, the dwell time is the time duration of the pulse times $10.12 \times 31.6 = 320$ within 31.6 seconds.

4.5.4. Test Setup Layout

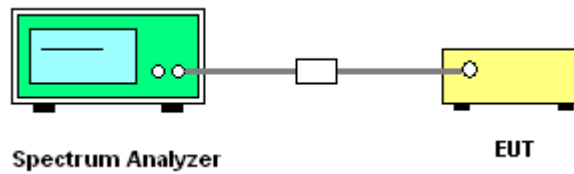

4.5.5. Test Deviation

There is no deviation with the original standard.

4.5.6. EUT Operation during Test

The EUT was programmed to be in continuously transmitting mode.

4.5.7. Test Result of Dwell Time

Temperature	24°C	Humidity	58%
Test Engineer	Leo Hung	Configurations	DH1, DH3, DH5

Data Packet	Frequency	Pulse Duration (ms)	Dwell Time (s)	Limits (s)	Test Result
DH5	2402 MHz	3.1050	0.3312	0.4000	Complies
DH3	2402 MHz	1.8450	0.2952	0.4000	Complies
DH1	2402 MHz	0.5800	0.1856	0.4000	Complies
DH5	2441 MHz	3.1250	0.3333	0.4000	Complies
DH3	2441 MHz	1.8350	0.2936	0.4000	Complies
DH1	2441 MHz	0.5750	0.1840	0.4000	Complies
DH5	2480 MHz	3.0950	0.3301	0.4000	Complies
DH3	2480 MHz	1.8350	0.2936	0.4000	Complies
DH1	2480 MHz	0.5700	0.1824	0.4000	Complies

DH5 Dwell Time Plot on Channel 0 / 2402 MHz

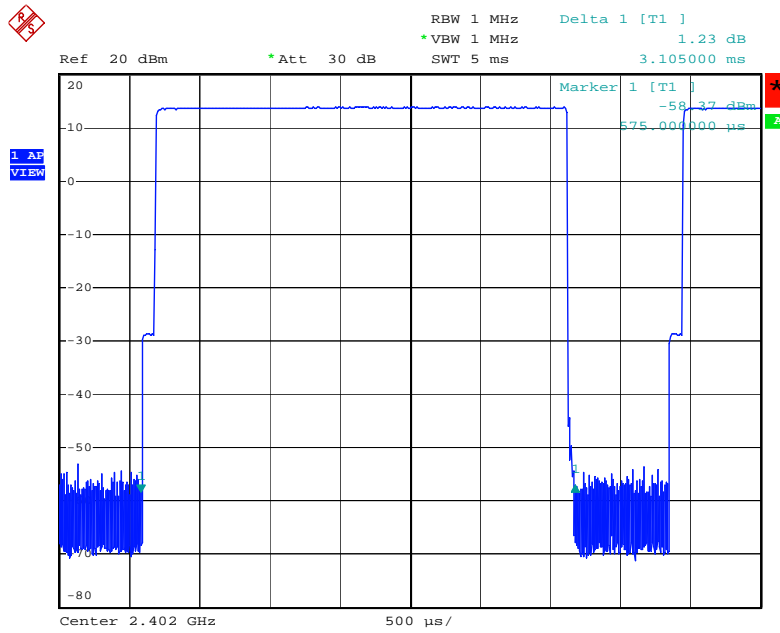

Date: 28.NOV.2006 20:26:10

DH3 Dwell Time Plot on Channel 0 / 2402 MHz

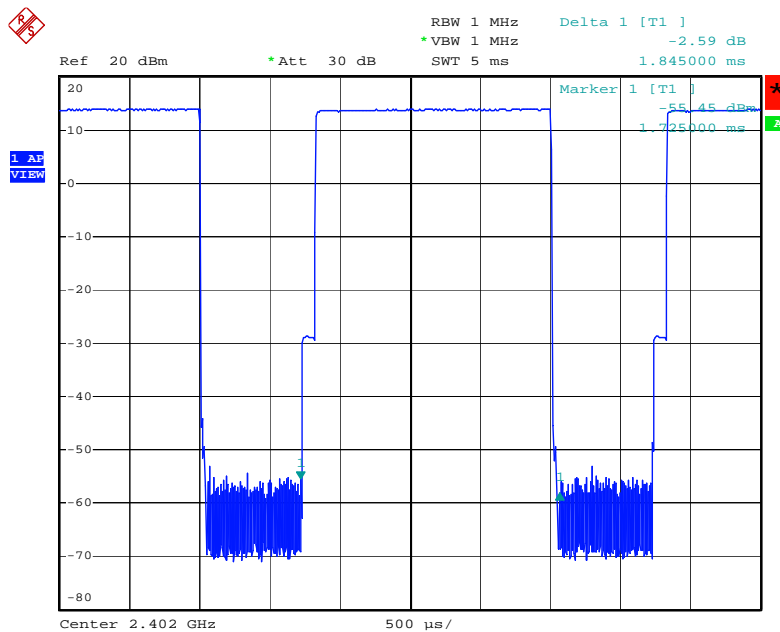

Date: 28.NOV.2006 20:27:07

DH1 Dwell Time Plot on Channel 0 / 2402 MHz

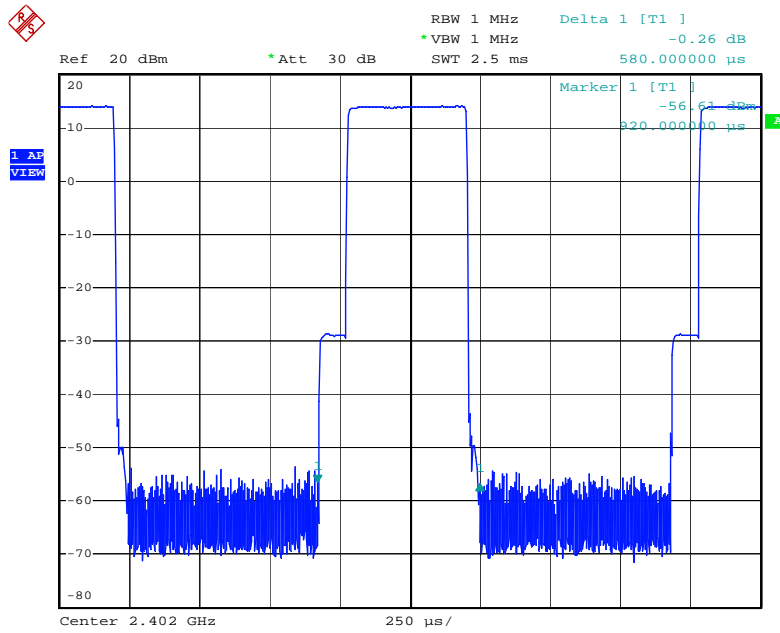

Date: 28.NOV.2006 20:21:53

DH5 Dwell Time Plot on Channel 39 / 2441 MHz

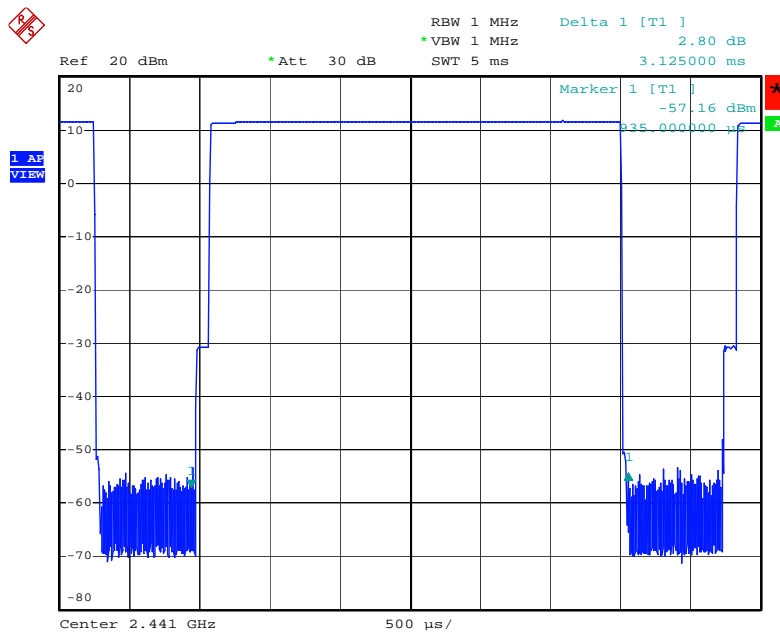

Date: 28.NOV.2006 20:25:41

DH3 Dwell Time Plot on Channel 39 / 2441 MHz

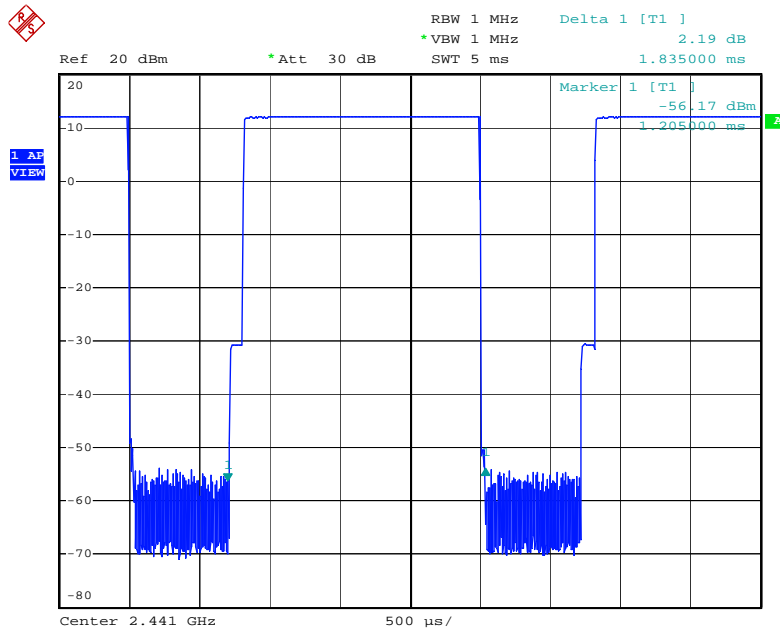

Date: 28.NOV.2006 20:27:41

DH1 Dwell Time Plot on Channel 39 / 2441 MHz

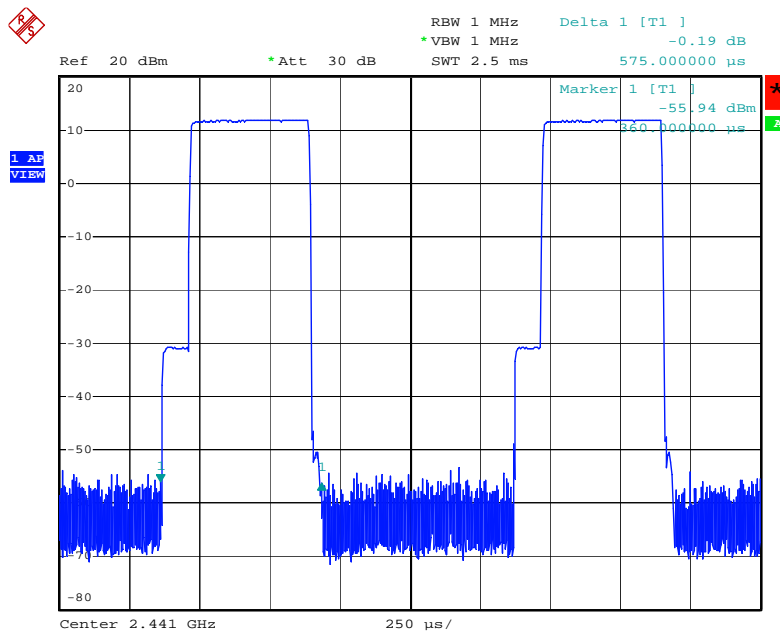

Date: 28.NOV.2006 20:22:20

4.6. Radiated Emissions Measurement

4.6.1. Limit

20dBc in any 100 kHz bandwidth outside the operating frequency band. In case the emission fall within the restricted band specified on 15.205(a), then the 15.209(a) limit in the table below has to be followed.

Frequencies (MHz)	Field Strength (micorvolts/meter)	Measurement Distance (meters)
0.009~0.490	2400/F(KHz)	300
0.490~1.705	24000/F(KHz)	30
1.705~30.0	30	30
30~88	100	3
88~216	150	3
216~960	200	3
Above 960	500	3

4.6.2. Measuring Instruments and Setting

Please refer to section 5 of equipments list in this report. The following table is the setting of spectrum analyzer and receiver.

Spectrum Parameter	Setting
Attenuation	Auto
Start Frequency	1000 MHz
Stop Frequency	10th carrier harmonic
RB / VB (Emission in restricted band)	1MHz / 1MHz for Peak, 1 MHz / 10Hz for Average
RB / VB (Emission in non-restricted band)	1000KHz / 1000KHz for peak

Receiver Parameter	Setting
Attenuation	Auto
Start ~ Stop Frequency	9kHz~150kHz / RB 200Hz for QP
Start ~ Stop Frequency	150kHz~30MHz / RB 9kHz for QP
Start ~ Stop Frequency	30MHz~1000MHz / RB 120kHz for QP

4.6.3. Test Procedures

1. Configure the EUT according to ANSI C63.4. The EUT was placed on the top of the turntable 0.8 meter above ground. The phase center of the receiving antenna mounted on the top of a height-variable antenna tower was placed 3 meters far away from the turntable.
2. Power on the EUT and all the supporting units. The turntable was rotated by 360 degrees to determine the position of the highest radiation.
3. The height of the broadband receiving antenna was varied between one meter and four meters above ground to find the maximum emissions field strength of both horizontal and vertical polarization.
4. For each suspected emissions, the antenna tower was scan (from 1 M to 4 M) and then the turntable was rotated (from 0 degree to 360 degrees) to find the maximum reading.
5. Set the test-receiver system to Peak or CISPR quasi-peak Detect Function with specified bandwidth under Maximum Hold Mode.
6. For emissions above 1GHz, use 1MHz VBW and RBW for peak reading. Then 1MHz RBW and 10Hz VBW for average reading in spectrum analyzer.
7. When the radiated emissions limits are expressed in terms of the average value of the emissions, and pulsed operation is employed, the measurement field strength shall be determined by averaging over one complete pulse train, including blanking intervals, as long as the pulse train does not exceed 0.1 seconds. As an alternative (provided the transmitter operates for longer than 0.1 seconds) or in cases where the pulse train exceeds 0.1 seconds, the measured field strength shall be determined from the average absolute voltage during a 0.1 second interval during which the field strength is at its maximum value.
8. If the emissions level of the EUT in peak mode was 3 dB lower than the average limit specified, then testing will be stopped and peak values of EUT will be reported, otherwise, the emissions which do not have 3 dB margin will be repeated one by one using the quasi-peak method for below 1GHz.
9. For testing above 1GHz, the emissions level of the EUT in peak mode was lower than average limit (that means the emissions level in peak mode also complies with the limit in average mode), then testing will be stopped and peak values of EUT will be reported, otherwise, the emissions will be measured in average mode again and reported.
10. In case the emission is lower than 30MHz, loop antenna has to be used for measurement and the recorded data should be QP measured by receiver. High – Low scan is not required in this case.

4.6.4. Test Setup Layout

For radiated emissions below 30MHz

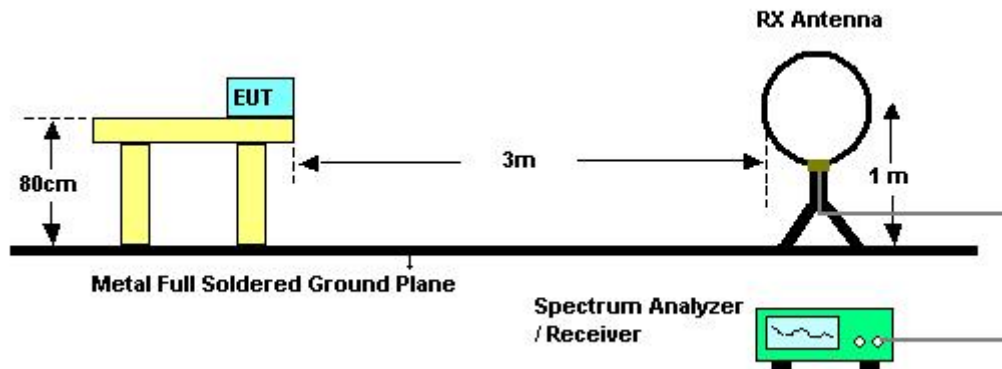

For radiated emissions above 30MHz

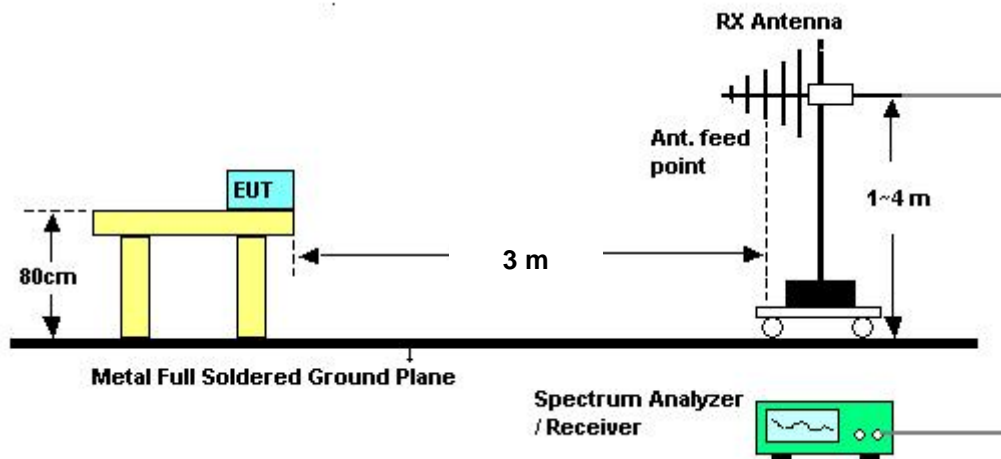

Above 10 GHz shall be extrapolated to the specified distance using an extrapolation factor of 20 dB/decade from 3m to 1.5m.

Distance extrapolation factor = $20 \log (\text{specific distance [3m]} / \text{test distance [1.5m]})$ (dB);

Limit line = specific limits (dBuV) + distance extrapolation factor [6 dB].

4.6.5. Test Deviation

There is no deviation with the original standard.

4.6.6. EUT Operation during Test

The EUT was programmed to be in continuously transmitting mode.

4.6.7. Results of Radiated Emissions (9kHz~30MHz)

Temperature	24°C	Humidity	58%
Test Engineer	Leo Hung	Configurations	Mode 2 / CH39

Freq. (MHz)	Level (dBuV)	Over Limit (dB)	Limit Line (dBuV)	Remark
-	-	-	-	See Note

Note:

The amplitude of spurious emissions which are attenuated by more than 20dB below the permissible value has no need to be reported.

Distance extrapolation factor = $40 \log(\text{specific distance} / \text{test distance})$ (dB);

Limit line = specific limits (dBuV) + distance extrapolation factor.

4.6.8. Results of Radiated Emissions (30MHz~1GHz)

Temperature	24°C	Humidity	58%
Test Engineer	Leo Hung	Configurations	CH39

Horizontal

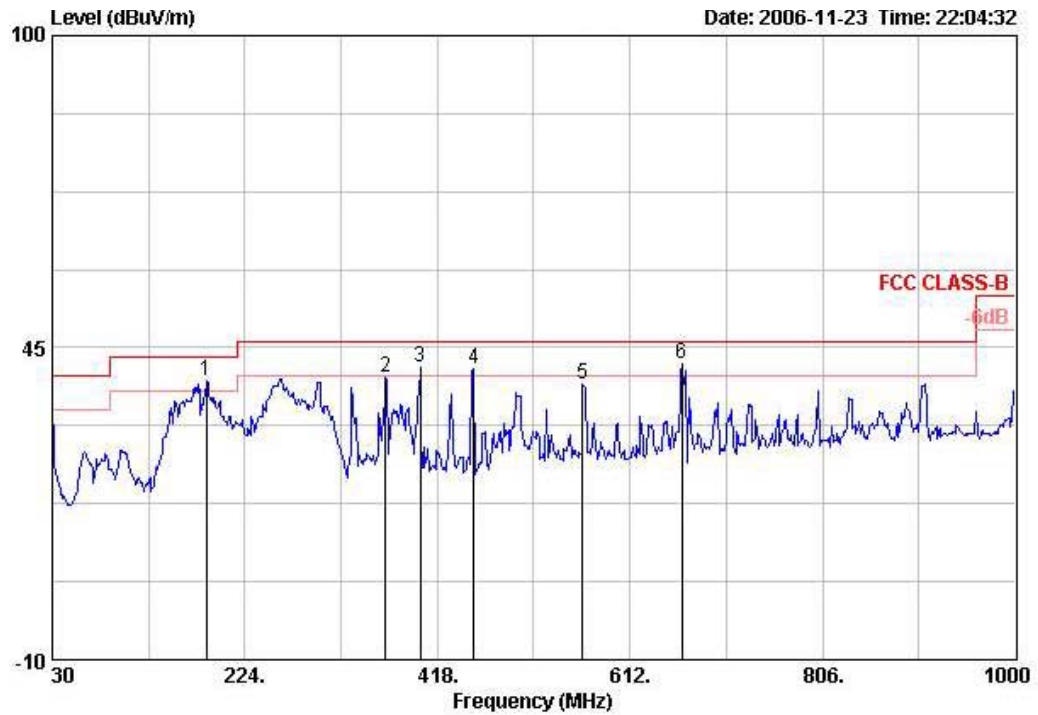

	Freq	Level	Over	Limit	Read	Cable	Preamp	Remark	Ant	Table	Antenna
	MHz	dBUV/m	Limit	Line	Level	Loss	Factor		Pos	Pos	Factor
			dB	dBUV/m	dBuV	dB	dB		cm	deg	dB/m
1 !	185.200	39.04	-4.46	43.50	58.98	2.00	31.59	Peak	---	---	9.65
2	365.620	39.65	-6.35	46.00	52.55	2.49	31.17	Peak	---	---	15.78
3 !	400.540	41.43	-4.57	46.00	53.15	2.70	31.03	Peak	---	---	16.61
4 !	454.860	41.14	-4.86	46.00	51.84	2.95	30.92	Peak	---	---	17.27
5	564.470	38.47	-7.53	46.00	47.09	3.17	30.75	Peak	---	---	18.96
6 ☹	664.380	42.04	-3.96	46.00	49.22	3.53	30.36	Peak	---	---	19.66

Vertical

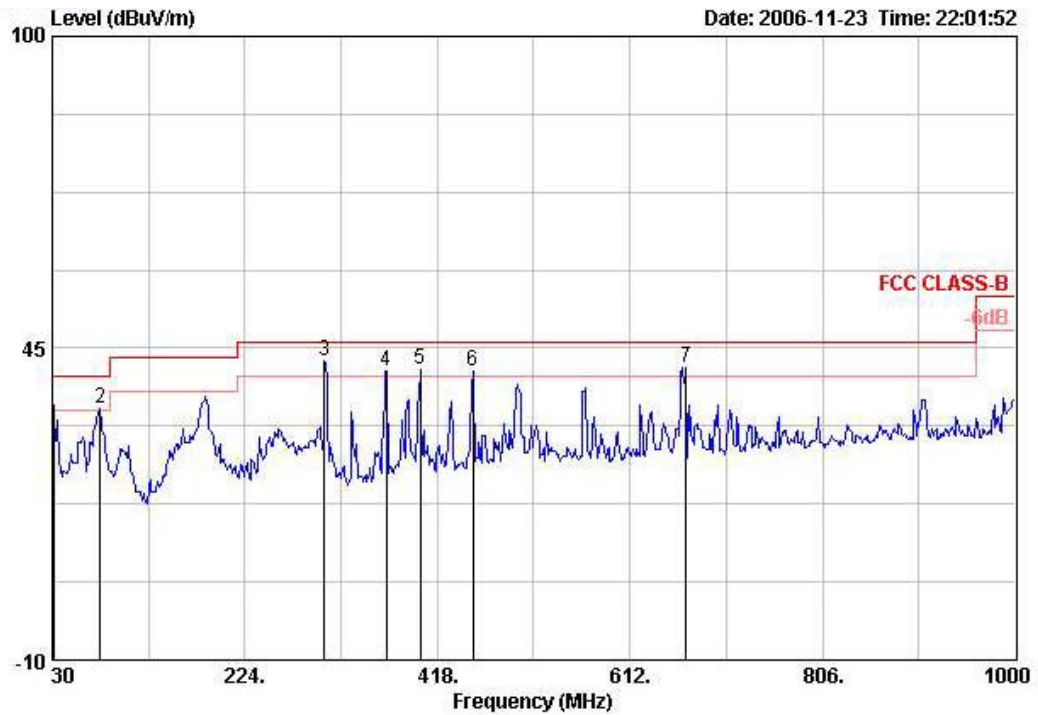

	Freq	Level	Over	Limit	Read	Cable	Preamp	Remark	Ant	Table	Antenna
	MHz	dBUV/m	Limit	Line	Level	Loss	Factor		Pos	Pos	Factor
			dB	dBUV/m	dBUV	dB	dB		cm	deg	dB/m
1 !	30.970	34.98	-5.02	40.00	46.47	0.80	31.67	Peak	---	---	19.38
2 !	78.500	34.32	-5.68	40.00	57.30	1.30	31.70	Peak	---	---	7.42
3 @	304.510	42.68	-3.32	46.00	57.65	2.22	31.31	Peak	---	---	14.13
4 !	366.590	40.94	-5.06	46.00	53.81	2.50	31.17	Peak	---	---	15.80
5 !	400.540	41.34	-4.66	46.00	53.06	2.70	31.03	Peak	---	---	16.61
6 !	453.890	40.81	-5.19	46.00	51.55	2.93	30.92	Peak	---	---	17.25
7 !	668.260	41.52	-4.48	46.00	48.70	3.54	30.38	Peak	---	---	19.67

Note:

The amplitude of spurious emissions which are attenuated by more than 20dB below the permissible value has no need to be reported.

Emission level (dBUV/m) = 20 log Emission level (uV/m).

Corrected Reading: Antenna Factor + Cable Loss + Read Level - Preamp Factor = Level.

4.6.9. Results for Radiated Emissions (1GHz~10th Harmonic)

Temperature	24°C	Humidity	58%
Test Engineer	Leo Hung	Configurations	Channel 0

Horizontal

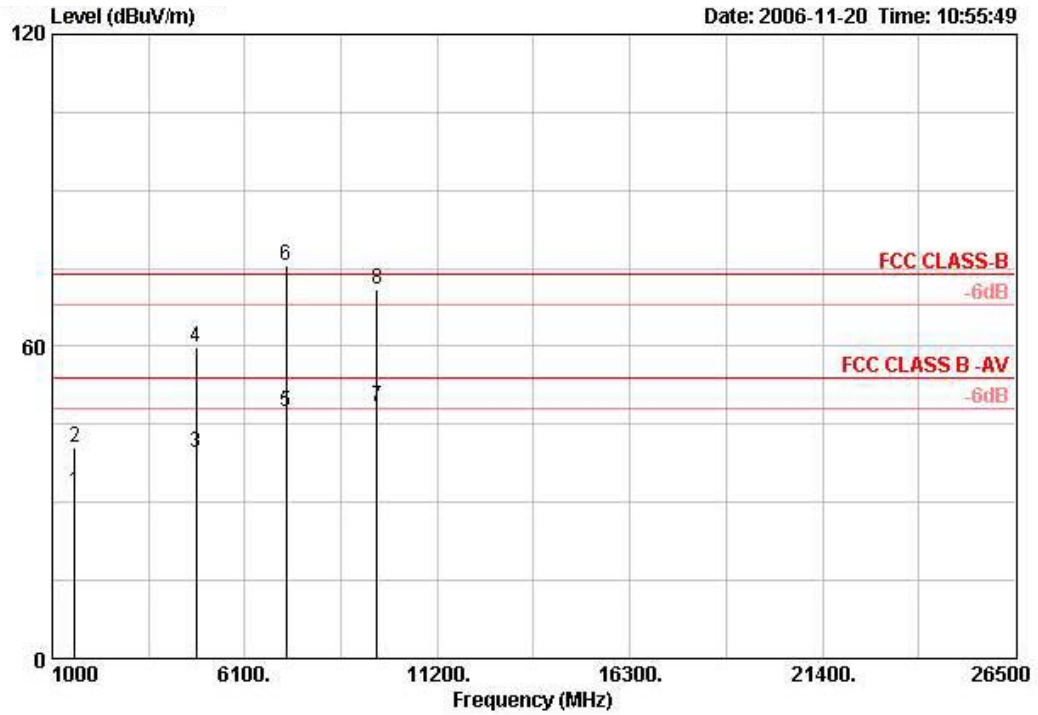

	Freq	Level	Over Limit	Limit Line	Read Level	Cable Loss	Preamp Factor	Remark	Ant Pos	TableAntenna Pos	Antenna Factor
	MHz	dBuV/m	dB	dBuV/m	dBuV	dB	dB		cm	deg	dB/m
1	1601.930	32.09	-21.91	54.00	38.83	2.28	34.72	AVERAGE	100	70	25.70
2	1602.050	40.50	-33.50	74.00	47.24	2.28	34.72	PEAK	100	70	25.70
3	4804.010	39.60	-14.40	54.00	37.45	4.30	35.17	AVERAGE	126	102	33.02
4	4804.040	59.88	-14.12	74.00	57.73	4.30	35.17	PEAK	126	102	33.02
5	7205.930	47.54	-6.46	54.00	41.55	5.48	35.21	AVERAGE	126	169	35.71
6	7206.060	75.48			69.49	5.48	35.21	PEAK	126	169	35.71
7	9608.010	48.36	-5.64	54.00	37.80	7.31	35.36	AVERAGE	100	154	38.62
8	9608.030	70.94	-3.06	74.00	60.38	7.31	35.36	PEAK	100	154	38.62

Note: Item 6 is on un-restricted band, so the limit is -20dBc for the field strength of fundamental emission.

Vertical

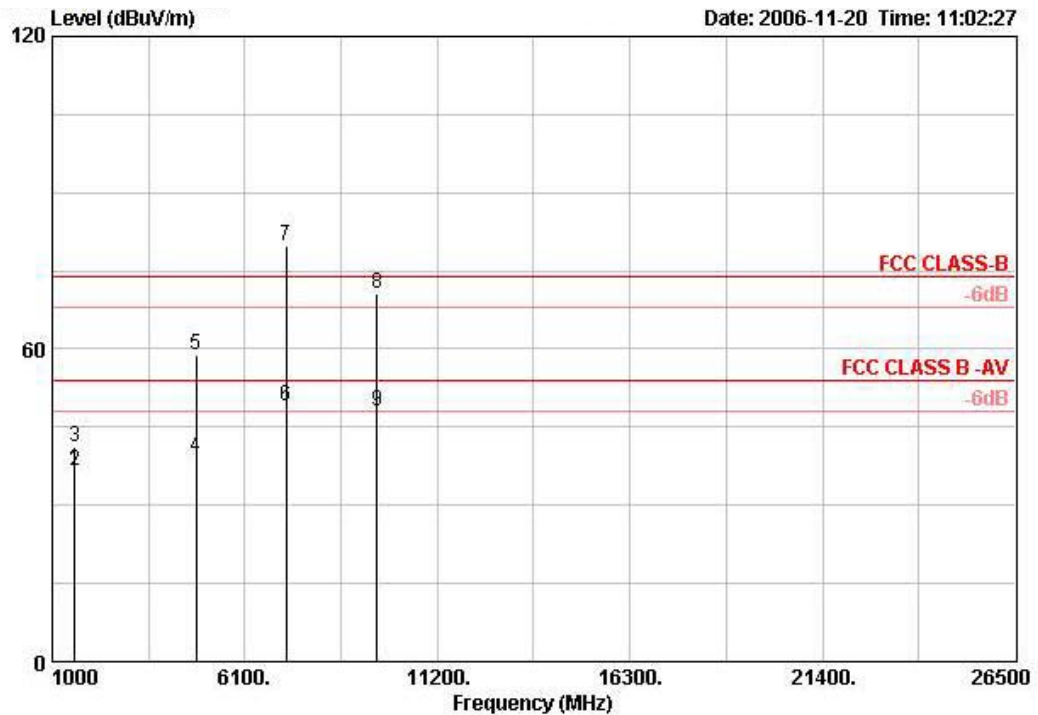

	Freq	Level	Over	Limit	Read	Cable	Preamp	Remark	Ant	TableAntenna
	MHz	dBuV/m	Limit	Line	Level	Loss	Factor		Pos	Pos Factor
			dB	dBuV/m	dBuV	dB	dB		cm	deg dB/m
1	1602.000	36.67	-17.33	54.00	43.41	2.28	34.72	AVERAGE	100	204 25.70
2	1602.000	36.67	-37.33	74.00	43.41	2.28	34.72	PEAK	100	204 25.70
3	1602.000	41.08	-32.92	74.00	47.82	2.28	34.72	PEAK	100	204 25.70
4	4804.050	39.32	-14.68	54.00	37.17	4.30	35.17	AVERAGE	100	200 33.02
5	4804.120	58.95	-15.05	74.00	56.80	4.30	35.17	PEAK	100	200 33.02
6 !	7205.970	49.14	-4.86	54.00	43.15	5.48	35.21	AVERAGE	105	126 35.71
7 @	7206.010	79.77			73.78	5.48	35.21	PEAK	105	126 35.71
8 @	9607.170	70.66	-3.34	74.00	60.09	7.31	35.36	PEAK	100	116 38.62
9 !	9607.970	48.20	-5.80	54.00	37.64	7.31	35.36	AVERAGE	100	116 38.62

Note: Item 7 is on un-restricted band, so the limit is -20dBc for the field strength of fundamental emission.

Temperature	24°C	Humidity	58%
Test Engineer	Leo Hung	Configurations	Channel 39

Horizontal

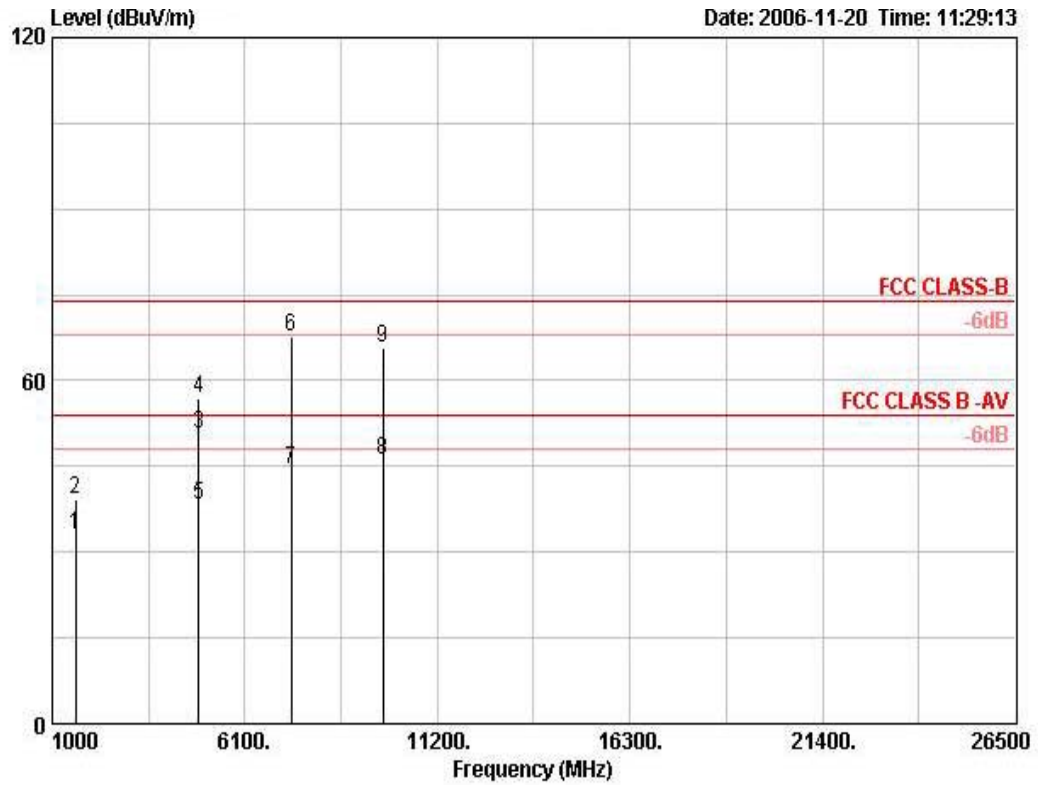

	Freq	Level	Over Limit	Limit Line	Read Level	Cable Loss	Preamp Factor	Remark	Ant Pos	TableAntenna Pos	Antenna Factor
	MHz	dBUV/m	dB	dBUV/m	dBUV	dB	dB		cm	deg	dB/m
1	1627.970	32.90	-21.10	54.00	39.51	2.28	34.73	AVERAGE	100	68	25.83
2	1628.000	39.28	-34.72	74.00	45.90	2.28	34.73	PEAK	100	68	25.83
3	4881.980	50.83	-3.17	54.00	48.52	4.30	35.15	AVERAGE	147	302	33.16
4	4882.020	56.79	-17.21	74.00	54.49	4.30	35.15	PEAK	147	302	33.16
5	4882.030	38.10	-15.90	54.00	35.80	4.30	35.15	AVERAGE	147	302	33.16
6	7322.890	67.72	-6.28	74.00	61.39	5.56	35.18	PEAK	100	80	35.96
7	7322.950	44.44	-9.56	54.00	38.11	5.56	35.18	AVERAGE	100	80	35.96
8	9763.990	46.09	-7.91	54.00	35.67	7.38	35.44	AVERAGE	112	162	38.48
9	9764.050	65.82	-8.18	74.00	55.40	7.38	35.44	PEAK	112	162	38.48

Vertical

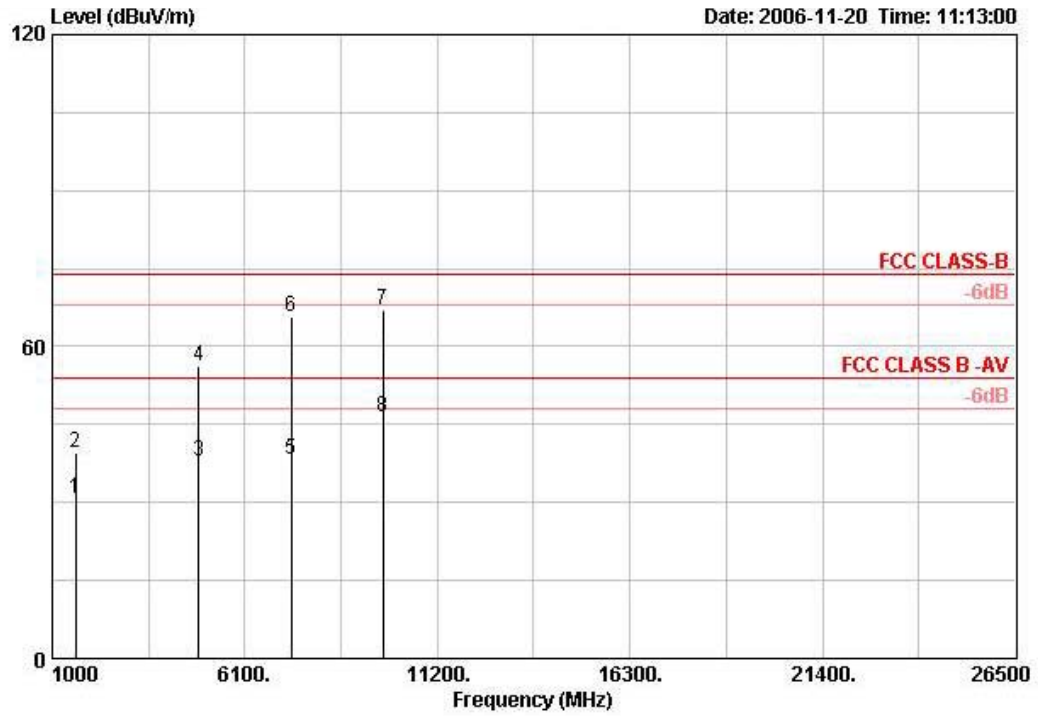

	Freq	Level	Over Limit	Limit Line	Read Level	Cable Loss	Preamp Factor	Remark	Ant Pos	TableAntenna Pos	Antenna Factor
	MHz	dBUV/m	dB	dBUV/m	dBuV	dB	dB		cm	deg	dB/m
1	1627.970	30.77	-23.23	54.00	37.39	2.28	34.73	AVERAGE	139	197	25.83
2	1628.040	39.59	-34.41	74.00	46.21	2.28	34.73	PEAK	139	197	25.83
3	4882.010	37.97	-16.03	54.00	35.67	4.30	35.15	AVERAGE	118	212	33.16
4	4882.040	56.22	-17.78	74.00	53.92	4.30	35.15	PEAK	118	212	33.16
5	7320.500	38.27	-15.73	54.00	31.94	5.56	35.18	AVERAGE	112	118	35.96
6	7320.500	65.62	-8.38	74.00	59.29	5.56	35.18	PEAK	112	118	35.96
7	9763.960	66.96	-7.04	74.00	56.54	7.38	35.44	PEAK	100	100	38.48
8	9764.090	46.54	-7.46	54.00	36.11	7.38	35.44	AVERAGE	100	100	38.48

Temperature	24°C	Humidity	58%
Test Engineer	Leo Hung	Configurations	Channel 78

Horizontal

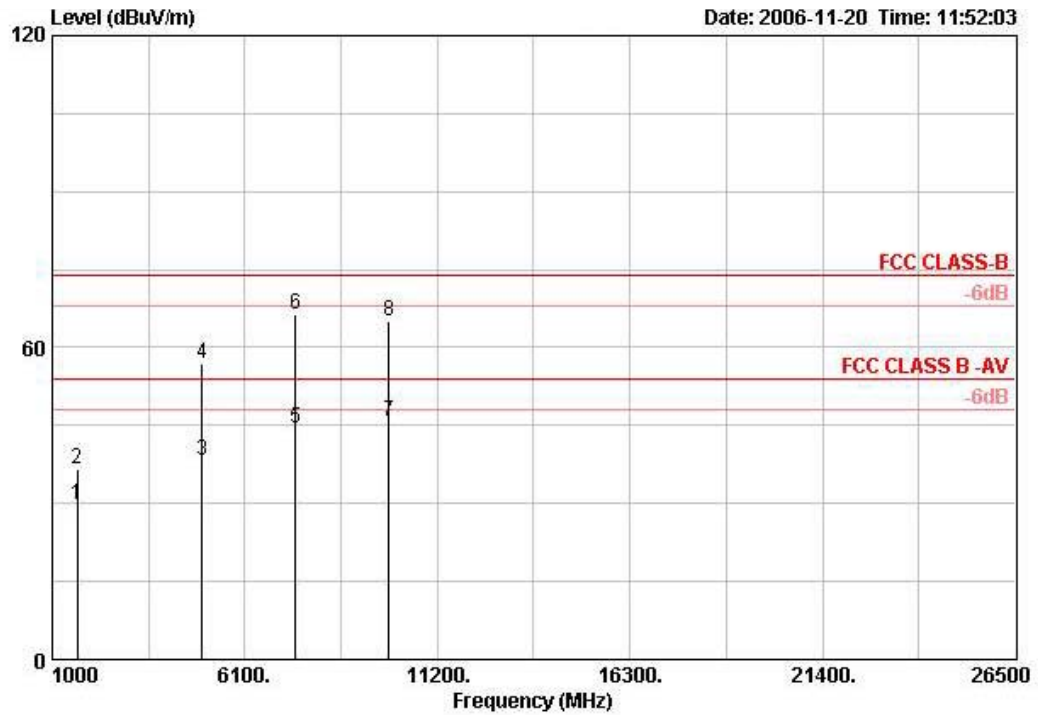

	Freq	Level	Over Limit	Limit Line	Read Level	Cable Loss	Preamp Factor	Remark	Ant Pos	Table Antenna Pos	Antenna Factor
	MHz	dBuV/m	dB	dBuV/m	dBuV	dB	dB		cm	deg	dB/m
1	1656.800	29.62	-24.38	54.00	36.09	2.30	34.74	AVERAGE	110	355	25.97
2	1656.800	36.78	-37.22	74.00	43.25	2.30	34.74	PEAK	110	355	25.97
3	4959.950	38.25	-15.75	54.00	35.76	4.30	35.14	AVERAGE	144	360	33.33
4	4960.040	56.77	-17.23	74.00	54.28	4.30	35.14	PEAK	144	360	33.33
5	7439.930	44.40	-9.60	54.00	37.72	5.63	35.15	AVERAGE	132	85	36.20
6	7440.090	66.48	-7.52	74.00	59.81	5.63	35.15	PEAK	132	85	36.20
7	9920.030	45.77	-8.23	54.00	35.47	7.46	35.52	AVERAGE	111	164	38.36
8	9920.170	65.08	-8.92	74.00	54.78	7.46	35.52	PEAK	111	164	38.36

Vertical

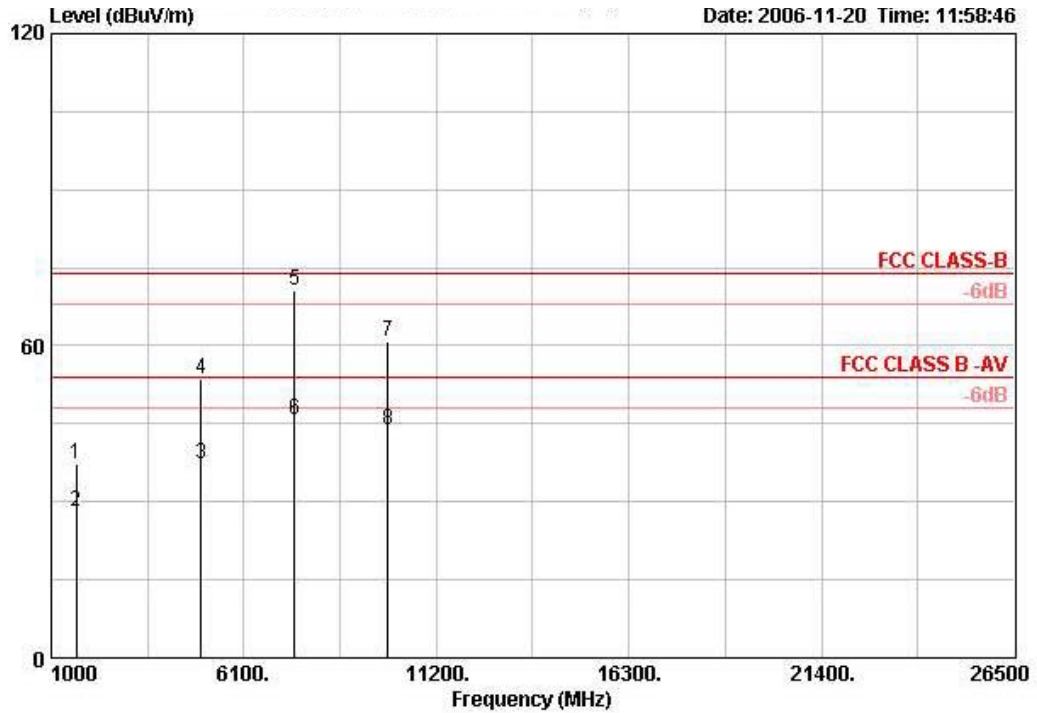

	Freq	Level	Over Limit	Limit Line	Read Level	Cable Loss	Preamp Factor	Remark	Ant Pos	Table Antenna Pos	Antenna Factor
	MHz	dBuV/m	dB	dBuV/m	dBuV	dB	dB		cm	deg	dB/m
1	1656.800	37.14	-36.86	74.00	43.61	2.30	34.74	PEAK	112	4	25.97
2	1656.800	28.24	-25.76	54.00	34.71	2.30	34.74	AVERAGE	112	4	25.97
3	4960.000	37.25	-16.75	54.00	34.76	4.30	35.14	AVERAGE	129	216	33.33
4	4960.000	53.48	-20.52	74.00	50.98	4.30	35.14	PEAK	129	216	33.33
5	7439.980	70.68	-3.32	74.00	64.00	5.63	35.15	PEAK	100	93	36.20
6	7440.000	45.90	-8.10	54.00	39.22	5.63	35.15	AVERAGE	100	93	36.20
7	9920.180	60.87	-13.13	74.00	50.57	7.46	35.52	PEAK	112	337	38.36
8	9920.180	43.91	-10.09	54.00	33.61	7.46	35.52	AVERAGE	112	337	38.36

Note:

The amplitude of spurious emissions which are attenuated by more than 20dB below the permissible value has no need to be reported.

Emission level (dBuV/m) = 20 log Emission level (uV/m).

Corrected Reading: Antenna Factor + Cable Loss + Read Level - Preamp Factor = Level.

4.7. Band Edge Emissions Measurement

4.7.1. Limit

20dBc in any 100 kHz bandwidth outside the operating frequency band. In case the emission fall within the restricted band specified on 15.205(a), then the 15.209(a) limit in the table below has to be followed.

Frequencies (MHz)	Field Strength (micovolts/meter)	Measurement Distance (meters)
0.009~0.490	2400/F(KHz)	300
0.490~1.705	24000/F(KHz)	30
1.705~30.0	30	30
30~88	100	3
88~216	150	3
216~960	200	3
Above 960	500	3

4.7.2. Measuring Instruments and Setting

Please refer to section 5 of equipments list in this report. The following table is the setting of the spectrum analyzer.

Spectrum Parameter	Setting
Attenuation	Auto
Span Frequency	100 MHz
RB / VB (Emission in restricted band)	1 MHz / 1MHz for Peak, 1 MHz / 10Hz for Average
RB / VB (Emission in non-restricted band)	100 KHz /100 KHz for Peak

4.7.3. Test Procedures

1. The test procedure is the same as section 4.5.3, only the frequency range investigated is limited to 100MHz around bandedges.
2. In case the emission is fail due to the used RB/VB is too wide, marker-delta method of FCC Public Notice DA00-705 will be followed.

4.7.4. Test Setup Layout

This test setup layout is the same as that shown in section 4.6.4.

4.7.5. Test Deviation

There is no deviation with the original standard.

4.7.6. EUT Operation during Test

The EUT was programmed to be in continuously transmitting mode.

4.7.7. Test Result of Band Edge and Fundamental Emissions

Temperature	24°C	Humidity	58%
Test Engineer	Leo Hung	Configurations	Channel 0, 78

Channel 0

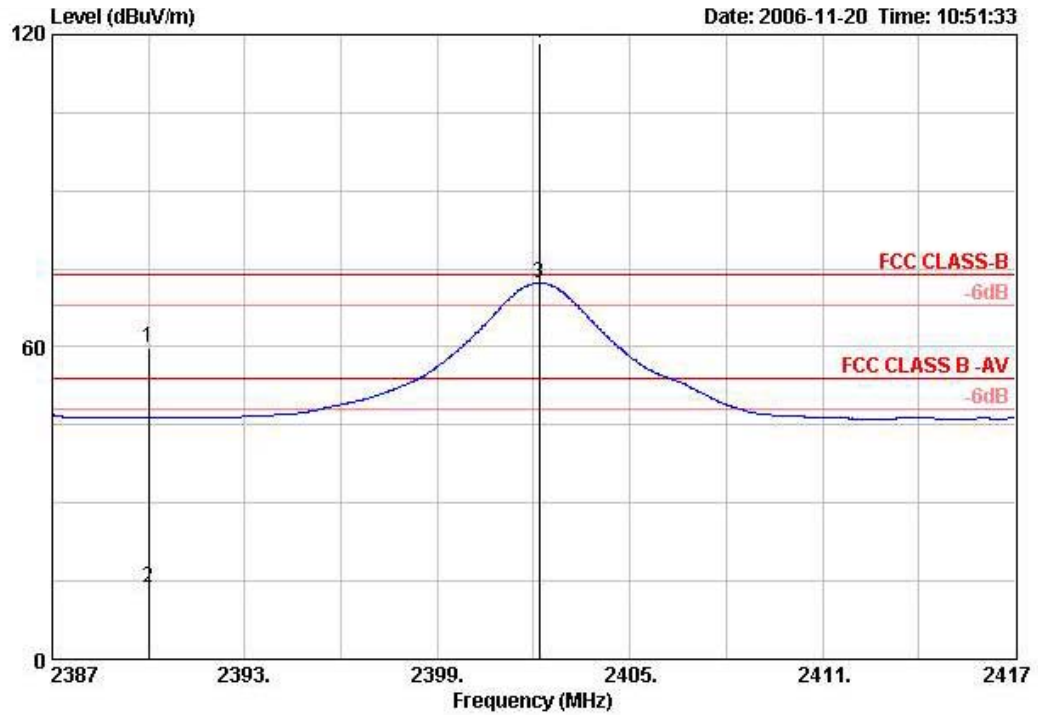

	Freq	Level	Over Limit	Limit Line	Read Level	Cable Loss	Preamp Factor	Remark	Ant Pos	Table Antenna Pos	Antenna Factor
	MHz	dBuV/m	dB	dBuV/m	dBuV	dB	dB		cm	deg	dB/m
1	2390.000	59.88	-14.12	74.00	28.94	2.76	0.00	Peak	159	341	28.17
2	2390.000	13.63	-40.37	54.00	-17.31	2.76	0.00	Average	159	341	28.17
3	2402.180	72.23			41.29	2.76	0.00	AVERAGE	159	341	28.17
4	2402.180	118.48			87.54	2.76	0.00	PEAK	159	341	28.17

Item 1, 2 are Band Edge.

Channel 78

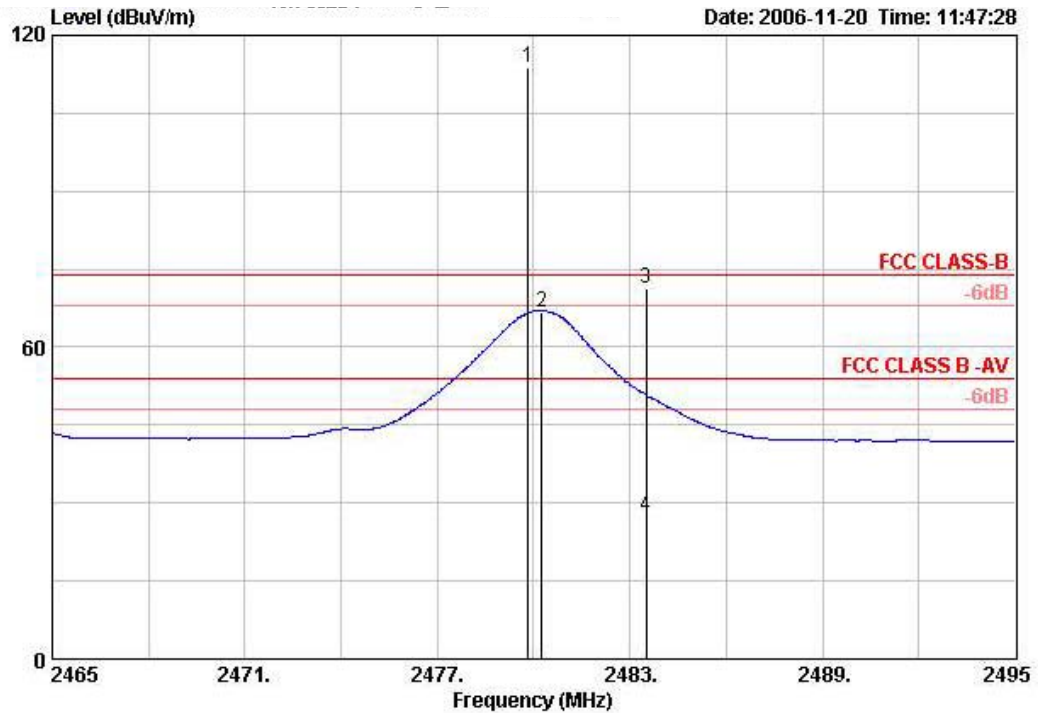

	Freq	Level	Over	Limit	Read	Cable	Preamp	Remark	Ant	Table	Antenna
	MHz	dBuV/m	dB	dBuV/m	dBuV	dB	dB		cm	deg	dB/m
1	2479.820	113.66			82.48	2.81	0.00	PEAK	156	343	28.36
2	2480.240	66.83			35.66	2.81	0.00	AVERAGE	156	343	28.36
3	2483.500	71.27	-2.73	74.00	40.07	2.84	0.00	Peak	156	343	28.36
4	2483.500	27.44	-26.56	54.00	-3.76	2.84	0.00	Average	156	343	28.36

Item 3, 4 are Band Edge.

Note:

Emission level (dBuV/m) = 20 log Emission level (uV/m).

Corrected Reading: Antenna Factor + Cable Loss + Read Level - Preamp Factor = Level.

For Emission not in Restricted Band

Low Band Edge Plot on Channel 0 / 2402 MHz

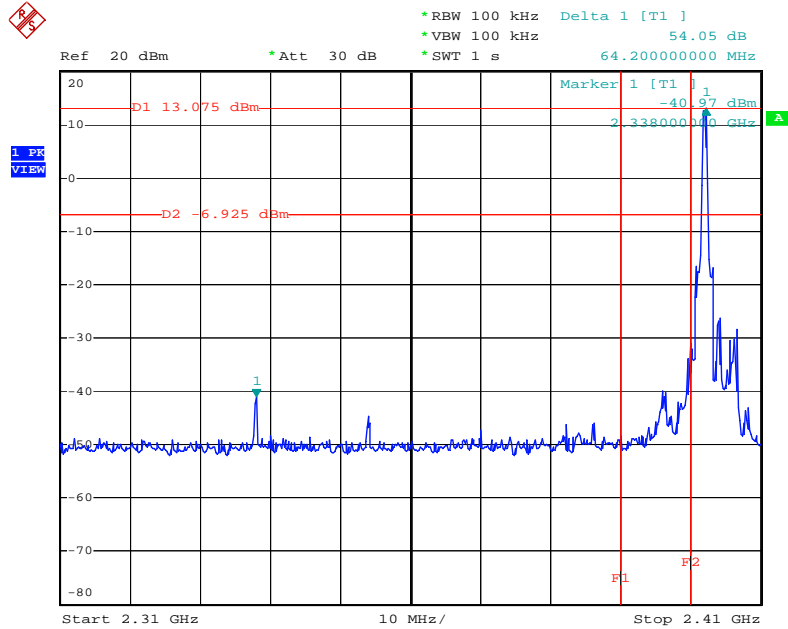

Date: 28.NOV.2006 20:04:43

High Band Edge Plot on Channel 78 / 2480 MHz

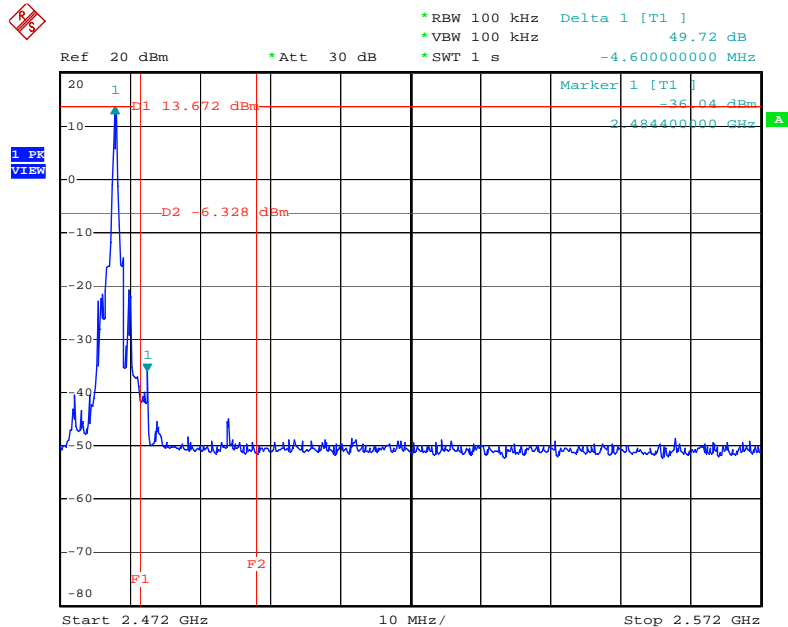

Date: 28.NOV.2006 20:09:36

4.8. Antenna Requirements

4.8.1. Limit

Except for special regulations, the Low-power Radio-frequency Devices must not be equipped with any jacket for installing an antenna with extension cable. An intentional radiator shall be designed to ensure that no antenna other than that furnished by the responsible party shall be used with the device. The use of a permanently attached antenna or of an antenna that uses a unique coupling to the intentional radiator shall be considered sufficient to comply with the provisions of this Section. The manufacturer may design the unit so that the user can replace a broken antenna, but the use of a standard antenna jack or electrical connector is prohibited.

4.8.2. Antenna Connector Construction

Please refer to section 3.3 in this test report, antenna connector complied with the requirements.

5. LIST OF MEASURING EQUIPMENTS

Instrument	Manufacturer	Model No.	Serial No.	Characteristics	Calibration Date	Remark
EMC Receiver	R&S	ESCS 30	100174	9kHz – 2.75GHz	Feb. 22, 2006	Conduction (CO04-HY)
LISN	MessTec	NNB-2/16Z	99079	9kHz – 30MHz	Dec. 19, 2005	Conduction (CO04-HY)
LISN (Support Unit)	EMCO	3810/2NM	9708-1839	9kHz – 30MHz	Mar. 18, 2006	Conduction (CO04-HY)
RF Cable-CON	UTIFLEX	3102-26886-4	CB049	9kHz – 30MHz	Apr. 20, 2006	Conduction (CO04-HY)
EMI Filter	LINDGREN	LRE-2030	2651	< 450 Hz	N/A	Conduction (CO04-HY)
3m Semi Anechoic Chamber	SIDT FRANKONIA	SAC-3M	03CH03-HY	30 MHz - 1 GHz 3m	Jun. 15, 2006	Radiation (03CH03-HY)
Amplifier	SCHAFFNER	CPA9231A	18667	9 kHz - 2 GHz	Jan. 18, 2006	Radiation (03CH03-HY)
Amplifier	Agilent	8449B	3008A02120	1 GHz - 26.5 GHz	May 29, 2006	Radiation (03CH03-HY)
Amplifier	MITEQ	AMF-6F-260400	923364	26.5 GHz - 40 GHz	Jan. 24, 2006*	Radiation (03CH03-HY)
Spectrum Analyzer	R&S	FSP40	100004/040	9 kHz - 40 GHz	Sep. 21, 2006	Radiation (03CH03-HY)
Bilog Antenna	SCHAFFNER	CBL 6112D	22237	30 MHz – 1 GHz	Jul. 24, 2006	Radiation (03CH03-HY)
RF Cable-R03m	Jye Bao	RG142	CB021	30 MHz - 1 GHz	Dec.02, 2006	Radiation (03CH03-HY)
RF Cable-HIGH	SUHNER	SUCOFLEX 106	03CH03-HY	1 GHz - 40 GHz	Dec.02, 2006	Radiation (03CH03-HY)
Turn Table	HD	DS 420	420/650/00	0 – 360 degree	N/A	Radiation (03CH03-HY)
Antenna Mast	HD	MA 240	240/560/00	1 m - 4 m	N/A	Radiation (03CH03-HY)
Loop Antenna	R&S	HFH2-Z2	860004/001	9 kHz - 30 MHz	May 23, 2006*	Radiation (03CH03-HY)
Horn Antenna	EMCO	3115	6903	1GHz ~ 18GHz	Mar. 15, 2006	Radiation (03CH03-HY)
Horn Antenna	SCHWARZBECK	BBHA9170	BBHA9170154	15 GHz - 40 GHz	NCR	Radiation (03CH03-HY)
Spectrum Analyzer	R&S	FSP30	100023	9kHz ~ 30GHz	Nov. 26, 2006	Conducted (TH01-HY)
Power Meter	R&S	NRVS	100764	DC ~ 40GHz	Jul. 20, 2006	Conducted (TH01-HY)
Power Sensor	R&S	NRV-Z51	100666	DC ~ 40GHz	Jul. 20, 2006	Conducted (TH01-HY)
Power Sensor	R&S	NRV-Z32	100057	30MHz ~ 6GHz	Jun, 10, 2006	Conducted (TH01-HY)
AC Power Source	HPC	HPA-500W	HPA-9100024	AC 0 ~ 300V	Apr. 21, 2005*	Conducted (TH01-HY)
DC Power Source	G.W.	GPC-6030D	C671845	DC 1V ~ 60V	Dec. 28, 2005	Conducted (TH01-HY)
Temp. and Humidity Chamber	KSON	THS-C3L	612	N/A	Oct. 02, 2006	Conducted (TH01-HY)
RF CABLE-1m	Jye Bao	RG142	CB034-1m	20MHz ~ 7GHz	Dec. 01, 2006	Conducted (TH01-HY)

Instrument	Manufacturer	Model No.	Serial No.	Characteristics	Calibration Date	Remark
RF CABLE-2m	Jye Bao	RG142	CB035-2m	20MHz ~ 1GHz	Dec. 01, 2006	Conducted (TH01-HY)
Oscilloscope	Tektronix	TDS1012	CO38515	100MHz / 1GS/s	Jun. 20, 2006	Conducted (TH01-HY)
Signal Generator	R&S	SMR40	100116	10MHz ~ 40GHz	Dec. 30, 2005	Conducted (TH01-HY)

Note: Calibration Interval of instruments listed above is one year.

*Calibration Interval of instruments listed above is two year.

NCR means Non-Calibration required.

6. TEST LOCATION

SHIJR	ADD : 6Fl., No. 106, Sec. 1, Shintai 5th Rd., Shijr City, Taipei, Taiwan 221, R.O.C. TEL : 886-2-2696-2468 FAX : 886-2-2696-2255
HWA YA	ADD : No. 52, Hwa Ya 1st Rd., Kwei-Shan Hsiang, Tao Yuan Hsien, Taiwan, R.O.C. TEL : 886-3-327-3456 FAX : 886-3-318-0055
LINKOU	ADD : No. 30-2, Dingfu Tsuen, Linkou Shiang, Taipei, Taiwan 244, R.O.C TEL : 886-2-2601-1640 FAX : 886-2-2601-1695
DUNGHU	ADD : No. 3, Lane 238, Kangle St., Neihu Chiu, Taipei, Taiwan 114, R.O.C. TEL : 886-2-2631-4739 FAX : 886-2-2631-9740
JUNGHE	ADD : 7Fl., No. 758, Jungjeng Rd., Junghe City, Taipei, Taiwan 235, R.O.C. TEL : 886-2-8227-2020 FAX : 886-2-8227-2626
NEIHU	ADD : 4Fl., No. 339, Hsin Hu 2 nd Rd., Taipei 114, Taiwan, R.O.C. TEL : 886-2-2794-8886 FAX : 886-2-2794-9777
JHUBEI	ADD : No.8, Lane 724, Bo-ai St., Jhubei City, HsinChu County 302, Taiwan, R.O.C. TEL : 886-3-656-9065 FAX : 886-3-656-9085



Annex

Declaration for Bluetooth Device acc to Part 15.247



1 Output power and channel separation of a Bluetooth device in the different operating modes:

The different operating modes (data-mode, acquisition-mode) of a Bluetooth device has no influence on the output power and the channel spacing. There is only one transmitter which is driven by identical input parameters concerning these two parameters.

Only a different hopping sequence will be used. For this reason the check of these RF parameters in one op-mode is sufficient.

2 Frequency range of a Bluetooth device:

Hereby we declare that the maximum frequency of this device is: 2402 – 2480 MHz. This is according to the Bluetooth Core Specification (+ critical errata) for devices which will be operated in the USA.

This was checked during the Bluetooth Qualification tests (Test Case: TRM/CA/04-E). Other frequency ranges (e.g. for Spain, France, Japan) which are allowed according the Core Specification are not supported by this device.

3 Co-ordination of the hopping sequence in data mode to avoid simultaneous occupancy by multiple transmitters:

Bluetooth units which want to communicate with other units must be organised in a structure called piconet. This piconet consist of max. 8 Bluetooth units. One unit is the master the other seven are the slaves. The master co-ordinates frequency occupation in this piconet for all units. As the master hop sequence is derived from its BD address which is unique for each Bluetooth device, additional masters intending to establish new piconets will always use different hop sequences.

4 Example of a hopping sequence in data mode:

Example of a 79 hopping sequence in data mode:

40, 21, 44, 23, 42, 53, 46, 55, 48, 33, 52, 35, 50, 65, 54, 67,
56, 37, 60, 39, 58, 69, 62, 71, 64, 25, 68, 27, 66, 57, 70, 59,
72, 29, 76, 31, 74, 61, 78, 63, 01, 41, 05, 43, 03, 73, 07, 75,
09, 45, 13, 47, 11, 77, 15, 00, 64, 49, 66, 53, 68, 02, 70, 06,
01, 51, 03, 55, 05, 04



5 Equally average use of frequencies in data mode and behaviour for short transmissions:

The generation of the hopping sequence in connection mode depends essentially on two input values:

1. LAP/UAP of the master of the connection
2. Internal master clock

The LAP (lower address part) are the 24 LSB's of the 48 BD_ADDRESS. The BD_ADDRESS is an unambiguous number of every Bluetooth unit. The UAP (upper address part) are the 24 MSB's of the 48 BD_ADDRESS.

The internal clock of a Bluetooth unit is derived from a free running clock which is never adjusted and is never turned off. For synchronisation with other units only offset are used. It has no relation to the time of the day. Its resolution is at least half the RX/TX slot length of 312.5 μ s. The clock has a cycle of about one day (23h30). In most case it is implemented as 28 bit counter. For the deriving of the hopping sequence the entire

LAP (24 bits), 4 LSB's (4 bits) (Input 1) and the 27 MSB's of the clock (Input 2) are used. With this input values different mathematical procedures (permutations, additions, XOR- operations) are performed to generate the sequence. This will be done at the beginning of every new transmission.

Regarding short transmissions the Bluetooth system has the following behaviour:

The first connection between the two devices is established, a hopping sequence was generated. For transmitting the wanted data the complete hopping sequence was not used. The connection ended.

The second connection will be established. A new hopping sequence is generated. Due to the fact that the Bluetooth clock has a different value, because the period between the two transmission is longer (and it cannot be shorter) than the minimum resolution of the clock (312.5 μ s). The hopping sequence will always differ from the first one.

6 Receiver input bandwidth and behaviour for repeated single or multiple packets:

The input bandwidth of the receiver is 1 MHz. In every connection one Bluetooth device is the master and the other one is the slave. The master determines the hopping sequence (see chapter 5). The slave follows this sequence. Both devices shift between RX and TX time slot according to the clock of the master.

Additionally the type of connection (e.g. single or multislot packet) is set up at the beginning of the connection. The master adapts its hopping frequency and its TX/RX timing according to the packet type of the connection. Also the slave of the connection will use these settings.

Repeating of a packet has no influence on the hopping sequence. The hopping sequence generated by the master of the connection will be followed in any case. That means, a repeated packet will not be send on the same frequency, it is send on the next frequency of the hopping sequence.



7 Dwell time in data mode

The dwell time of 0.3797s within a 30 second period in data mode is independent from the packet type (packet length). The calculation for a 30 second period is as follows:

Dwell time = time slot length * hop rate / number of hopping channels * 30s

Example for a DH1 packet (with a maximum length of one time slot) Dwell time = $625 \mu\text{s} * 1600 \text{ 1/s} / 79 * 30\text{s} = 0.3797\text{s}$ (in a 30s period)

For multislot packet the hopping is reduced according to the length of the packet. Example for a DH5 packet (with a maximum length of five time slots)

Dwell time = $5 * 625 \mu\text{s} * 1600 * 1/5 * 1/\text{s} / 79 * 30\text{s} = 0.3797\text{s}$ (in a 30s period). This is according to the Bluetooth Core Specification V 1.0B (+ critical errata) for all Bluetooth devices. Therefore all Bluetooth devices **comply** with the FCC dwell time requirement in data mode. This was checked during the Bluetooth Qualification tests. The Dwell time in hybrid mode is measured and stated in the test report.

8 Channel Separation in hybrid mode

The nominal channel spacing of the Bluetooth system is 1MHz independent of the operating mode.

The maximum "initial carrier frequency tolerance" which is allowed for Bluetooth is $f_{\text{center}} = 75 \text{ kHz}$.

This was checked during the Bluetooth Qualification tests (Test Case: TRM/CA/07-E) for three frequencies (2402, 2441, 2480 MHz).

Additionally an example for the channel separation is given in the test report

9 Derivation and examples for a hopping sequence in hybrid mode

For the generation of the inquiry and page hop sequences the same procedures as described for the data mode are used (see chapter 5), but this time with different input vectors:

- For the inquiry hop sequence, a predefined fixed address is always used. This results in the same 32 frequencies used by all devices doing an inquiry but every time with a different start frequency and phase in this sequence.
- For the page hop sequence, the device address of the paged unit is used as input vector. This results in the use of a subset of 32 frequencies which is specific for that initial state of the connection establishment between the two units. A page to different devices would result in a different subset of 32 frequencies.

So it is ensured that also in hybrid mode the frequency use is equally averaged.

Example of a hopping sequence in inquiry mode:

48, 50, 09, 13, 52, 54, 41, 45, 56, 58, 11, 15, 60, 62, 43, 47, 00, 02, 64, 68, 04, 06, 17, 21, 08, 10, 66, 70, 12, 14, 19, 23



Example of a hopping sequence in paging mode:

08, 57, 68, 70, 51, 02, 42, 40, 04, 61, 44, 46, 63, 14, 50, 48, 16, 65, 52, 54, 67, 18, 58, 56, 20, 53, 60, 62, 55, 06, 66, 64

10 Receiver input bandwidth and synchronisation in hybrid mode:

The receiver input bandwidth is the same as in the data mode (1 MHz). When two Bluetooth devices establish contact for the first time, one device sends an inquiry access code, the other device is scanning for this inquiry access code. If two devices have been connected previously and want to start a new transmission, a similar procedure takes place. The only difference is, instead of the inquiry access code, a special access code, derived from the BD_ADDRESS of the paged device will be, will be sent by the master of this connection.

Due to the fact that both units have been connected before (in the inquiry procedure) the paging unit has timing and frequency information about the page scan of the paged unit. For this reason the time to establish the connection is reduced considerable.

11 Spread rate / data rate of the direct sequence signal

The Spread rate / Data rate in inquiry and paging mode can be defined via the access code. The access code is the only criterion for the system to check if there is a valid transmission or not. If you regard the presence of a valid access code as one bit of information, and compare it with the length of the access code of 68 bits, the Spread rate / Data rate will be 68/1.

12 Spurious emission in hybrid mode

The dwell time in hybrid mode is shorter than in data mode. For this reason the spurious emissions average level in data mode is worst case. The spurious emissions peak level is the same for both modes.

13 Peak power spectral density measurement

Since the transmitter is only active for some milliseconds on one channel you would get a result with many interruptions if using a sweep time of e.g. 1s as stated in the FCC rules. Therefore a fast sweep in maxhold function is used instead and the EUT is activated several times until the measurement curve has stabilized.