

RADIO TEST REPORT

FCC 47 CFR PART 15 SUBPART C

Test Standard	FCC Part 15.247 RSS-247 issue 2 and RSS-GEN issue 5
Product name	BLE Module
Brand Name	Raytac Corporation
Model No.	MDBT42TV, MDBT42TV-P
Test Result	Pass
Statements of Conformity	Determination of compliance is based on the results of the compliance measurement, not taking into account measurement instrumentation uncertainty.

The test Result was tested by Compliance Certification Services Inc. The test data, data evaluation, test procedures, and equipment configurations shown in this report were given in ANSI C63.10: 2013 and compliance standards.

The test results of this report relate only to the tested sample (EUT) identified in this report.

The test Report of full or partial shall not copy. Without written approval of Compliance Certification Services Inc. (Wugu Laboratory)

Approved by:



Kevin Tsai
Deputy Manager

Unless otherwise stated the results shown in this test report refer only to the sample(s) tested and such sample(s) are retained for 90 days only.
除非另有說明，此報告結果僅對測試之樣品負責，同時此樣品僅保留90天。本報告未經本公司書面許可，不可部份複製。

This document is issued by the Company subject to its General Conditions of Service printed overleaf, available on request or accessible at <http://www.sgs.com.tw/Terms-and-Conditions> and, for electronic format documents, subject to Terms and Conditions for Electronic Documents at <http://www.sgs.com.tw/Terms-and-Conditions>. Attention is drawn to the limitation of liability, indemnification and jurisdiction issues defined therein. Any holder of this document is advised that information contained hereon reflects the Company's findings at the time of its intervention only and within the limits of client's instruction, if any. The Company's sole responsibility is to its Client and this document does not exonerate parties to a transaction from exercising all their rights and obligations under the transaction documents. This document cannot be reproduced, except in full, without prior written approval of the Company. Any unauthorized alteration, forgery or falsification of the content or appearance of this document is unlawful and offenders may be prosecuted to the fullest extent of the law.



Report No.: T200824W11-RP

Page: 2 / 87
Rev.: 01

Revision History

Rev.	Issue Date	Revisions	Effect Page	Revised By
00	October 15, 2020	Initial Issue	ALL	Mita Wu
01	November 4, 2020	See the following note Rev.(01)	P.6	Mita Wu

Rev.(01)

1. Added uncertainty of 3M semi anechoic chamber 9kHz~30MHz in section 1.4.

Table of contents

1.	GENERAL INFORMATION	4
1.1	EUT INFORMATION	4
1.2	EUT CHANNEL INFORMATION	5
1.3	ANTENNA INFORMATION	5
1.4	MEASUREMENT UNCERTAINTY.....	6
1.5	FACILITIES AND TEST LOCATION	7
1.6	INSTRUMENT CALIBRATION	7
1.7	SUPPORT AND EUT ACCESSORIES EQUIPMENT	9
1.8	TEST METHODOLOGY AND APPLIED STANDARDS	9
2.	TEST SUMMARY	10
3.	DESCRIPTION OF TEST MODES.....	11
3.1	THE WORST MODE OF OPERATING CONDITION	11
3.2	THE WORST MODE OF MEASUREMENT	12
3.3	EUT DUTY CYCLE.....	13
4.	TEST RESULT	14
4.1	AC POWER LINE CONDUCTED EMISSION	14
4.2	6DB BANDWIDTH AND OCCUPIED BANDWIDTH (99%)	15
4.3	OUTPUT POWER MEASUREMENT	21
4.4	POWER SPECTRAL DENSITY.....	24
4.5	CONDUCTED BAND EDGE AND SPURIOUS EMISSION	28
4.6	RADIATION BANDEDGE AND SPURIOUS EMISSION	35
APPENDIX 1 - PHOTOGRAPHS OF EUT		

1. GENERAL INFORMATION

1.1 EUT INFORMATION

Applicant	Raytac Corp. 5F.,No.3, Jiankang Road, Zhonghe District, New Taipei City 23586, Taiwan	
Manufacturer	Raytac Corp. 5F.,No.3, Jiankang Road, Zhonghe District, New Taipei City 23586, Taiwan	
Equipment	BLE Module	
Model No.	MDBT42TV, MDBT42TV-P	
Model Discrepancy	Difference of the model numbers (list on this report) is difference between antenna type as below:	
	Model:	Antenna type:
	MDBT42TV	Chip antenna
	MDBT42TV-P	PCB antenna
Trade Name	Raytac Corporation	
Received Date	August 24, 2020	
Date of Test	August 26 ~ September 8, 2020	
Power Supply	Power from host system.	
S.W Version	1.0	
H.W: Version	1.0	
EUT Serial #	MDBT42TV-IC-01	

1.2 EUT CHANNEL INFORMATION

Frequency Range	2402MHz-2480MHz
Modulation Type	GFSK for BLE 1 Mbps & 2 Mbps
Number of channels	40 Channels

Remark:

Refer as ANSI C63.10: 2013 clause 5.6.1 Table 4 for test channels

Number of frequencies to be tested		
Frequency range in which device operates	Number of frequencies	Location in frequency range of operation
<input type="checkbox"/> 1 MHz or less	1	Middle
<input type="checkbox"/> 1 MHz to 10 MHz	2	1 near top and 1 near bottom
<input checked="" type="checkbox"/> More than 10 MHz	3	1 near top, 1 near middle, and 1 near bottom

1.3 ANTENNA INFORMATION

Antenna Type	<input type="checkbox"/> PIFA <input checked="" type="checkbox"/> PCB <input type="checkbox"/> Dipole <input checked="" type="checkbox"/> Chip		
Antenna Gain	Model:	Antenna type:	Gain (dBi):
	MDBT42TV	Chip antenna	-5.81
	MDBT42TV-P	PCB antenna	-6.50
Antenna Connector	N/A		

1.4 MEASUREMENT UNCERTAINTY

PARAMETER	UNCERTAINTY
AC Powerline Conducted Emission	+/- 1.2575
Emission bandwidth, 20dB bandwidth	+/- 0.0014
RF output power, conducted	+/- 1.14
Power density, conducted	+/- 1.40
3M Semi Anechoic Chamber / 9KHz~30MHz	+/- 2.30
3M Semi Anechoic Chamber / 30MHz~200MHz	+/- 4.12
3M Semi Anechoic Chamber / 200MHz~1000MHz	+/- 4.68
3M Semi Anechoic Chamber / 1GHz~8GHz	+/- 5.18
3M Semi Anechoic Chamber / 8GHz~18GHz	+/- 5.47
3M Semi Anechoic Chamber / 18GHz~26GHz	+/- 3.81
3M Semi Anechoic Chamber / 26GHz~40GHz	+/- 3.87

Remark:

- 1.This uncertainty represents an expanded uncertainty expressed at approximately the 95% confidence level using a coverage factor of k=2
2. ISO/IEC 17025 requires that an estimate of the measurement uncertainties associated with the emissions test results be included in the report.

1.5 FACILITIES AND TEST LOCATION

All measurement facilities used to collect the measurement data are located at No.11, Wugong 6th Rd., Wugu Dist., New Taipei City, Taiwan. (R.O.C.)

Test site	Test Engineer	Remark
AC Conduction Room	N/A	Not applicable, because EUT doesn't connect to AC Main Source direct.
Radiation	Jerry Chang	-
RF Conducted	Rick Lee	-

Remark: The sites are constructed in conformance with the requirements of ANSI C63.7, ANSI C63.4 and CISPR Publication 22.

1.6 INSTRUMENT CALIBRATION

RF Conducted Test Site					
Equipment	Manufacturer	Model	Serial Number	Cal Date	Cal Due
Coaxial Cable	Woken	WC12	CC003	06/29/2020	06/28/2021
Signal Analyzer	R&S	FSV 40	101073	09/25/2019	09/24/2020
Power Meter	Anritsu	ML2487A	6K00003260	05/21/2020	05/20/2021
Power Seneor	Anritsu	MA2490A	032910	05/21/2020	05/20/2021
Software	N/A				

Note:

1. The calibration interval of the above test instruments is 12 months and the calibrations are traceable to NML/ROC and NIST/USA.
2. N.C.R. = No Calibration Required.

3M 966 Chamber Test Site					
Equipment	Manufacturer	Model	Serial Number	Cal Date	Cal Due
Band Reject Filters	MICRO TRONICS	BRM 50702	120	02/25/2020	02/24/2021
Bilog Antenna	Sunol Sciences	JB3	A030105	07/24/2020	07/23/2021
Coaxial Cable	HUBER SUHNER	SUCOFLEX 104PEA	20995	02/25/2020	02/24/2021
Coaxial Cable	EMCI	EMC105	190914+25111	09/20/2019	09/19/2020
Digital Thermo-Hygro Meter	WISEWIND	1206	D07	01/15/2020	01/14/2021
double Ridged Guide Horn Antenna	ETC	MCTD 1209	DRH13M02003	10/04/2019	10/03/2020
Loop Ant	COM-POWER	AL-130	121051	03/27/2020	03/26/2021
Pre-Amplifier	EMEC	EM330	060609	02/25/2020	02/24/2021
Pre-Amplifier	HP	8449B	3008A00965	02/25/2020	02/24/2021
PSA Series Spectrum Analyzer	Agilent	E4446A	MY46180323	07/24/2020	07/23/2021
Antenna Tower	CCS	CC-A-1F	N/A	N.C.R	N.C.R
Controller	CCS	CC-C-1F	N/A	N.C.R	N.C.R
Turn Table	CCS	CC-T-1F	N/A	N.C.R	N.C.R
Software	e3 6.11-20180413				

Note:

1. The calibration interval of the above test instruments is 12 months and the calibrations are traceable to NML/ROC and NIST/USA.
2. N.C.R. = No Calibration Required.

1.7 SUPPORT AND EUT ACCESSORIES EQUIPMENT

EUT Accessories Equipment					
No.	Equipment	Brand	Model	Series No.	FCC ID
	N/A				

Support Equipment					
No.	Equipment	Brand	Model	Series No.	FCC ID
1	NB(J)	TOSHIBA	PT345T-00L002	N/A	PD97260H

1.8 TEST METHODOLOGY AND APPLIED STANDARDS

The test methodology, setups and results comply with all requirements in accordance with ANSI C63.10:2013, FCC Part 2, FCC Part 15.247, KDB 558074 D01, RSS-247 Issue 2 and RSS-GEN Issue 5



Report No.: T200824W11-RP

Page: 10 / 87
Rev.: 01

2. TEST SUMMARY

FCC Standard Section	IC Standard Section	Report Section	Test Item	Result
15.203	-	1.3	Antenna Requirement	Pass
15.207(a)	RSS-GEN 8.8	4.1	AC Conducted Emission	Pass
15.247(a)(2)	RSS-247(5.2)(a)	4.2	6 dB Bandwidth	Pass
-	RSS-GEN 6.7	4.2	Occupied Bandwidth (99%)	Pass
15.247(b)(3)	RSS-247(5.4)(d)	4.3	Output Power Measurement	Pass
15.247(e)	RSS-247(5.2)(b)	4.4	Power Spectral Density	Pass
15.247(d)	RSS-247(5.5)	4.5	Conducted Band Edge	Pass
15.247(d)	RSS-247(5.5)	4.5	Conducted Spurious Emission	Pass
15.247(d)	RSS-GEN 8.9, 8.10	4.6	Radiation Band Edge	Pass
15.247(d)	RSS-GEN 8.9, 8.10	4.6	Radiation Spurious Emission	Pass

3. DESCRIPTION OF TEST MODES

3.1 THE WORST MODE OF OPERATING CONDITION

Operation mode	BLE Mode (1Mbps) BLE Mode (2Mbps)
Test Channel Frequencies	1.Lowest Channel : 2402MHz 2.Middle Channel : 2442MHz 3.Highest Channel : 2480MHz

Remark:

1. EUT pre-scanned data rate of output power for each mode, the worst data rate were recorded in this report.

3.2 THE WORST MODE OF MEASUREMENT

Radiated Emission Measurement Below 1G	
Test Condition	Radiated Emission Below 1G
Power supply Mode	Mode 1: EUT power by Host System
Worst Mode	<input checked="" type="checkbox"/> Mode 1 <input type="checkbox"/> Mode 2 <input type="checkbox"/> Mode 3 <input type="checkbox"/> Mode 4

Radiated Emission Measurement Above 1G	
Test Condition	Radiated Emission Above 1G
Power supply Mode	Mode 1: EUT power by Host system.
Worst Mode	<input checked="" type="checkbox"/> Mode 1 <input type="checkbox"/> Mode 2 <input type="checkbox"/> Mode 3 <input type="checkbox"/> Mode 4
Worst Position	<input type="checkbox"/> Placed in fixed position. <input checked="" type="checkbox"/> Placed in fixed position at X-Plane (E2-Plane) <input type="checkbox"/> Placed in fixed position at Y-Plane (E1-Plane) <input type="checkbox"/> Placed in fixed position at Z-Plane (H-Plane)

Remark:

1. The worst mode was record in this test report.
2. EUT pre-scanned in three axis ,X,Y, Z and two polarity, for radiated measurement. The worst case(X-Plane) were recorded in this report
3. AC power line conducted emission and for below 1G radiation emission were performed the EUT transmit at the highest output power channel as worse case.



Report No.: T200824W11-RP

3.3 EUT DUTY CYCLE

Temperature: 25°C

Humidity: 50% RH

Tested by: Rick Lee

Duty Cycle				
Configuration	Duty Cycle (%)	Duty Factor (dB)	1/T (kHz)	VBW Setting (kHz)
BLE-1Mbps	11.65%	9.34	5.75	6.00
BLE-2Mbps	7.21%	11.42	9.86	10.00

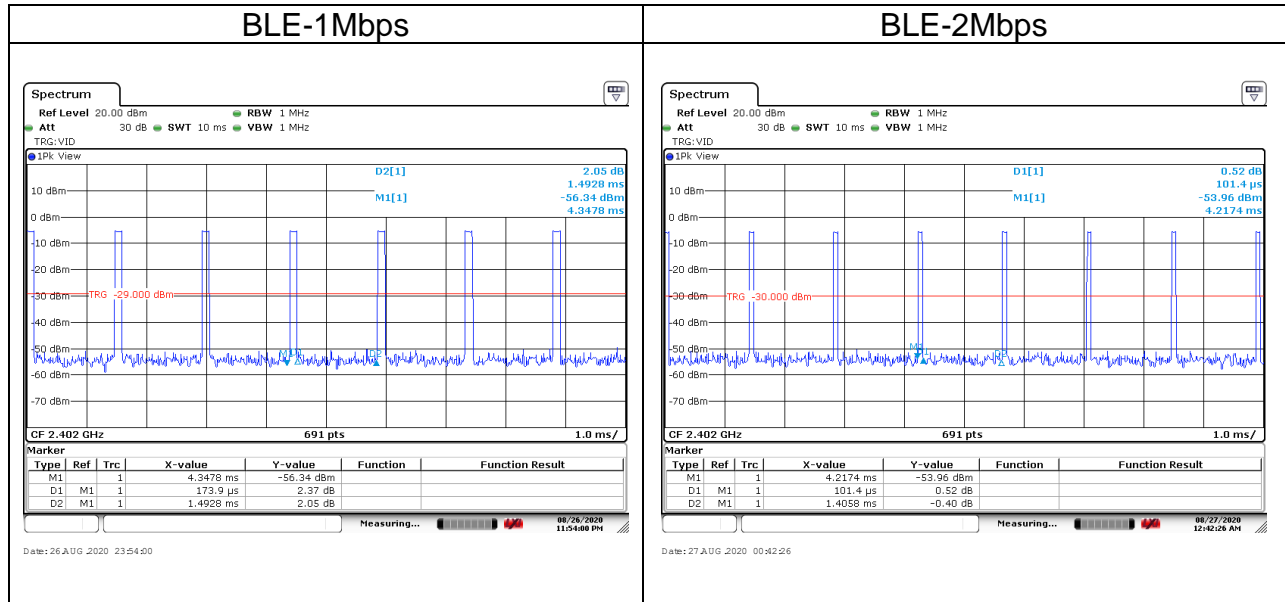

Report No.: T200824W11-RP

4. TEST RESULT

4.1 AC POWER LINE CONDUCTED EMISSION

4.1.1 Test Limit

According to §15.207(a) and RSS-GEN section 8.8,

Frequency Range (MHz)	Limits(dB μ V)	
	Quasi-peak	Average
0.15 to 0.50	66 to 56*	56 to 46*
0.50 to 5	56	46
5 to 30	60	50

* Decreases with the logarithm of the frequency.

4.1.2 Test Procedure

Test method Refer as ANSI C63.10: 2013 clause 6.2,

1. The EUT was placed above horizontal ground plane and 0.4m above vertical ground plane
2. EUT connected to the line impedance stabilization network (LISN)
3. Receiver set RBW of 9kHz and Detector Peak, and note as quasi-peak and average.
4. Maximum procedure was performed on the six highest emissions to ensure EUT compliance.
5. Recorded Line for Neutral and Line.

4.1.3 Test Setup

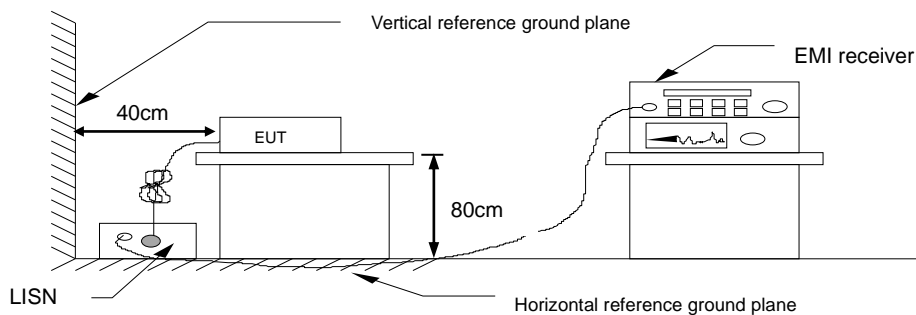

4.1.4 Test Result

Not applicable, because EUT doesn't connect to AC Main Source direct..

Report No.: T200824W11-RP

4.2 6dB BANDWIDTH AND OCCUPIED BANDWIDTH (99%)

4.2.1 Test Limit

According to §15.247(a)(2) and RSS-247 section 5.2(a)

6 dB Bandwidth :

Limit	Shall be at least 500kHz
-------	--------------------------

Occupied Bandwidth(99%) : For reporting purposes only.

4.2.2 Test Procedure

Test method Refer as KDB 558074 D01 and ANSI C63.10: 2013 clause 6.9.2,

1. The EUT RF output connected to the spectrum analyzer by RF cable.
2. Setting maximum power transmit of EUT.
3. SA set RBW =100KHz, VBW = 300KHz and Detector = Peak, to measurement 6dB Bandwidth.
4. SA set RBW = 1% ~ 5% OBW, VBW = three times the RBW and Detector = Peak, to measurement 99% Bandwidth.
5. Measure and record the result of 6 dB Bandwidth and 99% Bandwidth. in the test report.

4.2.3 Test Setup

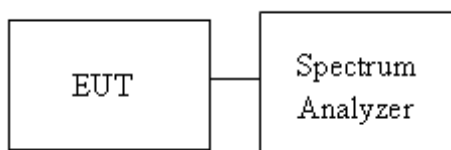



Report No.: T200824W11-RP

Page: 16 / 87
Rev.: 01

4.2.4 Test Result

Temperature: 25°C

Humidity: 50% RH

Tested by: Rick Lee

Test mode: BLE-1Mbps mode / 2402-2480 MHz				
Channel	Frequency (MHz)	OBW (99%) (MHz)	6dB BW (MHz)	6dB limit (kHz)
Low	2402	1.0332	0.6860	>500
Mid	2442	1.0332	0.6860	
High	2480	1.0419	0.6860	
Test mode: BLE-2Mbps mode / 2402-2480 MHz				
Low	2402	2.0188	1.1548	>500
Mid	2442	2.0188	1.1505	
High	2480	2.0274	1.1635	

Test Data

6dB BANDWIDTH

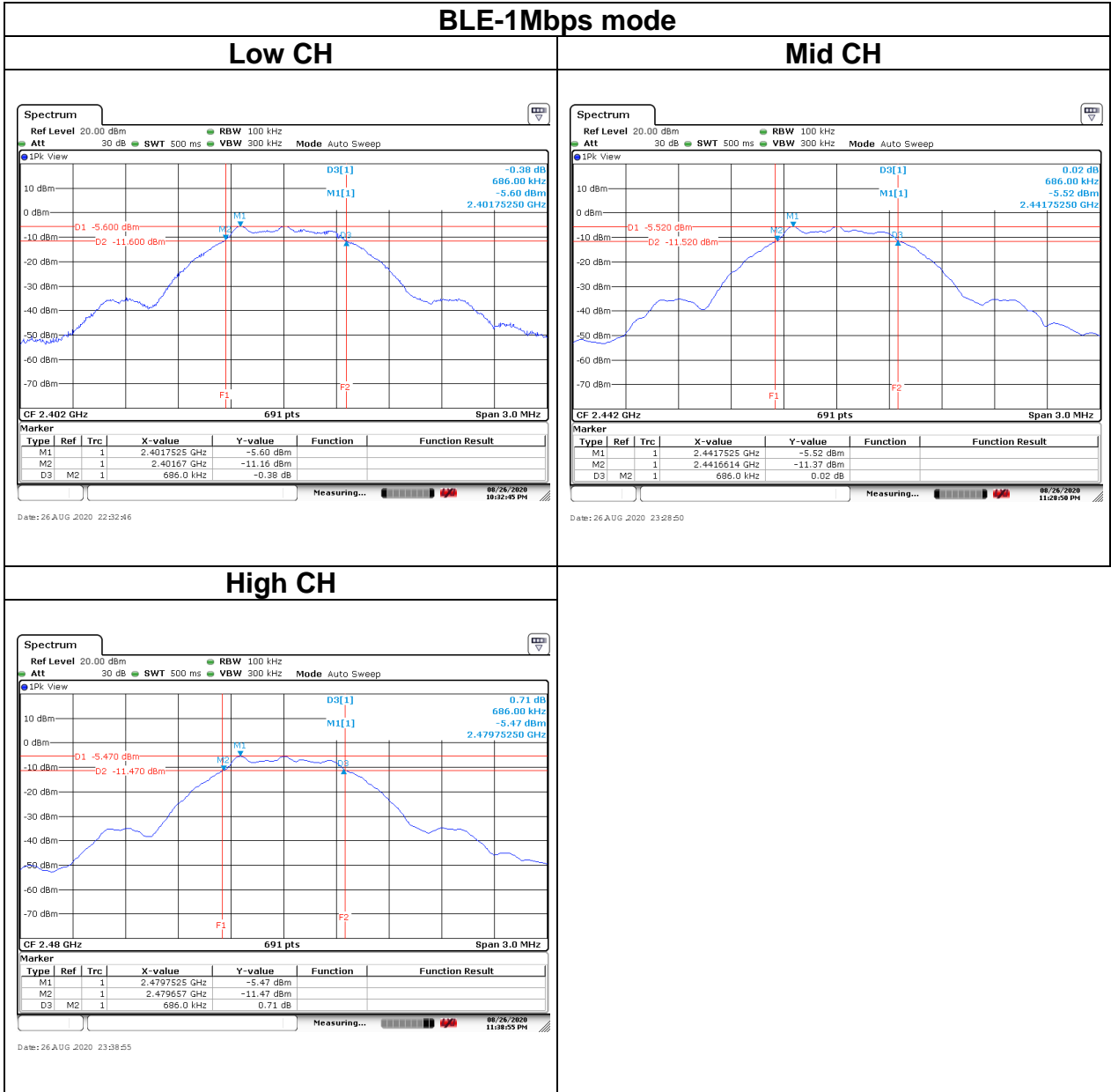

BLE-2Mbps mode

Low CH

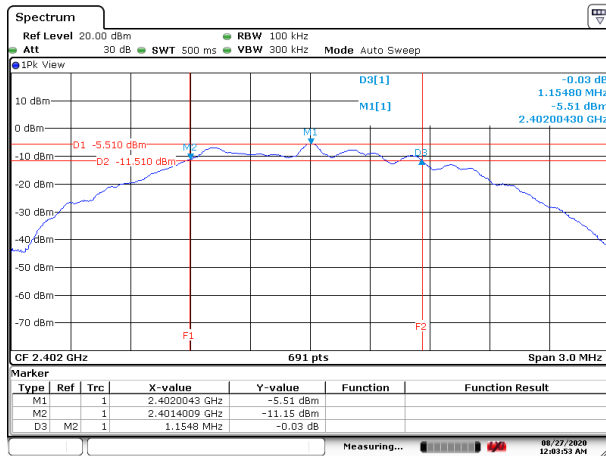

Mid CH

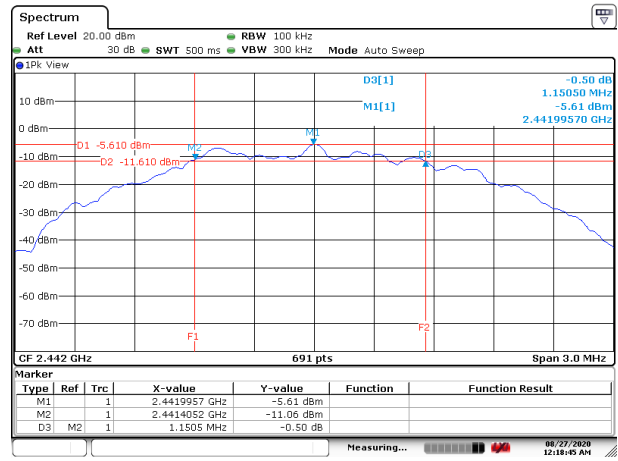

High CH

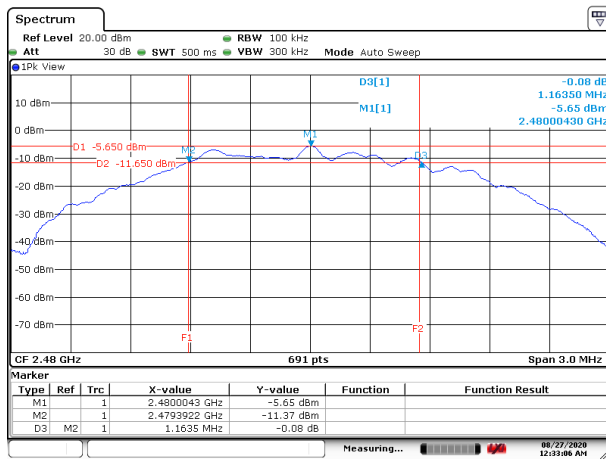

Test Data

BANDWIDTH (99%)

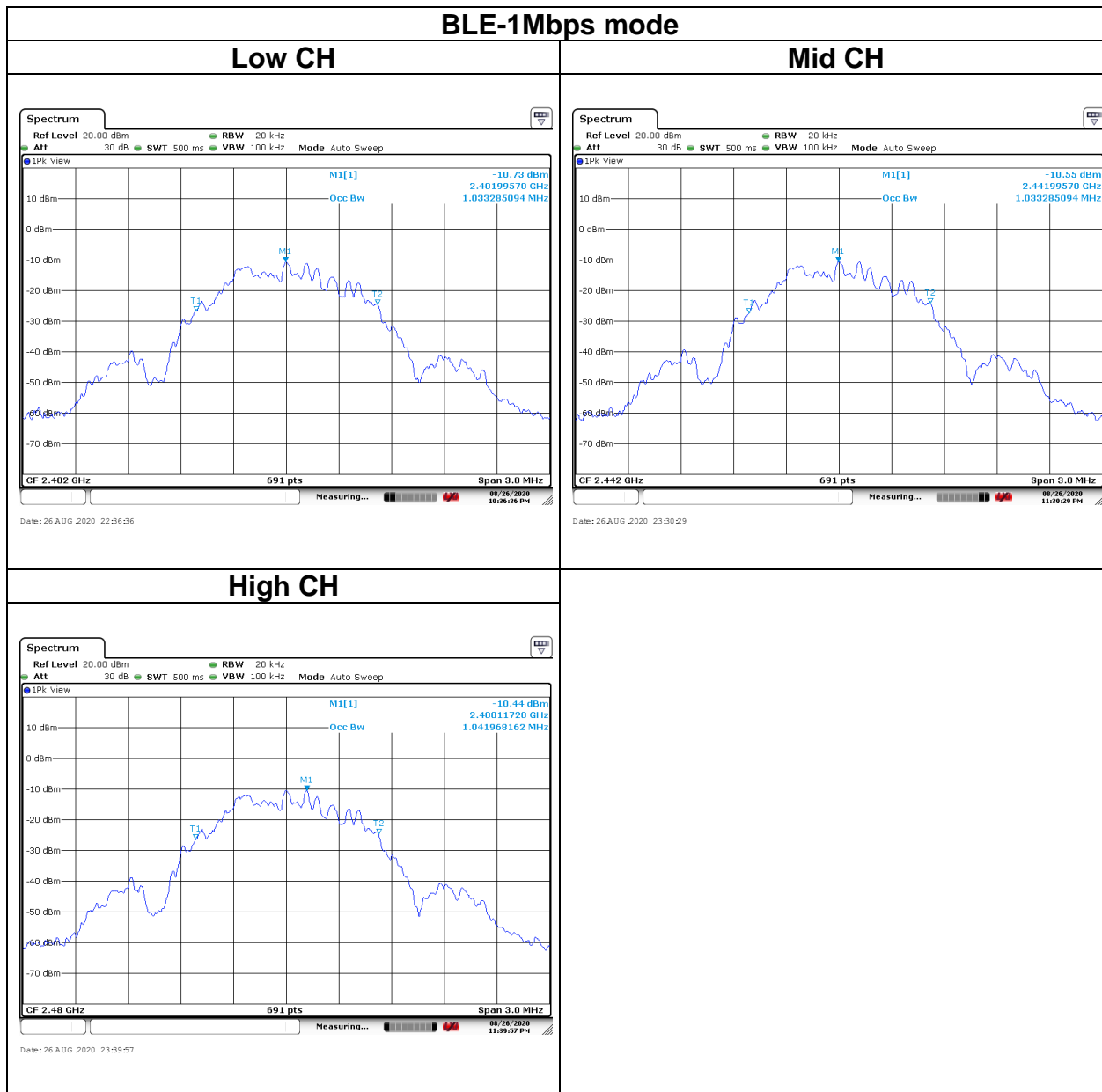

Report No.: T200824W11-RP

BLE-2Mbps mode

Low CH

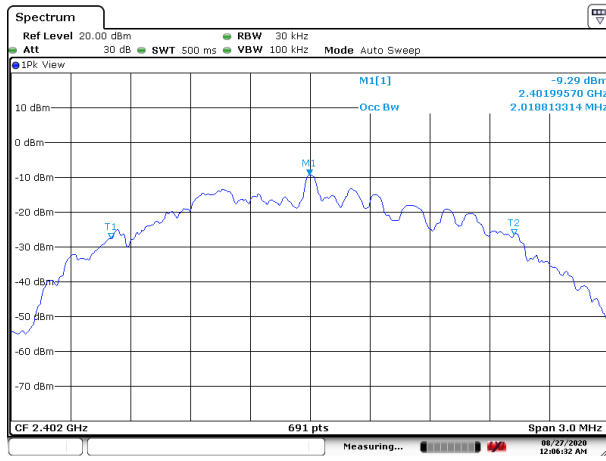

Mid CH

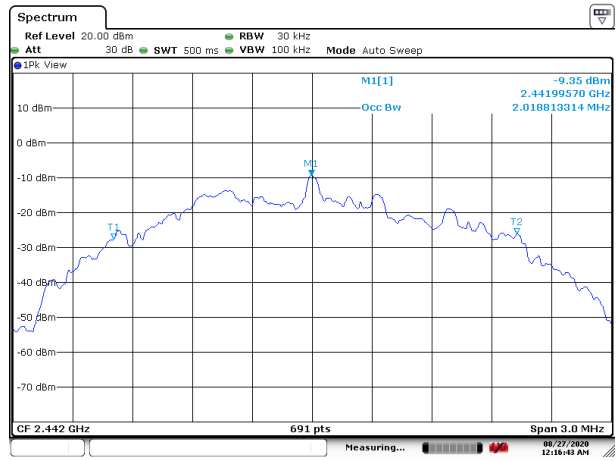

High CH

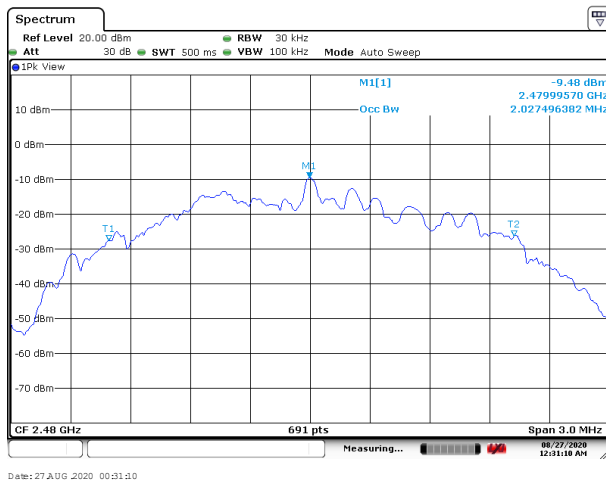



4.3 OUTPUT POWER MEASUREMENT

4.3.1 Test Limit

According to §15.247(b)(3) and RSS-247 section 5.4(d)

Peak output power :

FCC

Alternatively, frequency hopping systems operating in the 2400-2483.5 MHz band may have hopping channel carrier frequencies that are separated by 25 kHz or two-thirds of the 20 dB bandwidth of the hopping channel, whichever is greater, provided the systems operate with an output power no greater than 125 mW.

IC

For DTSs employing digital modulation techniques operating in the bands 902-928 MHz and 2400-2483.5 MHz, the maximum peak conducted output power shall not exceed 1 W. The e.i.r.p. shall not exceed 4 W, except as provided in section 5.4(e), base on the use of antennas with directional gain not exceed 6 dBi If transmitting antennas of directional gain greater than 6dBi are used the peak output power the conducted output power from the intentional radiator shall be reduced by the amount in dB that the directional gain of the antenna exceeds 6 dBi. In case of point-to-point operation, the limit has to be reduced by 1dB for every 3 dB that the directional gain of the antenna exceeds 6 dBi.

Limit	<input checked="" type="checkbox"/> Antenna not exceed 6 dBi : 30dBm <input type="checkbox"/> Antenna with DG greater than 6 dBi [Limit = 30 – (DG – 6)] <input type="checkbox"/> Point-to-point operation
-------	---

Average output power : For reporting purposes only.

4.3.2 Test Procedure

Test method Refer as KDB 558074 D01.

1. The EUT RF output connected to the power meter by RF cable.
2. Setting maximum power transmit of EUT.
3. The path loss was compensated to the results for each measurement.
4. Measure and record the result of Peak output power and Average output power. in the test report.

4.3.3 Test Setup

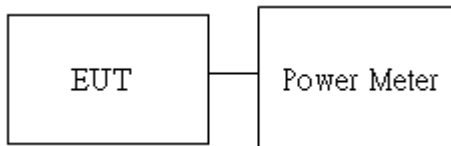

Report No.: T200824W11-RP

4.3.4 Test Result

Temperature: 25°C

Humidity: 50% RH

Tested by: Rick Lee

Test Date: August 27, 2020

Peak output power :

BLE Mode									
Config.	CH	Freq. (MHz)	Power Setting	PK Power (dBm)	EIRP PK Power (dBm)	PK Power (W)	EIRP PK Power (W)	FCC/IC Limit (dBm)	IC EIRP Limit (dBm)
BLE Data rate: 1Mbps	0	2402	8	5.34	-0.47	0.0034	0.0009	30	36
	19	2442	8	5.22	-0.59	0.0033	0.0009		
	39	2480	8	5.32	-0.49	0.0034	0.0009		
BLE Data rate: 2Mbps	0	2402	8	5.35	-0.46	0.0034	0.0009	30	36
	19	2442	8	5.29	-0.52	0.0034	0.0009		
	39	2480	8	5.15	-0.66	0.0033	0.0009		

Average output power :

BLE Mode			
Config.	CH	Freq. (MHz)	AV Power (dBm)
BLE Data rate: 1Mbps	0	2402	4.98
	19	2442	4.97
	39	2480	4.90
BLE Data rate: 2Mbps	0	2402	5.01
	19	2442	4.98
	39	2480	4.90

Report No.: T200824W11-RP

4.4 POWER SPECTRAL DENSITY

4.4.1 Test Limit

According to §15.247(e) and RSS-247 section 5.2(b)

For digitally modulated systems, the power spectral density conducted from the intentional radiator to the antenna shall not be greater than 8 dBm in any 3 kHz band during any time interval of continuous transmission.

Limit	<input checked="" type="checkbox"/> Antenna not exceed 6 dBi : 8dBm <input type="checkbox"/> Antenna with DG greater than 6 dBi [Limit = 8 – (DG – 6)] <input type="checkbox"/> Point-to-point operation :
-------	---

4.4.2 Test Procedure

Test method Refer as KDB 558074 D01.

1. The EUT RF output connected to the spectrum analyzer by RF cable.
2. Setting maximum power transmit of EUT
3. SA set RBW = 3kHz, VBW = 10kHz, Span = 1.5 times DTS Bandwidth (6 dB BW), Detector = Peak, Sweep Time = Auto and Trace = Max hold.
4. The path loss and Duty Factor were compensated to the results for each measurement by SA.
5. Mark the maximum level.
6. Measure and record the result of power spectral density. in the test report.

4.4.3 Test Setup





Report No.: T200824W11-RP

Page: 25 / 87
Rev.: 01

4.4.4 Test Result

Temperature: 25°C

Humidity: 50% RH

Tested by: Rick Lee

Test mode: BLE-1Mbps mode / 2402-2480 MHz			
Channel	Frequency (MHz)	PSD (dBm)	FCC limit (dBm)
Low	2402	-9.72	8
Mid	2442	-9.78	
High	2480	-9.86	

Test mode: BLE-2Mbps mode / 2402-2480 MHz			
Channel	Frequency (MHz)	PSD (dBm)	FCC limit (dBm)
Low	2402	-12.78	8
Mid	2442	-12.97	
High	2480	-13.11	

Report No.: T200824W11-RP

Test Data

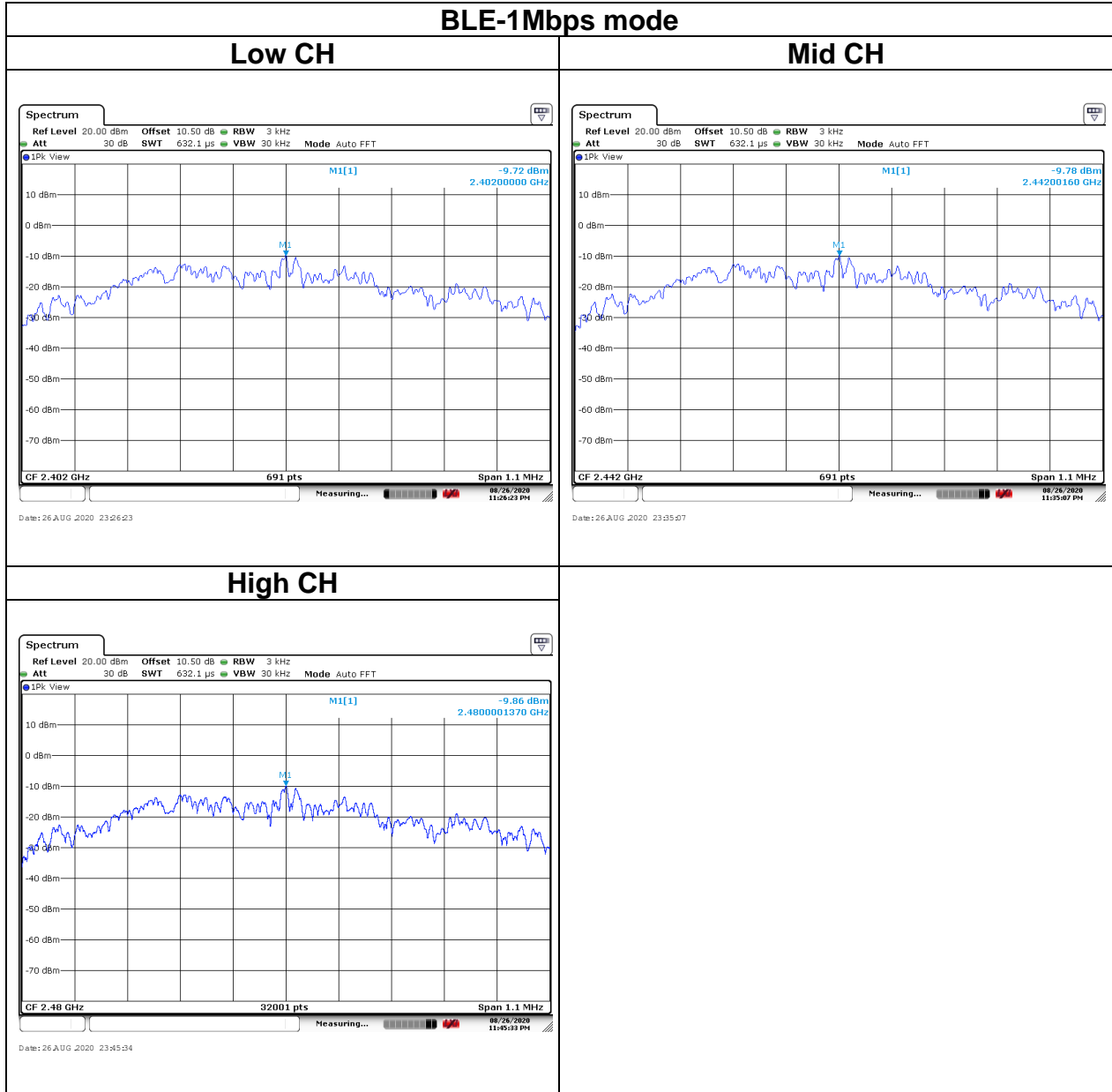



Report No.: T200824W11-RP

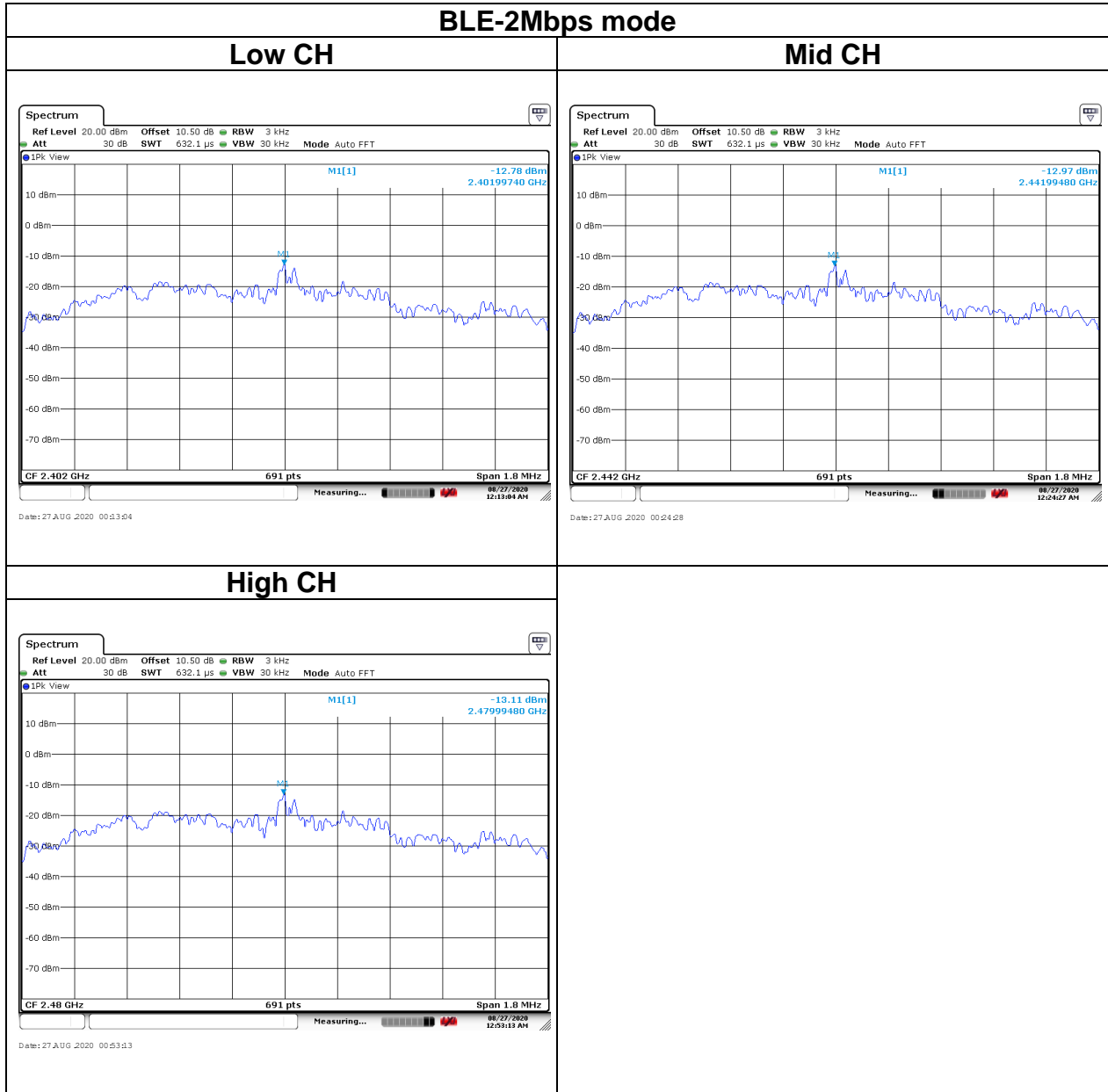

4.5 CONDUCTED BAND EDGE AND SPURIOUS EMISSION

4.5.1 Test Limit

According to §15.247(d) and RSS-247 section 5.5

FCC: In any 100 kHz bandwidth outside the authorized frequency band,

Non-restricted bands shall be attenuated at least 20 dB/30 dB relative to the maximum PSD level in 100 kHz by RF conducted or a radiated measurement which fall in the restricted bands, as defined in §15.205(a), must also comply with the radiated emission limits specified in §15.209(a).

IC: In any 100 kHz bandwidth outside the frequency band in which the spread spectrum or digitally modulated device is operating, the RF power that is produced shall be at least 20 dB below that in the 100 kHz bandwidth within the band that contains the highest level of the desired power, based on either an RF conducted or a radiated measurement, provided that the transmitter demonstrates compliance with the peak conducted power limits. If the transmitter complies with the conducted power limits based on the use of root-mean-square averaging over a time interval, as permitted under section 5.4(d), the attenuation required shall be 30 dB instead of 20 dB. Attenuation below the general field strength limits specified in RSS-Gen is not required.

4.5.2 Test Procedure

Test method Refer as KDB 558074 D01.

1. EUT RF output port connected to the SA by RF cable, and the path loss was compensated to result.
2. SA setting, RBW=100kHz, VBW=300kHz, Detector=Peak, Trace mode = max hold, SWT = Auto.
3. In any 100 kHz bandwidth outside the authorized frequency band, shall be attenuated at least 20 dB relative to the maximum in-band peak PSD level in 100 kHz when conducted power procedure is used. If the transmitter complies with the conducted power limits based on the use of RMS averaging over a time interval, the attenuation required under this paragraph shall be 30 dB instead of 20 dB.

4.5.3 Test Setup



Report No.: T200824W11-RP

4.5.4 Test Result

Test Data

Temperature: 25°C

Humidity: 50% RH

Tested by: Rick Lee

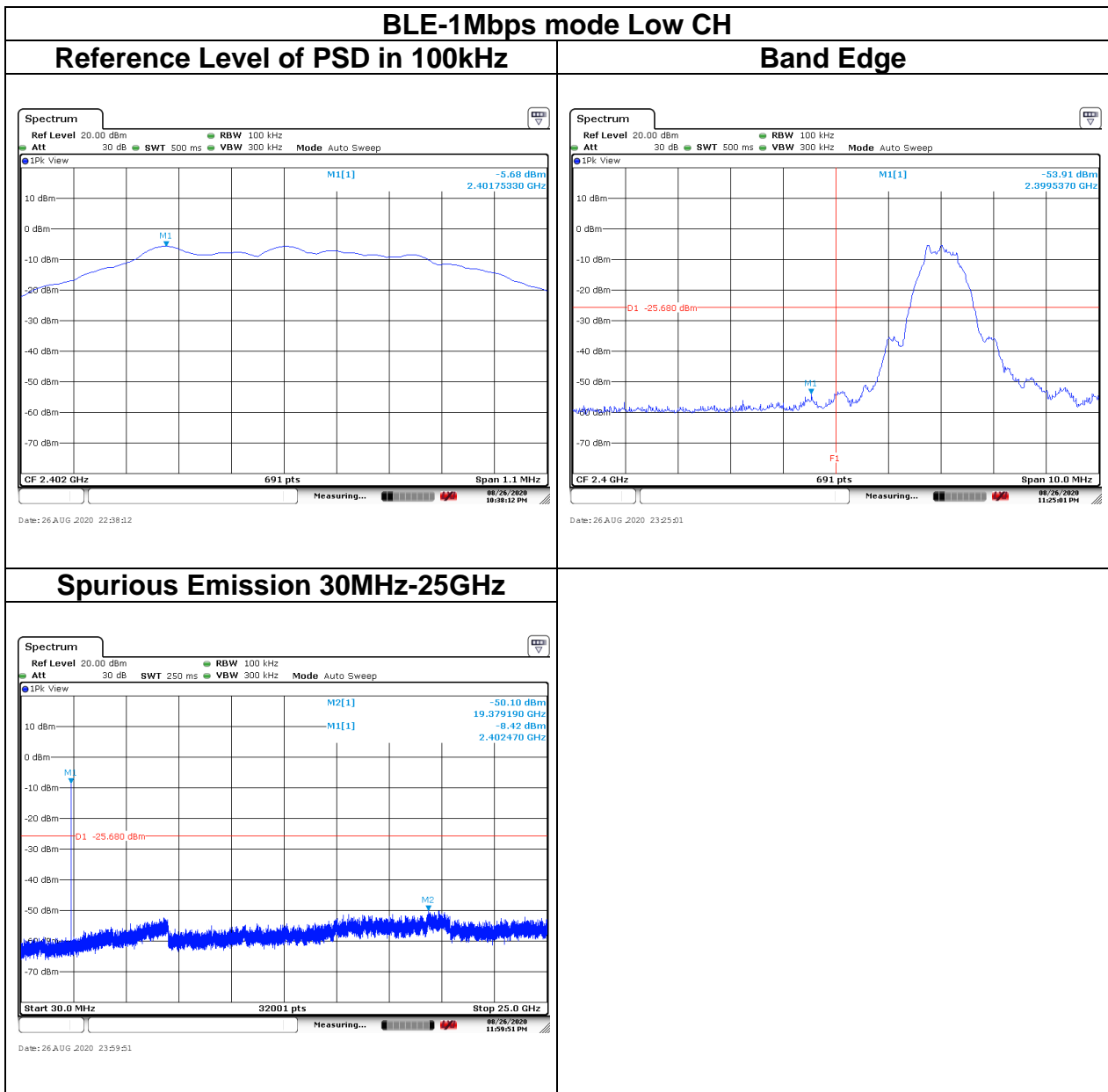

Report No.: T200824W11-RP

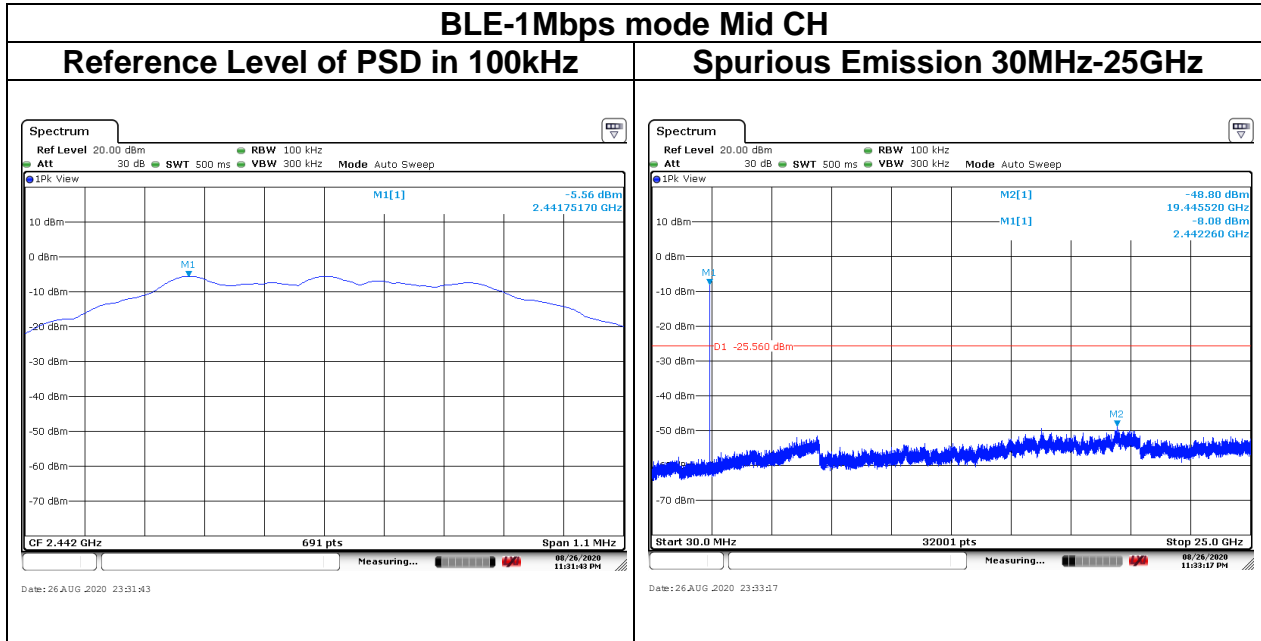

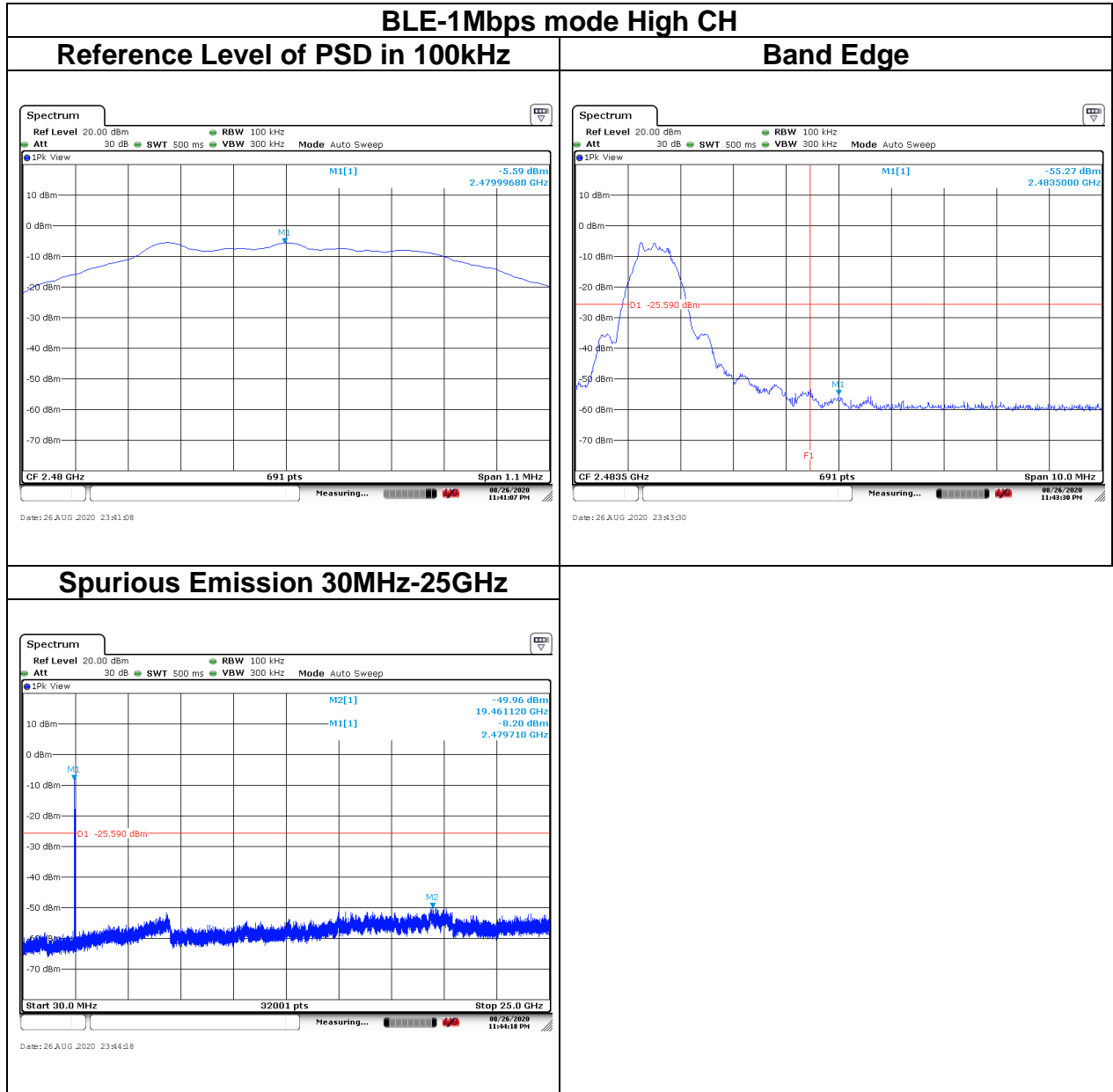

Report No.: T200824W11-RP

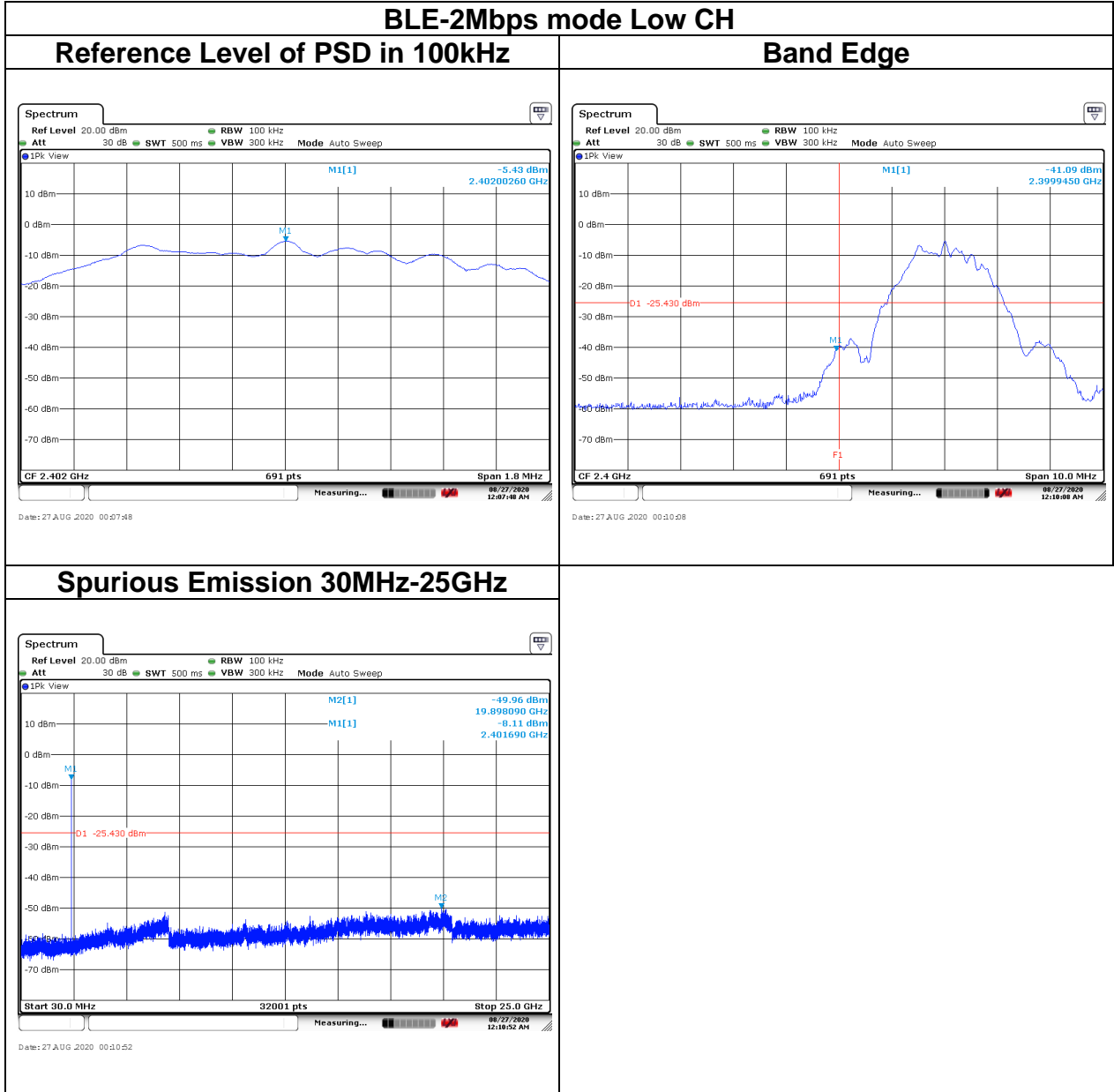

Report No.: T200824W11-RP

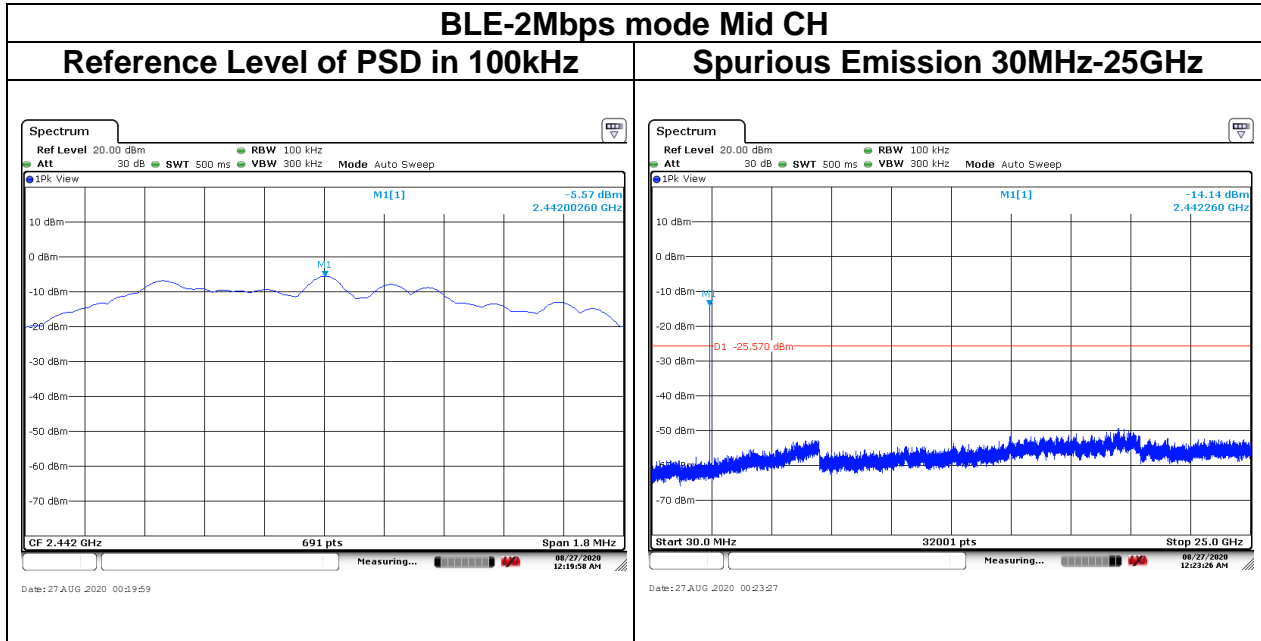

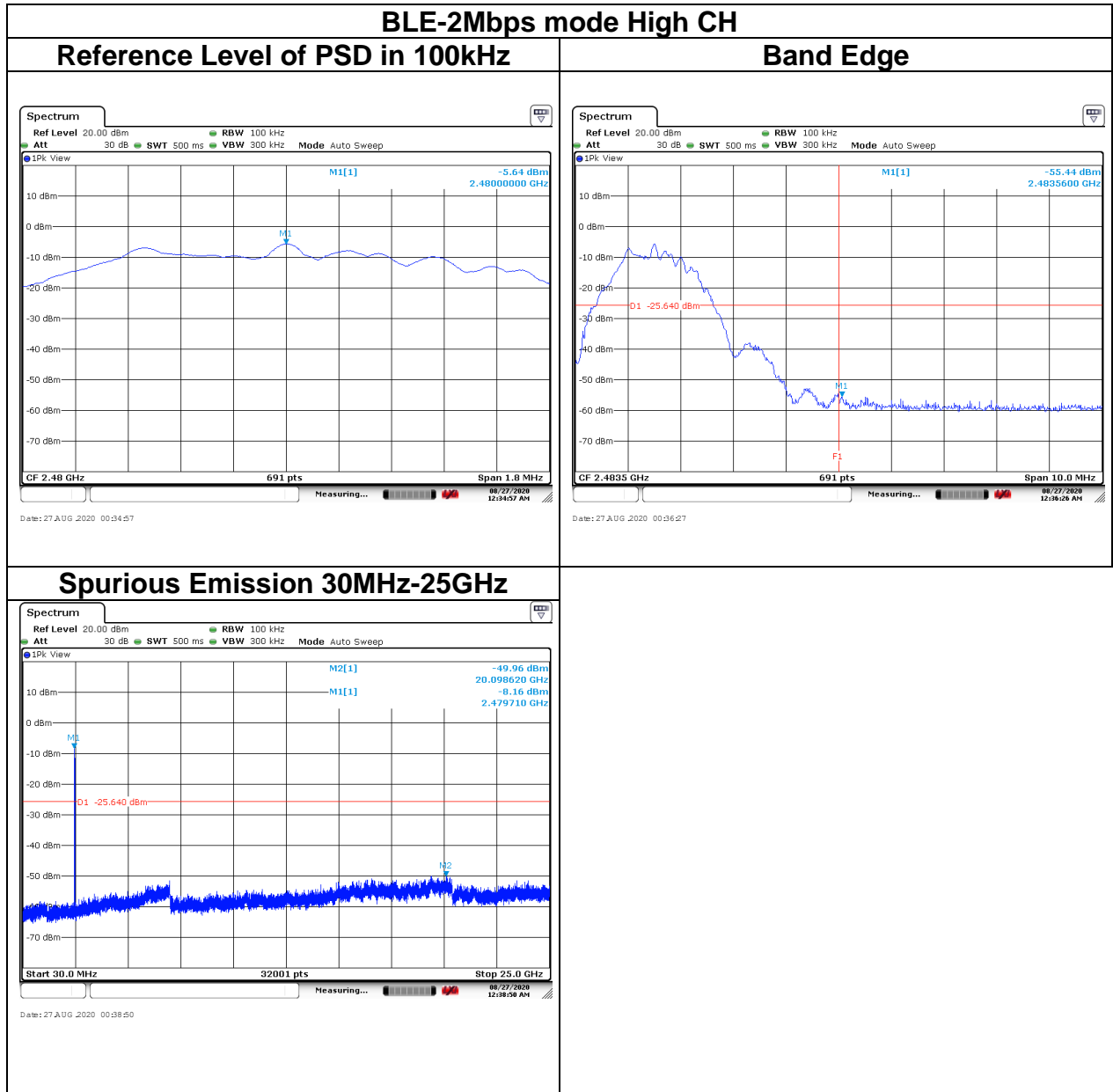

Report No.: T200824W11-RP

4.6 RADIATION BANDEDGE AND SPURIOUS EMISSION

4.6.1 Test Limit

FCC according to §15.247(d), §15.209 and §15.205,

IC according to RSS-247 section 5.5, RSS-Gen, Section 8.9 and 8.10

In any 100 kHz bandwidth outside the authorized frequency band, all harmonic and spurious must be least 20 dB below the highest emission level with the authorized frequency band. Radiation emission which fall in the restricted bands must also follow the FCC section 15.209 as below limit in table.

Below 30 MHz

Frequency	Field Strength (microvolts/m)	Magnetic H-Field (microamperes/m)	Measurement Distance (metres)
9-490 kHz	2,400/F (F in kHz)	2,400/F (F in kHz)	300
490-1,705 kHz	24,000/F (F in kHz)	24,000/F (F in kHz)	30
1.705-30 MHz	30	N/A	30

Above 30 MHz

Frequency (MHz)	Field Strength microvolts/m at 3 metres (watts, e.i.r.p.)	
	Transmitters	Receivers
30-88	100 (3 nW)	100 (3 nW)
88-216	150 (6.8 nW)	150 (6.8 nW)
216-960	200 (12 nW)	200 (12 nW)
Above 960	500 (75 nW)	500 (75 nW)

Remark:

Although these tests were performed other than open area test site, adequate comparison measurements were confirmed against 30 m open are test site. Therefore sufficient tests were made to demonstrate that the alternative site produces results that correlate with the ones of tests made in an open field based on KDB 414788.

IC according to RSS-247 section 5.5, RSS-Gen, Section 8.9 and 8.10

RSS-Gen Table 3 and Table 5 – General Field Strength Limits for Transmitters and Receivers at Frequencies Above 30 MHz (Note)

Frequency (MHz)	Field Strength microvolts/m at 3 metres (watts, e.i.r.p.)	
	Transmitters	Receivers
30-88	100 (3 nW)	100 (3 nW)
88-216	150 (6.8 nW)	150 (6.8 nW)
216-960	200 (12 nW)	200 (12 nW)
Above 960	500 (75 nW)	500 (75 nW)

Note: Measurements for compliance with the limits in table 3 may be performed at distances other than 3 metres, in accordance with Section 6.6.

RSS-Gen Table 6: General Field Strength Limits for Transmitters at Frequencies Below 30 MHz (Transmit)

Frequency	Magnetic field strength (H-Field) ($\mu\text{A/m}$)	Measurement Distance (m)
9-490 kHz ^{Note}	6.37/F (F in kHz)	300
490-1,705 kHz	63.7/F (F in kHz)	30
1.705-30 MHz	0.08	30

Note: The emission limits for the ranges 9-90 kHz and 110-490 kHz are based on measurements employing a linear average detector.

Report No.: T200824W11-RP

4.6.2 Test Procedure

Test method Refer as KDB 558074 D01.

1. The EUT is placed on a turntable, Above 1 GHz is 1.5m and below 1 GHz is 0.8m above ground plane. The EUT Configured un accordance with ANSI C63.10: 2013, and the EUT set in a continuous mode.
2. The turntable shall be rotated for 360 degrees to determine the position of maximum emission level. And EUT is set 3m away from the receiving antenna, which is scanned from 1m to 4m above the ground plane to find out the highest emissions. Measurement are made polarized in both the vertical and the horizontal positions with antenna.
3. Span shall wide enough to full capture the emission measured. The SA from 9KHz to 26.5GHz set to the low, Mid and High channels with the EUT transmit.

Remark:

1. Although these tests were performed other than open area test site, adequate comparison measurements were confirmed against 30 m open are test site. Therefore sufficient tests were made to demonstrate that the alternative site produces results that correlate with the ones of tests made in an open field based on KDB 414788.
 2. No emission found between lowest internal used/generated frequency to 30MHz (9kHz~30MHz).
4. The SA setting following :
- (1) Below 1G : RBW = 100kHz, VBW \geq 3 RBW, Sweep = Auto, Detector = Peak, Trace = Max hold.
 - (2) Above 1G :
 - (2.1) For Peak measurement : RBW = 1MHz, VBW \geq 3 RBW, Sweep = Auto, Detector = Peak, Trace = Max hold.
 - (2.2) For Average measurement : RBW = 1MHz, VBW
 - 'If Duty Cycle \geq 98%, VBW=10Hz.
 - 'If Duty Cycle < 98%, VBW=1/T.

4.6.3 Test Setup

9kHz ~ 30MHz

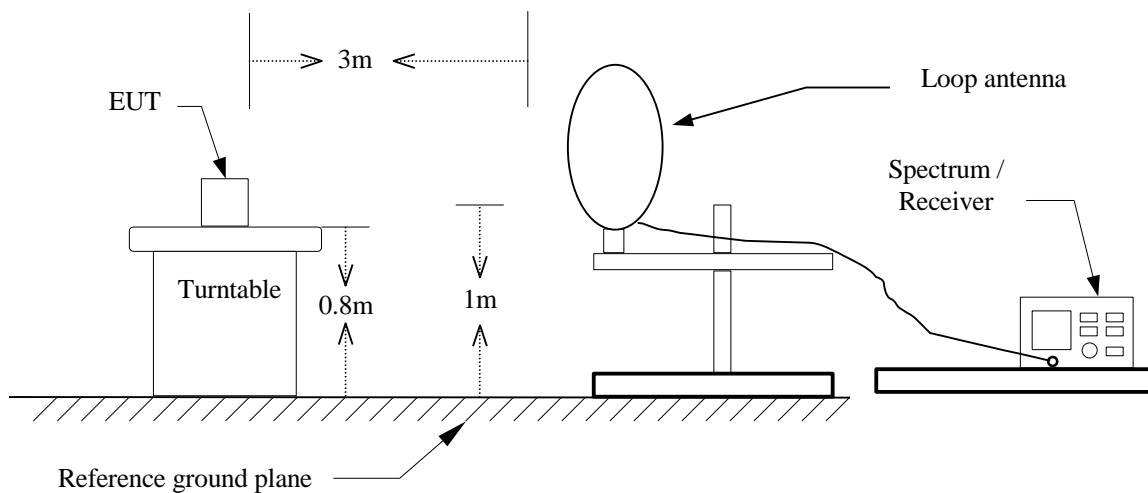

30MHz ~ 1GHz

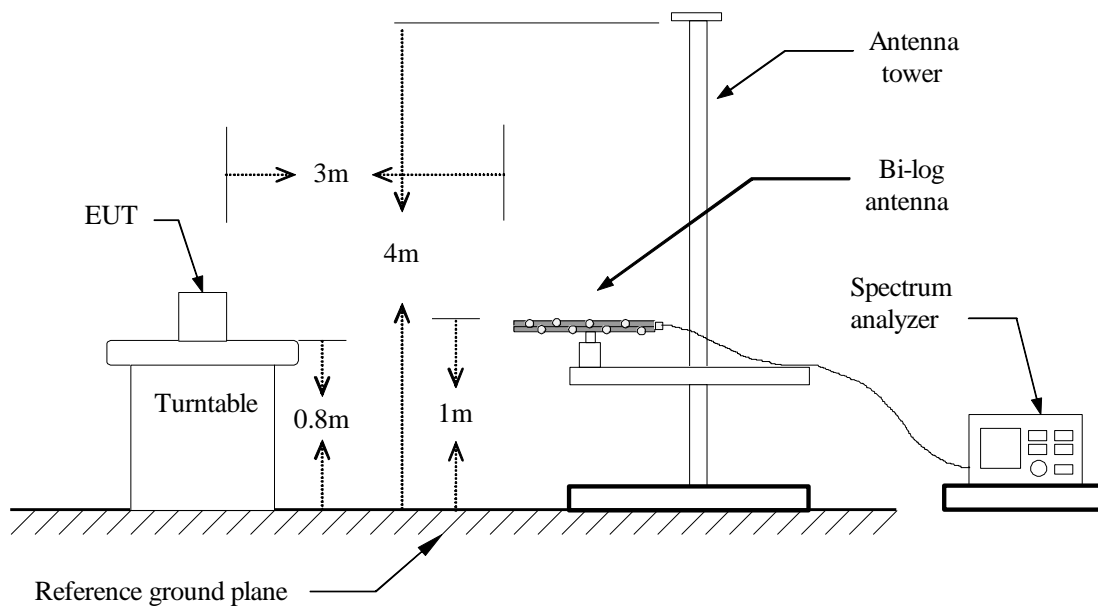

Above 1 GHz

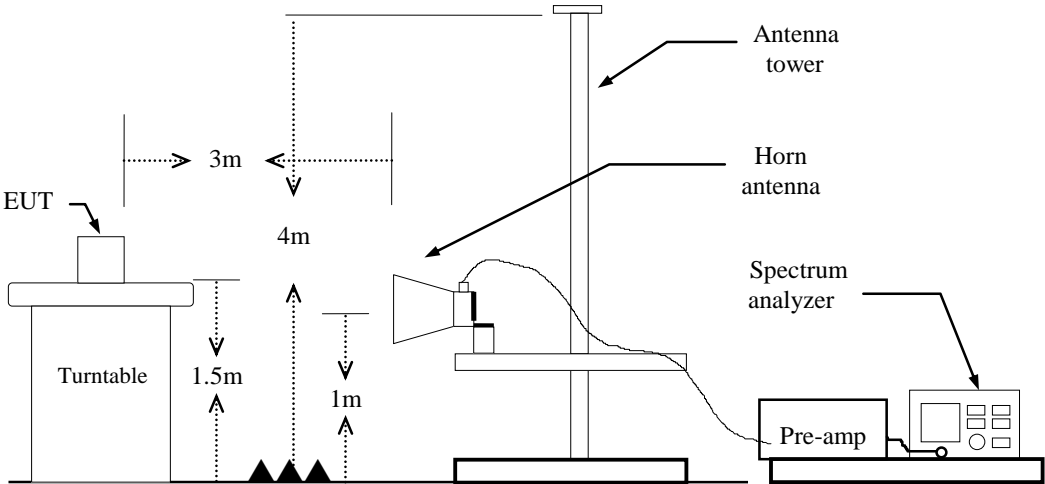

Report No.: T200824W11-RP

4.6.4 Test Result

Band Edge Test Data

Model: MDBT42TV

Test Mode:	BLE-1Mbps Low CH	Temp/Hum	25.0(°C)/ 43%RH
Test Item	Band Edge	Test Date	September 8, 2020
Polarize	Vertical	Test Engineer	Jerry Chang
Detector	Peak / Average		

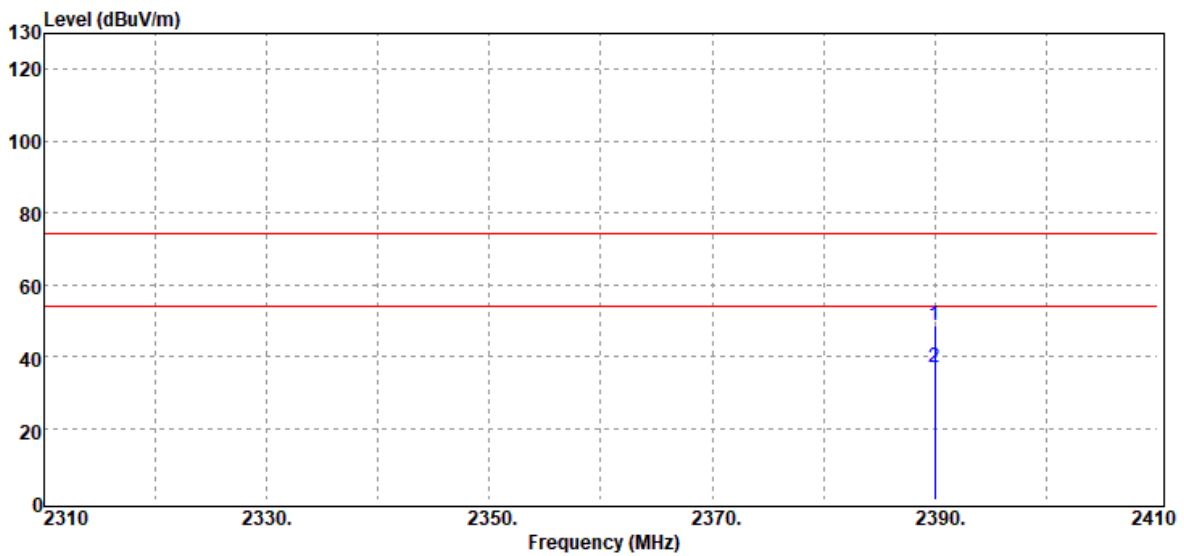

Freq. MHz	Detector Mode PK/QP/AV	Spectrum Reading Level dB μ V	Factor dB	Actual FS dB μ V/m	Limit @3m dB μ V/m	Margin dB
2390.00	Peak	51.88	-3.17	48.71	74.00	-25.29
2390.00	Average	40.13	-3.17	36.96	54.00	-17.04

Report No.: T200824W11-RP

Test Mode:	BLE-1Mbps Low CH	Temp/Hum	25.0(°C)/ 43%RH
Test Item	Band Edge	Test Date	September 8, 2020
Polarize	Horizontal	Test Engineer	Jerry Chang
Detector	Peak / Average		

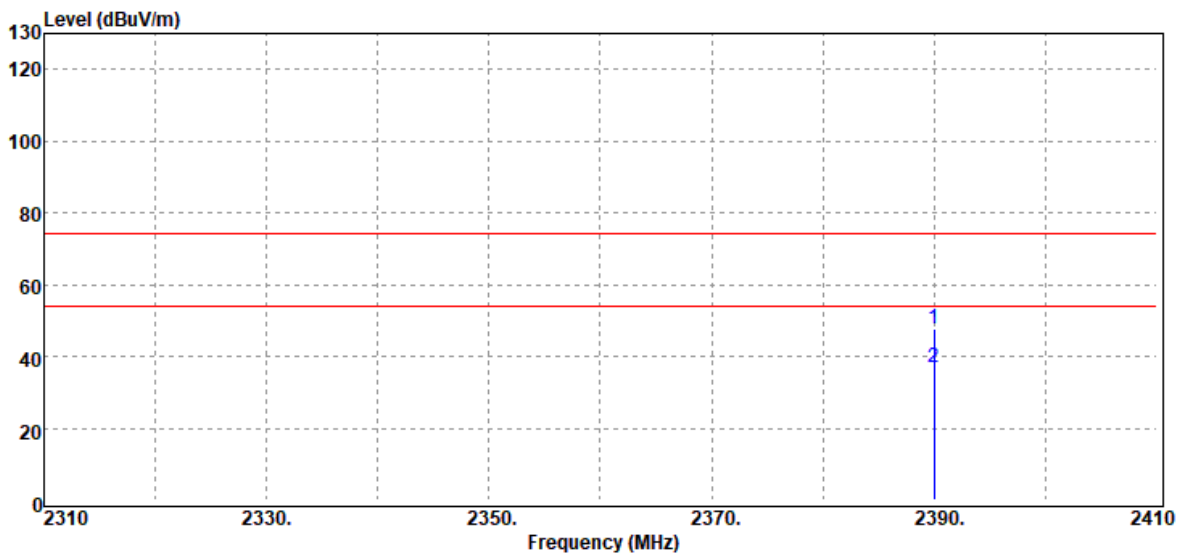

Freq. MHz	Detector Mode PK/QP/AV	Spectrum Reading Level dB μ V	Factor dB	Actual FS dB μ V/m	Limit @3m dB μ V/m	Margin dB
2390.00	Peak	50.92	-3.17	47.75	74.00	-26.25
2390.00	Average	39.98	-3.17	36.81	54.00	-17.19

Report No.: T200824W11-RP

Test Mode:	BLE-1Mbps High CH	Temp/Hum	25.0(°C)/ 43%RH
Test Item	Band Edge	Test Date	September 8, 2020
Polarize	Vertical	Test Engineer	Jerry Chang
Detector	Peak / Average		

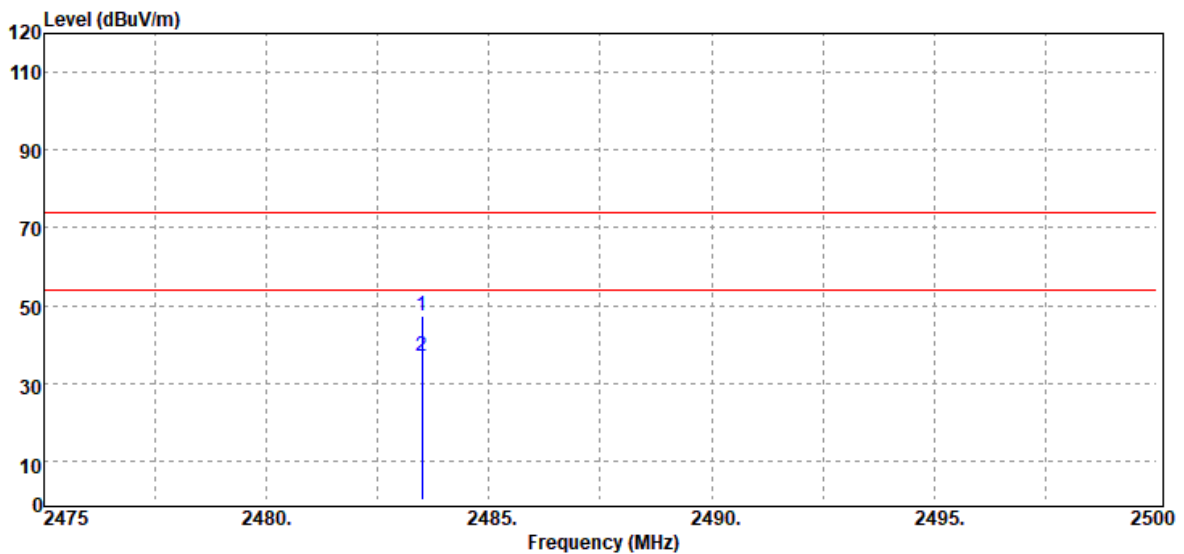

Freq. MHz	Detector Mode PK/QP/AV	Spectrum Reading Level dB μ V	Factor dB	Actual FS dB μ V/m	Limit @3m dB μ V/m	Margin dB
2483.50	Peak	49.90	-2.71	47.19	74.00	-26.81
2483.50	Average	39.62	-2.71	36.91	54.00	-17.09

Report No.: T200824W11-RP

Test Mode:	BLE-1Mbps High CH	Temp/Hum	25.0(°C)/ 43%RH
Test Item	Band Edge	Test Date	September 8, 2020
Polarize	Horizontal	Test Engineer	Jerry Chang
Detector	Peak / Average		

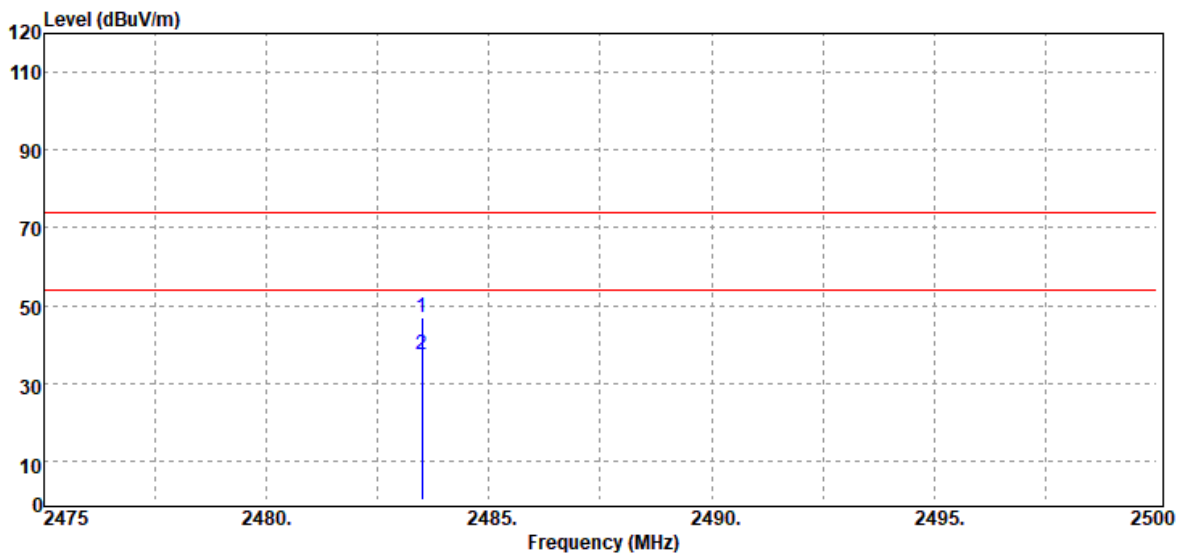

Freq. MHz	Detector Mode PK/QP/AV	Spectrum Reading Level dB μ V	Factor dB	Actual FS dB μ V/m	Limit @3m dB μ V/m	Margin dB
2483.50	Peak	49.57	-2.71	46.86	74.00	-27.14
2483.50	Average	40.21	-2.71	37.50	54.00	-16.50

Report No.: T200824W11-RP

Test Mode:	BLE-2Mbps Low CH	Temp/Hum	25.0(°C)/ 43%RH
Test Item	Band Edge	Test Date	September 8, 2020
Polarize	Vertical	Test Engineer	Jerry Chang
Detector	Peak / Average		

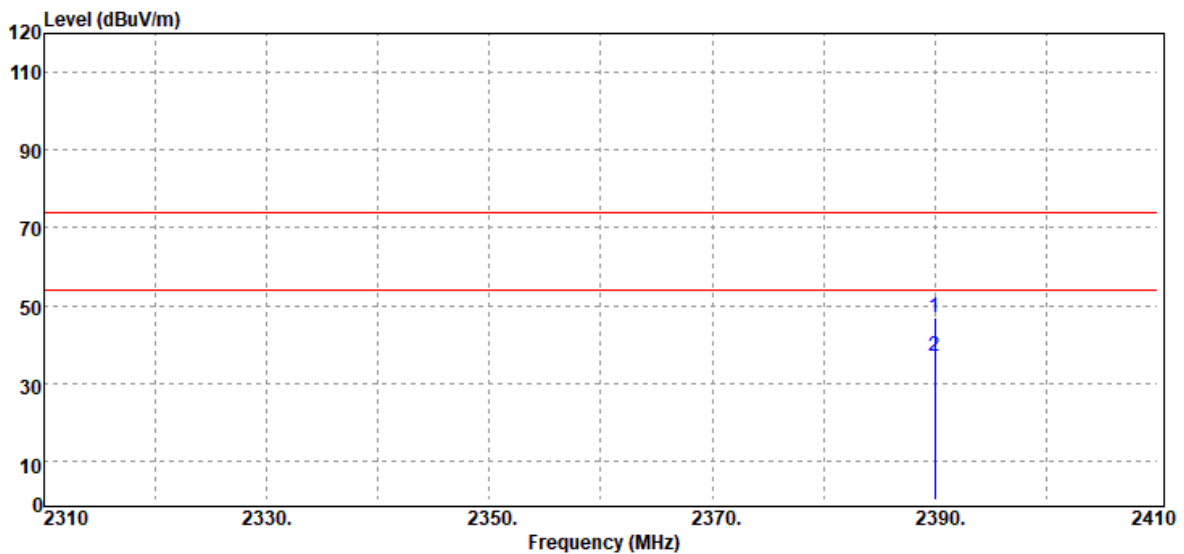

Freq. MHz	Detector Mode PK/QP/AV	Spectrum Reading Level dB μ V	Factor dB	Actual FS dB μ V/m	Limit @3m dB μ V/m	Margin dB
2390.00	Peak	50.05	-3.17	46.88	74.00	-27.12
2390.00	Average	40.13	-3.17	36.96	54.00	-17.04

Report No.: T200824W11-RP

Test Mode:	BLE-2Mbps Low CH	Temp/Hum	25.0(°C)/ 43%RH
Test Item	Band Edge	Test Date	September 8, 2020
Polarize	Horizontal	Test Engineer	Jerry Chang
Detector	Peak / Average		

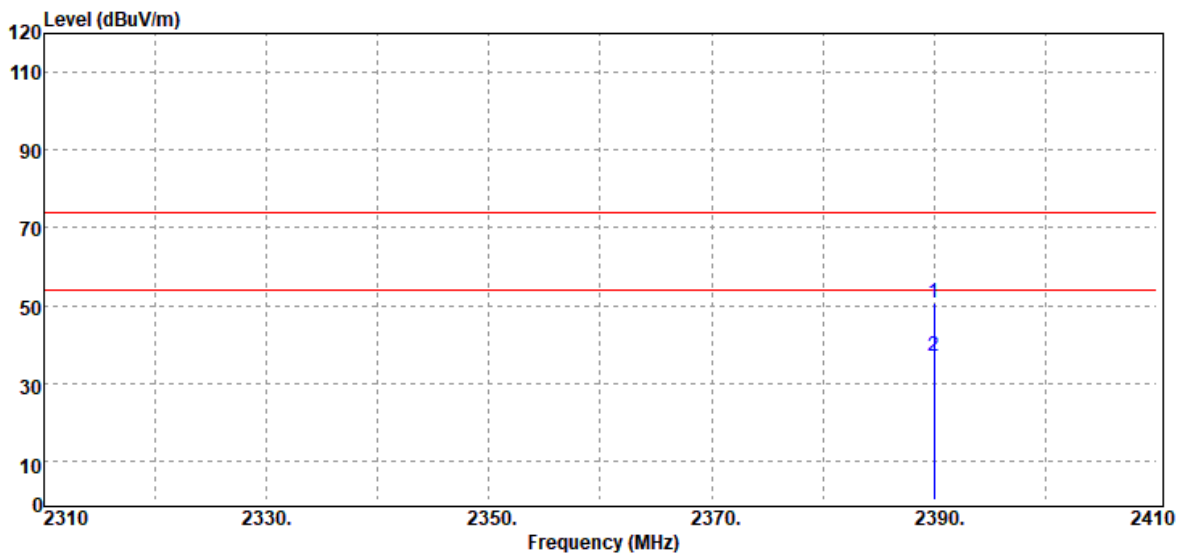

Freq. MHz	Detector Mode PK/QP/AV	Spectrum Reading Level dB μ V	Factor dB	Actual FS dB μ V/m	Limit @3m dB μ V/m	Margin dB
2390.00	Peak	53.93	-3.17	50.76	74.00	-23.24
2390.00	Average	40.01	-3.17	36.84	54.00	-17.16

Report No.: T200824W11-RP

Test Mode:	BLE-2Mbps High CH	Temp/Hum	25.0(°C)/ 43%RH
Test Item	Band Edge	Test Date	September 8, 2020
Polarize	Vertical	Test Engineer	Jerry Chang
Detector	Peak / Average		

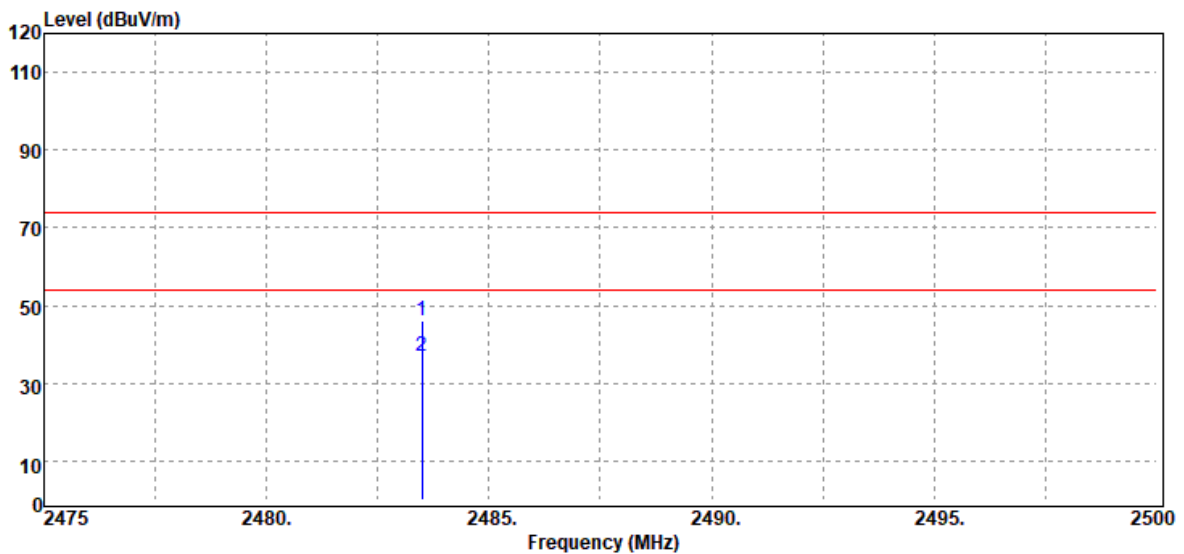

Freq. MHz	Detector Mode PK/QP/AV	Spectrum Reading Level dB μ V	Factor dB	Actual FS dB μ V/m	Limit @3m dB μ V/m	Margin dB
2483.50	Peak	48.90	-2.71	46.19	74.00	-27.81
2483.50	Average	39.54	-2.71	36.83	54.00	-17.17

Report No.: T200824W11-RP

Test Mode:	BLE-2Mbps High CH	Temp/Hum	25.0(°C)/ 43%RH
Test Item	Band Edge	Test Date	September 8, 2020
Polarize	Horizontal	Test Engineer	Jerry Chang
Detector	Peak / Average		

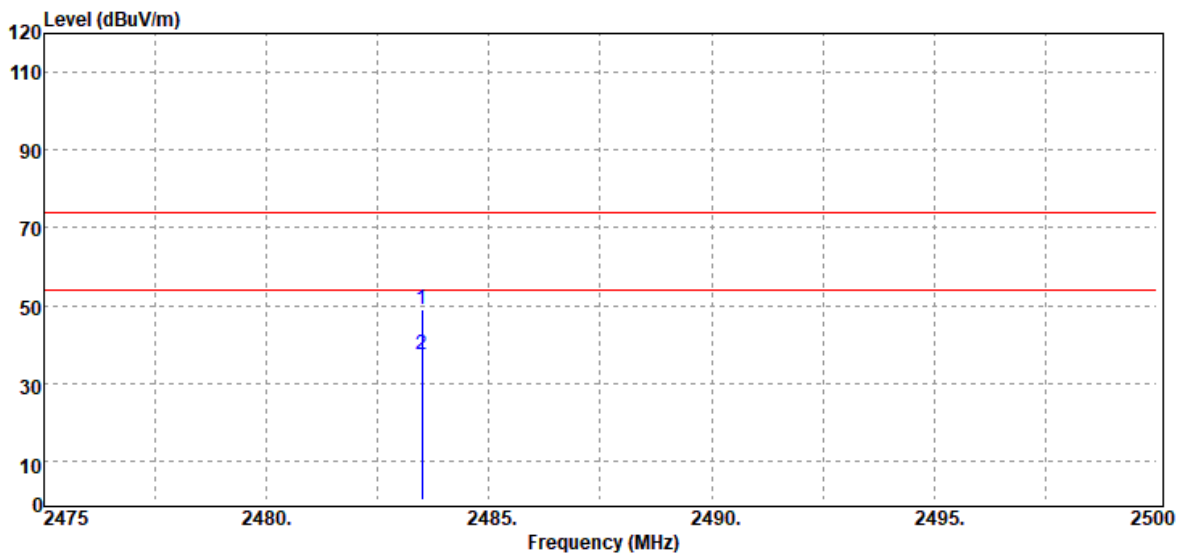

Freq. MHz	Detector Mode PK/QP/AV	Spectrum Reading Level dB μ V	Factor dB	Actual FS dB μ V/m	Limit @3m dB μ V/m	Margin dB
2483.50	Peak	51.88	-2.71	49.17	74.00	-24.83
2483.50	Average	39.93	-2.71	37.22	54.00	-16.78

Report No.: T200824W11-RP

Band Edge Test Data

Model: MDBT42TV-P

Test Mode:	BLE-1Mbps Low CH	Temp/Hum	25.0(°C)/ 43%RH
Test Item	Band Edge	Test Date	September 8, 2020
Polarize	Vertical	Test Engineer	Jerry Chang
Detector	Peak / Average		

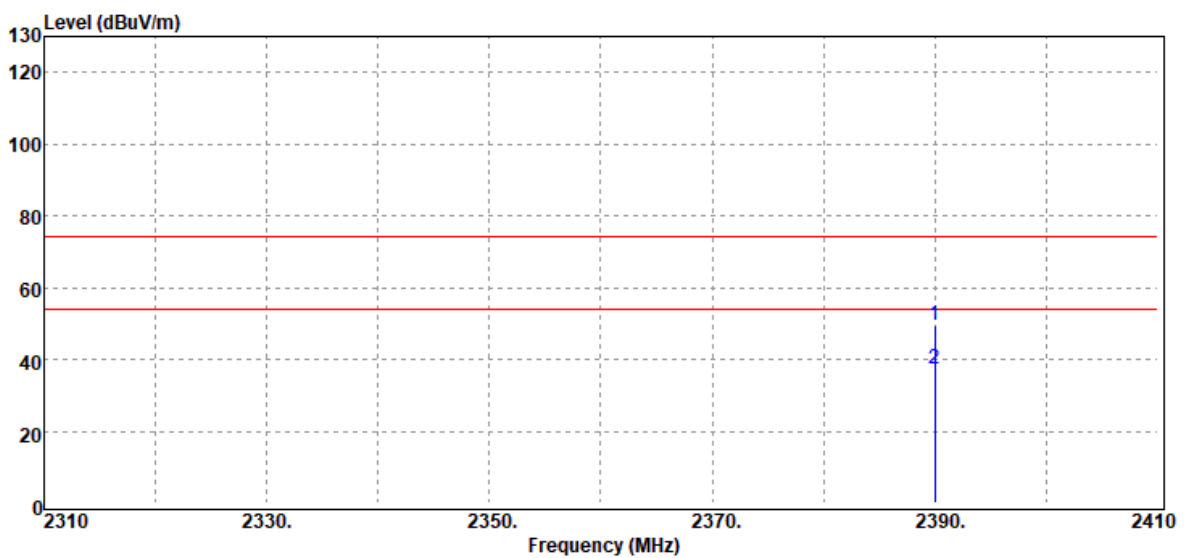

Freq. MHz	Detector Mode PK/QP/AV	Spectrum Reading Level dB μ V	Factor dB	Actual FS dB μ V/m	Limit @3m dB μ V/m	Margin dB
2390.00	Peak	52.47	-3.17	49.30	74.00	-24.70
2390.00	Average	40.34	-3.17	37.17	54.00	-16.83

Report No.: T200824W11-RP

Test Mode:	BLE-1Mbps Low CH	Temp/Hum	25.0(°C)/ 43%RH
Test Item	Band Edge	Test Date	September 8, 2020
Polarize	Horizontal	Test Engineer	Jerry Chang
Detector	Peak / Average		

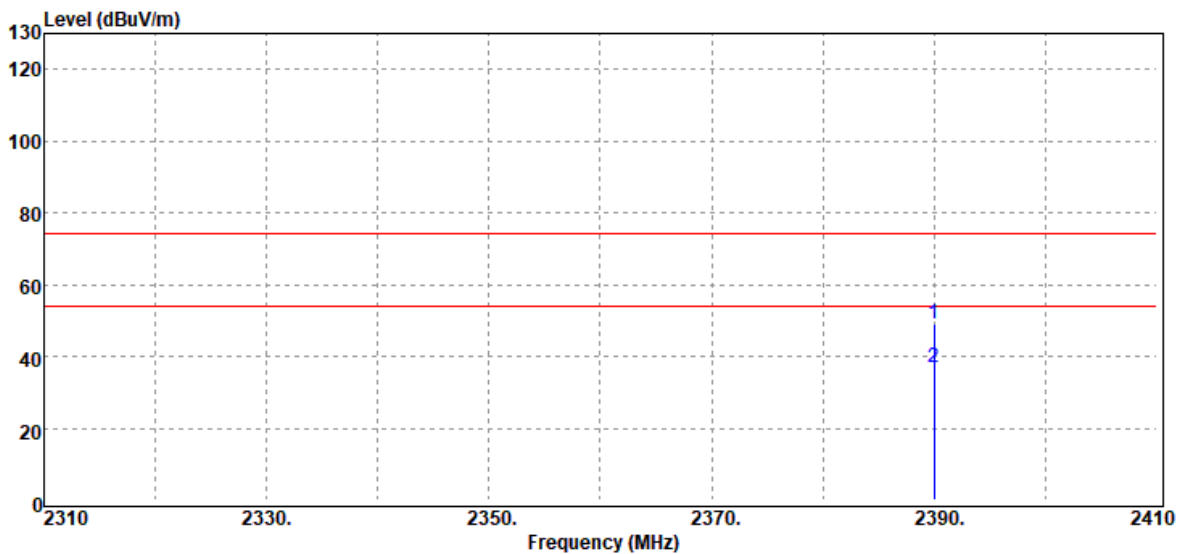

Freq. MHz	Detector Mode PK/QP/AV	Spectrum Reading Level dB μ V	Factor dB	Actual FS dB μ V/m	Limit @3m dB μ V/m	Margin dB
2390.00	Peak	52.08	-3.17	48.91	74.00	-25.09
2390.00	Average	40.22	-3.17	37.05	54.00	-16.95

Report No.: T200824W11-RP

Test Mode:	BLE-1Mbps High CH	Temp/Hum	25.0(°C)/ 43%RH
Test Item	Band Edge	Test Date	September 8, 2020
Polarize	Vertical	Test Engineer	Jerry Chang
Detector	Peak / Average		

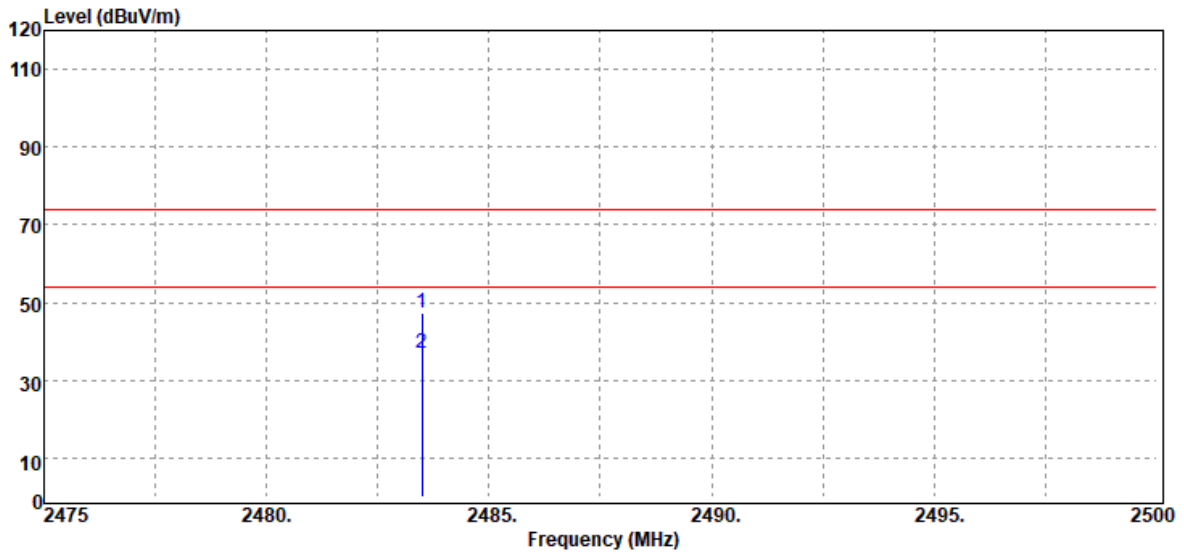

Freq. MHz	Detector Mode PK/QP/AV	Spectrum Reading Level dB μ V	Factor dB	Actual FS dB μ V/m	Limit @3m dB μ V/m	Margin dB
2483.50	Peak	50.12	-2.71	47.41	74.00	-26.59
2483.50	Average	39.61	-2.71	36.90	54.00	-17.10

Report No.: T200824W11-RP

Test Mode:	BLE-1Mbps High CH	Temp/Hum	25.0(°C)/ 43%RH
Test Item	Band Edge	Test Date	September 8, 2020
Polarize	Horizontal	Test Engineer	Jerry Chang
Detector	Peak / Average		

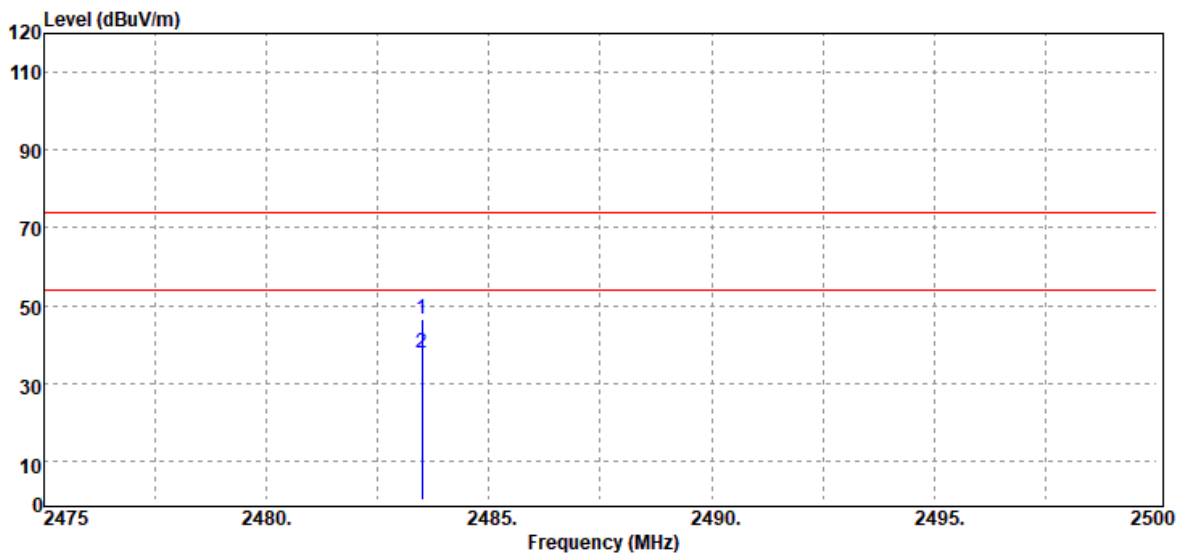

Freq. MHz	Detector Mode PK/QP/AV	Spectrum Reading Level dB μ V	Factor dB	Actual FS dB μ V/m	Limit @3m dB μ V/m	Margin dB
2483.50	Peak	49.12	-2.71	46.41	74.00	-27.59
2483.50	Average	40.36	-2.71	37.65	54.00	-16.35

Report No.: T200824W11-RP

Test Mode:	BLE-2Mbps Low CH	Temp/Hum	25.0(°C)/ 43%RH
Test Item	Band Edge	Test Date	September 8, 2020
Polarize	Vertical	Test Engineer	Jerry Chang
Detector	Peak / Average		

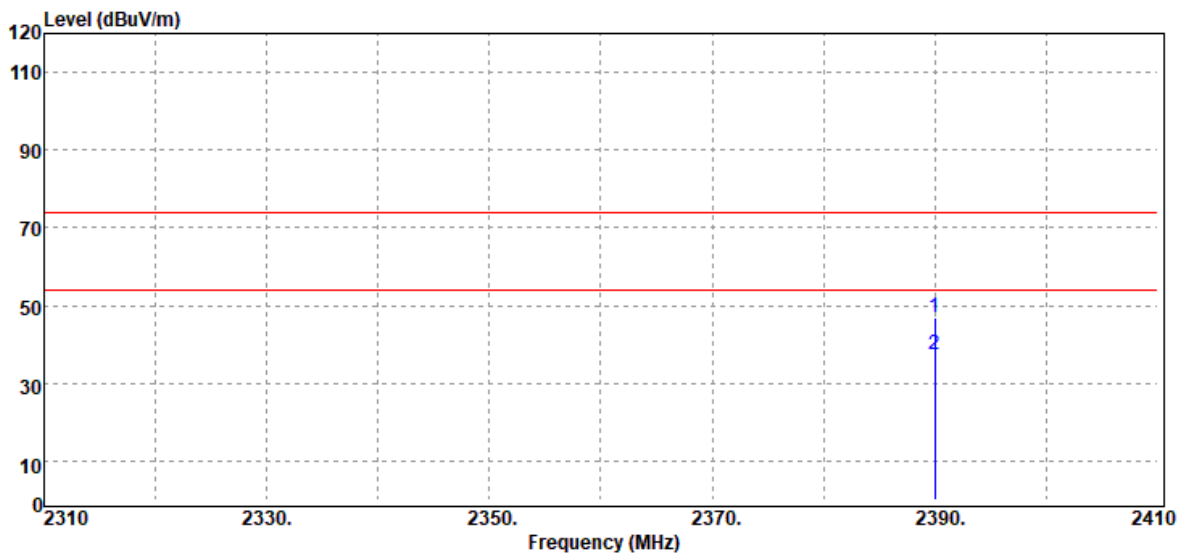

Freq. MHz	Detector Mode PK/QP/AV	Spectrum Reading Level dB μ V	Factor dB	Actual FS dB μ V/m	Limit @3m dB μ V/m	Margin dB
2390.00	Peak	50.24	-3.17	47.07	74.00	-26.93
2390.00	Average	40.43	-3.17	37.26	54.00	-16.74

Report No.: T200824W11-RP

Test Mode:	BLE-2Mbps Low CH	Temp/Hum	25.0(°C)/ 43%RH
Test Item	Band Edge	Test Date	September 8, 2020
Polarize	Horizontal	Test Engineer	Jerry Chang
Detector	Peak / Average		

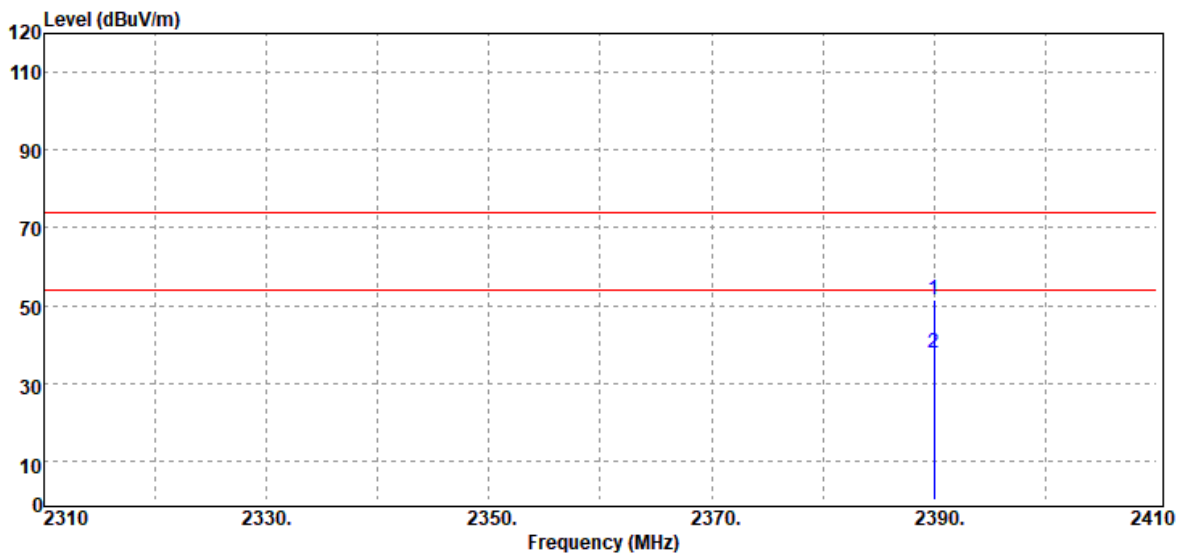

Freq. MHz	Detector Mode PK/QP/AV	Spectrum Reading Level dB μ V	Factor dB	Actual FS dB μ V/m	Limit @3m dB μ V/m	Margin dB
2390.00	Peak	54.58	-3.17	51.41	74.00	-22.59
2390.00	Average	41.03	-3.17	37.86	54.00	-16.14

Report No.: T200824W11-RP

Test Mode:	BLE-2Mbps High CH	Temp/Hum	25.0(°C)/ 43%RH
Test Item	Band Edge	Test Date	September 8, 2020
Polarize	Vertical	Test Engineer	Jerry Chang
Detector	Peak / Average		

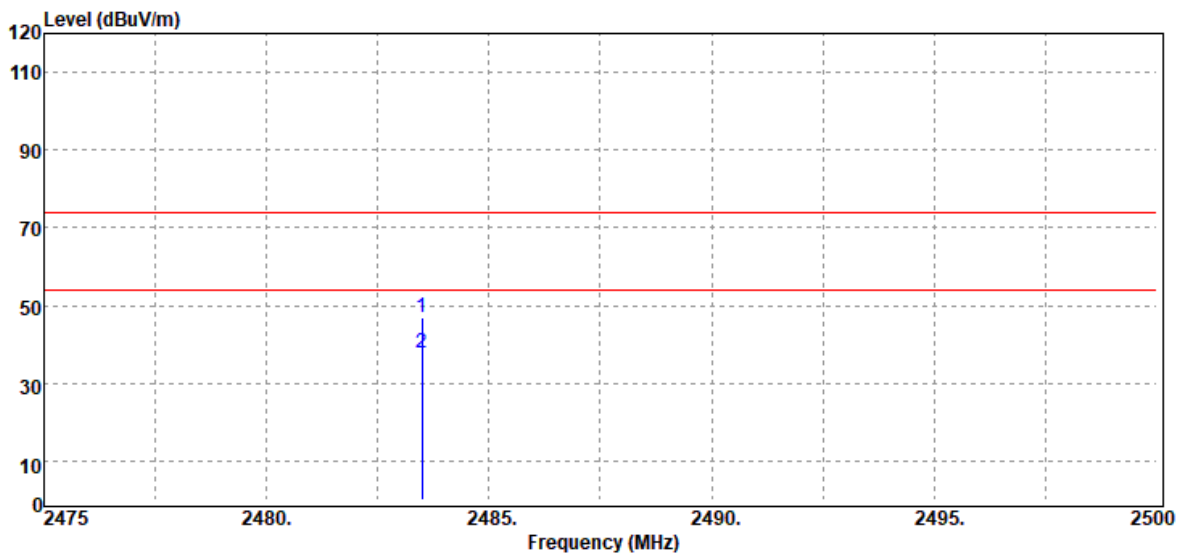

Freq. MHz	Detector Mode PK/QP/AV	Spectrum Reading Level dB μ V	Factor dB	Actual FS dB μ V/m	Limit @3m dB μ V/m	Margin dB
2483.50	Peak	49.47	-2.71	46.76	74.00	-27.24
2483.50	Average	40.33	-2.71	37.62	54.00	-16.38

Report No.: T200824W11-RP

Test Mode:	BLE-2Mbps High CH	Temp/Hum	25.0(°C)/ 43%RH
Test Item	Band Edge	Test Date	September 8, 2020
Polarize	Horizontal	Test Engineer	Jerry Chang
Detector	Peak / Average		

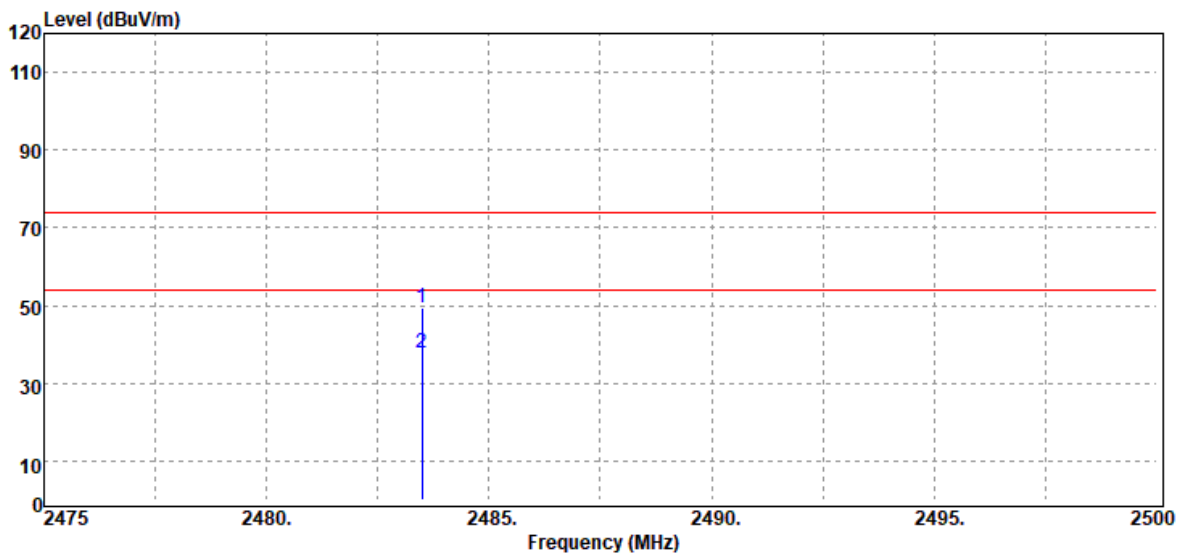

Freq. MHz	Detector Mode PK/QP/AV	Spectrum Reading Level dB μ V	Factor dB	Actual FS dB μ V/m	Limit @3m dB μ V/m	Margin dB
2483.50	Peak	52.30	-2.71	49.59	74.00	-24.41
2483.50	Average	40.35	-2.71	37.64	54.00	-16.36

Report No.: T200824W11-RP

Below 1G Test Data

Model: MDBT42TV

Test Mode:	BLE-1Mbps Mode	Temp/Hum	25.0(°C)/ 43%RH
Test Item	30MHz-1GHz	Test Date	September 8, 2020
Polarize	Vertical	Test Engineer	Jerry Chang
Detector	Peak		

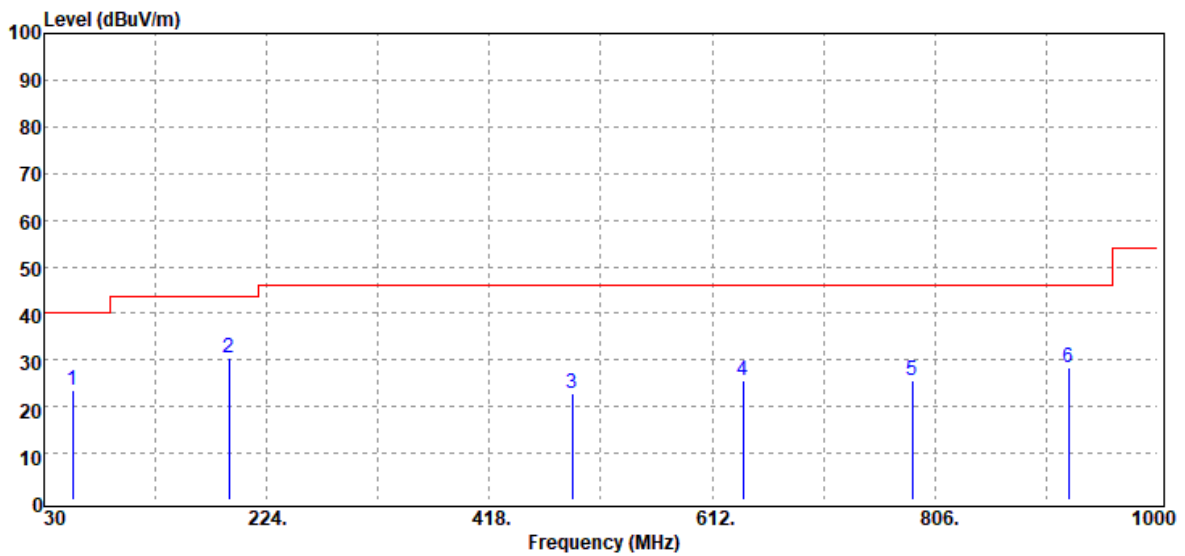

Freq. MHz	Detector Mode PK/QP/AV	Spectrum Reading Level dBμV	Factor dB	Actual FS dBμV/m	Limit @3m dBμV/m	Margin dB
55.22	Peak	39.64	-16.20	23.44	40.00	-16.56
191.02	Peak	41.48	-10.90	30.58	43.50	-12.92
489.78	Peak	26.10	-3.34	22.76	46.00	-23.24
639.16	Peak	26.18	-0.54	25.64	46.00	-20.36
786.60	Peak	24.07	1.41	25.48	46.00	-20.52
922.40	Peak	25.04	3.29	28.33	46.00	-17.67

Note: No emission found between lowest internal used/generated frequency to 30MHz (9kHz~30MHz).

Report No.: T200824W11-RP

Test Mode:	BLE-1Mbps Mode	Temp/Hum	25.0(°C)/ 43%RH
Test Item	30MHz-1GHz	Test Date	September 8, 2020
Polarize	Horizontal	Test Engineer	Jerry Chang
Detector	Peak		

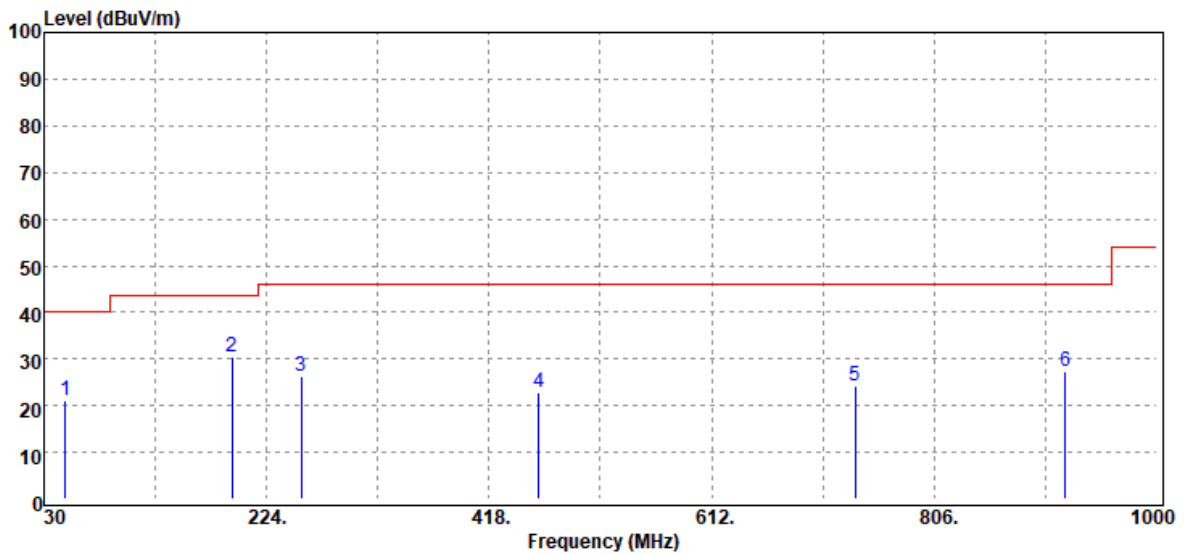

Freq. MHz	Detector Mode PK/QP/AV	Spectrum Reading Level dB μ V	Factor dB	Actual FS dB μ V/m	Limit @3m dB μ V/m	Margin dB
48.43	Peak	35.87	-14.81	21.06	40.00	-18.94
193.93	Peak	40.84	-10.41	30.43	43.50	-13.07
254.07	Peak	37.04	-10.72	26.32	46.00	-19.68
461.65	Peak	26.87	-4.06	22.81	46.00	-23.19
737.13	Peak	23.75	0.53	24.28	46.00	-21.72
920.46	Peak	24.26	3.23	27.49	46.00	-18.51

Note: No emission found between lowest internal used/generated frequency to 30MHz (9kHz~30MHz).

Report No.: T200824W11-RP

Test Mode:	BLE-2Mbps Mode	Temp/Hum	25.0(°C)/ 43%RH
Test Item	30MHz-1GHz	Test Date	September 8, 2020
Polarize	Vertical	Test Engineer	Jerry Chang
Detector	Peak		

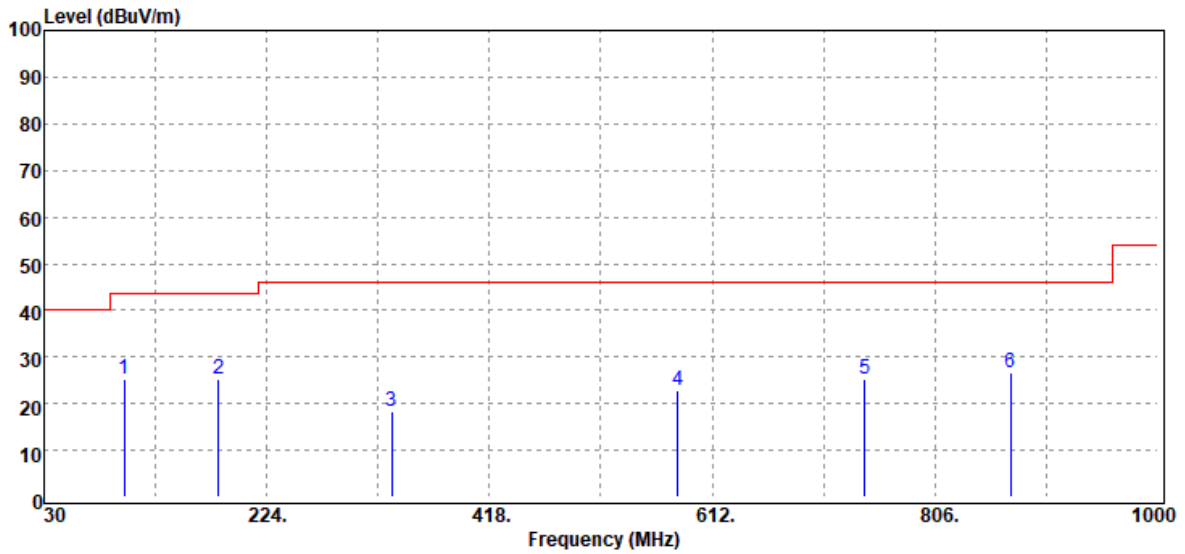

Freq. MHz	Detector Mode PK/QP/AV	Spectrum Reading Level dBμV	Factor dB	Actual FS dBμV/m	Limit @3m dBμV/m	Margin dB
99.84	Peak	38.21	-12.91	25.30	43.50	-18.20
182.29	Peak	36.81	-11.48	25.33	43.50	-18.17
332.64	Peak	26.00	-7.80	18.20	46.00	-27.80
581.93	Peak	25.02	-2.11	22.91	46.00	-23.09
744.89	Peak	24.41	0.78	25.19	46.00	-20.81
871.96	Peak	24.14	2.57	26.71	46.00	-19.29

Note: No emission found between lowest internal used/generated frequency to 30MHz (9kHz~30MHz).

Report No.: T200824W11-RP

Test Mode:	BLE-2Mbps Mode	Temp/Hum	25.0(°C)/ 43%RH
Test Item	30MHz-1GHz	Test Date	September 8, 2020
Polarize	Horizontal	Test Engineer	Jerry Chang
Detector	Peak		

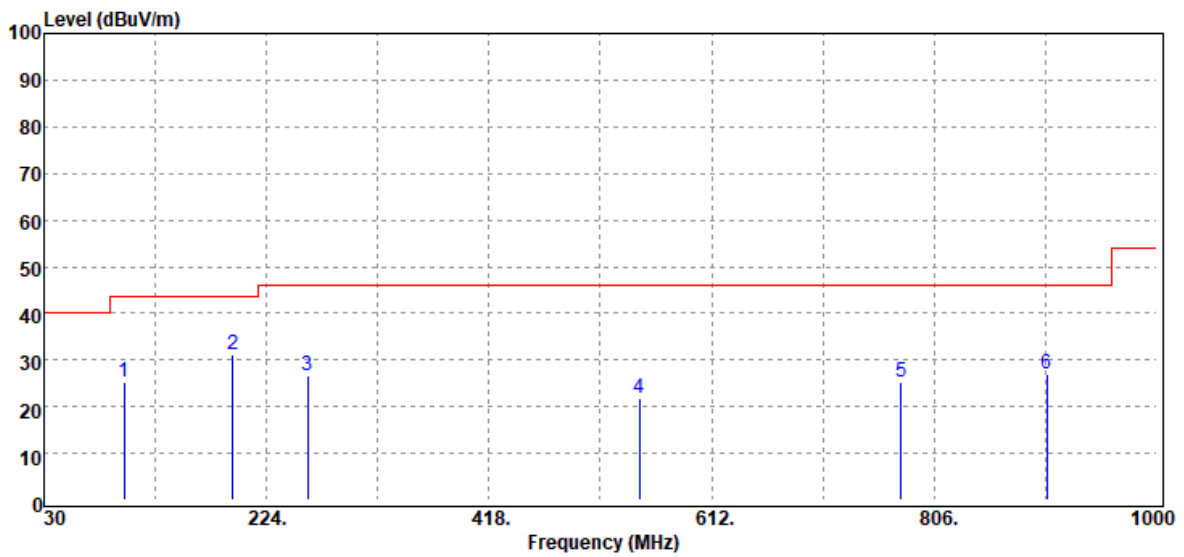

Freq. MHz	Detector Mode PK/QP/AV	Spectrum Reading Level dB μ V	Factor dB	Actual FS dB μ V/m	Limit @3m dB μ V/m	Margin dB
99.84	Peak	38.07	-12.91	25.16	43.50	-18.34
194.90	Peak	41.18	-10.21	30.97	43.50	-12.53
259.89	Peak	36.75	-10.13	26.62	46.00	-19.38
548.95	Peak	24.14	-2.44	21.70	46.00	-24.30
776.90	Peak	23.82	1.35	25.17	46.00	-20.83
903.97	Peak	23.97	3.16	27.13	46.00	-18.87

Note: No emission found between lowest internal used/generated frequency to 30MHz (9kHz~30MHz).

Report No.: T200824W11-RP

Below 1G Test Data

Model: MDBT42TV-P

Test Mode:	BLE-1Mbps Mode	Temp/Hum	25.0(°C)/ 43%RH
Test Item	30MHz-1GHz	Test Date	September 8, 2020
Polarize	Vertical	Test Engineer	Jerry Chang
Detector	Peak		

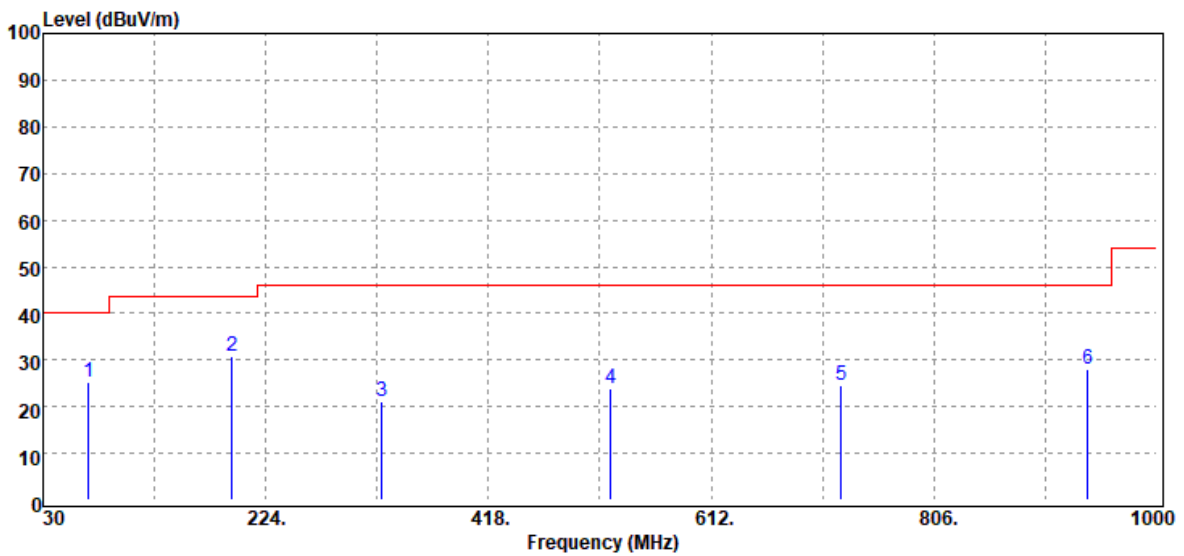

Freq. MHz	Detector Mode PK/QP/AV	Spectrum Reading Level dBμV	Factor dB	Actual FS dBμV/m	Limit @3m dBμV/m	Margin dB
69.77	Peak	40.43	-15.13	25.30	40.00	-14.70
194.90	Peak	41.05	-10.21	30.84	43.50	-12.66
324.88	Peak	29.08	-7.87	21.21	46.00	-24.79
524.70	Peak	26.75	-3.04	23.71	46.00	-22.29
725.49	Peak	24.24	0.42	24.66	46.00	-21.34
939.86	Peak	24.55	3.50	28.05	46.00	-17.95

Note: No emission found between lowest internal used/generated frequency to 30MHz (9kHz~30MHz).

Report No.: T200824W11-RP

Test Mode:	BLE-1Mbps Mode	Temp/Hum	25.0(°C)/ 43%RH
Test Item	30MHz-1GHz	Test Date	September 8, 2020
Polarize	Horizontal	Test Engineer	Jerry Chang
Detector	Peak		

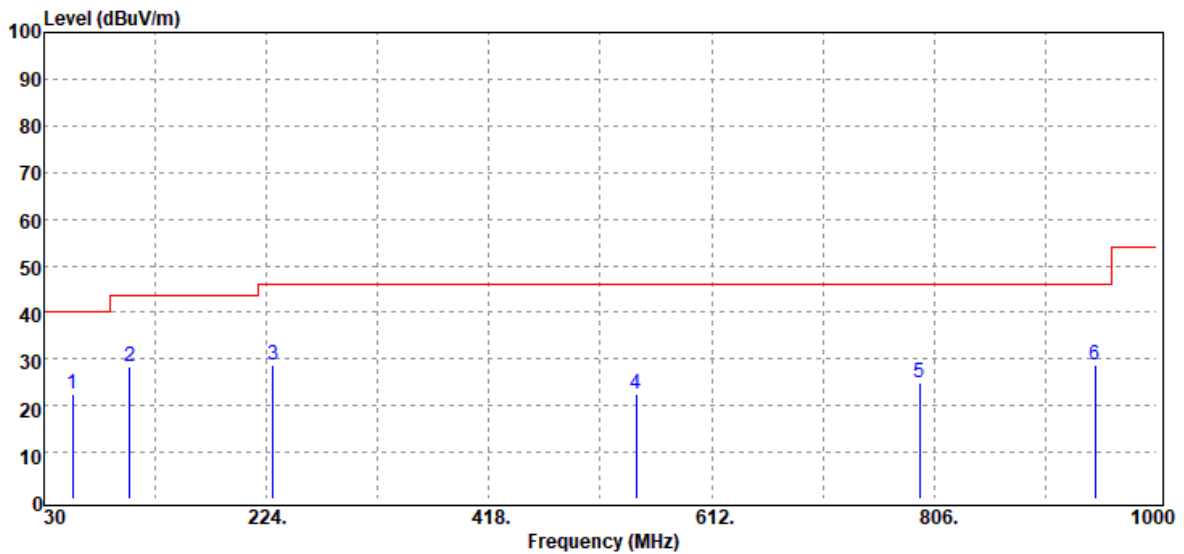

Freq. MHz	Detector Mode PK/QP/AV	Spectrum Reading Level dB μ V	Factor dB	Actual FS dB μ V/m	Limit @3m dB μ V/m	Margin dB
55.22	Peak	38.57	-16.20	22.37	40.00	-17.63
104.69	Peak	39.71	-11.41	28.30	43.50	-15.20
229.82	Peak	40.14	-11.25	28.89	46.00	-17.11
546.04	Peak	24.97	-2.41	22.56	46.00	-23.44
793.39	Peak	23.41	1.45	24.86	46.00	-21.14
946.65	Peak	24.51	4.13	28.64	46.00	-17.36

Note: No emission found between lowest internal used/generated frequency to 30MHz (9kHz~30MHz).

Test Mode:	BLE-2Mbps Mode	Temp/Hum	25.0(°C)/ 43%RH
Test Item	30MHz-1GHz	Test Date	September 8, 2020
Polarize	Vertical	Test Engineer	Jerry Chang
Detector	Peak		

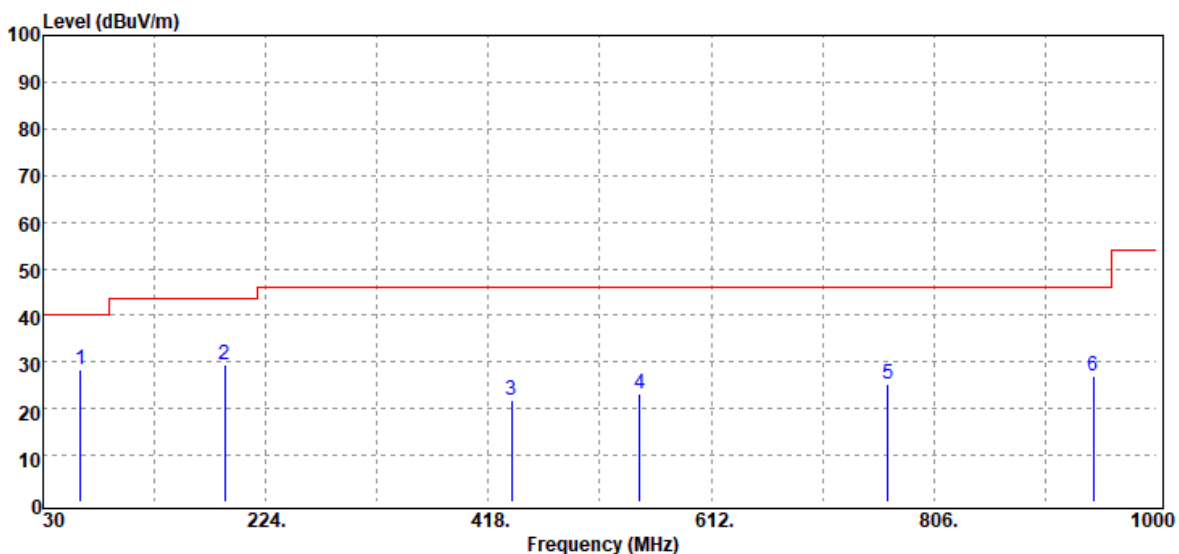

Freq. MHz	Detector Mode PK/QP/AV	Spectrum Reading Level dB μ V	Factor dB	Actual FS dB μ V/m	Limit @3m dB μ V/m	Margin dB
62.98	Peak	44.20	-15.77	28.43	40.00	-11.57
188.11	Peak	40.50	-11.24	29.26	43.50	-14.24
438.37	Peak	26.51	-4.56	21.95	46.00	-24.05
549.92	Peak	25.62	-2.46	23.16	46.00	-22.84
766.23	Peak	24.14	1.08	25.22	46.00	-20.78
944.71	Peak	23.01	3.94	26.95	46.00	-19.05

Note: No emission found between lowest internal used/generated frequency to 30MHz (9kHz~30MHz).

Test Mode:	BLE-2Mbps Mode	Temp/Hum	25.0(°C)/ 43%RH
Test Item	30MHz-1GHz	Test Date	September 8, 2020
Polarize	Horizontal	Test Engineer	Jerry Chang
Detector	Peak		

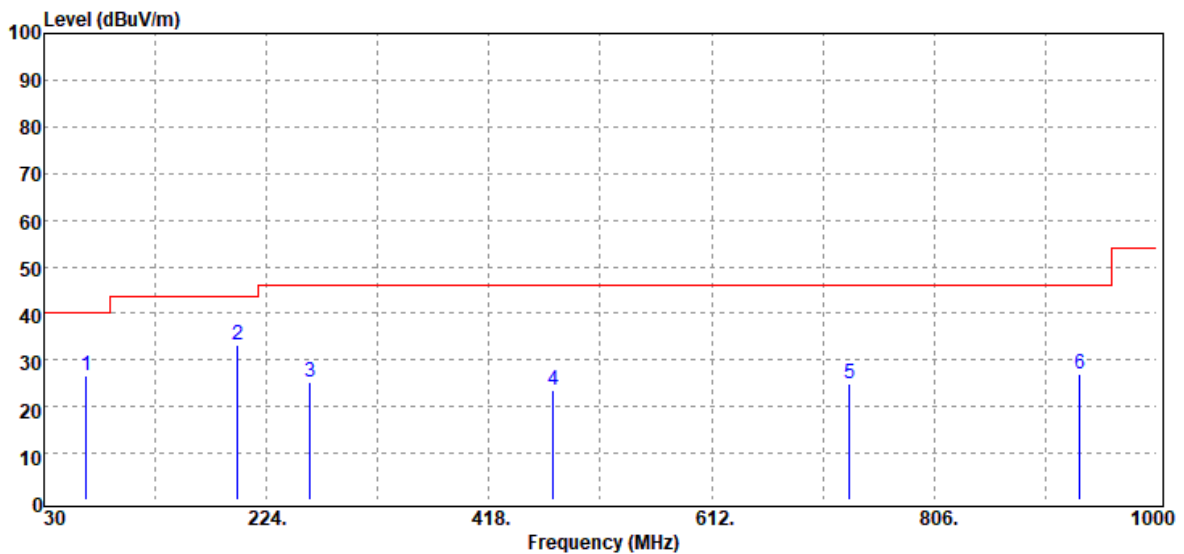

Freq. MHz	Detector Mode PK/QP/AV	Spectrum Reading Level dBμV	Factor dB	Actual FS dBμV/m	Limit @3m dBμV/m	Margin dB
66.86	Peak	42.02	-15.43	26.59	40.00	-13.41
198.78	Peak	42.69	-9.44	33.25	43.50	-10.25
261.83	Peak	35.17	-9.85	25.32	46.00	-20.68
474.26	Peak	27.15	-3.51	23.64	46.00	-22.36
732.28	Peak	24.31	0.44	24.75	46.00	-21.25
933.07	Peak	23.29	3.60	26.89	46.00	-19.11

Note: No emission found between lowest internal used/generated frequency to 30MHz (9kHz~30MHz).

Report No.: T200824W11-RP

Above 1G Test Data

Model: MDBT42TV

Test Mode:	BLE-1Mbps Low CH	Temp/Hum	25.0(°C)/ 43%RH
Test Item	Harmonic	Test Date	September 8, 2020
Polarize	Vertical	Test Engineer	Jerry Chang
Detector	Peak		

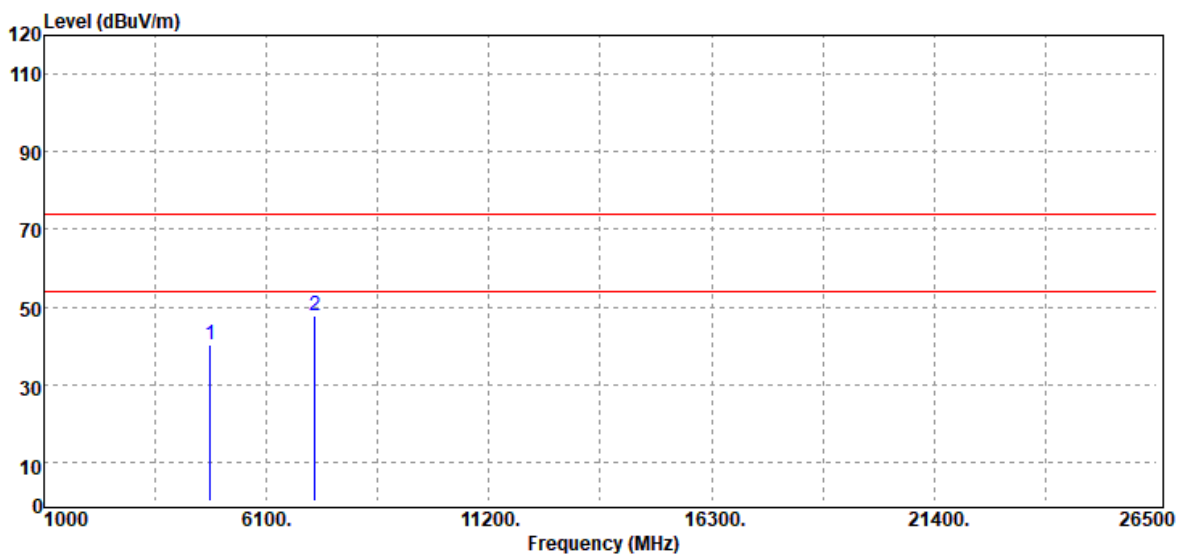

Freq. MHz	Detector Mode PK/QP/AV	Spectrum Reading Level dB μ V	Factor dB	Actual FS dB μ V/m	Limit @3m dB μ V/m	Margin dB
4804.00	Peak	37.07	3.36	40.43	74.00	-33.57
7206.00	Peak	36.91	10.77	47.68	74.00	-26.32
N/A						

Remark:

1. Measuring frequencies from 1 GHz to the 10th harmonic of highest fundamental frequency.
2. For above 1GHz, the EUT peak value was under average limit, therefore the Average value compliance with the average limit

Test Mode:	BLE-1Mbps Low CH	Temp/Hum	25.0(°C)/ 43%RH
Test Item	Harmonic	Test Date	September 8, 2020
Polarize	Horizontal	Test Engineer	Jerry Chang
Detector	Peak		

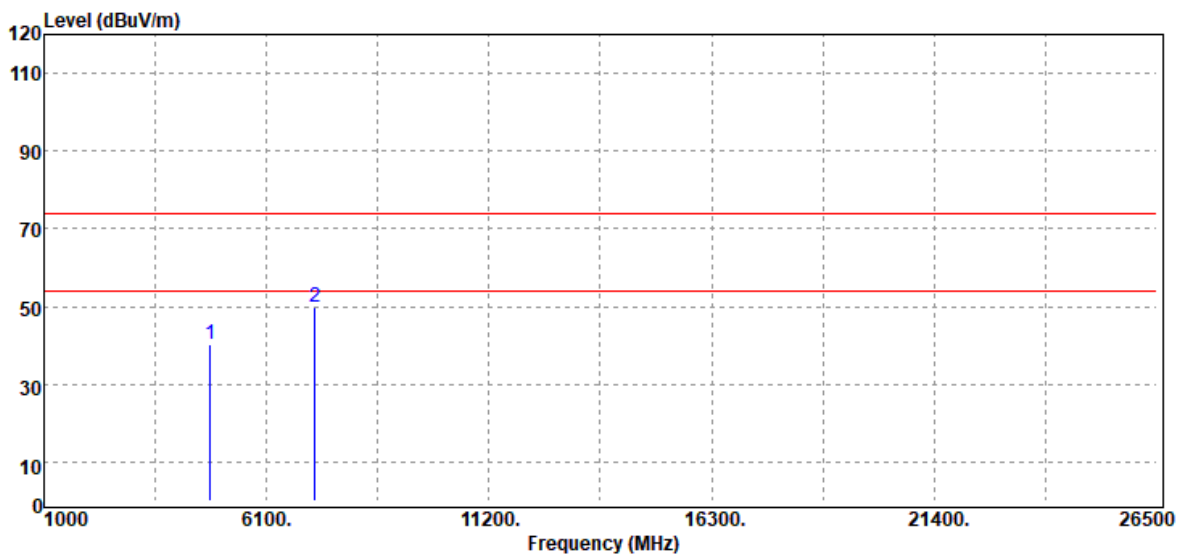

Freq. MHz	Detector Mode PK/QP/AV	Spectrum Reading Level dB μ V	Factor dB	Actual FS dB μ V/m	Limit @3m dB μ V/m	Margin dB
4804.00	Peak	37.02	3.36	40.38	74.00	-33.62
7206.00	Peak	39.13	10.77	49.90	74.00	-24.10
N/A						

Remark:

1. Measuring frequencies from 1 GHz to the 10th harmonic of highest fundamental frequency.
2. For above 1GHz, the EUT peak value was under average limit, therefore the Average value compliance with the average limit

Report No.: T200824W11-RP

Test Mode:	BLE-1Mbps Mid CH	Temp/Hum	25.0(°C)/ 43%RH
Test Item	Harmonic	Test Date	September 8, 2020
Polarize	Vertical	Test Engineer	Jerry Chang
Detector	Peak		

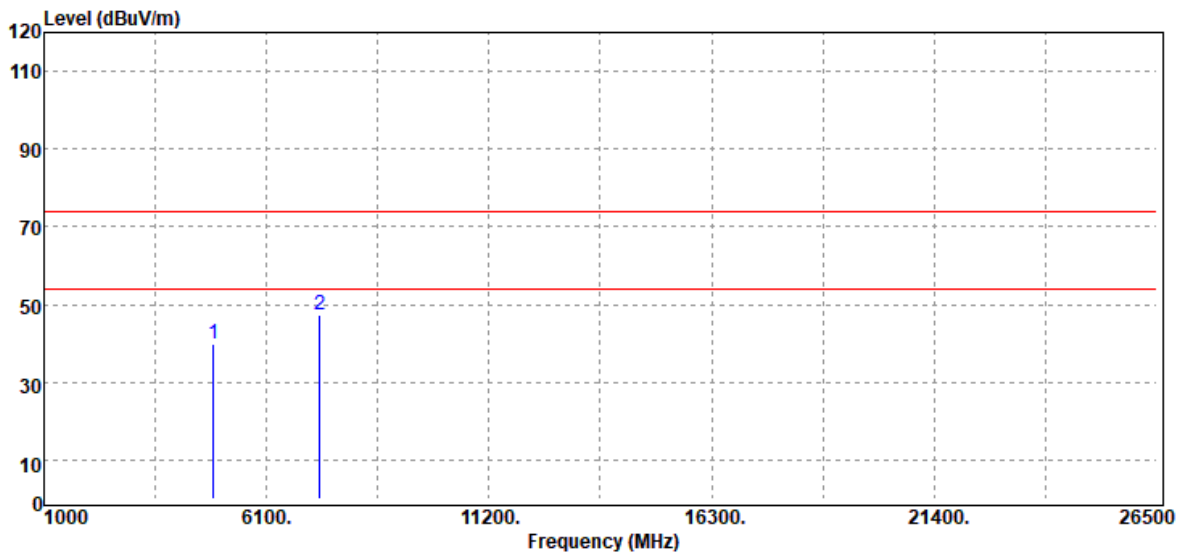

Freq. MHz	Detector Mode PK/QP/AV	Spectrum Reading Level dB μ V	Factor dB	Actual FS dB μ V/m	Limit @3m dB μ V/m	Margin dB
4884.00	Peak	36.50	3.53	40.03	74.00	-33.97
7326.00	Peak	36.18	11.00	47.18	74.00	-26.82
N/A						

Remark:

1. Measuring frequencies from 1 GHz to the 10th harmonic of highest fundamental frequency.
2. For above 1GHz, the EUT peak value was under average limit, therefore the Average value compliance with the average limit

Report No.: T200824W11-RP

Test Mode:	BLE-1Mbps Mid CH	Temp/Hum	25.0(°C)/ 43%RH
Test Item	Harmonic	Test Date	September 8, 2020
Polarize	Horizontal	Test Engineer	Jerry Chang
Detector	Peak		

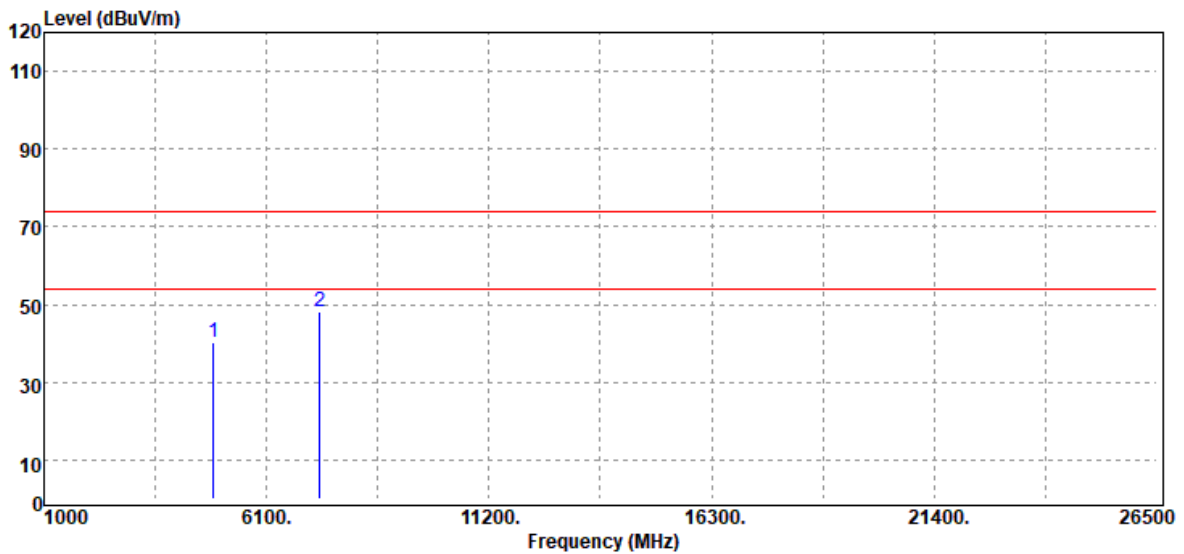

Freq. MHz	Detector Mode PK/QP/AV	Spectrum Reading Level dB μ V	Factor dB	Actual FS dB μ V/m	Limit @3m dB μ V/m	Margin dB
4884.00	Peak	36.67	3.53	40.20	74.00	-33.80
7326.00	Peak	37.33	11.00	48.33	74.00	-25.67
N/A						

Remark:

1. Measuring frequencies from 1 GHz to the 10th harmonic of highest fundamental frequency.
2. For above 1GHz, the EUT peak value was under average limit, therefore the Average value compliance with the average limit

Report No.: T200824W11-RP

Test Mode:	BLE-1Mbps High CH	Temp/Hum	25.0(°C)/ 43%RH
Test Item	Harmonic	Test Date	September 8, 2020
Polarize	Vertical	Test Engineer	Jerry Chang
Detector	Peak		

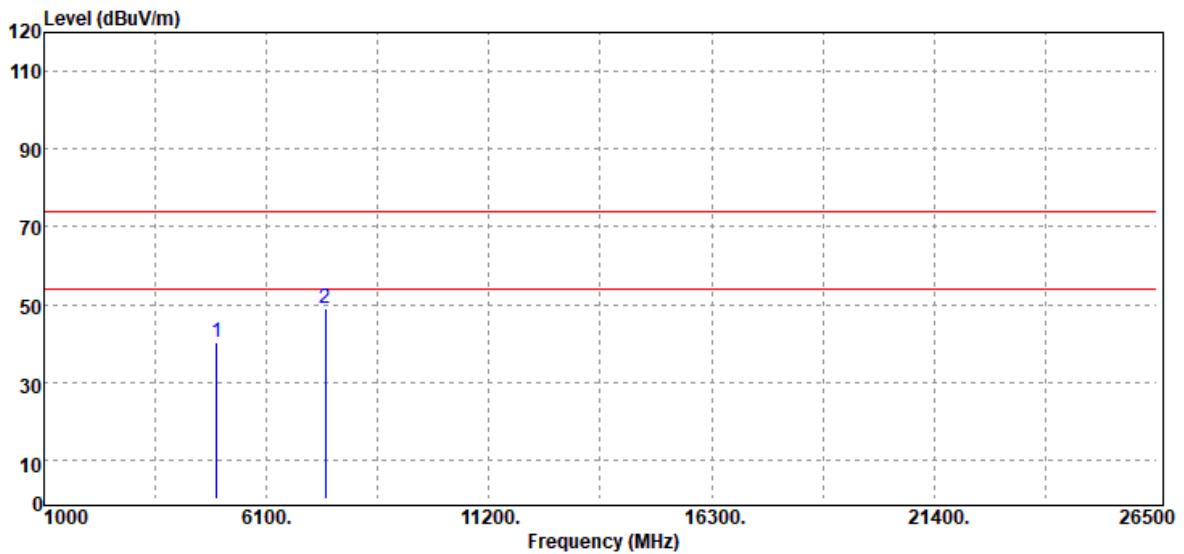

Freq. MHz	Detector Mode PK/QP/AV	Spectrum Reading Level dB μ V	Factor dB	Actual FS dB μ V/m	Limit @3m dB μ V/m	Margin dB
4960.00	Peak	35.83	4.46	40.29	74.00	-33.71
7440.00	Peak	38.26	10.66	48.92	74.00	-25.08
N/A						

Remark:

1. Measuring frequencies from 1 GHz to the 10th harmonic of highest fundamental frequency.
2. For above 1GHz, the EUT peak value was under average limit, therefore the Average value compliance with the average limit

Report No.: T200824W11-RP

Test Mode:	BLE-1Mbps High CH	Temp/Hum	25.0(°C)/ 43%RH
Test Item	Harmonic	Test Date	September 8, 2020
Polarize	Horizontal	Test Engineer	Jerry Chang
Detector	Peak		

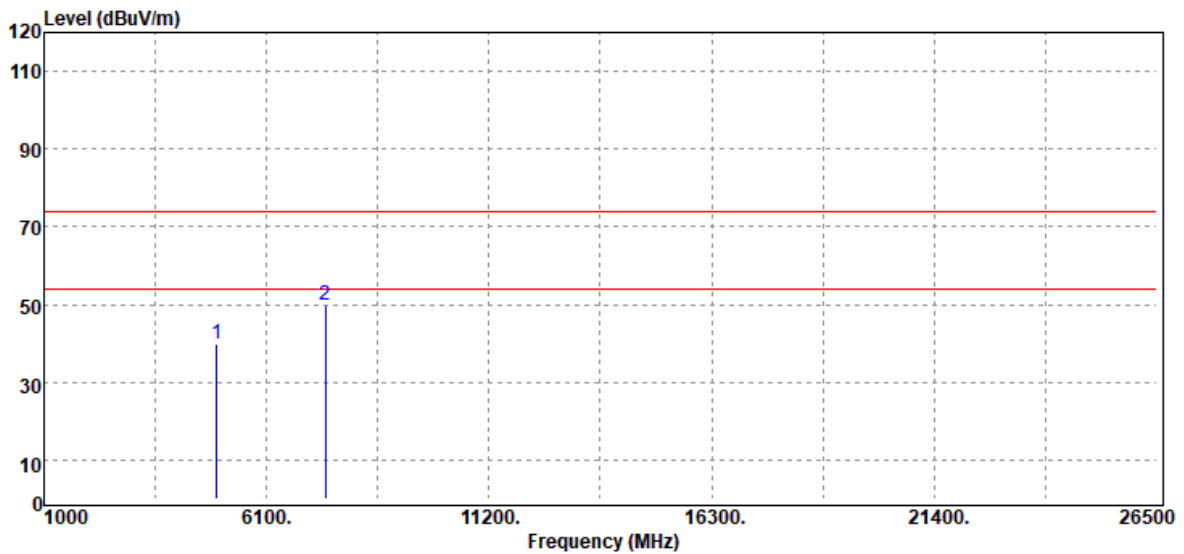

Freq. MHz	Detector Mode PK/QP/AV	Spectrum Reading Level dB μ V	Factor dB	Actual FS dB μ V/m	Limit @3m dB μ V/m	Margin dB
4960.00	Peak	35.38	4.46	39.84	74.00	-34.16
7440.00	Peak	39.10	10.66	49.76	74.00	-24.24
N/A						

Remark:

1. Measuring frequencies from 1 GHz to the 10th harmonic of highest fundamental frequency.
2. For above 1GHz, the EUT peak value was under average limit, therefore the Average value compliance with the average limit

Report No.: T200824W11-RP

Test Mode:	BLE-2Mbps Low CH	Temp/Hum	25.0(°C)/ 43%RH
Test Item	Harmonic	Test Date	September 8, 2020
Polarize	Vertical	Test Engineer	Jerry Chang
Detector	Peak		

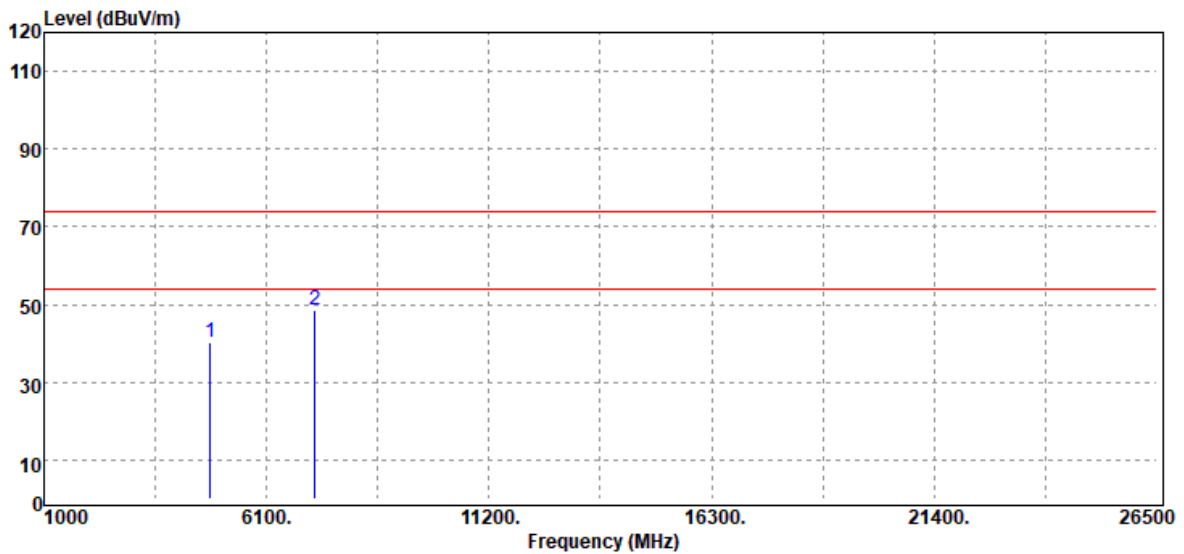

Freq. MHz	Detector Mode PK/QP/AV	Spectrum Reading Level dB μ V	Factor dB	Actual FS dB μ V/m	Limit @3m dB μ V/m	Margin dB
4804.00	Peak	37.04	3.36	40.40	74.00	-33.60
7206.00	Peak	37.62	10.77	48.39	74.00	-25.61
N/A						

Remark:

1. Measuring frequencies from 1 GHz to the 10th harmonic of highest fundamental frequency.
2. For above 1GHz, the EUT peak value was under average limit, therefore the Average value compliance with the average limit

Test Mode:	BLE-2Mbps Low CH	Temp/Hum	25.0(°C)/ 43%RH
Test Item	Harmonic	Test Date	September 8, 2020
Polarize	Horizontal	Test Engineer	Jerry Chang
Detector	Peak		

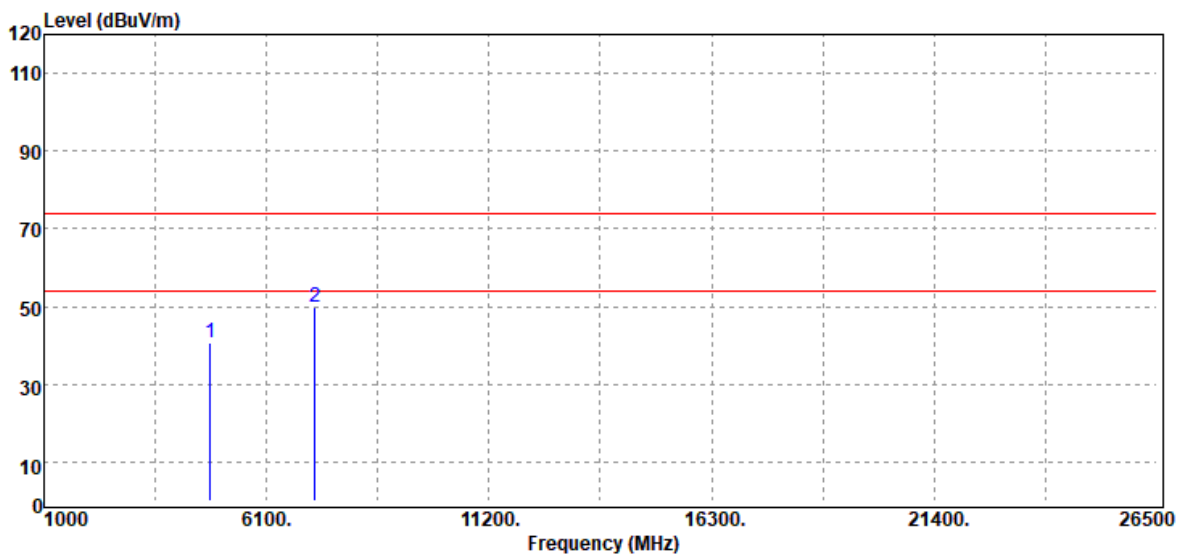

Freq. MHz	Detector Mode PK/QP/AV	Spectrum Reading Level dB μ V	Factor dB	Actual FS dB μ V/m	Limit @3m dB μ V/m	Margin dB
4804.00	Peak	37.28	3.36	40.64	74.00	-33.36
7206.00	Peak	38.97	10.77	49.74	74.00	-24.26
N/A						

Remark:

1. Measuring frequencies from 1 GHz to the 10th harmonic of highest fundamental frequency.
2. For above 1GHz, the EUT peak value was under average limit, therefore the Average value compliance with the average limit

Test Mode:	BLE-2Mbps Mid CH	Temp/Hum	25.0(°C)/ 43%RH
Test Item	Harmonic	Test Date	September 8, 2020
Polarize	Vertical	Test Engineer	Jerry Chang
Detector	Peak		

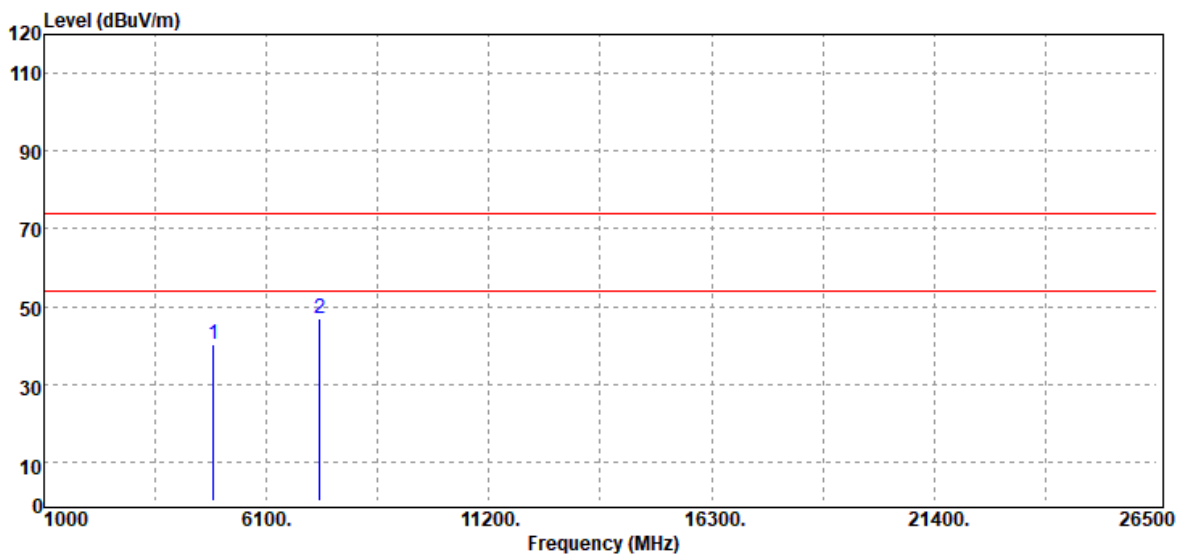

Freq. MHz	Detector Mode PK/QP/AV	Spectrum Reading Level dB μ V	Factor dB	Actual FS dB μ V/m	Limit @3m dB μ V/m	Margin dB
4884.00	Peak	36.55	3.53	40.08	74.00	-33.92
7326.00	Peak	35.87	11.00	46.87	74.00	-27.13
N/A						

Remark:

1. Measuring frequencies from 1 GHz to the 10th harmonic of highest fundamental frequency.
2. For above 1GHz, the EUT peak value was under average limit, therefore the Average value compliance with the average limit

Report No.: T200824W11-RP

Test Mode:	BLE-2Mbps Mid CH	Temp/Hum	25.0(°C)/ 43%RH
Test Item	Harmonic	Test Date	September 8, 2020
Polarize	Horizontal	Test Engineer	Jerry Chang
Detector	Peak		

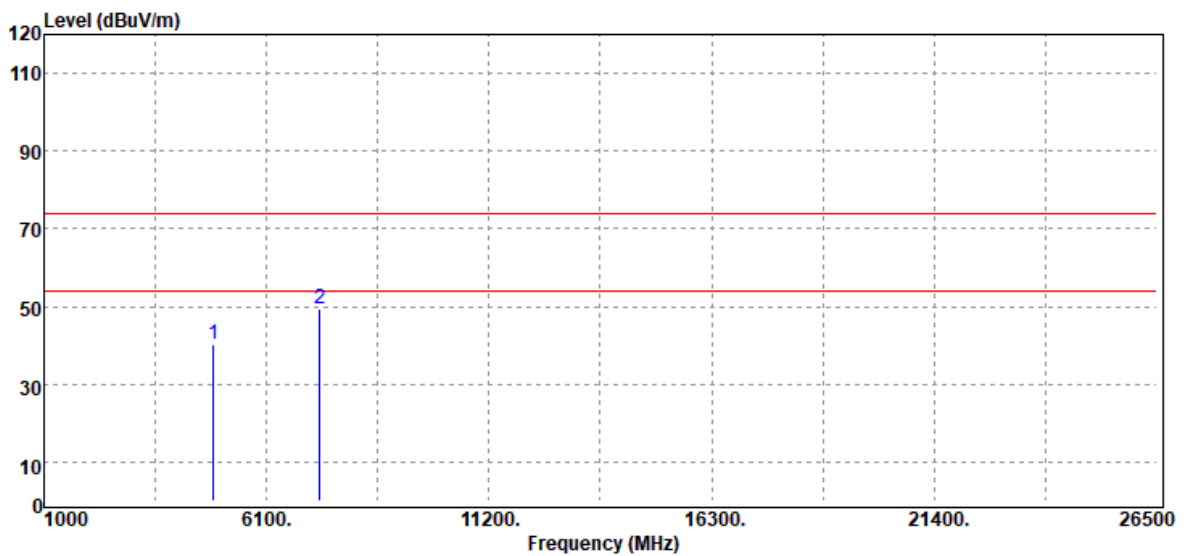

Freq. MHz	Detector Mode PK/QP/AV	Spectrum Reading Level dBUV	Factor dB	Actual FS dBUV/m	Limit @3m dBUV/m	Margin dB
4884.00	Peak	36.89	3.53	40.42	74.00	-33.58
7326.00	Peak	38.45	11.00	49.45	74.00	-24.55
N/A						

Remark:

1. Measuring frequencies from 1 GHz to the 10th harmonic of highest fundamental frequency.
2. For above 1GHz, the EUT peak value was under average limit, therefore the Average value compliance with the average limit

Report No.: T200824W11-RP

Test Mode:	BLE-2Mbps High CH	Temp/Hum	25.0(°C)/ 43%RH
Test Item	Harmonic	Test Date	September 8, 2020
Polarize	Vertical	Test Engineer	Jerry Chang
Detector	Peak		

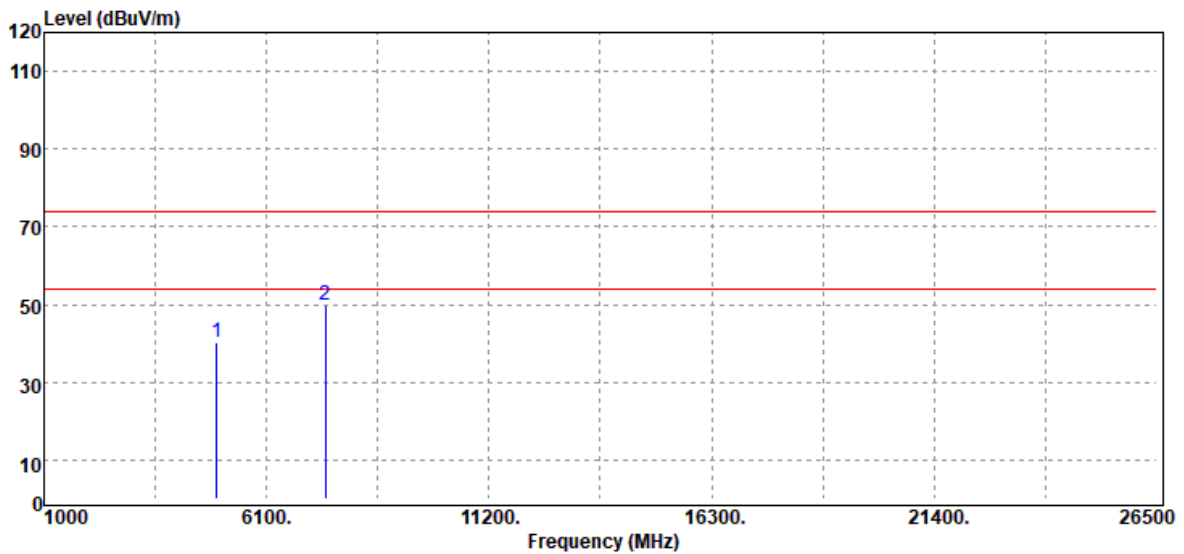

Freq. MHz	Detector Mode PK/QP/AV	Spectrum Reading Level dB μ V	Factor dB	Actual FS dB μ V/m	Limit @3m dB μ V/m	Margin dB
4960.00	Peak	35.80	4.46	40.26	74.00	-33.74
7440.00	Peak	39.28	10.66	49.94	74.00	-24.06
N/A						

Remark:

1. Measuring frequencies from 1 GHz to the 10th harmonic of highest fundamental frequency.
2. For above 1GHz, the EUT peak value was under average limit, therefore the Average value compliance with the average limit

Report No.: T200824W11-RP

Test Mode:	BLE-2Mbps High CH	Temp/Hum	25.0(°C)/ 43%RH
Test Item	Harmonic	Test Date	September 8, 2020
Polarize	Horizontal	Test Engineer	Jerry Chang
Detector	Peak		

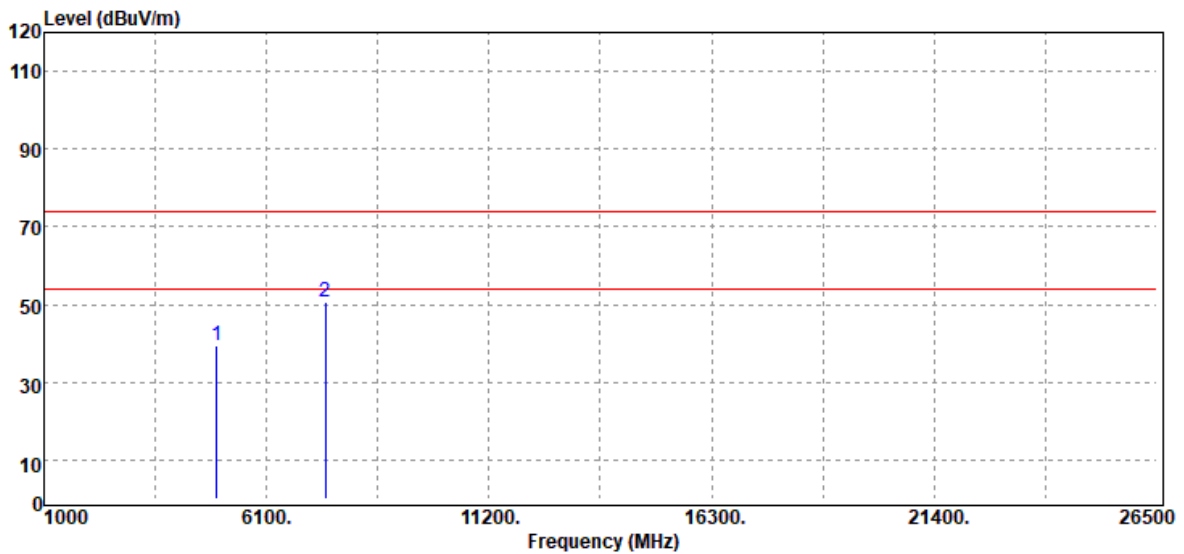

Freq. MHz	Detector Mode PK/QP/AV	Spectrum Reading Level dB μ V	Factor dB	Actual FS dB μ V/m	Limit @3m dB μ V/m	Margin dB
4960.00	Peak	34.86	4.46	39.32	74.00	-34.68
7440.00	Peak	40.01	10.66	50.67	74.00	-23.33
N/A						

Remark:

1. Measuring frequencies from 1 GHz to the 10th harmonic of highest fundamental frequency.
2. For above 1GHz, the EUT peak value was under average limit, therefore the Average value compliance with the average limit

Report No.: T200824W11-RP

Above 1G Test Data

Model: MDBT42TV-P

Test Mode:	BLE-1Mbps Low CH	Temp/Hum	25.0(°C)/ 43%RH
Test Item	Harmonic	Test Date	September 8, 2020
Polarize	Vertical	Test Engineer	Jerry Chang
Detector	Peak		

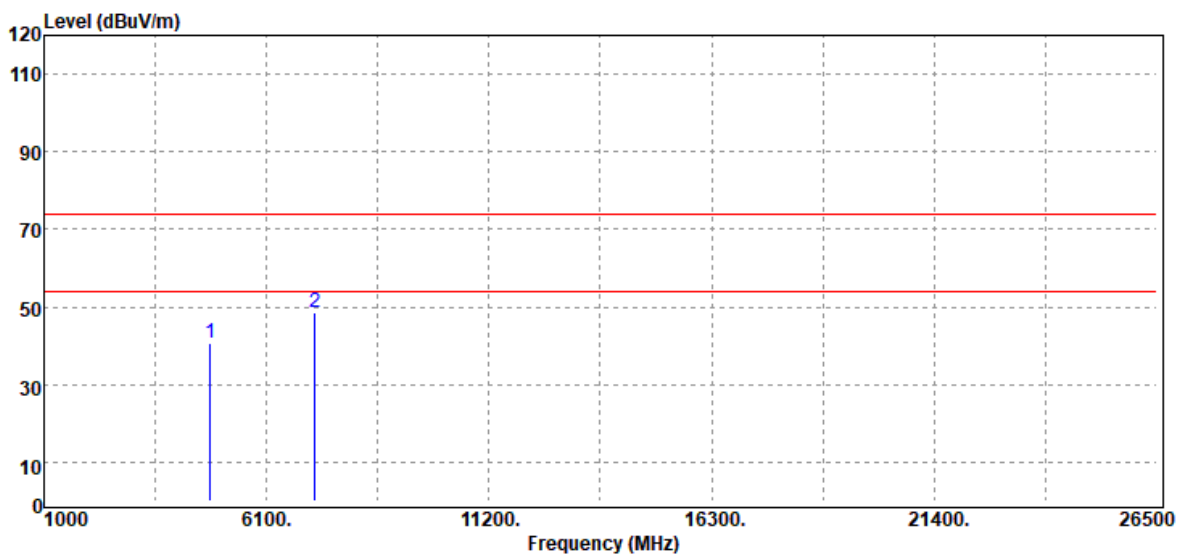

Freq. MHz	Detector Mode PK/QP/AV	Spectrum Reading Level dB μ V	Factor dB	Actual FS dB μ V/m	Limit @3m dB μ V/m	Margin dB
4804.00	Peak	37.32	3.36	40.68	74.00	-33.32
7206.00	Peak	37.95	10.77	48.72	74.00	-25.28
N/A						

Remark:

1. Measuring frequencies from 1 GHz to the 10th harmonic of highest fundamental frequency.
2. For above 1GHz, the EUT peak value was under average limit, therefore the Average value compliance with the average limit

Test Mode:	BLE-1Mbps Low CH	Temp/Hum	25.0(°C)/ 43%RH
Test Item	Harmonic	Test Date	September 8, 2020
Polarize	Horizontal	Test Engineer	Jerry Chang
Detector	Peak		

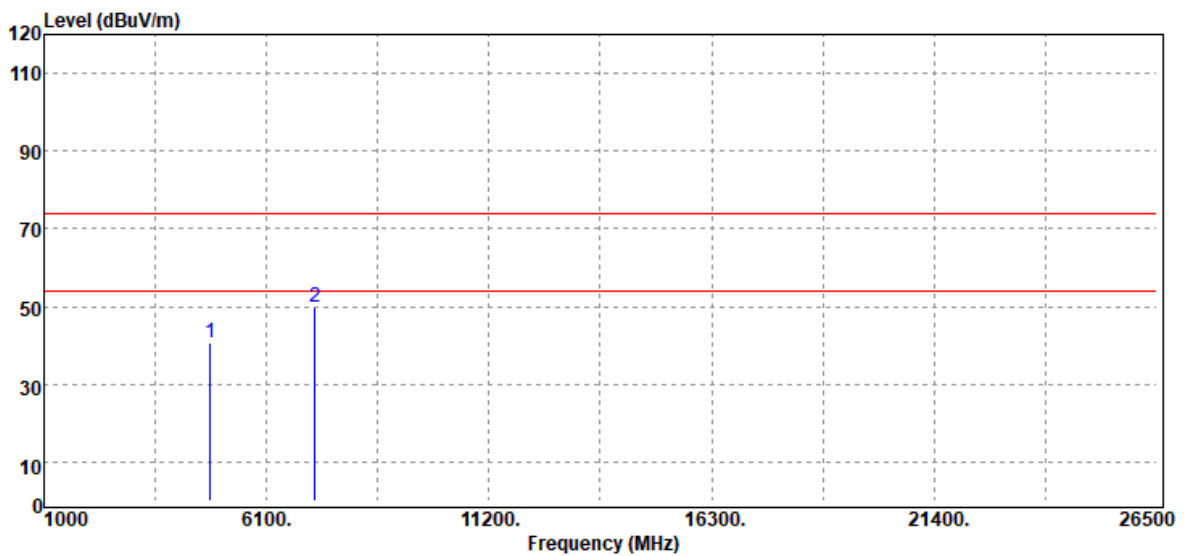

Freq. MHz	Detector Mode PK/QP/AV	Spectrum Reading Level dB μ V	Factor dB	Actual FS dB μ V/m	Limit @3m dB μ V/m	Margin dB
4804.00	Peak	37.25	3.36	40.61	74.00	-33.39
7206.00	Peak	39.15	10.77	49.92	74.00	-24.08
N/A						

Remark:

1. Measuring frequencies from 1 GHz to the 10th harmonic of highest fundamental frequency.
2. For above 1GHz, the EUT peak value was under average limit, therefore the Average value compliance with the average limit

Report No.: T200824W11-RP

Test Mode:	BLE-1Mbps Mid CH	Temp/Hum	25.0(°C)/ 43%RH
Test Item	Harmonic	Test Date	September 8, 2020
Polarize	Vertical	Test Engineer	Jerry Chang
Detector	Peak		

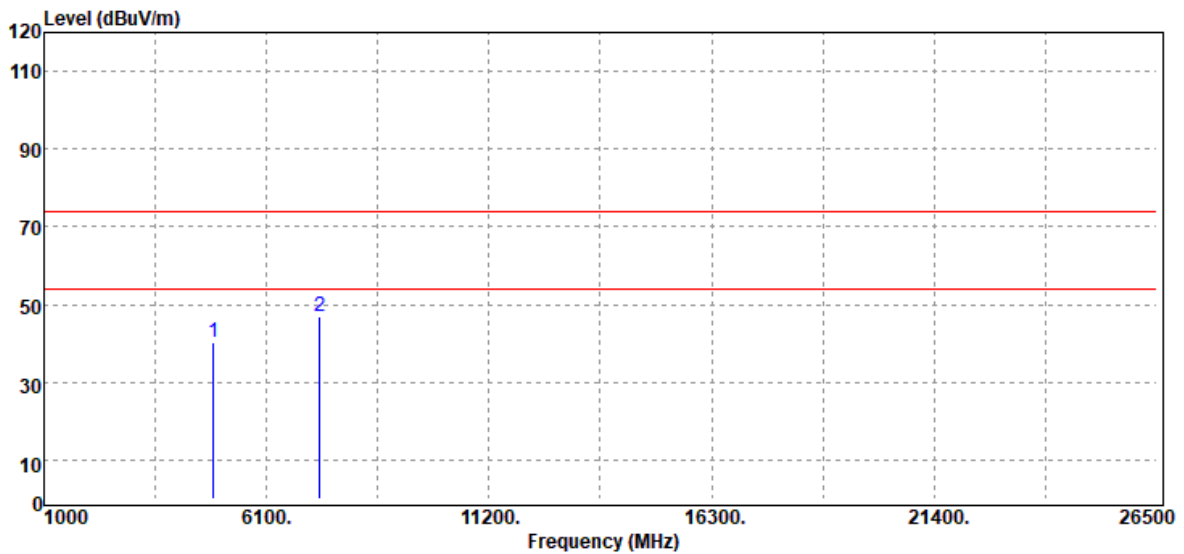

Freq. MHz	Detector Mode PK/QP/AV	Spectrum Reading Level dB μ V	Factor dB	Actual FS dB μ V/m	Limit @3m dB μ V/m	Margin dB
4884.00	Peak	36.60	3.53	40.13	74.00	-33.87
7326.00	Peak	36.09	11.00	47.09	74.00	-26.91
N/A						

Remark:

1. Measuring frequencies from 1 GHz to the 10th harmonic of highest fundamental frequency.
2. For above 1GHz, the EUT peak value was under average limit, therefore the Average value compliance with the average limit

Report No.: T200824W11-RP

Test Mode:	BLE-1Mbps Mid CH	Temp/Hum	25.0(°C)/ 43%RH
Test Item	Harmonic	Test Date	September 8, 2020
Polarize	Horizontal	Test Engineer	Jerry Chang
Detector	Peak		

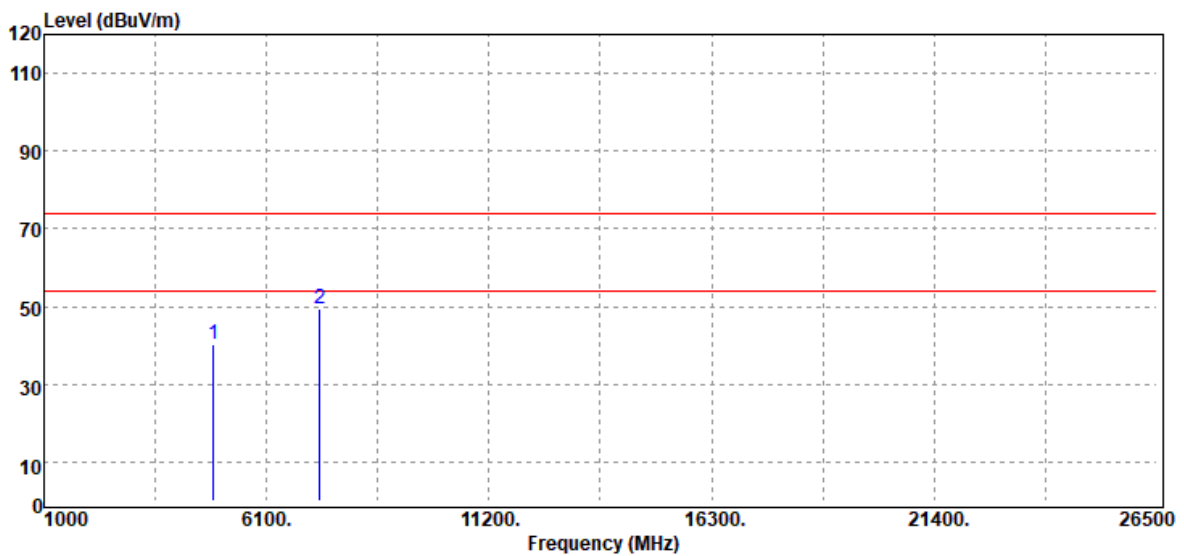

Freq. MHz	Detector Mode PK/QP/AV	Spectrum Reading Level dB μ V	Factor dB	Actual FS dB μ V/m	Limit @3m dB μ V/m	Margin dB
4884.00	Peak	36.55	3.53	40.08	74.00	-33.92
7326.00	Peak	38.36	11.00	49.36	74.00	-24.64
N/A						

Remark:

1. Measuring frequencies from 1 GHz to the 10th harmonic of highest fundamental frequency.
2. For above 1GHz, the EUT peak value was under average limit, therefore the Average value compliance with the average limit

Report No.: T200824W11-RP

Test Mode:	BLE-1Mbps High CH	Temp/Hum	25.0(°C)/ 43%RH
Test Item	Harmonic	Test Date	September 8, 2020
Polarize	Vertical	Test Engineer	Jerry Chang
Detector	Peak		

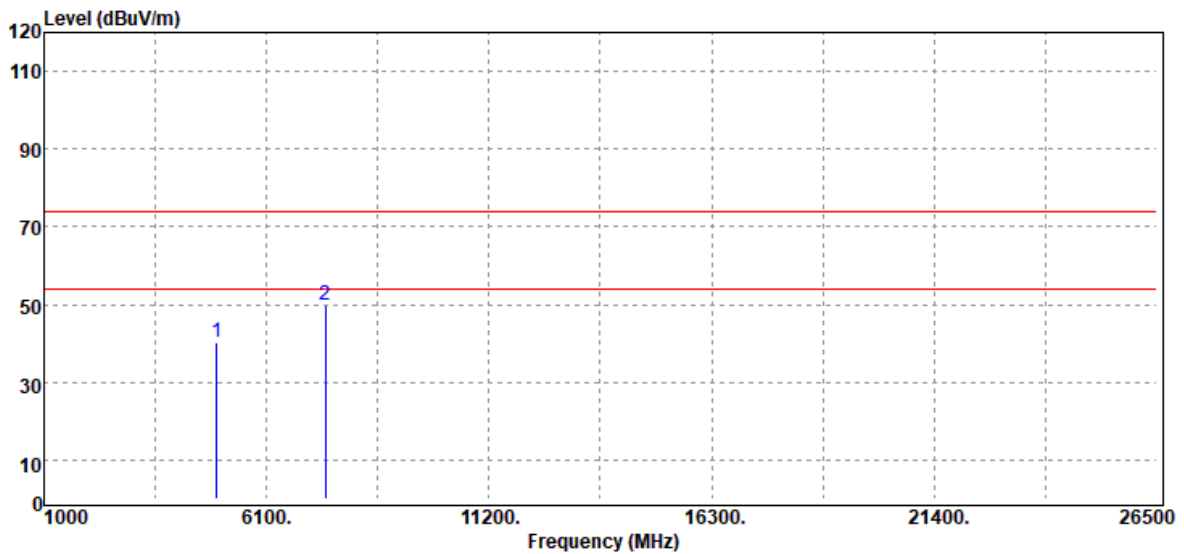

Freq. MHz	Detector Mode PK/QP/AV	Spectrum Reading Level dB μ V	Factor dB	Actual FS dB μ V/m	Limit @3m dB μ V/m	Margin dB
4960.00	Peak	35.66	4.46	40.12	74.00	-33.88
7440.00	Peak	39.25	10.66	49.91	74.00	-24.09
N/A						

Remark:

1. Measuring frequencies from 1 GHz to the 10th harmonic of highest fundamental frequency.
2. For above 1GHz, the EUT peak value was under average limit, therefore the Average value compliance with the average limit

Report No.: T200824W11-RP

Test Mode:	BLE-1Mbps High CH	Temp/Hum	25.0(°C)/ 43%RH
Test Item	Harmonic	Test Date	September 8, 2020
Polarize	Horizontal	Test Engineer	Jerry Chang
Detector	Peak		

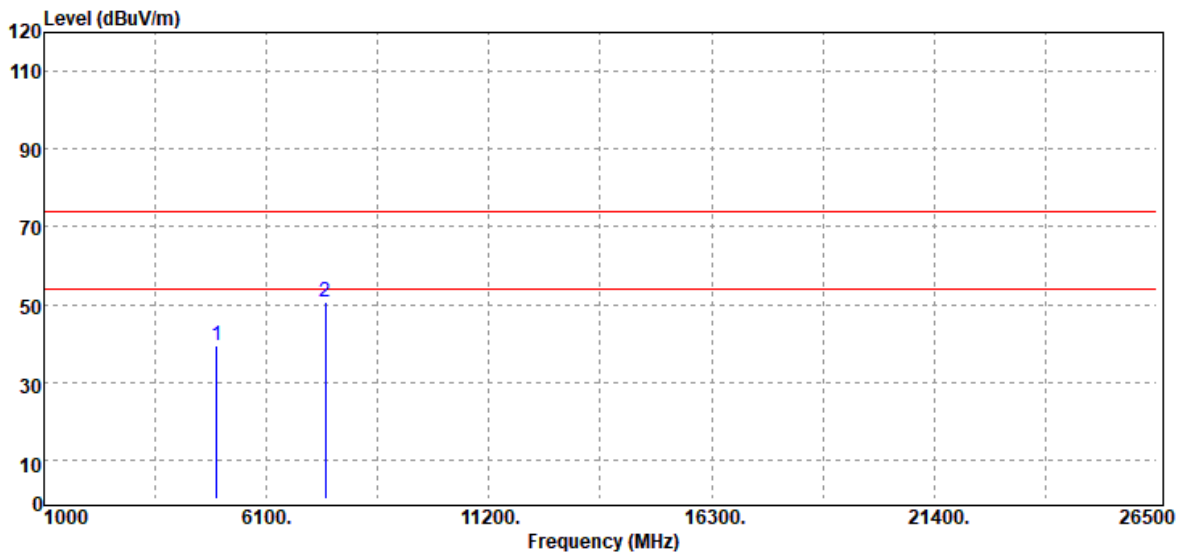

Freq. MHz	Detector Mode PK/QP/AV	Spectrum Reading Level dB μ V	Factor dB	Actual FS dB μ V/m	Limit @3m dB μ V/m	Margin dB
4960.00	Peak	34.90	4.46	39.36	74.00	-34.64
7440.00	Peak	40.15	10.66	50.81	74.00	-23.19
N/A						

Remark:

1. Measuring frequencies from 1 GHz to the 10th harmonic of highest fundamental frequency.
2. For above 1GHz, the EUT peak value was under average limit, therefore the Average value compliance with the average limit

Test Mode:	BLE-2Mbps Low CH	Temp/Hum	25.0(°C)/ 43%RH
Test Item	Harmonic	Test Date	September 8, 2020
Polarize	Vertical	Test Engineer	Jerry Chang
Detector	Peak		

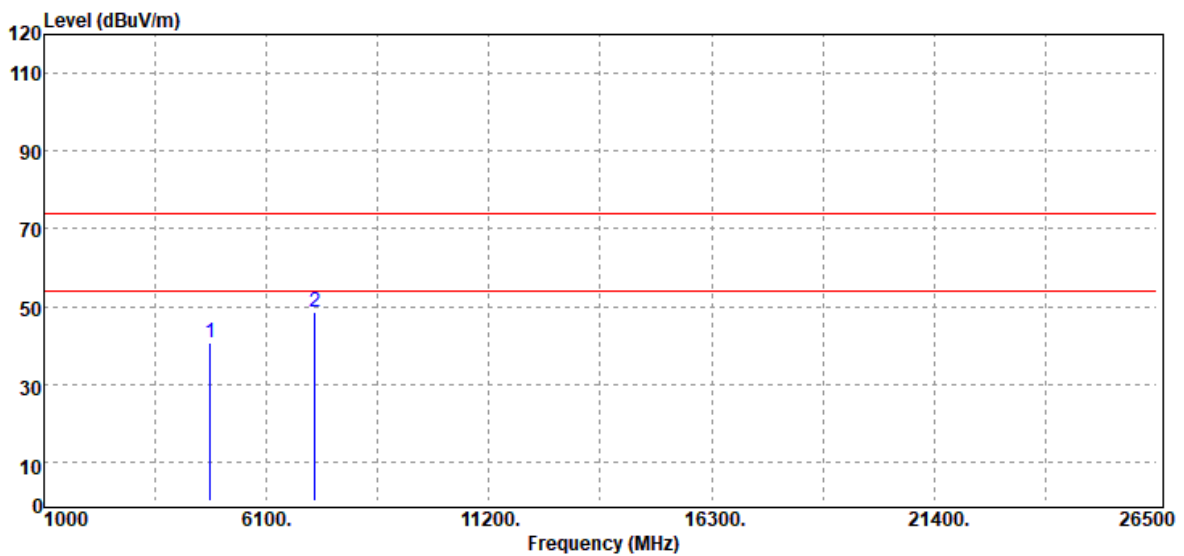

Freq. MHz	Detector Mode PK/QP/AV	Spectrum Reading Level dB μ V	Factor dB	Actual FS dB μ V/m	Limit @3m dB μ V/m	Margin dB
4804.00	Peak	37.23	3.36	40.59	74.00	-33.41
7206.00	Peak	37.79	10.77	48.56	74.00	-25.44
N/A						

Remark:

1. Measuring frequencies from 1 GHz to the 10th harmonic of highest fundamental frequency.
2. For above 1GHz, the EUT peak value was under average limit, therefore the Average value compliance with the average limit

Report No.: T200824W11-RP

Test Mode:	BLE-2Mbps Low CH	Temp/Hum	25.0(°C)/ 43%RH
Test Item	Harmonic	Test Date	September 8, 2020
Polarize	Horizontal	Test Engineer	Jerry Chang
Detector	Peak		

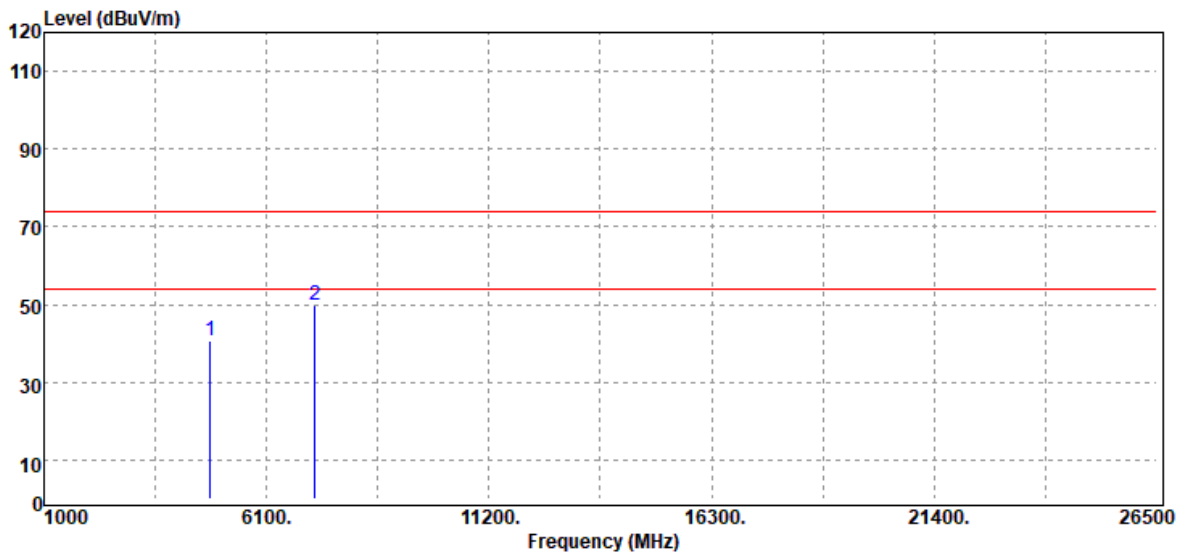

Freq. MHz	Detector Mode PK/QP/AV	Spectrum Reading Level dB μ V	Factor dB	Actual FS dB μ V/m	Limit @3m dB μ V/m	Margin dB
4804.00	Peak	37.25	3.36	40.61	74.00	-33.39
7206.00	Peak	38.95	10.77	49.72	74.00	-24.28
N/A						

Remark:

1. Measuring frequencies from 1 GHz to the 10th harmonic of highest fundamental frequency.
2. For above 1GHz, the EUT peak value was under average limit, therefore the Average value compliance with the average limit

Test Mode:	BLE-2Mbps Mid CH	Temp/Hum	25.0(°C)/ 43%RH
Test Item	Harmonic	Test Date	September 8, 2020
Polarize	Vertical	Test Engineer	Jerry Chang
Detector	Peak		

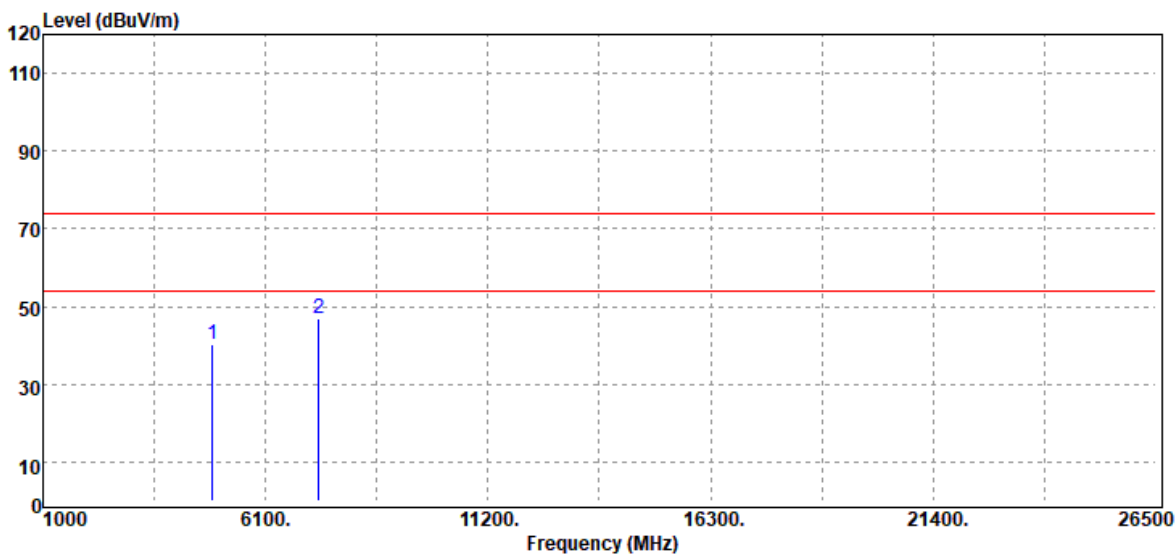

Freq. MHz	Detector Mode PK/QP/AV	Spectrum Reading Level dB μ V	Factor dB	Actual FS dB μ V/m	Limit @3m dB μ V/m	Margin dB
4884.00	Peak	36.69	3.53	40.22	74.00	-33.78
7326.00	Peak	36.07	11.00	47.07	74.00	-26.93
N/A						

Remark:

1. Measuring frequencies from 1 GHz to the 10th harmonic of highest fundamental frequency.
2. For above 1GHz, the EUT peak value was under average limit, therefore the Average value compliance with the average limit

Report No.: T200824W11-RP

Test Mode:	BLE-2Mbps Mid CH	Temp/Hum	25.0(°C)/ 43%RH
Test Item	Harmonic	Test Date	September 8, 2020
Polarize	Horizontal	Test Engineer	Jerry Chang
Detector	Peak		

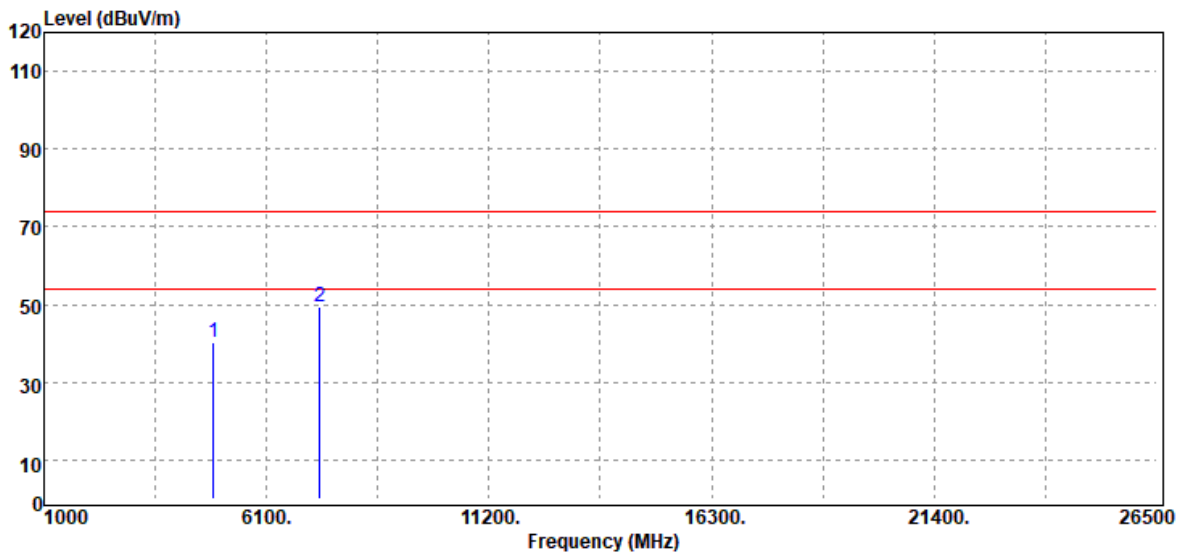

Freq. MHz	Detector Mode PK/QP/AV	Spectrum Reading Level dB μ V	Factor dB	Actual FS dB μ V/m	Limit @3m dB μ V/m	Margin dB
4884.00	Peak	36.75	3.53	40.28	74.00	-33.72
7326.00	Peak	38.32	11.00	49.32	74.00	-24.68
N/A						

Remark:

1. Measuring frequencies from 1 GHz to the 10th harmonic of highest fundamental frequency.
2. For above 1GHz, the EUT peak value was under average limit, therefore the Average value compliance with the average limit

Report No.: T200824W11-RP

Test Mode:	BLE-2Mbps High CH	Temp/Hum	25.0(°C)/ 43%RH
Test Item	Harmonic	Test Date	September 8, 2020
Polarize	Vertical	Test Engineer	Jerry Chang
Detector	Peak		

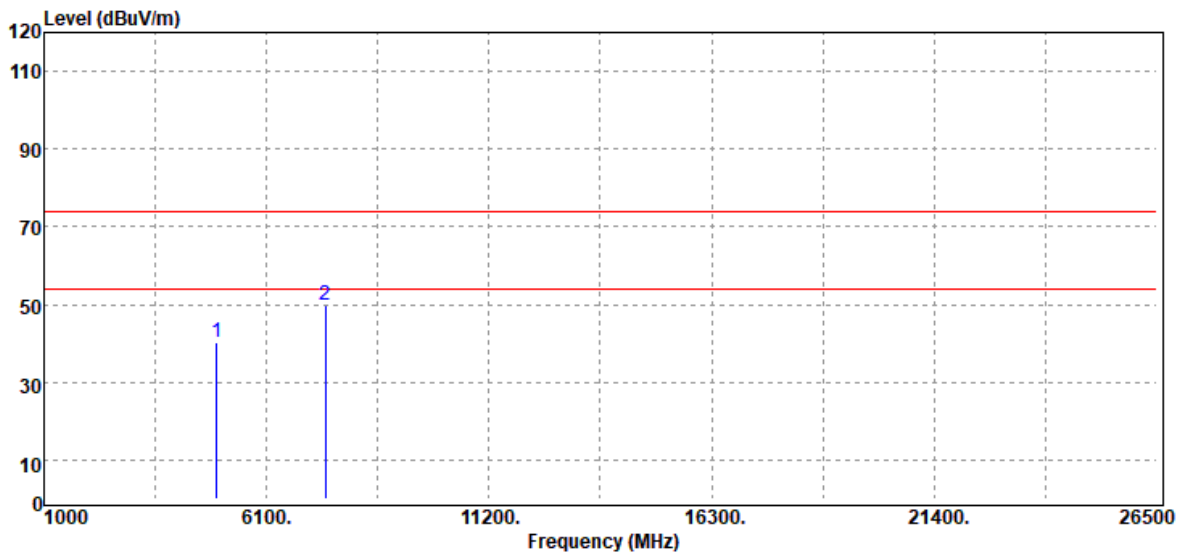

Freq. MHz	Detector Mode PK/QP/AV	Spectrum Reading Level dB μ V	Factor dB	Actual FS dB μ V/m	Limit @3m dB μ V/m	Margin dB
4960.00	Peak	35.86	4.46	40.32	74.00	-33.68
7440.00	Peak	39.08	10.66	49.74	74.00	-24.26
N/A						

Remark:

1. Measuring frequencies from 1 GHz to the 10th harmonic of highest fundamental frequency.
2. For above 1GHz, the EUT peak value was under average limit, therefore the Average value compliance with the average limit

Report No.: T200824W11-RP

Test Mode:	BLE-2Mbps High CH	Temp/Hum	25.0(°C)/ 43%RH
Test Item	Harmonic	Test Date	September 8, 2020
Polarize	Horizontal	Test Engineer	Jerry Chang
Detector	Peak		

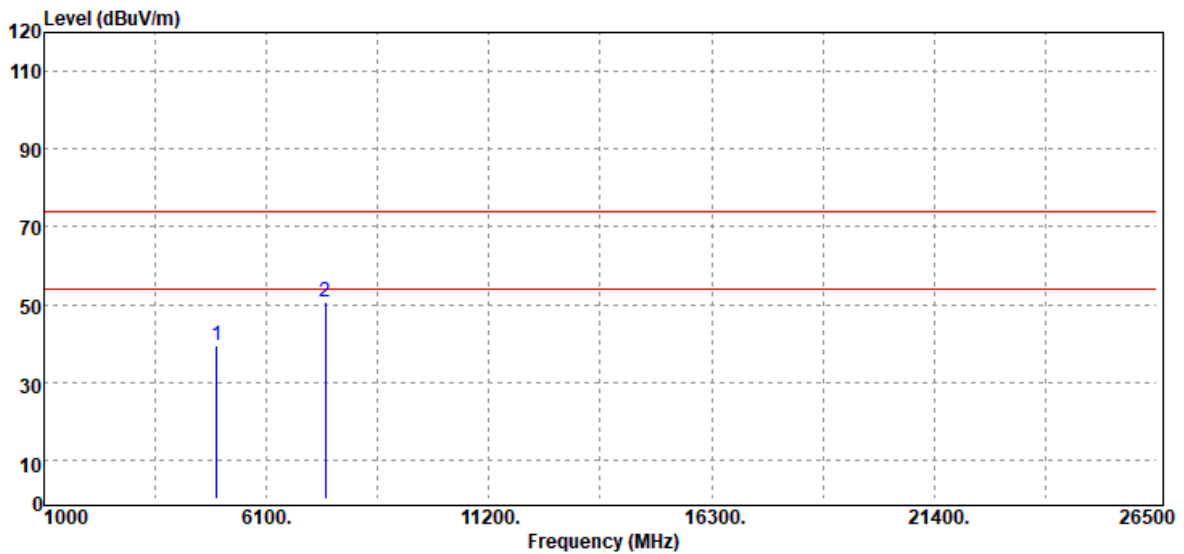

Freq. MHz	Detector Mode PK/QP/AV	Spectrum Reading Level dB μ V	Factor dB	Actual FS dB μ V/m	Limit @3m dB μ V/m	Margin dB
4960.00	Peak	35.13	4.46	39.59	74.00	-34.41
7440.00	Peak	39.84	10.66	50.50	74.00	-23.50
N/A						

Remark:

1. Measuring frequencies from 1 GHz to the 10th harmonic of highest fundamental frequency.
2. For above 1GHz, the EUT peak value was under average limit, therefore the Average value compliance with the average limit

--End of Test Report--