

FCC RADIO TEST REPORT

according to

47 CFR FCC Part 15 Subpart C § 15.249

Equipment : **Wireless Audio Transmitter**
Model No. : **MB1000T**
Brand Name : **Raytac**
Filing Type : **New Application**
Applicant : **Raytac Corp.**
12F., No.786, Zhongzheng Rd., Zhonghe City, Taipei County
23586, Taiwan
FCC ID : **SH6MB1000T**
Manufacturer : **Raytac Corp.**
12F., No.786, Zhongzheng Rd., Zhonghe City, Taipei County
23586, Taiwan
Received Date : Jul. 22, 2008
Final Test Date : Jul. 24, 2008

Statement

The test result in this report refers exclusively to the presented test model / sample.

Without written approval of SPORTON International Inc., the test report shall not be reproduced except in full.

The measurements and test results shown in this test report were made in accordance with the procedures and found in compliance with the limit given in **ANSI C63.4-2003** and **47 CFR FCC Part 15 Subpart C**.

The test equipment used to perform the test is calibrated and traceable to NML/ROC.



SPORTON International Inc.

6F, No. 106, Sec. 1, Hsin Tai Wu Rd., Hsi Chih, Taipei Hsien, Taiwan, R.O.C.

Table of Contents

1. SUMMARY OF THE TEST RESULT 2

2. GENERAL INFORMATION..... 3

2.1. Product Details 3

2.2. Table for Filed Antenna 3

2.3. Table for Carrier Frequencies 3

2.4. Table for Test Modes 3

2.5. Table for Testing Locations 4

2.6. Table for Supporting Units..... 4

2.7. Test Configurations 5

3. TEST RESULT 7

3.1. AC Power Line Conducted Emissions Measurement..... 7

3.2. Field Strength of Fundamental Emissions Measurement..... 11

3.3. 20dB Spectrum Bandwidth Measurement..... 14

3.4. Radiated Emissions Measurement..... 17

3.5. Band Edge Emissions Measurement 29

3.6. Antenna Requirements..... 31

4. LIST OF MEASURING EQUIPMENTS 32

5. TEST LOCATION..... 34

6. TAF CERTIFICATE OF ACCREDITATION 35

APPENDIX A. TEST PHOTOS A1 ~ A6

APPENDIX B. PHOTOGRAPHS OF EUT B1 ~ B6

CERTIFICATE OF COMPLIANCE

according to

47 CFR FCC Part 15 Subpart C § 15.249

Equipment : Wireless Audio Transmitter

Model No. : MB1000T

Brand Name : Raytac

Applicant : Raytac Corp.

12F., No.786, Zhongzheng Rd., Zhonghe City,
Taipei County 23586, Taiwan

Sporton International as requested by the applicant to evaluate the EMC performance of the product sample received on Jul. 22, 2008 would like to declare that the tested sample has been evaluated and found to be in compliance with the tested rule parts. The data recorded as well as the test configuration specified is true and accurate for showing the sample's EMC nature.

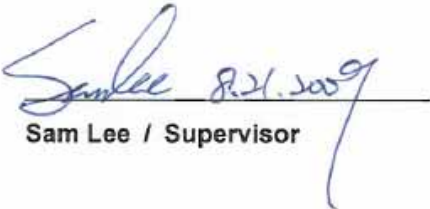

Sam Lee / Supervisor

SPORTON International Inc.

6F, No.106, Sec. 1, Hsin Tai Wu Rd., Hsi Chih, Taipei Hsien, Taiwan, R.O.C.

1. SUMMARY OF THE TEST RESULT

Applied Standard: 47 CFR FCC Part 15 Subpart C				
Part	Rule Section	Description of Test	Result	Under Limit
3.1	15.207	AC Power Line Conducted Emissions	Complies	8.69 dB
3.2	15.249(a)	Field Strength of Fundamental Emissions	Complies	2.83 dB
3.3	15.215(c)	20dB Spectrum Bandwidth	Complies	-
3.4	15.249(a)/(d)	Radiated Emissions	Complies	3.57 dB
3.5	15.249(d)	Band Edge Emissions	Complies	2.51 dB
3.6	15.203	Antenna Requirements	Complies	-

Test Items	Uncertainty	Remark
AC Power Line Conducted Emissions	±2.3dB	Confidence levels of 95%
Field Strength of Fundamental Emissions	±0.8dB	Confidence levels of 95%
20dB Spectrum Bandwidth	±8.5×10 ⁻⁸	Confidence levels of 95%
Radiated Emissions (9kHz~30MHz)	±0.8dB	Confidence levels of 95%
Radiated Emissions (30MHz~1000MHz)	±1.9dB	Confidence levels of 95%
Radiated / Band Edge Emissions (1GHz~18GHz)	±1.9dB	Confidence levels of 95%
Radiated Emissions (18GHz~40GHz)	±1.9dB	Confidence levels of 95%
Temperature	±0.7	Confidence levels of 95%
Humidity	±3.2%	Confidence levels of 95%
DC / AC Power Source	±1.4%	Confidence levels of 95%

2. GENERAL INFORMATION

2.1. Product Details

Items	Description
Power Type	Power from host
Modulation	GFSK
Frequency Range	2400 ~ 2483.5MHz
Channel Number	38
Channel Band Width (99%)	2.79 MHz
Max. Field Strength	91.17 dBuV/m at 3m (Average)

2.2. Table for Filed Antenna

Ant.	Antenna Type	Connector	Gain (dBi)
1	PIFA Antenna	FIX ON BOARD	0.84

2.3. Table for Carrier Frequencies

Frequency Band	Channel No.	Frequency
2400 ~ 2483.5MHz	1	2404 MHz
	2	2406 MHz
	:	:
	18	2438 MHz
	19	2440 MHz
	20	2442 MHz
	:	:
	37	2476 MHz
	38	2478 MHz

2.4. Table for Test Modes

Investigation has been done on all the possible configurations for searching the worst cases. The following table is a list of the test modes shown in this test report.

Test Items	Mode	Channel	Antenna
AC Power Line Conducted Emissions	Charger Mode	-	-
Field Strength of Fundamental Emissions 20dB Spectrum Bandwidth	CTX	1/19/38	1
Radiated Emissions 9kHz~1GHz	CTX	19	1
Radiated Emissions 1GHz~10 th Harmonic	CTX	1/19/38	1
Band Edge Emissions	CTX	1/38	1

Note: CTX=continuously transmitting

2.5. Table for Testing Locations

Test Site No.	Site Category	Location	FCC Reg. No.	IC File No.	VCCI Reg. No
03CH03-HY	SAC	Hwa Ya	643075	IC 4086B-1	-
CO04-HY	Conduction	Hwa Ya	643075	IC 4086B-1	-
TH01-HY	OVEN Room	Hwa Ya	-	-	-

Open Area Test Site (OATS); Semi Anechoic Chamber (SAC); Fully Anechoic Chamber (FAC).

2.6. Table for Supporting Units

Support Unit	Brand	Model	FCC ID
Notebook	DELL	D400	DoC
Mouse (USB)	Microsoft	1004	N/A
Modem	ACEXX	DM1414	IFAXDM1414
MIC+Earphone (Remote Workstation)	J-S	CD-87MV	N/A
Speaker (Remote Workstation)	KINYO	PS-240	N/A
Wireless Audio Box (Remote Workstation)	Raytac	MB1000	N/A

2.7. Test Configurations

2.7.1. Radiation Emissions Test Configuration

For radiated emissions 9kHz~1GHz

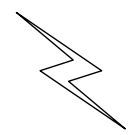
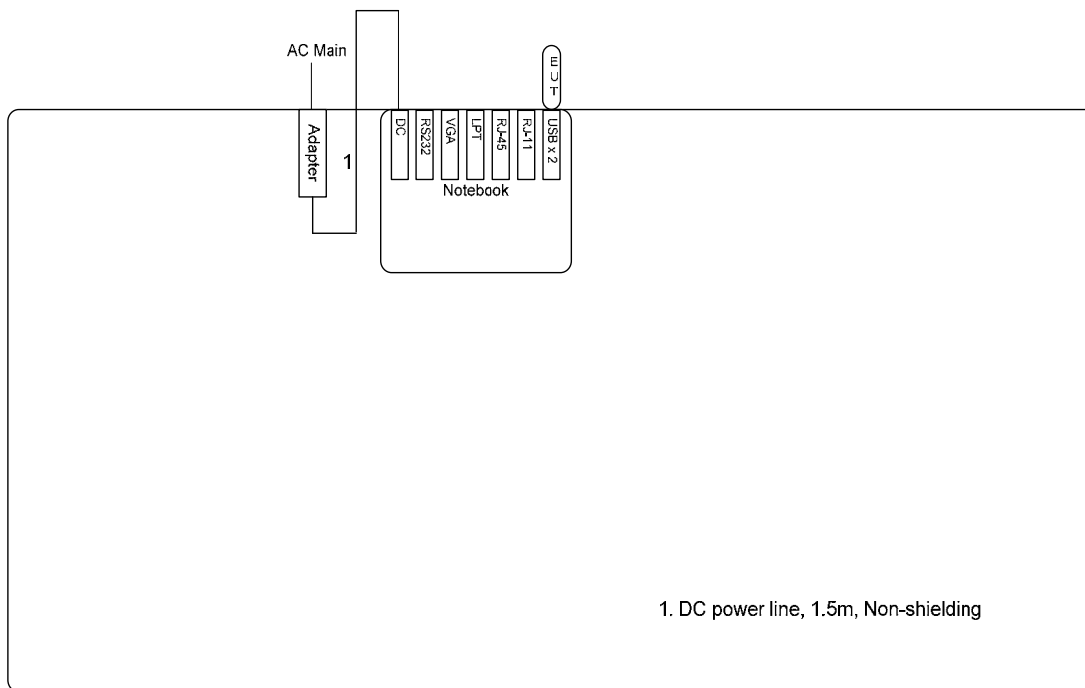

Remote Workstation

For radiated emissions above 1GHz

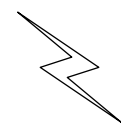
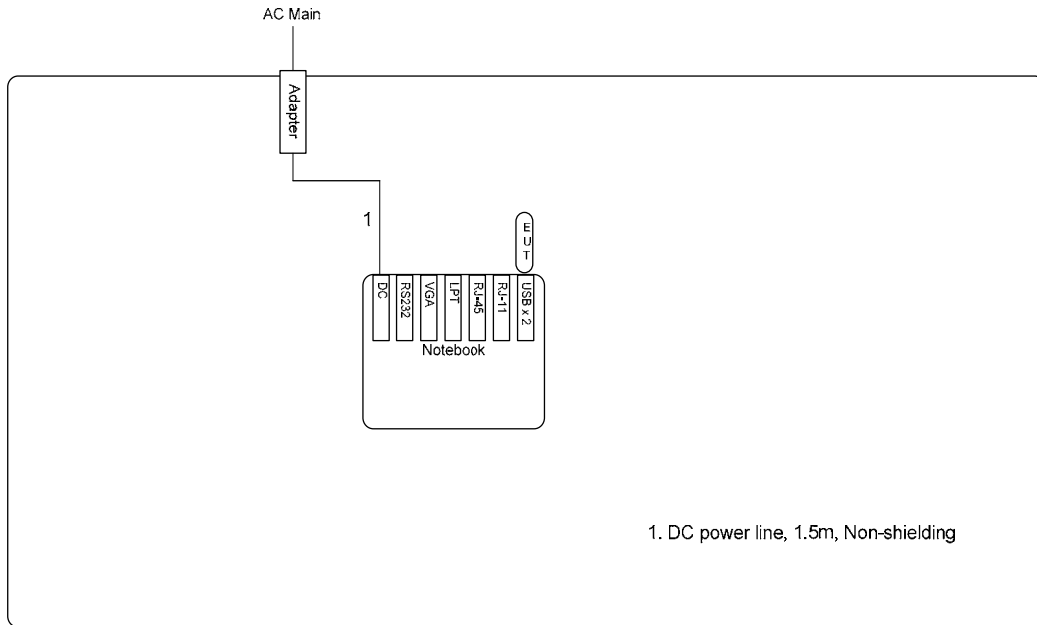

Remote Workstation

3. TEST RESULT

3.1. AC Power Line Conducted Emissions Measurement

3.1.1. Limit

For this product which is designed to be connected to the AC power line, the radio frequency voltage that is conducted back onto the AC power line on any frequency or frequencies within the band 150 kHz to 30 MHz shall not exceed below limits table.

Frequency (MHz)	QP Limit (dBuV)	AV Limit (dBuV)
0.15~0.5	66~56	56~46
0.5~5	56	46
5~30	60	50

3.1.2. Measuring Instruments and Setting

Please refer to section 4 of equipments list in this report. The following table is the setting of the receiver.

Receiver Parameters	Setting
Attenuation	10 dB
Start Frequency	0.15 MHz
Stop Frequency	30 MHz
IF Bandwidth	9 KHz

3.1.3. Test Procedures

1. Configure the EUT according to ANSI C63.4. The EUT or host of EUT has to be placed 0.4 meter far from the conducting wall of the shielding room and at least 80 centimeters from any other grounded conducting surface.
2. Connect EUT or host of EUT to the power mains through a line impedance stabilization network (LISN).
3. All the support units are connected to the other LISNs. The LISN should provide 50uH/50ohms coupling impedance.
4. The frequency range from 150 KHz to 30 MHz was searched.
5. Set the test-receiver system to Peak Detect Function and Specified Bandwidth with Maximum Hold Mode.
6. The measurement has to be done between each power line and ground at the power terminal.

3.1.4. Test Setup Layout

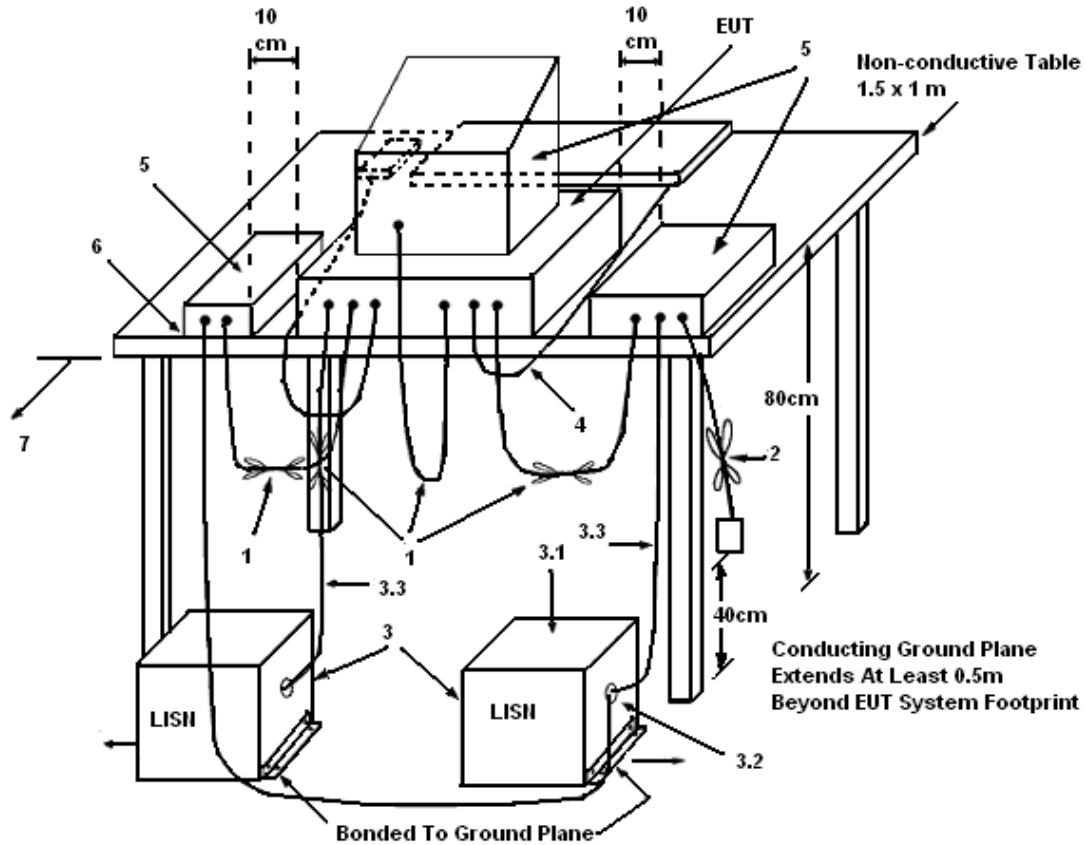

LEGEND:

- (1) Interconnecting cables that hang closer than 40 cm to the ground plane shall be folded back and forth in the center forming a bundle 30 to 40 cm long.
- (2) I/O cables that are not connected to a peripheral shall be bundled in the center. The end of the cable may be terminated, if required, using the correct terminating impedance. The overall length shall not exceed 1 m.
- (3) EUT connected to one LISN. Unused LISN measuring port connectors shall be terminated in 50 Ω. LISN can be placed on top of, or immediately beneath, reference ground plane.
- (3.1) All other equipment powered from additional LISN(s).
- (3.2) Multiple outlet strip can be used for multiple power cords of non-EUT equipment.
- (3.3) LISN at least 80 cm from nearest part of EUT chassis.
- (4) Cables of hand-operated devices, such as keyboards, mice, etc., shall be placed as for normal use.
- (5) Non-EUT components of EUT system being tested.
- (6) Rear of EUT, including peripherals, shall all be aligned and flush with rear of tabletop.
- (7) Rear of tabletop shall be 40 cm removed from a vertical conducting plane that is bonded to the ground plane.

3.1.5. Test Deviation

There is no deviation with the original standard.

3.1.6. EUT Operation during Test

The EUT was placed on the test table and programmed in normal function.

3.1.7. Results of AC Power Line Conducted Emissions Measurement

Test date	Jul. 24, 2008	Test Site No.	CO04-HY
Temperature	23	Humidity	64%
Test Engineer	Steven	Phase	Line
Configurations	Charger Mode		

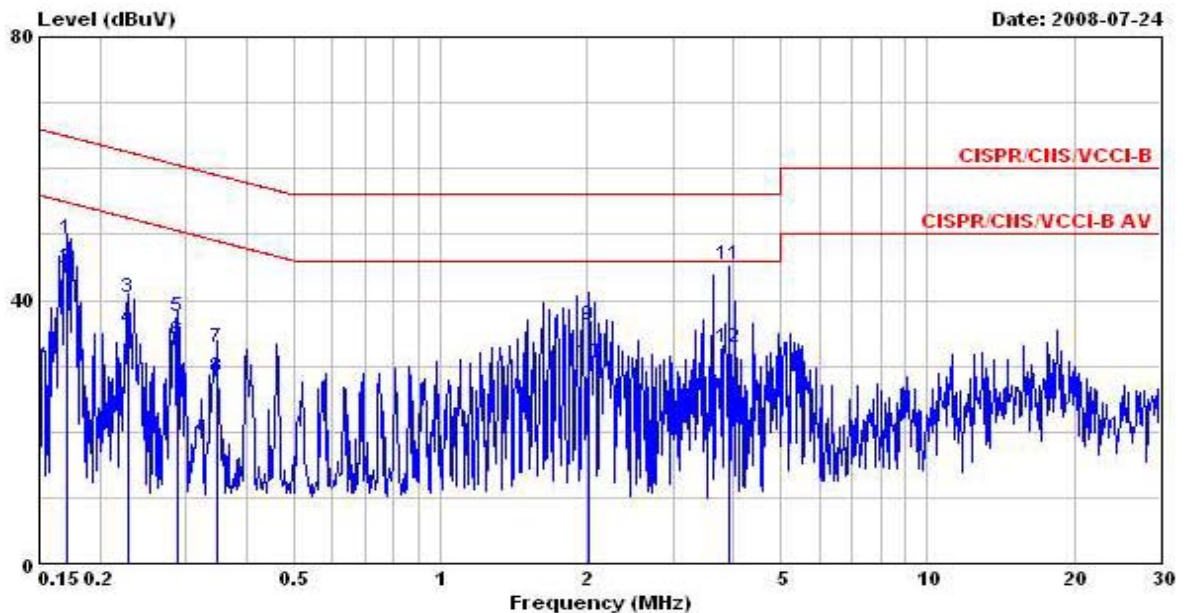

	Freq	Level	Over Limit	Limit Line	Read Level	LISN Factor	Cable Loss	Remark
	MHz	dBuV	dB	dBuV	dBuV	dB	dB	
1	0.1712450	49.35	-15.55	64.90	49.20	0.09	0.06	QP
2	0.1712450	44.88	-10.02	54.90	44.73	0.09	0.06	Average
3	0.2291780	40.35	-22.13	62.48	40.20	0.09	0.06	QP
4	0.2291780	35.72	-16.76	52.48	35.57	0.09	0.06	Average
5	0.2878180	37.58	-23.01	60.59	37.43	0.10	0.05	QP
6	0.2878180	33.84	-16.75	50.59	33.69	0.10	0.05	Average
7	0.3464610	32.83	-26.22	59.05	32.69	0.10	0.04	QP
8	0.3464610	28.37	-20.68	49.05	28.23	0.10	0.04	Average
9	2.020	36.18	-19.82	56.00	35.37	0.13	0.68	QP
10	2.020	30.30	-15.70	46.00	29.49	0.13	0.68	Average
11	3.915	45.43	-10.57	56.00	45.12	0.17	0.14	QP
12	3.915	32.66	-13.34	46.00	32.35	0.17	0.14	Average

Test date	Jul. 24, 2008	Test Site No.	CO04-HY
Temperature	23	Humidity	64%
Test Engineer	Steven	Phase	Neutral
Configurations	Charger Mode		

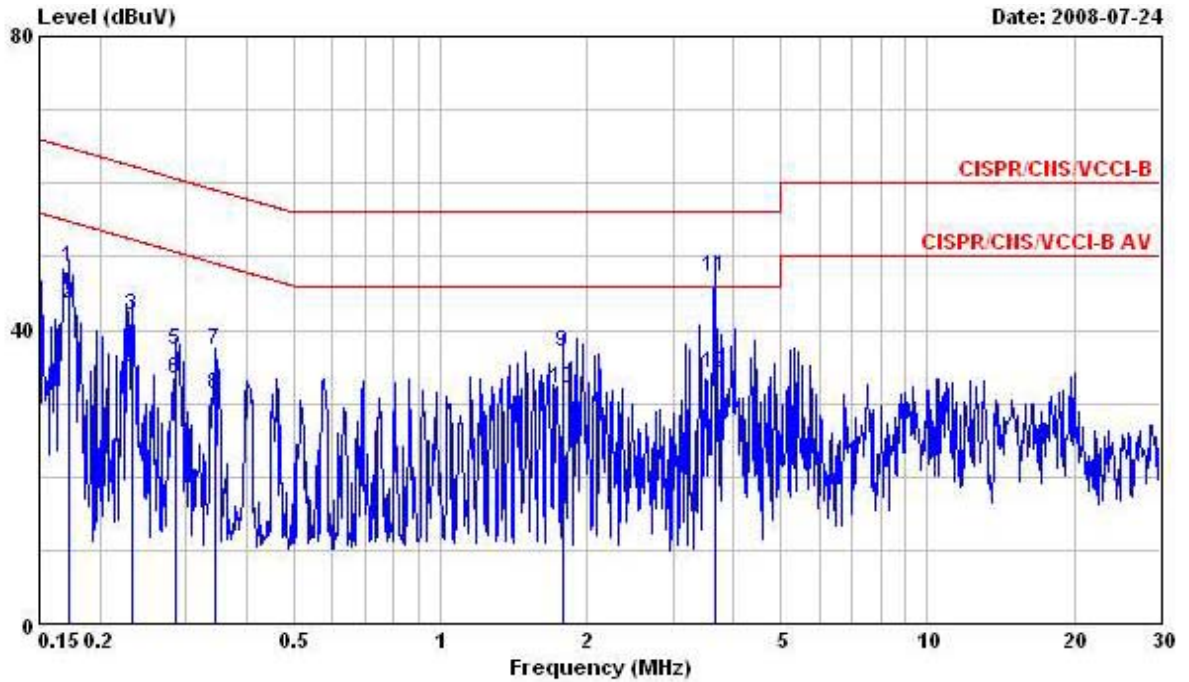

	Freq	Level	Over Limit	Limit Line	Read Level	LISN Factor	Cable Loss	Remark
	MHz	dBuV	dB	dBuV	dBuV	dB	dB	
1	0.1721540	48.62	-16.24	64.86	48.48	0.08	0.06	QP
2	0.1721540	43.49	-11.37	54.86	43.35	0.08	0.06	Average
3	0.2328500	41.86	-20.49	62.35	41.72	0.08	0.06	QP
4	0.2328500	34.48	-17.87	52.35	34.34	0.08	0.06	Average
5	0.2847840	37.31	-23.37	60.68	37.17	0.09	0.05	QP
6	0.2847840	33.36	-17.32	50.68	33.22	0.09	0.05	Average
7	0.3446300	37.31	-21.78	59.09	37.18	0.09	0.04	QP
8	0.3446300	31.13	-17.96	49.09	31.00	0.09	0.04	Average
9	1.780	37.03	-18.97	56.00	36.26	0.12	0.65	QP
10	1.780	32.08	-13.92	46.00	31.31	0.12	0.65	Average
11	3.681	47.31	-8.69	56.00	46.97	0.15	0.19	QP
12	3.681	34.18	-11.82	46.00	33.84	0.15	0.19	Average

Note:

Level = Read Level + LISN Factor + Cable Loss.

3.2. Field Strength of Fundamental Emissions Measurement

3.2.1. Limit

The field strength of fundamental emissions within these bands specified at a distance of 3 meters (measurement instrumentation employing an average detector) shall comply with the following table.

Frequency Band (MHz)	Fundamental Emissions Limit (dBuV/m) at 3m
2400-2483.5	94
5725-5875	94

3.2.2. Measuring Instruments and Setting

Please refer to section 4 of equipments list in this report. The following table is the setting of the spectrum analyzer.

Power Meter Parameter	Setting
RB	1 MHz Peak / 1MHz Average
VB	1 MHz Peak / 10Hz Average
Detector	Peak
Trace	Max Hold
Sweep Time	Auto

3.2.3. Test Procedures

1. Configure the EUT according to ANSI C63.4. The EUT was placed on the top of the turntable 0.8 meter above ground. The phase center of the receiving antenna mounted on the top of a height-variable antenna tower was placed 3 meters far away from the turntable.
2. Power on the EUT and all the supporting units. The turntable was rotated by 360 degrees to determine the position of the highest radiation.
3. The height of the broadband receiving antenna was varied between one meter and four meters above ground to find the maximum emissions field strength of both horizontal and vertical polarization.
4. For each suspected emissions, the antenna tower was scan (from 1 M to 4 M) and then the turntable was rotated (from 0 degree to 360 degrees) to find the maximum reading.
5. For Fundamental emissions, use 1MHz VBW and RBW for peak reading. Then 1MHz RBW and 10Hz VBW for average reading in spectrum analyzer.
6. When the radiated emissions limits are expressed in terms of the average value of the emissions, and pulsed operation is employed, the measurement field strength shall be determined by averaging over one complete pulse train, including blanking intervals, as long as the pulse train does not exceed 0.1 seconds. As an alternative (provided the transmitter operates for longer than 0.1 seconds) or in cases where the pulse train exceeds 0.1 seconds, the measured field strength shall be determined from the average absolute voltage during a 0.1 second interval during which the field strength is at its maximum value.

3.2.4. Test Setup Layout

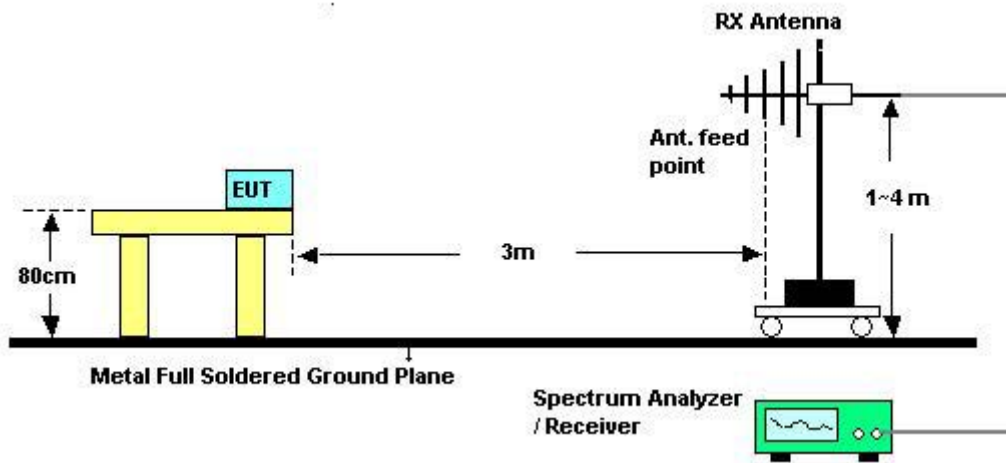

3.2.5. Test Deviation

There is no deviation with the original standard.

3.2.6. EUT Operation during Test

The EUT was programmed to be in continuously transmitting mode.

3.2.7. Test Result of Field Strength of Fundamental Emissions

Test date	Jul. 22, 2008	Test Site No.	03CH03-HY
Temperature	28	Humidity	53%
Test Engineer	Eddie	Configurations	Channel 1/19/38

Channel 1

Vertical

	Freq	Level	Over Limit	Limit Line	ReadAntenna Level	Antenna Factor	Cable Loss	Preamp Factor	Remark
	MHz	dBuV/m	dB	dBuV/m	dBuV	dB/m	dB	dB	
3	2403.290	105.58	-8.42	114.00	75.07	28.33	2.19	0.00	Peak
3	2403.290	88.33	-5.67	94.00	57.82	28.33	2.19	0.00	Average

Channel 19

Vertical

	Freq	Level	Over Limit	Limit Line	ReadAntenna Level	Antenna Factor	Cable Loss	Preamp Factor	Remark
	MHz	dBuV/m	dB	dBuV/m	dBuV	dB/m	dB	dB	
1	2439.580	106.78	-7.22	114.00	76.17	28.40	2.22	0.00	Peak
1 @	2439.580	90.31	-3.69	94.00	59.70	28.40	2.22	0.00	Average

Channel 38

Vertical

	Freq	Level	Over Limit	Limit Line	ReadAntenna Level	Antenna Factor	Cable Loss	Preamp Factor	Remark
	MHz	dBuV/m	dB	dBuV/m	dBuV	dB/m	dB	dB	
1	2477.770	107.75	-6.25	114.00	77.04	28.47	2.25	0.00	Peak
1 @	2477.770	91.17	-2.83	94.00	60.46	28.47	2.25	0.00	Average

Note:

Emission level (dBuV/m) = 20 log Emission level (uV/m).

Corrected Reading: Antenna Factor + Cable Loss + Read Level - Preamp Factor = Level.

3.3. 20dB Spectrum Bandwidth Measurement

3.3.1. Limit

Intentional radiators must be designed to ensure that the 20 dB bandwidth of the emissions in the specific band (2400 ~ 2483.5MHz).

3.3.2. Measuring Instruments and Setting

Please refer to section 4 of equipments list in this report. The following table is the setting of the spectrum analyzer.

Spectrum Parameters	Setting
Attenuation	Auto
Span Frequency	> 6dB Bandwidth
RB	100 kHz
VB	100 kHz
Detector	Peak
Trace	Max Hold
Sweep Time	Auto

3.3.3. Test Procedures

1. The transmitter output (antenna port) was connected to the spectrum analyzer in peak hold mode.
2. The resolution bandwidth of 100 kHz and the video bandwidth of 100 kHz were used.
3. Measured the spectrum width with power higher than 6dB below carrier.

3.3.4. Test Setup Layout

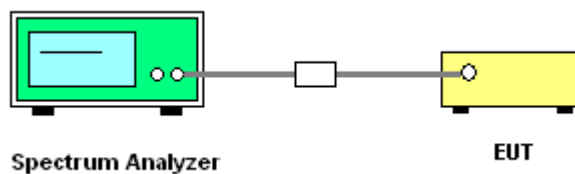

3.3.5. Test Deviation

There is no deviation with the original standard.

3.3.6. EUT Operation during Test

The EUT was programmed to be in continuously transmitting mode.

3.3.7. Test Result of 20dB Spectrum Bandwidth

Test date	Jul. 24, 2008	Test Site No.	TH01-HY
Temperature	28	Humidity	58%
Test Engineer	Tom	Configurations	Channel 1/19/38

Frequency	20dB BW (MHz)	99% OBW (MHz)	Frequency range (MHz) f _L > 2400MHz	Frequency range (MHz) f _H < 2483MHz	Test Result
2404 MHz	2.49	2.65	2402.5900	-	Complies
2440 MHz	2.50	2.73	-	-	Complies
2478 MHz	2.75	2.79	-	2479.3100	Complies

20 dB/99% Bandwidth Plot on 2404 MHz

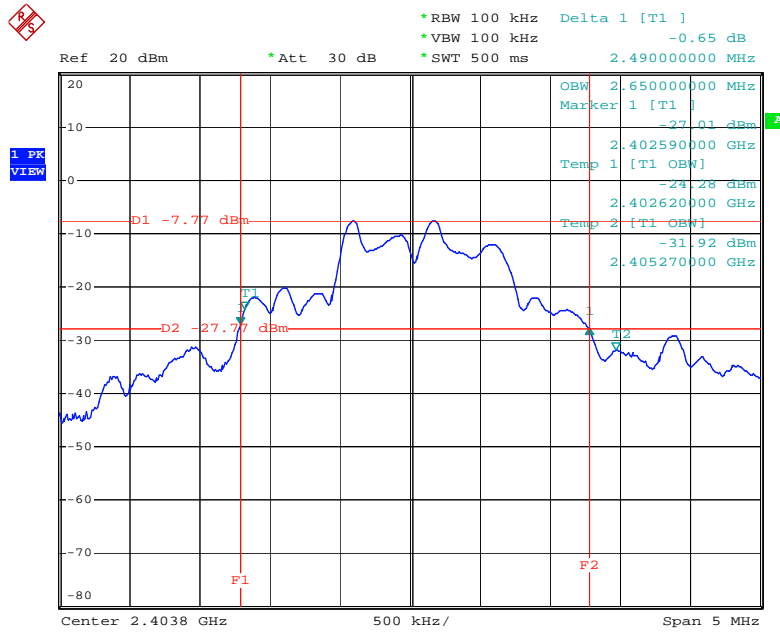

Date: 24.JUL.2008 16:40:28

20 dB/99% Bandwidth Plot on 2440 MHz

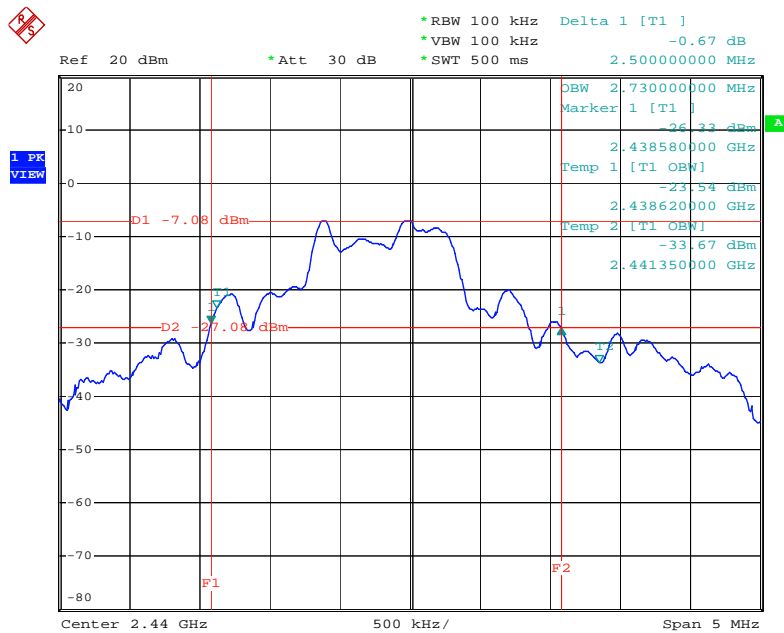

Date: 24.JUL.2008 16:50:03

20 dB/99% Bandwidth Plot on 2478 MHz

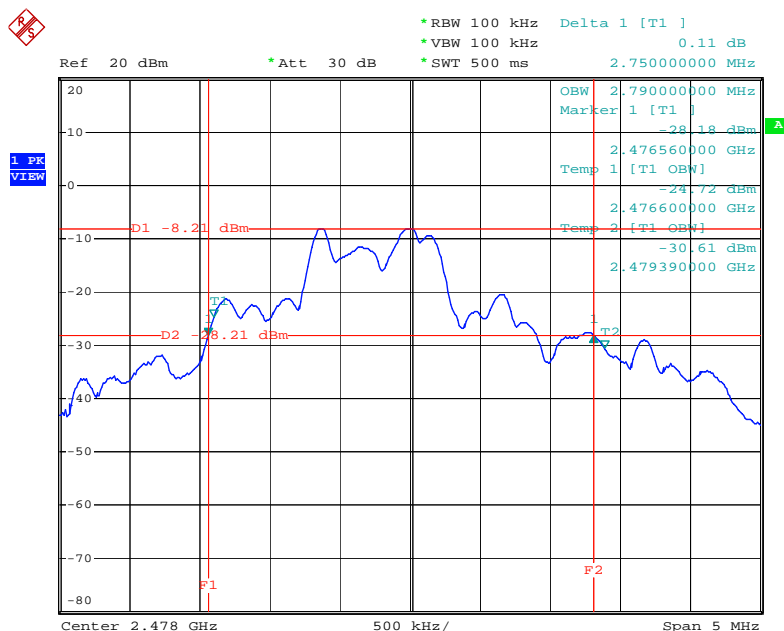

Date: 24.JUL.2008 16:45:34

3.4. Radiated Emissions Measurement

3.4.1. Limit

Harmonic emissions limits comply with below 54 dBuV/m at 3m. Other emissions radiated outside of the specified frequency bands, except for harmonics, shall be attenuated by at least 50 dB below the level of the fundamental or comply with the radiated emissions limits specified in section 15.209(a) limit in the table below has to be followed.

Frequencies (MHz)	Field Strength (micorvolts/meter)	Measurement Distance (meters)
0.009~0.490	2400/F(KHz)	300
0.490~1.705	24000/F(KHz)	30
1.705~30.0	30	30
30~88	100	3
88~216	150	3
216~960	200	3
Above 960	500	3

3.4.2. Measuring Instruments and Setting

Please refer to section 4 of equipments list in this report. The following table is the setting of the spectrum analyzer and receiver.

Spectrum Parameter	Setting
Attenuation	Auto
Start Frequency	1000 MHz
Stop Frequency	10th carrier harmonic
RB / VB	1MHz / 1MHz for Peak, 1 MHz / 10Hz for Average

Receiver Parameter	Setting
Attenuation	Auto
Start ~ Stop Frequency	9kHz~150kHz / RB 200Hz for QP
Start ~ Stop Frequency	150kHz~30MHz / RB 9kHz for QP
Start ~ Stop Frequency	30MHz~1000MHz / RB 120kHz for QP

3.4.3. Test Procedures

1. Configure the EUT according to ANSI C63.4. The EUT was placed on the top of the turntable 0.8 meter above ground. The phase center of the receiving antenna mounted on the top of a height-variable antenna tower was placed 3 meters far away from the turntable.
2. Power on the EUT and all the supporting units. The turntable was rotated by 360 degrees to determine the position of the highest radiation.
3. The height of the broadband receiving antenna was varied between one meter and four meters above ground to find the maximum emissions field strength of both horizontal and vertical polarization.
4. For each suspected emissions, the antenna tower was scan (from 1 M to 4 M) and then the turntable was rotated (from 0 degree to 360 degrees) to find the maximum reading.
5. Set the test-receiver system to Peak or CISPR quasi-peak Detect Function with specified bandwidth under Maximum Hold Mode.
6. For emissions above 1GHz, use 1MHz VBW and RBW for peak reading. Then 1MHz RBW and 10Hz VBW for average reading in spectrum analyzer.
7. When the radiated emissions limits are expressed in terms of the average value of the emissions, and pulsed operation is employed, the measurement field strength shall be determined by averaging over one complete pulse train, including blanking intervals, as long as the pulse train does not exceed 0.1 seconds. As an alternative (provided the transmitter operates for longer than 0.1 seconds) or in cases where the pulse train exceeds 0.1 seconds, the measured field strength shall be determined from the average absolute voltage during a 0.1 second interval during which the field strength is at its maximum value.
8. If the emissions level of the EUT in peak mode was 3 dB lower than the average limit specified, then testing will be stopped and peak values of EUT will be reported, otherwise, the emissions which do not have 3 dB margin will be repeated one by one using the quasi-peak method for below 1GHz.
9. For testing above 1GHz, the emissions level of the EUT in peak mode was lower than average limit (that means the emissions level in peak mode also complies with the limit in average mode), then testing will be stopped and peak values of EUT will be reported, otherwise, the emissions will be measured in average mode again and reported.
10. In case the emission is lower than 30MHz, loop antenna has to be used for measurement and the recorded data should be QP measured by receiver. High – Low scan is not required in this case.

3.4.4. Test Setup Layout

For radiated emissions below 30MHz

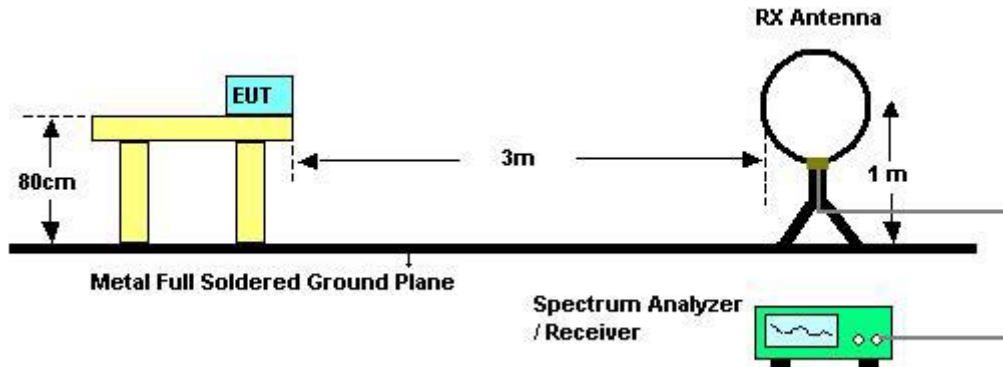

For radiated emissions above 30MHz

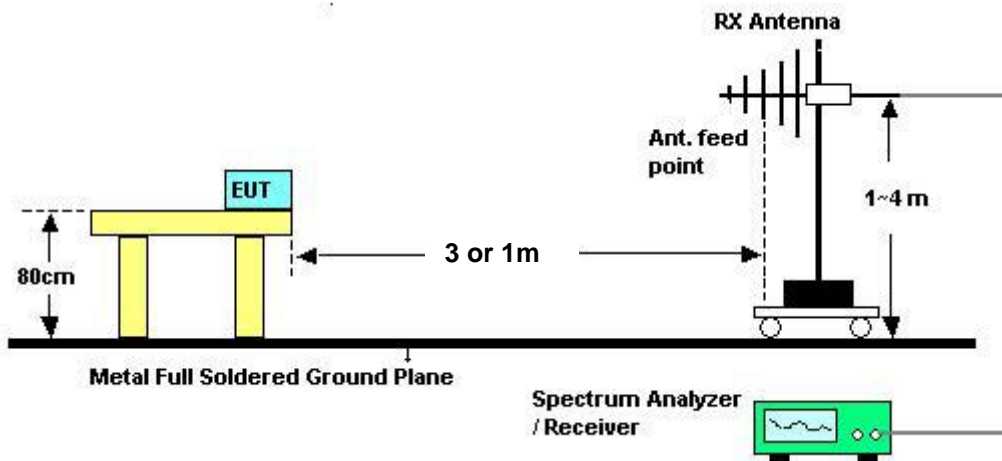

Above 10 GHz shall be extrapolated to the specified distance using an extrapolation factor of 20 dB/decade from 3m to 1m.

Distance extrapolation factor = $20 \log (\text{specific distance [3m]} / \text{test distance [1m]})$ (dB);

Limit line = specific limits (dBuV) + distance extrapolation factor [9.54 dB].

3.4.5. Test Deviation

There is no deviation with the original standard.

3.4.6. EUT Operation during Test

The EUT was programmed to be in continuously transmitting mode.

3.4.7. Results of Radiated Emissions (9kHz~30MHz)

Test date	Jul. 23, 2008	Test Site No.	03CH02-HY
Temperature	28	Humidity	53%
Test Engineer	Eddie		

Freq. (MHz)	Level (dBuV)	Over Limit (dB)	Limit Line (dBuV)	Remark
-	-	-	-	See Note

Note:

The amplitude of spurious emissions which are attenuated by more than 20dB below the permissible value has no need to be reported.

Distance extrapolation factor = $40 \log(\text{specific distance} / \text{test distance})$ (dB);

Limit line = specific limits (dBuV) + distance extrapolation factor.

3.4.8. Results of Radiated Emissions (30MHz~1GHz)

Test date	Jul. 23, 2008	Test Site No.	03CH02-HY
Temperature	28	Humidity	53%
Test Engineer	Eddie	Configurations	Channel 19

Horizontal

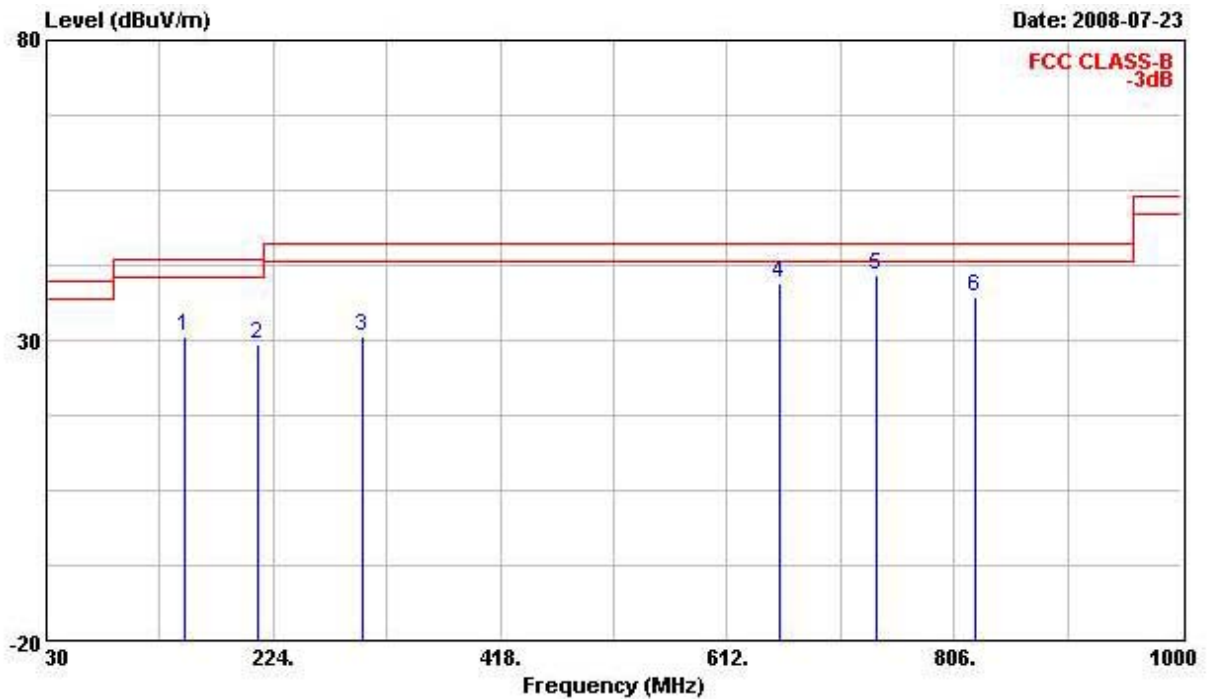

	Freq	Level	Over Limit	Limit Line	ReadAntenna Level	Antenna Factor	Cable Loss	Preamp Factor	Remark
	MHz	dBuV/m	dB	dBuV/m	dBuV	dB/m	dB	dB	
1	148.340	30.81	-12.69	43.50	45.98	10.60	2.15	27.91	Peak
2	211.390	29.32	-14.18	43.50	45.55	9.36	2.56	28.16	Peak
3	299.660	30.75	-15.25	46.00	42.61	13.58	2.94	28.38	Peak
4	657.590	39.63	-6.37	46.00	44.94	19.68	4.52	29.51	Peak
5 @	739.070	40.86	-5.14	46.00	45.25	20.54	4.67	29.61	Peak
6	823.460	37.26	-8.74	46.00	41.08	20.79	4.98	29.60	Peak

Vertical

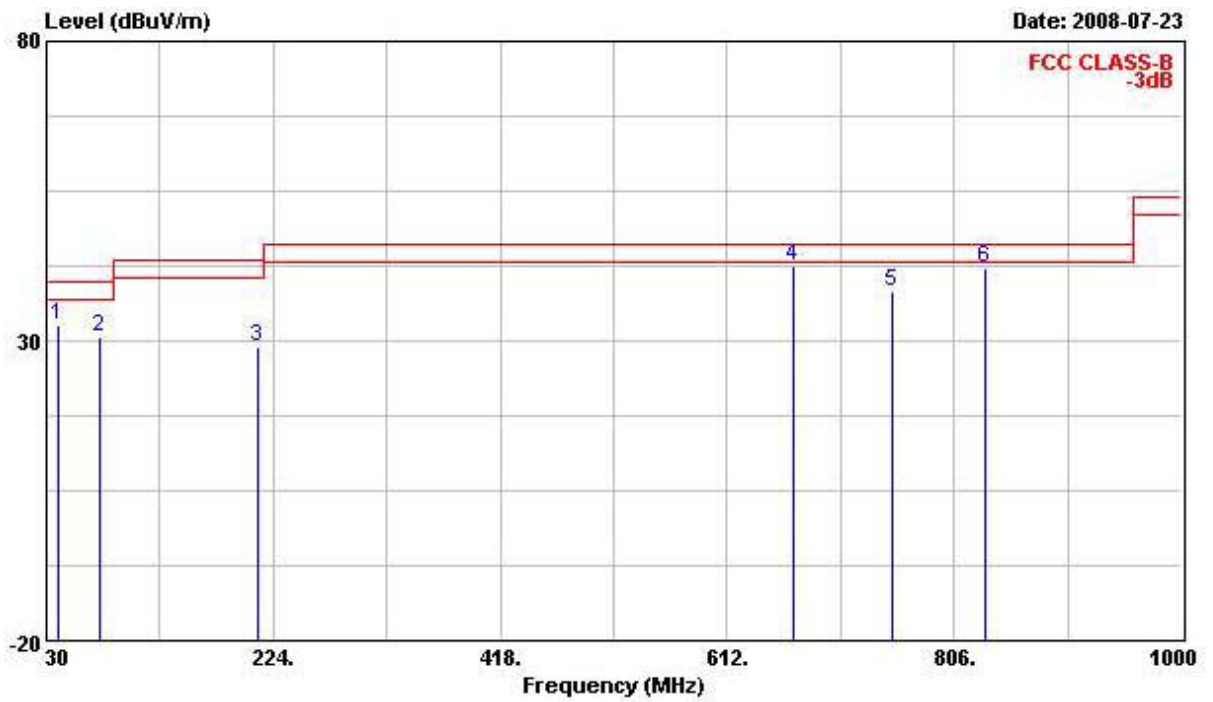

	Freq	Level	Over Limit	Limit Line	ReadAntenna Level	Antenna Factor	Cable Loss	Preamp Factor	Remark
	MHz	dBuV/m	dB	dBuV/m	dBuV	dB/m	dB	dB	
1	40.670	32.53	-7.47	40.00	47.02	12.17	1.09	27.74	Peak
2	75.590	30.53	-9.47	40.00	50.09	6.68	1.51	27.76	Peak
3	211.390	29.15	-14.35	43.50	45.38	9.36	2.56	28.16	Peak
4	668.260	42.43	-3.57	46.00	47.84	19.75	4.40	29.56	Peak
5	753.620	38.08	-7.92	46.00	42.32	20.72	4.63	29.59	Peak
6	832.190	42.25	-3.75	46.00	45.74	20.81	5.04	29.34	Peak

Note:

The amplitude of spurious emissions which are attenuated by more than 20dB below the permissible value has no need to be reported.

Emission level (dBuV/m) = 20 log Emission level (uV/m).

Corrected Reading: Antenna Factor + Cable Loss + Read Level - Preamp Factor = Level.

3.4.9. Results for Radiated Emissions (1GHz~10th Harmonic)

Test date	Jul. 22, 2008	Test Site No.	03CH02-HY
Temperature	28	Humidity	53%
Test Engineer	Eddie	Configurations	Channel 1

Horizontal

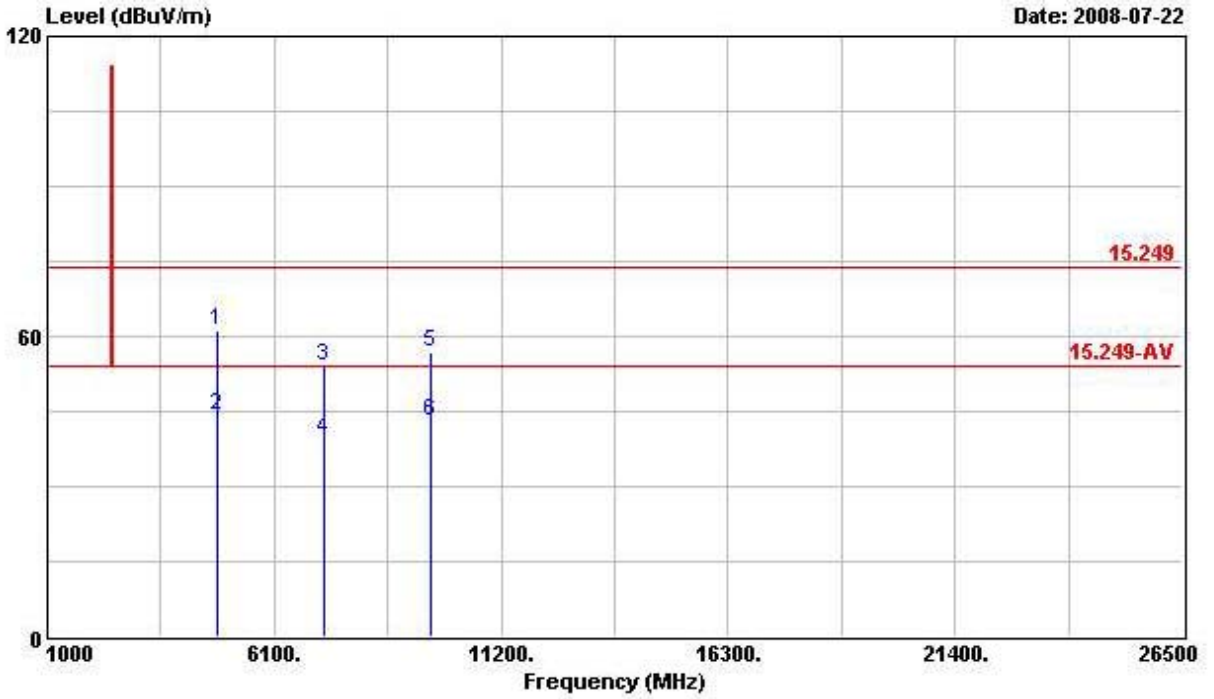

	Freq	Level	Over Limit	Limit Line	ReadAntenna Level	Antenna Factor	Cable Loss	Preamplifier	Remark
	MHz	dBuV/m	dB	dBuV/m	dBuV	dB/m	dB	dB	
1	4807.900	61.04	-12.96	74.00	56.46	33.02	4.03	32.48	PEAK
2	4807.900	44.01	-9.99	54.00	39.44	33.02	4.03	32.48	Average
3	7212.000	54.05	-19.95	74.00	47.61	35.70	3.55	32.80	PEAK
4	7212.000	39.64	-14.36	54.00	33.20	35.70	3.55	32.80	Average
5	9616.000	56.69	-17.31	74.00	46.15	38.34	5.16	32.96	PEAK
6	9616.000	42.99	-11.01	54.00	32.45	38.34	5.16	32.96	Average

Vertical

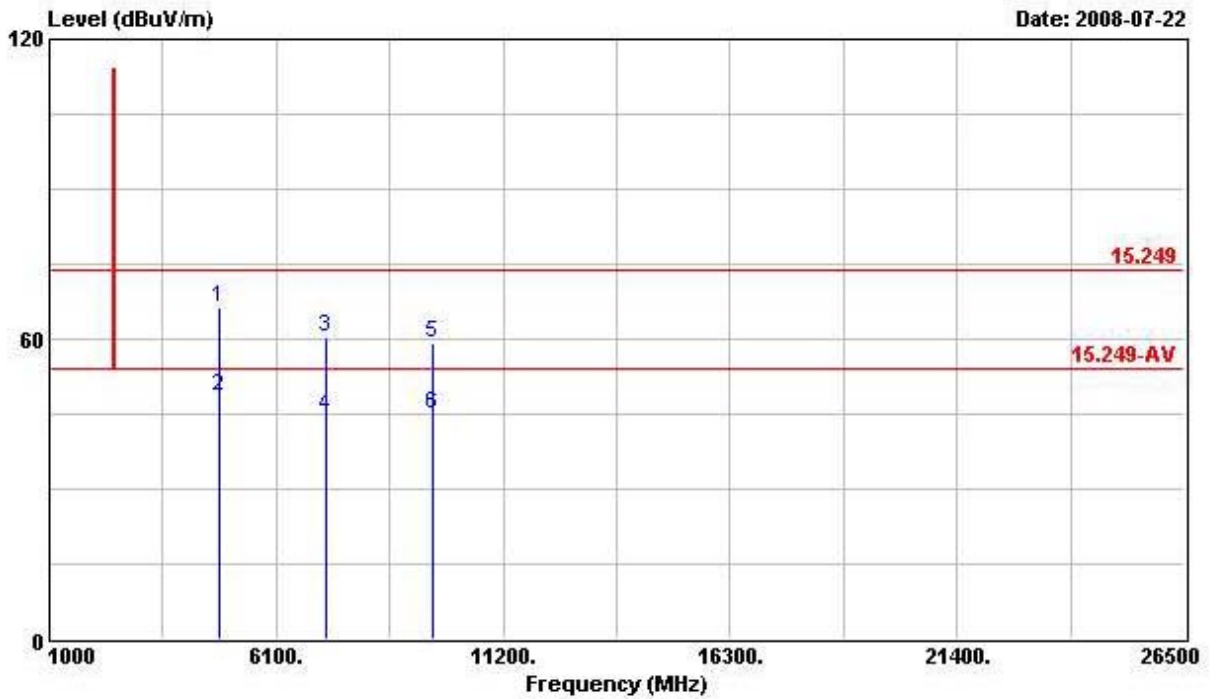

	Freq	Level	Over	Limit	ReadAntenna	Cable	Preamp	Remark
	MHz	dBuV/m	Limit	Line	Level	Loss	Factor	
			dB	dBuV/m	dBuV	dB	dB	
1	4807.960	66.23	-7.77	74.00	61.65	33.02	4.03	32.48 PEAK
2	4807.960	48.73	-5.27	54.00	44.16	33.02	4.03	32.48 Average
3	7208.000	60.22	-13.78	74.00	53.76	35.70	3.55	32.78 PEAK
4	7208.000	44.43	-9.57	54.00	37.97	35.70	3.55	32.78 Average
5	9616.000	59.36	-14.64	74.00	48.82	38.34	5.16	32.96 PEAK
6	9616.000	45.17	-8.83	54.00	34.63	38.34	5.16	32.96 Average

Test date	Jul. 22, 2008	Test Site No.	03CH02-HY
Temperature	28	Humidity	53%
Test Engineer	Eddie	Configurations	Channel 19

Horizontal

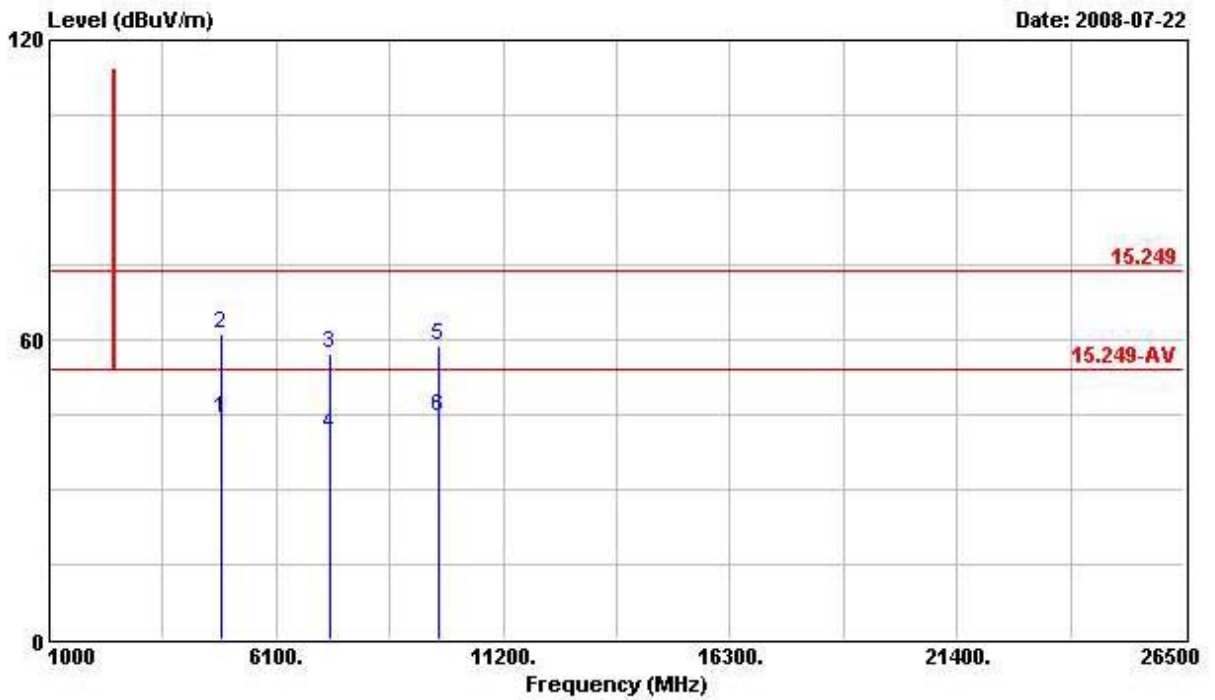

	Freq	Level	Over Limit	Limit Line	ReadAntenna Level	Antenna Factor	Cable Loss	Preamp Factor	Remark
	MHz	dBuV/m	dB	dBuV/m	dBuV	dB/m	dB	dB	
1	4880.000	44.05	-9.95	54.00	39.34	33.16	4.02	32.47	Average
2	4880.000	61.00	-13.00	74.00	56.29	33.16	4.02	32.47	PEAK
3	7317.960	57.36	-16.64	74.00	50.33	35.99	3.91	32.87	PEAK
4	7317.960	40.98	-13.02	54.00	33.95	35.99	3.91	32.87	Average
5	9760.000	58.80	-15.20	74.00	47.73	38.62	5.36	32.92	PEAK
6	9760.000	44.58	-9.42	54.00	33.51	38.62	5.36	32.92	Average

Vertical

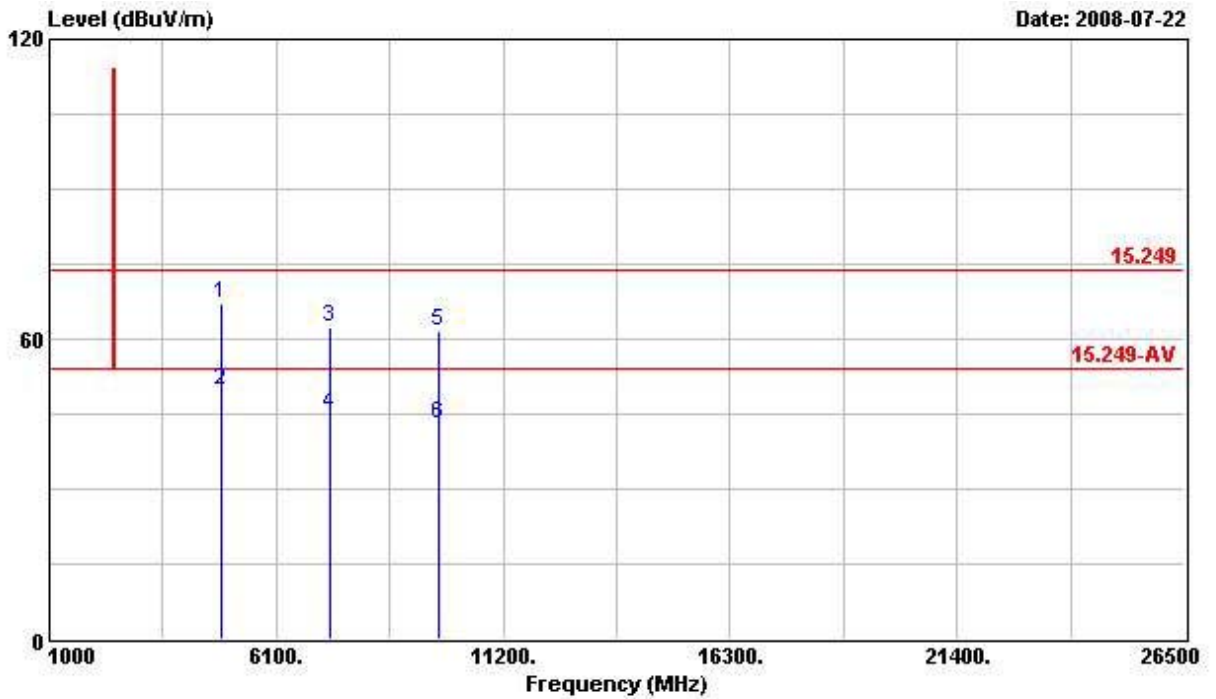

	Freq	Level	Over Limit	Limit Line	ReadAntenna Level	Antenna Factor	Cable Loss	Preamp Factor	Remark
	MHz	dBuV/m	dB	dBuV/m	dBuV	dB/m	dB	dB	
1	4880.000	67.05	-6.95	74.00	62.34	33.16	4.02	32.47	PEAK
2	4880.000	49.64	-4.36	54.00	44.93	33.16	4.02	32.47	Average
3	7318.060	62.30	-11.70	74.00	55.27	35.99	3.91	32.87	PEAK
4	7318.060	44.93	-9.07	54.00	37.90	35.99	3.91	32.87	Average
5	9760.000	61.70	-12.30	74.00	50.63	38.62	5.36	32.92	PEAK
6	9760.000	43.21	-10.79	54.00	32.14	38.62	5.36	32.92	Average

Test date	Jul. 22, 2008	Test Site No.	03CH02-HY
Temperature	28	Humidity	53%
Test Engineer	Eddie	Configurations	Channel 38

Horizontal

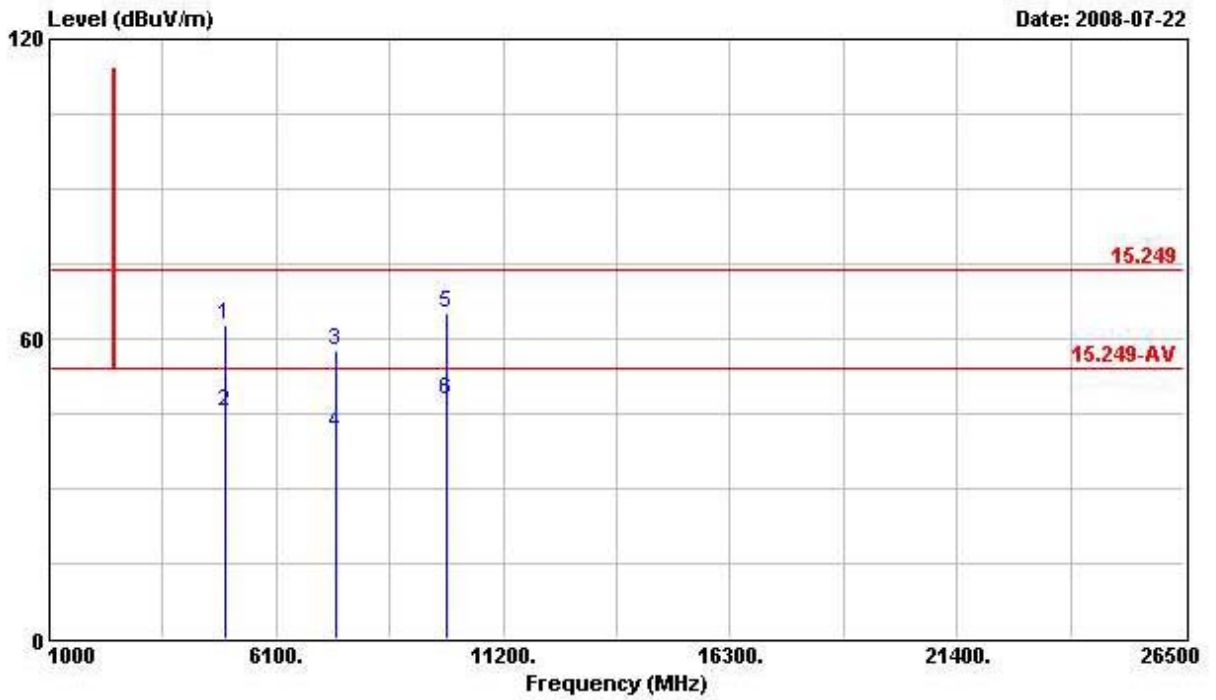

	Freq	Level	Over Limit	Limit Line	ReadAntenna Level	Antenna Factor	Cable Loss	Preamp Factor	Remark
	MHz	dBuV/m	dB	dBuV/m	dBuV	dB/m	dB	dB	
1	4954.760	62.92	-11.08	74.00	58.04	33.33	4.02	32.46	PEAK
2	4954.760	45.46	-8.54	54.00	40.57	33.33	4.02	32.46	Average
3	7432.060	57.64	-16.36	74.00	50.06	36.23	4.28	32.93	PEAK
4	7432.060	40.94	-13.06	54.00	33.36	36.23	4.28	32.93	Average
5	9912.060	65.00	-9.00	74.00	53.38	38.93	5.57	32.88	PEAK
6	9912.060	47.61	-6.39	54.00	35.99	38.93	5.57	32.88	Average

Vertical

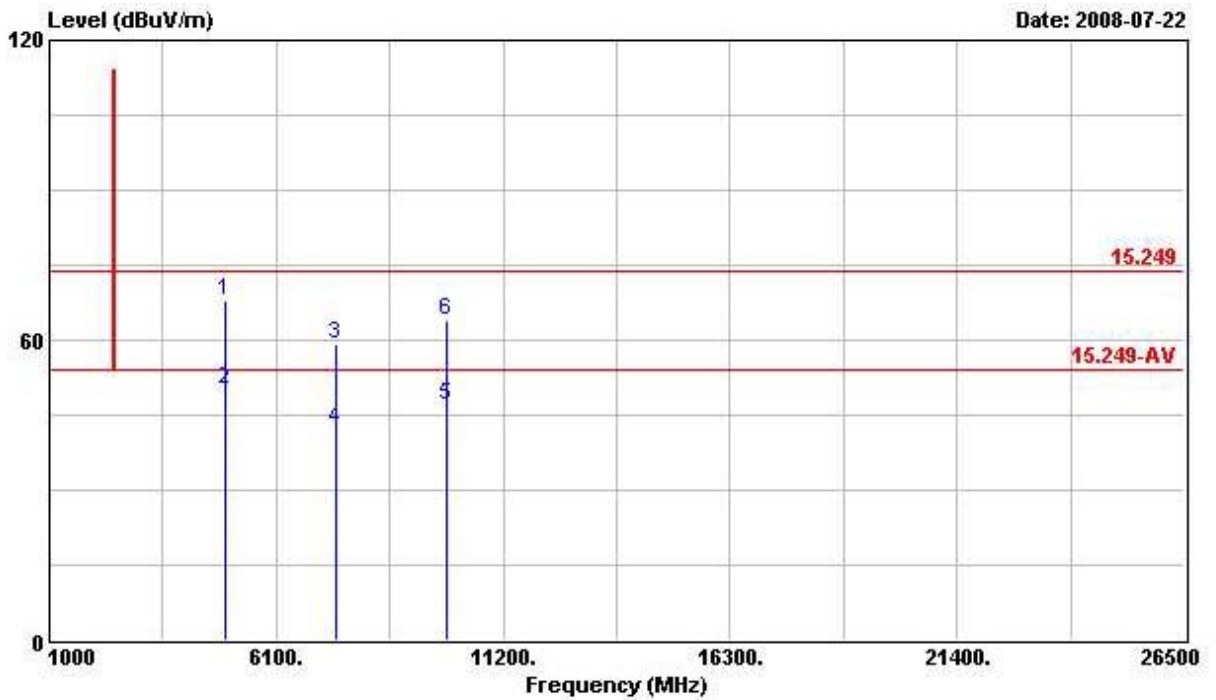

	Freq	Level	Over Limit	Limit Line	ReadAntenna Level	Antenna Factor	Cable Loss	Preamp Factor	Remark
	MHz	dBuV/m	dB	dBuV/m	dBuV	dB/m	dB	dB	
1	4954.680	67.93	-6.07	74.00	63.04	33.33	4.02	32.46	PEAK
2 @	4954.680	49.94	-4.06	54.00	45.05	33.33	4.02	32.46	Average
3	7433.980	59.03	-14.97	74.00	51.45	36.23	4.28	32.93	PEAK
4	7433.980	42.14	-11.86	54.00	34.56	36.23	4.28	32.93	Average
5	9911.960	46.87	-7.13	54.00	35.25	38.93	5.57	32.88	Average
6	9911.960	64.14	-9.86	74.00	52.52	38.93	5.57	32.88	PEAK

Note:

The amplitude of spurious emissions which are attenuated by more than 20dB below the permissible value has no need to be reported.

Emission level (dBuV/m) = 20 log Emission level (uV/m).

Corrected Reading: Antenna Factor + Cable Loss + Read Level - Preamp Factor = Level.

3.5. Band Edge Emissions Measurement

3.5.1. Limit

Band edge emissions radiated outside of the specified frequency bands shall be attenuated by at least 50 dB below the level of the fundamental or comply with the radiated emissions limits specified in section 15.209(a) limit in the table below has to be followed.

Frequencies (MHz)	Field Strength (micровolts/meter)	Measurement Distance (meters)
0.009~0.490	2400/F(KHz)	300
0.490~1.705	24000/F(KHz)	30
1.705~30.0	30	30
30~88	100	3
88~216	150	3
216~960	200	3
Above 960	500	3

3.5.2. Measuring Instruments and Setting

Please refer to section 4 of equipments list in this report. The following table is the setting of the spectrum analyzer.

Spectrum Parameter	Setting
Attenuation	Auto
Span Frequency	100 MHz
RB / VB	1MHz / 1MHz for Peak, 1 MHz / 10Hz for Average

3.5.3. Test Procedures

1. The test procedure is the same as section 3.2.3, only the frequency range investigated is limited to 2MHz around band edges.
2. In case the emission is fail due to the used RB/VB is too wide, marker-delta method of FCC Public Notice DA00-705 will be followed.

3.5.4. Test Setup Layout

This test setup layout is the same as that shown in section 3.2.4.

3.5.5. Test Deviation

There is no deviation with the original standard.

3.5.6. EUT Operation during Test

The EUT was programmed to be in continuously transmitting mode.

3.5.7. Test Result of Band Edge

Test date	Jul. 23, 2008	Test Site No.	03CH02-HY
Temperature	28	Humidity	53%
Test Engineer	Eddie	Configurations	Channel 1, 38

Channel 1

	Freq	Level	Over Limit	Limit Line	ReadAntenna Level	Antenna Factor	Cable Loss	Preamp Factor	Remark
	MHz	dBuV/m	dB	dBuV/m	dBuV	dB/m	dB	dB	
1 @	2390.000	70.29	-3.71	74.00	39.81	28.29	2.19	0.00	Peak
2 @	2400.000	71.49	-2.51	74.00	41.01	28.29	2.19	0.00	Peak
1	2390.000	44.23	-9.77	54.00	13.75	28.29	2.19	0.00	Average
2 @	2400.000	50.65	-3.35	54.00	20.17	28.29	2.19	0.00	Average

Channel 38

	Freq	Level	Over Limit	Limit Line	ReadAntenna Level	Antenna Factor	Cable Loss	Preamp Factor	Remark
	MHz	dBuV/m	dB	dBuV/m	dBuV	dB/m	dB	dB	
2	2483.500	67.91	-6.09	74.00	37.20	28.47	2.25	0.00	Peak
2	2483.500	46.84	-7.16	54.00	16.13	28.47	2.25	0.00	Average

Note:

Emission level (dBuV/m) = 20 log Emission level (uV/m).

Corrected Reading: Antenna Factor + Cable Loss + Read Level - Preamp Factor = Level.

3.6. Antenna Requirements

3.6.1. Limit

Except for special regulations, the Low-power Radio-frequency Devices must not be equipped with any jacket for installing an antenna with extension cable. An intentional radiator shall be designed to ensure that no antenna other than that furnished by the responsible party shall be used with the device. The use of a permanently attached antenna or of an antenna that uses a unique coupling to the intentional radiator shall be considered sufficient to comply with the provisions of this Section. The manufacturer may design the unit so that the user can replace a broken antenna, but the use of a standard antenna jack or electrical connector is prohibited.

3.6.2. Antenna Connector Construction

Please refer to section 2.2 in this test report; antenna connector complied with the requirements.

4. LIST OF MEASURING EQUIPMENTS

Instrument	Manufacturer	Model No.	Serial No.	Characteristics	Calibration Date	Remark
EMC Receiver	R&S	ESCS 30	100174	9kHz – 2.75GHz	Mar. 03, 2008	Conduction (CO04-HY)
LISN	MessTec	NNB-2/16Z	99079	9kHz – 30MHz	Mar. 31, 2008	Conduction (CO04-HY)
LISN (Support Unit)	EMCO	3810/2NM	9703-1839	9kHz – 30MHz	Mar. 22, 2008	Conduction (CO04-HY)
RF Cable-CON	UTIFLEX	3102-26886-4	CB049	9kHz – 30MHz	Apr. 20, 2008	Conduction (CO04-HY)
ISN	SCHAFFNER	ISN T400	21653	9kHz –30MHz	Mar. 27, 2008	Conduction (CO04-HY)
EMI Filter	LINDGREN	LRE-2030	2651	< 450 Hz	N/A	Conduction (CO04-HY)

Note: Calibration Interval of instruments listed above is one year. NCR: Non-Calibration required.

Instrument	Manufacturer	Model No.	Serial No.	Characteristics	Calibration Date	Remark
Spectrum Analyzer	R&S	FSP30	100023	9kHz ~ 30GHz	Jan. 10, 2008	Conducted (TH01-HY)
Power Meter	R&S	NRVS	100444	DC ~ 40GHz	Jul. 11, 2008	Conducted (TH01-HY)
Power Sensor	R&S	NRV-Z51	100458	DC ~ 30GHz	Jul. 11, 2008	Conducted (TH01-HY)
Power Sensor	R&S	NRV-Z32	100057	30MHz ~ 6GHz	Jul. 11, 2008	Conducted (TH01-HY)
DC Power Source	G.W.	GPC-6030D	C671845	DC 1V ~ 60V	Mar. 13, 2008	Conducted (TH01-HY)
Temp. and Humidity Chamber	KSON	THS-C3L	612	N/A	Oct. 01, 2007	Conducted (TH01-HY)
RF CABLE-1m	Jye Bao	RG142	CB034-1m	20MHz ~ 7GHz	Dec. 01, 2007	Conducted (TH01-HY)
RF CABLE-2m	Jye Bao	RG142	CB035-2m	20MHz ~ 1GHz	Dec. 01, 2007	Conducted (TH01-HY)
Vector Signal Generator	R&S	SMU200A	102098	100kHz ~ 6GHz	Nov. 14, 2007	Conducted (TH01-HY)
Signal Generator	R&S	SMR40	100116	10MHz ~ 40GHz	Mar. 10, 2008	Conducted (TH01-HY)

Note: Calibration Interval of instruments listed above is one year.

Instrument	Manufacturer	Model No.	Serial No.	Characteristics	Calibration Date	Remark
AC Power Source	HPC	HPA-500W	HPA-9100024	AC 0 ~ 300V	May 30, 2008*	Conducted (TH01-HY)

Note: Calibration Interval of instruments listed above is two year.

Instrument	Manufacturer	Model No.	Serial No.	Characteristics	Calibration Date	Remark
3m Semi Anechoic Chamber	SIDT FRANKONIA	SAC-3M	03CH02-HY	30 MHz - 1 GHz 3m	May 12, 2008	Radiation (03CH02-HY)
Amplifier	ADVANTEST	BB525C	CH300001	9 kHz - 2 GHz	Dec. 05, 2007	Radiation (03CH02-HY)
Spectrum Analyzer	R&S	FSP40	100305/040	9 kHz - 40GHz	Jan. 10, 2008	Radiation (03CH02-HY)
Bilog Antenna	SCHAFFNER	CBL61128	2723	30 MHz - 2 GHz	Dec. 22, 2007	Radiation (03CH02-HY)
Turn Table	HD	DS 420	420/649/00	0 - 360 degree	N/A	Radiation (03CH02-HY)
Antenna Mast	HD	MA 240	240/559/00	1 m - 4 m	N/A	Radiation (03CH02-HY)
RF Cable-R03m	Jye Bao	RG142	CB020	30 MHz - 1 GHz	Dec. 08, 2007	Radiation (03CH02-HY)
Amplifier	Agilent	8449B	3008A02373	1GHz – 26.5 GHz	Jul. 16, 2008	Radiation (03CH02-HY)
Horn Antenna	EMCO	3115	6903	1GHz~18GHz	Apr. 21, 2008	Radiation (03CH02-HY)
RF Cable-HIGH	SUHNER	SUCOFLEX106	03CH02-HY	1GHz~40GHz	Dec. 12, 2007	Radiation (03CH02-HY)

Note: Calibration Interval of instruments listed above is one year. NCR: Non-Calibration required.

Instrument	Manufacturer	Model No.	Serial No.	Characteristics	Calibration Date	Remark
Loop Antenna	TESEQ	HLA6120	24155	9KHz ~ 30MHz	Jan. 18, 2007*	Radiation (03CH02-HY)

Note: Calibration Interval of instruments listed above is two year.

5. TEST LOCATION

SHIJR	ADD : 6Fl., No. 106, Sec. 1, Shintai 5th Rd., Shijr City, Taipei, Taiwan 221, R.O.C. TEL : 886-2-2696-2468 FAX : 886-2-2696-2255
HWA YA	ADD : No. 52, Hwa Ya 1st Rd., Kwei-Shan Hsiang, Tao Yuan Hsien, Taiwan, R.O.C. TEL : 886-3-327-3456 FAX : 886-3-318-0055
LINKOU	ADD : No. 30-2, Dingfu Tsuen, Linkou Shiang, Taipei, Taiwan 244, R.O.C TEL : 886-2-2601-1640 FAX : 886-2-2601-1695
DUNGHU	ADD : No. 3, Lane 238, Kangle St., Neihu Chiu, Taipei, Taiwan 114, R.O.C. TEL : 886-2-2631-4739 FAX : 886-2-2631-9740
JUNGHE	ADD : 7Fl., No. 758, Jungjeng Rd., Junghe City, Taipei, Taiwan 235, R.O.C. TEL : 886-2-8227-2020 FAX : 886-2-8227-2626
NEIHU	ADD : 4Fl., No. 339, Hsin Hu 2 nd Rd., Taipei 114, Taiwan, R.O.C. TEL : 886-2-2794-8886 FAX : 886-2-2794-9777
JHUBEI	ADD : No.8, Lane 728, Bo-ai St., Jhubei City, HsinChu County 302, Taiwan, R.O.C. TEL : 886-3-656-9065 FAX : 886-3-656-9085

6. TAF CERTIFICATE OF ACCREDITATION



Certificate No. : L1190-090318

財團法人全國認證基金會
Taiwan Accreditation Foundation

Certificate of Accreditation

This is to certify that

Sporton International Inc.
EMC & Wireless Communications Laboratory
No.52, Hwa Ya 1st Rd., Hwa Ya Technology Park, Kwei-Shan Hsiang, Tao Yuan Hsien,
Taiwan, R.O.C.

is accredited in respect of laboratory

Accreditation Criteria	: ISO/IEC 17025:2005
Accreditation Number	: 1190
Originally Accredited	: December 15, 2003
Effective Period	: January 10, 2007 to January 09, 2010
Accredited Scope	: Testing Field, see described in the Appendix
Specific Accreditation Program	: Accreditation Program for Designated Testing Laboratory for Commodities Inspection Accreditation Program for Telecommunication Equipment Testing Laboratory Accreditation Program for BSMI Mutual Recognition Arrangement with Foreign Authorities



Jay-San Chen
President, Taiwan Accreditation Foundation
Date : March 18, 2009

PI, total 19 pages

The Appendix forms an integral part of this Certificate, which shall be invalid when use without the Appendix