

## SPECIFIC ABSORPTION RATE (SAR)

# TEST REPORT

Of

### GSM Mobile Phone

Model Name: HG-A7  
Trade Name: Haier  
Report No.: SZ06120009S01  
FCC ID: SG7200611HG-A7

*prepared for*

### Qingdao Haier Telecom Co., Ltd.

No.1, Haier Road, Hi-tech Zone, Qingdao, 266101, P.R. China

**Shenzhen Electronic Product Quality Testing Center**

**Morlab Laboratory**

3/F, Electronic Testing Building, Shahe Road, Xili,  
Nanshan District, Shenzhen 518055 P. R. China

Tel: +86 755 86130398

Fax: +86 755 86130218



**NOTE:** This test report can be duplicated completely for the legal use with the approval of the applicant, it shall not be reproduced except in full, without the written approval of Shenzhen Electronic Product Quality Testing Center Morlab Laboratory. Any objections should be raised to us within thirty workdays since the date of issue.

### GENERAL SUMMARY

Product Name	GSM Mobile Phone	Development Stage	Identical prototype
Standard(s)	<p><b>47CFR § 2.1093:</b> Radiofrequency Radiation Exposure Evaluation: Portable Devices  <b>FCC OET Bulletin 65 (Edition 97-01), Supplement C (Edition 01-01):</b> Evaluating Compliance with FCC Guidelines for Human Exposure to Radiofrequency Electromagnetic Fields  <b>ANSI C95.1-1999:</b> IEEE Standard for Safety Levels with Respect to Human Exposure to Radio Frequency Electromagnetic Fields, 3 kHz to 300 GHz.  <b>IEEE 1528-2003:</b> Recommended Practice for Determining the Peak Spatial-Average Specific Absorption Rate (SAR) in the Human Body Due to Wireless Communications Devices: Experimental Techniques.</p>		
Conclusion	<p>Localized Specific Absorption Rate (SAR) of this portable wireless equipment has been measured in all cases requested by the relevant standards cited in Clause 5.2 of this test report. Maximum localized SAR is below exposure limits specified in the relevant standards cited in Clause 5.1 of this test report.</p> <p>General Judgment: <b>Pass</b></p> <p style="text-align: right;"><b>Date of issue: Jan 19, 2007</b></p>		
Comment	<p>TX Freq. Band: 824.20 MHz-848.80 MHz(Cellular) 1850.20 MHz-1909.80 MHz(PCS)  RX Freq. Band: 869.20 MHz-893.80 MHz(Cellular) 1930.20 MHz -1989.80 MHz(PCS)  Antenna Character : build inside  The test result only responds to the measured sample.</p>		

Tested by: Li Weili, Date: 2007.01.19

Checked by: Wu Xueshen, Date: 2007.01.19

Approved by: Shu Luan, Date: 2007.01.19



Shu Luan

## Contents

- 1. GENERAL CONDITIONS**
- 2. ADMINISTRATIVE DATA**
  - 2.1. Identification of the Responsible Testing Laboratory
  - 2.2. Identification of the Responsible Testing Location(s)
  - 2.3. Organization Item
  - 2.4. Identification of Applicant
  - 2.5. Identification of Manufacture
- 3. EQUIPMENT UNDER TEST (EUT)**
  - 3.1. Identification of the Equipment under Test
  - 3.2. Identification of all used Test Sample of the Equipment under Test
- 4. OPERATIONAL CONDITIONS DURING TEST**
  - 4.1. Schematic Test Configuration
  - 4.2. SAR Measurement System
- 5. CHARACTERISTICS OF THE TEST**
  - 5.1. Applicable Limit Regulations
  - 5.2. Applicable Measurement Standards
- 6. LABORATORY ENVIRONMENT**
- 7. TEST RESULTS**
  - 7.1. Dielectric Performance
  - 7.2. Summary of Measurement Results
  - 7.3. Conclusion
- 8. MEASUREMENT UNCERTAINTY**
- 9. MAIN TEST INSTRUMENTS**

**This Test Report consists of the following Annexes:**

<p><b>Annex A: Accreditation Certificate</b></p> <p><b>Annex B: Test Layout</b></p> <p><b>Annex C: Sample Photographs</b></p> <p><b>Annex D: Graph Test Results</b></p> <p><b>Annex E: System Performance Check Data</b></p>
--

---

## **1. GENERAL CONDITIONS**

**1.1 This report only refers to the item that has undergone the test.**

**1.2 This report standalone dose not constitute or imply by its own an approval of the product by the certification Bodies or competent Authorities.**

**1.3 This document is only valid if complete; no partial reproduction can be made without written approval of ShenZhen Morlab Communications Technology Co.,Ltd..**

**1.4 This report cannot be used partially or in full for publicity and/or promotional purposes without previous written approval of ShenZhen Morlab Communications Technology Co.,Ltd. and the Accreditation Bodies, if it applies.**



## 2. Administrative Date

### 2.1. Identification of the Responsible Testing Laboratory

**Company Name:** ShenZhen Morlab Communications Technology Co.,Ltd.  
**Department:** Testing Department  
**Address:** 3FI, Electronic Testing Building, ShaHe Road, NanShan District,  
ShenZhen, P. R. China  
**Telephone:** +86-755-86130268  
**Fax:** +86-755-86130218  
**Responsible Test Lab  
Managers:** Mr. Shu Luan

### 2.2. Identification of the Responsible Testing Location(s)

**Company Name:** ShenZhen Morlab Communications Technology Co.,Ltd.  
**Address:** 3FI, Electronic Testing Building, ShaHe Road, NanShan District,  
ShenZhen, P. R. China

### 2.3. Organization Item

**Morlab Report No.:** SZ06120009S01  
**Morlab Project Leader:** Mr. Wu Xuewen  
**Morlab Responsible for  
Accreditation scope:** Mr. Shu Luan  
**Start of Testing:** 2007-01-15  
**End of Testing:** 2007-01-18

### 2.4. Identification of Applicant

**Company Name:** Qingdao Haier Telecom Co., Ltd.  
**Address:** No.1,Haier Road,Hi-tech Zone,Qingdao,266101,P.R.China  
**Contact person:** Xu Jun  
**Telephone:** +86(532)88937356  
**Fax:** +86(532)88939585

### 2.5. Identification of Manufacture

**Company Name:** Qingdao Haier Telecom Co.,Ltd  
**Address:** No.1,Haier Road,Hi-tech Zone,Qingdao,266101,P.R.China  
**Contact person:** Xu Jun  
**Telephone:** +86(532)88937356  
**Fax:** +86(532)88939585

**Notes:** This data is based on the information by the applicant.

### 3. Equipment Under Test (EUT)

#### 3.1. Identification of the Equipment under Test

**Brand Name:** Haier  
**Type Name:** HG-A7  
**Marking Name:** HG-A7  
 Test frequency GSM 850MHz PCS 1900MHz  
 Development Stage Identical prototype  
 Accessories Charger, Battery, Earphone  
 Battery Model H11092  
 Battery specification 3.7V 560mAh  
**General description:** Antenna type Build inside  
 Operation mode Call established  
 Modulation mode GSM; No Bluetooth  
 Max. Power 0.758W (28.8dBm) (GSM 850MHz ERP)  
 0.547W (27.38dBm) (PCS 1900MHz EIRP)

#### 3.2. Identification of all used Test Sample of the Equipment under Test

EUT Code	Serial Number	Hardware Version	Software Version	IMEI
1#	N.A.	H04	030	359832000196744

**NOTE:**

1. The EUT consists of Hand Telephone Set and normal options: Charger, Lithium Battery as listed above.
2. Please refer to Appendix C for the photographs of the EUT. For a more detailed features description about the EUT, please refer to User’s Manual.

## 4 OPERATIONAL CONDITIONS DURING TEST

### 4.1 Schematic Test Configuration

During SAR test, EUT is in Traffic Mode (Channel Allocated) at Normal Voltage Condition. A communication link is set up with a System Simulator (SS) by air link, and a call is established.

The TCH is allocated to 128, 190 and 251 respectively in the case of GSM 850 MHz, or to 512, 661 and 810 respectively in the case of PCS 1900 MHz. The EUT is commanded to operate at maximum transmitting power.

The EUT shall use its internal transmitter. The antenna(s), battery and accessories shall be those specified by the manufacturer. The EUT battery must be fully charged and checked periodically during the test to ascertain uniform power output. If a wireless link is used, the antenna connected to the output of the base station simulator shall be placed at least 50 cm away from the handset.

The signal transmitted by the simulator to the antenna feeding point shall be lower than the output power level of the handset by at least 35 dB.

### 4.2 SAR Measurement System

The SAR measurement system being used is the IndexSAR SARA2 system, which consists of a

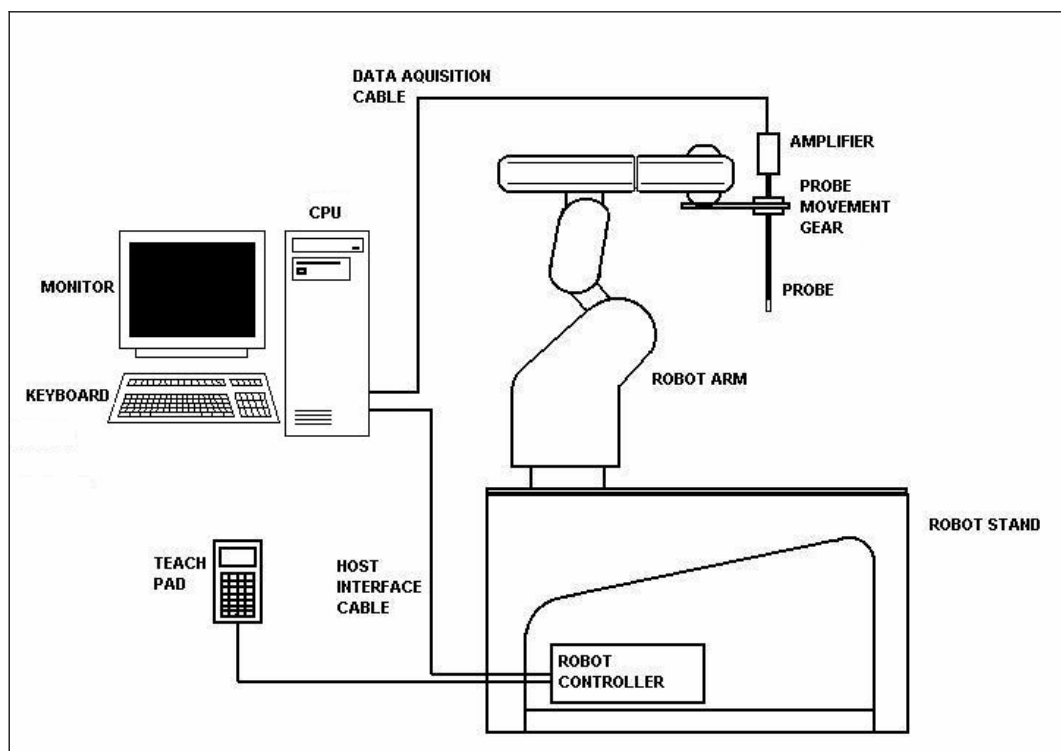

Figure1. SAR Lab Test Measurement Set-up

Mitsubishi RV-E2 6-axis robot arm and controller, IndexSAR probe and amplifier and SAM phantom Head Shape. The system is controlled remotely from a PC, which contains the software to control the robot and data acquisition equipment. The software also displays the data obtained from test scans.

In operation, the system first does an area (2D) scan at a fixed depth within the liquid from the inside wall of the phantom. When the maximum SAR point has been found, the system will then carry out a 3D scan centred at that point to determine volume averaged SAR level.

#### 4.2.1 Robot system specification

The robot is used to articulate the probe to programmed positions inside the phantom head to obtain the SAR readings from the DUT.



##### Robot and Stand

<b>Type</b>	Mitsubishi Movemaster RV-2A / 6 axis vertical articulated robot
<b>Dimensions (robot)</b>	Height: 790mm (in home position)
<b>Dimensions (robot stand)</b>	1010L x 450W x 820H mm
<b>Weight</b>	Approx. 36 kg
<b>Position repeatability</b>	+/- 0.04mm
<b>Drive Method</b>	AC servomotor
<b>Expandability</b>	Extra axis expansion capability for probe calibration applications E-Field probe



##### Robot Controller Unit

<b>Type</b>	CR1 - 571
<b>Dimensions</b>	212W x 290D x 151H mm
<b>Weight</b>	8 kg
<b>Power source</b>	single-phase 100 - 240 VAC

#### 4.2.2 Probe and amplifier specification

##### IXP-050 Indexsar isotropic immersible SAR probe

The probes are constructed using three orthogonal dipole sensors arranged on an interlocking, triangular



prism core. The probes have built-in shielding against static charges and are contained within a PEEK cylindrical enclosure material at the tip (showed in figure 2). The system uses diode compression potential (DCP) to determine SAR values for different types of modulation. Crest factor is not used for determining SAR values. The DCP for different types of modulation is determined during the probe calibration procedure.

<b>E-filed Probe</b>	
<b>Type</b>	Three orthogonal dipole sensors arranged on triangular, interlocking substrates
<b>Dimensions</b>	<b>Overall length:</b> 350mm
	<b>Tip length:</b> 10mm
	<b>Body diameter:</b> 12mm
	<b>Tip diameter:</b> 5mm
<b>Interfacing</b>	Lemo 6 pole latching connector for interfacing to high impedance amplifier
<b>Isotropy</b>	+/- 0.5dB in brain liquids (rotation about probe axis)
	typically +/- 0.15dB
<b>Calibration</b>	+/- 0.5dB in brain liquids (rotation normal to probe axis)
<b>Dynamic Range</b>	Indexasar calibration in brain tissue simulating liquids at frequency of 900MHz, 1800MHz and 1900MHz
<b>Dynamic Range</b>	0.001W/kg to 100W/kg in liquid. Linearity +/- 0.2W/kg

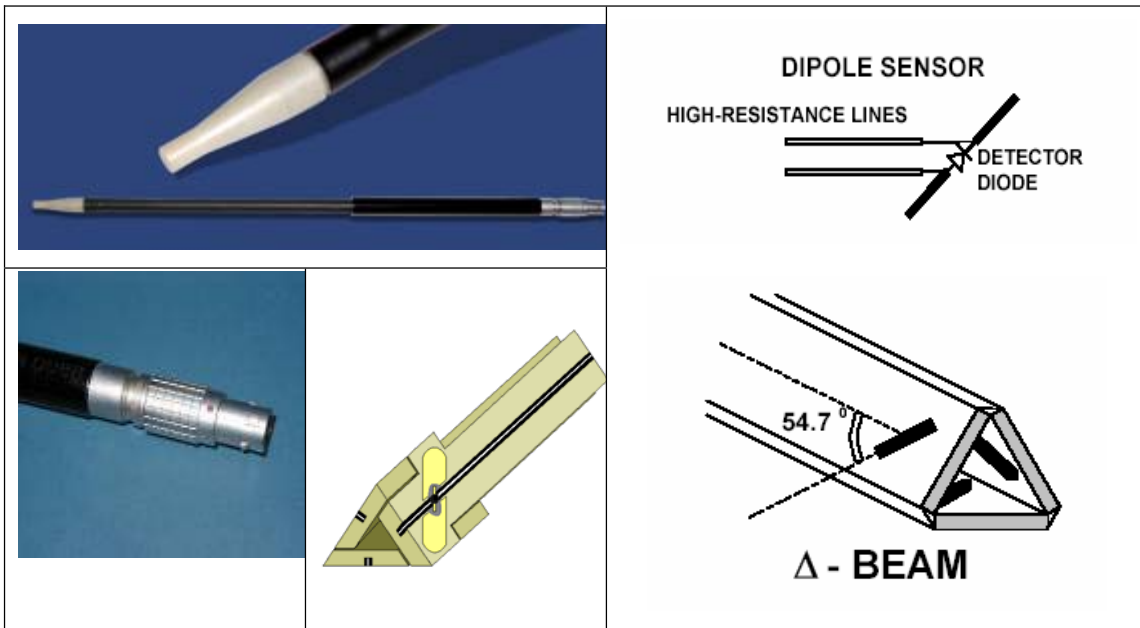
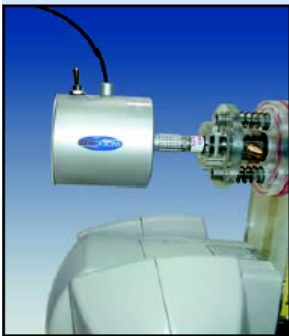

Figure2. Specification and characterisation parameters of indexasar probe

## IFA-010 Amplifier

The amplifier unit has a multi-pole connector to connect to the probe and a multiplexer selects between the 3-channel single-ended inputs. A 16-bit AtoD converter with programmable gain is used along with an on-board micro-controller with non-volatile firmware. Battery life is around 150 hours and data are transferred to the PC via 3m of duplex optical fibre and a self-powered RS232 to optical converter.



### Probe Amplifier and PC Interface

<b>Type</b>	High impedance inputs with 3 independent x,y,z sensor channels giving simultaneous measurement data every 2ms. Reads true average of modulated signals without the need for duty cycle corrections
<b>Ranges</b>	Software selectable of x1 to 63
<b>Cable</b>	Optical cable with self-powered 9 way RS232 converter. 3m cable length supplied as standard. Other lengths to order.
<b>Power Requirements</b>	2 x AAA batteries giving approximately 100 hours usage.

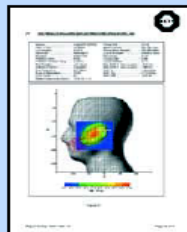

#### 'Word' report format

The results of each frequency scan are presented in a Microsoft 'Word' document with all the necessary measurement parameters automatically tabulated. Users can customise the layout and in some cases language changes are possible.

## 4.2.3 Phantoms and simulant liquid

### 4.2.3.1 SAR head phantom (SAM)

The Indexsar SAM Upright Phantom is fabricated to the shape defined in these CAD files by Antennessa.



### Head Phantom

<b>Type 2</b>	Upright SAM phantom
<b>Dimensions</b>	Height: 320mm Baseplate diameter: 275mm
<b>Weight</b>	empty: 1.2 kg filled: 7.2 kg
<b>Wall thickness</b>	2.0 mm $\pm$ 0.2
<b>Construction</b>	Low loss resin / Strengthened saggital seam

It is mounted on the base table, which holds the robotic positioner. Both mechanical and laser-based

registration systems are utilised to register the phantom position in relationship to the robot co-ordinate system. In the SARA2 implementation, the SAM phantom is mounted on a supporting table made of low dielectric loss material, which includes mounting brackets for DUT positioners, dipole holders and (optionally) a shelf for supporting larger devices like laptop computers.

#### 4.2.3.2 Box phantom

The box phantom used for body testing and for validation is manufactured from Perspex.

### IXB – 070 Specification and characterisation parameters

	<b>Constructional details</b>	
	<b>Internal dimensions:</b>	200mm x 200mm x 200mm
	<b>Thickness of base:</b>	2mm +/- 0.2mm
	<b>Wall thickness:</b>	4mm
	<b>Material:</b>	PMMA
	<b>Frequency range</b>	300MHz – 6GHz
	<b>Dielectric properties</b>	Relative permittivity 2.7 Loss tangent <0.02

**Tissue-simulant volume required for 150mm depth (6 litres)**

#### 4.2.3.3 Simulant liquids

Simulant liquids that are used for testing at frequencies of GSM 850MHz and PCS 1900MHz, which are made mainly of sugar, salt and water solutions may be left in the phantoms. Approximately 7litres are needed for an upright head compared to about 27litres for a horizontal bath phantom.

Ingredients (% by weight )	Frequency(MHz)			
	850		1900	
Tissue Type	Head	Body	Head	Body
Water	40.92	56.0	54.9	40.4
Salt(NaCl)	1.48	0.76	0.18	0.5
Sugar	56.5	41.76	0.0	58.0
HEC	1	1.21	0.0	1.0
Bacterial de	0.0	0.0	0.0	0.1
DGBE	0.0	0.0	44.92	0.0
Acticide SPX	0.1	0.27	0.0	0.0
Dielectric Constant	41.44	52.99	39.9	54.0
Conductivity (S/m)	0.99	1.12	1.42	1.45

### 4.2.4 SAR measurement procedure

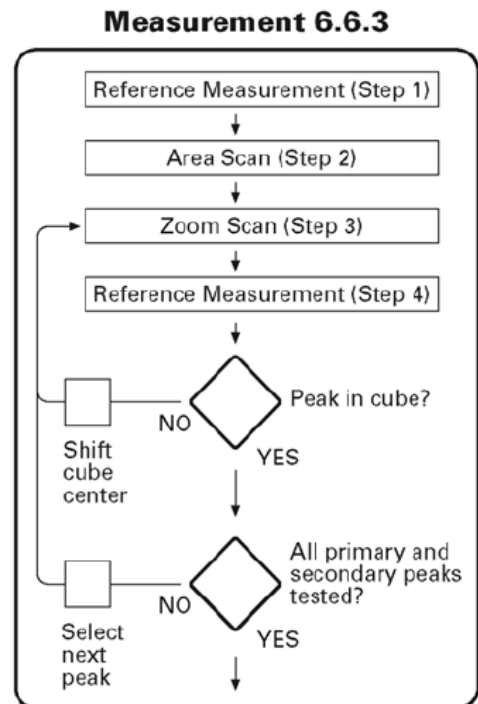
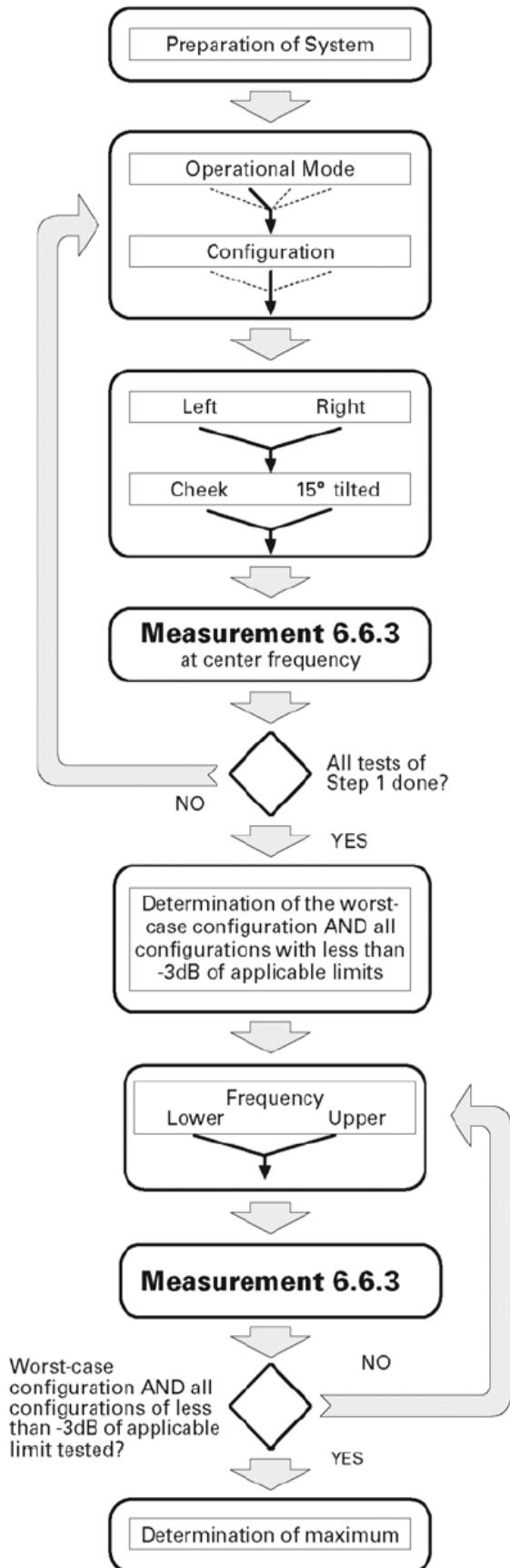

Channel	Left				Right			
	Cheek		Tilt		Cheek		Tilt	
	Retracted	Extended	Retracted	Extended	Retracted	Extended	Retracted	Extended
Mode 1:								
High			S2(-1.4dB)	S2(-0.4dB)			S2(-2.2dB)	S2(-1.4dB)
Middle	S1(-4dB)	S1(-4dB)	S1(-1.5dB)	S1(-0.5dB)	S1(-5dB)	S1(-5dB)	S1(-2.5dB)	S1(-1.5dB)
Low			S2(-1.3dB)	S2(-0.7dB)			S2(-2.7dB)	S2(-0.6dB)
Mode 2:								
High			S2(-2.7dB)	S2(-1.1dB)				
Middle	S1(-5dB)	S1(-5dB)	S1(-2.5dB)	S1(-1dB)	S1(-6dB)	S1(-6dB)	S1(-5dB)	S1(-5dB)
Low			S2(-2.2dB)	S2(-0.8dB)				

After an area scan has been done at a fixed distance of 8mm from the surface of the phantom on the source side, a 3D scan is set up around the location of the maximum spot SAR. First, a point within the scan area is visited by the probe and a SAR reading taken at the start of testing. At the end of testing, the probe is returned to the same point and a second reading is taken. Comparison between these start and end readings enables the power drift during measurement to be assessed.

Above is the scanning procedure flow chart and table from the IEEE p1528 standard. This is the procedure for which all compliant testing should be carried out to ensure that all variations of the device position and transmission behaviour are tested.

#### 4.2.5 Validation testing using box phantoms

The following procedure, recommended for performing validation tests using box phantoms is based on the procedures described in the draft IEEE standard P1528. Setup according to the setup diagram below :

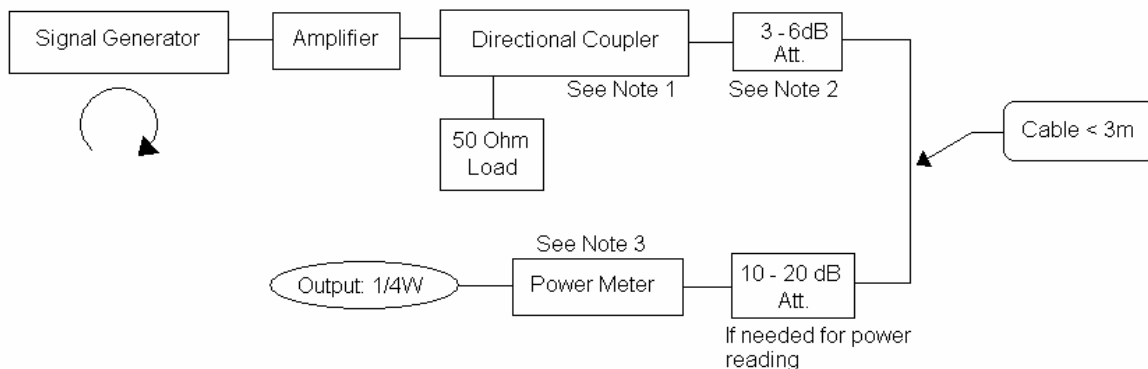

With the SG and Amp and with directional coupler in place, set up the source signal at the relevant

frequency and use a power meter to measure the power at the end of the SMA cable that you intend to connect to the balanced dipole. Adjust the SG to make this, say, 0.25W (24 dBm). If this level is too high to read directly with the power meter sensor, insert a calibrated attenuator (e.g. 10 or 20 dB) and make a suitable correction to the power meter reading.

Note 1: In this method, the directional coupler is used for monitoring rather than setting the exact feed power level. If, however, the directional coupler is used for power measurement, you should check the frequency range and power rating of the coupler and measure the coupling factor (referred to output) at the test frequency using a VNA.

Note 2: Remember that the use of a 3dB attenuator (as shown in Figure 8.1 of P1528) means that you need an RF amplifier of 2 times greater power for the same feed power. The other issue is the cable length. You might get up to 1dB of loss per meter of cable, so the cable length after the coupler needs to be quite short.

Note 3: For the validation testing done using CW signals, most power meters are suitable. However, if you are measuring the output of a modulated signal from either a signal generator or a handset, you must ensure that the power meter correctly reads the modulated signals.

**4.2.5.1 Setting up the box phantom for validation testing**

The main purpose of the box phantom is for validation of the system. By placing the box phantom in place of the upright head, using the box phantom dipole holder the system can now be used to check that the probe and software are giving accurate readings.

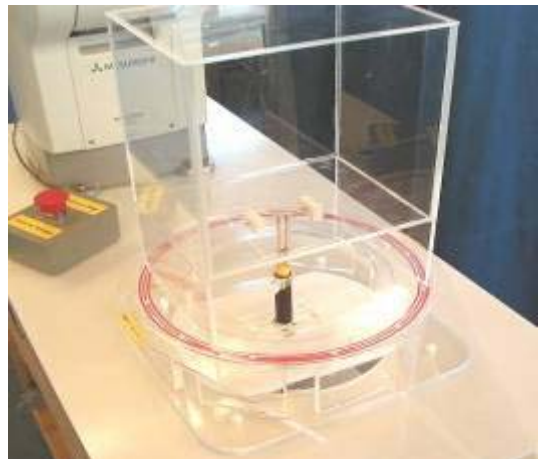

**4.2.5.2 Equipments and results of validation testing**

Equipments :

name	Type and specification
Signal generator	SML02
Directional coupler	450MHz-3GHz
Amplifier	3W 502(10-2500MHz)
Reference dipole	IXD-080 validation dipole
	IXD-090 validation dipole

Results:

Frequency	Date	Target value(1g) W/kg	Test value(1g) W/kg	
			Head	Body
850MHz	2007.01.15	10.8	10.608 (Head)	10.468 (Body)
1900MHz	2007.01.16	39.7	40.452 (Head)	40.368 (Body)

#### **4.2.6 SARA2 Interpolation and Extrapolation schemes**

SARA2 software contains support for both 2D cubic B-spline interpolation as well as 3D cubic B-spline interpolation. In addition, for extrapolation purposes, a general n-th order polynomial fitting routine is implemented following a singular value decomposition algorithm. A 4th order polynomial fit is used by default for data extrapolation, but a linear-logarithmic fitting function can be selected as an option. The polynomial fitting procedures have been tested by comparing the fitting coefficients generated by the SARA2 procedures with those obtained using the polynomial fit functions of Microsoft Excel when applied to the same test input data.

#### **4.2.7 Interpolation of 2D area scan**

The 2D cubic B-spline interpolation is used after the initial area scan at fixed distance from the phantom shell wall. The initial scan data are collected with approx. 10mm spatial resolution and spline interpolation is used to find the location of the local maximum to within a 1mm resolution for positioning the subsequent 3D scanning.

#### **4.2.8 Extrapolation of 3D scan**

For the 3D scan, data are collected on a spatially regular 3D grid having (by default) 6.4 mm steps in the lateral dimensions and 3.5 mm steps in the depth direction (away from the source). SARA2 enables full control over the selection of alternative step sizes in all directions.

The digitised shape of the head is available to the SARA2 software, which decides which points in the 3D array are sufficiently well within the shell wall to be 'visited' by the SAR probe. After the data collection, the data are extrapolated in the depth direction to assign values to points in the 3D array closer to the shell wall. A notional extrapolation value is also assigned to the first point outside the shell wall so that subsequent interpolation schemes will be applicable right up to the shell wall boundary.

#### **4.2.9 Interpolation of 3D scan and volume averaging**

The procedure used for defining the shape of the volumes used for SAR averaging in the SARA2 software follow the method of adapting the surface of the 'cube' to conform with the curved inner surface of the phantom. This is called, here, the conformal scheme.

For each row of data in the depth direction, the data are extrapolated and interpolated to less than 1mm spacing and average values are calculated from the phantom surface for the row of data over distances corresponding to the requisite depth for 10g and 1g cubes. This results in two 2D arrays of data, which

are then cubic B-spline interpolated to sub mm lateral resolution. A search routine then moves an averaging square around through the 2D array and records the maximum value of the corresponding 1g and 10g volume averages. For the definition of the surface in this procedure, the digitized position of the head shell surface is used for measurement in head-shaped phantoms. For measurements in rectangular, box phantoms, the distance between the phantom wall and the closest set of gridded data points is entered into the software. For measurements in box-shaped phantoms, this distance is under the control of the user. The effective distance must be greater than 2.5mm as this is the tip-sensor distance and to avoid interface proximity effects, it should be at least 5mm. A value of 6 or 8mm is recommended. This distance is called **dbe**.

For automated measurements inside the head, the distance cannot be less than 2.5mm, which is the radius of the probe tip and to avoid interface proximity effects, a minimum clearance distance of  $x$  mm is retained. The actual value of **dbe** will vary from point to point depending upon how the spatially regular 3D grid points fit within the shell. The greatest separation is when a grid point is just not visited due to the probe tip dimensions. In this case the distance could be as large as the step-size plus the minimum clearance distance (i.e with  $x=5$  and a step size of 3.5, **dbe** will be between 3.5 and 8.5mm).

The default step size (**dstep**) used is 3.5mm, but this is under user-control. The compromise is with time of scan, so it is not practical to make it much smaller or scan times become long and power-drop influences become larger.

The robot positioning system specification for the repeatability of the positioning (**dss**) is  $\pm 0.04$ mm.

The phantom shell is made by an industrial moulding process from the CAD files of the SAM shape, with both internal and external moulds. For the upright phantoms, the external shape is subsequently digitized on a Mitutoyo CMM machine (Euro an ultrasonic sensor indicate that the shell thickness (**dph**) away from the ear is  $2.0 \pm 0.1$ mm. The ultrasonic measurements were calibrated using additional mechanical measurements on available cut surfaces of the phantom shells. See support document IXS-020x.

For the upright phantom, the alignment is based upon registration of the rotation axis of the phantom on its 253mm diameter baseplate bearing and the position of the probe axis when commanded to go to the axial position. A laser alignment tool is provided (procedure detailed elsewhere). This enables the registration of the phantom tip (**dmis**) to be assured to within approx. 0.2mm. This alignment is done with reference to the actual probe tip after installation and probe alignment. The rotational positioning of the phantom is variable – offering advantages for special studies, but locating pins ensure accurate



repositioning at the principal positions (LH and RH ears).

#### **4.2.10 Probe anisotropy and boundary proximity influence correction software (Virtual Probe Miniaturization VPM software)**

Indexsar Report IXS0223 provides a background to the factors affecting measurements at high frequencies when using SAR probes of size 8 – 5mm tip diameter. Although the Indexsar probes are at the smaller end of this range, SAR probes are not isotropic in 5GHz phantom field gradients and ad

1) At >5GHz, the SAR field decays to 1/e of its value within 3-4mm of the surface of a phantom with a source adjacent. So, measurements are significantly affected by small errors in the separation distances employed between the probe and the phantom surface. The distance between the probe tip and the plane of the sensors should be allowed for using the same value as that declared in the probe calibration document. Distances between the probe tip and phantom surface should be measured accurately to 0.1mm. The best way to assure this is to use the robot to position the probe in light contact with the phantom wall and then to withdraw the probe by the selected amount under robot control.

2) The preferred test geometry at 5GHz is for testing at the bottom of an open phantom. If tests at the side of a phantom are performed, it will be necessary to apply VPM corrections as described below. In either case, careful monitoring of probe spacing from the phantom is required. Probe isotropy is improved for measuring fields polarized either normal to or parallel to the probe axis. If the source polarization is known, this arrangement should be established, if possible.

3) The probe calibration factors including boundary correction terms should be carefully entered from the calibration document. The probe calibration factors require that the probe be oriented in a known rotational position. The red spot on the Indexsar probe should be aligned facing away from the robot arm.

4) The latest SARA2 software (VPM editions) contain support for correcting for probe anisotropy in strong field gradients and include a procedure for correcting for boundary proximity influences. As noted above, the probe has to be oriented in a given rotational position and some familiarity with the new measurement procedures is necessary. The calculations can be performed either with or without the extended correction schemes applied.

5) If boundary corrections are used, it may be preferable to go rather closer to the phantom surface than is usually recommended and to perform scans using small steps between the measurement planes so that good data on the SAR profiles are collected within the first 10mm of the phantom depth.



## 5 CHARACTERISTICS OF THE TEST

### 5.1 Applicable Limit Regulations

**47CFR § 2.1093:** Radiofrequency Radiation Exposure Evaluation: Portable Devices

**FCC OET Bulletin 65(Edition 97-01), Supplement C(Edition 01-01):** Evaluating Compliance with FCC Guidelines for Human Exposure to Radiofrequency Electromagnetic Fields

**ANSI C95.1–1999:** IEEE Standard for Safety Levels with Respect to Human Exposure to Radio Frequency Electromagnetic Fields, 3 kHz to 300 GHz.

It specifies the maximum exposure limit of **1.6 W/kg** as averaged over any 1 gram of tissue for portable devices being used within 20 cm of the user in the uncontrolled environment.

### 5.2 Applicable Measurement Standards

**IEEE 1528–2003:** Recommended Practice for Determining the Peak Spatial-Average Specific Absorption Rate (SAR) in the Human Body Due to Wireless Communications Devices: Experimental Techniques.

They specify the measurement method for demonstration of compliance with the SAR limits for such equipments.

## 6 LABORATORY ENVIRONMENT

**Table: The Ambient Conditions during SAR Test**

Temperature	Min. = 15 ° C, Max. = 30 ° C
Relative humidity	Min. = 30%, Max. = 70%
Ground system resistance	< 0.5 Ω
Ambient noise is checked and found very low and in compliance with requirement of standards. Reflection of surrounding objects is minimized and in compliance with requirement of standards.	

## 7 TEST RESULTS

### 7.1 Dielectric Performance

The measured 1-gram averaged SAR values of the device against the head and the body are provided in Tables 1 and 2 respectively. The humidity and ambient temperature of test facility were 54% ~60% and 23.0 °C ~23.9°C respectively. The SAM head phantom (SN 0380 SH and SN 0381 SH) were full of the head tissue simulating liquid. The depth of the body tissue was 15.1cm. The distance between the back of the device and the bottom of the flat phantom is 1.5cm. A base station simulator was used to control the device during the SAR measurement. The phone was supplied with full-charged battery for each measurement.

For head measurement, the device was tested at the lowest, middle and highest frequencies in the transmit band.

**Table 1: Dielectric Performance of Head Tissue Simulating Liquid**

Temperature: 23.0~23.9° C, humidity: 54~60%.			
/	Frequency	Permittivity $\epsilon$	Conductivity $\sigma$ (S/m)
<b>Target value</b>	850 MHZ	41.5	0.97
<b>Validation value</b> (Jan 15)	850 MHZ	41.58	0.902
<b>Target value</b>	1900 MHz	40.0	1.40
<b>Validation value</b> (Jan 16)	1900 MHz	40.12	1.394

For body-worn measurements, the device was tested against flat phantom representing the user body. Under measurement phone was put on in the belt holder.

**Table 2: Dielectric Performance of Body Tissue Simulating Liquid**

Temperature: 23.0~23.9° C, humidity: 54~60%.			
/	Frequency	Permittivity $\epsilon$	Conductivity $\sigma$ (S/m)
<b>Target value</b>	850 MHz	55.0	1.05
<b>Validation value</b> (Jan 15)	850 MHz	55.47	0.972
<b>Target value</b>	1900 MHz	53.3	1.52
<b>Validation value</b> (Jan 16)	1900 MHz	54.13	1.526

## 7.2 Summary of Measurement Results (GSM 850MHz and PCS 1900 MHz Band)

Table 3: SAR Values (GSM 850 MHz Band), Measured against the head.

Temperature: 23.0 °C ~24.8°C, humidity: 53~59%.		
Limit of SAR (W/kg)	1 g Average	
	1.6	
Test Case	Measurement Result (W/kg)	
	1 g Average (W/kg)	Power level (dBm)
Left head, Touch cheek, Bottom Channel	0.451	32.81
Left head, Touch cheek, Mid Channel	0.522	33.15
Left head, Touch cheek, Top Channel	0.553	33.23
Left head, Tilt 15 Degree, Bottom Channel	0.256	32.81
Left head, Tilt 15 Degree, Mid Channel	0.253	33.15
Left head, Tilt 15 Degree, Top Channel	0.302	33.23
Right head, Touch cheek, Bottom Channel	0.452	32.81
Right head, Touch cheek, Mid Channel	0.482	33.15
Right head, Touch cheek, Top Channel	0.606	33.23
Right head, Tilt 15 Degree, Bottom Channel	0.319	32.81
Right head, Tilt 15 Degree, Mid Channel	0.395	33.15
Right head, Tilt 15 Degree, Top Channel	0.506	33.23

Table 4: SAR Values (PCS 1900MHz Band), Measured against the head.

Temperature: 23.0 °C ~24.8°C, humidity: 52~59%.		
Limit of SAR (W/kg)	1 g Average	
	1.6	
Test Case	Measurement Result (W/kg)	
	1 g Average (W/kg)	Power level (dBm)
Left head, Touch cheek, Bottom Channel	0.427	30.34
Left head, Touch cheek, Mid Channel	0.375	30.35
Left head, Touch cheek, Top Channel	0.380	30.55
Left head, Tilt 15 Degree, Bottom Channel	0.078	30.34
Left head, Tilt 15 Degree, Mid Channel	0.079	30.35
Left head, Tilt 15 Degree, Top Channel	0.050	30.55
Right head, Touch cheek, Bottom Channel	0.618	30.34
Right head, Touch cheek, Mid Channel	0.511	30.35
Right head, Touch cheek, Top Channel	0.206	30.55
Right head, Tilt 15 Degree, Bottom Channel	0.117	30.34
Right head, Tilt 15 Degree, Mid Channel	0.099	30.35
Right head, Tilt 15 Degree, Top Channel	0.052	30.55



**Table 5: SAR Values (GSM 850 MHz Band), Measured against the body**

Temperature: 23.0 °C ~23.8°C, humidity: 48~58%.		
Limit of SAR (W/kg)	1 g Average	
	1.6	
Test Case	Measurement Result (W/kg)	
	1 g Average (W/kg)	Power level (dBm)
Side, Bottom Channel	0.179	32.81
Side, Mid Channel	0.188	33.15
Side, Top Channel	0.223	33.23
Side, Top Channel(with headphone)	0.292	33.23
Side, Top Channel(face to bottom)	0.343	33.23

**Table 7: SAR Values (PCS1900 MHz Band), Measured against the body**

Temperature: 21.0~21.9° C, humidity: 48~58%.		
Limit of SAR (W/kg)	1 g Average	
	1.6	
Test Case	Measurement Result (W/kg)	
	1 g Average (W/kg)	Power level (dBm)
Side, Bottom Channel	0.218	30.34
Side, Mid Channel	0.212	30.35
Side , Top Channel	0.128	30.55
Side, Bottom Channel(with headphone)	0.352	30.34
Side , Bottom Channel(face to bottom)	0.280	30.34

### 7.3 Conclusion

Localized Specific Absorption Rate (SAR) of this portable wireless device has been measured in all cases requested by the relevant standards cited in Clause 5.2 of this report. Maximum localized SAR is **below** exposure limits specified in the relevant standards cited in Clause 5.1 of this test report.

## 8 Measurement Uncertainty

No	Uncertainty Component	Type	Uncertainty Value (%)	Probability Distribution	k	$c_i$	Standard Uncertainty (%) $u_i(\%)$	Degree of freedom $V_{eff}$ or $v_i$
<b>Measurement System</b>								
1	–Probe Calibration	B	3.6	N	1	1	3.60	$\infty$
2	–Axial isotropy	B	4.23	R	$\sqrt{3}$	$\sqrt{1-cp}$	0.00	$\infty$
3	–Hemispherical Isotropy	B	10.7	R	$\sqrt{3}$	$\sqrt{cp}$	6.18	$\infty$
4	–Boundary Effect	B	1.7	R	$\sqrt{3}$	1	0.98	$\infty$
5	–Linearity	B	2.98	R	$\sqrt{3}$	1	1.69	$\infty$
6	–System Detection Limits	B	1.00	R	$\sqrt{3}$	1	0.60	$\infty$
7	–Readout Electronics	B	1.00	N	1	1	1.00	$\infty$
8	–Response Time	B	0.80	R	$\sqrt{3}$	1	0.50	$\infty$
9	–Integration Time	B	2.60	R	$\sqrt{3}$	1	1.50	$\infty$
10	–RF Ambient Conditions	B	3.00	R	$\sqrt{3}$	1	1.70	$\infty$
11	–Probe Position Mechanical tolerance	B	1.14	R	$\sqrt{3}$	1	0.33	$\infty$
12	–Probe Position with respect to Phantom Shell	B	2.86	R	$\sqrt{3}$	1	0.83	$\infty$
13	–Extrapolation, Interpolation and Integration Algorithms for Max. SAR evaluation	B	3.6	R	$\sqrt{3}$	1	2.08	$\infty$
<b>Uncertainties of the DUT</b>								
14	–Position of the DUT	A	2.90	N	1	1	2.90	0
15	–Holder of the DUT	A	3.60	N	1	1	3.60	0
16	–Output Power Variation – SAR drift measurement	B	5.0	R	$\sqrt{3}$	1	2.89	$\infty$



Phantom and Tissue Parameters								
17	–Phantom Uncertainty(shape and thickness tolerances)	B	1.43	R	$\sqrt{3}$	1	0.83	$\infty$
18	–Liquid Conductivity Target – tolerance	B	5.0	R	$\sqrt{3}$	0.7	2.02	$\infty$
19	–Liquid Conductivity – measurement Uncertainty)	B	2.0	R	$\sqrt{3}$	0.7	0.81	$\infty$
20	–Liquid Permittivity Target tolerance	B	5.0	R	$\sqrt{3}$	0.6	1.73	$\infty$
21	–Liquid Permittivity – measurement uncertainty	B	1.0	R	$\sqrt{3}$	0.6	0.35	$\infty$
<b>Combined Standard Uncertainty</b>				RSS			±8.95%	
<b>Expanded uncertainty</b> (Confidence interval of 95 %)				K=	2.003935		±17.9%	

## 9 MAIN TEST INSTRUMENTS

No.	EQUIPMENT	TYPE	Due Date
1	E-Field SAR Probe	IXP-050 (SN 0177)	2007-03-28
2	Six-axis AC Servo industrial robot	RV-2A (SN AN406018)	2007-03-28
3	Mobile Phone Tester	4405 (SN 0811211)	2007-03-28
4	System Validation Dipole 2450MHZ	IXD-245 (SN 0104)	2007-03-28
5	System Validation Dipole 1900MHZ	IXD-080 (SN 0112)	2007-03-28
6	System Validation Dipole 850MHZ	IXD-090 (SN 0093)	2007-03-28
7	Probe Amplifier and PC Interface	IFA-010 (SN 0027)	2007-03-28
8	SAM Head Phantom	SN 0380 SH	2007-03-28
9	SAM Head Phantom	SN 0381 SH	2007-03-28
10	Box Phantom	IXB-070	2007-03-28

**ANNEX A**  
**of**  
**ShenZhen Morlab Communications Technology Co.,Ltd.**

**CONFORMANCE TEST REPORT FOR**  
**HUMAN EXPOSURE TO ELECTROMAGNETIC FIELDS**

REPORT NO: SZ06120009S01

**Qingdao Haier Telecom Co., Ltd.**

**GSM Mobile Phone**

**Accreditation Certificate**







**ACCREDITATION CERTIFICATE  
OF CHINA NATIONAL ACCREDITATION BOARD  
FOR LABORATORIES  
(No.L1659 )**

This is to certify that

**Shenzhen Electronic Product Quality Testing Center**  
Electronic Testing Building, Shahe Road, Xili, Nanshan District,  
Shenzhen, Guangdong, China

has been assessed and proved to be in compliance with CNAL/AC01:  
*2003 Accreditation Criteria for Testing and Calibration Laboratories*  
(identical to ISO/IEC17025 : 1999 *General Requirements for the*  
*Competence of Testing and Calibration Laboratories*).

Accreditation scope of the laboratory is listed in the attachment.

Date of Issue: 2004.10.09

Date of Expiry: 2009.10.08



**Wei Hao**

Secretary General of CNAL

**ANNEX B**  
**of**  
**ShenZhen Morlab Communications Technology Co.,Ltd.**

**CONFORMANCE TEST REPORT FOR**  
**HUMAN EXPOSURE TO ELECTROMAGNETIC FIELDS**

REPORT NO: SZ0612004009S01

**Qingdao Haier Telecom Co., Ltd.**

**GSM Mobile Phone**

**Type Name: HG-A7**

**TEST LAYOUT**

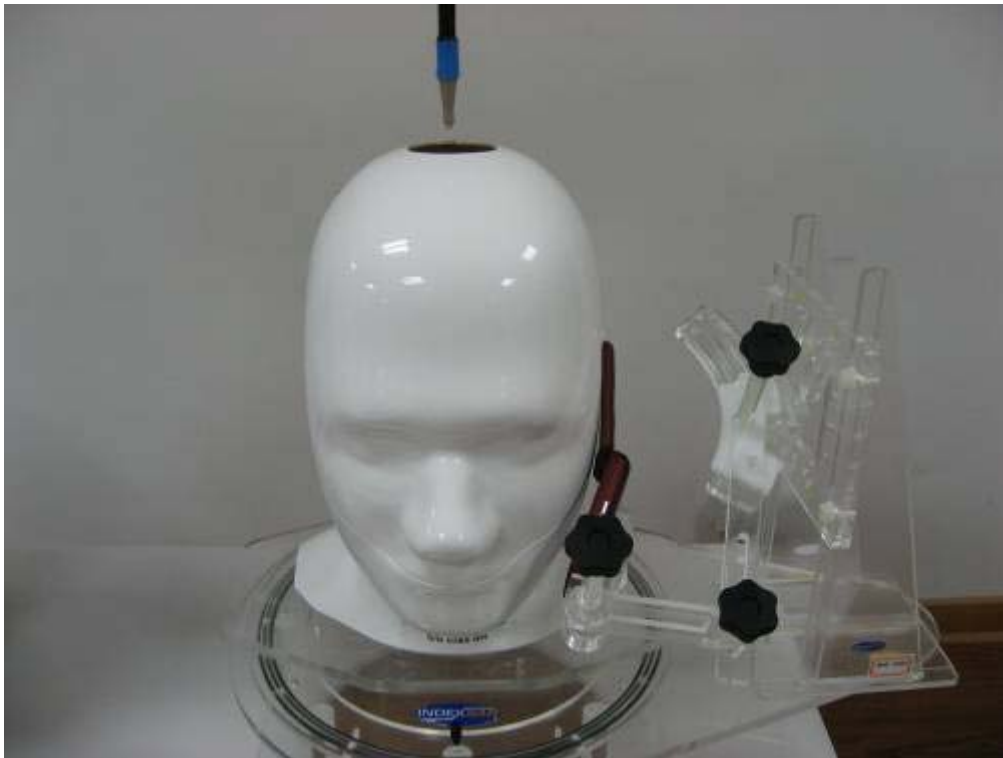



**Fig.1 SARA2 System Test Layout**



**Fig.2 The depth of head tissue in SAM**



**Fig.3 EUT Left Head Touch Cheek Position**



**Fig.4 EUT Left Head Tilt15 Position**



**Fig.5 EUT Right Head Touch Cheek Position**



**Fig.6 EUT Right Head Tilt15 Position**



**Fig.7 spacer 1.5cm**



**Fig.8 the depth of body tissue**



**Fig.9 Side Position**

**ANNEX C**  
**of**  
**ShenZhen Morlab Communications Technology Co.,Ltd.**

**CONFORMANCE TEST REPORT FOR**  
**HUMAN EXPOSURE TO ELECTROMAGNETIC FIELDS**

**REPORT NO: SZ06120009S01**

**Qingdao Haier Telecom Co., Ltd.**

**GSM Mobile Phone**

Type Name: **HG-A7**

**Sample Photographs**



Photograph of the Equipment under Test





1.2 Inside





**ANNEX D**

**of**

**ShenZhen Morlab Communications Technology Co.,Ltd.**

**CONFORMANCE TEST REPORT FOR  
HUMAN EXPOSURE TO ELECTROMAGNETIC FIELDS**

REPORT NO: SZ06120009S01

**Qingdao Haier Telecom Co., Ltd.**

**GSM Mobile Phone**

Type Name: **HG-A7**

**Graph Test Results**



**SAR Test GSM 850 LH\_TouchCheek (Bottom Channel)**

<b>System / software:</b>	SARA2 / 2.40 VPM	<b>Input Power Drift:</b>	
<b>Date / Time:</b>	2007-1-15 9:00:30	<b>DUT Battery Model/No:</b>	
<b>Filename:</b>	HG-A7_850_LH_TOUCHC HEEK_B.txt	<b>Probe Serial Number:</b>	0177
<b>Ambient Temperature:</b>	20.0°C	<b>Liquid Simulant:</b>	HEAD tissue
<b>Device Under Test:</b>	HG-A7	<b>Relative Permittivity:</b>	41.37
<b>Relative Humidity:</b>	44%	<b>Conductivity:</b>	.900
<b>Phantom S/No:</b>	Head_381SH.csv	<b>Liquid Temperature:</b>	20.1°C
<b>Phantom Rotation:</b>	0°	<b>Max SAR Y-axis Location:</b>	-57.00 mm
<b>DUT Position:</b>	HG-A7_LH_TOUCHCHEEK _B	<b>Max SAR Z-axis Location:</b>	-164.50 mm
<b>Antenna Configuration:</b>	BUILD INSIDE	<b>Max E Field:</b>	23.17 V/m
<b>Test Frequency:</b>	850MHz	<b>SAR 1g:</b>	0.451 W/kg
<b>Air Factors:</b>	417.2 / 368.0 / 414.8	<b>SAR 10g:</b>	0.362 W/kg
<b>Conversion Factors:</b>	.287 / .287 / .287	<b>SAR Start:</b>	0.360 W/kg
<b>Type of Modulation:</b>		<b>SAR End:</b>	0.366 W/kg
<b>Modn. Duty Cycle:</b>		<b>SAR Drift during Scan:</b>	1.42 %
<b>Diode Compression Factors (V*200):</b>	20 / 20 / 20	<b>Probe battery last changed:</b>	20/05/05
<b>Input Power Level:</b>	33dBm	<b>Extrapolation:</b>	poly4

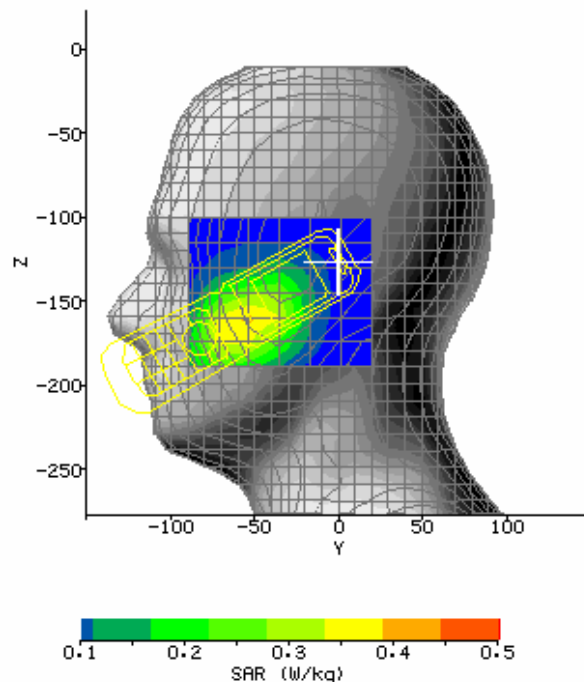

**SAR Test GSM 850 LH\_TouchCheek (Middle Channel)**

<b>System / software:</b>	SARA2 / 2.40 VPM	<b>Input Power Drift:</b>	
<b>Date / Time:</b>	2007-1-15 9:20:06	<b>DUT Battery Model/No:</b>	
<b>Filename:</b>	HG-A7_850_LH_TOUCHC HEEK_M.txt	<b>Probe Serial Number:</b>	0177
<b>Ambient Temperature:</b>	20.0°C	<b>Liquid Simulant:</b>	HEAD tissue
<b>Device Under Test:</b>	HG-A7	<b>Relative Permittivity:</b>	41.58
<b>Relative Humidity:</b>	44%	<b>Conductivity:</b>	.902
<b>Phantom S/No:</b>	Head_381SH.csv	<b>Liquid Temperature:</b>	20.1°C
<b>Phantom Rotation:</b>	0°	<b>Max SAR Y-axis Location:</b>	-55.17 mm
<b>DUT Position:</b>	HG-A7_LH_TOUCHCHEEK_M	<b>Max SAR Z-axis Location:</b>	-164.50 mm
<b>Antenna Configuration:</b>	BUILD INSIDE	<b>Max E Field:</b>	25.64 V/m
<b>Test Frequency:</b>	850MHz	<b>SAR 1g:</b>	0.522 W/kg
<b>Air Factors:</b>	417.2 / 368.0 / 414.8	<b>SAR 10g:</b>	0.413 W/kg
<b>Conversion Factors:</b>	.287 / .287 / .287	<b>SAR Start:</b>	0.414 W/kg
<b>Type of Modulation:</b>		<b>SAR End:</b>	0.419 W/kg
<b>Modn. Duty Cycle:</b>		<b>SAR Drift during Scan:</b>	1.28 %
<b>Diode Compression Factors (V*200):</b>	20 / 20 / 20	<b>Probe battery last changed:</b>	20/05/05
<b>Input Power Level:</b>	33dBm	<b>Extrapolation:</b>	poly4

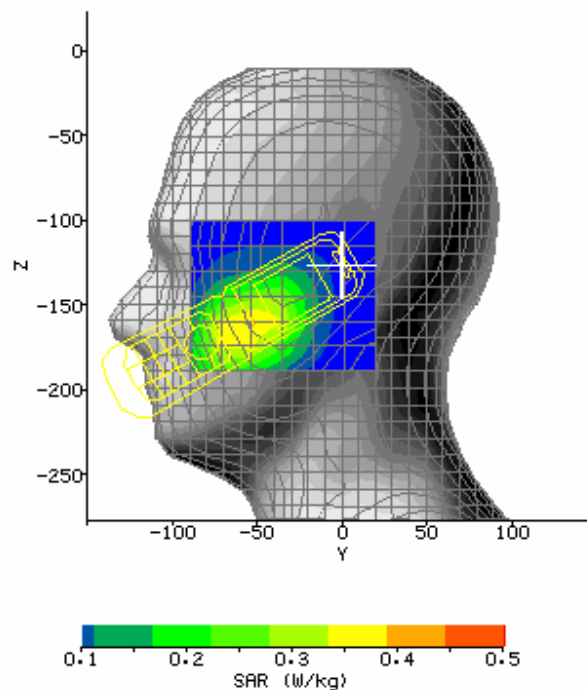

**SAR Test GSM 850 LH\_TouchCheek (Top Channel)**

<b>System / software:</b>	SARA2 / 2.40 VPM	<b>Input Power Drift:</b>	
<b>Date / Time:</b>	2007-1-15 9:37:44	<b>DUT Battery Model/No:</b>	
<b>Filename:</b>	HG- A7_850_LH_TOUCHCHEE K_T.txt	<b>Probe Serial Number:</b>	0177
<b>Ambient Temperature:</b>	20.0°C	<b>Liquid Simulant:</b>	HEAD tissue
<b>Device Under Test:</b>	HG-A7	<b>Relative Permittivity:</b>	41.58
<b>Relative Humidity:</b>	44%	<b>Conductivity:</b>	.902
<b>Phantom S/No:</b>	Head_381SH.csv	<b>Liquid Temperature:</b>	20.1°C
<b>Phantom Rotation:</b>	0°	<b>Max SAR Y-axis Location:</b>	-53.33 mm
<b>DUT Position:</b>	HG- A7_LH_TOUCHCHEEK_T	<b>Max SAR Z-axis Location:</b>	-163.00 mm
<b>Antenna Configuration:</b>	BUILD INSIDE	<b>Max E Field:</b>	25.70 V/m
<b>Test Frequency:</b>	850MHz	<b>SAR 1g:</b>	0.553 W/kg
<b>Air Factors:</b>	417.2 / 368.0 / 414.8	<b>SAR 10g:</b>	0.445 W/kg
<b>Conversion Factors:</b>	.287 / .287 / .287	<b>SAR Start:</b>	0.439 W/kg
<b>Type of Modulation:</b>		<b>SAR End:</b>	0.452 W/kg
<b>Modn. Duty Cycle:</b>		<b>SAR Drift during Scan:</b>	2.97 %
<b>Diode Compression Factors (V*200):</b>	20 / 20 / 20	<b>Probe battery last changed:</b>	20/05/05
<b>Input Power Level:</b>	33dBm	<b>Extrapolation:</b>	poly4

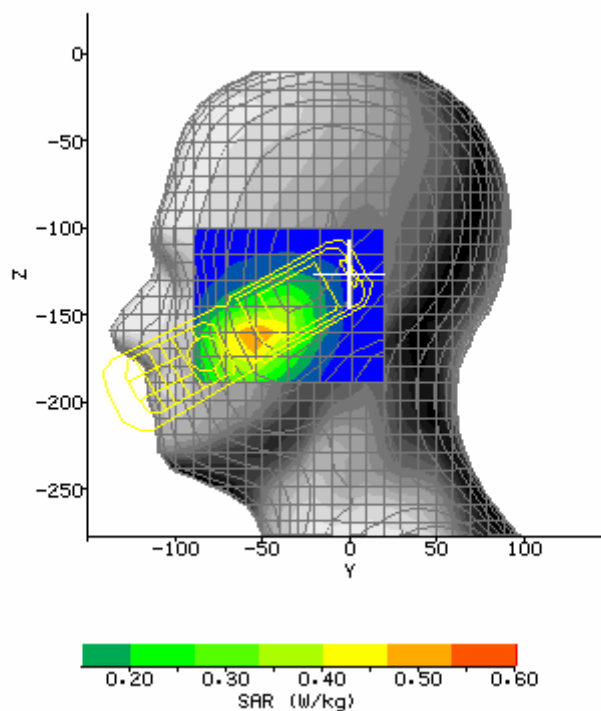

**SAR Test GSM 850 LH\_Tilt15 (Bottom Channel)**

<b>System / software:</b>	SARA2 / 2.40 VPM	<b>Input Power Drift:</b>	
<b>Date / Time:</b>	2007-1-15 9:59:03	<b>DUT Battery Model/No:</b>	
<b>Filename:</b>	HG-A7_850_LH_TILT15_B.txt	<b>Probe Serial Number:</b>	0177
<b>Ambient Temperature:</b>	20.0°C	<b>Liquid Simulant:</b>	HEAD tissue
<b>Device Under Test:</b>	HG-A7	<b>Relative Permittivity:</b>	41.58
<b>Relative Humidity:</b>	44%	<b>Conductivity:</b>	.902
<b>Phantom S/No:</b>	Head_381SH.csv	<b>Liquid Temperature:</b>	20.1°C
<b>Phantom Rotation:</b>	0°	<b>Max SAR Y-axis Location:</b>	-36.83 mm
<b>DUT Position:</b>	HG-A7_LH_TILT15_B	<b>Max SAR Z-axis Location:</b>	-146.50 mm
<b>Antenna Configuration:</b>	BUILD INSIDE	<b>Max E Field:</b>	17.45 V/m
<b>Test Frequency:</b>	850MHz	<b>SAR 1g:</b>	0.256 W/kg
<b>Air Factors:</b>	417.2 / 368.0 / 414.8	<b>SAR 10g:</b>	0.223 W/kg
<b>Conversion Factors:</b>	.287 / .287 / .287	<b>SAR Start:</b>	0.204 W/kg
<b>Type of Modulation:</b>		<b>SAR End:</b>	0.240 W/kg
<b>Modn. Duty Cycle:</b>		<b>SAR Drift during Scan:</b>	17.66 %
<b>Diode Compression Factors (V*200):</b>	20 / 20 / 20	<b>Probe battery last changed:</b>	20/05/05
<b>Input Power Level:</b>	33dBm	<b>Extrapolation:</b>	poly4

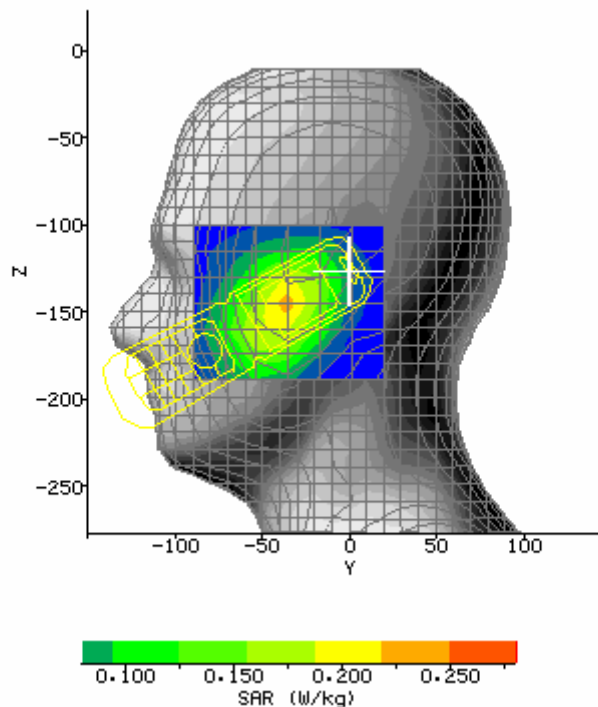

**SAR Test GSM 850 LH\_Tilt15 (Middle Channel)**

<b>System / software:</b>	SARA2 / 2.40 VPM	<b>Input Power Drift:</b>	
<b>Date / Time:</b>	2007-1-15 10:18:46	<b>DUT Battery Model/No:</b>	
<b>Filename:</b>	HG-A7_850_LH_TILT15_M.txt	<b>Probe Serial Number:</b>	0177
<b>Ambient Temperature:</b>	20.0°C	<b>Liquid Simulant:</b>	HEAD tissue
<b>Device Under Test:</b>	HG-A7	<b>Relative Permittivity:</b>	41.58
<b>Relative Humidity:</b>	44%	<b>Conductivity:</b>	.902
<b>Phantom S/No:</b>	Head_381SH.csv	<b>Liquid Temperature:</b>	20.1°C
<b>Phantom Rotation:</b>	0°	<b>Max SAR Y-axis Location:</b>	-38.67 mm
<b>DUT Position:</b>	HG-A7_LH_TILT15_M	<b>Max SAR Z-axis Location:</b>	-149.50 mm
<b>Antenna Configuration:</b>	BUILD INSIDE	<b>Max E Field:</b>	17.31 V/m
<b>Test Frequency:</b>	850MHz	<b>SAR 1g:</b>	0.253 W/kg
<b>Air Factors:</b>	417.2 / 368.0 / 414.8	<b>SAR 10g:</b>	0.221 W/kg
<b>Conversion Factors:</b>	.287 / .287 / .287	<b>SAR Start:</b>	0.225 W/kg
<b>Type of Modulation:</b>		<b>SAR End:</b>	0.223 W/kg
<b>Modn. Duty Cycle:</b>		<b>SAR Drift during Scan:</b>	-0.56 %
<b>Diode Compression Factors (V*200):</b>	20 / 20 / 20	<b>Probe battery last changed:</b>	20/05/05
<b>Input Power Level:</b>	33dBm	<b>Extrapolation:</b>	poly4

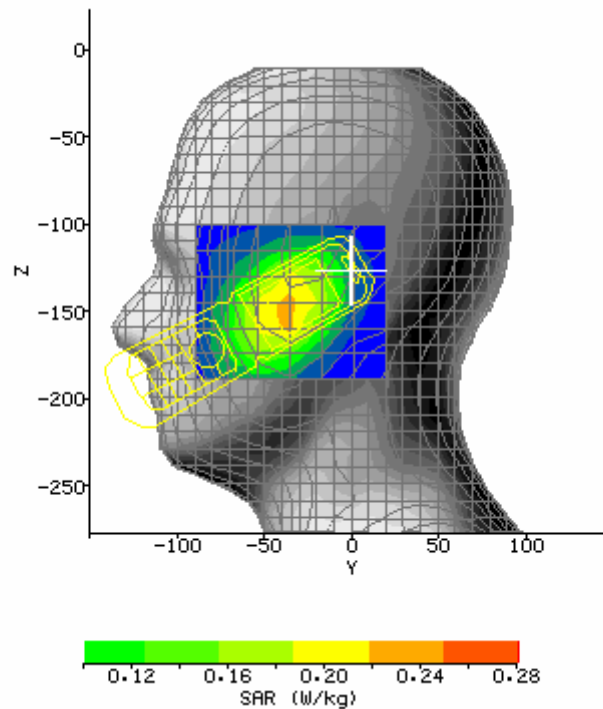

**SAR Test GSM 850 LH\_Tilt15 (Top Channel)**

<b>System / software:</b>	SARA2 / 2.40 VPM	<b>Input Power Drift:</b>	
<b>Date / Time:</b>	2007-1-15 10:39:26	<b>DUT Battery Model/No:</b>	
<b>Filename:</b>	HG-A7_850_LH_TILT15_T.txt	<b>Probe Serial Number:</b>	0177
<b>Ambient Temperature:</b>	20.0°C	<b>Liquid Simulant:</b>	HEAD tissue
<b>Device Under Test:</b>	HG-A7	<b>Relative Permittivity:</b>	41.58
<b>Relative Humidity:</b>	44%	<b>Conductivity:</b>	.902
<b>Phantom S/No:</b>	Head_381SH.csv	<b>Liquid Temperature:</b>	20.1°C
<b>Phantom Rotation:</b>	0°	<b>Max SAR Y-axis Location:</b>	-36.83 mm
<b>DUT Position:</b>	HG-A7_LH_TILT15_T	<b>Max SAR Z-axis Location:</b>	-148.00 mm
<b>Antenna Configuration:</b>	BUILD INSIDE	<b>Max E Field:</b>	18.84 V/m
<b>Test Frequency:</b>	850MHz	<b>SAR 1g:</b>	0.302 W/kg
<b>Air Factors:</b>	417.2 / 368.0 / 414.8	<b>SAR 10g:</b>	0.244 W/kg
<b>Conversion Factors:</b>	.287 / .287 / .287	<b>SAR Start:</b>	0.234 W/kg
<b>Type of Modulation:</b>		<b>SAR End:</b>	0.232 W/kg
<b>Modn. Duty Cycle:</b>		<b>SAR Drift during Scan:</b>	-0.99 %
<b>Diode Compression Factors (V*200):</b>	20 / 20 / 20	<b>Probe battery last changed:</b>	20/05/05
<b>Input Power Level:</b>	33dBm	<b>Extrapolation:</b>	poly4

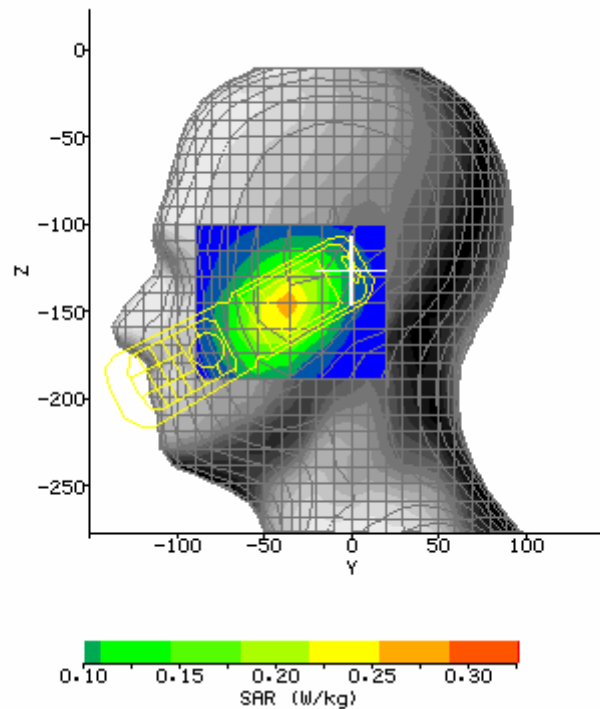



**SAR Test GSM 850 RH\_TouchCheek (Bottom Channel)**

<b>System / software:</b>	SARA2 / 2.40 VPM	<b>Input Power Drift:</b>	
<b>Date / Time:</b>	2007-1-15 11:07:12	<b>DUT Battery Model/No:</b>	
<b>Filename:</b>	HG-A7_850_RH_TOUCHC HEEK_B.txt	<b>Probe Serial Number:</b>	0177
<b>Ambient Temperature:</b>	20.0°C	<b>Liquid Simulant:</b>	HEAD tissue
<b>Device Under Test:</b>	HG-A7	<b>Relative Permittivity:</b>	41.58
<b>Relative Humidity:</b>	44%	<b>Conductivity:</b>	.902
<b>Phantom S/No:</b>	Head_381SH.csv	<b>Liquid Temperature:</b>	20.1°C
<b>Phantom Rotation:</b>	180°	<b>Max SAR Y-axis Location:</b>	57.00 mm
<b>DUT Position:</b>	HG-A7_RH_TOUCHCHEE K_B	<b>Max SAR Z-axis Location:</b>	-160.00 mm
<b>Antenna Configuration:</b>	BUILD INSIDE	<b>Max E Field:</b>	23.32 V/m
<b>Test Frequency:</b>	850MHz	<b>SAR 1g:</b>	0.452 W/kg
<b>Air Factors:</b>	417.2 / 368.0 / 414.8	<b>SAR 10g:</b>	0.367 W/kg
<b>Conversion Factors:</b>	.287 / .287 / .287	<b>SAR Start:</b>	0.389 W/kg
<b>Type of Modulation:</b>		<b>SAR End:</b>	0.376 W/kg
<b>Modn. Duty Cycle:</b>		<b>SAR Drift during Scan:</b>	-3.47 %
<b>Diode Compression Factors (V*200):</b>	20 / 20 / 20	<b>Probe battery last changed:</b>	20/05/05
<b>Input Power Level:</b>	33dBm	<b>Extrapolation:</b>	poly4

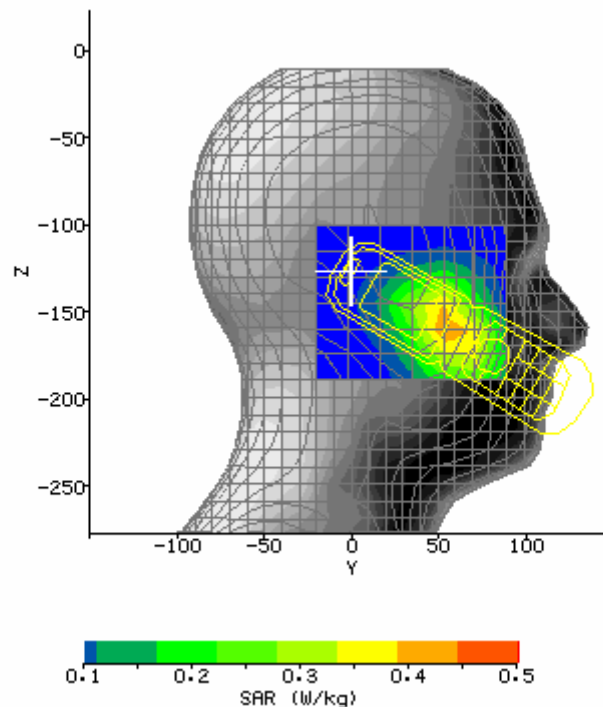

**SAR Test GSM 850 RH\_TouchCheek (Middle Channel)**

<b>System / software:</b>	SARA2 / 2.40 VPM	<b>Input Power Drift:</b>	
<b>Date / Time:</b>	2007-1-15 11:28:38	<b>DUT Battery Model/No:</b>	
<b>Filename:</b>	HG- A7_850_RH_TOUCHC HEEK_M.txt	<b>Probe Serial Number:</b>	0177
<b>Ambient Temperature:</b>	20.0°C	<b>Liquid Simulant:</b>	HEAD tissue
<b>Device Under Test:</b>	HG-A7	<b>Relative Permittivity:</b>	41.58
<b>Relative Humidity:</b>	44%	<b>Conductivity:</b>	.902
<b>Phantom S/No:</b>	Head_381SH.csv	<b>Liquid Temperature:</b>	20.1°C
<b>Phantom Rotation:</b>	180°	<b>Max SAR Y-axis Location:</b>	58.83 mm
<b>DUT Position:</b>	HG- A7_RH_TOUCHCHEE K_M	<b>Max SAR Z-axis Location:</b>	-161.50 mm
<b>Antenna Configuration:</b>	BUILD INSIDE	<b>Max E Field:</b>	24.24 V/m
<b>Test Frequency:</b>	850MHz	<b>SAR 1g:</b>	0.482 W/kg
<b>Air Factors:</b>	417.2 / 368.0 / 414.8	<b>SAR 10g:</b>	0.394 W/kg
<b>Conversion Factors:</b>	.287 / .287 / .287	<b>SAR Start:</b>	0.426 W/kg
<b>Type of Modulation:</b>		<b>SAR End:</b>	0.430 W/kg
<b>Modn. Duty Cycle:</b>		<b>SAR Drift during Scan:</b>	1.04 %
<b>Diode Compression Factors (V*200):</b>	20 / 20 / 20	<b>Probe battery last changed:</b>	20/05/05
<b>Input Power Level:</b>	33dBm	<b>Extrapolation:</b>	poly4

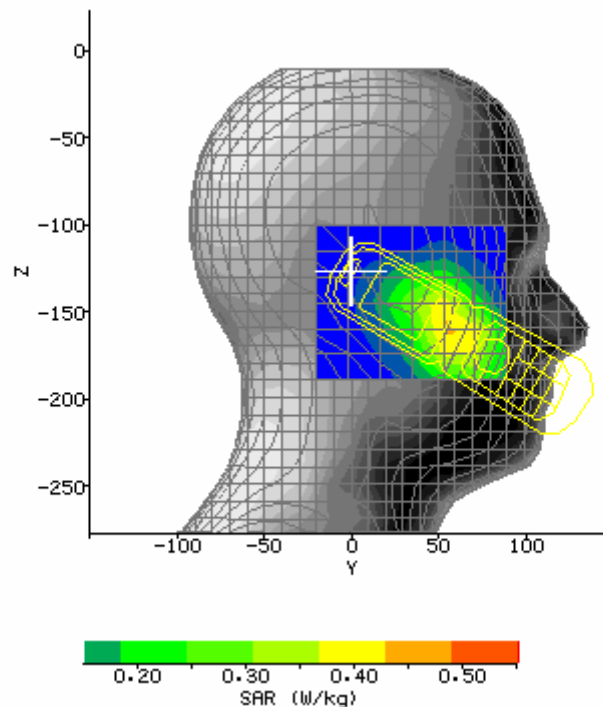

### SAR Test GSM 850 RH\_TouchCheek (Top Channel)

<b>System / software:</b>	SARA2 / 2.40 VPM	<b>Input Power Drift:</b>	
<b>Date / Time:</b>	2007-1-15 11:49:05	<b>DUT Battery Model/No:</b>	
<b>Filename:</b>	HG- A7_850_RH_TOUCHC HEEK_T.txt	<b>Probe Serial Number:</b>	0177
<b>Ambient Temperature:</b>	20.0°C	<b>Liquid Simulant:</b>	HEAD tissue
<b>Device Under Test:</b>	HG-A7	<b>Relative Permittivity:</b>	41.58
<b>Relative Humidity:</b>	44%	<b>Conductivity:</b>	.902
<b>Phantom S/No:</b>	Head_381SH.csv	<b>Liquid Temperature:</b>	20.1°C
<b>Phantom Rotation:</b>	180°	<b>Max SAR Y-axis Location:</b>	57.00 mm
<b>DUT Position:</b>	HG- A7_RH_TOUCHCHEE K_T	<b>Max SAR Z-axis Location:</b>	-160.00 mm
<b>Antenna Configuration:</b>	BUILD INSIDE	<b>Max E Field:</b>	27.42 V/m
<b>Test Frequency:</b>	850MHz	<b>SAR 1g:</b>	0.606 W/kg
<b>Air Factors:</b>	417.2 / 368.0 / 414.8	<b>SAR 10g:</b>	0.503 W/kg
<b>Conversion Factors:</b>	.287 / .287 / .287	<b>SAR Start:</b>	0.524 W/kg
<b>Type of Modulation:</b>		<b>SAR End:</b>	0.570 W/kg
<b>Modn. Duty Cycle:</b>		<b>SAR Drift during Scan:</b>	8.77 %
<b>Diode Compression Factors (V*200):</b>	20 / 20 / 20	<b>Probe battery last changed:</b>	20/05/05
<b>Input Power Level:</b>	33dBm	<b>Extrapolation:</b>	poly4

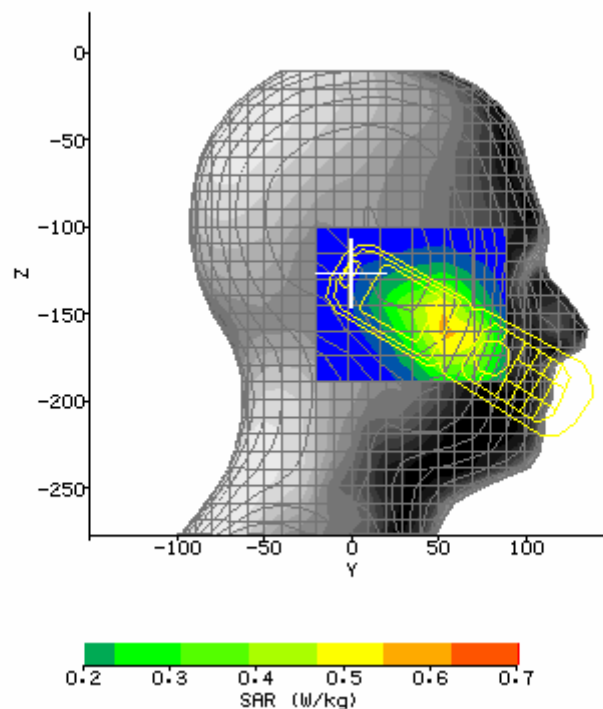

**SAR Test GSM 850 RH\_Tilt15 (Bottom Channel)**

<b>System / software:</b>	SARA2 / 2.40 VPM	<b>Input Power Drift:</b>	
<b>Date / Time:</b>	2007-1-15 12:08:20	<b>DUT Battery Model/No:</b>	
<b>Filename:</b>	HG-A7_850_RH_TILT15_B.txt	<b>Probe Serial Number:</b>	0177
<b>Ambient Temperature:</b>	20.0°C	<b>Liquid Simulant:</b>	HEAD tissue
<b>Device Under Test:</b>	HG-A7	<b>Relative Permittivity:</b>	41.58
<b>Relative Humidity:</b>	44%	<b>Conductivity:</b>	.902
<b>Phantom S/No:</b>	Head_381SH.csv	<b>Liquid Temperature:</b>	20.1°C
<b>Phantom Rotation:</b>	180°	<b>Max SAR Y-axis Location:</b>	33.17 mm
<b>DUT Position:</b>	HG-A7_RH_TILT15_B	<b>Max SAR Z-axis Location:</b>	-149.50 mm
<b>Antenna Configuration:</b>	BUILD INSIDE	<b>Max E Field:</b>	19.31 V/m
<b>Test Frequency:</b>	850MHz	<b>SAR 1g:</b>	0.319 W/kg
<b>Air Factors:</b>	417.2 / 368.0 / 414.8	<b>SAR 10g:</b>	0.280 W/kg
<b>Conversion Factors:</b>	.287 / .287 / .287	<b>SAR Start:</b>	0.307 W/kg
<b>Type of Modulation:</b>		<b>SAR End:</b>	0.304 W/kg
<b>Modn. Duty Cycle:</b>		<b>SAR Drift during Scan:</b>	-0.88 %
<b>Diode Compression Factors (V*200):</b>	20 / 20 / 20	<b>Probe battery last changed:</b>	20/05/05
<b>Input Power Level:</b>	33dBm	<b>Extrapolation:</b>	poly4

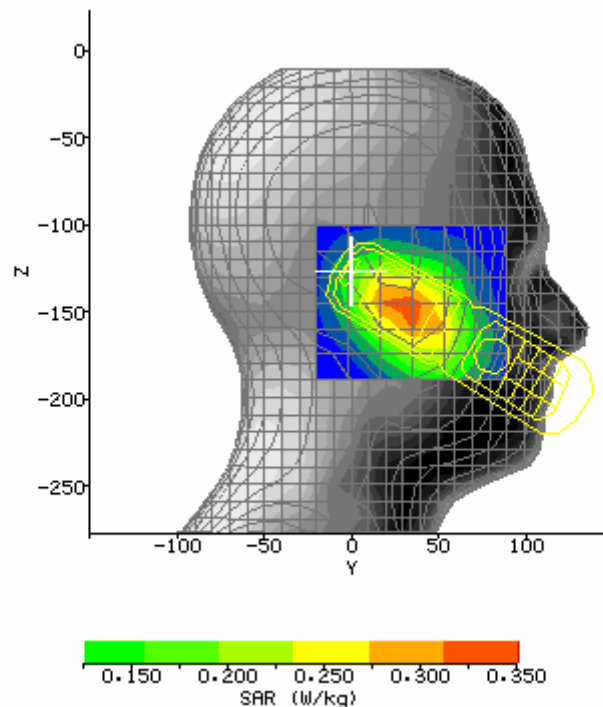

**SAR Test GSM 850 RH\_Tilt15 (Middle Channel)**

<b>System / software:</b>	SARA2 / 2.40 VPM	<b>Input Power Drift:</b>	
<b>Date / Time:</b>	2007-1-15 12:30:09	<b>DUT Battery Model/No:</b>	
<b>Filename:</b>	HG-A7_850_RH_TILT15_M.txt	<b>Probe Serial Number:</b>	0177
<b>Ambient Temperature:</b>	20.0°C	<b>Liquid Simulant:</b>	HEAD tissue
<b>Device Under Test:</b>	HG-A7	<b>Relative Permittivity:</b>	41.58
<b>Relative Humidity:</b>	44%	<b>Conductivity:</b>	.902
<b>Phantom S/No:</b>	Head_381SH.csv	<b>Liquid Temperature:</b>	20.1°C
<b>Phantom Rotation:</b>	180°	<b>Max SAR Y-axis Location:</b>	33.17 mm
<b>DUT Position:</b>	HG-A7_RH_TILT15_M	<b>Max SAR Z-axis Location:</b>	-148.00 mm
<b>Antenna Configuration:</b>	BUILD INSIDE	<b>Max E Field:</b>	21.87 V/m
<b>Test Frequency:</b>	850MHz	<b>SAR 1g:</b>	0.395 W/kg
<b>Air Factors:</b>	417.2 / 368.0 / 414.8	<b>SAR 10g:</b>	0.344 W/kg
<b>Conversion Factors:</b>	.287 / .287 / .287	<b>SAR Start:</b>	0.370 W/kg
<b>Type of Modulation:</b>		<b>SAR End:</b>	0.372 W/kg
<b>Modn. Duty Cycle:</b>		<b>SAR Drift during Scan:</b>	0.40 %
<b>Diode Compression Factors (V*200):</b>	20 / 20 / 20	<b>Probe battery last changed:</b>	20/05/05
<b>Input Power Level:</b>	33dBm	<b>Extrapolation:</b>	poly4

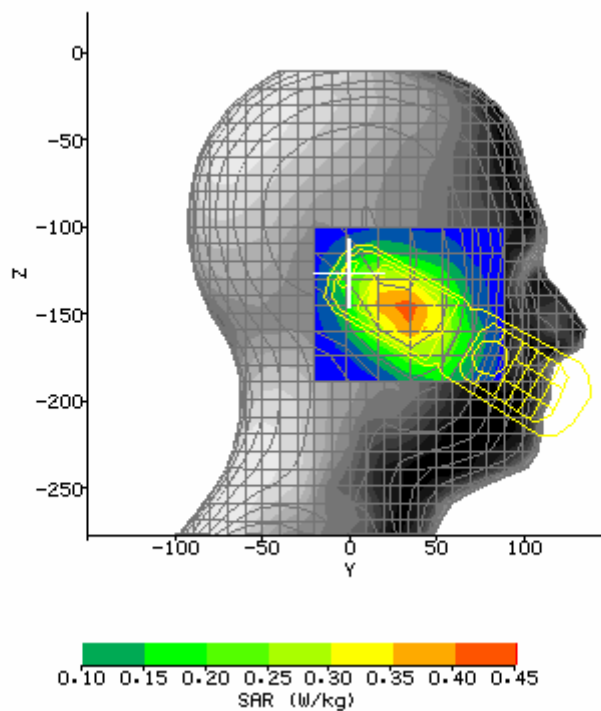

**SAR Test GSM 850 RH\_Tilt15 (Top Channel)**

<b>System / software:</b>	SARA2 / 2.40 VPM	<b>Input Power Drift:</b>	
<b>Date / Time:</b>	2007-1-15 13:40:48	<b>DUT Battery Model/No:</b>	
<b>Filename:</b>	HG-A7_850_RH_TILT15_T.txt	<b>Probe Serial Number:</b>	0177
<b>Ambient Temperature:</b>	20.0°C	<b>Liquid Simulant:</b>	HEAD tissue
<b>Device Under Test:</b>	HG-A7	<b>Relative Permittivity:</b>	41.58
<b>Relative Humidity:</b>	44%	<b>Conductivity:</b>	.902
<b>Phantom S/No:</b>	Head_381SH.csv	<b>Liquid Temperature:</b>	20.1°C
<b>Phantom Rotation:</b>	180°	<b>Max SAR Y-axis Location:</b>	29.50 mm
<b>DUT Position:</b>	HG-A7_RH_TILT15_T	<b>Max SAR Z-axis Location:</b>	-146.50 mm
<b>Antenna Configuration:</b>	BUILD INSIDE	<b>Max E Field:</b>	24.47 V/m
<b>Test Frequency:</b>	850MHz	<b>SAR 1g:</b>	0.506 W/kg
<b>Air Factors:</b>	417.2 / 368.0 / 414.8	<b>SAR 10g:</b>	0.425 W/kg
<b>Conversion Factors:</b>	.287 / .287 / .287	<b>SAR Start:</b>	0.439 W/kg
<b>Type of Modulation:</b>		<b>SAR End:</b>	0.438 W/kg
<b>Modn. Duty Cycle:</b>		<b>SAR Drift during Scan:</b>	-0.09 %
<b>Diode Compression Factors (V*200):</b>	20 / 20 / 20	<b>Probe battery last changed:</b>	20/05/05
<b>Input Power Level:</b>	33dBm	<b>Extrapolation:</b>	poly4

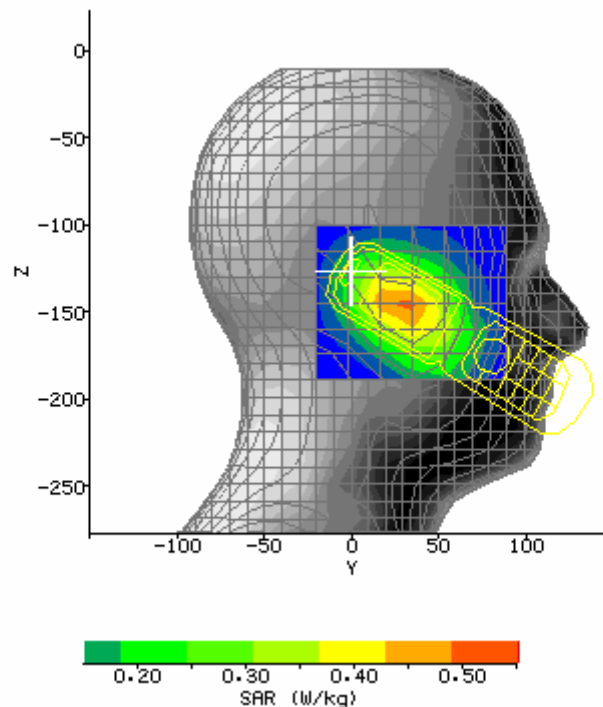

### SAR Test GSM 850 Body (Bottom Channel)

<b>System / software:</b>	SARA2 / 2.40 VPM	<b>Input Power Drift:</b>	
<b>Date / Time:</b>	2007-1-15 14:00:53	<b>DUT Battery Model/No:</b>	
<b>Filename:</b>	HG- A7_850_BODY_B.txt	<b>Probe Serial Number:</b>	0177
<b>Ambient Temperature:</b>	21.3°C	<b>Liquid Simulant:</b>	Body tissue
<b>Device Under Test:</b>	HG-A7	<b>Relative Permittivity:</b>	55.47
<b>Relative Humidity:</b>	54%	<b>Conductivity:</b>	.972
<b>Phantom S/No:</b>	HeadBox75mm.csv	<b>Liquid Temperature:</b>	21.4°C
<b>Phantom Rotation:</b>	0°	<b>Max SAR X-axis Location:</b>	6.86 mm
<b>DUT Position:</b>	BODY	<b>Max SAR Y-axis Location:</b>	10.29 mm
<b>Antenna Configuration:</b>	BUILD INSIDE	<b>Max E Field:</b>	13.37 V/m
<b>Test Frequency:</b>	850MHz	<b>SAR 1g:</b>	0.179 W/kg
<b>Air Factors:</b>	417 / 368 / 414	<b>SAR 10g:</b>	0.139 W/kg
<b>Conversion Factors:</b>	.271 / .271 / .271	<b>SAR Start:</b>	0.072 W/kg
<b>Type of Modulation:</b>		<b>SAR End:</b>	0.076 W/kg
<b>Modn. Duty Cycle:</b>		<b>SAR Drift during Scan:</b>	5.53 %
<b>Diode Compression Factors (V*200):</b>	20 / 20 / 20	<b>Probe battery last changed:</b>	20/05/05
<b>Input Power Level:</b>	Max Power	<b>Extrapolation:</b>	poly4

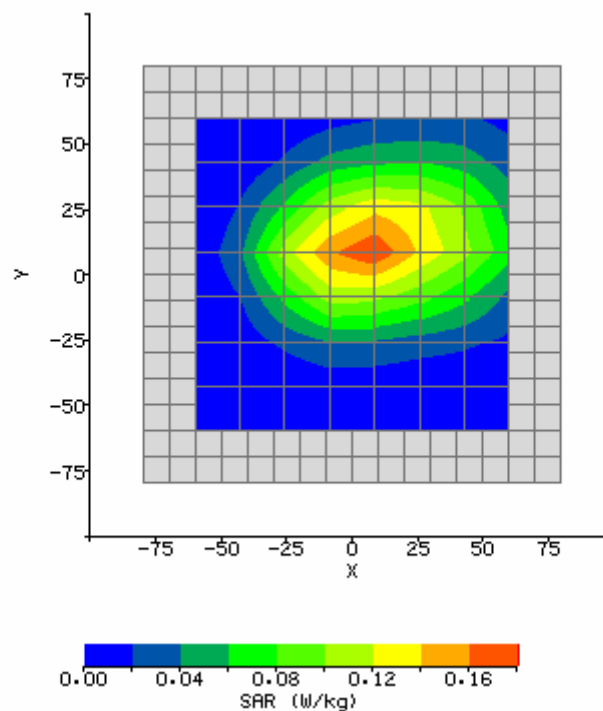

### SAR Test GSM 850 Body (Middle Channel)

<b>System / software:</b>	SARA2 / 2.40 VPM	<b>Input Power Drift:</b>	
<b>Date / Time:</b>	2007-1-15 14:19:00	<b>DUT Battery Model/No:</b>	
<b>Filename:</b>	HG-A7_850_BODY_M.txt	<b>Probe Serial Number:</b>	0177
<b>Ambient Temperature:</b>	21.3°C	<b>Liquid Simulant:</b>	Body tissue
<b>Device Under Test:</b>	HG-A7	<b>Relative Permittivity:</b>	55.47
<b>Relative Humidity:</b>	54%	<b>Conductivity:</b>	.972
<b>Phantom S/No:</b>	HeadBox75mm.csv	<b>Liquid Temperature:</b>	21.4°C
<b>Phantom Rotation:</b>	0°	<b>Max SAR X-axis Location:</b>	1.71 mm
<b>DUT Position:</b>	BODY	<b>Max SAR Y-axis Location:</b>	8.57 mm
<b>Antenna Configuration:</b>	BUILD INSIDE	<b>Max E Field:</b>	13.38 V/m
<b>Test Frequency:</b>	850MHz	<b>SAR 1g:</b>	0.188 W/kg
<b>Air Factors:</b>	417 / 368 / 414	<b>SAR 10g:</b>	0.141 W/kg
<b>Conversion Factors:</b>	.271 / .271 / .271	<b>SAR Start:</b>	0.070 W/kg
<b>Type of Modulation:</b>		<b>SAR End:</b>	0.071 W/kg
<b>Modn. Duty Cycle:</b>		<b>SAR Drift during Scan:</b>	1.39 %
<b>Diode Compression Factors (V*200):</b>	20 / 20 / 20	<b>Probe battery last changed:</b>	20/05/05
<b>Input Power Level:</b>	Max Power	<b>Extrapolation:</b>	poly4

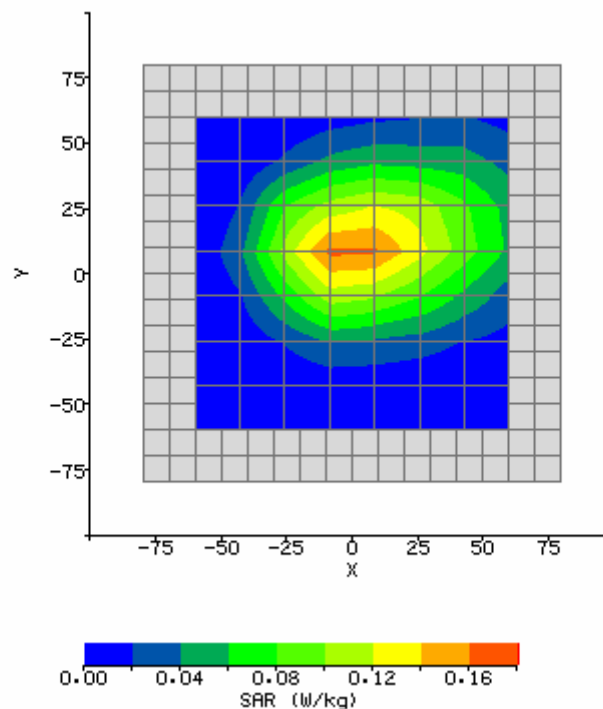



**SAR Test GSM 850 Body (Top Channel)**

<b>System / software:</b>	SARA2 / 2.40 VPM	<b>Input Power Drift:</b>	
<b>Date / Time:</b>	2007-1-15 14:38:40	<b>DUT Battery Model/No:</b>	
<b>Filename:</b>	HG- A7_850_BODY_T.txt	<b>Probe Serial Number:</b>	0177
<b>Ambient Temperature:</b>	21.3°C	<b>Liquid Simulant:</b>	Body tissue
<b>Device Under Test:</b>	HG-A7	<b>Relative Permittivity:</b>	55.47
<b>Relative Humidity:</b>	54%	<b>Conductivity:</b>	.972
<b>Phantom S/No:</b>	HeadBox75mm.csv	<b>Liquid Temperature:</b>	21.4°C
<b>Phantom Rotation:</b>	0°	<b>Max SAR X-axis Location:</b>	12.00 mm
<b>DUT Position:</b>	BODY	<b>Max SAR Y-axis Location:</b>	10.29 mm
<b>Antenna Configuration:</b>	BUILD INSIDE	<b>Max E Field:</b>	14.56 V/m
<b>Test Frequency:</b>	850MHz	<b>SAR 1g:</b>	0.223 W/kg
<b>Air Factors:</b>	417 / 368 / 414	<b>SAR 10g:</b>	0.169 W/kg
<b>Conversion Factors:</b>	.271 / .271 / .271	<b>SAR Start:</b>	0.099 W/kg
<b>Type of Modulation:</b>		<b>SAR End:</b>	0.100 W/kg
<b>Modn. Duty Cycle:</b>		<b>SAR Drift during Scan:</b>	1.08 %
<b>Diode Compression Factors (V*200):</b>	20 / 20 / 20	<b>Probe battery last changed:</b>	20/05/05
<b>Input Power Level:</b>	Max Power	<b>Extrapolation:</b>	poly4

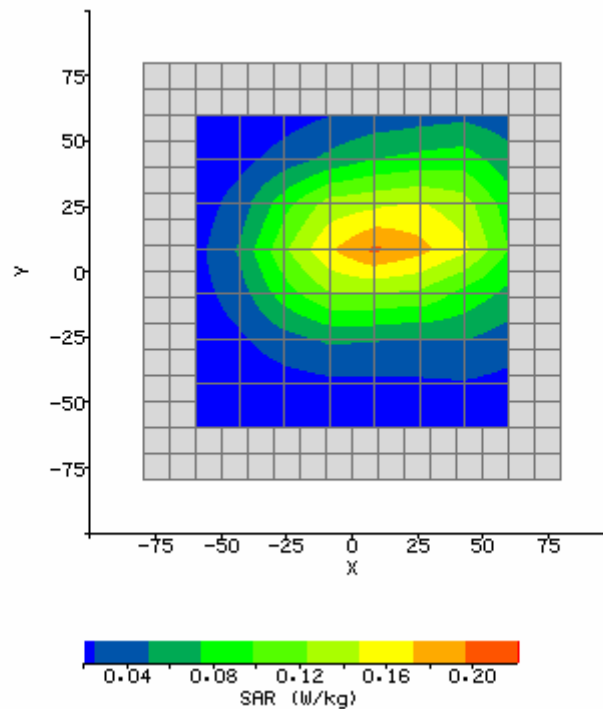

**SAR Test GSM 850 Body (Top Channel, with Headphone)**

<b>System / software:</b>	SARA2 / 2.40 VPM	<b>Input Power Drift:</b>	
<b>Date / Time:</b>	2007-1-15 13:00:30	<b>DUT Battery Model/No:</b>	
<b>Filename:</b>	HG-A7_850_BODY_T_WIT HHEADPHONE.txt	<b>Probe Serial Number:</b>	0177
<b>Ambient Temperature:</b>	21.3°C	<b>Liquid Simulant:</b>	Body tissue
<b>Device Under Test:</b>	HG-A7	<b>Relative Permittivity:</b>	55.47
<b>Relative Humidity:</b>	54%	<b>Conductivity:</b>	.972
<b>Phantom S/No:</b>	HeadBox75mm.csv	<b>Liquid Temperature:</b>	21.4°C
<b>Phantom Rotation:</b>	0°	<b>Max SAR X-axis Location:</b>	8.57 mm
<b>DUT Position:</b>	BODY	<b>Max SAR Y-axis Location:</b>	6.86 mm
<b>Antenna Configuration:</b>	BUILD INSIDE	<b>Max E Field:</b>	17.10 V/m
<b>Test Frequency:</b>	850MHz	<b>SAR 1g:</b>	0.292 W/kg
<b>Air Factors:</b>	417 / 368 / 414	<b>SAR 10g:</b>	0.216 W/kg
<b>Conversion Factors:</b>	.271 / .271 / .271	<b>SAR Start:</b>	0.123 W/kg
<b>Type of Modulation:</b>		<b>SAR End:</b>	0.121 W/kg
<b>Modn. Duty Cycle:</b>		<b>SAR Drift during Scan:</b>	-2.01 %
<b>Diode Compression Factors (V*200):</b>	20 / 20 / 20	<b>Probe battery last changed:</b>	20/05/05
<b>Input Power Level:</b>	Max Power	<b>Extrapolation:</b>	poly4

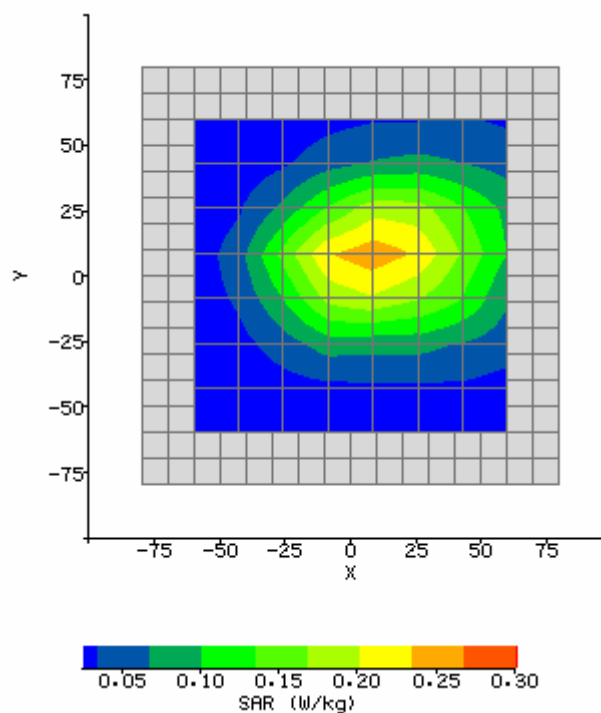

**SAR Test GSM 850 Body (Top Channel, face to bottom)**

<b>System / software:</b>	SARA2 / 2.40 VPM	<b>Input Power Drift:</b>	
<b>Date / Time:</b>	2007-1-15 15:30:29	<b>DUT Battery Model/No:</b>	
<b>Filename:</b>	HG-A7_850_BODY_T_FAC ETOBOTTOM.txt	<b>Probe Serial Number:</b>	0177
<b>Ambient Temperature:</b>	21.3°C	<b>Liquid Simulant:</b>	Body tissue
<b>Device Under Test:</b>	HG-A7	<b>Relative Permittivity:</b>	55.47
<b>Relative Humidity:</b>	54%	<b>Conductivity:</b>	.972
<b>Phantom S/No:</b>	HeadBox75mm.csv	<b>Liquid Temperature:</b>	21.4°C
<b>Phantom Rotation:</b>	0°	<b>Max SAR X-axis Location:</b>	20.57 mm
<b>DUT Position:</b>	BODY	<b>Max SAR Y-axis Location:</b>	5.14 mm
<b>Antenna Configuration:</b>	BUILD INSIDE	<b>Max E Field:</b>	17.65 V/m
<b>Test Frequency:</b>	850MHz	<b>SAR 1g:</b>	0.343 W/kg
<b>Air Factors:</b>	417 / 368 / 414	<b>SAR 10g:</b>	0.255 W/kg
<b>Conversion Factors:</b>	.271 / .271 / .271	<b>SAR Start:</b>	0.148 W/kg
<b>Type of Modulation:</b>		<b>SAR End:</b>	0.141 W/kg
<b>Modn. Duty Cycle:</b>		<b>SAR Drift during Scan:</b>	-5.15 %
<b>Diode Compression Factors (V*200):</b>	20 / 20 / 20	<b>Probe battery last changed:</b>	20/05/05
<b>Input Power Level:</b>	Max Power	<b>Extrapolation:</b>	poly4

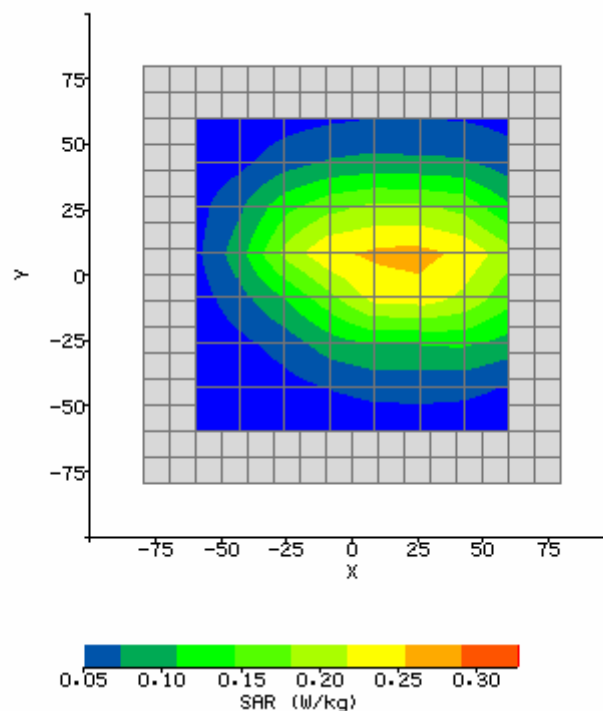

**SAR Test PCS 1900 LH\_Touchcheek (Bottom Channel)**

<b>System / software:</b>	SARA2 / 2.40 VPM	<b>Input Power Drift:</b>	
<b>Date / Time:</b>	2007-1-16 9:32:01	<b>DUT Battery Model/No:</b>	
<b>Filename:</b>	HG-A7_1900_LH_TOUCHCHEEK_B.txt	<b>Probe Serial Number:</b>	0177
<b>Ambient Temperature:</b>	19.7°C	<b>Liquid Simulant:</b>	HEAD tissue
<b>Device Under Test:</b>	HG-A7	<b>Relative Permittivity:</b>	40.12
<b>Relative Humidity:</b>	49%	<b>Conductivity:</b>	1.394
<b>Phantom S/No:</b>	Head_381SH.csv	<b>Liquid Temperature:</b>	19.8°C
<b>Phantom Rotation:</b>	0°	<b>Max SAR Y-axis Location:</b>	-66.17 mm
<b>DUT Position:</b>	HG-A7_LH_TOUCHCHEEK_B	<b>Max SAR Z-axis Location:</b>	-178.00 mm
<b>Antenna Configuration:</b>	BUILD INSIDE	<b>Max E Field:</b>	23.17 V/m
<b>Test Frequency:</b>	1900MHz	<b>SAR 1g:</b>	0.427 W/kg
<b>Air Factors:</b>	417 / 368 / 414	<b>SAR 10g:</b>	0.250 W/kg
<b>Conversion Factors:</b>	.325 / .325 / .325	<b>SAR Start:</b>	0.267 W/kg
<b>Type of Modulation:</b>		<b>SAR End:</b>	0.279 W/kg
<b>Modn. Duty Cycle:</b>		<b>SAR Drift during Scan:</b>	4.68 %
<b>Diode Compression Factors (V*200):</b>	20 / 20 / 20	<b>Probe battery last changed:</b>	20/05/05
<b>Input Power Level:</b>	30dBm	<b>Extrapolation:</b>	poly4

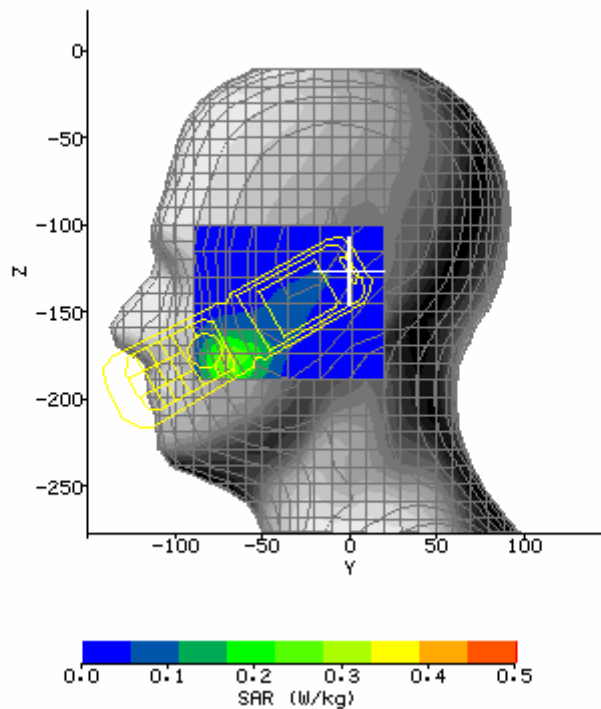

**SAR Test PCS 1900 LH\_Touchcheek (Middle Channel)**

<b>System / software:</b>	SARA2 / 2.40 VPM	<b>Input Power Drift:</b>	
<b>Date / Time:</b>	2007-1-16 9:58:24	<b>DUT Battery Model/No:</b>	
<b>Filename:</b>	HG-A7_1900_LH_TOUCHC HEEK_M.txt	<b>Probe Serial Number:</b>	0177
<b>Ambient Temperature:</b>	19.7°C	<b>Liquid Simulant:</b>	HEAD tissue
<b>Device Under Test:</b>	HG-A7	<b>Relative Permittivity:</b>	40.12
<b>Relative Humidity:</b>	49%	<b>Conductivity:</b>	1.394
<b>Phantom S/No:</b>	Head_381SH.csv	<b>Liquid Temperature:</b>	19.8°C
<b>Phantom Rotation:</b>	0°	<b>Max SAR Y-axis Location:</b>	-66.17 mm
<b>DUT Position:</b>	HG-A7_LH_TOUCHC HEEK_M	<b>Max SAR Z-axis Location:</b>	-179.50 mm
<b>Antenna Configuration:</b>	BUILD INSIDE	<b>Max E Field:</b>	22.20 V/m
<b>Test Frequency:</b>	1900MHz	<b>SAR 1g:</b>	0.375 W/kg
<b>Air Factors:</b>	417 / 368 / 414	<b>SAR 10g:</b>	0.227 W/kg
<b>Conversion Factors:</b>	.325 / .325 / .325	<b>SAR Start:</b>	0.258 W/kg
<b>Type of Modulation:</b>		<b>SAR End:</b>	0.260 W/kg
<b>Modn. Duty Cycle:</b>		<b>SAR Drift during Scan:</b>	0.97 %
<b>Diode Compression Factors (V*200):</b>	20 / 20 / 20	<b>Probe battery last changed:</b>	20/05/05
<b>Input Power Level:</b>	30dBm	<b>Extrapolation:</b>	poly4

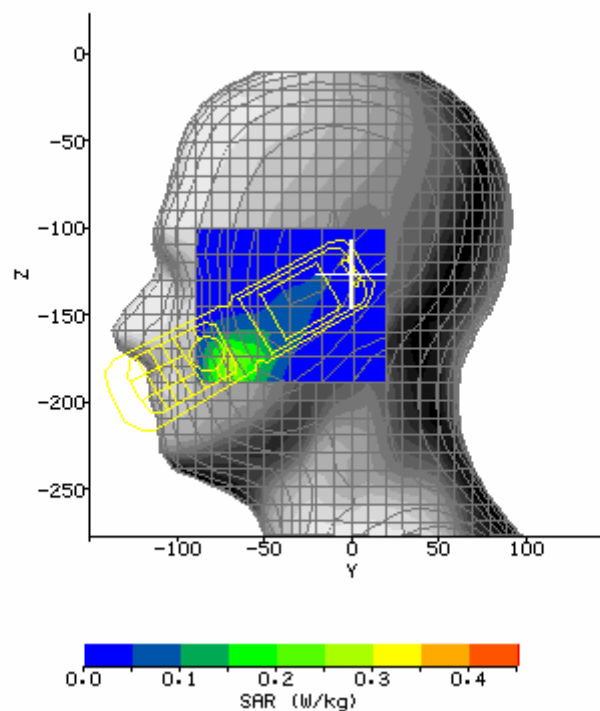

**SAR Test PCS 1900 LH\_Touchcheek (Top Channel)**

<b>System / software:</b>	SARA2 / 2.40 VPM	<b>Input Power Drift:</b>	
<b>Date / Time:</b>	2007-1-16 10:21:17	<b>DUT Battery Model/No:</b>	
<b>Filename:</b>	HG-A7_1900_LH_TOUCHC HEEK_T.txt	<b>Probe Serial Number:</b>	0177
<b>Ambient Temperature:</b>	19.7°C	<b>Liquid Simulant:</b>	HEAD tissue
<b>Device Under Test:</b>	HG-A7	<b>Relative Permittivity:</b>	40.12
<b>Relative Humidity:</b>	49%	<b>Conductivity:</b>	1.394
<b>Phantom S/No:</b>	Head_381SH.csv	<b>Liquid Temperature:</b>	19.8°C
<b>Phantom Rotation:</b>	0°	<b>Max SAR Y-axis Location:</b>	-64.33 mm
<b>DUT Position:</b>	HG-A7_LH_TOUCHCHEEK_T	<b>Max SAR Z-axis Location:</b>	-178.00 mm
<b>Antenna Configuration:</b>	BUILD INSIDE	<b>Max E Field:</b>	21.89 V/m
<b>Test Frequency:</b>	1900MHz	<b>SAR 1g:</b>	0.380 W/kg
<b>Air Factors:</b>	417 / 368 / 414	<b>SAR 10g:</b>	0.227 W/kg
<b>Conversion Factors:</b>	.325 / .325 / .325	<b>SAR Start:</b>	0.254 W/kg
<b>Type of Modulation:</b>		<b>SAR End:</b>	0.254 W/kg
<b>Modn. Duty Cycle:</b>		<b>SAR Drift during Scan:</b>	-0.02 %
<b>Diode Compression Factors (V*200):</b>	20 / 20 / 20	<b>Probe battery last changed:</b>	20/05/05
<b>Input Power Level:</b>	30dBm	<b>Extrapolation:</b>	poly4

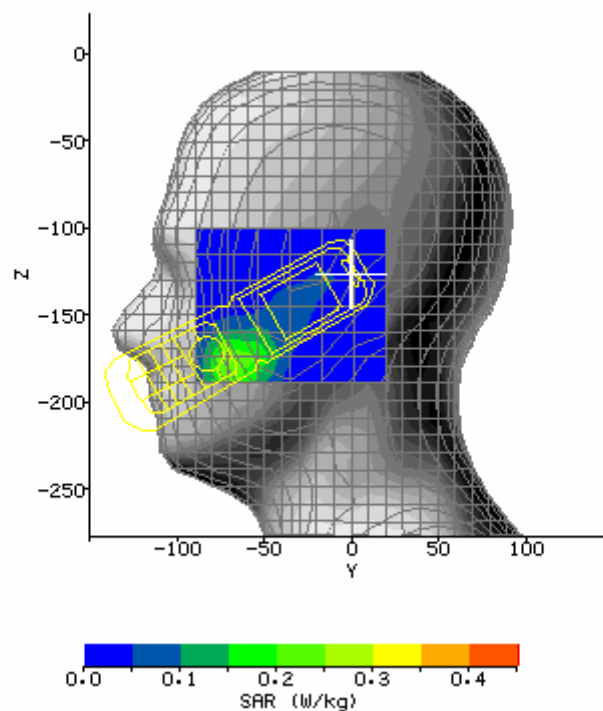

**SAR Test PCS 1900 LH\_Tilt15 (Bottom Channel)**

<b>System / software:</b>	SARA2 / 2.40 VPM	<b>Input Power Drift:</b>	
<b>Date / Time:</b>	2007-1-16 10:45:20	<b>DUT Battery Model/No:</b>	
<b>Filename:</b>	HG-A7_1900_LH_TILT15_B.txt	<b>Probe Serial Number:</b>	0177
<b>Ambient Temperature:</b>	19.7°C	<b>Liquid Simulant:</b>	HEAD tissue
<b>Device Under Test:</b>	HG-A7	<b>Relative Permittivity:</b>	39.87
<b>Relative Humidity:</b>	49%	<b>Conductivity:</b>	1.394
<b>Phantom S/No:</b>	Head_381SH.csv	<b>Liquid Temperature:</b>	19.8°C
<b>Phantom Rotation:</b>	0°	<b>Max SAR Y-axis Location:</b>	-46.00 mm
<b>DUT Position:</b>	HG-A7_LH_TILT15_B	<b>Max SAR Z-axis Location:</b>	-166.00 mm
<b>Antenna Configuration:</b>	BUILD INSIDE	<b>Max E Field:</b>	7.86 V/m
<b>Test Frequency:</b>	1900MHz	<b>SAR 1g:</b>	0.078 W/kg
<b>Air Factors:</b>	417 / 368 / 414	<b>SAR 10g:</b>	0.056 W/kg
<b>Conversion Factors:</b>	.325 / .325 / .325	<b>SAR Start:</b>	0.048 W/kg
<b>Type of Modulation:</b>		<b>SAR End:</b>	0.051 W/kg
<b>Modn. Duty Cycle:</b>		<b>SAR Drift during Scan:</b>	6.22 %
<b>Diode Compression Factors (V*200):</b>	20 / 20 / 20	<b>Probe battery last changed:</b>	20/05/05
<b>Input Power Level:</b>	30dBm	<b>Extrapolation:</b>	poly4

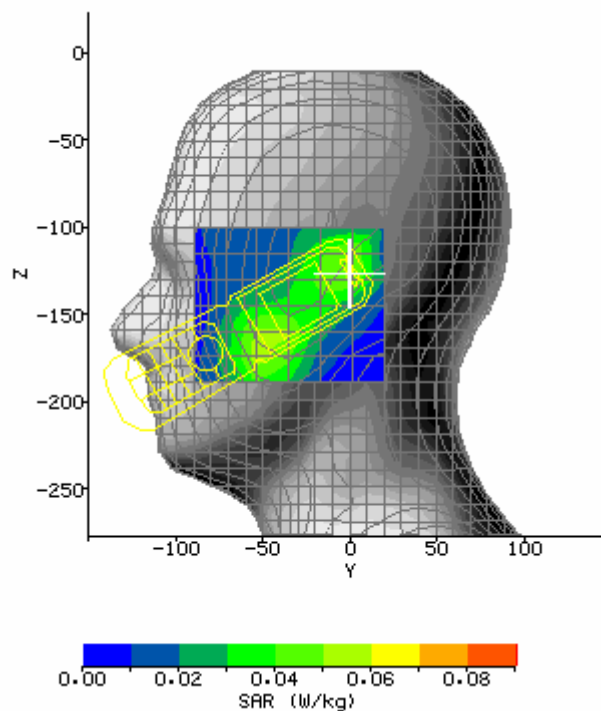

**SAR Test PCS 1900 LH\_Tilt15 (Middle Channel)**

<b>System / software:</b>	SARA2 / 2.40 VPM	<b>Input Power Drift:</b>	
<b>Date / Time:</b>	2007-1-16 11:04:14	<b>DUT Battery Model/No:</b>	
<b>Filename:</b>	HG-A7_1900_LH_TILT15_M.txt	<b>Probe Serial Number:</b>	0177
<b>Ambient Temperature:</b>	19.7°C	<b>Liquid Simulant:</b>	HEAD tissue
<b>Device Under Test:</b>	HG-A7	<b>Relative Permittivity:</b>	39.87
<b>Relative Humidity:</b>	49%	<b>Conductivity:</b>	1.394
<b>Phantom S/No:</b>	Head_381SH.csv	<b>Liquid Temperature:</b>	19.8°C
<b>Phantom Rotation:</b>	0°	<b>Max SAR Y-axis Location:</b>	-46.00 mm
<b>DUT Position:</b>	HG-A7_LH_TILT15_M	<b>Max SAR Z-axis Location:</b>	-166.00 mm
<b>Antenna Configuration:</b>	BUILD INSIDE	<b>Max E Field:</b>	7.81 V/m
<b>Test Frequency:</b>	1900MHz	<b>SAR 1g:</b>	0.079 W/kg
<b>Air Factors:</b>	417 / 368 / 414	<b>SAR 10g:</b>	0.054 W/kg
<b>Conversion Factors:</b>	.325 / .325 / .325	<b>SAR Start:</b>	0.045 W/kg
<b>Type of Modulation:</b>		<b>SAR End:</b>	0.046 W/kg
<b>Modn. Duty Cycle:</b>		<b>SAR Drift during Scan:</b>	3.08 %
<b>Diode Compression Factors (V*200):</b>	20 / 20 / 20	<b>Probe battery last changed:</b>	20/05/05
<b>Input Power Level:</b>	30dBm	<b>Extrapolation:</b>	poly4

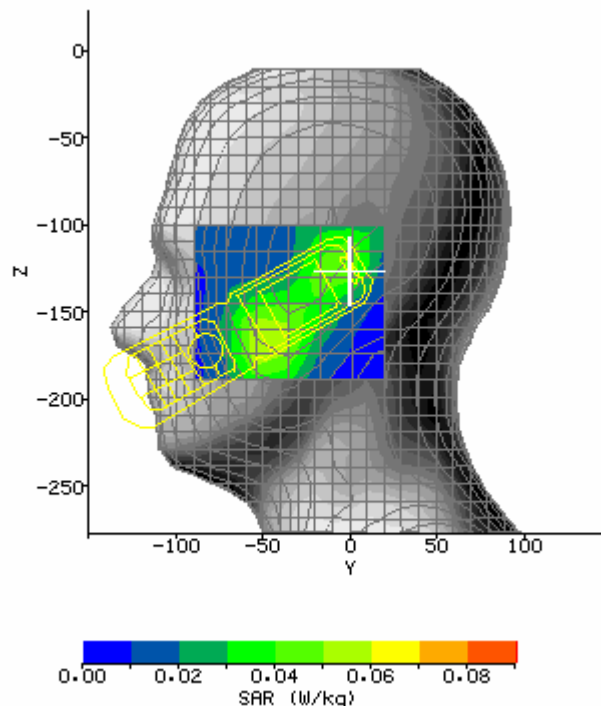



### SAR Test PCS 1900 LH\_Tilt15 (Top Channel)

<b>System / software:</b>	SARA2 / 2.40 VPM	<b>Input Power Drift:</b>	
<b>Date / Time:</b>	2007-1-16 11:23:22	<b>DUT Battery Model/No:</b>	
<b>Filename:</b>	HG-A7_1900_LH_TILT15_T.txt	<b>Probe Serial Number:</b>	0177
<b>Ambient Temperature:</b>	19.7°C	<b>Liquid Simulant:</b>	HEAD tissue
<b>Device Under Test:</b>	HG-A7	<b>Relative Permittivity:</b>	39.87
<b>Relative Humidity:</b>	49%	<b>Conductivity:</b>	1.394
<b>Phantom S/No:</b>	Head_381SH.csv	<b>Liquid Temperature:</b>	19.8°C
<b>Phantom Rotation:</b>	0°	<b>Max SAR Y-axis Location:</b>	-36.83 mm
<b>DUT Position:</b>	HG-A7_LH_TILT15_T	<b>Max SAR Z-axis Location:</b>	-155.50 mm
<b>Antenna Configuration:</b>	BUILD INSIDE	<b>Max E Field:</b>	6.26 V/m
<b>Test Frequency:</b>	1900MHz	<b>SAR 1g:</b>	0.050 W/kg
<b>Air Factors:</b>	417 / 368 / 414	<b>SAR 10g:</b>	0.038 W/kg
<b>Conversion Factors:</b>	.325 / .325 / .325	<b>SAR Start:</b>	0.027 W/kg
<b>Type of Modulation:</b>		<b>SAR End:</b>	0.028 W/kg
<b>Modn. Duty Cycle:</b>		<b>SAR Drift during Scan:</b>	4.60 %
<b>Diode Compression Factors (V*200):</b>	20 / 20 / 20	<b>Probe battery last changed:</b>	20/05/05
<b>Input Power Level:</b>	30dBm	<b>Extrapolation:</b>	poly4

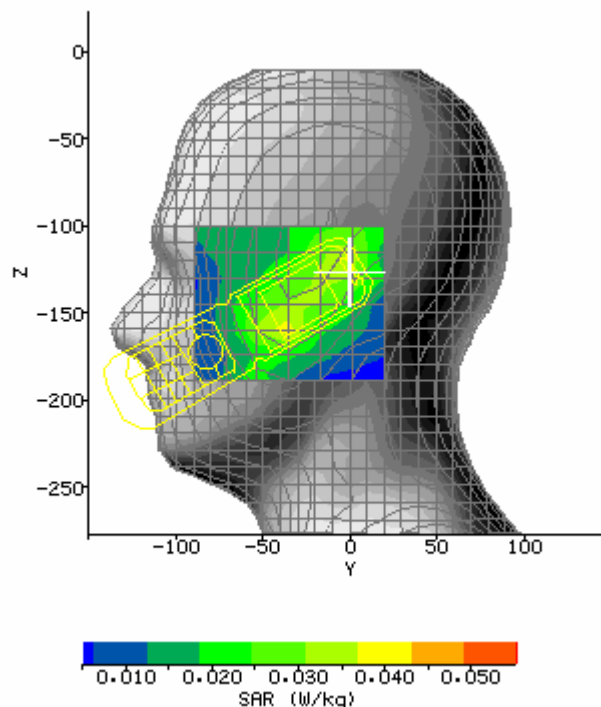

### SAR Test PCS 1900 RH\_Touchcheek (Bottom Channel)

<b>System / software:</b>	SARA2 / 2.40 VPM	<b>Input Power Drift:</b>	
<b>Date / Time:</b>	2007-1-16 11 :53:08	<b>DUT Battery Model/No:</b>	
<b>Filename:</b>	HG- A7_1900_RH_TOUCH CHEEK_B.txt	<b>Probe Serial Number:</b>	0177
<b>Ambient Temperature:</b>	19.7°C	<b>Liquid Simulant:</b>	HEAD tissue
<b>Device Under Test:</b>	HG-A7	<b>Relative Permittivity:</b>	39.87
<b>Relative Humidity:</b>	49%	<b>Conductivity:</b>	1.394
<b>Phantom S/No:</b>	Head_381SH.csv	<b>Liquid Temperature:</b>	19.8°C
<b>Phantom Rotation:</b>	180°	<b>Max SAR Y-axis Location:</b>	71.67 mm
<b>DUT Position:</b>	HG- A7_RH_TOUCHCHEE K_B	<b>Max SAR Z-axis Location:</b>	-169.00 mm
<b>Antenna Configuration:</b>	BUILD INSIDE	<b>Max E Field:</b>	21.65 V/m
<b>Test Frequency:</b>	1900MHz	<b>SAR 1g:</b>	0.618 W/kg
<b>Air Factors:</b>	417 / 368 / 414	<b>SAR 10g:</b>	0.364 W/kg
<b>Conversion Factors:</b>	.325 / .325 / .325	<b>SAR Start:</b>	0.379 W/kg
<b>Type of Modulation:</b>		<b>SAR End:</b>	0.391 W/kg
<b>Modn. Duty Cycle:</b>		<b>SAR Drift during Scan:</b>	3.11 %
<b>Diode Compression Factors (V*200):</b>	20 / 20 / 20	<b>Probe battery last changed:</b>	20/05/05
<b>Input Power Level:</b>	30dBm	<b>Extrapolation:</b>	poly4

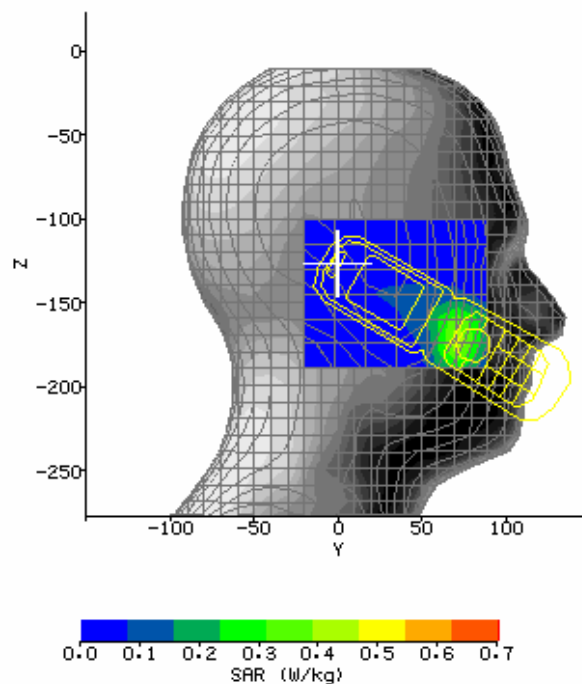

**SAR Test PCS 1900 RH\_Touchcheek (Middle Channel)**

<b>System / software:</b>	SARA2 / 2.40 VPM	<b>Input Power Drift:</b>	
<b>Date / Time:</b>	2007-1-16 12:14:47	<b>DUT Battery Model/No:</b>	
<b>Filename:</b>	HG-A7_1900_RH_TOUCHCHEEK_M.txt	<b>Probe Serial Number:</b>	0177
<b>Ambient Temperature:</b>	19.7°C	<b>Liquid Simulant:</b>	HEAD tissue
<b>Device Under Test:</b>	HG-A7	<b>Relative Permittivity:</b>	39.87
<b>Relative Humidity:</b>	49%	<b>Conductivity:</b>	1.394
<b>Phantom S/No:</b>	Head_381SH.csv	<b>Liquid Temperature:</b>	19.8°C
<b>Phantom Rotation:</b>	180°	<b>Max SAR Y-axis Location:</b>	71.67 mm
<b>DUT Position:</b>	HG-A7_RH_TOUCHCHEEK_M	<b>Max SAR Z-axis Location:</b>	-169.00 mm
<b>Antenna Configuration:</b>	BUILD INSIDE	<b>Max E Field:</b>	20.72 V/m
<b>Test Frequency:</b>	1900MHz	<b>SAR 1g:</b>	0.511 W/kg
<b>Air Factors:</b>	417 / 368 / 414	<b>SAR 10g:</b>	0.331 W/kg
<b>Conversion Factors:</b>	.325 / .325 / .325	<b>SAR Start:</b>	0.362 W/kg
<b>Type of Modulation:</b>		<b>SAR End:</b>	0.365 W/kg
<b>Modn. Duty Cycle:</b>		<b>SAR Drift during Scan:</b>	0.93 %
<b>Diode Compression Factors (V*200):</b>	20 / 20 / 20	<b>Probe battery last changed:</b>	20/05/05
<b>Input Power Level:</b>	30dBm	<b>Extrapolation:</b>	poly4

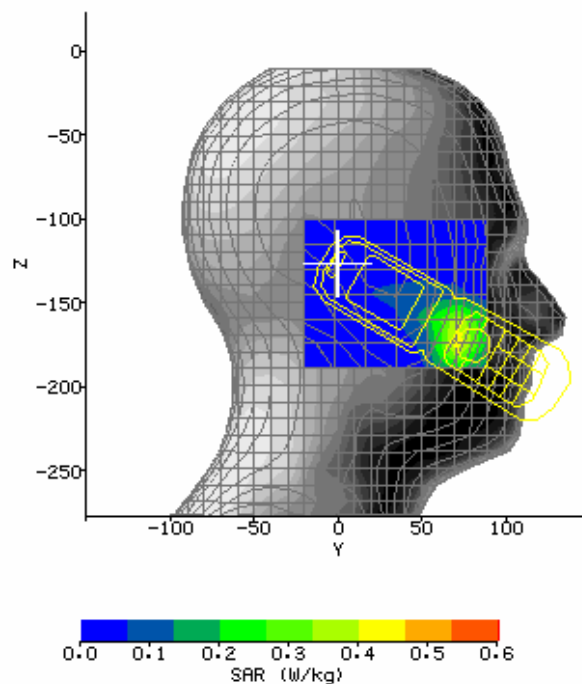

### SAR Test PCS 1900 RH\_Touchcheek (Top Channel)

<b>System / software:</b>	SARA2 / 2.40 VPM	<b>Input Power Drift:</b>	
<b>Date / Time:</b>	2007-1-16 13:39:56	<b>DUT Battery Model/No:</b>	
<b>Filename:</b>	HG- A7_1900_RH_TOUCH CHEEK_T.txt	<b>Probe Serial Number:</b>	0177
<b>Ambient Temperature:</b>	19.7°C	<b>Liquid Simulant:</b>	HEAD tissue
<b>Device Under Test:</b>	HG-A7	<b>Relative Permittivity:</b>	39.87
<b>Relative Humidity:</b>	49%	<b>Conductivity:</b>	1.394
<b>Phantom S/No:</b>	Head_381SH.csv	<b>Liquid Temperature:</b>	19.8°C
<b>Phantom Rotation:</b>	180°	<b>Max SAR Y-axis Location:</b>	68.00 mm
<b>DUT Position:</b>	HG- A7_RH_TOUCHCHEE K_T	<b>Max SAR Z-axis Location:</b>	-166.00 mm
<b>Antenna Configuration:</b>	BUILD INSIDE	<b>Max E Field:</b>	13.49 V/m
<b>Test Frequency:</b>	1900MHz	<b>SAR 1g:</b>	0.206 W/kg
<b>Air Factors:</b>	417 / 368 / 414	<b>SAR 10g:</b>	0.132 W/kg
<b>Conversion Factors:</b>	.325 / .325 / .325	<b>SAR Start:</b>	0.125 W/kg
<b>Type of Modulation:</b>		<b>SAR End:</b>	0.128 W/kg
<b>Modn. Duty Cycle:</b>		<b>SAR Drift during Scan:</b>	2.43 %
<b>Diode Compression Factors (V*200):</b>	20 / 20 / 20	<b>Probe battery last changed:</b>	20/05/05
<b>Input Power Level:</b>	30dBm	<b>Extrapolation:</b>	poly4

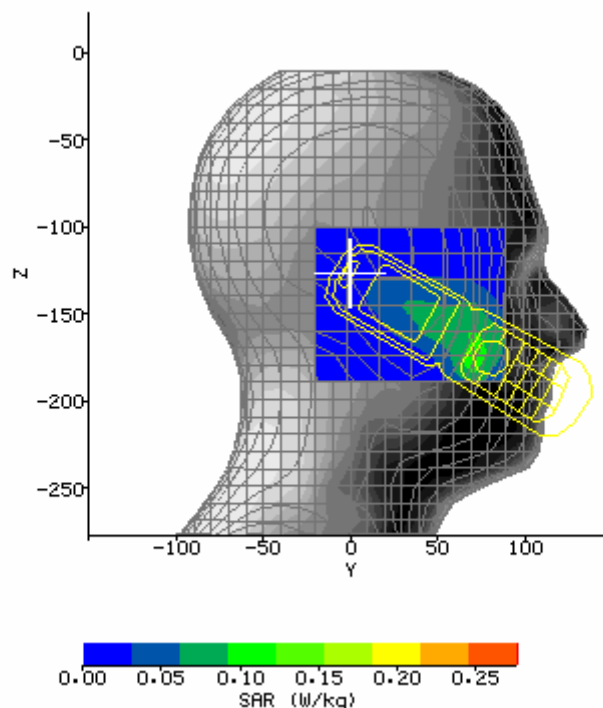

**SAR Test PCS 1900 RH\_Tilt15 (Bottom Channel)**

<b>System / software:</b>	SARA2 / 2.40 VPM	<b>Input Power Drift:</b>	
<b>Date / Time:</b>	2007-1-16 13:59:52	<b>DUT Battery Model/No:</b>	
<b>Filename:</b>	HG-A7_1900_RH_TILT15_B.txt	<b>Probe Serial Number:</b>	0177
<b>Ambient Temperature:</b>	19.7°C	<b>Liquid Simulant:</b>	HEAD tissue
<b>Device Under Test:</b>	HG-A7	<b>Relative Permittivity:</b>	39.87
<b>Relative Humidity:</b>	49%	<b>Conductivity:</b>	1.394
<b>Phantom S/No:</b>	Head_381SH.csv	<b>Liquid Temperature:</b>	19.8°C
<b>Phantom Rotation:</b>	180°	<b>Max SAR Y-axis Location:</b>	2.17 mm
<b>DUT Position:</b>	HG-A7_RH_TILT15_B	<b>Max SAR Z-axis Location:</b>	-123.17 mm
<b>Antenna Configuration:</b>	BUILD INSIDE	<b>Max E Field:</b>	9.38 V/m
<b>Test Frequency:</b>	1900MHz	<b>SAR 1g:</b>	0.117 W/kg
<b>Air Factors:</b>	417 / 368 / 414	<b>SAR 10g:</b>	0.075 W/kg
<b>Conversion Factors:</b>	.325 / .325 / .325	<b>SAR Start:</b>	0.062 W/kg
<b>Type of Modulation:</b>		<b>SAR End:</b>	0.064 W/kg
<b>Modn. Duty Cycle:</b>		<b>SAR Drift during Scan:</b>	4.10 %
<b>Diode Compression Factors (V*200):</b>	20 / 20 / 20	<b>Probe battery last changed:</b>	20/05/05
<b>Input Power Level:</b>	30dBm	<b>Extrapolation:</b>	poly4

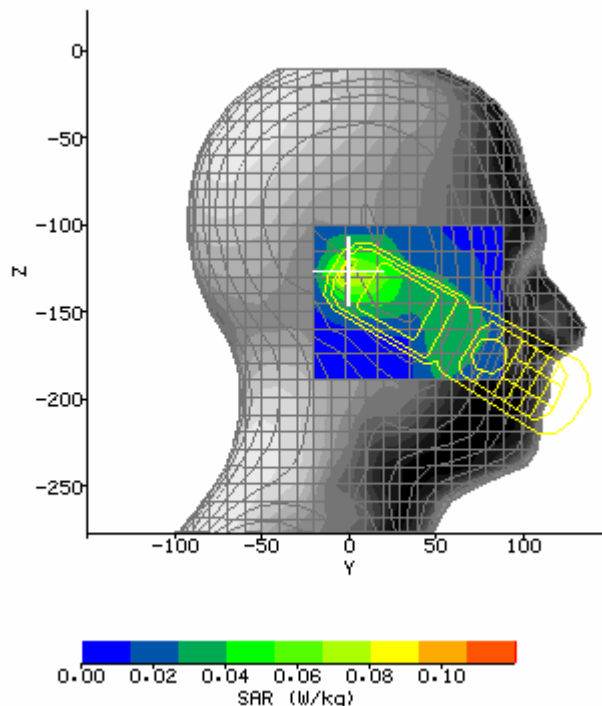

**SAR Test PCS 1900 RH\_Tilt15 (Middle Channel)**

<b>System / software:</b>	SARA2 / 2.40 VPM	<b>Input Power Drift:</b>	
<b>Date / Time:</b>	2007-1-16 13:53:59	<b>DUT Battery Model/No:</b>	
<b>Filename:</b>	HG-A7_1900_RH_TILT15_M.txt	<b>Probe Serial Number:</b>	0177
<b>Ambient Temperature:</b>	19.7°C	<b>Liquid Simulant:</b>	HEAD tissue
<b>Device Under Test:</b>	HG-A7	<b>Relative Permittivity:</b>	39.87
<b>Relative Humidity:</b>	49%	<b>Conductivity:</b>	1.394
<b>Phantom S/No:</b>	Head_381SH.csv	<b>Liquid Temperature:</b>	19.8°C
<b>Phantom Rotation:</b>	180°	<b>Max SAR Y-axis Location:</b>	7.50 mm
<b>DUT Position:</b>	HG-A7_RH_TILT15_M	<b>Max SAR Z-axis Location:</b>	-130.00 mm
<b>Antenna Configuration:</b>	BUILD INSIDE	<b>Max E Field:</b>	9.16 V/m
<b>Test Frequency:</b>	1900MHz	<b>SAR 1g:</b>	0.099 W/kg
<b>Air Factors:</b>	417 / 368 / 414	<b>SAR 10g:</b>	0.065 W/kg
<b>Conversion Factors:</b>	.325 / .325 / .325	<b>SAR Start:</b>	0.055 W/kg
<b>Type of Modulation:</b>		<b>SAR End:</b>	0.057 W/kg
<b>Modn. Duty Cycle:</b>		<b>SAR Drift during Scan:</b>	4.33 %
<b>Diode Compression Factors (V*200):</b>	20 / 20 / 20	<b>Probe battery last changed:</b>	20/05/05
<b>Input Power Level:</b>	30dBm	<b>Extrapolation:</b>	poly4

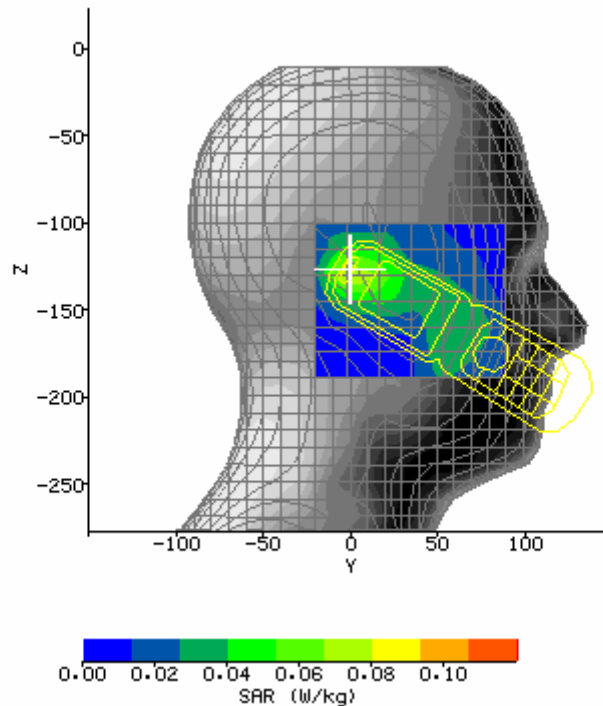

### SAR Test PCS 1900 RH\_Tilt15 (Top Channel)

<b>System / software:</b>	SARA2 / 2.40 VPM	<b>Input Power Drift:</b>	
<b>Date / Time:</b>	2007-1-16 14:21:52	<b>DUT Battery Model/No:</b>	
<b>Filename:</b>	HG-A7_1900_RH_TILT15_T.txt	<b>Probe Serial Number:</b>	0177
<b>Ambient Temperature:</b>	19.7°C	<b>Liquid Simulant:</b>	HEAD tissue
<b>Device Under Test:</b>	HG-A7	<b>Relative Permittivity:</b>	39.87
<b>Relative Humidity:</b>	49%	<b>Conductivity:</b>	1.394
<b>Phantom S/No:</b>	Head_381SH.csv	<b>Liquid Temperature:</b>	19.8°C
<b>Phantom Rotation:</b>	180°	<b>Max SAR Y-axis Location:</b>	7.50 mm
<b>DUT Position:</b>	HG-A7_RH_TILT15_T	<b>Max SAR Z-axis Location:</b>	-130.00 mm
<b>Antenna Configuration:</b>	BUILD INSIDE	<b>Max E Field:</b>	6.39 V/m
<b>Test Frequency:</b>	1900MHz	<b>SAR 1g:</b>	0.052 W/kg
<b>Air Factors:</b>	417 / 368 / 414	<b>SAR 10g:</b>	0.035 W/kg
<b>Conversion Factors:</b>	.325 / .325 / .325	<b>SAR Start:</b>	0.025 W/kg
<b>Type of Modulation:</b>		<b>SAR End:</b>	0.028 W/kg
<b>Modn. Duty Cycle:</b>		<b>SAR Drift during Scan:</b>	13.86 %
<b>Diode Compression Factors (V*200):</b>	20 / 20 / 20	<b>Probe battery last changed:</b>	20/05/05
<b>Input Power Level:</b>	30dBm	<b>Extrapolation:</b>	poly4

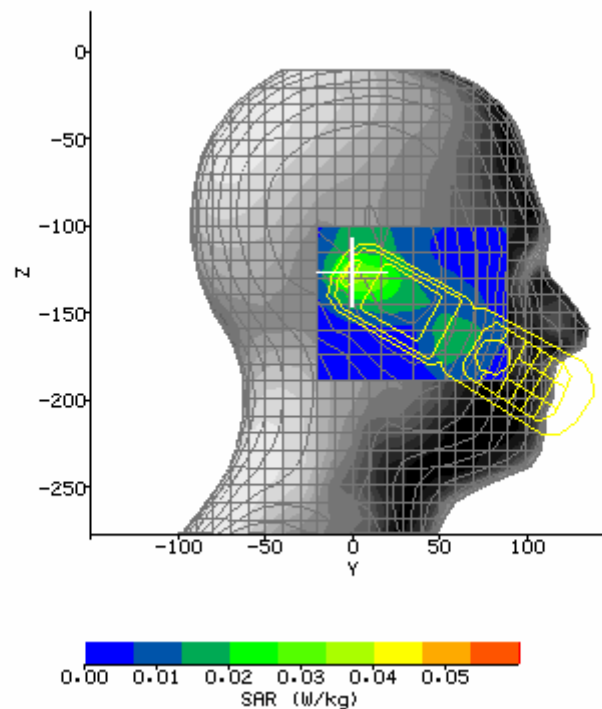

### SAR Test PCS 1900 Body (Bottom Channel)

<b>System / software:</b>	SARA2 / 2.40 VPM	<b>Input Power Drift:</b>	
<b>Date / Time:</b>	2007-1-16 14:44:23	<b>DUT Battery Model/No:</b>	
<b>Filename:</b>	HG- A7_1900_BODY_B.txt	<b>Probe Serial Number:</b>	0177
<b>Ambient Temperature:</b>	21.3°C	<b>Liquid Simulant:</b>	Body tissue
<b>Device Under Test:</b>	HG-A7	<b>Relative Permittivity:</b>	54.13
<b>Relative Humidity:</b>	54%	<b>Conductivity:</b>	1.526
<b>Phantom S/No:</b>	HeadBox75mm.csv	<b>Liquid Temperature:</b>	21.4°C
<b>Phantom Rotation:</b>	0°	<b>Max SAR X-axis Location:</b>	6.86 mm
<b>DUT Position:</b>	BODY	<b>Max SAR Y-axis Location:</b>	3.43 mm
<b>Antenna Configuration:</b>	BUILD INSIDE	<b>Max E Field:</b>	10.88 V/m
<b>Test Frequency:</b>	1900MHz	<b>SAR 1g:</b>	0.218 W/kg
<b>Air Factors:</b>	417 / 368 / 414	<b>SAR 10g:</b>	0.138 W/kg
<b>Conversion Factors:</b>	.356 / .356 / .356	<b>SAR Start:</b>	0.044 W/kg
<b>Type of Modulation:</b>		<b>SAR End:</b>	0.045 W/kg
<b>Modn. Duty Cycle:</b>		<b>SAR Drift during Scan:</b>	2.19 %
<b>Diode Compression Factors (V*200):</b>	20 / 20 / 20	<b>Probe battery last changed:</b>	20/05/05
<b>Input Power Level:</b>	Max Power	<b>Extrapolation:</b>	poly4

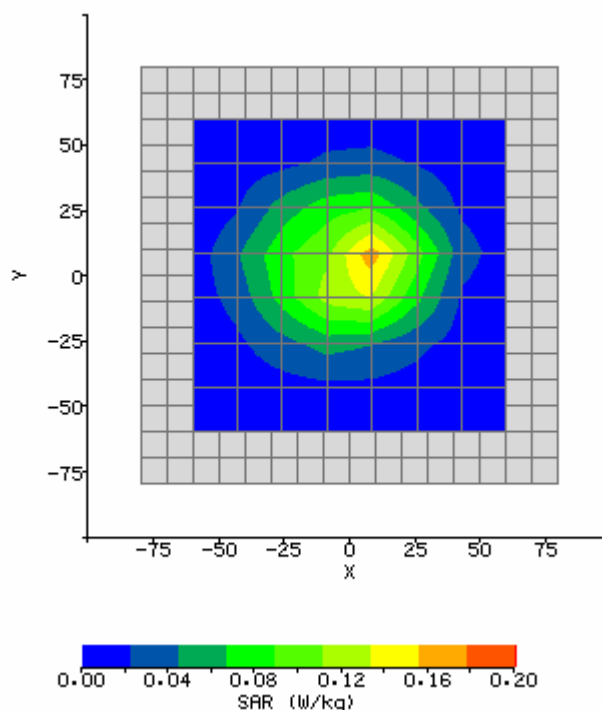



### SAR Test PCS 1900 Body (Middle Channel)

<b>System / software:</b>	SARA2 / 2.40 VPM	<b>Input Power Drift:</b>	
<b>Date / Time:</b>	2007-1-16 15:16:33	<b>DUT Battery Model/No:</b>	
<b>Filename:</b>	HG- A7_1900_BODY_M.txt	<b>Probe Serial Number:</b>	0177
<b>Ambient Temperature:</b>	21.3°C	<b>Liquid Simulant:</b>	Body tissue
<b>Device Under Test:</b>	HG-A7	<b>Relative Permittivity:</b>	54.13
<b>Relative Humidity:</b>	54%	<b>Conductivity:</b>	1.526
<b>Phantom S/No:</b>	HeadBox75mm.csv	<b>Liquid Temperature:</b>	21.4°C
<b>Phantom Rotation:</b>	0°	<b>Max SAR X-axis Location:</b>	6.86 mm
<b>DUT Position:</b>	BODY	<b>Max SAR Y-axis Location:</b>	3.43 mm
<b>Antenna Configuration:</b>	BUILD INSIDE	<b>Max E Field:</b>	10.85 V/m
<b>Test Frequency:</b>	1900MHz	<b>SAR 1g:</b>	0.212 W/kg
<b>Air Factors:</b>	417 / 368 / 414	<b>SAR 10g:</b>	0.124 W/kg
<b>Conversion Factors:</b>	.356 / .356 / .356	<b>SAR Start:</b>	0.039 W/kg
<b>Type of Modulation:</b>		<b>SAR End:</b>	0.041 W/kg
<b>Modn. Duty Cycle:</b>		<b>SAR Drift during Scan:</b>	4.96 %
<b>Diode Compression Factors (V*200):</b>	20 / 20 / 20	<b>Probe battery last changed:</b>	20/05/05
<b>Input Power Level:</b>	Max Power	<b>Extrapolation:</b>	poly4

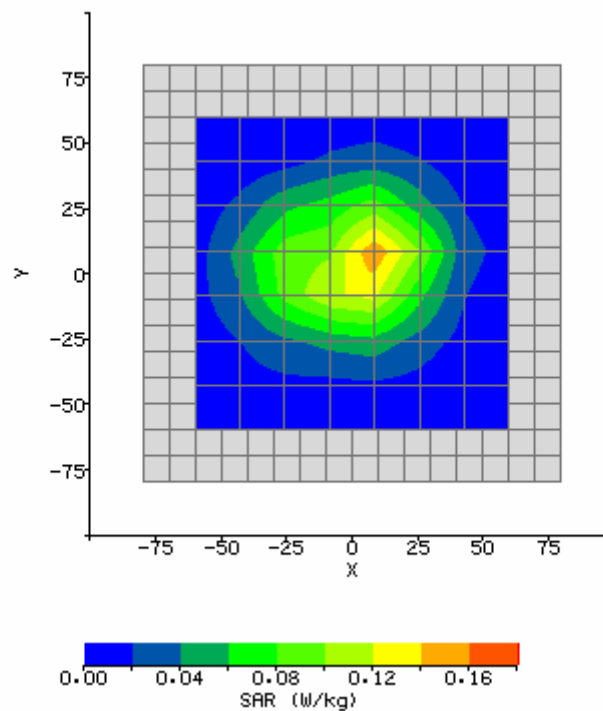

### SAR Test PCS 1900 Body (Top Channel)

<b>System / software:</b>	SARA2 / 2.40 VPM	<b>Input Power Drift:</b>	
<b>Date / Time:</b>	2007-1-16 15:46:14	<b>DUT Battery Model/No:</b>	
<b>Filename:</b>	HG- A7_1900_BODY_T.txt	<b>Probe Serial Number:</b>	0177
<b>Ambient Temperature:</b>	21.3°C	<b>Liquid Simulant:</b>	Body tissue
<b>Device Under Test:</b>	HG-A7	<b>Relative Permittivity:</b>	54.13
<b>Relative Humidity:</b>	54%	<b>Conductivity:</b>	1.526
<b>Phantom S/No:</b>	HeadBox75mm.csv	<b>Liquid Temperature:</b>	21.4°C
<b>Phantom Rotation:</b>	0°	<b>Max SAR X-axis Location:</b>	6.86 mm
<b>DUT Position:</b>	BODY	<b>Max SAR Y-axis Location:</b>	1.71 mm
<b>Antenna Configuration:</b>	BUILD INSIDE	<b>Max E Field:</b>	8.50 V/m
<b>Test Frequency:</b>	1900MHz	<b>SAR 1g:</b>	0.128 W/kg
<b>Air Factors:</b>	417 / 368 / 414	<b>SAR 10g:</b>	0.077 W/kg
<b>Conversion Factors:</b>	.356 / .356 / .356	<b>SAR Start:</b>	0.023 W/kg
<b>Type of Modulation:</b>		<b>SAR End:</b>	0.023 W/kg
<b>Modn. Duty Cycle:</b>		<b>SAR Drift during Scan:</b>	-0.26 %
<b>Diode Compression Factors (V*200):</b>	20 / 20 / 20	<b>Probe battery last changed:</b>	20/05/05
<b>Input Power Level:</b>	Max Power	<b>Extrapolation:</b>	poly4

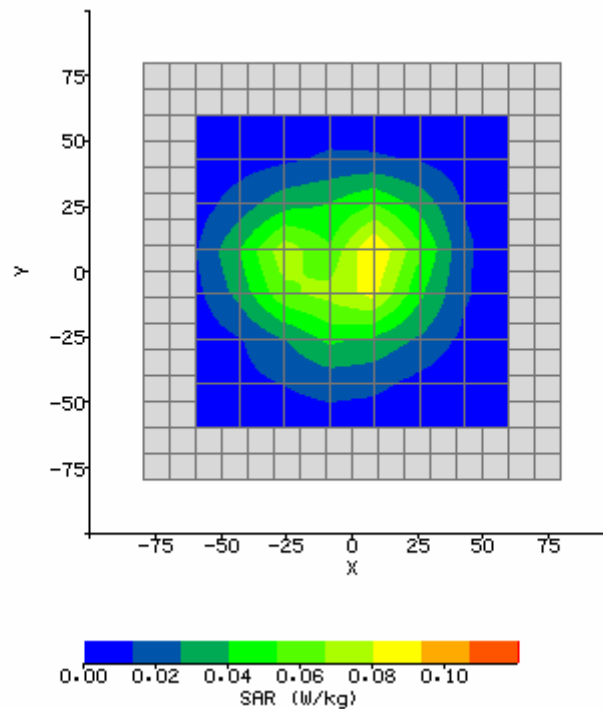

**SAR Test PCS 1900 Body (Bottom Channel, with Headphone)**

<b>System / software:</b>	SARA2 / 2.40 VPM	<b>Input Power Drift:</b>	
<b>Date / Time:</b>	2007-1-16 16:19:07	<b>DUT Battery Model/No:</b>	
<b>Filename:</b>	HG-A7_1900_BODY_B_WITHHEADPHONE.txt	<b>Probe Serial Number:</b>	0177
<b>Ambient Temperature:</b>	21.3°C	<b>Liquid Simulant:</b>	Body tissue
<b>Device Under Test:</b>	HG-A7	<b>Relative Permittivity:</b>	54.13
<b>Relative Humidity:</b>	54%	<b>Conductivity:</b>	1.526
<b>Phantom S/No:</b>	HeadBox75mm.csv	<b>Liquid Temperature:</b>	21.4°C
<b>Phantom Rotation:</b>	0°	<b>Max SAR X-axis Location:</b>	-8.57 mm
<b>DUT Position:</b>	BODY	<b>Max SAR Y-axis Location:</b>	5.14 mm
<b>Antenna Configuration:</b>	BUILD INSIDE	<b>Max E Field:</b>	13.52 V/m
<b>Test Frequency:</b>	1900MHz	<b>SAR 1g:</b>	0.352 W/kg
<b>Air Factors:</b>	417 / 368 / 414	<b>SAR 10g:</b>	0.194 W/kg
<b>Conversion Factors:</b>	.356 / .356 / .356	<b>SAR Start:</b>	0.046 W/kg
<b>Type of Modulation:</b>		<b>SAR End:</b>	0.044 W/kg
<b>Modn. Duty Cycle:</b>		<b>SAR Drift during Scan:</b>	-4.74 %
<b>Diode Compression Factors (V*200):</b>	20 / 20 / 20	<b>Probe battery last changed:</b>	20/05/05
<b>Input Power Level:</b>	Max Power	<b>Extrapolation:</b>	poly4

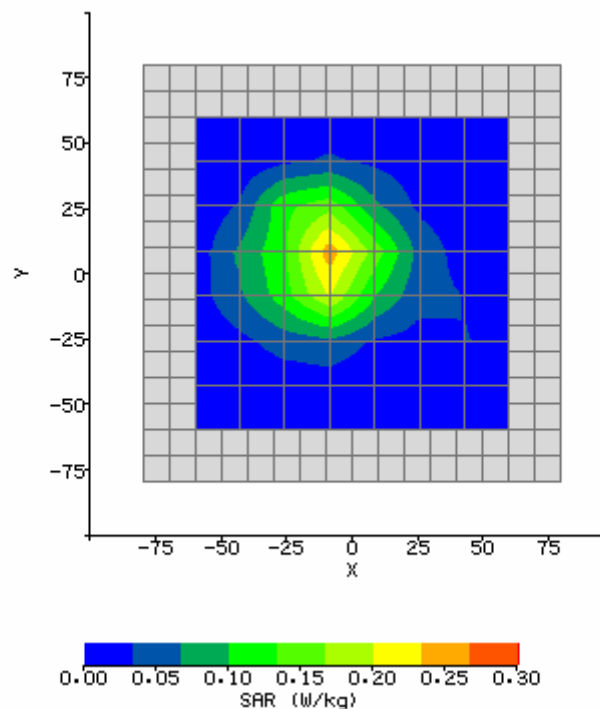

**SAR Test PCS 1900 Body (Bottom Channel, face to Bottom)**

<b>System / software:</b>	SARA2 / 2.40 VPM	<b>Input Power Drift:</b>	
<b>Date / Time:</b>	2007-1-16 16:44:42	<b>DUT Battery Model/No:</b>	
<b>Filename:</b>	HG- A7_1900_BODY_B_FA CETOBOTTOM.txt	<b>Probe Serial Number:</b>	0177
<b>Ambient Temperature:</b>	21.3°C	<b>Liquid Simulant:</b>	Body tissue
<b>Device Under Test:</b>	HG-A7	<b>Relative Permittivity:</b>	54.13
<b>Relative Humidity:</b>	54%	<b>Conductivity:</b>	1.526
<b>Phantom S/No:</b>	HeadBox75mm.csv	<b>Liquid Temperature:</b>	21.4°C
<b>Phantom Rotation:</b>	0°	<b>Max SAR X-axis Location:</b>	-24.00 mm
<b>DUT Position:</b>	BODY	<b>Max SAR Y-axis Location:</b>	5.14 mm
<b>Antenna Configuration:</b>	BUILD INSIDE	<b>Max E Field:</b>	12.25 V/m
<b>Test Frequency:</b>	1900MHz	<b>SAR 1g:</b>	0.280 W/kg
<b>Air Factors:</b>	417 / 368 / 414	<b>SAR 10g:</b>	0.162 W/kg
<b>Conversion Factors:</b>	.356 / .356 / .356	<b>SAR Start:</b>	0.034 W/kg
<b>Type of Modulation:</b>		<b>SAR End:</b>	0.034 W/kg
<b>Modn. Duty Cycle:</b>		<b>SAR Drift during Scan:</b>	-0.71 %
<b>Diode Compression Factors (V*200):</b>	20 / 20 / 20	<b>Probe battery last changed:</b>	20/05/05
<b>Input Power Level:</b>	Max Power	<b>Extrapolation:</b>	poly4

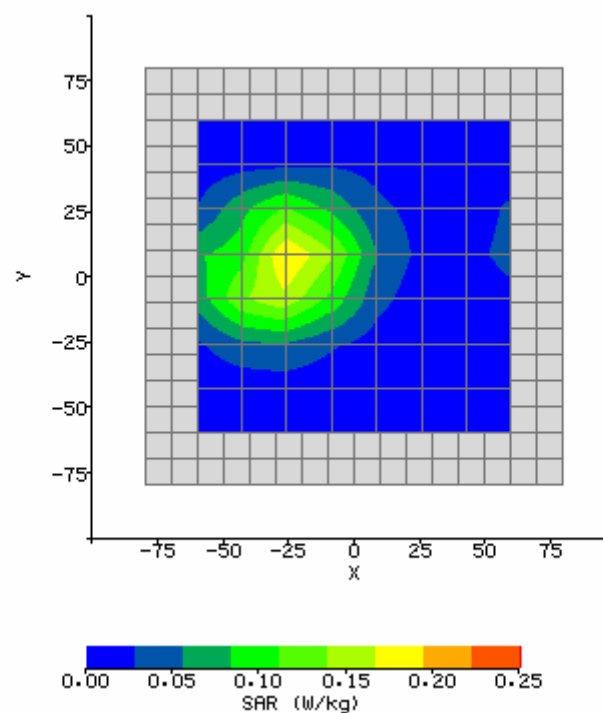

**ANNEX E**  
**of**  
**ShenZhen Morlab Communications Technology Co.,Ltd.**

**CONFORMANCE TEST REPORT FOR**  
**HUMAN EXPOSURE TO ELECTROMAGNETIC FIELDS**

REPORT NO: SZ06120009S01

**Qingdao Haier Telecom Co., Ltd.**

**GSM Mobile Phone**

Type Name: **HG-A7**

**System Performance Check Data**



### System Check Head 850MHz

<b>System / software:</b>	SARA2 / 2.40 VPM	<b>Input Power Drift:</b>	-0.03dB
<b>Date / Time:</b>	2007-1-15 8:15:12	<b>DUT Battery Model/No:</b>	
<b>Filename:</b>	System Cheek_Head _850MHz.txt	<b>Probe Serial Number:</b>	0177
<b>Ambient Temperature:</b>	23.3°C	<b>Liquid Simulant:</b>	Head tissue
<b>Device Under Test:</b>	IXD-090antenna (250mw)	<b>Relative Permittivity:</b>	41.58
<b>Relative Humidity:</b>	59%	<b>Conductivity:</b>	0.902
<b>Phantom S/No:</b>	HeadBox75mm.csv	<b>Liquid Temperature:</b>	21.3°C
<b>Phantom Rotation:</b>	0°	<b>Max SAR Y-axis Location:</b>	4.12 mm
<b>DUT Position:</b>	850_Head	<b>Max SAR Z-axis Location:</b>	-212.09 mm
<b>Antenna Configuration:</b>	IXD-090antenna	<b>Max E Field:</b>	47.03 V/m
<b>Test Frequency:</b>	850MHz	<b>SAR 1g:</b>	2.652 W/kg
<b>Air Factors:</b>	417.2 / 368.0 / 414.8	<b>SAR 10g:</b>	1.768 W/kg
<b>Conversion Factors:</b>	.287 / .287 / .287	<b>SAR Start:</b>	0.615 W/kg
<b>Type of Modulation:</b>	/	<b>SAR End:</b>	0.599 W/kg
<b>Modn. Duty Cycle:</b>	1	<b>SAR Drift during Scan:</b>	-2.58 %
<b>Diode Compression Factors (V*200):</b>	20 / 20 / 20	<b>Probe battery last changed:</b>	20/05/05
<b>Input Power Level:</b>	24dBm	<b>Extrapolation:</b>	poly4

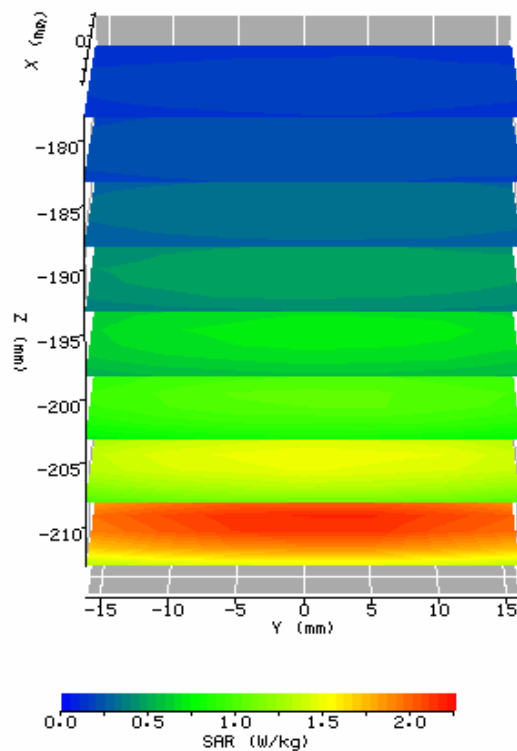

### System Check body 850MHz

<b>System / software:</b>	SARA2 / 2.40 VPM	<b>Input Power Drift:</b>	0.02dB
<b>Date / Time:</b>	2007-1-15 8:44:12	<b>DUT Battery Model/No:</b>	
<b>Filename:</b>	System Cheek_Body _850MHz.txt	<b>Probe Serial Number:</b>	0177
<b>Ambient Temperature:</b>	23.5°C	<b>Liquid Simulant:</b>	Body tissue
<b>Device Under Test:</b>	IXD-090antenna (250mw)	<b>Relative Permittivity:</b>	55.47
<b>Relative Humidity:</b>	57%	<b>Conductivity:</b>	0.972
<b>Phantom S/No:</b>	HeadBox75mm.csv	<b>Liquid Temperature:</b>	21.3°C
<b>Phantom Rotation:</b>	0°	<b>Max SAR X-axis Location:</b>	0.00 mm
<b>DUT Position:</b>	850_Body	<b>Max SAR Y-axis Location:</b>	0.00 mm
<b>Antenna Configuration:</b>	IXD-090antenna	<b>Max E Field:</b>	44.80 V/m
<b>Test Frequency:</b>	850MHz	<b>SAR 1g:</b>	2.617 W/kg
<b>Air Factors:</b>	417 / 368 / 414	<b>SAR 10g:</b>	1.680W/kg
<b>Conversion Factors:</b>	.271 / .271 / .271	<b>SAR Start:</b>	0.561 W/kg
<b>Type of Modulation:</b>	/	<b>SAR End:</b>	0.564 W/kg
<b>Modn. Duty Cycle:</b>	1	<b>SAR Drift during Scan:</b>	0.52 %
<b>Diode Compression Factors (V*200):</b>	20 / 20 / 20	<b>Probe battery last changed:</b>	20/05/05
<b>Input Power Level:</b>	24dBm	<b>Extrapolation:</b>	poly4

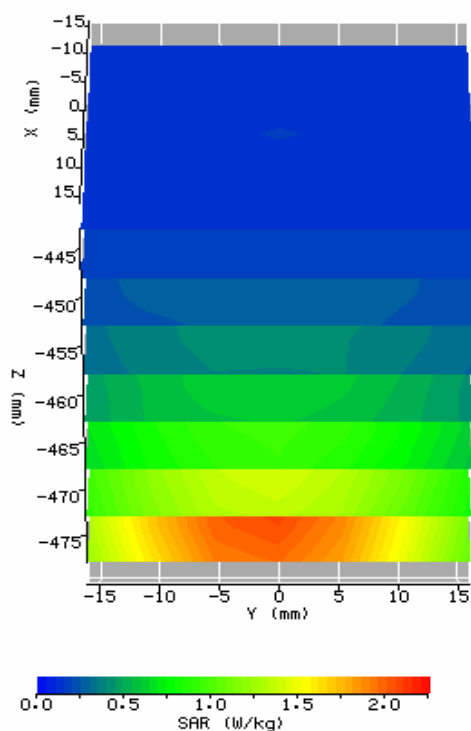

## System Check Head 1900MHz

<b>System / software:</b>	SARA2 / 2.40 VPM	<b>Input Power Drift:</b>	-0.01dB
<b>Date / Time:</b>	2007-1-16 8:18:15	<b>DUT Battery Model/No:</b>	
<b>Filename:</b>	System Cheek_Head _1900MHz.txt	<b>Probe Serial Number:</b>	0177
<b>Ambient Temperature:</b>	23.6°C	<b>Liquid Simulant:</b>	Head tissue
<b>Device Under Test:</b>	IXD-080antenna (250mw)	<b>Relative Permittivity:</b>	40.12
<b>Relative Humidity:</b>	56%	<b>Conductivity:</b>	1.394
<b>Phantom S/No:</b>	HeadBox75mm.csv	<b>Liquid Temperature:</b>	19.8°C
<b>Phantom Rotation:</b>	0°	<b>Max SAR Y-axis Location:</b>	0.00 mm
<b>DUT Position:</b>	1900_Head	<b>Max SAR Z-axis Location:</b>	-213.09 mm
<b>Antenna Configuration:</b>	IXD-080antenna	<b>Max E Field:</b>	76.86 V/m
<b>Test Frequency:</b>	1900MHz	<b>SAR 1g:</b>	10.113 W/kg
<b>Air Factors:</b>	417 / 368 / 414	<b>SAR 10g:</b>	5.607 W/kg
<b>Conversion Factors:</b>	.325 / .325 / .325	<b>SAR Start:</b>	1.477 W/kg
<b>Type of Modulation:</b>	/	<b>SAR End:</b>	1.473 W/kg
<b>Modn. Duty Cycle:</b>	1	<b>SAR Drift during Scan:</b>	-0.19 %
<b>Diode Compression Factors (V*200):</b>	20 / 20 / 20	<b>Probe battery last changed:</b>	20/05/05
<b>Input Power Level:</b>	24dBm	<b>Extrapolation:</b>	poly4

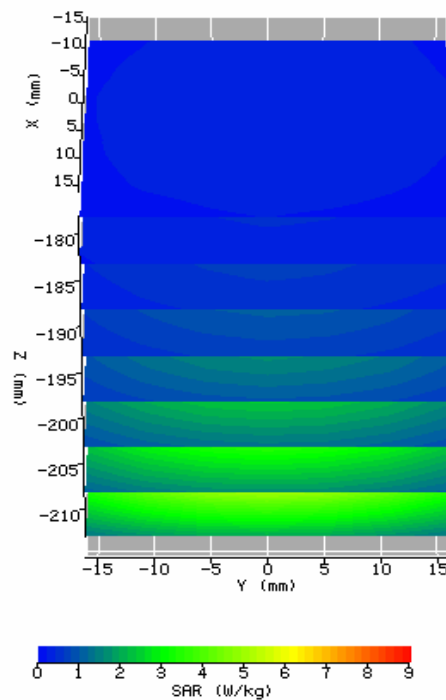



### System Check Body 1900 MHz

<b>System / software:</b>	SARA2 / 2.40 VPM	<b>Input Power Drift:</b>	0.01dB
<b>Date / Time:</b>	2007-1-16 8:40:23	<b>DUT Battery Model/No:</b>	
<b>Filename:</b>	System Cheek_Body _1900MHz.txt	<b>Probe Serial Number:</b>	0177
<b>Ambient Temperature:</b>	23.6°C	<b>Liquid Simulant:</b>	BODY tissue
<b>Device Under Test:</b>	IXD-080antenna (250mw)	<b>Relative Permittivity:</b>	54.13
<b>Relative Humidity:</b>	57%	<b>Conductivity:</b>	1.526
<b>Phantom S/No:</b>	HeadBox75mm.csv	<b>Liquid Temperature:</b>	21.4°C
<b>Phantom Rotation:</b>	0°	<b>Max SAR X-axis Location:</b>	0.00 mm
<b>DUT Position:</b>	1900_Body	<b>Max SAR Y-axis Location:</b>	0.00 mm
<b>Antenna Configuration:</b>	IXD-080antenna	<b>Max E Field:</b>	73.06 V/m
<b>Test Frequency:</b>	1900MHz	<b>SAR 1g:</b>	10.092 W/kg
<b>Air Factors:</b>	417 / 368 / 414	<b>SAR 10g:</b>	5.493 W/kg
<b>Conversion Factors:</b>	.356 / .356 / .356	<b>SAR Start:</b>	1.581 W/kg
<b>Type of Modulation:</b>	/	<b>SAR End:</b>	1.572 W/kg
<b>Modn. Duty Cycle:</b>	1	<b>SAR Drift during Scan:</b>	0.25 %
<b>Diode Compression Factors (V*200):</b>	20 / 20 / 20	<b>Probe battery last changed:</b>	20/05/05
<b>Input Power Level:</b>	24dBm	<b>Extrapolation:</b>	poly4

