FCC Test Report

Report No.: AGC19U120301F2B

FCC ID : SG71204HG-M168
PRODUCT DESIGNATION : GSM Mobile Phone
BRAND NAME : Haier
MODEL NAME : HG-M168
CLIENT : Haier Telecom (Qingdao) Co., Ltd.
DATE OF ISSUE : May 19, 2012
STANDARD(S) : FCC Part 15 Rules
REPORT VERSION : V1.0

Attestation of Global Compliance Co., Ltd.

CAUTION: This report shall not be reproduced except in full without the written permission of the test laboratory and shall not be quoted out of context.

VERIFICATION OF COMPLIANCE

Applicant:	Haier Telecom (Qingdao) Co., Ltd.
	Haier Information Park, NO.1 Haier Road, Hi-tech zone, Qingdao China, 266101
Manufacturer:	Haier Telecom (Qingdao) Co., Ltd.
	Haier Information Park, NO.1 Haier Road, Hi-tech zone, Qingdao China, 266101
Product Designation:	GSM Mobile Phone
Brand name:	Haier
Test Model:	HG-M168
FCC ID:	SG71204HG-M168
File Number:	AGC19U120301F2B
Date of test:	Apr. 27, 2012 to May 06, 2012

WE HEREBY CERTIFY THAT:

The above equipment was tested by Attestation of Global Compliance Co., Ltd. The test data, data evaluation, test procedures, and equipment configurations shown in this report were made in accordance with the procedures given in ANSI C63.4 (2003) and the energy emitted by the sample EUT tested as described in this report is in compliance with radiated emission limits of FCC Rules Part 15.247.

Tested By: _____



Leo Lee May 19, 2012

Reviewed By: _____



Forrest Lei May 19, 2012

Approved By: _____



Solger Zhang May 19, 2012

TABLE OF CONTENTS

1. GENERAL INFORMATION	4
1.1 PRODUCT DESCRIPTION	4
1.2 TABLE OF CARRIER FREQUENCIES	4
1.3 RECEIVER INPUT BANDWIDTH	4
1.4 EXAMPLE OF A HOPPING SEQUENCY IN DATA MODE	5
1.5 EQUALLY AVERAGE USE OF FREQUENCIES AND BEHAVIOUR	5
1.6 RELATED SUBMITTAL(S) / GRANT (S)	5
1.7 TEST METHODOLOGY	5
1.8 TEST FACILITY	6
1.9 SPECIAL ACCESSORIES	6
1.10 EQUIPMENT MODIFICATIONS	6
2. SYSTEM TEST CONFIGURATION	7
2.1 CONFIGURATION OF EUT SYSTEM	7
2.2 EQUIPMENT USED IN EUT SYSTEM	7
3. SUMMARY OF TEST RESULTS	8
4. DESCRIPTION OF TEST MODES	8
5. PEAK OUTPUT POWER	9
5.1 MEASUREMENT PROCEDURE	9
5.2 TEST SET-UP (BLOCK DIAGRAM OF CONFIGURATION)	9
5.3 MEASUREMENT EQUIPMENT USED	10
5.4 LIMITS AND MEASUREMENT RESULT	10
6. 20 DB BANDWIDTH	11
6.1 MEASUREMENT PROCEDURE	11
6.2 TEST SET-UP (BLOCK DIAGRAM OF CONFIGURATION)	11
6.3 MEASUREMENT EQUIPMENT USED	11
6.4 LIMITS AND MEASUREMENT RESULTS	11
7. CONDUCTED SPURIOUS EMISSION	13
7.1 MEASUREMENT PROCEDURE	13
7.2 TEST SET-UP (BLOCK DIAGRAM OF CONFIGURATION)	13
7.3 MEASUREMENT EQUIPMENT USED	13
7.4 LIMITS AND MEASUREMENT RESULT	13
8. RADIATED EMISSION	15
8.1 MEASUREMENT PROCEDURE	15
8.2 TEST SETUP	16
8.3 TEST EQUIPMENT LIST	17
8.4 TEST RESULT	18
9. BAND EDGE EMISSION	22
9.1 MEASUREMENT PROCEDURE	22
9.2 TEST SET-UP	22
9.3 TEST RESULT	22
10. NUMBER OF HOPPING FREQUENCY	26
10.1 MEASUREMENT PROCEDURE	26
10.2 TEST SETUP (BLOCK DIAGRAM OF CONFIGURATION)	26

10.3 MEASUREMENT EQUIPMENT USED.....	26
10.4 LIMITS AND MEASUREMENT RESULT	26
11. TIME OF OCCUPANCY (DWELL TIME).....	27
11.1 MEASUREMENT PROCEDURE	27
11.2 TEST SETUP (BLOCK DIAGRAM OF CONFIGURATION)	27
11.3 MEASUREMENT EQUIPMENT USED	27
11.4 LIMITS AND MEASUREMENT RESULT.....	27
12. FREQUENCY SEPARATION.....	30
12.1 MEASUREMENT PROCEDURE	30
12.2 TEST SETUP (BLOCK DIAGRAM OF CONFIGURATION)	30
12.3 MEASUREMENT EQUIPMENT USED.....	30
12.4 LIMITS AND MEASUREMENT RESULT	30
13. FCC LINE CONDUCTED EMISSION TEST	31
13.1 LIMITS OF LINE CONDUCTED EMISSION TEST	31
13.2 BLOCK DIAGRAM OF LINE CONDUCTED EMISSION TEST.....	31
13.3 PRELIMINARY PROCEDURE OF LINE CONDUCTED EMISSION TEST	32
13.4 FINAL PROCEDURE OF LINE CONDUCTED EMISSION TEST.....	32
13.5 TEST RESULT OF LINE CONDUCTED EMISSION TEST.....	33
APPENDIX I	35
PHOTOGRAPHS OF THE EUT.....	35
APPENDIX II	42
PHOTOGRAPHS OF THE TEST SETUP	42

1. GENERAL INFORMATION

1.1 PRODUCT DESCRIPTION

The EUT is a GSM Mobile Phone designed as an “Communication Device”. It is designed by way of utilizing the FHSS technology to achieve the system operation.

A major technical description of EUT is described as following

Operation Frequency	2.402 GHz to 2.480GHz
Rated Output Power	3.87dBm
Bluetooth Version:	V2.1 with EDR
Modulation	GFSK, $\pi/4$ -DQPSK, 8-DPSK
Number of channels	79
Antenna Designation	Integrated Antenna
Antenna Gain	0.8dBi
Power Supply	DC3.7V by Built-in Li-ion Battery
<i>**note: the EUT can charged by PC while transfer data.</i>	

1.2 TABLE OF CARRIER FREQUENCIES

Frequency Band	Channel Number	Frequency
2400~2483.5MHZ	0	2402MHZ
	1	2403MHZ
	:	:
	38	2440 MHZ
	39	2441 MHZ
	40	2442 MHZ
	:	:
	77	2479 MHZ
	78	2480 MHZ

1.3 RECEIVER INPUT BANDWIDTH

The input bandwidth of the receiver is 1.2MHZ, In every connection one Bluetooth device is the master and the other one is slave. The master determines the hopping sequence. The slave follows this sequence. Both devices shift between RX and TX time slot according to the clock of the master. Additionally the type of connection(e.g. single of multislotted packet) is set up at the beginning of the connection. The master adapts its hopping frequency and its TX/RX timing according to the packet type of the connection. Also the slave of the connection will use these settings.

Repeating of a packet has no influence on the hopping sequence. The hopping sequence generated by the master of the connection will be followed in any case. That means, a repeated packet will not be send on the same frequency, it is send on the next frequency of the hopping sequence.

1.4 EXAMPLE OF A HOPPING SEQUENCY IN DATA MODE

Example of a 79 hopping sequence in data mode:

40,21,44,23,42,53,46,55,48,33,52,35,50,65,54,67
56,37,60,39,58,69,62,71,64,25,68,27,66,57,70,59
72,29,76,31,74,61,78,63,01,41,05,43,03,73,07,75
09,45,13,47,11,77,15,00,64,49,66,53,68,02,70,06
01,51,03,55,05,04

1.5 EQUALLY AVERAGE USE OF FREQUENCIES AND BEHAVIOUR

The generation of the hopping sequence in connection mode depends essentially on two input values:

1 LAP/UAP of the master of the connection

2. Internal master clock

The LAP(lower address part) are the 24 LSB's of the 48 BD_ADDRESS. The BD_ADDRESS is an unambiguous number of every Bluetooth unit. The UAP(upper address part) are the 24MSB's of the 48BD_ADDRESS

The internal clock of a Bluetooth unit is derived from a free running clock which is never adjusted and is never turned off. For ehavior zation with other units only offset are used. It has no relation to the time Of the day. Its resolution is at least half the RX/TX slot length of 312.5us.The clock has a cycle of about One day(23h30).In most case it is implemented as 28 bit counter. For the deriving of the hopping sequence the entire.

LAP(24 bits),4LSB's(4bits)(Input 1) and the 27MSB's of the clock(Input 2) are used. With this input values different mathematical procedures(permutations, additions, XOR-operations)are performed to generate te Sequence. This will be done at the beginning of every new transmission.

Regarding short transmissions the Bluetooth system has the following ehavior:

The first connection between the two devices is established, a hopping sequence was generated. For Transmitting the wanted data the complete hopping sequence was not used. The connection ended.

The second connection will be established. A new hopping sequence is generated. Due to the fact the Bluetooth clock has a different value, because the period between the two transmission is longer(and it Cannot be shorter)than the minimum resolution of the clock(312.5us).The hopping sequence will always Differ from the first one.

1.6 RELATED SUBMITTAL(S) / GRANT (S)

This submittal(s) (test report) is intended for **FCC ID: SG71204HG-M168** filing to comply with Section 15.247 of the FCC Part 15, Subpart C Rules.

1.7 TEST METHODOLOGY

Both conducted and radiated testing were performed according to the procedures in ANSI C63.4 (2003). Radiated testing was performed at an antenna to EUT distance 3 meters.

1.8 TEST FACILITY

All measurement facilities used to collect the measurement data are located at Attestation of Global Compliance Co., Ltd.

2F., No.2 Building, Huafeng No.1 Technical Industrial Park, Sanwei, XiXiang, Baoan District, Shenzhen
The test site is constructed and calibrated to meet the FCC requirements in documents ANSI C63.4: 2003.
FCC register No.: 259865

1.9 SPECIAL ACCESSORIES

Refer to section 2.2.

1.10 EQUIPMENT MODIFICATIONS

Not available for this EUT intended for grant.

2. SYSTEM TEST CONFIGURATION

2.1 CONFIGURATION OF EUT SYSTEM

Configure :

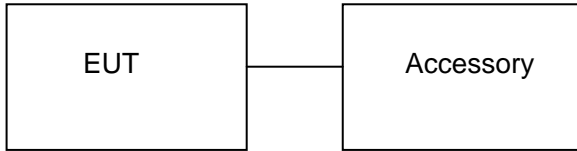

*****Note:** No software used to control the EUT for staying in continuous transmitting mode for testing.

2.2 EQUIPMENT USED IN EUT SYSTEM

Item	Equipment	Mfr/Brand	Model/Type No.	Remark
1	GSM Mobile Phone	Haier	HG-M168	EUT
2	Adapter	Haier	TC09-10	accessory
3	Battery	Haier	H11247	accessory
4	USB Cable	N/A	N/A	accessory
5	Earphone	N/A	N/A	accessory

3. SUMMARY OF TEST RESULTS

FCC RULES	DESCRIPTION OF TEST	RESULT
§15.247	Peak Output Power	Compliant
§15.247	20 dB Bandwidth	Compliant
§15.247	Spurious Emission	Compliant
§15.209	Radiated Emission	Compliant
§15.247	Band Edges	Compliant
§15.207	Conduction Emission	Compliant
§15.247	Number of Hopping Frequency	Compliant
§15.247	Time of Occupancy	Compliant
§15.247	Frequency Separation	Compliant

4. DESCRIPTION OF TEST MODES

The following operating modes were applied for the related test items. For Radiated Emission, 3 axis were chosen for testing for each applicable modes.

No.	TEST MODES
1	Low Channel(TX)
2	Middle Channel(TX)
3	High Channel(TX)
4	Normal Hopping

Note: All the test modes can be supply by Built-in Li-ion battery and adapter, only the result of the worst case was recorded in the report.

5. PEAK OUTPUT POWER

5.1 MEASUREMENT PROCEDURE

1. The EUT was placed on a turn table which is 0.8m above ground plane.
2. Connect EUT RF output port to the Spectrum Analyzer through an RF attenuator
3. Set the EUT Work on the top, middle and the bottom operation frequency individually.
4. Set Span = approximately 5 times the 20 dB bandwidth, centered on a hopping channel
RBW > the 20 dB bandwidth of the emission being measured
VBW \geq RBW; Sweep = auto; Detector function = peak
5. Set SPA Trace 1 Max hold, then View.

5.2 TEST SET-UP (BLOCK DIAGRAM OF CONFIGURATION)

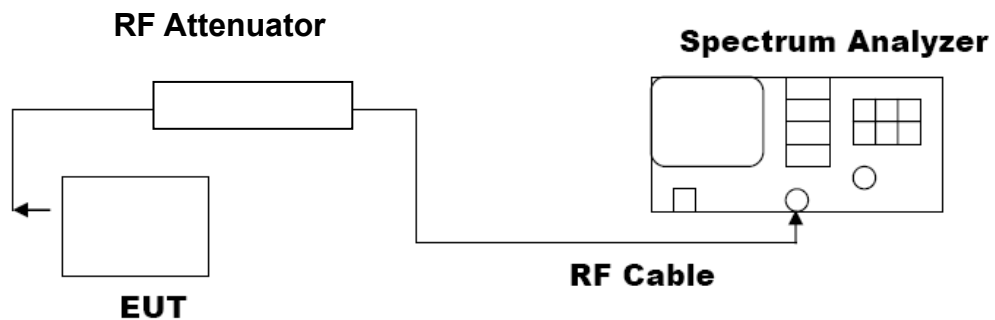

5.3 MEASUREMENT EQUIPMENT USED

Description	Manufacturer	Model	SERIAL NUMBER	Cal. Date	Cal. Due
Spectrum Analyzer	Agilent	E4440A	N/A	06/27/2011	06/26/2012
RF attenuator	N/A	RFA20db	N/A	N/A	N/A

5.4 LIMITS AND MEASUREMENT RESULT

PEAK OUTPUT POWER MEASUREMENT RESULT FOR GFSK MODULATION			
Frequency (GHz)	Result (dBm)	Applicable Limits (dBm)	Pass or Fail
2.402	3.87	30	Pass
2.441	3.84	30	Pass
2.480	3.79	30	Pass

PEAK OUTPUT POWER MEASUREMENT RESULT FOR $\pi/4$ -DQPSK, 8-DPSK MODULATION				
Frequency (GHz)	Test Result 2 Mbps (dBm)	Test Result 3 Mbps (dBm)	Applicable Limits (dBm)	Pass or Fail
2.402	3.21	3.19	30	Pass
2.441	3.17	3.14	30	Pass
2.480	3.13	3.11	30	Pass

6. 20 DB BANDWIDTH

6.1 MEASUREMENT PROCEDURE

1. The EUT was placed on a turn table which is 0.8m above ground plane.
2. Connect EUT RF output port to the Spectrum Analyzer through an RF attenuator
3. Set the EUT Work on the top, the middle and the bottom operation frequency individually.
4. Set Span = approximately 2 to 3 times the 20 dB bandwidth, centered on a hopping channel
RBW \geq 1% of the 20 dB bandwidth, VBW \geq RBW; Sweep = auto; Detector function = peak
5. Set SPA Trace 1 Max hold, then View.

6.2 TEST SET-UP (BLOCK DIAGRAM OF CONFIGURATION)

The Same as described in Section 5.2

6.3 MEASUREMENT EQUIPMENT USED

The same as described in Section 5.3

6.4 LIMITS AND MEASUREMENT RESULTS

LIMITS AND MEASUREMENT RESULT			
Applicable Limits	Measurement Result(3Mbps)		
	Test Data (MHz)		Criteria
N/A	Low Channel	1.108	PASS
	Middle Channel	1.106	PASS
	High Channel	1.103	PASS

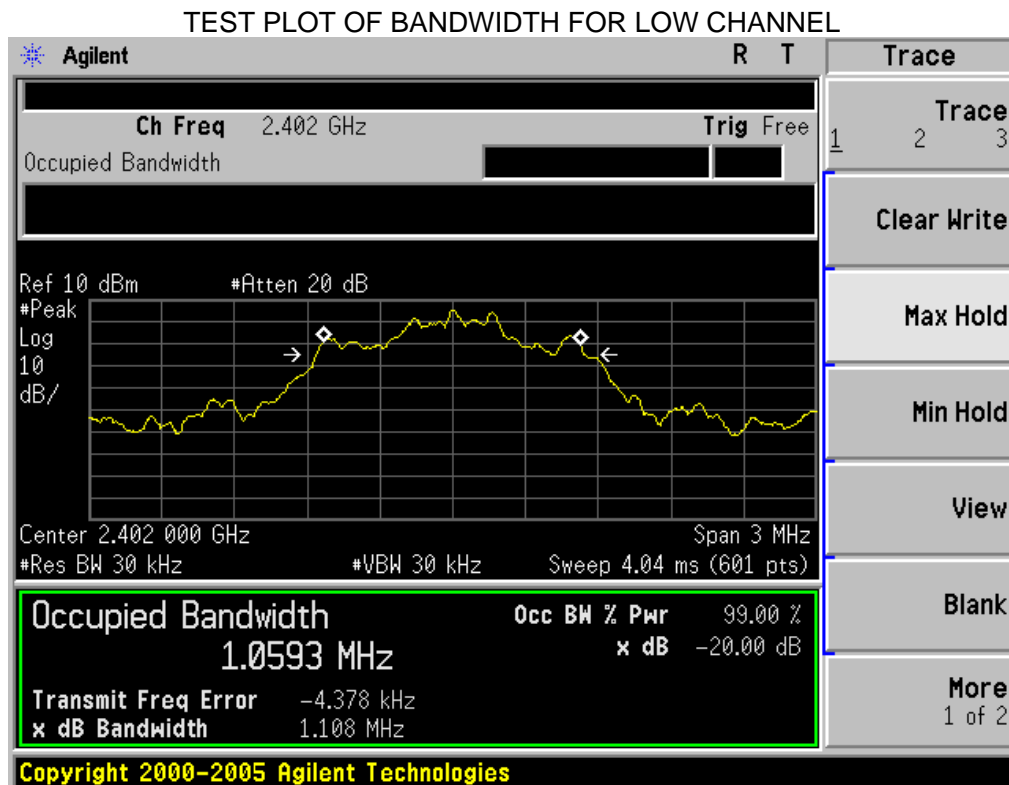

TEST PLOT OF BANDWIDTH FOR MIDDLE CHANNEL

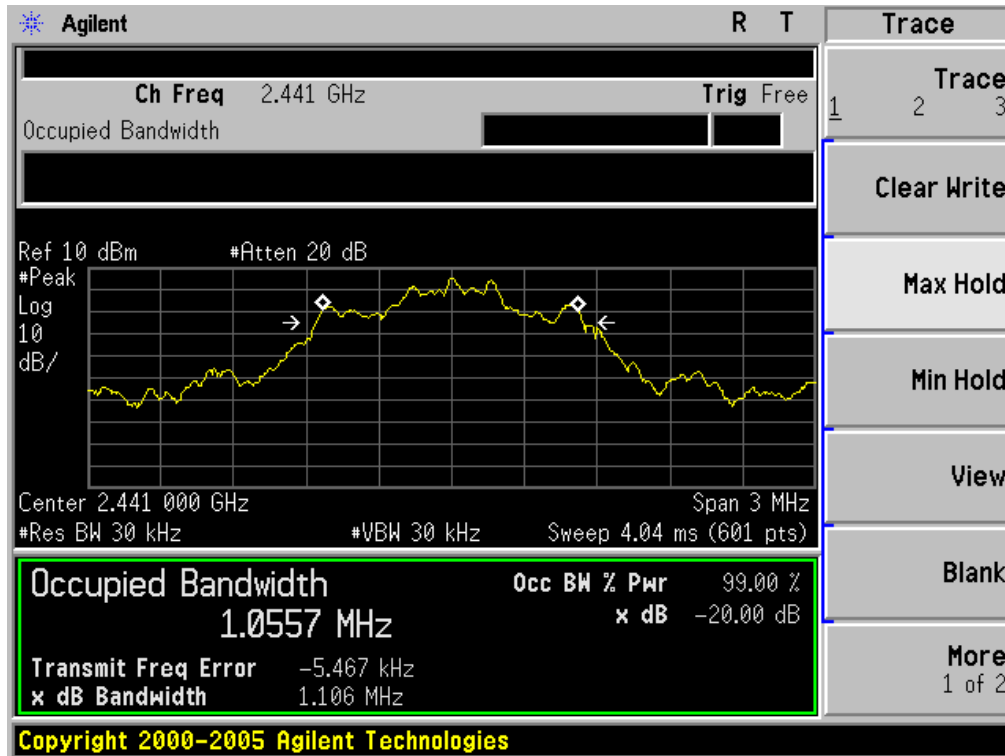

TEST PLOT OF BANDWIDTH FOR HIGH CHANNEL



7. CONDUCTED SPURIOUS EMISSION

7.1 MEASUREMENT PROCEDURE

1. The EUT was placed on a turn table which is 0.8m above ground plane.
2. Connect EUT RF output port to the Spectrum Analyzer through an RF attenuator
3. Set the EUT Work on the top, the Middle and the bottom operation frequency individually.
4. Set the Span = wide enough to capture the peak level of the in-band emission and all spurious emissions from the lowest frequency generated in the EUT up through the 10th harmonic.
RBW = 100 kHz; VBW \geq RBW; Sweep = auto; Detector function = peak.
5. Set SPA Trace 1 Max hold, then View.

7.2 TEST SET-UP (BLOCK DIAGRAM OF CONFIGURATION)

The Same as described in section 5.2

7.3 MEASUREMENT EQUIPMENT USED

The Same as described in section 5.3

7.4 LIMITS AND MEASUREMENT RESULT

LIMITS AND MEASUREMENT RESULT		
Applicable Limits	Measurement Result	
	Test Data	Criteria
In any 100 KHz Bandwidth Outside the frequency band in which the spread spectrum intentional radiator is operating, the radio frequency power that is produce by the intentional radiator shall be at least 20 dB below that in 100KHz bandwidth within the band that contains the highest level of the desired power.	At least -20dBc than the limit Specified on the BOTTOM Channel	PASS
In addition, radiation emissions which fall in the restricted bands, as defined in §15.205(a), must also comply with the radiated emission limits specified in§15.209(a))	At least -20dBc than the limit Specified on the TOP Channel	PASS

TEST PLOT OF OUT OF BAND EMISSIONS WITH THE WORST CASE
 OF 1 MBPS FOR GFSK MODULATION IN LOW CHANNEL

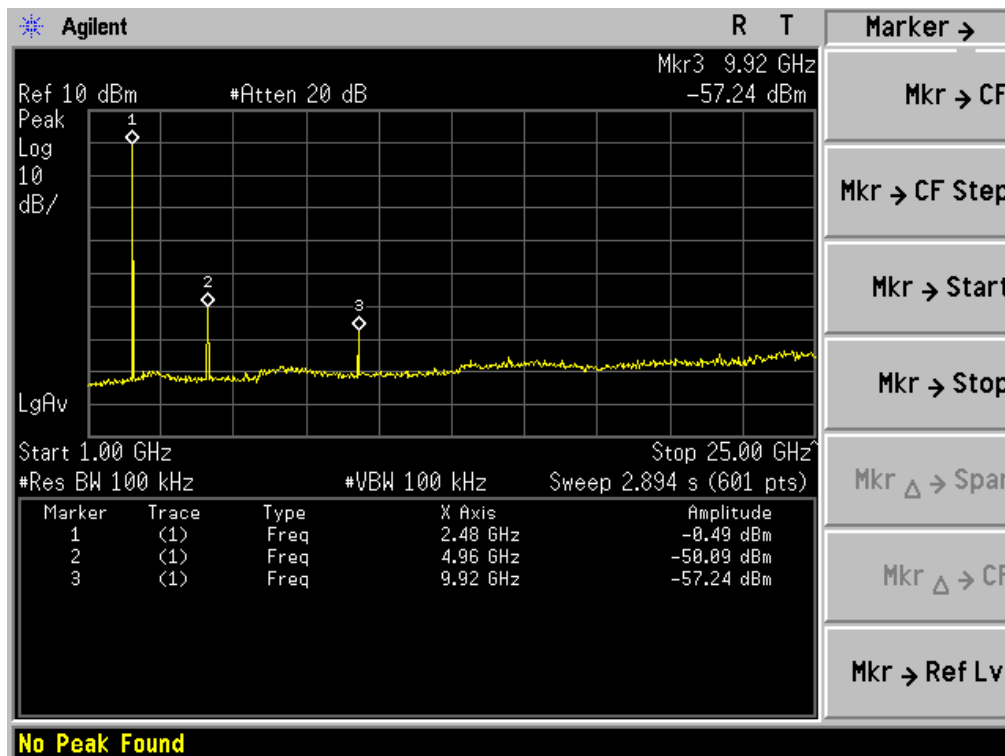
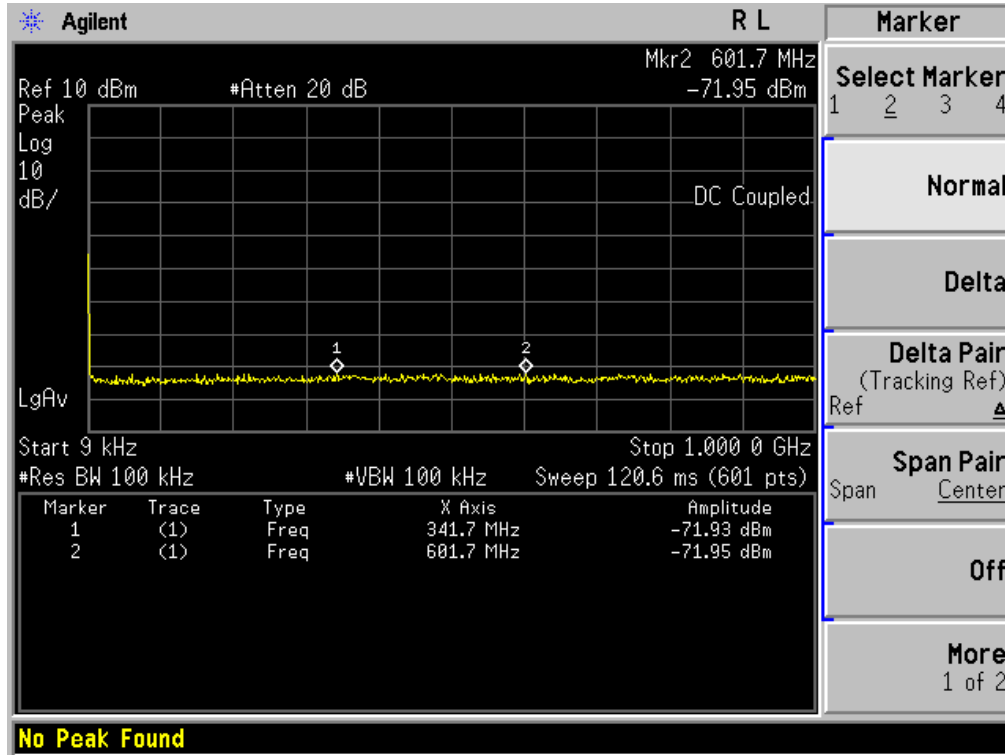

8. RADIATED EMISSION

8.1 MEASUREMENT PROCEDURE

1. Configure the EUT according to ANSI C63.4. The EUT was placed on the top of the turntable 0.8 meter above ground. The phase center of the receiving antenna mounted on the top of a height-variable antenna tower was placed 3 meters far away from the turntable.
2. Power on the EUT and all the supporting units. The turntable was rotated by 360 degrees to determine the position of the highest radiation.
3. The height of the broadband receiving antenna was varied between one meter and four meters above ground to find the maximum emissions field strength of both horizontal and vertical polarization.
4. For each suspected emissions, the antenna tower was scan (from 1 M to 4 M) and then the turntable was rotated (from 0 degree to 360 degrees) to find the maximum reading.
5. Set the test-receiver system to Peak or CISPR quasi-peak Detect Function with specified bandwidth under Maximum Hold Mode.
6. For emissions above 1GHz, use 1MHz VBW and RBW for peak reading. Then 1MHz RBW and 10Hz VBW for average reading in spectrum analyzer.
7. When the radiated emissions limits are expressed in terms of the average value of the emissions, and pulsed operation is employed, the measurement field strength shall be determined by averaging over one complete pulse train, including blanking intervals, as long as the pulse train does not exceed 0.1 seconds. As an alternative (provided the transmitter operates for longer than 0.1 seconds) or in cases where the pulse train exceeds 0.1 seconds, the measured field strength shall be determined from the average absolute voltage during a 0.1 second interval during which the field strength is at its maximum value.
8. If the emissions level of the EUT in peak mode was 3 dB lower than the average limit specified, then testing will be stopped and peak values of EUT will be reported, otherwise, the emissions which do not have 3 dB margin will be repeated one by one using the quasi-peak method for below 1GHz.
9. For testing above 1GHz, the emissions level of the EUT in peak mode was lower than average limit (that means the emissions level in peak mode also complies with the limit in average mode), then testing will be stopped and peak values of EUT will be reported, otherwise, the emissions will be measured in average mode again and reported.
10. In case the emission is lower than 30MHz, loop antenna has to be used for measurement and the recorded data should be QP measured by receiver. High – Low scan is not required in this case.

The following table is the setting of spectrum analyzer and receiver.'

Spectrum Parameter	Setting
Start ~Stop Frequency	9KHz~150KHz/RB 200Hz for QP
Start ~Stop Frequency	150KHz~30MHz/RB 9KHz for QP
Start ~Stop Frequency	30MHz~1000MHz/RB 120KHz for QP
Start ~Stop Frequency	1GHz~26.5GHz 1MHz/1MHz for Peak, 1MHz/10Hz for Average

Receiver Parameter	Setting
Start ~Stop Frequency	9KHz~150KHz/RB 200Hz for QP
Start ~Stop Frequency	150KHz~30MHz/RB 9KHz for QP
Start ~Stop Frequency	30MHz~1000MHz/RB 120KHz for QP

8.2 TEST SETUP

RADIATED EMISSION TEST SETUP BELOW 30MHz

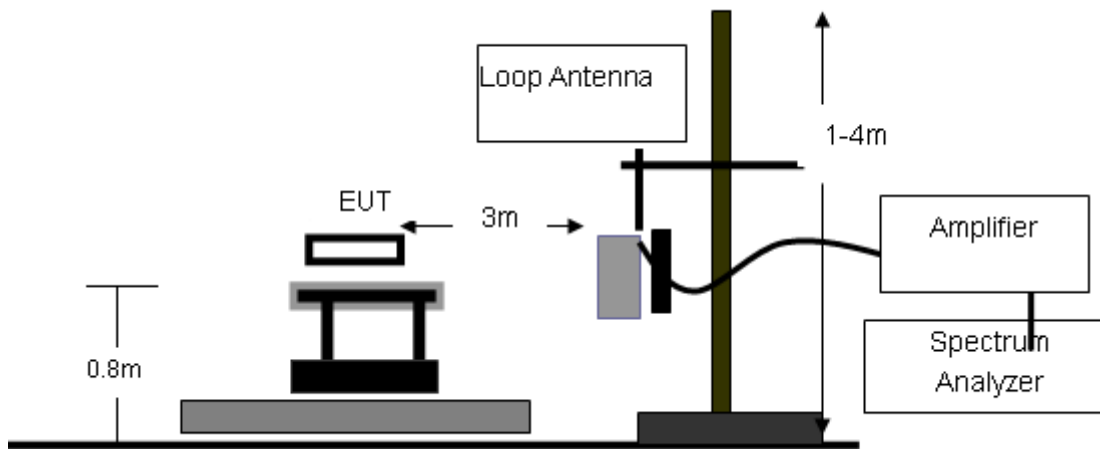

RADIATED EMISSION TEST SETUP 30MHz-1000MHz

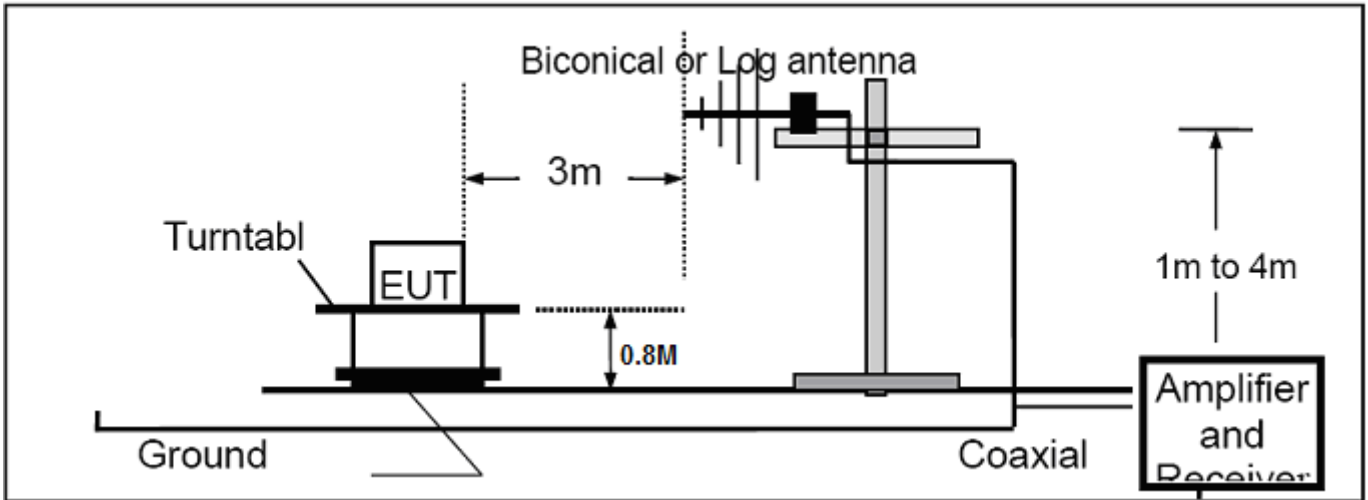

RADIATED EMISSION TEST SETUP ABOVE 1000MHz

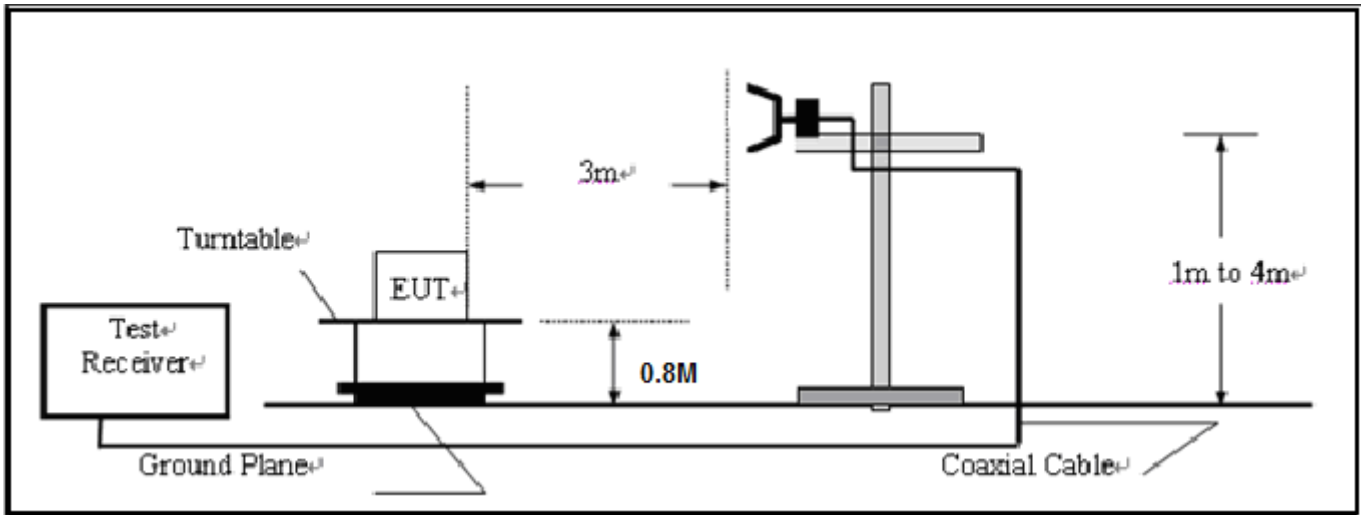

8.3 TEST EQUIPMENT LIST

Description	Manufacturer	Model	SERIAL NUMBER	Cal. Date	Cal. Due
Spectrum Analyzer	Agilent	E4440A	N/A	06/27/2011	06/26/2012
Amplifier	EM	EM30180	0607030	06/27/2011	06/26/2012
Horn Antenna	EM	EM-AH-10180	N/A	06/27/2011	06/26/2012
Horn Antenna	A.H. Systems Inc.	SAS-574	--	06/27/2011	06/26/2012
EMI Test Receiver	Rohde & Schwarz	ESCI	N/A	06/27/2011	06/26/2012
Amplifier	EM	EM30180	N/A	06/27/2011	06/26/2012
Biological Antenna	A.H. Systems Inc.	SAS-521-4	N/A	06/27/2011	06/26/2012
Loop Antenna	Daze	ZN30900N	SEL0097	06/27/2011	06/26/2012
Isolation Transformer	LETEAC	LTBK	--	06/27/2011	06/26/2012

8.4 TEST RESULT

RADIATED EMISSION BELOW 30MHZ

No emission found between lowest internal used/generated Frequency to 30MHz.

RADIATED EMISSION BELOW 1GHZ

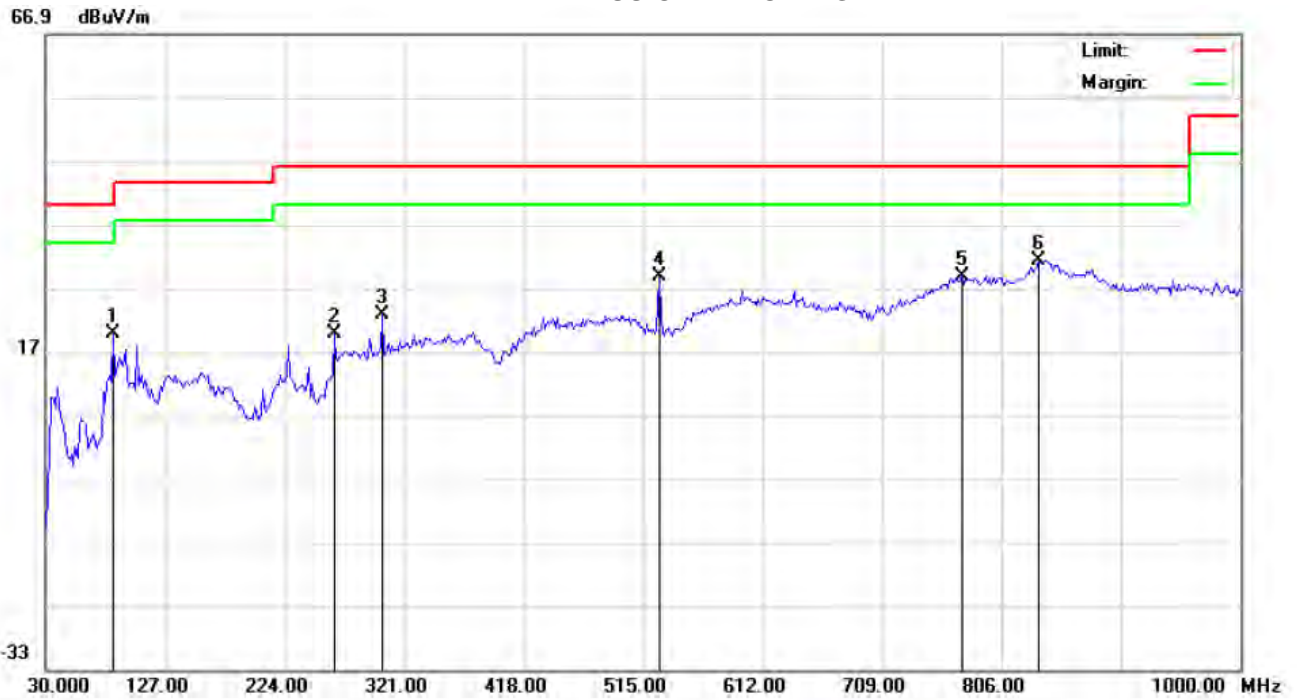

Site: site #1	Polarization: <i>Horizontal</i>	Temperature: 26
Limit: FCC Class B 3M Radiation	Power: AC 120V/60Hz	Humidity: 60 %
EUT: GSM Mobile Phone	Distance: 3m	
M/N: HG-M168		
Mode: Normal Hopping		
Note:		

No.	Mk	Freq.	Reading	Factor	Measurement	Limit	Over	Detector	Antenna Height	Table Degree	Comment
		MHz	dBuV	dB/m	dBuV/m	dBuV/m	dB		cm	degree	
1		84.9667	5.78	13.89	19.67	40.00	-20.33	peak			
2		264.4167	5.16	14.71	19.87	46.00	-26.13	peak			
3		303.2167	5.46	17.21	22.67	46.00	-23.33	peak			
4		527.9333	8.60	20.23	28.83	46.00	-17.17	peak			
5		773.6667	0.94	27.95	28.89	46.00	-17.11	peak			
6	*	836.7167	0.56	30.81	31.37	46.00	-14.63	peak			

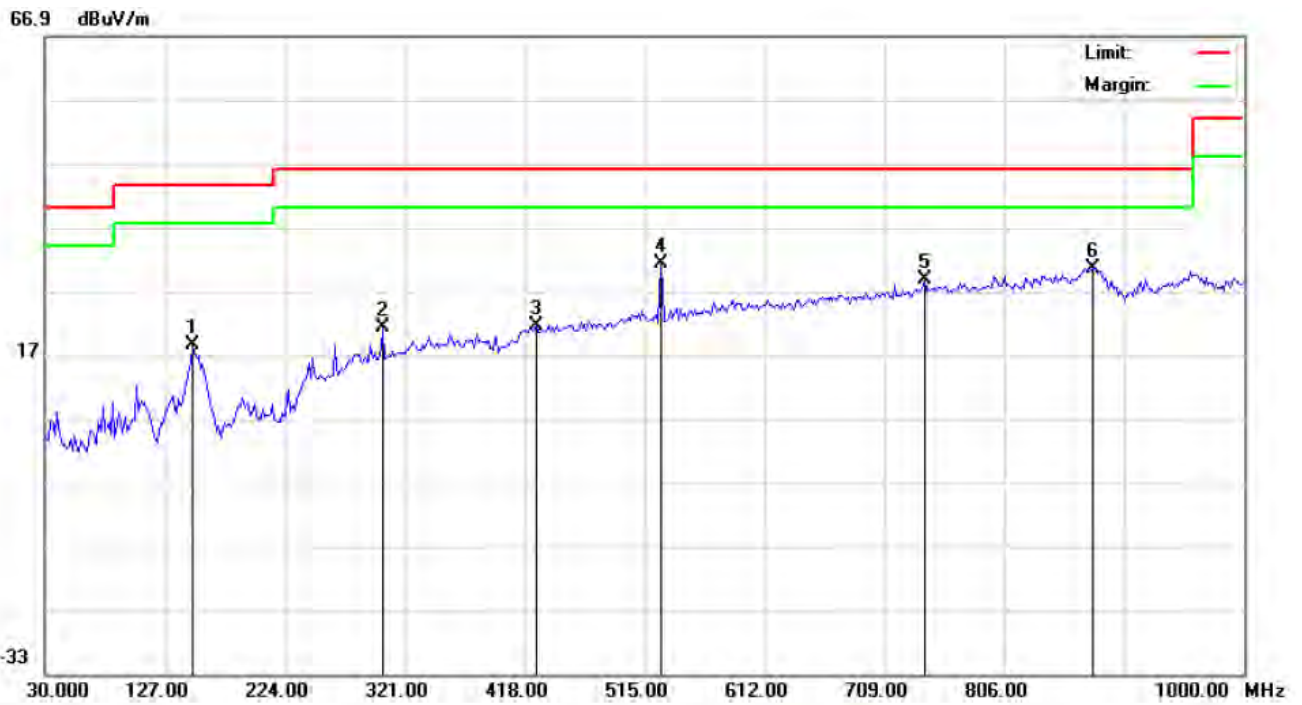

Site: site #1
 Limit: FCC Class B 3M Radiation
 EUT: GSM Mobile Phone
 M/N: HG-M168
 Mode: Normal Hopping
 Note:

Polarization: *Vertical*
 Power: AC 120V/60Hz
 Distance: 3m

Temperature: 26
 Humidity: 60 %

No.	Mk	Freq.	Reading	Factor	Measurement	Limit	Over	Detector	Antenna Height	Table Degree	Comment
		MHz	dBuV	dB/m	dBuV/m	dBuV/m	dB		cm	degree	
1		149.6333	-0.41	18.90	18.49	43.50	-25.01	peak			
2		303.2167	4.10	17.21	21.31	46.00	-24.69	peak			
3		427.7000	0.19	21.46	21.65	46.00	-24.35	peak			
4	*	527.9333	7.90	23.35	31.25	46.00	-14.75	peak			
5		741.3333	1.37	27.48	28.85	46.00	-17.15	peak			
6		877.1333	0.38	30.25	30.63	46.00	-15.37	peak			

9. BAND EDGE EMISSION

9.1 MEASUREMENT PROCEDURE

- 1, Set the EUT Work on the top, the bottom operation frequency individually.
2. Set SPA Start or Stop Frequency = Operation Frequency, RBW>=1%span, VBW>=RBW
3. The band edges was measured and recorded.

9.2 TEST SET-UP

Radiated same as 8.2

9.3 TEST RESULT

TEST PLOT OF BAND EDGE FOR LOW CHANNEL (1Mbps)



Site: site #1	Polarization: <i>Horizontal</i>	Temperature: 26
Limit: FCC Class B 3M Radiation above 1GHZ(PK)	Power: AC 120V/60Hz	Humidity: 60 %
EUT: GSM Mobile Phone	Distance: 3m	
M/N: HG-M168		
Mode: LowChannel-TX(1Mbps)		
Note:		

No.	Mk	Freq.	Reading	Factor	Measurement	Limit	Over	Detector	Antenna Height	Table Degree	Comment
		MHz	dBuV	dB/m	dBuV/m	dBuV/m	dB		cm	degree	
1		2394.458	36.90	-8.42	28.48	74.00	-45.52	peak			
2		2400.000	35.07	-8.40	26.67	74.00	-47.33	peak			
3	*	2402.000	88.88	-8.39	80.49	74.00	6.49	peak			

TEST PLOT OF BAND EDGE FOR HIGH CHANNEL (1Mbps)

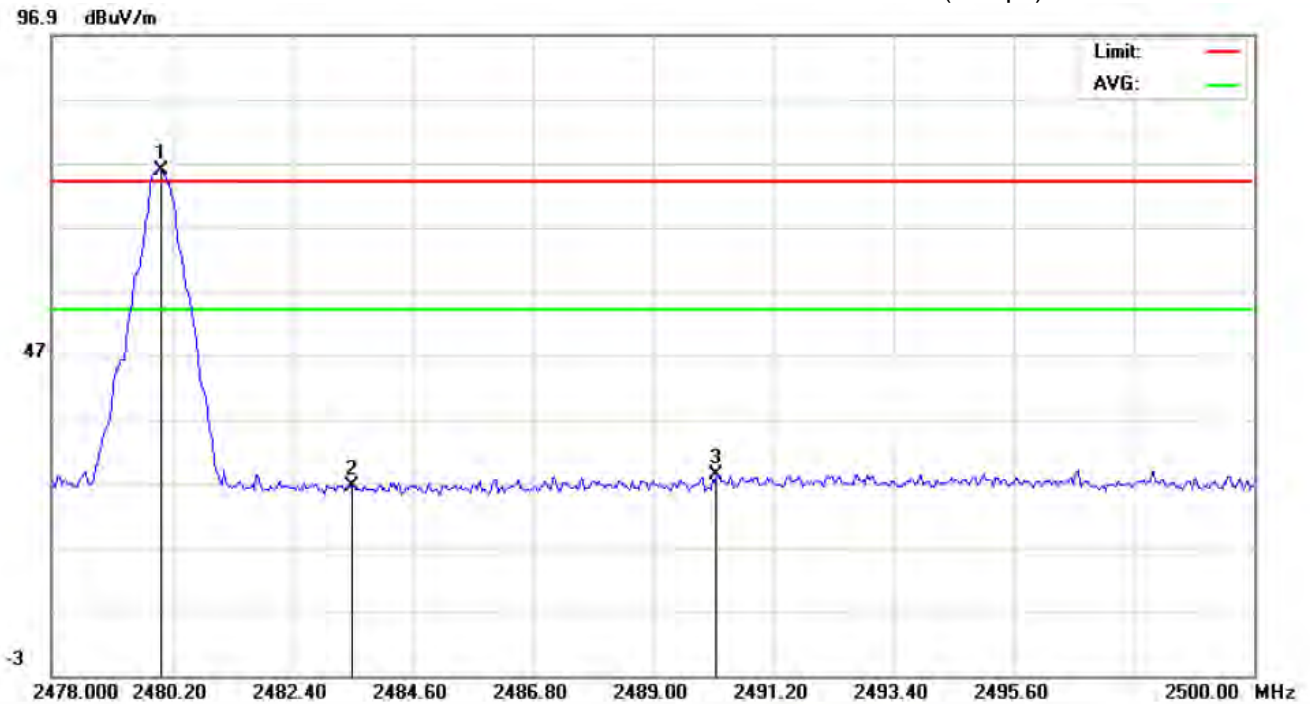

Site: site #1
Limit: FCC Class B 3M Radiation above 1GHZ(PK)
EUT: GSM Mobile Phone
M/N: HG-M168
Mode: High Channel-TX(1Mbps)
Note:

Polarization: *Horizontal*
Power: AC 120V/60Hz
Distance: 3m

Temperature: 26
Humidity: 60 %

No.	Mk	Freq.	Reading	Factor	Measurement	Limit	Over	Detector	Antenna Height	Table Degree	Comment
		MHz	dBuV	dB/m	dBuV/m	dBuV/m	dB		cm	degree	
1	*	2480.000	83.84	-8.08	75.76	74.00	1.76	peak			
2		2483.500	34.71	-8.07	26.64	74.00	-47.36	peak			
3		2490.173	36.36	-8.04	28.32	74.00	-45.68	peak			

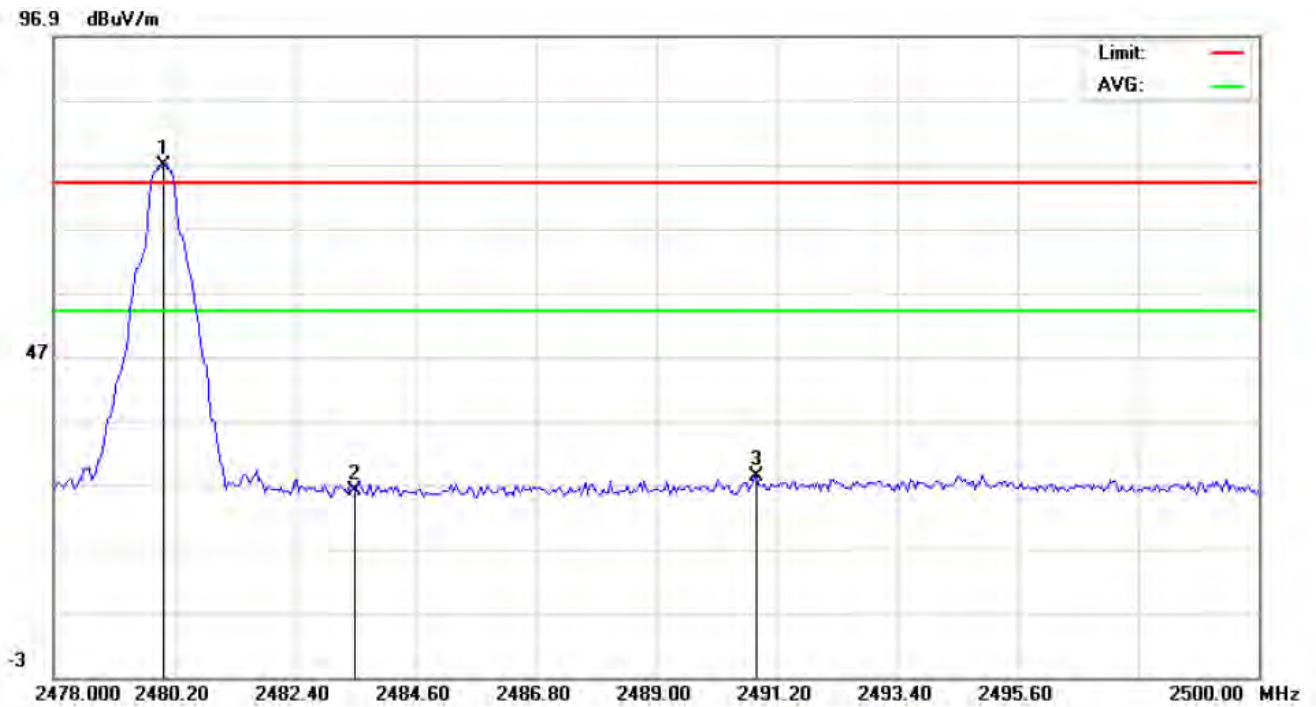

Site: site #1
 Limit: FCC Class B 3M Radiation above 1GHZ(PK)
 EUT: GSM Mobile Phone
 M/N: HG-M168
 Mode: High Channel-TX(1Mbps)
 Note:

Polarization: *Vertical*
 Power: AC 120V/60Hz
 Distance: 3m

Temperature: 26
 Humidity: 60 %

No.	Mk	Freq.	Reading	Factor	Measurement	Limit	Over	Detector	Antenna Height	Table Degree	Comment
		MHz	dBuV	dB/m	dBuV/m	dBuV/m	dB		cm	degree	
1	*	2480.000	84.93	-8.08	76.85	74.00	2.85	peak			
2		2483.500	34.04	-8.07	25.97	74.00	-48.03	peak			
3		2490.833	36.34	-8.04	28.30	74.00	-45.70	peak			

10. NUMBER OF HOPPING FREQUENCY

10.1 MEASUREMENT PROCEDURE

1. Place the EUT on the table and set it in transmitting mode.
2. Remove the antenna from the EUT and then connect a low RF cable from the antenna port to the spectrum analyzer.
3. Set the spectrum analyzer Start = 2.4GHz Stop = 2.4835GHz
4. Set the Spectrum Analyzer as RBW \geq 1%span, VBW \geq RBW.

10.2 TEST SETUP (BLOCK DIAGRAM OF CONFIGURATION)

Same as described in section 5.2

10.3 MEASUREMENT EQUIPMENT USED

The Same as described in section 5.3

10.4 LIMITS AND MEASUREMENT RESULT

TOTAL NO. OF HOPPING CHANNEL	LIMIT (NO. OF CH)	MEASUREMENT (NO. OF CH)	RESULT
	≥ 15	79	PASS

TEST PLOT FOR NO. OF TOTAL CHANNELS

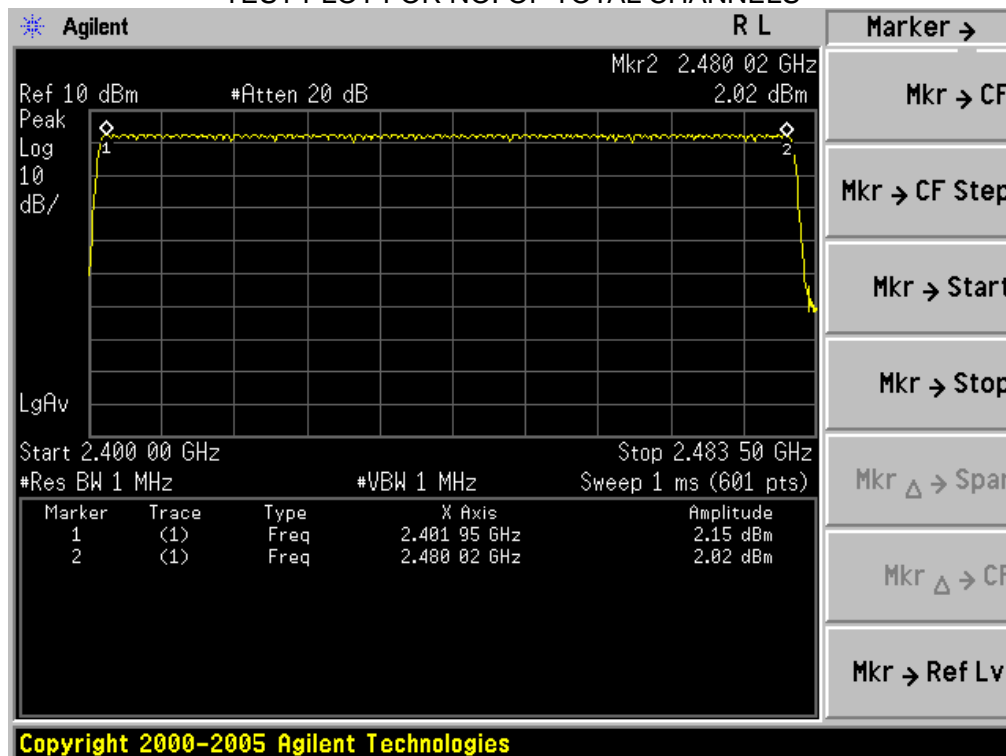

11. TIME OF OCCUPANCY (DWELL TIME)

11.1 MEASUREMENT PROCEDURE

1. Place the EUT on the table and set it in transmitting mode
2. Remove the antenna from the EUT and then connect a low RF cable from the antenna port to the spectrum analyzer
3. Set Span = zero span, centered on a hopping channel
4. Set the spectrum analyzer as RBW=1MHz, VBW>=RBW, Span = 0 Hz

11.2 TEST SETUP (BLOCK DIAGRAM OF CONFIGURATION)

Same as described in section 5.2

11.3 MEASUREMENT EQUIPMENT USED

The same as described in section 5.3

11.4 LIMITS AND MEASUREMENT RESULT

The Worst Case (3Mbps)

Channel	Time of Pulse for DH5 (ms)	Period Time (s)	Sweep Time (ms)	Limit (ms)
Low	2.871	31.6	306.24	400
Middle	2.871	31.6	306.24	400
High	2.871	31.6	306.24	400

Low Channel Time

$$2.871 * (1600/6) / 79 * 31.6 = 306.24 \text{ms}$$

Middle Channel Time

$$2.871 * (1600/6) / 79 * 31.6 = 306.24 \text{ms}$$

High Channel Time

$$2.871 * (1600/6) / 79 * 31.6 = 306.24 \text{ms}$$

TEST PLOT OF LOW CHANNEL

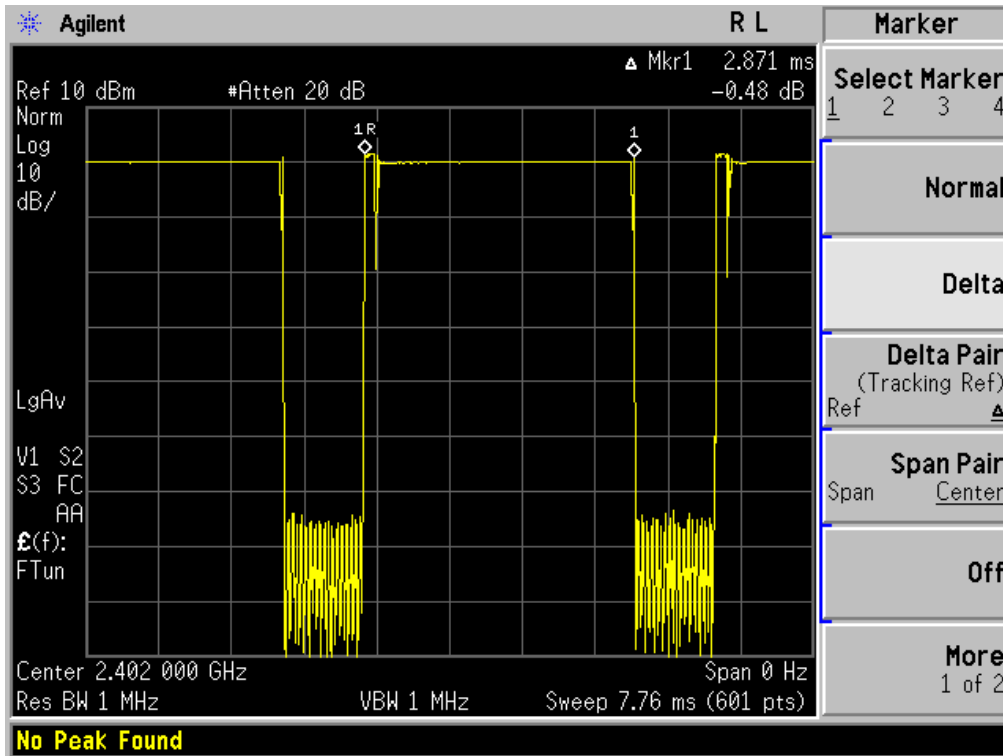

TEST PLOT OF MIDDLE CHANNEL

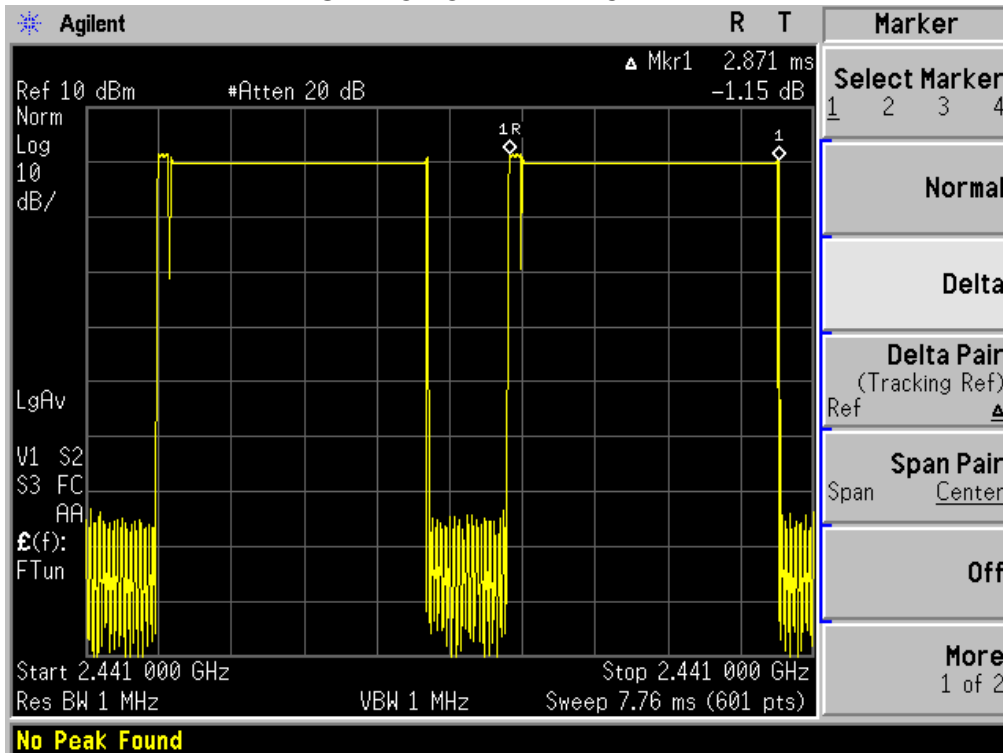

TEST PLOT OF HIGH CHANNEL

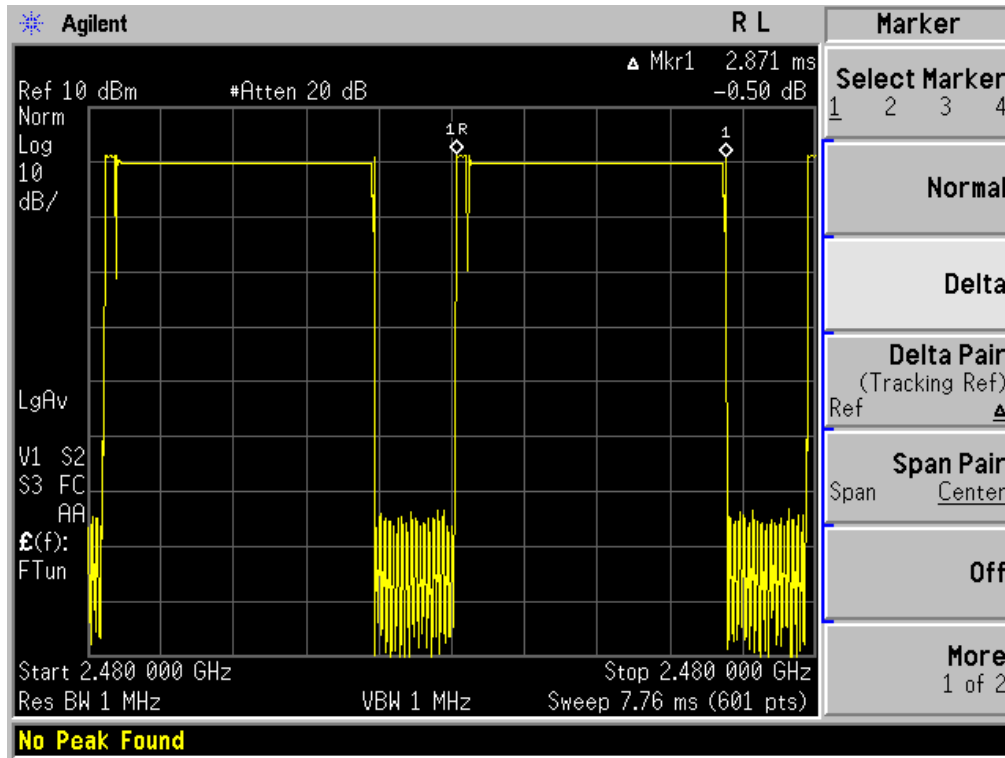

12. FREQUENCY SEPARATION
12.1 MEASUREMENT PROCEDURE

1. Place the EUT on the table and set it in transmitting mode
2. Remove the antenna from the EUT and then connect a low RF cable from the antenna port to the spectrum analyzer
3. Set Span = wide enough to capture the peaks of two adjacent channels Resolution (or IF) Bandwidth (RBW) \geq 1% of the span Video (or Average) Bandwidth (VBW) \geq RBW; Sweep = auto; Detector function = peak; Trace = max hold

12.2 TEST SETUP (BLOCK DIAGRAM OF CONFIGURATION)
Same as described in section 5.2

12.3 MEASUREMENT EQUIPMENT USED

The same as described in section 5.3

12.4 LIMITS AND MEASUREMENT RESULT

CHANNEL	CHANNEL SEPARATION	LIMIT	RESULT
	KHz	KHz	
CH00-CH01	1000	\geq 25 KHz or 2/3 20 dB BW	Pass

TEST PLOT FOR FREQUENCY SEPARATION

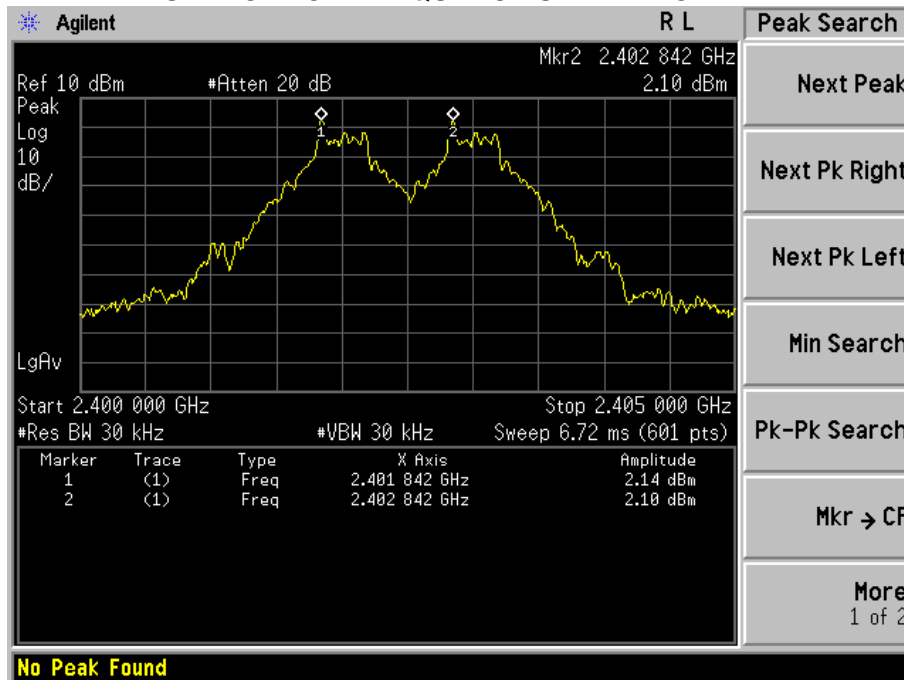

13. FCC LINE CONDUCTED EMISSION TEST

13.1 LIMITS OF LINE CONDUCTED EMISSION TEST

Frequency	Maximum RF Line Voltage	
	Q.P.(dBuV)	Average(dBuV)
150kHz~500kHz	66-56	56-46
500kHz~5MHz	56	46
5MHz~30MHz	60	50

**Note: 1. The lower limit shall apply at the transition frequency.
2. The limit decreases linearly with the logarithm of the frequency in the range 0.15 MHz to 0.50 MHz

13.2 BLOCK DIAGRAM OF LINE CONDUCTED EMISSION TEST

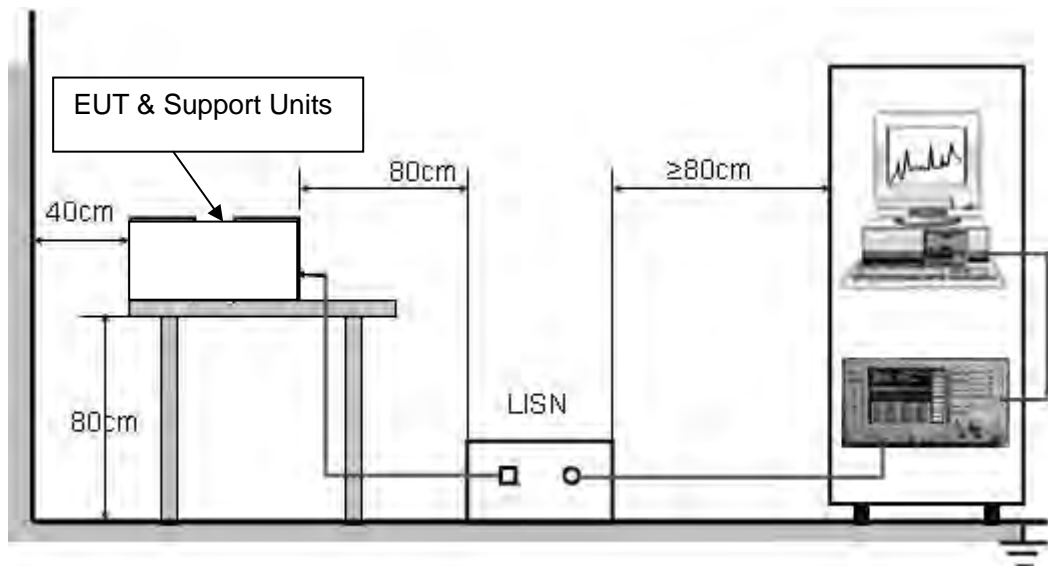

13.3 PRELIMINARY PROCEDURE OF LINE CONDUCTED EMISSION TEST

- 1) The equipment was set up as per the test configuration to simulate typical actual usage per the user's manual. When the EUT is a tabletop system, a wooden table with a height of 0.8 meters is used and is placed on the ground plane as per ANSI C63.4 (see Test Facility for the dimensions of the ground plane used). When the EUT is a floor-standing equipment, it is placed on the ground plane which has a 3-12 mm non-conductive covering to insulate the EUT from the ground plane.
- 2) Support equipment, if needed, was placed as per ANSI C63.4.
- 3) All I/O cables were positioned to simulate typical actual usage as per ANSI C63.4.
- 4) All support equipments received AC120V/60Hz power from a LISN, if any.
- 5) The EUT received power by adapter which received 120V/60Hz power by a LISN..
- 6) The test program was started. Emissions were measured on each current carrying line of the EUT using a spectrum Analyzer / Receiver connected to the LISN powering the EUT. The LISN has two monitoring points: Line 1 (Hot Side) and Line 2 (Neutral Side). Two scans were taken: one with Line 1 connected to Analyzer / Receiver and Line 2 connected to a 50 ohm load; the second scan had Line 1 connected to a 50 ohm load and Line 2 connected to the Analyzer / Receiver.
- 7) Analyzer / Receiver scanned from 150 kHz to 30MHz for emissions in each of the test modes.
- 8) During the above scans, the emissions were maximized by cable manipulation.
- 9) The test mode(s) were scanned during the preliminary test.

Then, the EUT configuration and cable configuration of the above highest emission level were recorded for reference of final testing.

13.4 FINAL PROCEDURE OF LINE CONDUCTED EMISSION TEST

- 1) EUT and support equipment was set up on the test bench as per step 2 of the preliminary test.
- 2) A scan was taken on both power lines, Line 1 and Line 2, recording at least the six highest emissions. Emission frequency and amplitude were recorded into a computer in which correction factors were used to calculate the emission level and compare reading to the applicable limit. If EUT emission level was less -2dB to the A.V. limit in Peak mode, then the emission signal was re-checked using Q.P and Average detector.
- 3) The test data of the worst case condition(s) was reported on the Summary Data page.

13.5 TEST RESULT OF LINE CONDUCTED EMISSION TEST

Line Conducted Emission Test Line 1-L

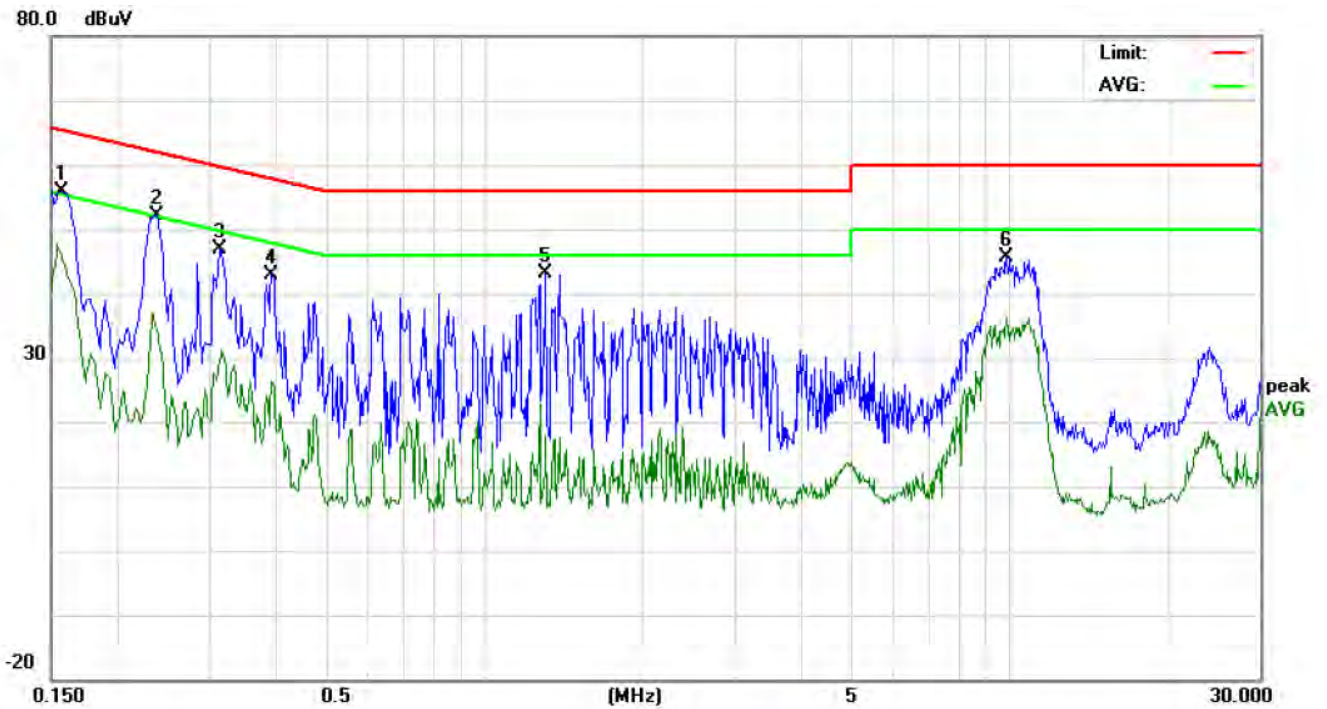

Site: Conduction
 Limit: FCC Class B Conduction(QP)
 EUT: GSM Mobile Phone
 M/N: HG-M168
 Mode: Normal Hopping
 Note:

Phase: **L1**
 Power: AC 120V/60Hz

Temperature: 26
 Humidity: 60 %

No.	Freq. (MHz)	Reading_Level (dBuV)			Correct Factor (dB)	Measurement (dBuV)			Limit (dBuV)		Margin (dB)		P/F	Comment
		Peak	QP	AVG		Peak	QP	AVG	QP	AVG	QP	AVG		
1	0.1580	45.68		35.03	10.17	55.85		45.20	65.56	55.56	-9.71	-10.36	P	
2	0.2380	41.94		24.21	10.26	52.20		34.47	62.16	52.16	-9.96	-17.69	P	
3	0.3140	36.62		19.64	10.30	46.92		29.94	59.86	49.86	-12.94	-19.92	P	
4	0.3940	32.44		16.07	10.33	42.77		26.40	57.98	47.98	-15.21	-21.58	P	
5	1.3099	32.74		7.43	10.38	43.12		17.81	56.00	46.00	-12.88	-28.19	P	
6	9.9059	35.51		26.31	10.14	45.65		36.45	60.00	50.00	-14.35	-13.55	P	

Line Conducted Emission Test Line 2-N

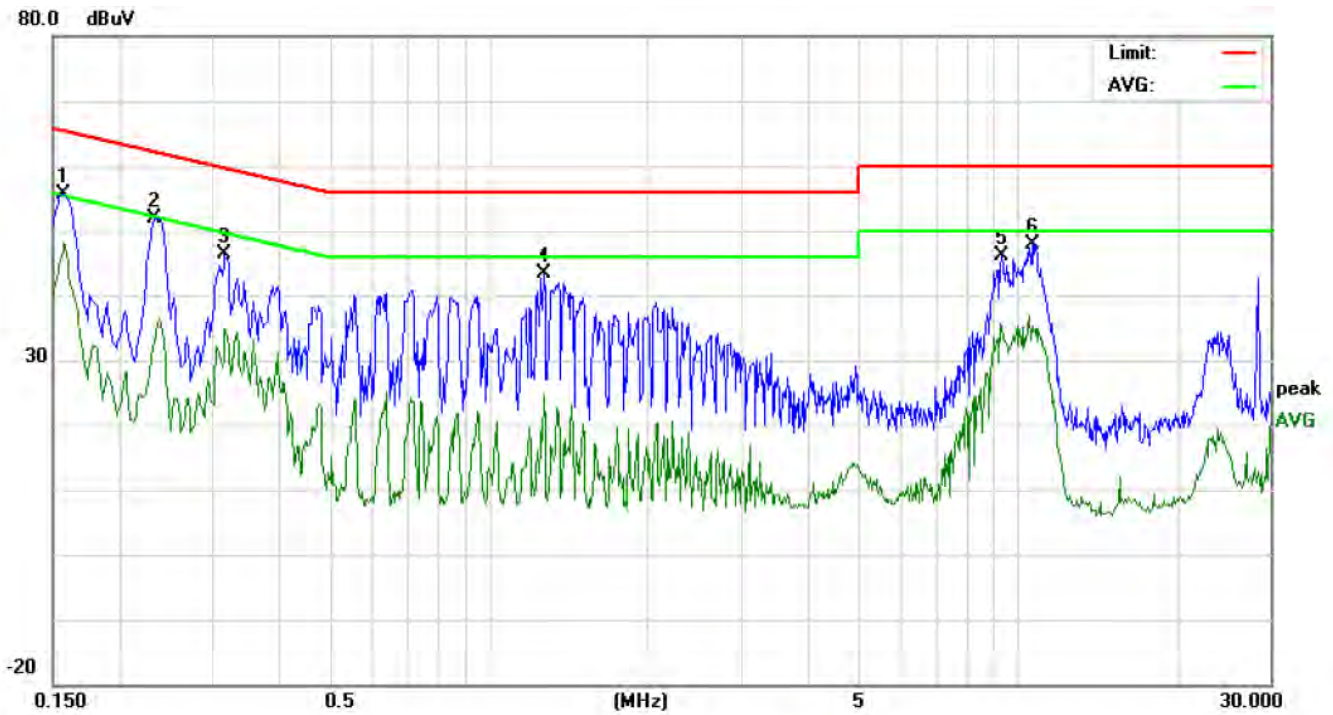

Site: Conduction Phase: **N** Temperature: 26
 Limit: FCC Class B Conduction(QP) Power: AC 120V/60Hz Humidity: 60 %
 EUT: GSM Mobile Phone
 M/N: HG-M168
 Mode: Normal Hopping
 Note:

No.	Freq. (MHz)	Reading_Level (dBuV)			Correct Factor (dB)	Measurement (dBuV)			Limit (dBuV)		Margin (dB)		P/F	Comment
		Peak	QP	AVG		Peak	QP	AVG	QP	AVG	QP	AVG		
1	0.1580	45.57		37.95	10.17	55.74		48.12	65.56	55.56	-9.82	-7.44	P	
2	0.2340	41.70		23.13	10.25	51.95		33.38	62.30	52.30	-10.35	-18.92	P	
3	0.3180	36.04		24.65	10.30	46.34		34.95	59.76	49.76	-13.42	-14.81	P	
4	1.2740	32.95		14.24	10.38	43.33		24.62	56.00	46.00	-12.67	-21.38	P	
5	9.3059	35.74		25.13	10.31	46.05		35.44	60.00	50.00	-13.95	-14.56	P	
6	10.6699	37.85		25.17	10.10	47.95		35.27	60.00	50.00	-12.05	-14.73	P	

APPENDIX I
PHOTOGRAPHS OF THE EUT
TOP VIEW OF SAMPLE



BOTTOM VIEW OF SAMPLE



LEFT VIEW OF SAMPLE



RIGHT VIEW OF SAMPLE



FRONT VIEW OF SAMPLE



BACK VIEW OF SAMPLE



ALL VIEW OF SAMPLE



OPEN VIEW OF SAMPLE (Single SIM Card)



INTERNAL VIEW OF SAMPLE-2

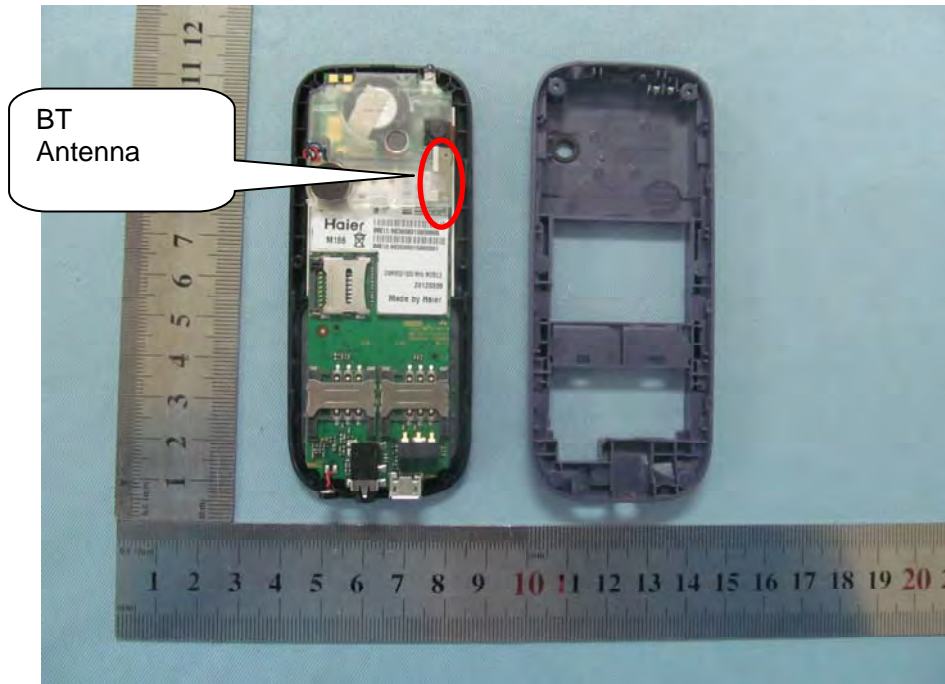

INTERNAL VIEW OF SAMPLE-3

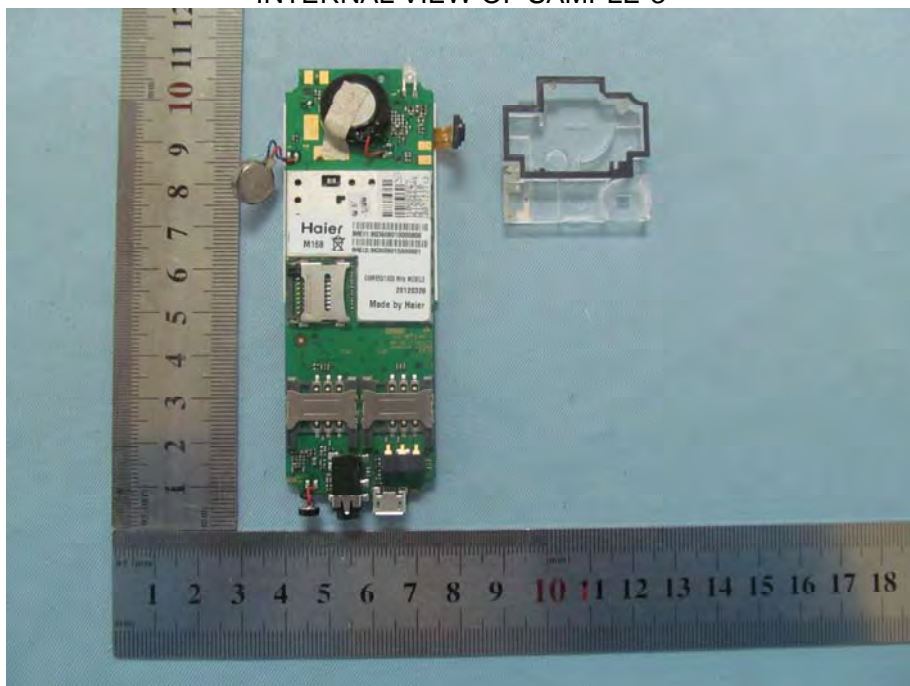

INTERNAL VIEW OF SAMPLE-4

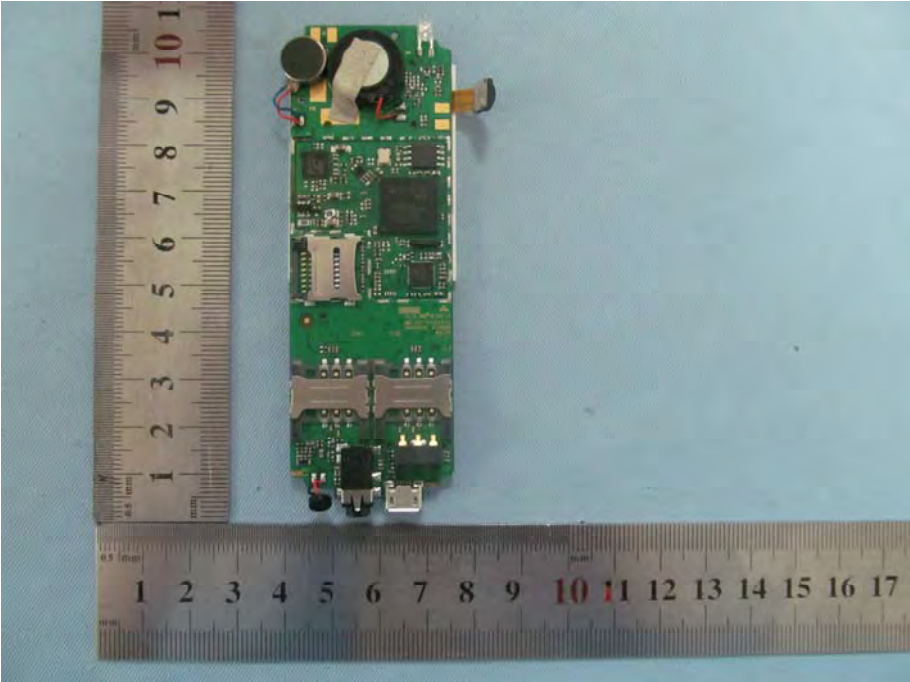

INTERNAL VIEW OF SAMPLE-5

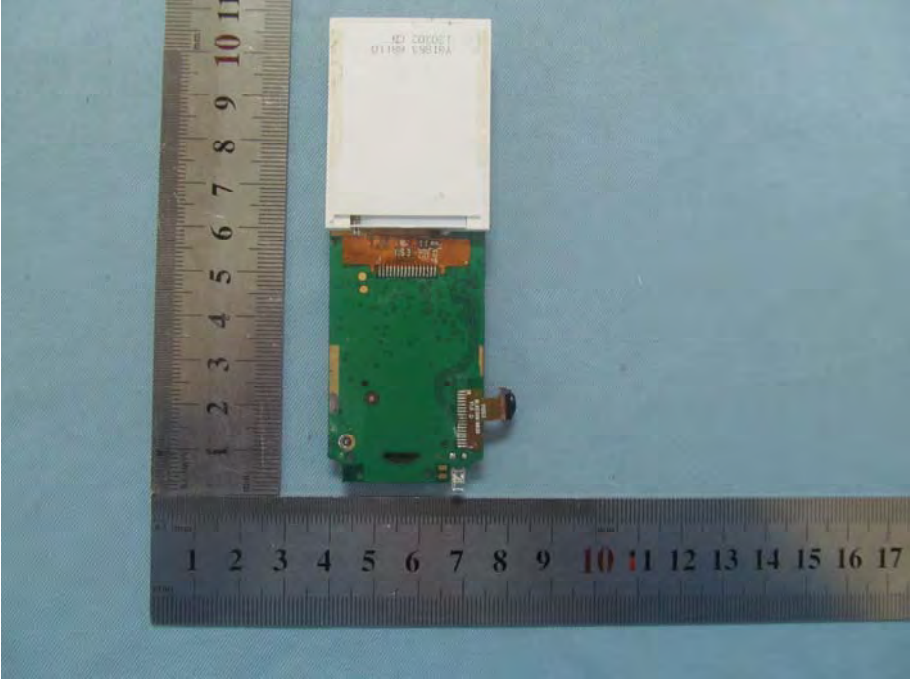

APPENDIX II
PHOTOGRAPHS OF THE TEST SETUP
CONDUCTED EMISSION



RADIATED SPURIOUS EMISSION



----END OF REPORT----