

FCC RF Test Report

APPLICANT : Communication PL Haier Group
EQUIPMENT : GSM Mobilephone
BRAND NAME : Haier
MODEL NAME : HG-U69
FCC ID : SG71102HG-U69
STANDARD : FCC 47 CFR Part 2, 22(H), 24(E)
CLASSIFICATION : PCS Licensed Transmitter Held to Ear (PCE)
Tx/Rx FREQUENCY RANGE : GSM850 : 824.2 ~ 848.8 MHz /
869.2 ~ 893.8 MHz
GSM1900 : 1850.2 ~ 1909.8 MHz /
1930.2 ~ 1989.8 MHz
MAX. ERP/EIRP POWER : GSM850 (GSM) : 0.87 W
GSM1900 (GSM) : 1.01 W
EMISSION DESIGNATOR : 246KGXW

The product was received on Feb. 15, 2011 and completely tested on Mar. 03, 2011. We, SPORTON International (KUNSHAN) Inc., would like to declare that the tested sample has been evaluated in accordance with the procedures given in ANSI / TIA / EIA-603-C-2004 and shown compliance with the applicable technical standards.

The test results in this report apply exclusively to the tested model / sample. Without written approval of SPORTON International (KUNSHAN) Inc., the test report shall not be reproduced except in full.

Reviewed by:

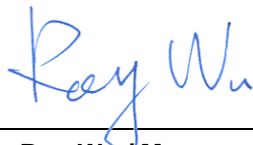

Roy Wu / Manager



SPORTON INTERNATIONAL (KUNSHAN) INC.
No. 3-2, PingXiang Road, Kunshan, Jiangsu Province, P.R.C.



TABLE OF CONTENTS

REVISION HISTORY	3
SUMMARY OF TEST RESULT	4
1 GENERAL DESCRIPTION	5
1.1 Applicant.....	5
1.2 Manufacturer	5
1.3 Feature of Equipment Under Test.....	5
1.4 Testing Site.....	6
1.5 Applied Standards	6
1.6 Ancillary Equipment List	6
2 TEST CONFIGURATION OF EQUIPMENT UNDER TEST	7
2.1 Test Mode.....	7
2.2 Connection Diagram of Test System	8
3 TEST RESULT	9
3.1 Conducted Output Power Measurement.....	9
3.2 Effective Radiated Power and Effective Isotropic Radiated Power Measurement	11
3.3 Occupied Bandwidth Measurement	14
3.4 Band Edge Measurement.....	17
3.5 Conducted Emission Measurement	20
3.6 Field Strength of Spurious Radiation Measurement	26
3.7 Frequency Stability Measurement.....	32
4 LIST OF MEASURING EQUIPMENT	36
5 UNCERTAINTY OF EVALUATION	37
APPENDIX A. PHOTOGRAPHS OF EUT	
APPENDIX B. SETUP PHOTOGRAPHS	



REVISION HISTORY

REPORT NO.	VERSION	DESCRIPTION	ISSUED DATE
FG121531	Rev. 01	Initial issue of report	Mar. 10, 2011



SUMMARY OF TEST RESULT

Report Section	FCC Rule	IC Rule	Description	Limit	Result	Remark
3.1	§2.1046	N/A	Conducted Output Power	N/A	PASS	-
3.2	§22.913(a)(2)	RSS-132(4.4) SRSP-503(5.1.3)	Effective Radiated Power	< 7 Watts	PASS	-
3.2	§24.232(c)	RSS-133 (6.4) SRSP-510(5.1.2)	Equivalent Isotropic Radiated Power	< 2 Watts	PASS	-
3.3	§2.1049 §22.917(a) §24.238(a)	N/A	Occupied Bandwidth	N/A	PASS	-
3.4	§2.1051 §22.917(a) §24.238(a)	RSS-132 (4.5.1) RSS-133 (6.5.1)	Band Edge Measurement	< 43+10log ₁₀ (P[Watts])	PASS	-
3.5	§2.1051 §22.917(a) §24.238(a)	RSS-132 (4.5.1) RSS-133 (6.5.1)	Conducted Emission	< 43+10log ₁₀ (P[Watts])	PASS	-
3.6	§2.1053 §22.917(a) §24.238(a)	RSS-132 (4.5.1) RSS-133 (6.5.1)	Field Strength of Spurious Radiation	< 43+10log ₁₀ (P[Watts])	PASS	Under limit 24.05 dB at 1672 MHz
3.7	§2.1055 §22.355 §24.235	RSS-132(4.3) RSS-133(6.3)	Frequency Stability for Temperature & Voltage	< 2.5 ppm	PASS	-

1 General Description

1.1 Applicant

Communication PL Haier Group

No. 1, Haier Road, Hi-tech Zone, Qingdao 266101, P.R.China

1.2 Manufacturer

Communication PL Haier Group

No. 1, Haier Road, Hi-tech Zone, Qingdao 266101, P.R.China

1.3 Feature of Equipment Under Test

Product Feature & Specification	
Equipment	GSM Mobilephone
Brand Name	Haier
Model Name	HG-U69
FCC ID	SG71102HG-U69
Tx Frequency	GSM850 : 824 MHz ~ 849 MHz GSM1900 : 1850 MHz ~ 1910 MHz
Rx Frequency	GSM850 : 869 MHz ~ 894 MHz GSM1900 : 1930 MHz ~ 1990 MHz
Maximum Output Power to Antenna	GSM850 : 32.42 dBm GSM1900 : 29.06 dBm
Maximum ERP/EIRP	GSM850 (GSM) : 0.87 W (29.39 dBm) GSM1900 (GSM) : 1.01 W (30.03 dBm)
Antenna Type	Fixed Internal Antenna
HW Version	sp
SW Version	HG-U69JH-H01-S006-S-TIGO
Type of Modulation	GMSK
Type of Emission	246KGXW
EUT Stage	Identical Prototype

Remark:

1. For other wireless features of this EUT, the test report will be issued separately.
2. This test report recorded only product characteristics and test results of PCS Licensed Transmitter Held to Ear (PCE).
3. The above EUT's information was declared by manufacturer. Please refer to the specifications or user's manual for more detailed description.

1.4 Testing Site

Test Site	SPORTON INTERNATIONAL (KUNSHAN) INC.	
Test Site Location	No. 3-2, PingXiang Road, Kunshan, Jiangsu Province, P.R.C. TEL: +86-0512-5790-0158 FAX: +86-0512-5790-0958	
Test Site No.	Sporton Site No.	
	TH01-KS	03CH01-KS

1.5 Applied Standards

According to the specifications of the manufacturer, the EUT must comply with the requirements of the following standards:

- FCC 47 CFR Part 2, 22(H), 24(E)
- ANSI / TIA / EIA-603-C-2004
- IC RSS-132 Issue 2
- IC RSS-133 Issue 5

Remark:

1. All test items were verified and recorded according to the standards and without any deviation during the test.
2. This EUT has also been tested and complied with the requirements of FCC Part 15, Subpart B (DoC), recorded in a separate test report.

1.6 Ancillary Equipment List

Item	Equipment	Trade Name	Model No.	FCC ID	Data Cable	Power Cord
1.	System Simulator	R&S	CMU200	N/A	N/A	Unshielded, 1.8 m

2 Test Configuration of Equipment Under Test

2.1 Test Mode

During all testing, EUT is in link mode with base station emulator at maximum power level. The spurious emission measurements were carried out in semi-anechoic chamber with 3-meter test range, and EUT is rotated on three test planes to find out the worst emission.

Frequency range investigated for radiated emission is as follows:

1. 30 MHz to 9000 MHz for GSM850.
2. 30 MHz to 19000 MHz for GSM1900.

Test Modes		
Band	Radiated TCs	Conducted TCs
GSM 850	■ GSM Link	■ GSM Link
GSM 1900	■ GSM Link	■ GSM Link

Note:

1. The maximum power levels are GSM GMSK link, only these modes were used for all tests.
2. Because there are individual antennas for each WWAN and Bluetooth, the co-location test modes are not required.

The conducted power tables are as follows:

Conducted Power (*Unit: dBm)						
Band	GSM850			GSM1900		
Channel	128	189	251	512	661	810
Frequency	824.2	836.4	848.8	1850.2	1880.0	1909.8
GSM	32.42	32.38	32.36	29.06	29.03	28.84
GPRS 8	32.28	32.24	32.21	28.85	28.82	28.63
GPRS 10	31.15	31.12	31.10	27.78	27.75	27.55
GPRS 12	28.41	28.40	28.38	25.23	25.21	25.01

2.2 Connection Diagram of Test System

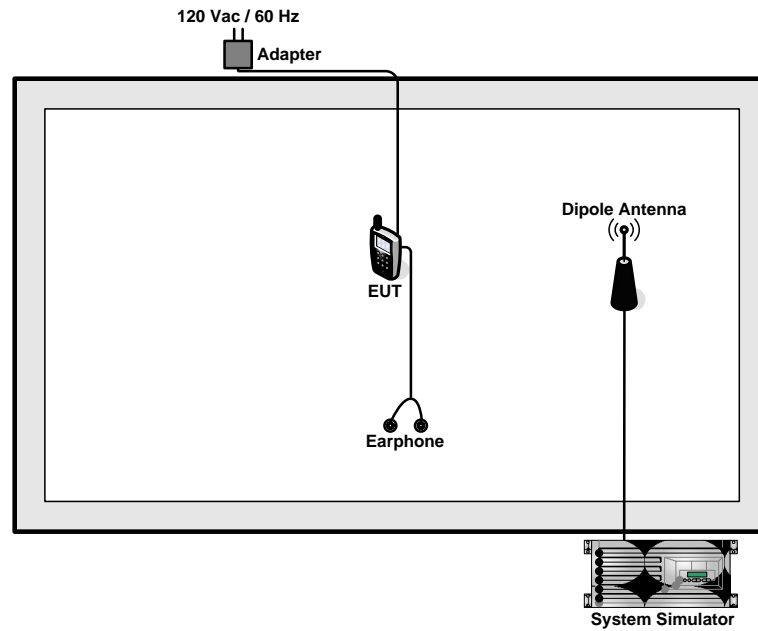

3 Test Result

3.1 Conducted Output Power Measurement

3.1.1 Description of the Conducted Output Power Measurement

A base station simulator was used to establish communication with the EUT. Its parameters were set to transmit the maximum power on the EUT. The measured power in the radio frequency on the transmitter output terminals shall be reported.

3.1.2 Measuring Instruments

See list of measuring instruments of this test report.

3.1.3 Test Procedures

1. The transmitter output port was connected to base station.
2. Set EUT at maximum power through base station.
3. Select lowest, middle, and highest channels for each band and different modulation.

3.1.4 Test Setup

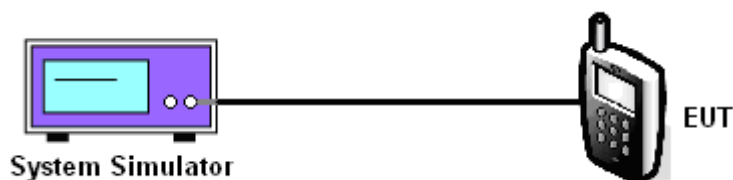

3.1.5 Test Result of Conducted Output Power

Cellular Band				
Modes	Channel	Frequency (MHz)	Conducted Power (dBm)	Conducted Power (Watts)
GSM850 (GSM)	128 (Low)	824.2	32.42	1.75
	189 (Mid)	836.4	32.38	1.73
	251 (High)	848.8	32.36	1.72

PCS Band				
Modes	Channel	Frequency (MHz)	Conducted Power (dBm)	Conducted Power (Watts)
GSM1900 (GSM)	512 (Low)	1850.2	29.06	0.81
	661 (Mid)	1880.0	29.03	0.80
	810 (High)	1909.8	28.84	0.77

3.2 Effective Radiated Power and Effective Isotropic Radiated Power Measurement

3.2.1 Description of the ERP/EIRP Measurement

ERP/EIRP is measured by substitution method according to ANSI / TIA / EIA-603-C-2004. The ERP of mobile transmitters must not exceed 7 Watts and the EIRP of mobile transmitters are limited to 2 Watts.

3.2.2 Measuring Instruments

See list of measuring instruments of this test report.

3.2.3 Test Procedures

1. The EUT was placed on a turntable with 1.0 meter height in a fully anechoic chamber.
2. The EUT was set at 1.2 meters from the receiving antenna, which was mounted on the antenna tower.
3. The table was rotated 360 degrees to determine the position of the highest radiated power.
4. The height of the receiving antenna is adjusted to look for the maximum ERP/EIRP.
5. Taking the record of maximum ERP/EIRP.
6. A dipole antenna was substituted in place of the EUT and was driven by a signal generator.
7. The conducted power at the terminal of the dipole antenna is measured.
8. Repeat step 3 to step 5 to get the maximum ERP/EIRP of the substitution antenna.
9. $ERP/EIRP = P_s + E_t - E_s + G_s = P_s + R_t - R_s + G_s$
Ps (dBm) : Input power to substitution antenna.
Gs (dBi or dBd) : Substitution antenna Gain.
 $E_t = R_t + AF$
 $E_s = R_s + AF$
AF (dB/m) : Receive antenna factor
Rt : The highest received signal in spectrum analyzer for EUT.
Rs : The highest received signal in spectrum analyzer for substitution antenna.

3.2.4 Test Setup

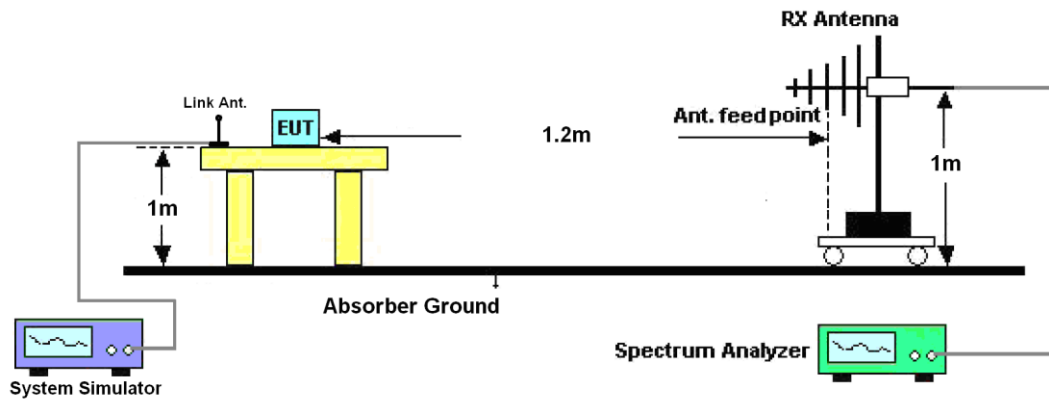

3.2.5 Test Result of ERP

GSM850 (GSM) Radiated Power ERP						
Horizontal Polarization						
Frequency (MHz)	Rt (dBm)	Rs (dBm)	Ps (dBm)	Gs (dBd)	ERP (dBm)	ERP (W)
824.20	-18.75	-48.12	0.00	-1.08	28.29	0.67
836.40	-18.27	-48.28	0.00	-0.93	29.08	0.81
848.80	-18.20	-48.35	0.00	-0.76	29.39	0.87
Vertical Polarization						
Frequency (MHz)	Rt (dBm)	Rs (dBm)	Ps (dBm)	Gs (dBd)	ERP (dBm)	ERP (W)
824.20	-32.18	-47.97	0.00	-1.08	14.71	0.03
836.40	-31.13	-48.01	0.00	-0.93	15.95	0.04
848.80	-30.37	-48.05	0.00	-0.76	16.92	0.05

3.2.6 Test Result of EIRP

GSM1900 (GSM) Radiated Power EIRP						
Horizontal Polarization						
Frequency (MHz)	Rt (dBm)	Rs (dBm)	Ps (dBm)	Gs (dBi)	EIRP (dBm)	EIRP (W)
1850.20	-24.16	-51.88	0.00	1.96	29.68	0.93
1880.00	-24.96	-52.99	0.00	2.00	30.03	1.01
1909.80	-27.05	-54.28	0.00	1.98	29.21	0.83
Vertical Polarization						
Frequency (MHz)	Rt (dBm)	Rs (dBm)	Ps (dBm)	Gs (dBi)	EIRP (dBm)	EIRP (W)
1850.20	-26.87	-52.13	0.00	1.96	27.22	0.53
1880.00	-27.20	-53.17	0.00	2.00	27.97	0.63
1909.80	-28.03	-54.13	0.00	1.98	28.08	0.64

3.3 Occupied Bandwidth Measurement

3.3.1 Description of Occupied Bandwidth Measurement

The emission bandwidth is defined as the width of the signal between two points, located at the 2 sides of the carrier frequency, outside of which all emissions are attenuated at least 26 dB below the transmitter power.

3.3.2 Measuring Instruments

See list of measuring instruments of this test report.

3.3.3 Test Procedures

1. The EUT was connected to Spectrum Analyzer and Base Station via power divider.
2. The 99% and 26 dB occupied bandwidth (BW) of the middle channel for the highest RF powers were measured.

3.3.4 Test Setup

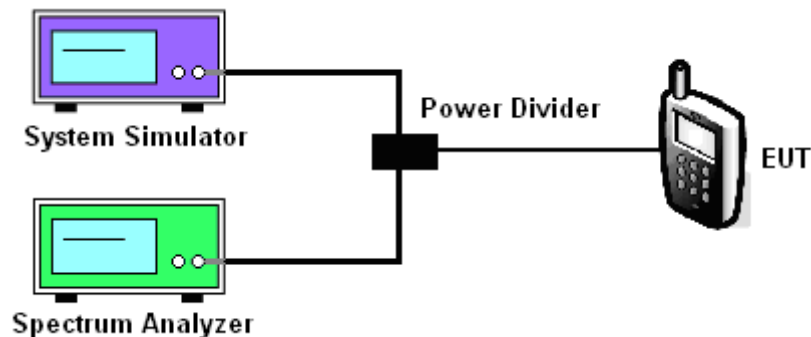



3.3.5 Test Result (Plots) of Occupied Bandwidth

Band :	GSM 850	Power Stage :	High
Test Mode :	GSM Link		

99% Occupied Bandwidth Plot on Channel 189

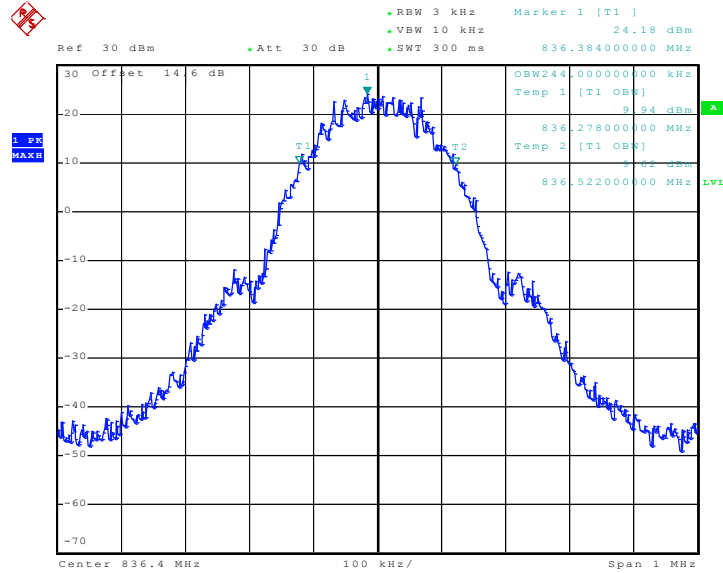

TH-01

Date: 18.FEB.2011 10:56:38

26dB Bandwidth Plot on Channel 189

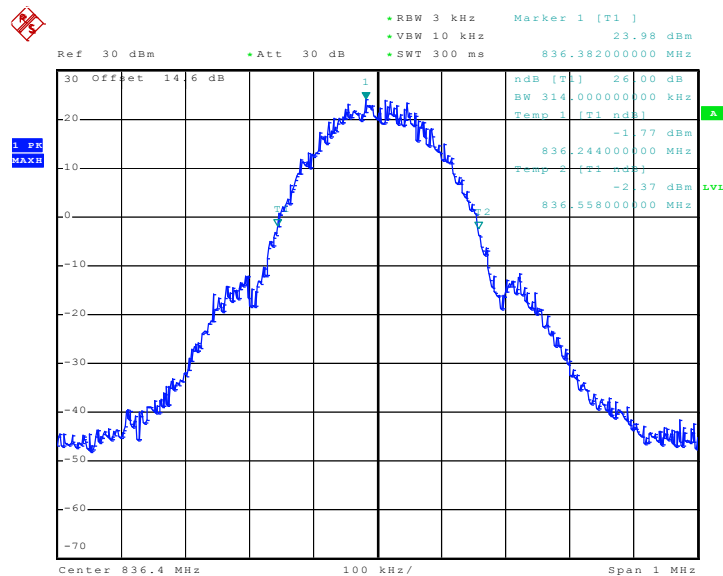

TH-01

Date: 18.FEB.2011 10:55:19



Band :	GSM 1900	Power Stage :	High
Test Mode :	GSM Link		

99% Occupied Bandwidth Plot on Channel 661

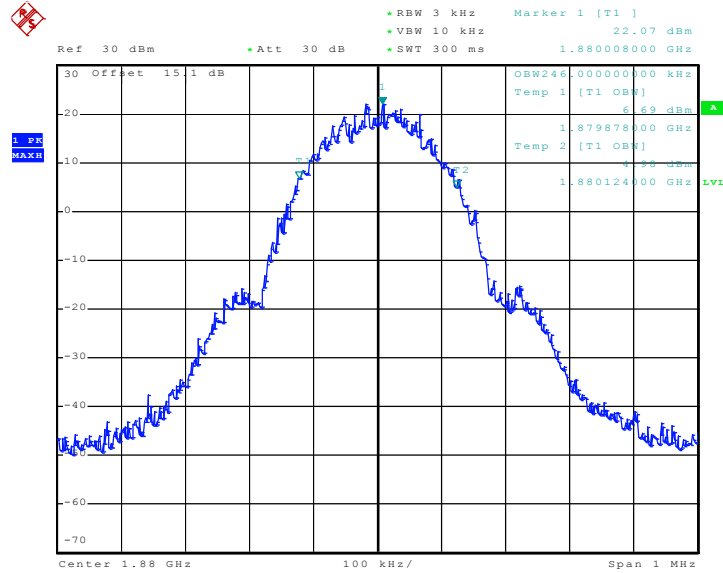

TH-01

Date: 18.FEB.2011 10:27:39

26dB Bandwidth Plot on Channel 661

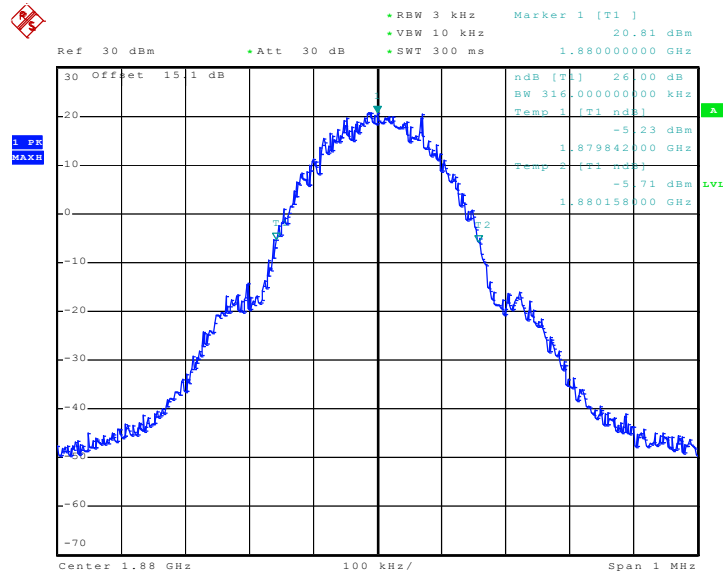

TH-01

Date: 18.FEB.2011 10:26:21

3.4 Band Edge Measurement

3.4.1 Description of Band Edge Measurement

The power of any emission outside of the authorized operating frequency ranges must be lower than the transmitter power (P) by a factor of at least $43 + 10 \log (P)$ dB.

3.4.2 Measuring Instruments

See list of measuring instruments of this test report.

3.4.3 Test Procedures

1. The EUT was connected to Spectrum Analyzer and Base Station via power divider.
2. The band edges of low and high channels for the highest RF powers were measured. Setting RBW as roughly BW/100.

3.4.4 Test Setup

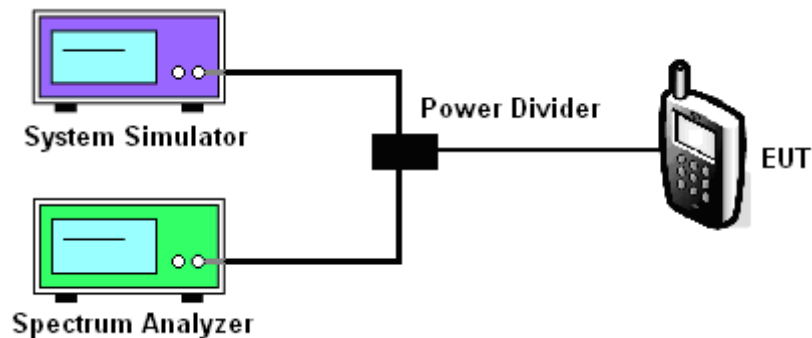

3.4.5 Test Result (Plots) of Conducted Band Edge

Band :	GSM850	Power Stage :	High
Test Mode :	GSM Link		

Lower Band Edge Plot on Channel 128

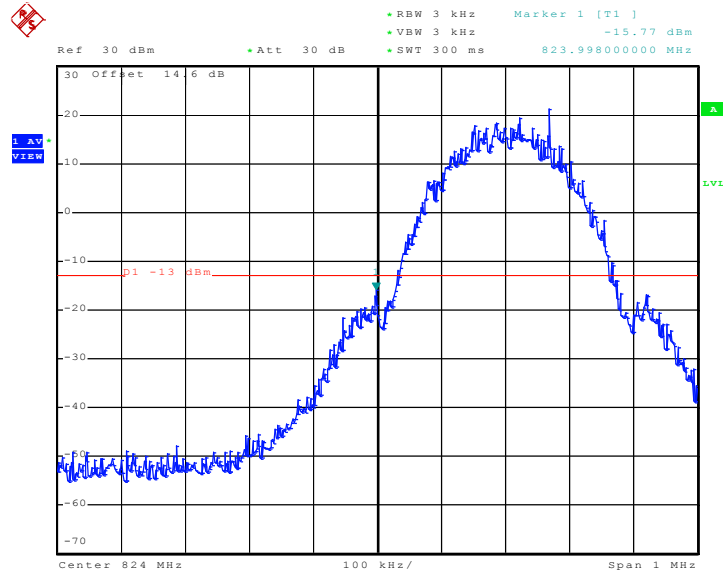

TH-01

Date: 18.FEB.2011 10:58:29

Higher Band Edge Plot on Channel 251

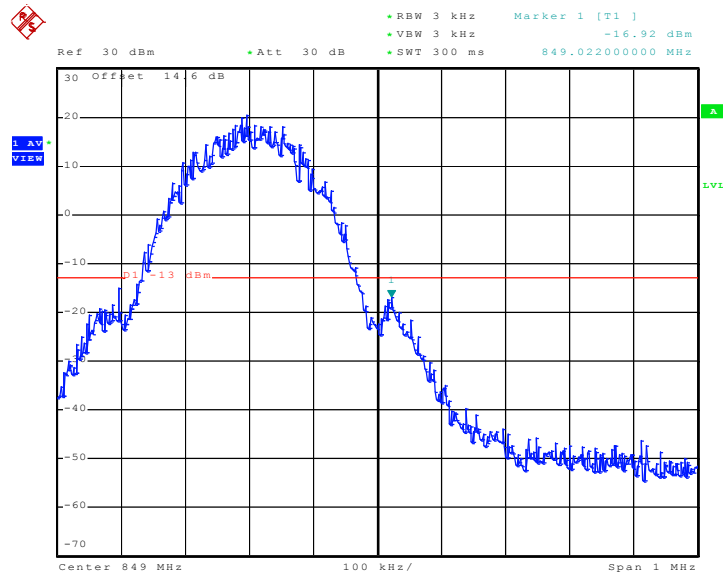

TH-01

Date: 18.FEB.2011 10:58:55



Band :	GSM1900	Power Stage :	High
Test Mode :	GSM Link		

Lower Band Edge Plot on Channel 512

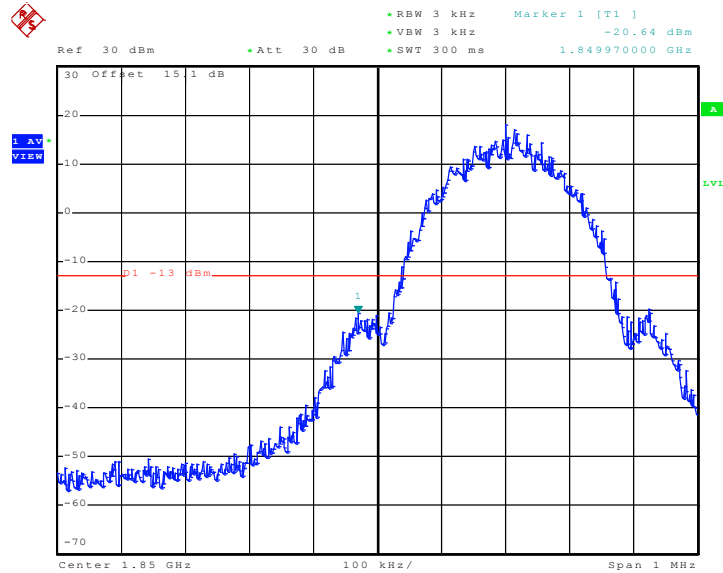

TH-01
Date: 18.FEB.2011 10:29:30

Higher Band Edge Plot on Channel 810

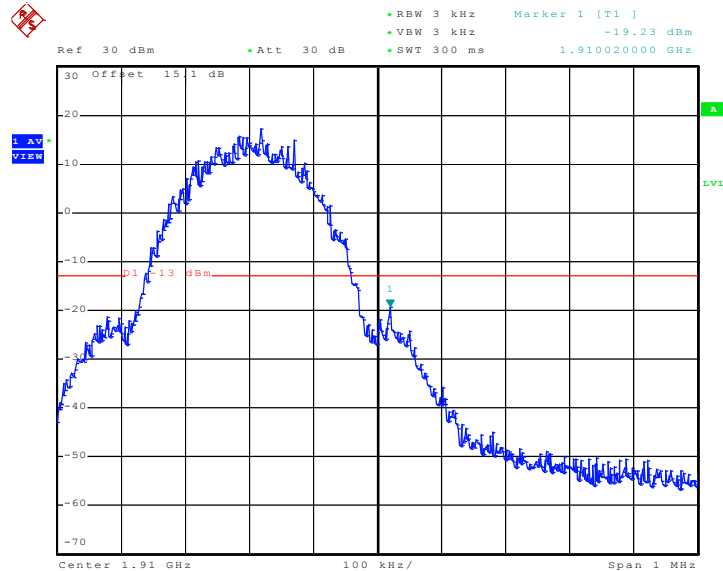

TH-01
Date: 18.FEB.2011 10:29:56

3.5 Conducted Emission Measurement

3.5.1 Description of Conducted Emission Measurement

The power of any emission outside of the authorized operating frequency ranges must be lower than the transmitter power (P) by a factor of at least $43 + 10 \log (P)$ dB.

It is measured by means of a calibrated spectrum analyzer and scanned from 30 MHz up to a frequency including its 10th harmonic.

3.5.2 Measuring Instruments

See list of measuring instruments of this test report.

3.5.3 Test Procedures

1. The EUT was connected to spectrum analyzer and base station via power divider.
2. The middle channel for the highest RF power within the transmitting frequency was measured.
3. The conducted spurious emission for the whole frequency range was taken.

3.5.4 Test Setup

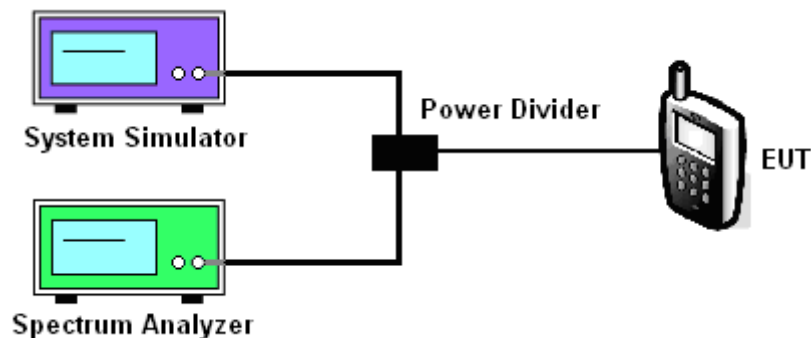

3.5.5 Test Result (Plots) of Conducted Emission

Band :	GSM850	Channel :	CH189
Test Mode :	GSM Link		

Conducted Emission Plot between 30MHz ~ 1GHz

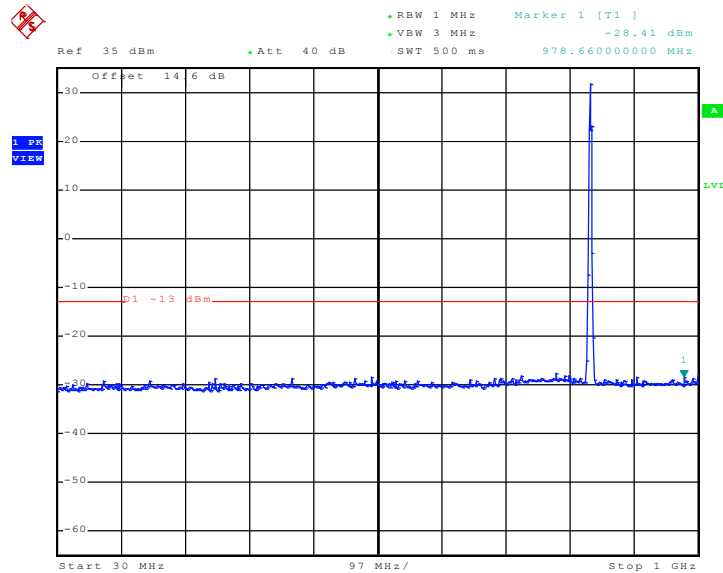

TH-01

Date: 18.FEB.2011 11:05:11

Conducted Emission Plot between 1GHz ~ 3GHz

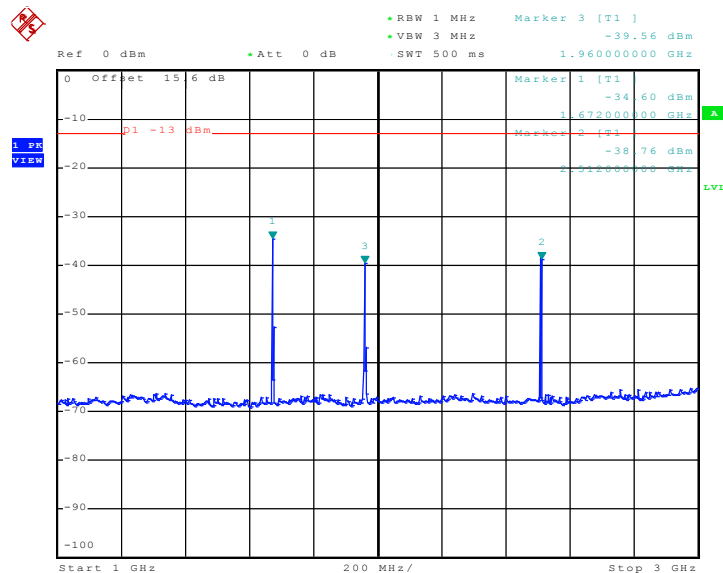

TH-01

Date: 18.FEB.2011 11:07:31

Conducted Emission Plot between 3GHz ~ 7GHz

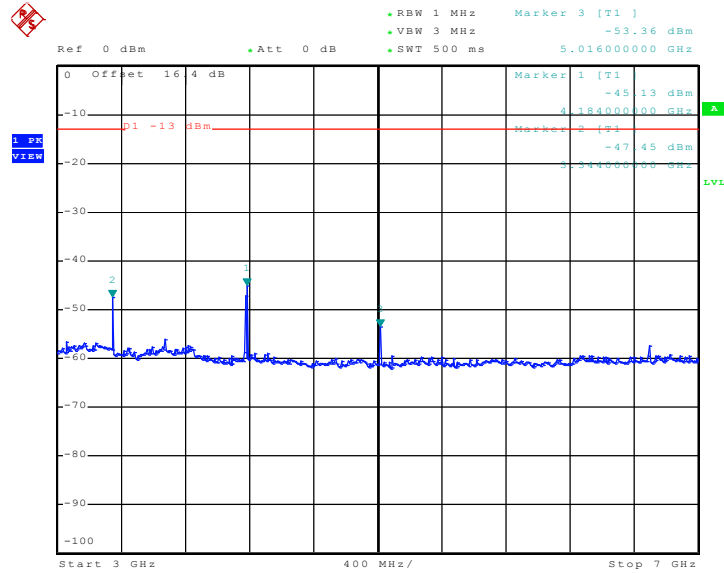

TH-01

Date: 18.FEB.2011 11:12:35

Conducted Emission Plot between 7GHz ~ 9GHz

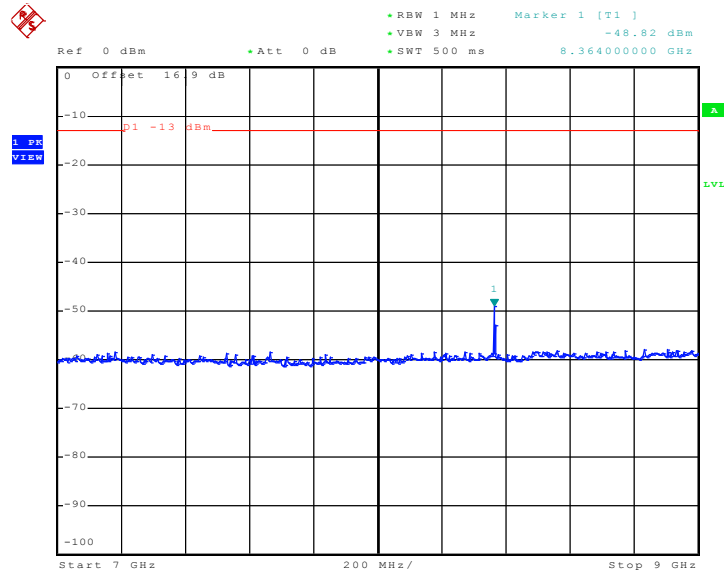

TH-01

Date: 18.FEB.2011 11:11:45



Band :	GSM1900	Channel :	CH661
Test Mode :	GSM Link		

Conducted Emission Plot between 30MHz ~ 1GHz

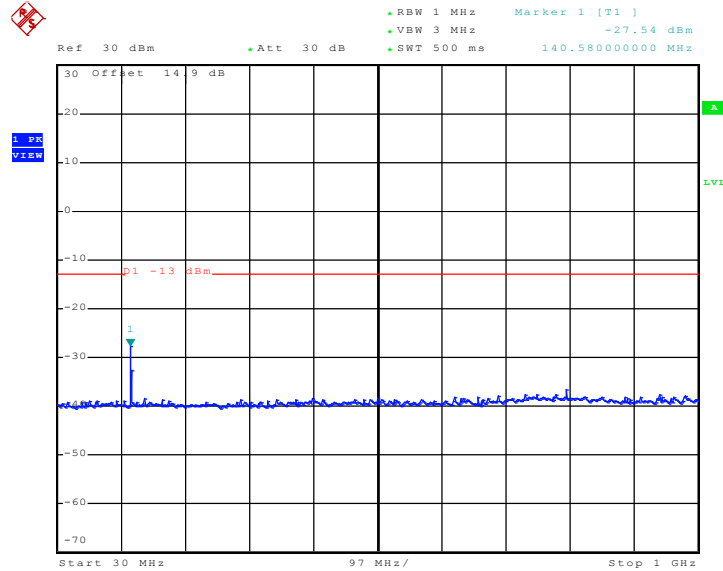

TH-01

Date: 18.FEB.2011 10:40:51

Conducted Emission Plot between 1GHz ~ 3GHz

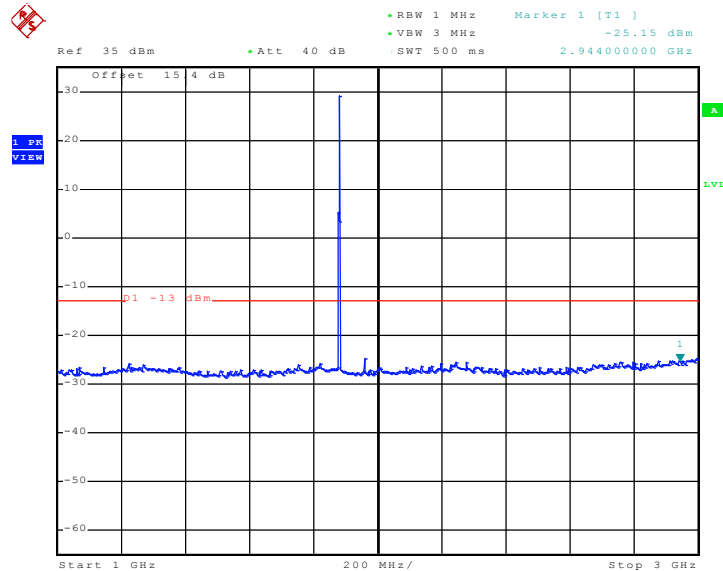

TH-01

Date: 18.FEB.2011 10:43:52



Conducted Emission Plot between 3GHz ~ 7GHz

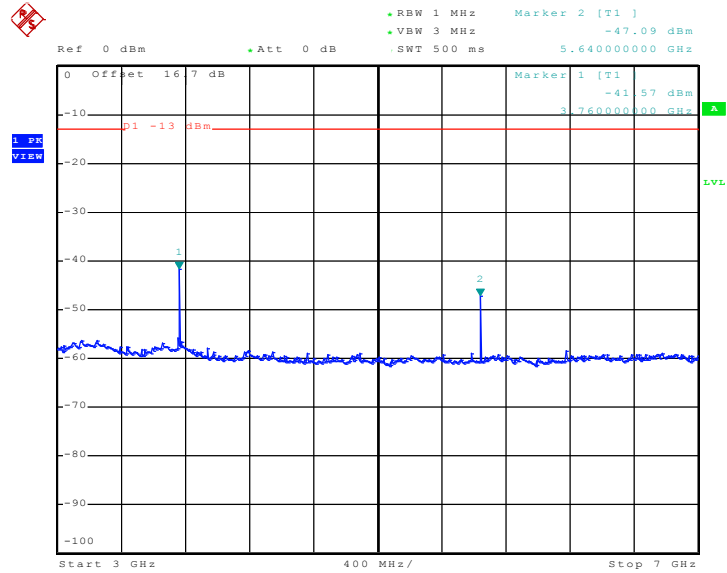

TH-01

Date: 18.FEB.2011 10:46:34

Conducted Emission Plot between 7GHz ~ 13.6GHz

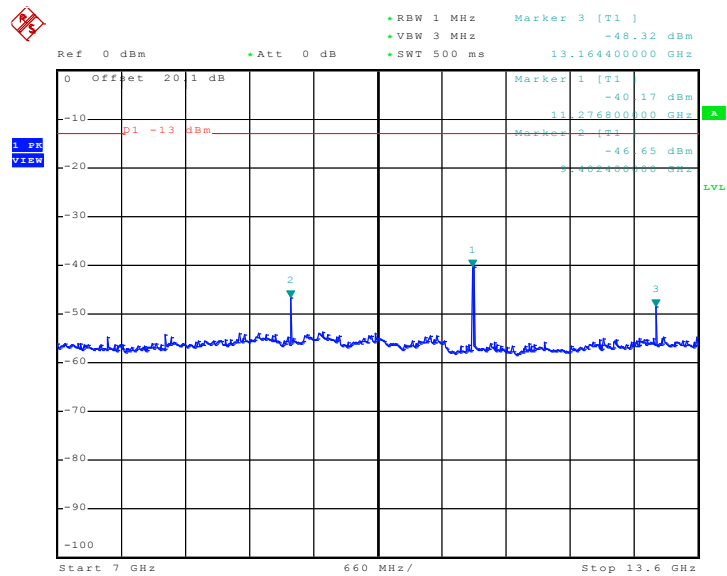

TH-01

Date: 18.FEB.2011 10:48:37



Conducted Emission Plot between 13.6GHz ~ 19.1GHz

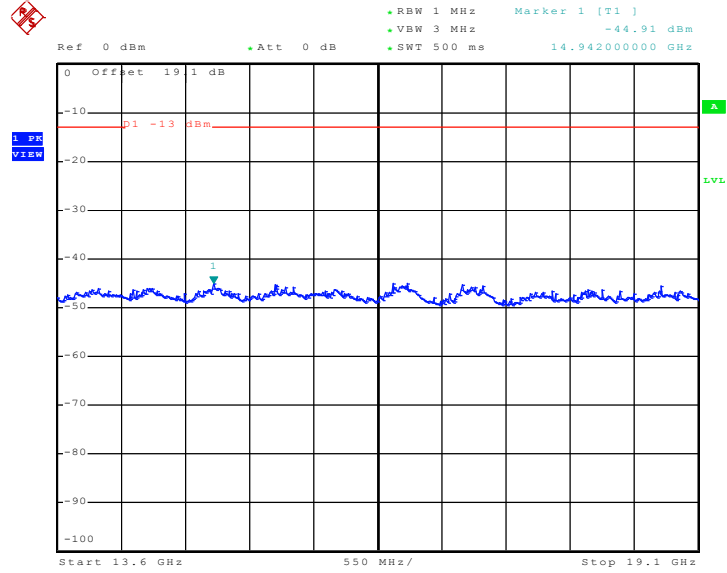

TH-01

Date: 18.FEB.2011 10:50:08

3.6 Field Strength of Spurious Radiation Measurement

3.6.1 Description of Field Strength of Spurious Radiated Measurement

The radiated spurious emission was measured by substitution method according to ANSI / TIA / EIA-603-C-2004. The power of any emission outside of the authorized operating frequency ranges must be attenuated below the transmitter power (P) by a factor of at least $43 + 10 \log (P)$ dB. The spectrum is scanned from 30 MHz up to a frequency including its 10th harmonic.

3.6.2 Measuring Instruments

See list of measuring instruments of this test report.

3.6.3 Test Procedures

1. The EUT was placed on a rotatable wooden table with 0.8 meter about ground.
2. The EUT was set 3 meters from the receiving antenna, which was mounted on the antenna tower.
3. The table was rotated 360 degrees to determine the position of the highest spurious emission.
4. The height of the receiving antenna is varied between one meter and four meters to search the maximum spurious emission for both horizontal and vertical polarizations.
5. Make the measurement with the spectrum analyzer's RBW = 1MHz, VBW = 3MHz, Sweep = 500ms, Taking the record of maximum spurious emission.
6. A horn antenna was substituted in place of the EUT and was driven by a signal generator.
7. Tune the output power of signal generator to the same emission level with EUT maximum spurious emission.
8. Taking the record of output power at antenna port.
9. Repeat step 7 to step 8 for another polarization.
10. $EIRP \text{ (dBm)} = S.G. \text{ Power} - Tx \text{ Cable Loss} + Tx \text{ Antenna Gain}$
11. $ERP \text{ (dBm)} = EIRP - 2.15$

3.6.4 Test Setup

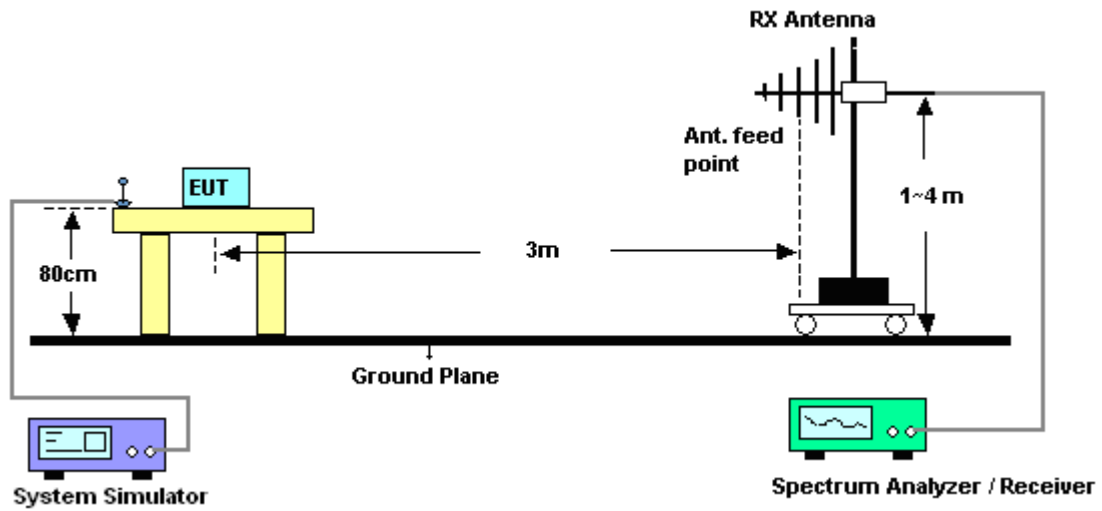



3.6.5 Test Result of Field Strength of Spurious Radiated

Band :	GSM850	Temperature :	22~23°C
Test Mode :	GSM Link	Relative Humidity :	40~41%
Test Engineer :	Cloud Peng	Polarization :	Horizontal
Remark :	Spurious emissions within 30-1000MHz were found more than 20dB below limit line.		

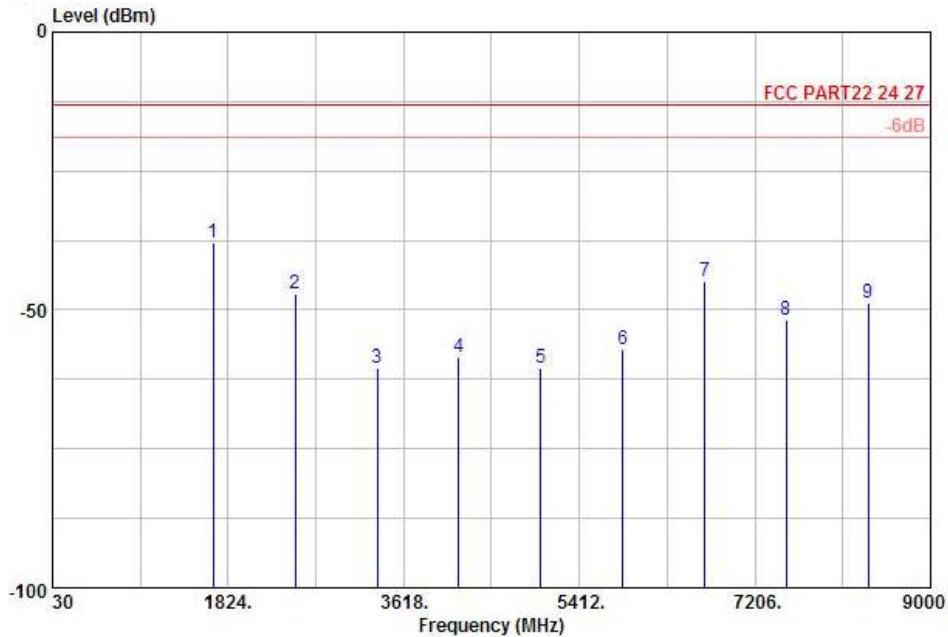

Site : 03CH01-KS
 Condition: FCC PART22 24 27 HF EIRP FACTOR-09020 HORIZONTAL

Plane : E1

Frequency (MHz)	ERP (dBm)	Limit (dBm)	Over Limit (dB)	SPA Reading (dBm)	S.G. Power (dBm)	TX Cable loss (dB)	TX Antenna Gain (dBi)	Polarization (H/V)	Result
1672	-37.98	-13	-24.98	-38.22	-38.63	0.57	3.37	H	Pass
2510	-47.05	-13	-34.05	-49.76	-49.28	0.78	5.16	H	Pass
3345	-60.44	-13	-47.44	-62.38	-64.08	0.87	6.66	H	Pass
4182	-58.48	-13	-45.48	-61.22	-63.07	0.97	7.71	H	Pass
5018	-60.49	-13	-47.49	-66.69	-66.16	1.09	8.91	H	Pass
5856	-57.02	-13	-44.02	-65.73	-63.46	1.22	9.81	H	Pass
6692	-44.81	-13	-31.81	-56.13	-52.03	1.25	10.62	H	Pass
7528	-51.74	-13	-38.74	-64.51	-59.64	1.42	11.47	H	Pass
8366	-48.84	-13	-35.84	-61.88	-57.42	1.5	12.23	H	Pass



Band :	GSM850	Temperature :	22~23°C
Test Mode :	GSM Link	Relative Humidity :	40~41%
Test Engineer :	Cloud Peng	Polarization :	Vertical
Remark :	Spurious emissions within 30-1000MHz were found more than 20dB below limit line.		

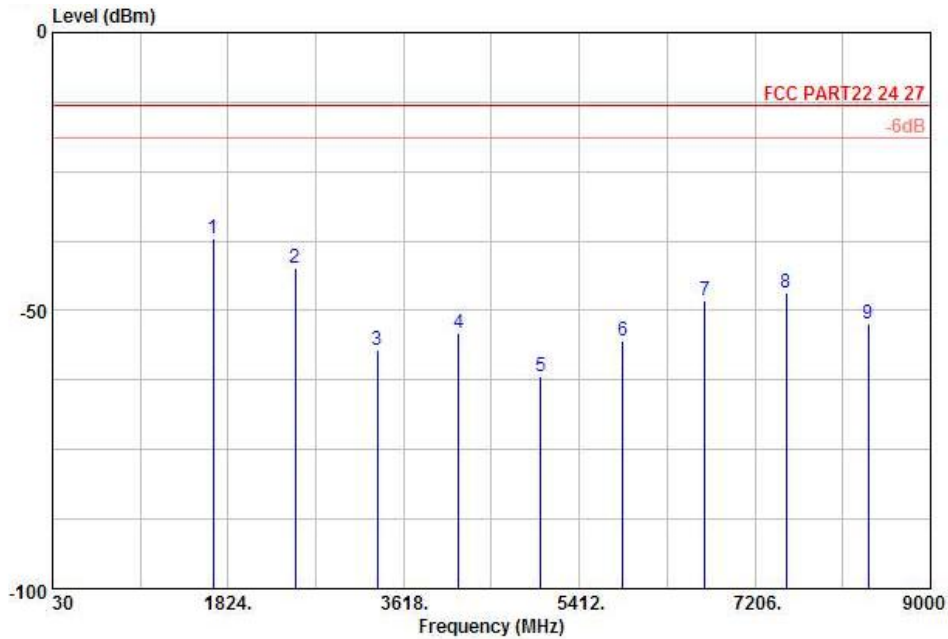

Site : 03CH01-KS
 Condition: FCC PART22 24 27 HF EIRP FACTOR-09020 VERTICAL

Plane : E1

Frequency (MHz)	ERP (dBm)	Limit (dBm)	Over Limit (dB)	SPA Reading (dBm)	S.G. Power (dBm)	TX Cable loss (dB)	TX Antenna Gain (dBi)	Polarization (H/V)	Result
1672	-37.05	-13	-24.05	-42.12	-37.70	0.57	3.37	V	Pass
2512	-42.36	-13	-29.36	-47.87	-44.59	0.78	5.16	V	Pass
3346	-57.11	-13	-44.11	-59.09	-60.75	0.87	6.66	V	Pass
4182	-53.91	-13	-40.91	-57.75	-58.50	0.97	7.71	V	Pass
5018	-61.71	-13	-48.71	-66.65	-67.38	1.09	8.91	V	Pass
5854	-55.37	-13	-42.37	-63.36	-61.81	1.22	9.81	V	Pass
6692	-48.06	-13	-35.06	-58.77	-55.28	1.25	10.62	V	Pass
7528	-46.88	-13	-33.88	-60.02	-54.78	1.42	11.47	V	Pass
8364	-52.41	-13	-39.41	-64.77	-60.99	1.50	12.23	V	Pass



Band :	GSM1900	Temperature :	22~23°C
Test Mode :	GSM Link	Relative Humidity :	40~41%
Test Engineer :	Cloud Peng	Polarization :	Horizontal
Remark :	Spurious emissions within 30-1000MHz were found more than 20dB below limit line.		

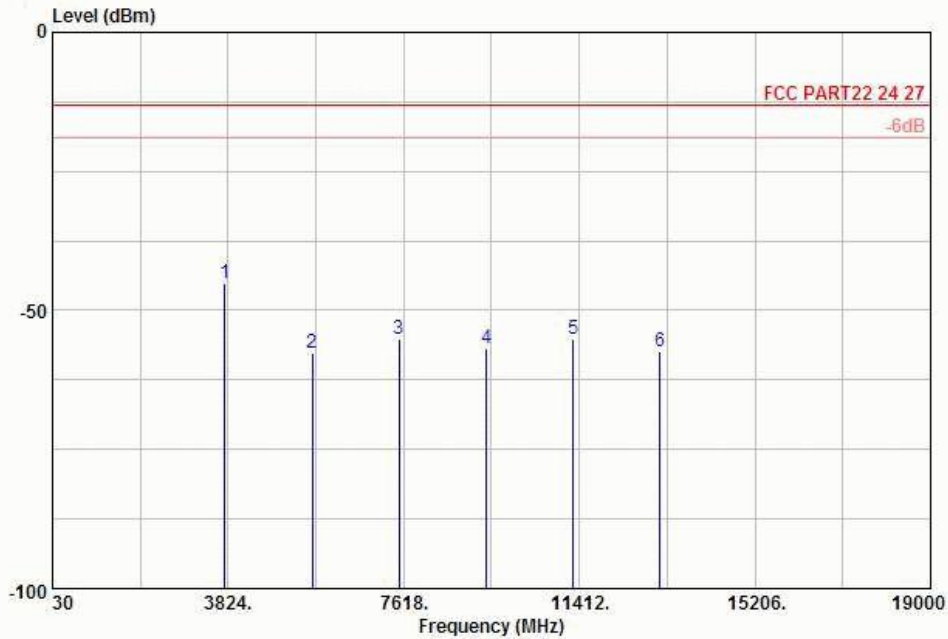

Site : 03CH01-KS
 Condition: FCC PART22 24 27 HF EIRP FACTOR-09020 HORIZONTAL
 Plane : E2

Frequency (MHz)	EIRP (dBm)	Limit (dBm)	Over Limit (dB)	SPA Reading (dBm)	S.G. Power (dBm)	TX Cable loss (dB)	TX Antenna Gain (dBi)	Polarization (H/V)	Result
3760	-45.00	-13	-32.00	-49.55	-51.38	0.78	7.16	H	Pass
5640	-57.58	-13	-44.58	-61.76	-66.12	1.04	9.58	H	Pass
7520	-55.21	-13	-42.21	-60.34	-65.32	1.35	11.46	H	Pass
9399	-56.94	-13	-43.94	-60.20	-68.00	1.75	12.81	H	Pass
11280	-55.10	-13	-42.10	-66.59	-66.19	2	13.09	H	Pass
13160	-57.38	-13	-44.38	-68.68	-69.09	2.04	13.75	H	Pass



Band :	GSM1900	Temperature :	22~23°C
Test Mode :	GSM Link	Relative Humidity :	40~41%
Test Engineer :	Cloud Peng	Polarization :	Vertical
Remark :	Spurious emissions within 30-1000MHz were found more than 20dB below limit line.		

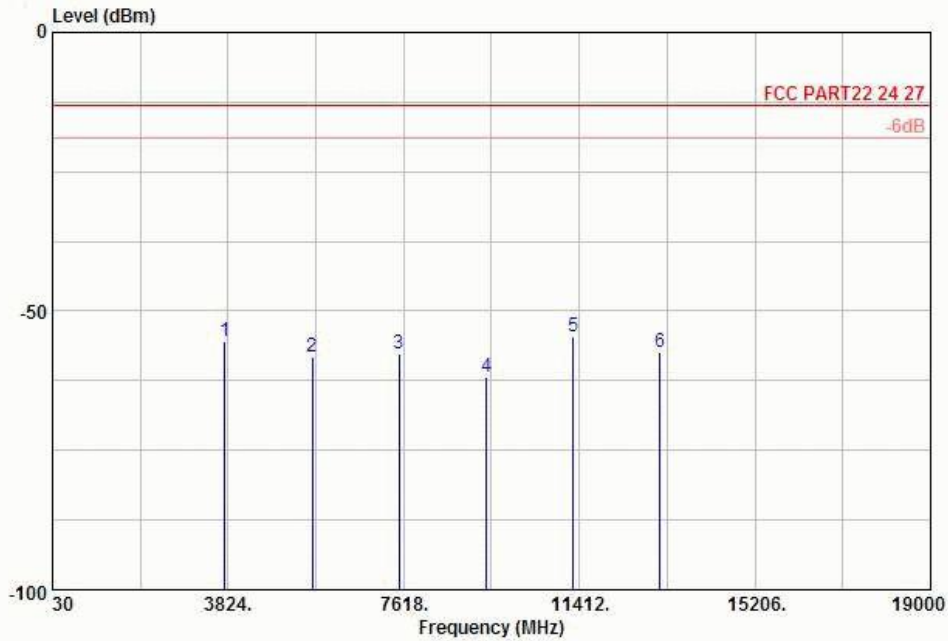

Site : 03CH01-KS
 Condition: FCC PART22 24 27 HF EIRP FACTOR-09020 VERTICAL
 Plane : E2

Frequency (MHz)	EIRP (dBm)	Limit (dBm)	Over Limit (dB)	SPA Reading (dBm)	S.G. Power (dBm)	TX Cable loss (dB)	TX Antenna Gain (dBi)	Polarization (H/V)	Result
3760	-55.56	-13	-42.56	-56.93	-61.94	0.78	7.16	V	Pass
5640	-58.09	-13	-45.09	-61.31	-66.63	1.04	9.58	V	Pass
7520	-57.66	-13	-44.66	-62.15	-67.77	1.35	11.46	V	Pass
9399	-61.90	-13	-48.90	-63.12	-72.96	1.75	12.81	V	Pass
11280	-54.48	-13	-41.48	-65.72	-65.57	2	13.09	V	Pass
13160	-57.51	-13	-44.51	-68.7	-69.22	2.04	13.75	V	Pass

3.7 Frequency Stability Measurement

3.7.1 Description of Frequency Stability Measurement

The frequency stability shall be measured by variation of ambient temperature and variation of primary supply voltage to ensure that the fundamental emission stays within the authorized frequency block. The frequency stability of the transmitter shall be maintained within $\pm 0.00025\%$ ($\pm 2.5\text{ppm}$) of the center frequency.

3.7.2 Measuring Instruments

See list of measuring instruments of this test report.

3.7.3 Test Procedures for Temperature Variation

1. The EUT was set up in the thermal chamber and connected with the base station.
2. With power OFF, the temperature was decreased to -30°C and the EUT was stabilized for three hours. Power was applied and the maximum change in frequency was recorded within one minute.
3. With power OFF, the temperature was raised in 10°C step up to 50°C . The EUT was stabilized at each step for at least half an hour. Power was applied and the maximum frequency change was recorded within one minute.
4. If the EUT can not be turned on at -30°C , the testing lowest temperature will be raised in 10°C step until the EUT can be turned on.

3.7.4 Test Procedures for Voltage Variation

1. The EUT was placed in a temperature chamber at $25\pm 5^{\circ}\text{C}$ and connected with the base station.
2. The power supply voltage to the EUT was varied from BEP to 115% of the nominal value measured at the input to the EUT.
3. The variation in frequency was measured for the worst case.

3.7.5 Test Setup

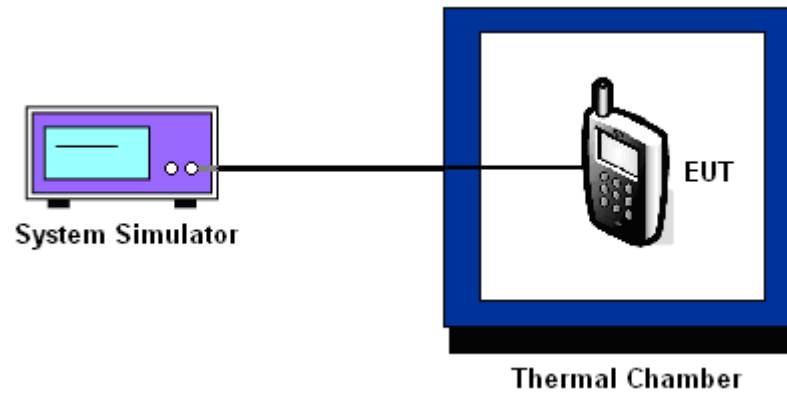

3.7.6 Test Result of Temperature Variation

Band :	GSM 850	Channel :	189
Limit (ppm) :	2.5		

Temperature (°C)	Freq. Dev. (Hz)	Deviation (ppm)	Result
-30	N/A	N/A	PASS
-20	N/A	N/A	
-10	12	0.01	
0	21	0.02	
10	29	0.03	
20	-22	-0.03	
30	-16	-0.02	
40	-23	-0.03	
50	-15	-0.02	

Note:

1. The EUT stops transmitting at temperatures -20°C and -30°C.
2. The manufacturer declared that the EUT could work properly between temperatures -10°C~55°C.

Band :	GSM 1900	Channel :	661
Limit (ppm) :	2.5		

Temperature (°C)	Freq. Dev. (Hz)	Deviation (ppm)	Result
-30	N/A	N/A	PASS
-20	N/A	N/A	
-10	45	0.02	
0	49	0.03	
10	50	0.03	
20	-26	-0.01	
30	-27	-0.01	
40	-58	-0.03	
50	-26	-0.01	

Note:

1. The EUT stops transmitting at temperatures -20°C and -30°C.
2. The manufacturer declared that the EUT could work properly between temperatures -10°C~55°C.

3.7.7 Test Result of Voltage Variation

Band & Channel	Voltage (Volt)	Freq. Dev. (Hz)	Deviation (ppm)	Limit (ppm)	Result
GSM 850 CH189	3.8	12	0.01	2.5	PASS
	BEP	16	0.02		
	4.2	15	0.02		
GSM 1900 CH661	3.8	21	0.01		
	BEP	26	0.01		
	4.2	16	0.01		

Note:

1. Normal Voltage = 3.8V.
2. Battery End Point (BEP) = 3.4 V.



4 List of Measuring Equipment

Instrument	Manufacturer	Model No.	Serial No.	Characteristics	Calibration Date	Due Date	Remark
Spectrum Analyzer	R&S	FSP40	100319	9kHz~40GHz	Jan. 07, 2011	Jan. 06, 2012	Conducted (TH01-KS)
Power Meter	Agilent	E4416A	MY45101555	N/A	Aug. 24, 2010	Aug. 23, 2011	Conducted (TH01-KS)
Power Sensor	Agilent	E9327A	MY44421198	N/A	Aug. 24, 2010	Aug. 23, 2011	Conducted (TH01-KS)
Thermal Chamber	Ten Billion	TTC-B3S	TBN-960502	N/A	Dec. 28, 2010	Dec. 27, 2011	Conducted (TH01-KS)
DC Power Supply	TOPWARD	3306D	N/A	N/A	N/A	N/A	Conducted (TH01-KS)
EMI Test Receiver	R&S	ESCI	100534	9kHz~3GHz	Nov. 16, 2010	Nov. 15, 2011	Radiation (03CH01-KS)
Spectrum Analyzer	R&S	FSP40	100319	9kHz~40GHz	Jan. 07, 2011	Jan. 06, 2012	Radiation (03CH01-KS)
Bilog Antenna	SCHAFFNER	CBL6112D	23182	25MHz~2GHz	Dec. 07, 2010	Dec. 06, 2011	Radiation (03CH01-KS)
Double Ridge Horn Antenna	EMCO	3117	00075959	1GHz~18GHz	Jan. 07, 2011	Jan. 06, 2012	Radiation (03CH01-KS)
Amplifier	Wireless	FPA-6592G	060004	30MHz~2GHz	Dec. 09, 2010	Dec. 08, 2011	Radiation (03CH01-KS)
Amplifier	Agilent	8449B	3008A02370	1GHz~26.5GHz	Jan. 07, 2011	Jan. 06, 2012	Radiation (03CH01-KS)
Actice hore antenna	com-power	AHA-118	701023	1G-18GHz	Nov. 09, 2010	Nov. 08, 2011	Radiation (03CH01-KS)
Signal Generator	R&S	SMR40	100455	10MHz~40GHz	Jan. 06, 2011	Jan. 05, 2012	Radiation (03CH01-KS)
SHF-EHF Horn	Schwarzbeck	BBHA 9170	BBHA170249	15-40GHz	Oct. 15, 2010	Oct. 14, 2011	Radiation (03CH01-KS)
Loop Antenna	R&S	HFH2-Z2	860004/001	9 kHz~30 MHz	Jul. 29, 2010	Jul. 28, 2011	Radiation (03CH01-KS)
System Simulator	R&S	CMU200	837587/066	Full-Band	Jan. 07, 2011	Jan. 06, 2012	Radiation (03CH01-KS)

5 Uncertainty of Evaluation

Uncertainty of Radiated Emission Measurement (30 MHz ~ 1000 MHz)

Contribution	Uncertainty of X_i		$u(X_i)$
	dB	Probability Distribution	
Receiver Reading	0.41	Normal (k=2)	0.21
Antenna Factor Calibration	0.83	Normal (k=2)	0.42
Cable Loss Calibration	0.25	Normal (k=2)	0.13
Pre-Amplifier Gain Calibration	0.27	Normal (k=2)	0.14
RCV/SPA Specification	2.50	Rectangular	0.72
Antenna Factor Interpolation for Frequency	1.00	Rectangular	0.29
Site Imperfection	1.43	Rectangular	0.83
Mismatch	+0.39 / -0.41	U-Shape	0.28
Combined Standard Uncertainty $U_c(y)$	1.27		
Measuring Uncertainty for a Level of Confidence of 95% ($U = 2U_c(y)$)	2.54		

Uncertainty of Radiated Emission Measurement (1 GHz ~ 40 GHz)

Contribution	Uncertainty of X_i		$u(X_i)$	C_i	$C_i * u(X_i)$
	dB	Probability Distribution			
Receiver Reading	± 0.10	Normal (k=2)	0.10	1	0.10
Antenna Factor Calibration	± 1.70	Normal (k=2)	0.85	1	0.85
Cable Loss Calibration	± 0.50	Normal (k=2)	0.25	1	0.25
Receiver Correction	± 2.00	Rectangular	1.15	1	1.15
Antenna Factor Directional	± 1.50	Rectangular	0.87	1	0.87
Site Imperfection	± 2.80	Triangular	1.14	1	1.14
Mismatch Receiver VSWR $\Gamma_1 = 0.197$ Antenna VSWR $\Gamma_2 = 0.194$ Uncertainty = $20\text{Log}(1-\Gamma_1*\Gamma_2)$	+0.34 / -0.35	U-Shape	0.244	1	0.244
Combined Standard Uncertainty $U_c(y)$	2.36				
Measuring Uncertainty for a Level of Confidence of 95% ($U = 2U_c(y)$)	4.72				



Appendix A. Photographs of EUT

Please refer to Sporton report number EP121531 as below.