



**Calibration Laboratory of  
Schmid & Partner  
Engineering AG**  
Zeughausstrasse 43, 8004 Zurich, Switzerland



**S** Schweizerischer Kalibrierdienst  
**C** Service suisse d'étalonnage  
**S** Servizio svizzero di taratura  
**S** Swiss Calibration Service

Accredited by the Swiss Accreditation Service (SAS)  
The Swiss Accreditation Service is one of the signatories to the EA  
Multilateral Agreement for the recognition of calibration certificates

Accreditation No.: **SCS 108**

Client **Sporton (Auden)**

Certificate No: **CD835V3-1045\_Sep09**

**CALIBRATION CERTIFICATE**

Object **CD835V3 - SN: 1045**

Calibration procedure(s) **QA CAL-20.v4  
Calibration procedure for dipoles in air**

Calibration date: **September 17, 2009**

Condition of the calibrated item **In Tolerance**

This calibration certificate documents the traceability to national standards, which realize the physical units of measurements (SI).  
All calibrations have been conducted in the closed laboratory facility: environment temperature (22 ± 3)°C and humidity < 70%.

Calibration Equipment used (M&TE critical for calibration)

Primary Standards	ID #	Cal Date (Certificate No.)	Scheduled Calibration
Power meter EPM-442A	GB37480704	08-Oct-08 (No. 217-00898)	Oct-09
Power sensor HP 8481A	US37292783	08-Oct-08 (No. 217-00898)	Oct-09
Probe ER3DV6	SN: 2336	22-Dec-08 (No. ER3-2336_Dec08)	Dec-09
Probe H3DV6	SN: 6065	22-Dec-08 (No. H3-6065_-Dec08)	Dec-09
DAE4	SN: 781	20-Feb-09 (No. DAE4-781_Feb09)	Feb-10
Secondary Standards	ID #	Check Date (in house)	Scheduled Check
Power meter R&S NRP	SN: 101748	23-Sep-08 (in house check Dec-08)	In house check: Dec-10
Power sensor R&S NRP-Z91	SN: 100711	25-Aug-08 (in house check Dec-08)	In house check: Dec-10
Power sensor R&S NRP-Z91	SN: 100712	25-Aug-08 (in house check Dec-08)	In house check: Dec-10
Network Analyzer HP 8753E	US37390585	18-Oct-01 (in house check Oct-08)	In house check: Oct-09
RF generator E4433B	MY 41310391	03-Nov-04 (in house check Oct-07)	In house check: Oct-09

Calibrated by:	Name <b>Claudio Leubler</b>	Function <b>Laboratory Technician</b>	Signature 
Approved by:	Name <b>Katja Pokovic</b>	Function <b>Technical Manager</b>	Signature 

Issued: September 17, 2009

This calibration certificate shall not be reproduced except in full without written approval of the laboratory.



**Calibration Laboratory of**  
Schmid & Partner  
Engineering AG  
Zeughausstrasse 43, 8004 Zurich, Switzerland



**S** Schweizerischer Kalibrierdienst  
**C** Service suisse d'étalonnage  
**S** Servizio svizzero di taratura  
**S** Swiss Calibration Service

Accredited by the Swiss Accreditation Service (SAS)  
The Swiss Accreditation Service is one of the signatories to the EA  
Multilateral Agreement for the recognition of calibration certificates

Accreditation No.: **SCS 108**

## References

- [1] ANSI-C63.19-2006  
American National Standard for Methods of Measurement of Compatibility between Wireless Communications Devices and Hearing Aids.
- [2] ANSI-C63.19-2007  
American National Standard for Methods of Measurement of Compatibility between Wireless Communications Devices and Hearing Aids.

## Methods Applied and Interpretation of Parameters:

- **Coordinate System:** y-axis is in the direction of the dipole arms. z-axis is from the basis of the antenna (mounted on the table) towards its feed point between the two dipole arms. x-axis is normal to the other axes. In coincidence with the standards [1, 2], the measurement planes (probe sensor center) are selected to be at a distance of 10 mm above the top edge of the dipole arms.
- **Measurement Conditions:** Further details are available from the hardcopies at the end of the certificate. All figures stated in the certificate are valid at the frequency indicated. The forward power to the dipole connector is set with a calibrated power meter connected and monitored with an auxiliary power meter connected to a directional coupler. While the dipole under test is connected, the forward power is adjusted to the same level.
- **Antenna Positioning:** The dipole is mounted on a HAC Test Arch phantom using the matching dipole positioner with the arms horizontal and the feeding cable coming from the floor. The measurements are performed in a shielded room with absorbers around the setup to reduce the reflections. It is verified before the mounting of the dipole under the Test Arch phantom, that its arms are perfectly in a line. It is installed on the HAC dipole positioner with its arms parallel below the dielectric reference wire and able to move elastically in vertical direction without changing its relative position to the top center of the Test Arch phantom. The vertical distance to the probe is adjusted after dipole mounting with a DASY4 Surface Check job. Before the measurement, the distance between phantom surface and probe tip is verified. The proper measurement distance is selected by choosing the matching section of the HAC Test Arch phantom with the proper device reference point (upper surface of the dipole) and the matching grid reference point (tip of the probe) considering the probe sensor offset. The vertical distance to the probe is essential for the accuracy.
- **Feed Point Impedance and Return Loss:** These parameters are measured using a HP 8753E Vector Network Analyzer. The impedance is specified at the SMA connector of the dipole. The influence of reflections was eliminating by applying the averaging function while moving the dipole in the air, at least 70cm away from any obstacles.
- **E-field distribution:** E field is measured in the x-y-plane with an isotropic ER3D-field probe with 100 mW forward power to the antenna feed point. In accordance with [1, 2], the scan area is 20mm wide, its length exceeds the dipole arm length (180 or 90mm). The sensor center is 10 mm (in z) above the top of the dipole arms. Two 3D maxima are available near the end of the dipole arms. Assuming the dipole arms are perfectly in one line, the average of these two maxima (in subgrid 2 and subgrid 8) is determined to compensate for any non-parallelity to the measurement plane as well as the sensor displacement. The E-field value stated as calibration value represents the maximum of the interpolated 3D-E-field, 10mm above the dipole surface.
- **H-field distribution:** H-field is measured with an isotropic H-field probe with 100mW forward power to the antenna feed point, in the x-y-plane. The scan area and sensor distance is equivalent to the E-field scan. The maximum of the field is available at the center (subgrid 5) above the feed point. The H-field value stated as calibration value represents the maximum of the interpolated H-field, 10mm above the dipole surface at the feed point.



1 Measurement Conditions

DASY system configuration, as far as not given on page 1.

DASY Version	DASY5	V5.0 B127
DASY PP Version	SEMCAD X	V13.4 B125
Phantom	HAC Test Arch	SD HAC P01 BA, #1070
Distance Dipole Top - Probe Center	10 mm	
Scan resolution	dx, dy = 5 mm	area = 20 x 180 mm
Frequency	<b>835 MHz ± 1 MHz</b>	
Forward power at dipole connector	20.0 dBm = 100mW	
Input power drift	< 0.05 dB	

2 Maximum Field values

H-field 10 mm above dipole surface	condition	interpolated maximum
Maximum measured	100 mW forward power	<b>0.457 A/m</b>

Uncertainty for H-field measurement: 8.2% (k=2)

E-field 10 mm above dipole surface	condition	Interpolated maximum
Maximum measured above high end-	100 mW forward power	170.6 V/m
Maximum measured above low end	100 mW forward power	169.8 V/m
Averaged maximum above arm	100 mW forward power	<b>170.2 V/m</b>

Uncertainty for E-field measurement: 12.8% (k=2)

3 Appendix

3.1 Antenna Parameters

Frequency	Return Loss	Impedance
800 MHz	15.7 dB	( 44.9 – j14.9 ) Ohm
<b>835 MHz</b>	<b>40.5 dB</b>	<b>( 49.2 - j0.5 ) Ohm</b>
900 MHz	17.4 dB	( 53.0 – j13.7 ) Ohm
950 MHz	20.2 dB	( 47.5 + j9.2 ) Ohm
960 MHz	14.8 dB	( 53.9 + j18.8 ) Ohm

3.2 Antenna Design and Handling

The calibration dipole has a symmetric geometry with a built-in two stub matching network, which leads to the enhanced bandwidth.

The dipole is built of standard semirigid coaxial cable. The internal matching line is open ended. The antenna is therefore open for DC signals.

Do not apply force to dipole arms, as they are liable to bend. The soldered connections near the feedpoint may be damaged. After excessive mechanical stress or overheating, check the impedance characteristics to ensure that the internal matching network is not affected.

After long term use with 40W radiated power, only a slight warming of the dipole near the feedpoint can be measured.





3.3 Measurement Sheets

3.3.1 Return Loss and Smith Chart

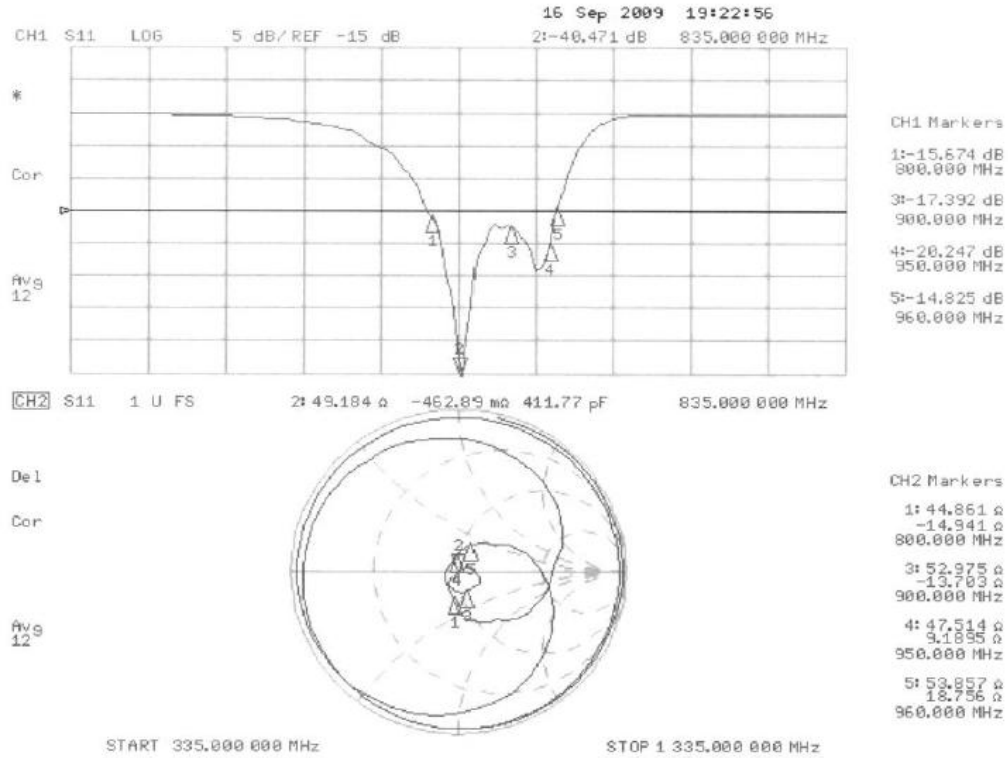

**3.3.2 DAS Y4 H-field Result**

Date/Time: 16.09.2009 10:26:07

Test Laboratory: SPEAG Lab2

H\_CD835\_1045\_090916.da5

**DUT: HAC-Dipole 835 MHz; Type: D835V3; Serial: 1045**

Communication System: CW; Frequency: 835 MHz; Duty Cycle: 1:1

Medium parameters used:  $\sigma = 0$  mho/m,  $\epsilon_r = 1$ ;  $\rho = 1$  kg/m<sup>3</sup>

Phantom section: RF Section

Measurement Standard: DAS Y5 (IEEE/IEC)

DAS Y5 Configuration:

- Probe: H3DV6 - SN6065; ; Calibrated: 22.12.2008
- Sensor-Surface: (Fix Surface)
- Electronics: DAE4 Sn781; Calibrated: 20.02.2009
- Phantom: HAC Test Arch with AMCC; Type: SD HAC P01 BA; Serial: 1070
- Measurement SW: DAS Y5, V5.0 Build 127; SEMCAD X Version 13.4 Build 125

**H Scan - measurement distance from the probe sensor center to CD835 Dipole = 10mm/Hearing Aid Compatibility Test (41x361x1):**

Measurement grid: dx=5mm, dy=5mm

Maximum value of peak Total field = 0.457 A/m

Probe Modulation Factor = 1

Device Reference Point: 0, 0, -6.3 mm

Reference Value = 0.487 A/m; Power Drift = 0.00195 dB

**Hearing Aid Near-Field Category: M4 (AWF 0 dB)**

Peak H-field in A/m

Grid 1 <b>0.384</b> <b>M4</b>	Grid 2 <b>0.410</b> <b>M4</b>	Grid 3 <b>0.385</b> <b>M4</b>
Grid 4 <b>0.431</b> <b>M4</b>	Grid 5 <b>0.457</b> <b>M4</b>	Grid 6 <b>0.429</b> <b>M4</b>
Grid 7 <b>0.383</b> <b>M4</b>	Grid 8 <b>0.401</b> <b>M4</b>	Grid 9 <b>0.369</b> <b>M4</b>

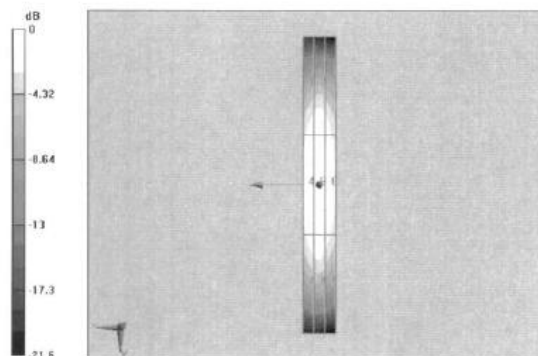

0 dB = 0.457A/m

**3.3.3 DASY4 E-field Result**

Date/Time: 17.09.2009 09:59:19

Test Laboratory: SPEAG Lab2

E\_CD835\_1045\_090917.da5

**DUT: HAC-Dipole 835 MHz; Type: D835V3; Serial: 1045**

Communication System: CW; Frequency: 835 MHz; Duty Cycle: 1:1

Medium parameters used:  $\sigma = 0$  mho/m,  $\epsilon_r = 1$ ;  $\rho = 1000$  kg/m<sup>3</sup>

Phantom section: RF Section

Measurement Standard: DASY5 (IEEE/IEC)

DASY5 Configuration:

- Probe: ER3DV6 - SN2336; ConvF(1, 1, 1); Calibrated: 22.12.2008
- Sensor-Surface: (Fix Surface)
- Electronics: DAE4 Sn781; Calibrated: 20.02.2009
- Phantom: HAC Test Arch with AMCC; Type: SD HAC P01 BA; Serial: 1070
- Measurement SW: DASY5, V5.0 Build 127; SEMCAD X Version 13.4 Build 125

**E Scan - measurement distance from the probe sensor center to CD835 Dipole = 10mm/Hearing Aid Compatibility Test (41x361x1):**

Measurement grid: dx=5mm, dy=5mm

Maximum value of peak Total field = 170.6 V/m

Probe Modulation Factor = 1

Device Reference Point: 0, 0, -6.3 mm

Reference Value = 109.7 V/m; Power Drift = -0.035 dB

**Hearing Aid Near-Field Category: M4 (AWF 0 dB)**

Peak E-field in V/m

Grid 1 <b>164.9</b> <b>M4</b>	Grid 2 <b>170.6</b> <b>M4</b>	Grid 3 <b>164.4</b> <b>M4</b>
Grid 4 <b>87.7</b> <b>M4</b>	Grid 5 <b>89.9</b> <b>M4</b>	Grid 6 <b>86.1</b> <b>M4</b>
Grid 7 <b>165.1</b> <b>M4</b>	Grid 8 <b>169.8</b> <b>M4</b>	Grid 9 <b>159.4</b> <b>M4</b>

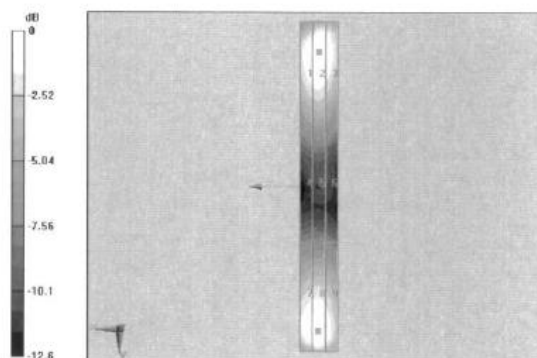

0 dB = 170.6V/m



# Calibration Certificate of DAS Y

**Calibration Laboratory of**  
 Schmid & Partner  
 Engineering AG  
 Zeughausstrasse 43, 8004 Zurich, Switzerland



**S** Schweizerischer Kalibrierdienst  
**C** Service suisse d'étalonnage  
**S** Servizio svizzero di taratura  
**S** Swiss Calibration Service

Accredited by the Swiss Accreditation Service (SAS)  
 The Swiss Accreditation Service is one of the signatories to the EA  
 Multilateral Agreement for the recognition of calibration certificates

Accreditation No.: **SCS 108**

Client **Sporton (Auden)**

Certificate No: **CD1880V3-1038\_Sep09**

## CALIBRATION CERTIFICATE

Object: **CD1880V3 - SN: 1038**

Calibration procedure(s): **QA CAL-20.v4  
Calibration procedure for dipoles in air**

Calibration date: **September 17, 2009**

Condition of the calibrated item: **In Tolerance**

This calibration certificate documents the traceability to national standards, which realize the physical units of measurements (SI).  
 All calibrations have been conducted in the closed laboratory facility: environment temperature (22 ± 3)°C and humidity < 70%.

Calibration Equipment used (M&TE critical for calibration)

Primary Standards	ID #	Cal Date (Certificate No.)	Scheduled Calibration
Power meter EPM-442A	GB37480704	08-Oct-08 (No. 217-00898)	Oct-09
Power sensor HP 8481A	US37292783	08-Oct-08 (No. 217-00898)	Oct-09
Probe ER3DV6	SN: 2336	22-Dec-08 (No. ER3-2336_Dec08)	Dec-09
Probe H3DV6	SN: 6065	22-Dec-08 (No. H3-6065_-Dec08)	Dec-09
DAE4	SN 781	20-Feb-09 (No. DAE4-781_Feb09)	Feb-10

Secondary Standards	ID #	Check Date (in house)	Scheduled Check
Power meter R&S NRP	SN: 101748	23-Sep-08 (in house check Dec-08)	In house check: Dec-10
Power sensor R&S NRP-Z91	SN: 100711	25-Aug-08 (in house check Dec-08)	In house check: Dec-10
Power sensor R&S NRP-Z91	SN: 100712	25-Aug-08 (in house check Dec-08)	In house check: Dec-10
Network Analyzer HP 8753E	US37390585	18-Oct-01 (in house check Oct-08)	In house check: Oct-09
RF generator E4433B	MY 41310391	22-Nov-04 (in house check Oct-07)	In house check: Oct-09

Calibrated by: **Claudio Leubler** (Name) / **Laboratory Technician** (Function) / *[Signature]* (Signature)

Approved by: **Katja Pokovic** (Name) / **Technical Manager** (Function) / *[Signature]* (Signature)

Issued: September 17, 2009

This calibration certificate shall not be reproduced except in full without written approval of the laboratory.



**Calibration Laboratory of**  
Schmid & Partner  
Engineering AG  
Zeughausstrasse 43, 8004 Zurich, Switzerland



**S** Schweizerischer Kalibrierdienst  
**C** Service suisse d'étalonnage  
**S** Servizio svizzero di taratura  
**S** Swiss Calibration Service

Accredited by the Swiss Accreditation Service (SAS)  
The Swiss Accreditation Service is one of the signatories to the EA  
Multilateral Agreement for the recognition of calibration certificates

Accreditation No.: **SCS 108**

## References

- [1] ANSI-C63.19-2006  
American National Standard for Methods of Measurement of Compatibility between Wireless Communications Devices and Hearing Aids.
- [2] ANSI-C63.19-2007  
American National Standard for Methods of Measurement of Compatibility between Wireless Communications Devices and Hearing Aids.

## Methods Applied and Interpretation of Parameters:

- *Coordinate System:* y-axis is in the direction of the dipole arms. z-axis is from the basis of the antenna (mounted on the table) towards its feed point between the two dipole arms. x-axis is normal to the other axes. In coincidence with the standards [1, 2], the measurement planes (probe sensor center) are selected to be at a distance of 10 mm above the top edge of the dipole arms.
- *Measurement Conditions:* Further details are available from the hardcopies at the end of the certificate. All figures stated in the certificate are valid at the frequency indicated. The forward power to the dipole connector is set with a calibrated power meter connected and monitored with an auxiliary power meter connected to a directional coupler. While the dipole under test is connected, the forward power is adjusted to the same level.
- *Antenna Positioning:* The dipole is mounted on a HAC Test Arch phantom using the matching dipole positioner with the arms horizontal and the feeding cable coming from the floor. The measurements are performed in a shielded room with absorbers around the setup to reduce the reflections. It is verified before the mounting of the dipole under the Test Arch phantom, that its arms are perfectly in a line. It is installed on the HAC dipole positioner with its arms parallel below the dielectric reference wire and able to move elastically in vertical direction without changing its relative position to the top center of the Test Arch phantom. The vertical distance to the probe is adjusted after dipole mounting with a DASY4 Surface Check job. Before the measurement, the distance between phantom surface and probe tip is verified. The proper measurement distance is selected by choosing the matching section of the HAC Test Arch phantom with the proper device reference point (upper surface of the dipole) and the matching grid reference point (tip of the probe) considering the probe sensor offset. The vertical distance to the probe is essential for the accuracy.
- *Feed Point Impedance and Return Loss:* These parameters are measured using a HP 8753E Vector Network Analyzer. The impedance is specified at the SMA connector of the dipole. The influence of reflections was eliminated by applying the averaging function while moving the dipole in the air, at least 70cm away from any obstacles.
- *E-field distribution:* E field is measured in the x-y-plane with an isotropic ER3D-field probe with 100 mW forward power to the antenna feed point. In accordance with [1, 2], the scan area is 20mm wide, its length exceeds the dipole arm length (180 or 90mm). The sensor center is 10 mm (in z) above the top of the dipole arms. Two 3D maxima are available near the end of the dipole arms. Assuming the dipole arms are perfectly in one line, the average of these two maxima (in subgrid 2 and subgrid 8) is determined to compensate for any non-parallelity to the measurement plane as well as the sensor displacement. The E-field value stated as calibration value represents the maximum of the interpolated 3D-E-field, 10mm above the dipole surface.
- *H-field distribution:* H-field is measured with an isotropic H-field probe with 100mW forward power to the antenna feed point, in the x-y-plane. The scan area and sensor distance is equivalent to the E-field scan. The maximum of the field is available at the center (subgrid 5) above the feed point. The H-field value stated as calibration value represents the maximum of the interpolated H-field, 10mm above the dipole surface at the feed point.





**1. Measurement Conditions**

DASY system configuration, as far as not given on page 1.

DASY Version	DASY5	V5.0 B127
DASY PP Version	SEMCAD X	V13.4 B125
Phantom	HAC Test Arch	SD HAC P01 BA, #1070
Distance Dipole Top - Probe Center	10 mm	
Scan resolution	dx, dy = 5 mm	area = 20 x 90 mm
Frequency	<b>1880 MHz ± 1 MHz</b>	
Forward power at dipole connector	20.0 dBm = 100mW	
Input power drift	< 0.05 dB	

**2. Maximum Field values**

H-field 10 mm above dipole surface	condition	Interpolated maximum
Maximum measured	100 mW forward power	<b>0.466 A/m</b>

Uncertainty for H-field measurement: 8.2% (k=2)

E-field 10 mm above dipole surface	condition	Interpolated maximum
Maximum measured above high end	100 mW forward power	138.2 V/m
Maximum measured above low end	100 mW forward power	135.3 V/m
Averaged maximum above arm	100 mW forward power	<b>136.8 V/m</b>

Uncertainty for E-field measurement: 12.8% (k=2)

**3. Appendix**

**3.1 Antenna Parameters**

Frequency	Return Loss	Impedance
1710 MHz	18.6 dB	( 48.6 + j11.6 ) Ohm
<b>1880 MHz</b>	<b>21.3 dB</b>	<b>( 52.9 + j8.4 ) Ohm</b>
1900 MHz	22.1 dB	( 55.5 + j6.3 ) Ohm
1950 MHz	28.1 dB	( 52.8 - j2.9 ) Ohm
2000 MHz	18.7 dB	( 39.6 - j1.0 ) Ohm

**3.2 Antenna Design and Handling**

The calibration dipole has a symmetric geometry with a built-in two stub matching network, which leads to the enhanced bandwidth.

The dipole is built of standard semirigid coaxial cable. The internal matching line is open ended. The antenna is therefore open for DC signals.

Do not apply force to dipole arms, as they are liable to bend. The soldered connections near the feedpoint may be damaged. After excessive mechanical stress or overheating, check the impedance characteristics to ensure that the internal matching network is not affected.

After long term use with 40W radiated power, only a slight warming of the dipole near the feedpoint can be measured.



3.3 Measurement Sheets

3.3.1 Return Loss and Smith Chart

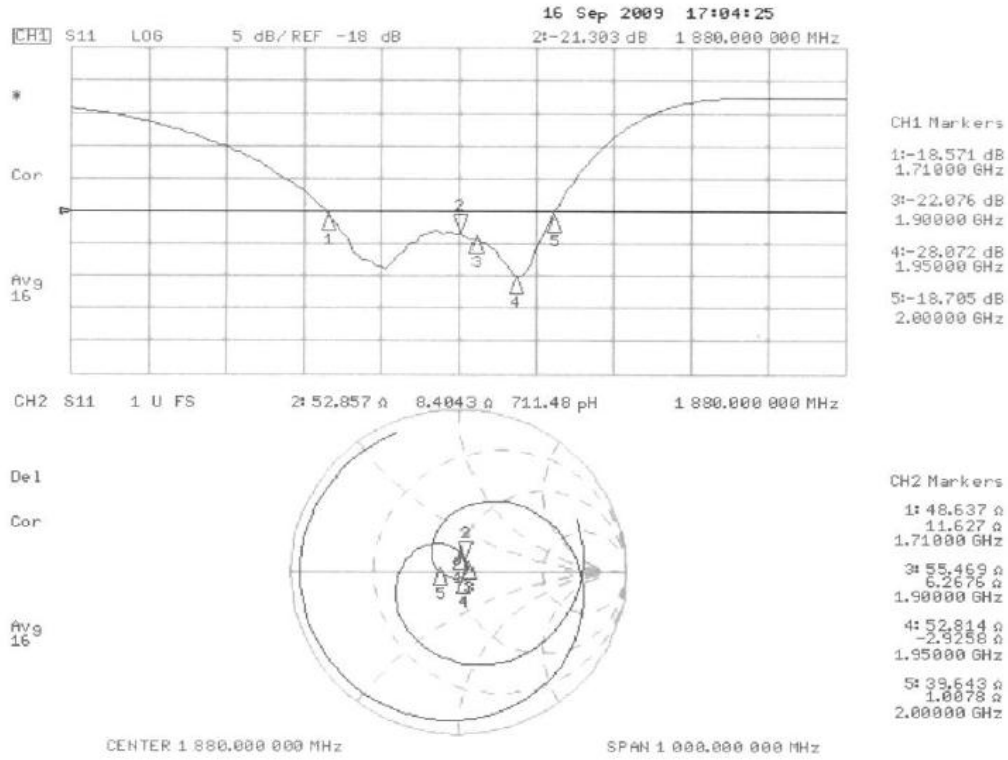

**3.3.2 DASY4 H-Field Result**

Date/Time: 16.09.2009 14:27:59

Test Laboratory: SPEAG Lab2

**H\_CD1880\_1038\_090916.da5**

**DUT: HAC Dipole 1880 MHz; Type: CD1880V3; Serial: 1038**

Communication System: CW; Frequency: 1880 MHz; Duty Cycle: 1:1

Medium parameters used:  $\sigma = 0$  mho/m,  $\epsilon_r = 1$ ;  $\rho = 1$  kg/m<sup>3</sup>

Phantom section: RF Section

Measurement Standard: DASY5 (IEEE/IEC)

DASY5 Configuration:

- Probe: H3DV6 - SN6065; ; Calibrated: 22.12.2008
- Sensor-Surface: (Fix Surface)
- Electronics: DAE4 Sn781; Calibrated: 20.02.2009
- Phantom: HAC Test Arch with AMCC; Type: SD HAC P01 BA; Serial: 1070
- Measurement SW: DASY5, V5.0 Build 127; SEMCAD X Version 13.4 Build 125

**H Scan - measurement distance from the probe sensor center to CD1880 Dipole = 10mm/Hearing Aid Compatibility Test (41x181x1):**

Measurement grid: dx=5mm, dy=5mm

Maximum value of peak Total field = 0.466 A/m

Probe Modulation Factor = 1

Device Reference Point: 0, 0, -6.3 mm

Reference Value = 0.493 A/m; Power Drift = -0.010 dB

**Hearing Aid Near-Field Category: M2 (AWF 0 dB)**

Peak H-field in A/m

Grid 1 <b>0.397</b> M2	Grid 2 <b>0.420</b> M2	Grid 3 <b>0.403</b> M2
Grid 4 <b>0.442</b> M2	Grid 5 <b>0.466</b> M2	Grid 6 <b>0.445</b> M2
Grid 7 <b>0.407</b> M2	Grid 8 <b>0.432</b> M2	Grid 9 <b>0.410</b> M2

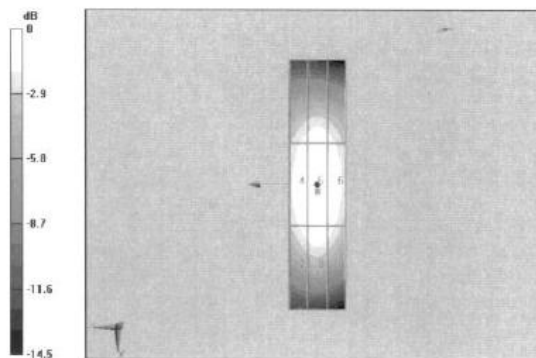

0 dB = 0.466A/m





**3.3.3 DASY4 E-Field Result**

Date/Time: 17.09.2009 15:13:12

Test Laboratory: SPEAG Lab2

**E\_CD1880\_1038\_090917.da5**

**DUT: HAC Dipole 1880 MHz; Type: CD1880V3; Serial: 1038**

Communication System: CW; Frequency: 1880 MHz; Duty Cycle: 1:1

Medium parameters used:  $\sigma = 0$  mho/m,  $\epsilon_r = 1$ ;  $\rho = 1000$  kg/m<sup>3</sup>

Phantom section: RF Section

Measurement Standard: DASY5 (IEEE/IEC)

DASY5 Configuration:

- Probe: ER3DV6 - SN2336; ConvF(1, 1, 1); Calibrated: 22.12.2008
- Sensor-Surface: (Fix Surface)
- Electronics: DAE4 Sn781; Calibrated: 20.02.2009
- Phantom: HAC Test Arch with AMCC; Type: SD HAC P01 BA; Serial: 1070
- Measurement SW: DASY5, V5.0 Build 127; SEMCAD X Version 13.4 Build 125

**E Scan - measurement distance from the probe sensor center to CD1880 Dipole = 10mm/Hearing Aid Compatibility Test (41x181x1):**

Measurement grid: dx=5mm, dy=5mm

Maximum value of peak Total field = 138.2 V/m

Probe Modulation Factor = 1

Device Reference Point: 0, 0, -6.3 mm

Reference Value = 155.9 V/m; Power Drift = -0.00724 dB

**Hearing Aid Near-Field Category: M2 (AWF 0 dB)**

Peak E-field in V/m

Grid 1 <b>130.2</b> <b>M2</b>	Grid 2 <b>135.3</b> <b>M2</b>	Grid 3 <b>132.4</b> <b>M2</b>
Grid 4 <b>89</b> <b>M3</b>	Grid 5 <b>91.6</b> <b>M3</b>	Grid 6 <b>88.1</b> <b>M3</b>
Grid 7 <b>132.8</b> <b>M2</b>	Grid 8 <b>138.2</b> <b>M2</b>	Grid 9 <b>132.4</b> <b>M2</b>

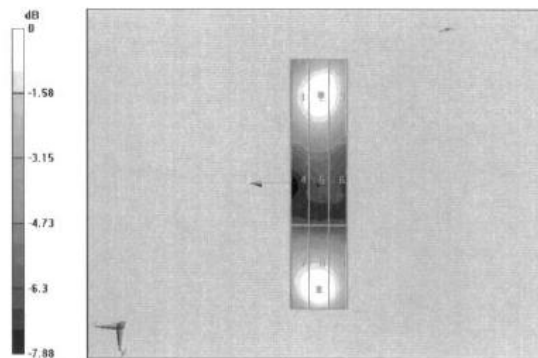

0 dB = 138.2V/m



Calibration Laboratory of Schmid & Partner Engineering AG, Zeughausstrasse 43, 8004 Zurich, Switzerland



S Schweizerischer Kalibrierdienst, S Service suisse d'étalonnage, S Servizio svizzero di taratura, S Swiss Calibration Service

Accredited by the Swiss Accreditation Service (SAS). The Swiss Accreditation Service is one of the signatories to the EA Multilateral Agreement for the recognition of calibration certificates

Accreditation No.: SCS 108

Client Sporton (Auden)

Certificate No: DAE4-778\_Oct10

CALIBRATION CERTIFICATE

Object: DAE4 - SD 000 D04 BJ - SN: 778
Calibration procedure(s): QA CAL-06.v22 Calibration procedure for the data acquisition electronics (DAE)
Calibration date: October 22, 2010

This calibration certificate documents the traceability to national standards, which realize the physical units of measurements (SI). The measurements and the uncertainties with confidence probability are given on the following pages and are part of the certificate.

All calibrations have been conducted in the closed laboratory facility: environment temperature (22 ± 3)°C and humidity < 70%.

Calibration Equipment used (M&TE critical for calibration)

Table with 4 columns: Standards, ID #, Date, and Check/Calibration status. Includes Primary Standards (Keithley Multimeter) and Secondary Standards (Calibrator Box).

Calibrated by: Eric Hainfeld, Technician
Approved by: Fin Bornholt, R&D Director

Issued: October 22, 2010

This calibration certificate shall not be reproduced except in full without written approval of the laboratory.

**Calibration Laboratory of**  
Schmid & Partner  
Engineering AG  
Zeughausstrasse 43, 8004 Zurich, Switzerland



**S** Schweizerischer Kalibrierdienst  
**C** Service suisse d'étalonnage  
**S** Servizio svizzero di taratura  
**S** Swiss Calibration Service

Accredited by the Swiss Accreditation Service (SAS)  
The Swiss Accreditation Service is one of the signatories to the EA  
Multilateral Agreement for the recognition of calibration certificates

Accreditation No.: **SCS 108**

## Glossary

**DAE** data acquisition electronics  
**Connector angle** information used in DAS Y system to align probe sensor X to the robot coordinate system.

## Methods Applied and Interpretation of Parameters

- **DC Voltage Measurement:** Calibration Factor assessed for use in DAS Y system by comparison with a calibrated instrument traceable to national standards. The figure given corresponds to the full scale range of the voltmeter in the respective range.
- **Connector angle:** The angle of the connector is assessed measuring the angle mechanically by a tool inserted. Uncertainty is not required.
- The following parameters as documented in the Appendix contain technical information as a result from the performance test and require no uncertainty.
  - **DC Voltage Measurement Linearity:** Verification of the Linearity at +10% and -10% of the nominal calibration voltage. Influence of offset voltage is included in this measurement.
  - **Common mode sensitivity:** Influence of a positive or negative common mode voltage on the differential measurement.
  - **Channel separation:** Influence of a voltage on the neighbor channels not subject to an input voltage.
  - **AD Converter Values with inputs shorted:** Values on the internal AD converter corresponding to zero input voltage
  - **Input Offset Measurement:** Output voltage and statistical results over a large number of zero voltage measurements.
  - **Input Offset Current:** Typical value for information; Maximum channel input offset current, not considering the input resistance.
  - **Input resistance:** Typical value for information: DAE input resistance at the connector, during internal auto-zeroing and during measurement.
  - **Low Battery Alarm Voltage:** Typical value for information. Below this voltage, a battery alarm signal is generated.
  - **Power consumption:** Typical value for information. Supply currents in various operating modes.





**DC Voltage Measurement**

A/D - Converter Resolution nominal

High Range: 1LSB = 6.1µV , full range = -100...+300 mV

Low Range: 1LSB = 61nV , full range = -1.....+3mV

DASY measurement parameters: Auto Zero Time: 3 sec; Measuring time: 3 sec

Calibration Factors	X	Y	Z
High Range	404.679 ± 0.1% (k=2)	403.480 ± 0.1% (k=2)	405.025 ± 0.1% (k=2)
Low Range	3.98633 ± 0.7% (k=2)	3.96375 ± 0.7% (k=2)	3.99940 ± 0.7% (k=2)

**Connector Angle**

Connector Angle to be used in DASY system	64.5 ° ± 1 °
---	--------------



**Appendix**

**1. DC Voltage Linearity**

High Range	Reading ( $\mu\text{V}$ )	Difference ( $\mu\text{V}$ )	Error (%)
Channel X + Input	200004.4	1.89	0.00
Channel X + Input	20001.11	1.41	0.01
Channel X - Input	-19998.36	1.54	-0.01
Channel Y + Input	199996.1	3.42	0.00
Channel Y + Input	19999.75	0.35	0.00
Channel Y - Input	-19999.92	-0.12	0.00
Channel Z + Input	200002.7	1.29	0.00
Channel Z + Input	19996.85	-2.55	-0.01
Channel Z - Input	-20004.31	-4.61	0.02

Low Range	Reading ( $\mu\text{V}$ )	Difference ( $\mu\text{V}$ )	Error (%)
Channel X + Input	2000.0	0.09	0.00
Channel X + Input	200.02	0.02	0.01
Channel X - Input	-198.62	1.48	-0.74
Channel Y + Input	1999.6	-0.58	-0.03
Channel Y + Input	199.13	-0.57	-0.29
Channel Y - Input	-200.71	-0.61	0.31
Channel Z + Input	2000.1	-0.01	-0.00
Channel Z + Input	198.96	-1.14	-0.57
Channel Z - Input	-200.98	-0.98	0.49

**2. Common mode sensitivity**

DASY measurement parameters: Auto Zero Time: 3 sec; Measuring time: 3 sec

	Common mode Input Voltage (mV)	High Range Average Reading ( $\mu\text{V}$ )	Low Range Average Reading ( $\mu\text{V}$ )
Channel X	200	-5.28	-6.07
	- 200	6.79	6.12
Channel Y	200	-1.80	-1.60
	- 200	0.97	0.35
Channel Z	200	-9.76	-9.86
	- 200	7.56	7.61

**3. Channel separation**

DASY measurement parameters: Auto Zero Time: 3 sec; Measuring time: 3 sec

	Input Voltage (mV)	Channel X ( $\mu\text{V}$ )	Channel Y ( $\mu\text{V}$ )	Channel Z ( $\mu\text{V}$ )
Channel X	200	-	1.86	-0.66
Channel Y	200	2.28	-	2.89
Channel Z	200	1.68	-0.15	-



**4. AD-Converter Values with inputs shorted**

DASY measurement parameters: Auto Zero Time: 3 sec; Measuring time: 3 sec

	High Range (LSB)	Low Range (LSB)
Channel X	16056	16950
Channel Y	16153	13741
Channel Z	16441	16086

**5. Input Offset Measurement**

DASY measurement parameters: Auto Zero Time: 3 sec; Measuring time: 3 sec

Input 10MΩ

	Average (μV)	min. Offset (μV)	max. Offset (μV)	Std. Deviation (μV)
Channel X	0.32	-2.35	2.08	0.55
Channel Y	-1.83	-2.96	-0.72	0.47
Channel Z	-1.93	-3.00	-0.90	0.45

**6. Input Offset Current**

Nominal Input circuitry offset current on all channels: <25fA

**7. Input Resistance** (Typical values for information)

	Zeroing (kOhm)	Measuring (MOhm)
Channel X	200	200
Channel Y	200	200
Channel Z	200	200

**8. Low Battery Alarm Voltage** (Typical values for information)

Typical values	Alarm Level (VDC)
Supply (+ Vcc)	+7.9
Supply (- Vcc)	-7.6

**9. Power Consumption** (Typical values for information)

Typical values	Switched off (mA)	Stand by (mA)	Transmitting (mA)
Supply (+ Vcc)	+0.01	+6	+14
Supply (- Vcc)	-0.01	-8	-9





Calibration Laboratory of Schmid & Partner Engineering AG, Zeughausstrasse 43, 8004 Zurich, Switzerland



SCS Schweizerischer Kalibrierdienst, Service suisse d'etalonnage, Servizio svizzero di taratura, Swiss Calibration Service

Accredited by the Swiss Accreditation Service (SAS) The Swiss Accreditation Service is one of the signatories to the EA Multilateral Agreement for the recognition of calibration certificates

Accreditation No.: SCS 108

Client Sporton-TW (Auden)

Certificate No: ER3-2358\_Jan11

CALIBRATION CERTIFICATE

Object: ER3DV6 - SN:2358
Calibration procedure(s): QA CAL-02.v6, QA CAL-25.v3
Calibration date: January 14, 2011
This calibration certificate documents the traceability to national standards, which realize the physical units of measurements (SI).

Table with 4 columns: Primary Standards, ID, Cal Date (Certificate No.), Scheduled Calibration. Lists various power meters, attenuators, and standards with their respective IDs and calibration dates.

Calibrated by: Marcel Fehr, Laboratory Technician
Approved by: Katja Pokovic, Technical Manager
Issued: January 25, 2011
This calibration certificate shall not be reproduced except in full without written approval of the laboratory.

**Calibration Laboratory of  
Schmid & Partner  
Engineering AG**  
Zeughausstrasse 43, 8004 Zurich, Switzerland



**S** Schweizerischer Kalibrierdienst  
**S** Service suisse d'étalonnage  
**C** Servizio svizzero di taratura  
**S** Swiss Calibration Service

Accredited by the Swiss Accreditation Service (SAS)

Accreditation No.: **SCS 108**

The Swiss Accreditation Service is one of the signatories to the EA  
Multilateral Agreement for the recognition of calibration certificates

## Glossary:

NORM <sub>x,y,z</sub>	sensitivity in free space
DCP	diode compression point
CF	crest factor (1/duty_cycle) of the RF signal
A, B, C	modulation dependent linearization parameters
Polarization $\varphi$	$\varphi$ rotation around probe axis
Polarization $\vartheta$	$\vartheta$ rotation around an axis that is in the plane normal to probe axis (at measurement center), i.e., $\vartheta = 0$ is normal to probe axis
Connector Angle	information used in DAS Y system to align probe sensor X to the robot coordinate system

## Calibration is Performed According to the Following Standards:

- IEEE Std 1309-2005, "IEEE Standard for calibration of electromagnetic field sensors and probes, excluding antennas, from 9 kHz to 40 GHz", December 2005.

## Methods Applied and Interpretation of Parameters:

- NORM<sub>x,y,z</sub>**: Assessed for E-field polarization  $\vartheta = 0$  for XY sensors and  $\vartheta = 90$  for Z sensor ( $f \leq 900$  MHz in TEM-cell;  $f > 1800$  MHz: R22 waveguide).
- NORM(f)<sub>x,y,z</sub>** = NORM<sub>x,y,z</sub> \* frequency\_response (see Frequency Response Chart).
- DCP<sub>x,y,z</sub>**: DCP are numerical linearization parameters assessed based on the data of power sweep with CW signal (no uncertainty required). DCP does not depend on frequency nor media.
- A<sub>x,y,z</sub>; B<sub>x,y,z</sub>; C<sub>x,y,z</sub>; VR<sub>x,y,z</sub>**: A, B, C are numerical linearization parameters assessed based on the data of power sweep for specific modulation signal. The parameters do not depend on frequency nor media. VR is the maximum calibration range expressed in RMS voltage across the diode.
- Spherical isotropy (3D deviation from isotropy)**: in a locally homogeneous field realized using an open waveguide setup.
- Sensor Offset**: The sensor offset corresponds to the offset of virtual measurement center from the probe tip (on probe axis). No tolerance required.
- Connector Angle**: The angle is assessed using the information gained by determining the NORM<sub>x</sub> (no uncertainty required).



ER3DV6 – SN:2358

January 14, 2011

# Probe ER3DV6

## SN:2358

Manufactured: July 7, 2005  
Calibrated: January 14, 2011

Calibrated for DASY/EASY Systems  
(Note: non-compatible with DASY2 system!)



ER3DV6- SN:2358

January 14, 2011

## DASY/EASY - Parameters of Probe: ER3DV6 - SN:2358

### Basic Calibration Parameters

	Sensor X	Sensor Y	Sensor Z	Unc (k=2)
Norm ( $\mu\text{V}/(\text{V}/\text{m})^2$ )	1.72	1.56	1.59	$\pm 10.1 \%$
DCP (mV) <sup>b</sup>	98.6	97.8	99.6	

### Modulation Calibration Parameters

UID	Communication System Name	PAR		A dB	B dB	C dB	VR mV	Unc <sup>E</sup> (k=2)
10000	CW	0.00	X	0.00	0.00	1.00	151.8	$\pm 1.6 \%$
			Y	0.00	0.00	1.00	153.3	
			Z	0.00	0.00	1.00	138.4	

The reported uncertainty of measurement is stated as the standard uncertainty of measurement multiplied by the coverage factor  $k=2$ , which for a normal distribution corresponds to a coverage probability of approximately 95%.

<sup>b</sup> Numerical linearization parameter; uncertainty not required.

<sup>E</sup> Uncertainty is determined using the max. deviation from linear response applying rectangular distribution and is expressed for the square of the field value.





ER3DV6- SN:2358

January 14, 2011

### Frequency Response of E-Field (TEM-Cell:ifi110 EXX, Waveguide: R22)

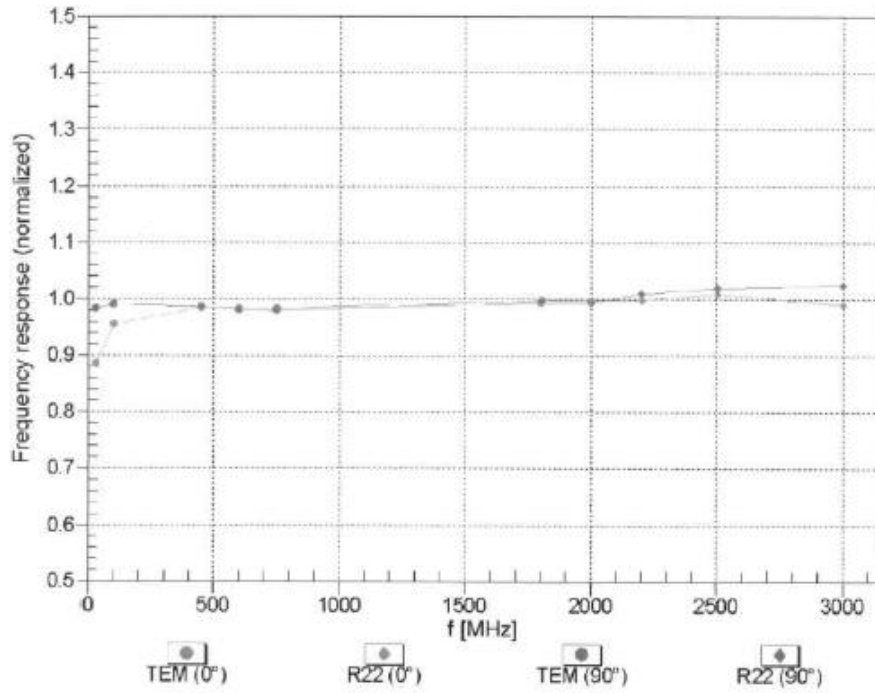

Uncertainty of Frequency Response of E-field:  $\pm 6.3\%$  (k=2)



ER3DV6- SN:2358

January 14, 2011

### Receiving Pattern ( $\phi$ ), $\vartheta = 0^\circ$

f=600 MHz, TEM,  $0^\circ$

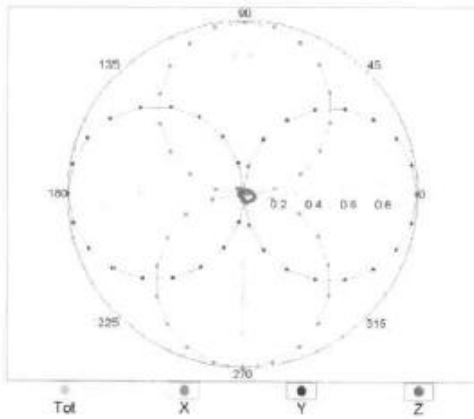

f=2500 MHz, R22,  $0^\circ$

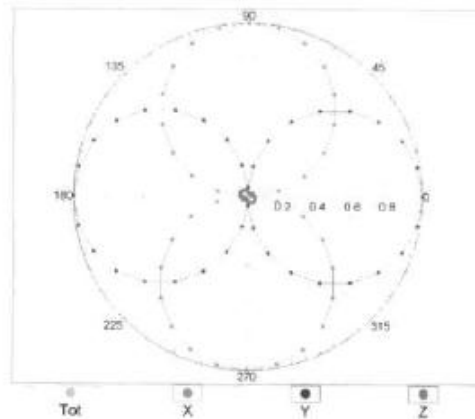

### Receiving Pattern ( $\phi$ ), $\vartheta = 90^\circ$

f=600 MHz, TEM,  $90^\circ$

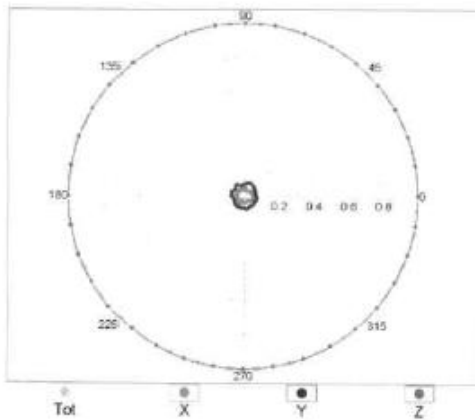

f=2500 MHz, R22,  $90^\circ$

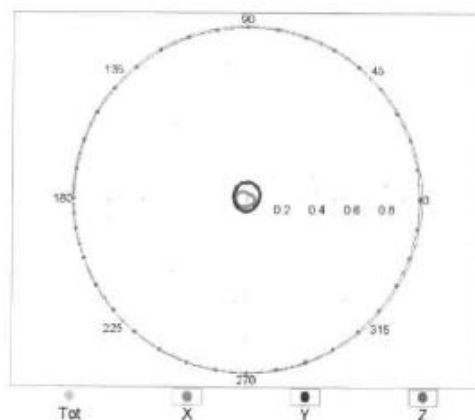



### Receiving Pattern ( $\phi$ ), $\vartheta = 0^\circ$

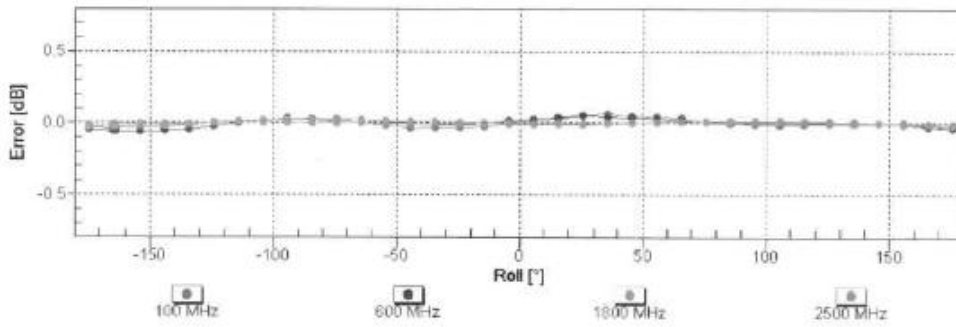

Uncertainty of Axial Isotropy Assessment:  $\pm 0.5\%$  ( $k=2$ )

### Receiving Pattern ( $\phi$ ), $\vartheta = 90^\circ$

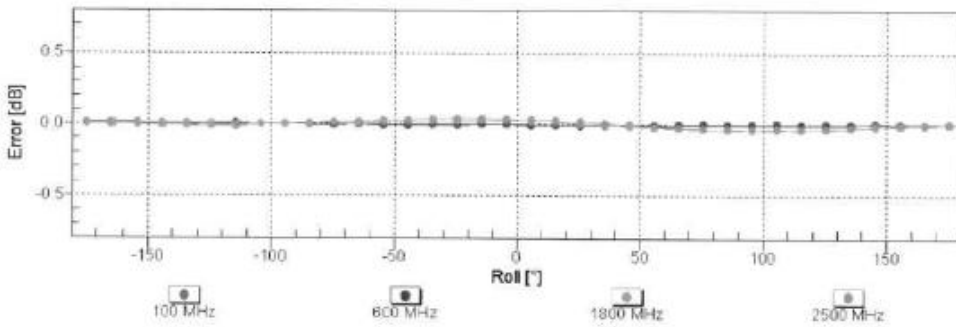

Uncertainty of Axial Isotropy Assessment:  $\pm 0.5\%$  ( $k=2$ )



### Dynamic Range f(E-field) (TEM cell , f = 900 MHz)

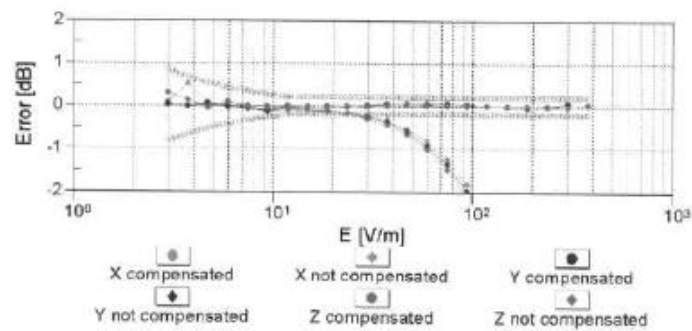
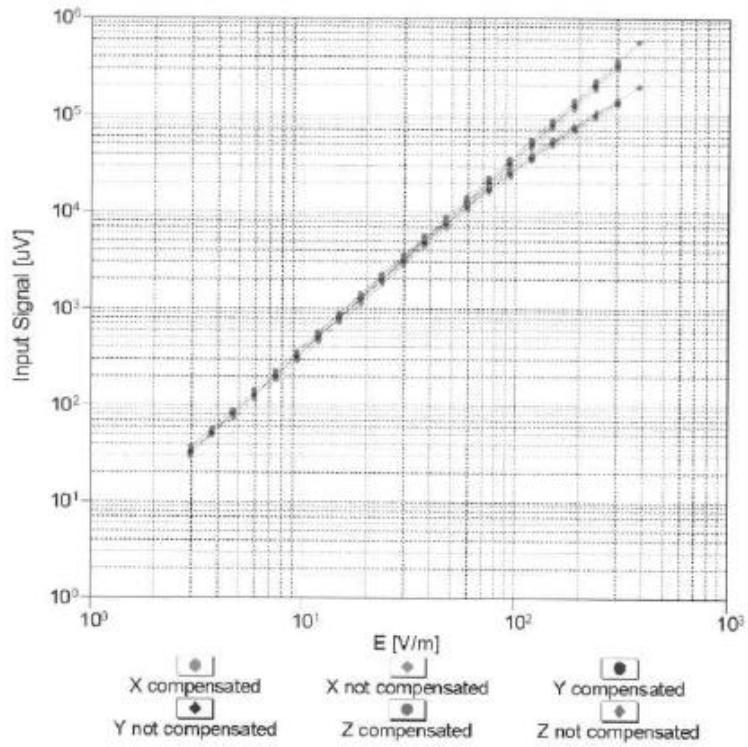

Uncertainty of Linearity Assessment:  $\pm 0.6\%$  ( $k=2$ )





ER3DV6- SN:2358

January 14, 2011

### Deviation from Isotropy in Air

Error ( $\phi, \theta$ ),  $f = 900$  MHz

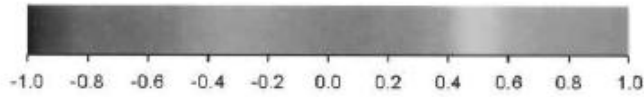
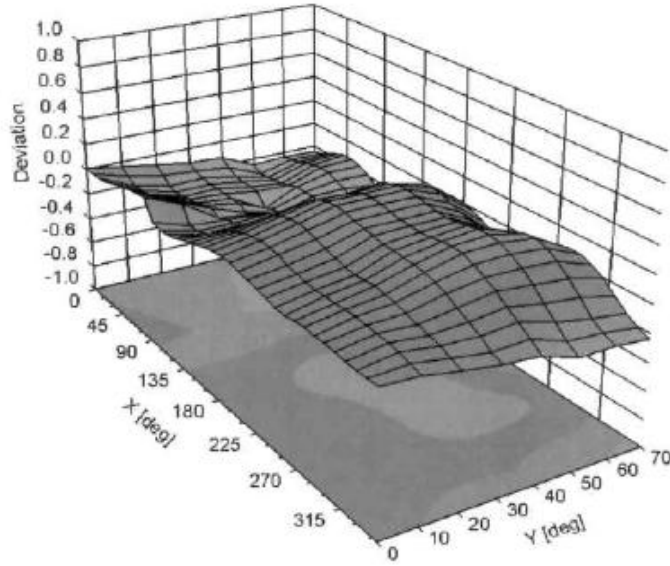

Uncertainty of Spherical Isotropy Assessment:  $\pm 2.6\%$  ( $k=2$ )



ER3DV6- SN:2358

January 14, 2011

## **DASY/EASY - Parameters of Probe: ER3DV6 - SN:2358**

### **Other Probe Parameters**

Sensor Arrangement	Rectangular
Connector Angle (°)	115.6
Mechanical Surface Detection Mode	enabled
Optical Surface Detection Mode	disabled
Probe Overall Length	337 mm
Probe Body Diameter	10 mm
Tip Length	10 mm
Tip Diameter	8 mm
Probe Tip to Sensor X Calibration Point	2.5 mm
Probe Tip to Sensor Y Calibration Point	2.5 mm
Probe Tip to Sensor Z Calibration Point	2.5 mm



# Calibration Certificate of DAS Y

**Calibration Laboratory of  
Schmid & Partner  
Engineering AG**  
Zeughausstrasse 43, 8004 Zurich, Switzerland



**S** Schweizerischer Kalibrierdienst  
**S** Service suisse d'étalonnage  
**S** Servizio svizzero di taratura  
**S** Swiss Calibration Service

Accredited by the Swiss Accreditation Service (SAS)  
The Swiss Accreditation Service is one of the signatories to the EA  
Multilateral Agreement for the recognition of calibration certificates

Accreditation No.: **SCS 108**

Client **Sporton-TW (Auden)**

Certificate No: **H3-6184\_Jan11**

## CALIBRATION CERTIFICATE

Object	H3DV6 - SN:6184
Calibration procedure(s)	QA CAL-03.v6, QA CAL-25.v3 Calibration procedure for H-field probes optimized for close near field evaluations in air
Calibration date:	January 25, 2011
This calibration certificate documents the traceability to national standards, which realize the physical units of measurements (SI). The measurements and the uncertainties with confidence probability are given on the following pages and are part of the certificate.	
All calibrations have been conducted in the closed laboratory facility: environment temperature (22 ± 3)°C and humidity < 70%.	
Calibration Equipment used (M&TE critical for calibration)	

Primary Standards	ID	Cal Date (Certificate No.)	Scheduled Calibration
Power meter E4419B	GB41293874	01-Apr-10 (No. 217-01136)	Apr-11
Power sensor E4412A	MY41495277	01-Apr-10 (No. 217-01136)	Apr-11
Power sensor E4412A	MY41498087	01-Apr-10 (No. 217-01136)	Apr-11
Reference 3 dB Attenuator	SN: S5054 (3c)	30-Mar-10 (No. 217-01159)	Mar-11
Reference 20 dB Attenuator	SN: S5086 (20b)	30-Mar-10 (No. 217-01161)	Mar-11
Reference 30 dB Attenuator	SN: S5129 (30b)	30-Mar-10 (No. 217-01160)	Mar-11
Reference Probe H3DV6	SN: 6182	4-Oct-10 (No. H3-6182_Oct10)	Oct-11
DAE4	SN: 789	31-Aug-10 (No. DAE4-789_Aug10)	Aug-11
Secondary Standards	ID	Check Date (in house)	Scheduled Check
RF generator HP 8648C	US3642U01700	4-Aug-99 (in house check Oct-09)	In house check: Oct-11
Network Analyzer HP 8753E	US37390585	18-Oct-01 (in house check Oct-10)	In house check: Oct-11

Calibrated by:	Name Marcel Fehr	Function Laboratory Technician	Signature 
Approved by:	Katja Pokovic	Technical Manager	
			Issued: January 25, 2011
This calibration certificate shall not be reproduced except in full without written approval of the laboratory.			

**Calibration Laboratory of  
Schmid & Partner  
Engineering AG**  
Zeughausstrasse 43, 8004 Zurich, Switzerland



**S** Schweizerischer Kalibrierdienst  
**C** Service suisse d'étalonnage  
**S** Servizio svizzero di taratura  
**S** Swiss Calibration Service

Accredited by the Swiss Accreditation Service (SAS)

Accreditation No.: **SCS 108**

The Swiss Accreditation Service is one of the signatories to the EA  
Multilateral Agreement for the recognition of calibration certificates

**Glossary:**

NORM <sub>x,y,z</sub>	sensitivity in free space
DCP	diode compression point
CF	crest factor (1/duty_cycle) of the RF signal
A, B, C	modulation dependent linearization parameters
Polarization $\phi$	$\phi$ rotation around probe axis
Polarization $\theta$	$\theta$ rotation around an axis that is in the plane normal to probe axis (at measurement center), i.e., $\theta = 0$ is normal to probe axis
Connector Angle	information used in DAS Y system to align probe sensor X to the robot coordinate system

**Calibration is Performed According to the Following Standards:**

- a) IEEE Std 1309-2005, "IEEE Standard for calibration of electromagnetic field sensors and probes, excluding antennas, from 9 kHz to 40 GHz", December 2005.

**Methods Applied and Interpretation of Parameters:**

- **NORM<sub>x,y,z</sub>**: Assessed for E-field polarization  $\theta = 0$  for XY sensors and  $\theta = 90$  for Z sensor ( $f \leq 900$  MHz in TEM-cell;  $f > 1800$  MHz: R22 waveguide).
- **X, Y, Z(f)\_a0a1a2 = X, Y, Z\_a0a1a2\* frequency\_response** (see Frequency Response Chart).
- **DCP<sub>x,y,z</sub>**: DCP are numerical linearization parameters assessed based on the data of power sweep with CW signal (no uncertainty required). DCP does not depend on frequency nor media.
- **A<sub>x,y,z</sub>; B<sub>x,y,z</sub>; C<sub>x,y,z</sub>; VR<sub>x,y,z</sub>**: A, B, C are numerical linearization parameters assessed based on the data of power sweep for specific modulation signal. The parameters do not depend on frequency nor media. VR is the maximum calibration range expressed in RMS voltage across the diode.
- **Spherical isotropy (3D deviation from isotropy)**: in a locally homogeneous field realized using an open waveguide setup.
- **Sensor Offset**: The sensor offset corresponds to the offset of virtual measurement center from the probe tip (on probe axis). No tolerance required.
- **Connector Angle**: The angle is assessed using the information gained by determining the X\_a0a1a2 (no uncertainty required).





H3DV6 – SN:6184

January 25, 2011

# Probe H3DV6

## SN:6184

Manufactured: June 8, 2004  
Calibrated: January 25, 2011

Calibrated for DASY/EASY Systems  
(Note: non-compatible with DASY2 system!)



H3DV6- SN:6184

January 25, 2011

## DASY/EASY - Parameters of Probe: H3DV6 - SN:6184

### Basic Calibration Parameters

		Sensor X	Sensor Y	Sensor Z	Unc (k=2)
Norm (A/m / $\sqrt{(mV)}$ )	a0	2.53E-003	2.58E-003	3.00E-003	$\pm 5.1 \%$
Norm (A/m / $\sqrt{(mV)}$ )	a1	-2.60E-005	-9.54E-005	-1.07E-004	$\pm 5.1 \%$
Norm (A/m / $\sqrt{(mV)}$ )	a2	1.54E-005	2.86E-006	6.42E-005	$\pm 5.1 \%$
DCP (mV) <sup>B</sup>		91.0	90.6	91.7	

### Modulation Calibration Parameters

UID	Communication System Name	PAR		A dB	B dB	C dB	VR mV	Unc <sup>E</sup> (k=2)
10000	CW	0.00	X	0.00	0.00	1.00	251.5	$\pm 1.6 \%$
			Y	0.00	0.00	1.00	252.0	
			Z	0.00	0.00	1.00	238.8	

The reported uncertainty of measurement is stated as the standard uncertainty of measurement multiplied by the coverage factor k=2, which for a normal distribution corresponds to a coverage probability of approximately 95%.

<sup>B</sup> Numerical linearization parameter: uncertainty not required.

<sup>E</sup> Uncertainty is determined using the max. deviation from linear response applying rectangular distribution and is expressed for the square of the field value.



H3DV6- SN:6184

January 25, 2011

### Frequency Response of H-Field (TEM-Cell:ifi110 EXX, Waveguide: R22)

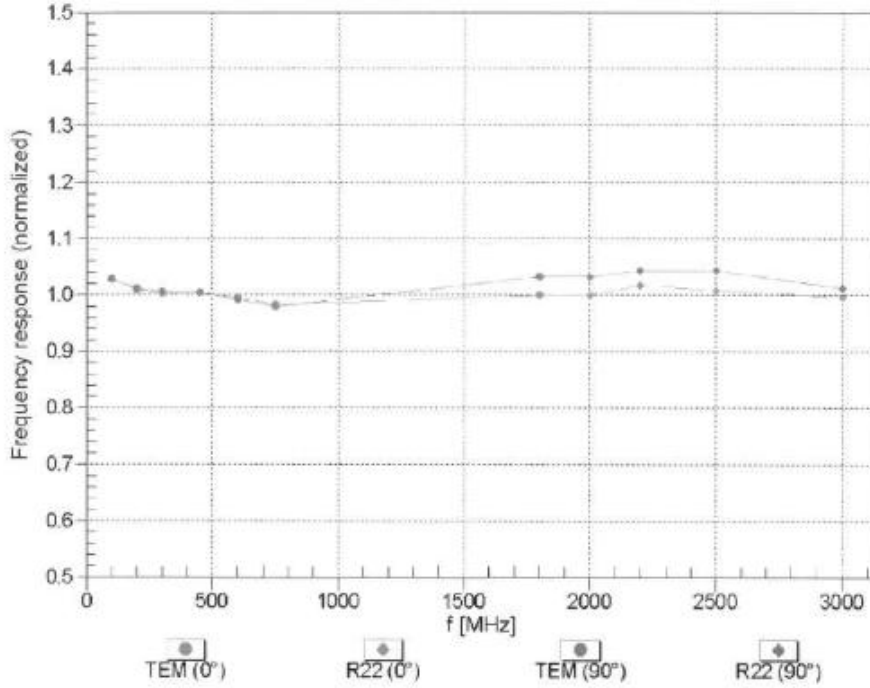

Uncertainty of Frequency Response of H-field:  $\pm 6.3\%$  (k=2)

**Receiving Pattern ( $\phi$ ),  $\vartheta = 0^\circ$**

f=600 MHz,TEM,0°

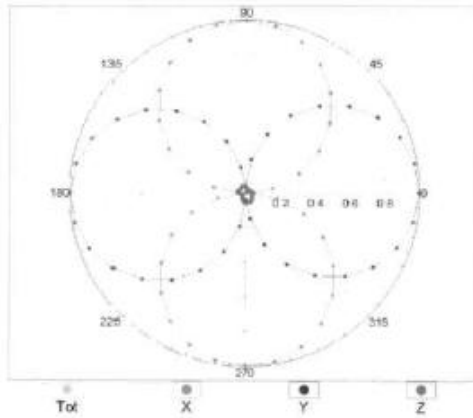

f=2500 MHz,R22,0°

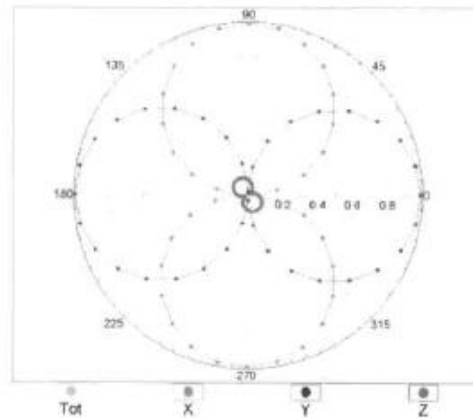

**Receiving Pattern ( $\phi$ ),  $\vartheta = 90^\circ$**

f=600 MHz,TEM,90°

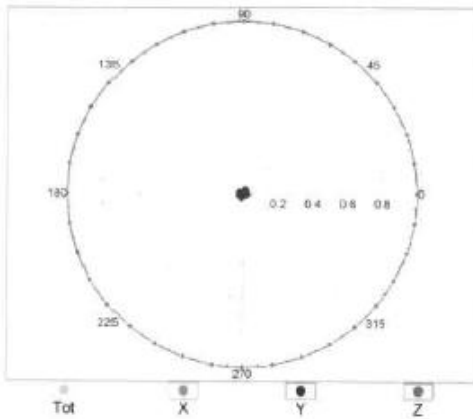

f=2500 MHz,R22,90°

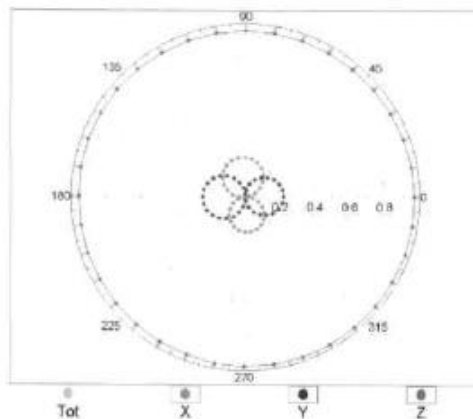



H3DV6- SN:6184

January 25, 2011

### Receiving Pattern ( $\phi$ ), $\vartheta = 0^\circ$

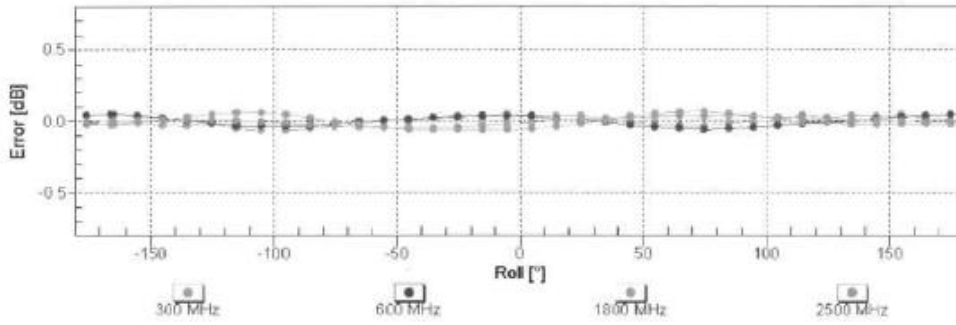

Uncertainty of Axial Isotropy Assessment:  $\pm 0.5\%$  (k=2)

### Receiving Pattern ( $\phi$ ), $\vartheta = 90^\circ$

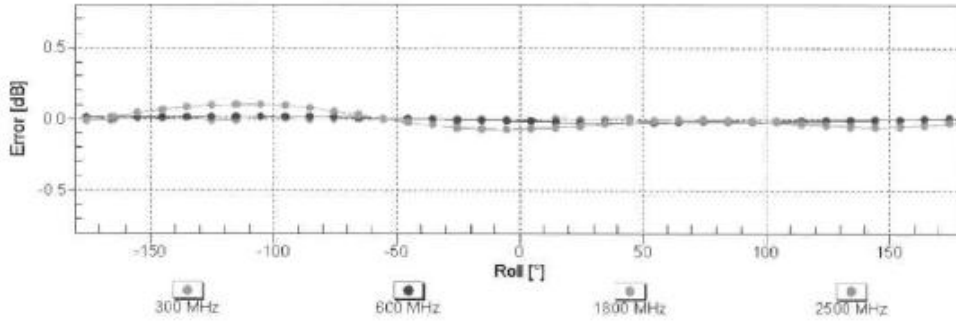

Uncertainty of Axial Isotropy Assessment:  $\pm 0.5\%$  (k=2)





### Dynamic Range f(H-field) (TEM cell, f = 900 MHz)

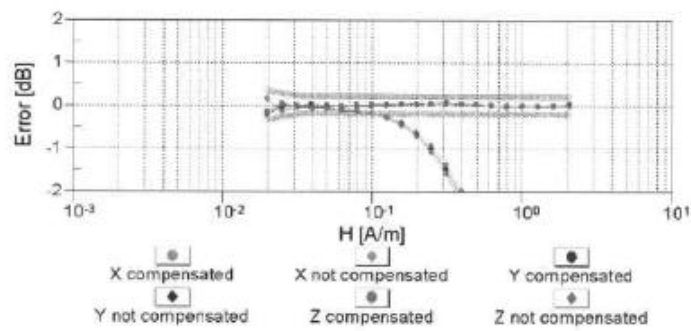
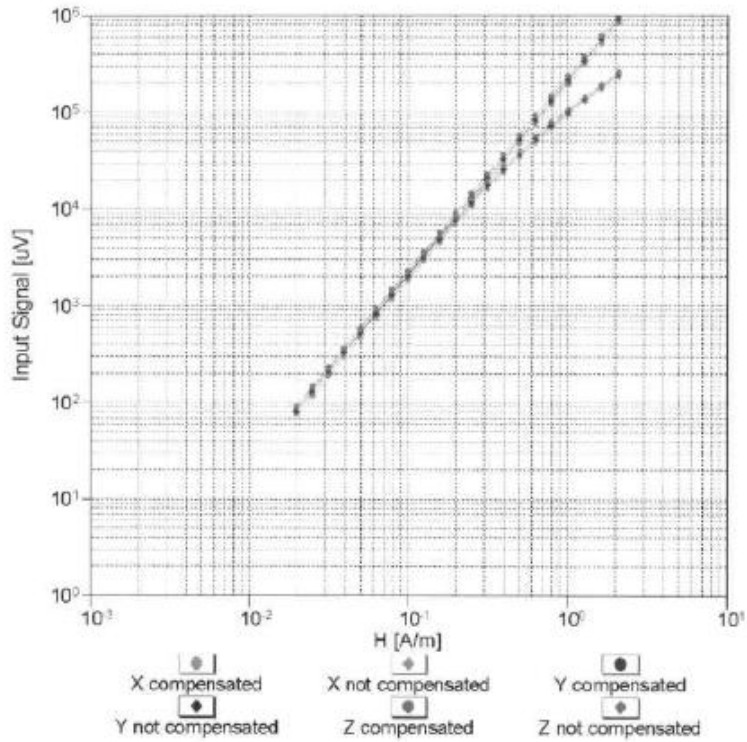

Uncertainty of Linearity Assessment:  $\pm 0.6\%$  (k=2)

H3DV6- SN:6184

January 25, 2011

### Deviation from Isotropy in Air

Error ( $\phi$ ,  $\theta$ ),  $f = 900$  MHz

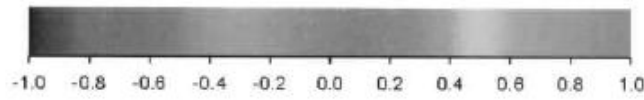
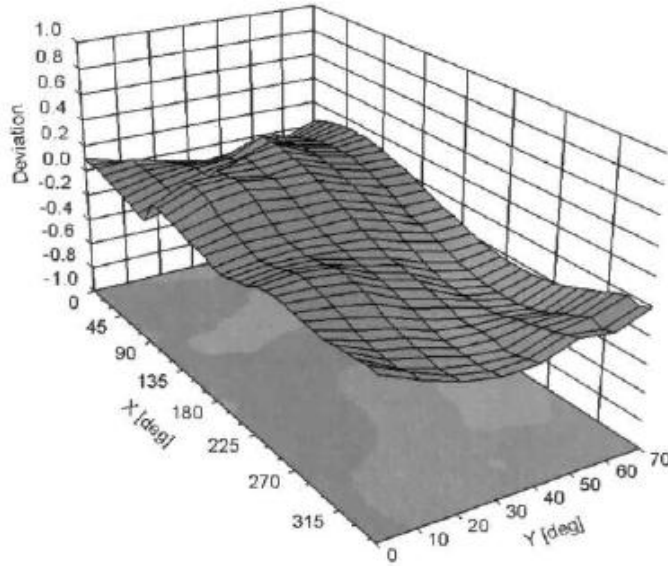

Uncertainty of Spherical Isotropy Assessment:  $\pm 2.6\%$  ( $k=2$ )



H3DV6- SN:6184

January 25, 2011

## DASY/EASY - Parameters of Probe: H3DV6 - SN:6184

### Other Probe Parameters

Sensor Arrangement	Rectangular
Connector Angle (°)	-65.4
Mechanical Surface Detection Mode	enabled
Optical Surface Detection Mode	disabled
Probe Overall Length	337 mm
Probe Body Diameter	10 mm
Tip Length	20 mm
Tip Diameter	6 mm
Probe Tip to Sensor X Calibration Point	3 mm
Probe Tip to Sensor Y Calibration Point	3 mm
Probe Tip to Sensor Z Calibration Point	3 mm