



(2004)量认(国)字(H2402)号



ShenZhen Electronic Product Quality Testing Center

CONFORMANCE TEST REPORT FOR HUMAN EXPOSURE TO ELECTROMAGNETIC FIELDS

SAR07-011

QINGDAO HAIER TELECOM CO., LTD.

GSM

Type Name: HG-A7I

FCC ID: SG70701HG-A7I

Hardware Version: P1
Software Version: H01-S003-NA

Date of Issue: 2007-03-13





GENERAL SUMMARY

Product Name	GSM	Development Stage	Identical prototype
Standard(s)	<p>47CFR § 2.1093: Radiofrequency Radiation Exposure Evaluation: Portable Devices FCC OET Bulletin 65 (Edition 97-01), Supplement C (Edition 01-01): Evaluating Compliance with FCC Guidelines for Human Exposure to Radiofrequency Electromagnetic Fields ANSI C95.1-1999: IEEE Standard for Safety Levels with Respect to Human Exposure to Radio Frequency Electromagnetic Fields, 3 kHz to 300 GHz. IEEE 1528-2003: Recommended Practice for Determining the Peak Spatial-Average Specific Absorption Rate (SAR) in the Human Body Due to Wireless Communications Devices: Experimental Techniques.</p>		
Conclusion	<p>Localized Specific Absorption Rate (SAR) of this portable wireless equipment has been measured in all cases requested by the relevant standards cited in Clause 5.2 of this test report. Maximum localized SAR is below exposure limits specified in the relevant standards cited in Clause 5.1 of this test report.</p> <p>General Judgment: Pass</p> <p style="text-align: right;">Date of issue: Mar 13, 2007</p>		
Comment	<p>TX Freq.Band: 824.20 MHz—848.80 MHz (GSM) 1850.20 MHz —1909.80 MHz (GSM) RX Freq. Band:869.20 MHz—893.80 MHz (GSM) 1930.20 MHz —1989.80 MHz (GSM) Antenna Character : build inside</p> <p>The test result only responds to the measured sample.</p>		
Tested	<p>by: <u>Zhang Can</u> Date: <u>Mar 13, 2007</u> Zhang Can</p> <p>Checked by: <u>Smart Li</u> Date: <u>Mar. 13, 2007</u> Smart Li</p> <p>Approved by: <u>Li'an Wu</u> Date: <u>Mar. 13, 2007</u> Li'an Wu</p>		





Contents

- 1. GENERAL CONDITIONS**
- 2. ADMINISTRATIVE DATA**
 - 2.1. Identification of the Responsible Testing Laboratory
 - 2.2. Identification of the Responsible Testing Location(s)
 - 2.3. Organization Item
 - 2.4. Identification of Applicant
 - 2.5. Identification of Manufacture
- 3. EQUIPMENT UNDER TEST (EUT)**
 - 3.1. Identification of the Equipment under Test
 - 3.2. Identification of all used Test Sample of the Equipment under Test
- 4. OPERATIONAL CONDITIONS DURING TEST**
 - 4.1. Schematic Test Configuration
 - 4.2. SAR Measurement System
- 5. CHARACTERISTICS OF THE TEST**
 - 5.1. Applicable Limit Regulations
 - 5.2. Applicable Measurement Standards
- 6. LABORATORY ENVIRONMENT**
- 7. TEST RESULTS**
 - 7.1. Dielectric Performance
 - 7.2. Summary of Measurement Results
 - 7.3. Conclusion
- 8. MEASUREMENT UNCERTAINTY**
- 9. MAIN TEST INSTRUMENTS**

This Test Report consists of the following Annexes:

- Annex A: Accreditation Certificate**
- Annex B: Test Layout**
- Annex C: Sample Photographs**
- Annex D: Graph Test Results**
- Annex E: System Performance Check Data**



1. GENERAL CONDITIONS

1.1 This report only refers to the item that has undergone the test.

1.2 This report standalone dose not constitute or imply by its own an approval of the product by the certification Bodies or competent Authorities.

1.3 This document is only valid if complete; no partial reproduction can be made without written approval of Shenzhen Electronic Product Quality Testing Center.

1.4 This report cannot be used partially or in full for publicity and/or promotional purposes without previous written approval of Shenzhen Electronic Product Quality Testing Center and the Accreditation Bodies, if it applies.



2. Administrative Date

2.1. Identification of the Responsible Testing Laboratory

Company Name: ShenZhen Electronic Product Quality Testing Center
Department: Testing Department
Address: Electronic Testing Building, ShaHe Road, NanShan District,
ShenZhen, P. R. China
Telephone: +86-755-26628676
Fax: +86-755-26627238
**Responsible Test Lab
Managers:** Mr. Li'an Wu

2.2. Identification of the Responsible Testing Location(s)

Company Name: ShenZhen Electronic Product Quality Testing Center
Address: Electronic Testing Building, ShaHe Road, NanShan District,
ShenZhen, P. R. China

2.3. Organization Item

S.E.T Report No.: SAR07-011
S.E.T Project Leader: Mr. Li Sixiong
**S.E.T Responsible for
accreditation scope:** Mr. Li'an Wu
Start of Testing: 2007-02-12
End of Testing: 2007-03-13

2.4. Identification of Applicant

Company Name: QINGDAO HAIER TELECOM CO., LTD.
Address: No.1,Haier Road,Hi-tech Zone,Qingdao,266101,P.R.China
Contact person: Xu Jun
Telephone: +86(532)88937356
Fax: +86(532)88939585

2.5. Identification of Manufacture

Company Name: QINGDAO HAIER TELECOM CO., LTD.
Address: 3F., Seocho-world Officetel, 1355-3, SeoCho-Dong, SeoCho-Gu,
Seoul 137-862, Korea
Contact person: Xu Jun
Telephone: +86(532)88937356
Fax: +86(532)88939585

Notes: This data is based on the information by the applicant.



3. Equipment Under Test (EUT)

3.1. Identification of the Equipment under Test

Brand Name: /
Type Name: HG-A7I
Marking Name: HG-A7I

General description:

Test frequency	GSM 850MHz and GSM 1900MHz
Development Stage	Identical prototype
Accessories	Charger, Battery
Battery Model	HG-A7I
Battery specification	560mAh 3.7V
Antenna type	Build inside
Operation mode	Call established
Modulation mode	GSMK
Max. Power	33dBm(GSM 850) 30dBm(GSM 1900)

3.2. Identification of all used Test Sample of the Equipment under Test

EUT Code	Serial Number	Hardware Version	Software Version	IMEI
1#	N.A.	P1	H01-S003-NA	0000000000000000

NOTE:

1. The EUT consists of Hand Telephone Set and normal options: Charger, Lithium Battery as listed above.
2. Please refer to Appendix C for the photographs of the EUT. For a more detailed features description about the EUT, please refer to User's Manual.
3. The EUT can work in four different bands, but this SAR test was performed only in the GSM 850MHz and GSM 1900MHz bands.

4 OPERATIONAL CONDITIONS DURING TEST

4.1 Schematic Test Configuration

During SAR test, EUT is in Traffic Mode (Channel Allocated) at Normal Voltage Condition. A communication link is set up with a System Simulator (SS) by air link, and a call is established.

The TCH is allocated to 128, 190 and 251 respectively in the case of GSM 850 MHz, or to 512, 661 and 810 respectively in the case of GSM 1900 MHz. The EUT is commanded to operate at maximum transmitting power.

The EUT shall use its internal transmitter. The antenna(s), battery and accessories shall be those specified by the manufacturer. The EUT battery must be fully charged and checked periodically during the test to ascertain uniform power output. If a wireless link is used, the antenna connected to the output of the base station simulator shall be placed at least 50 cm away from the handset.

The signal transmitted by the simulator to the antenna feeding point shall be lower than the output power level of the handset by at least 35 dB.

4.2 SAR Measurement System

The SAR measurement system being used is the IndexSAR SARA2 system, which consists of a

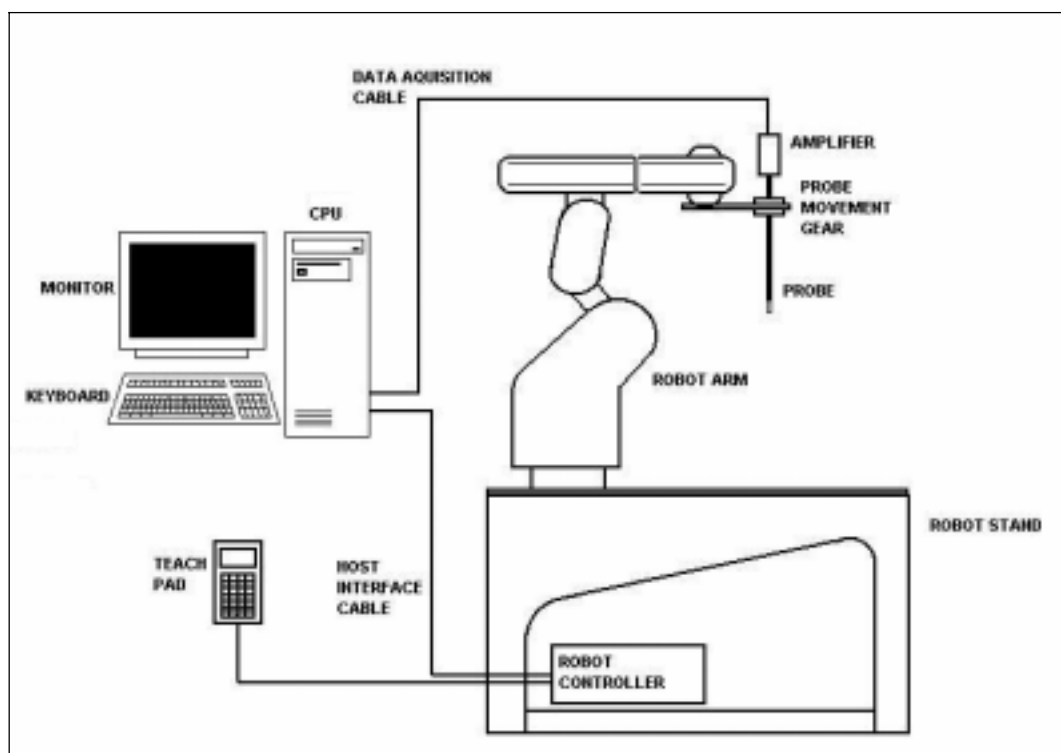

Figure1. SAR Lab Test Measurement Set-up

Mitsubishi RV-E2 6-axis robot arm and controller, IndexSAR probe and amplifier and SAM phantom Head Shape. The system is controlled remotely from a PC, which contains the software to control the robot and data acquisition equipment. The software also displays the data obtained from test scans.

In operation, the system first does an area (2D) scan at a fixed depth within the liquid from the inside wall of the phantom. When the maximum SAR point has been found, the system will then carry out a 3D scan centred at that point to determine volume averaged SAR level.

4.2.1 Robot system specification

The robot is used to articulate the probe to programmed positions inside the phantom head to obtain the SAR readings from the DUT.



Robot and Stand

Type	Mitsubishi Movemaster RV-2A / 6 axis vertical articulated robot
Dimensions (robot)	Height: 790mm (in home position)
Dimensions (robot stand)	1010L x 450W x 820H mm
Weight	Approx. 36 kg
Position repeatability	+/- 0.04mm
Drive Method	AC servomotor
Expandability	Extra axis expansion capability for probe calibration applications E-Field probe



Robot Controller Unit

Type	CR1 - 571
Dimensions	212W x 290D x 151H mm
Weight	8 kg
Power source	single-phase 100 - 240 VAC

4.2.2 Probe and amplifier specification

IXP-050 Indexsar isotropic immersible SAR probe

The probes are constructed using three orthogonal dipole sensors arranged on an interlocking, triangular

prism core. The probes have built-in shielding against static charges and are contained within a PEEK cylindrical enclosure material at the tip (showed in figure 2). The system uses diode compression potential (DCP) to determine SAR values for different types of modulation. Crest factor is not used for determining SAR values. The DCP for different types of modulation is determined during the probe calibration procedure.

E-filed Probe	
Type	Three orthogonal dipole sensors arranged on triangular, interlocking substrates
Dimensions	Overall length: 350mm Tip length: 10mm Body diameter: 12mm Tip diameter: 5mm Distance from probe tip to dipole centers: 2.5mm
Interfacing	Lemo 6 pole latching connector for interfacing to high impedance amplifier
Isotropy	+/- 0.5dB in brain liquids (rotation about probe axis) typically +/- 0.15dB +/- 0.5dB in brain liquids (rotation normal to probe axis)
Calibration	Indexsar calibration in brain tissue simulating liquids at frequency of 900MHz, 1800MHz and 1900MHz
Dynamic Range	0.001W/kg to 100W/kg in liquid. Linearity +/- 0.2W/kg

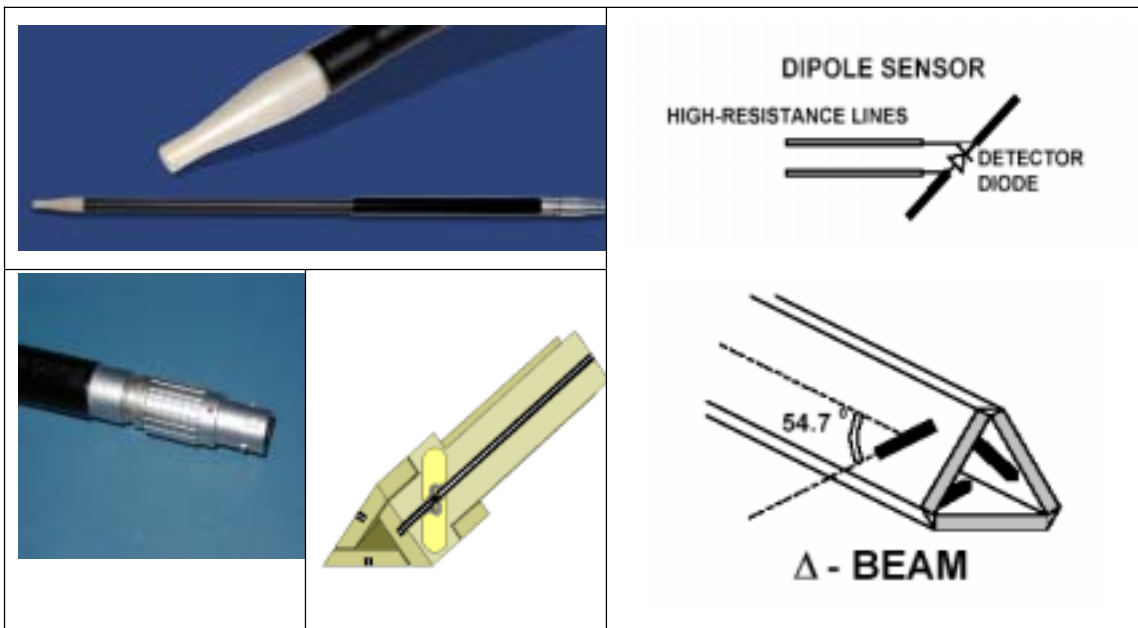



Figure2. Specification and characterisation parameters of indexsar probe

IFA-010 Amplifier

The amplifier unit has a multi-pole connector to connect to the probe and a multiplexer selects between the 3-channel single-ended inputs. A 16-bit AtoD converter with programmable gain is used along with an on-board micro-controller with non-volatile firmware. Battery life is around 150 hours and data are transferred to the PC via 3m of duplex optical fibre and a self-powered RS232 to optical converter.



Probe Amplifier and PC Interface

Type	High impedance inputs with 3 independent x,y,z sensor channels giving simultaneous measurement data every 2ms. Reads true average of modulated signals without the need for duty cycle corrections
Ranges	Software selectable of x1 to 63
Cable	Optical cable with self-powered 9 way RS232 converter. 3m cable length supplied as standard. Other lengths to order.
Power Requirements	2 x AAA batteries giving approximately 100 hours usage.

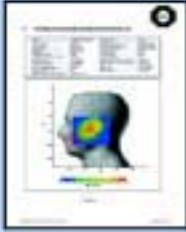

'Word' report format

The results of each frequency scan are presented in a Microsoft 'Word' document with all the necessary measurement parameters automatically tabulated. Users can customise the layout and in some cases language changes are possible.

4.2.3 Phantoms and simulant liquid

4.2.3.1 SAR head phantom (SAM)

The Indexsar SAM Upright Phantom is fabricated to the shape defined in these CAD files by Antennessa.



Head Phantom

Type 2	Upright SAM phantom
Dimensions	Height: 320mm Baseplate diameter: 275mm
Weight	empty: 1.2 kg filled: 7.2 kg
Wall thickness	2.0 mm \pm 0.2
Construction	Low loss resin / Strengthened saggital seam

It is mounted on the base table, which holds the robotic positioner. Both mechanical and laser-based

registration systems are utilised to register the phantom position in relationship to the robot co-ordinate system. In the SARA2 implementation, the SAM phantom is mounted on a supporting table made of low dielectric loss material, which includes mounting brackets for DUT positioners, dipole holders and (optionally) a shelf for supporting larger devices like laptop computers.

4.2.3.2 Box phantom

The box phantom used for body testing and for validation is manufactured from Perspex.

IXB – 070 Specification and characterisation parameters

	Constructional details	
	Internal dimensions:	200mm x 200mm x 200mm
	Thickness of base:	2mm +/- 0.2mm
	Wall thickness:	4mm
	Material:	PMMA
	Frequency range	300MHz – 6GHz
	Dielectric properties	Relative permittivity 2.7 Loss tangent <0.02

Tissue-simulant volume required for 150mm depth (6 litres)

4.2.3.3 Simulant liquids

Simulant liquids that are used for testing at frequencies of GSM 850MHz and GSM 1900MHz, which are made mainly of sugar, salt and water solutions may be left in the phantoms. Approximately 7litres are needed for an upright head compared to about 27litres for a horizontal bath phantom.

Ingredients (% by weight)	Frequency(MHz)			
	850		1900	
Tissue Type	Head	Body	Head	Body
Water	40.92	56.0	54.9	40.4
Salt(NaCl)	1.48	0.76	0.18	0.5
Sugar	56.5	41.76	0.0	58.0
HEC	1	1.21	0.0	1.0
Bacterial de	0.0	0.0	0.0	0.1
DGBE	0.0	0.0	44.92	0.0
Acticide SPX	0.1	0.27	0.0	0.0
Dielectric Constant	41.44	52.99	39.9	54.0
Conductivity (S/m)	0.99	1.12	1.42	1.45

4.2.4 SAR measurement procedure

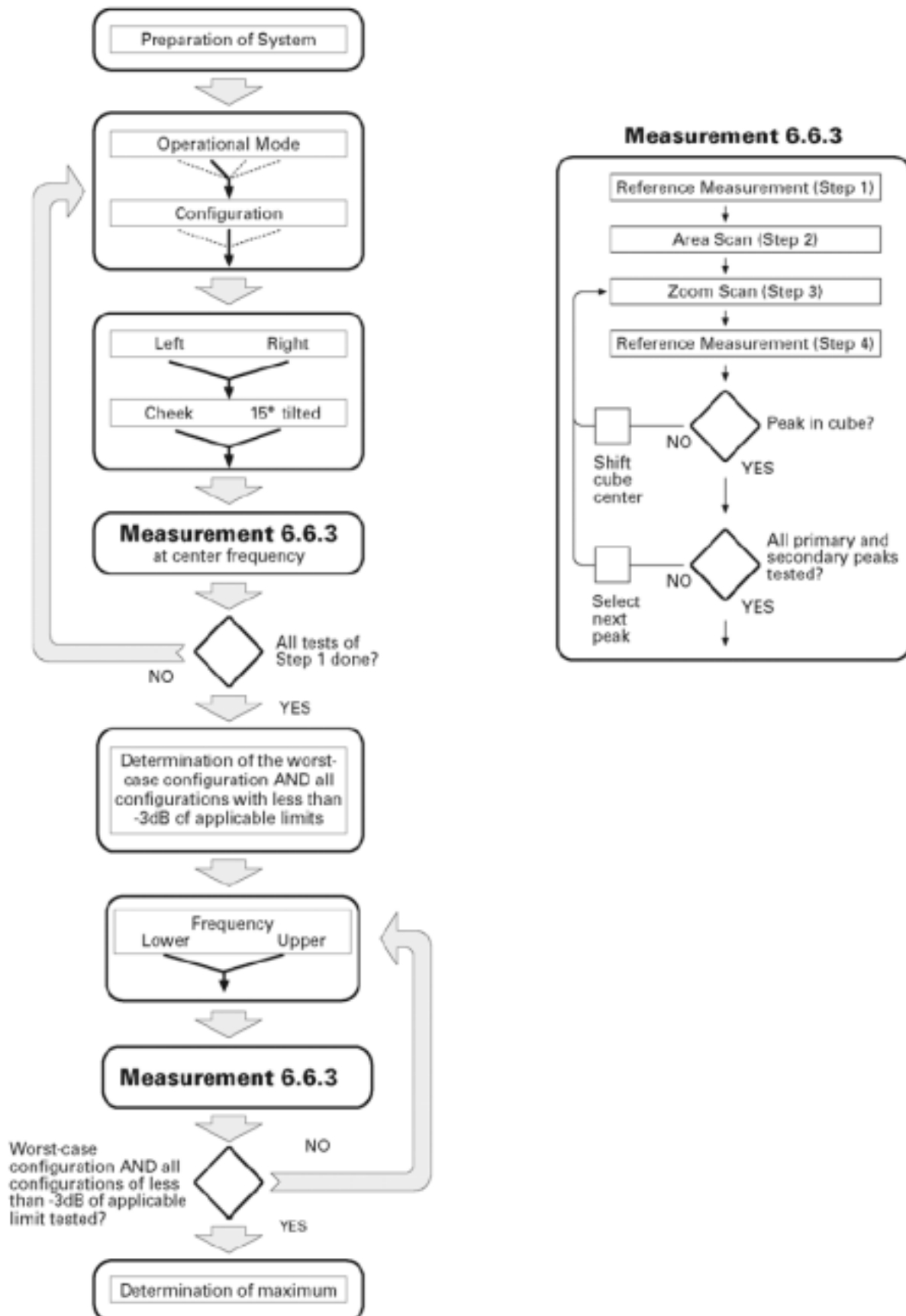

Channel	Left				Right			
	Cheek		Tilt		Cheek		Tilt	
	Retracted	Extended	Retracted	Extended	Retracted	Extended	Retracted	Extended
Mode 1:								
High			S2(-1.4dB)	S2(-0.4dB)			S2(-2.2dB)	S2(-1.4dB)
Middle	S1(-4dB)	S1(-4dB)	S1(-1.5dB)	S1(-0.5dB)	S1(-5dB)	S1(-5dB)	S1(-2.5dB)	S1(-1.5dB)
Low			S2(-1.3dB)	S2(-0.7dB)			S2(-2.7dB)	S2(-0.6dB)
Mode 2:								
High			S2(-2.7dB)	S2(-1.1dB)				
Middle	S1(-5dB)	S1(-5dB)	S1(-2.5dB)	S1(-1dB)	S1(-6dB)	S1(-6dB)	S1(-5dB)	S1(-5dB)
Low			S2(-2.2dB)	S2(-0.8dB)				

After an area scan has been done at a fixed distance of 8mm from the surface of the phantom on the source side, a 3D scan is set up around the location of the maximum spot SAR. First, a point within the scan area is visited by the probe and a SAR reading taken at the start of testing. At the end of testing, the probe is returned to the same point and a second reading is taken. Comparison between these start and end readings enables the power drift during measurement to be assessed.

Above is the scanning procedure flow chart and table from the IEEE P1528 standard. This is the procedure for which all compliant testing should be carried out to ensure that all variations of the device position and transmission behaviour are tested.

4.2.5 Validation testing using box phantoms

The following procedure, recommended for performing validation tests using box phantoms is based on the procedures described in the draft IEEE standard P1528. Setup according to the setup diagram below :

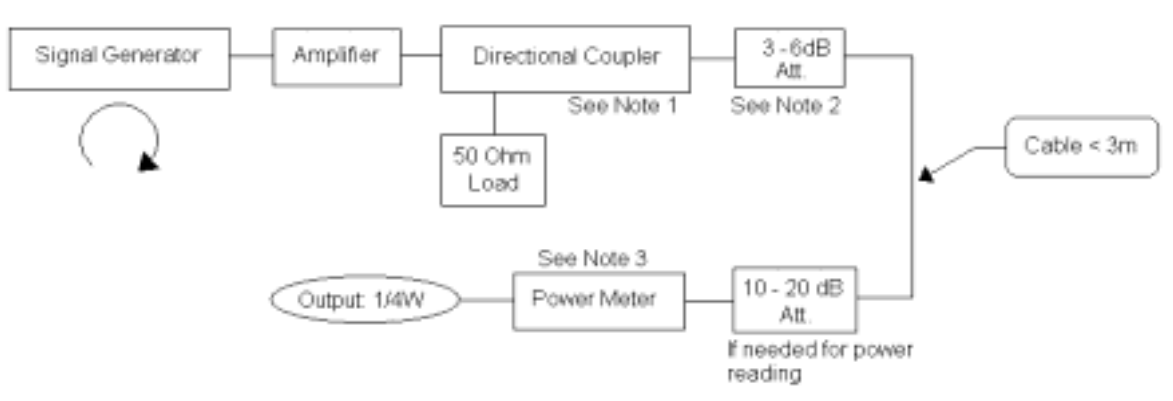

With the SG and Amp and with directional coupler in place, set up the source signal at the relevant

frequency and use a power meter to measure the power at the end of the SMA cable that you intend to connect to the balanced dipole. Adjust the SG to make this, say, 0.25W (24 dBm). If this level is too high to read directly with the power meter sensor, insert a calibrated attenuator (e.g. 10 or 20 dB) and make a suitable correction to the power meter reading.

Note 1: In this method, the directional coupler is used for monitoring rather than setting the exact feed power level. If, however, the directional coupler is used for power measurement, you should check the frequency range and power rating of the coupler and measure the coupling factor (referred to output) at the test frequency using a VNA.

Note 2: Remember that the use of a 3dB attenuator (as shown in Figure 8.1 of P1528) means that you need an RF amplifier of 2 times greater power for the same feed power. The other issue is the cable length. You might get up to 1dB of loss per meter of cable, so the cable length after the coupler needs to be quite short.

Note 3: For the validation testing done using CW signals, most power meters are suitable. However, if you are measuring the output of a modulated signal from either a signal generator or a handset, you must ensure that the power meter correctly reads the modulated signals.

4.2.5.1 Setting up the box phantom for validation testing

The main purpose of the box phantom is for validation of the system. By placing the box phantom in place of the upright head, using the box phantom dipole holder the system can now be used to check that the probe and software are giving accurate readings.

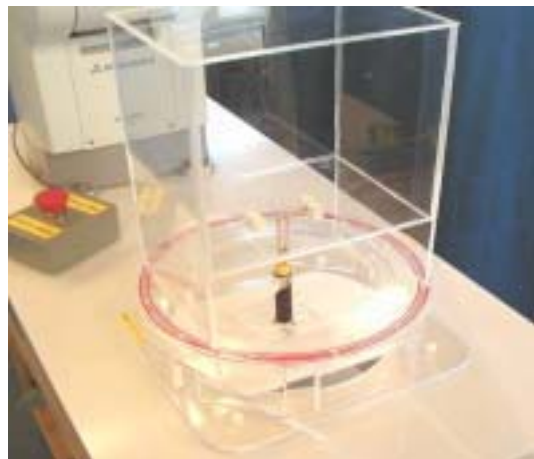

4.2.5.2 Equipments and results of validation testing

Equipments :

name	Type and specification
Signal generator	SML02
Directional coupler	450MHz-3GHz
Amplifier	3W 502(10-2500MHz)
Reference dipole	IXD-080 validation dipole
	IXD-090 validation dipole
	IXD-245 validation dipole

Results:

Frequency	Target value (1g)	Test value (1g)	
		10.528 W/kg (Head)	10.272 W/kg (Body)
850MHz	10.8 W/kg	41.140 W/kg (Head)	40.340 W/kg (Body)
1900MHz	39.7 W/kg		

4.2.6 SARA2 Interpolation and Extrapolation schemes

SARA2 software contains support for both 2D cubic B-spline interpolation as well as 3D cubic B-spline interpolation. In addition, for extrapolation purposes, a general n-th order polynomial fitting routine is implemented following a singular value decomposition algorithm. A 4th order polynomial fit is used by default for data extrapolation, but a linear-logarithmic fitting function can be selected as an option. The polynomial fitting procedures have been tested by comparing the fitting coefficients generated by the SARA2 procedures with those obtained using the polynomial fit functions of Microsoft Excel when applied to the same test input data.

4.2.7 Interpolation of 2D area scan

The 2D cubic B-spline interpolation is used after the initial area scan at fixed distance from the phantom shell wall. The initial scan data are collected with approx. 10mm spatial resolution and spline interpolation is used to find the location of the local maximum to within a 1mm resolution for positioning the subsequent 3D scanning.

4.2.8 Extrapolation of 3D scan

For the 3D scan, data are collected on a spatially regular 3D grid having (by default) 6.4 mm steps in the lateral dimensions and 3.5 mm steps in the depth direction (away from the source). SARA2 enables full control over the selection of alternative step sizes in all directions.

The digitised shape of the head is available to the SARA2 software, which decides which points in the 3D array are sufficiently well within the shell wall to be 'visited' by the SAR probe. After the data collection, the data are extrapolated in the depth direction to assign values to points in the 3D array closer to the shell wall. A notional extrapolation value is also assigned to the first point outside the shell wall so that subsequent interpolation schemes will be applicable right up to the shell wall boundary.

4.2.9 Interpolation of 3D scan and volume averaging

The procedure used for defining the shape of the volumes used for SAR averaging in the SARA2 software follow the method of adapting the surface of the 'cube' to conform with the curved inner surface of the phantom. This is called, here, the conformal scheme.

For each row of data in the depth direction, the data are extrapolated and interpolated to less than 1mm spacing and average values are calculated from the phantom surface for the row of data over distances corresponding to the requisite depth for 10g and 1g cubes. This results in two 2D arrays of data, which are then cubic B-spline interpolated to sub mm lateral resolution. A search routine then moves an



averaging square around through the 2D array and records the maximum value of the corresponding 1g and 10g volume averages. For the definition of the surface in this procedure, the digitized position of the head shell surface is used for measurement in head-shaped phantoms. For measurements in rectangular, box phantoms, the distance between the phantom wall and the closest set of gridded data points is entered into the software. For measurements in box-shaped phantoms, this distance is under the control of the user. The effective distance must be greater than 2.5mm as this is the tip-sensor distance and to avoid interface proximity effects, it should be at least 5mm. A value of 6 or 8mm is recommended. This distance is called **dbe**.

For automated measurements inside the head, the distance cannot be less than 2.5mm, which is the radius of the probe tip and to avoid interface proximity effects, a minimum clearance distance of x mm is retained. The actual value of dbe will vary from point to point depending upon how the spatially regular 3D grid points fit within the shell. The greatest separation is when a grid point is just not visited due to the probe tip dimensions. In this case the distance could be as large as the step-size plus the minimum clearance distance (i.e with $x=5$ and a step size of 3.5, dbe will be between 3.5 and 8.5mm).

The default step size ($dstep$) used is 3.5mm, but this is under user-control. The compromise is with time of scan, so it is not practical to make it much smaller or scan times become long and power-drop influences become larger.

The robot positioning system specification for the repeatability of the positioning (dss) is ± 0.04 mm.

The phantom shell is made by an industrial moulding process from the CAD files of the SAM shape, with both internal and external moulds. For the upright phantoms, the external shape is subsequently digitized on a Mitutoyo CMM machine (Euro an ultrasonic sensor indicate that the shell thickness (dph) away from the ear is 2.0 ± 0.1 mm. The ultrasonic measurements were calibrated using additional mechanical measurements on available cut surfaces of the phantom shells. See support document IXS-020x.

For the upright phantom, the alignment is based upon registration of the rotation axis of the phantom on its 253mm diameter baseplate bearing and the position of the probe axis when commanded to go to the axial position. A laser alignment tool is provided (procedure detailed elsewhere). This enables the registration of the phantom tip ($dmis$) to be assured to within approx. 0.2mm. This alignment is done with reference to the actual probe tip after installation and probe alignment. The rotational positioning of the phantom is variable – offering advantages for special studies, but locating pins ensure accurate repositioning at the principal positions (LH and RH ears).

4.2.10 Probe anisotropy and boundary proximity influence correction software (Virtual Probe Miniaturization VPM software)

Indexsar Report IXS0223 provides a background to the factors affecting measurements at high frequencies when using SAR probes of size 8 – 5mm tip diameter. Although the Indexsar probes are at the smaller end of this range, SAR probes are not isotropic in 5GHz phantom field gradients and ad

- 1) At >5GHz, the SAR field decays to 1/e of its value within 3-4mm of the surface of a phantom with a source adjacent. So, measurements are significantly affected by small errors in the separation distances employed between the probe and the phantom surface. The distance between the probe tip and the plane of the sensors should be allowed for using the same value as that declared in the probe calibration document. Distances between the probe tip and phantom surface should be measured accurately to 0.1mm. The best way to assure this is to use the robot to position the probe in light contact with the phantom wall and then to withdraw the probe by the selected amount under robot control.
- 2) The preferred test geometry at 5GHz is for testing at the bottom of an open phantom. If tests at the side of a phantom are performed, it will be necessary to apply VPM corrections as described below. In either case, careful monitoring of probe spacing from the phantom is required. Probe isotropy is improved for measuring fields polarized either normal to or parallel to the probe axis. If the source polarization is known, this arrangement should be established, if possible.
- 3) The probe calibration factors including boundary correction terms should be carefully entered from the calibration document. The probe calibration factors require that the probe be oriented in a known rotational position. The red spot on the Indexsar probe should be aligned facing away from the robot arm.
- 4) The latest SARA2 software (VPM editions) contain support for correcting for probe anisotropy in strong field gradients and include a procedure for correcting for boundary proximity influences. As noted above, the probe has to be oriented in a given rotational position and some familiarity with the new measurement procedures is necessary. The calculations can be performed either with or without the extended correction schemes applied.
- 5) If boundary corrections are used, it may be preferable to go rather closer to the phantom surface than is usually recommended and to perform scans using small steps between the measurement planes so that good data on the SAR profiles are collected within the first 10mm of the phantom depth.



5 CHARACTERISTICS OF THE TEST

5.1 Applicable Limit Regulations

47CFR § 2.1093: Radiofrequency Radiation Exposure Evaluation: Portable Devices

FCC OET Bulletin 65(Edition 97-01), Supplement C(Edition 01-01): Evaluating Compliance with FCC Guidelines for Human Exposure to Radiofrequency Electromagnetic Fields

ANSI C95.1–1999: IEEE Standard for Safety Levels with Respect to Human Exposure to Radio Frequency Electromagnetic Fields, 3 kHz to 300 GHz.

It specifies the maximum exposure limit of **1.6 W/kg** as averaged over any 1 gram of tissue for portable devices being used within 20 cm of the user in the uncontrolled environment.

5.2 Applicable Measurement Standards

IEEE 1528–2003: Recommended Practice for Determining the Peak Spatial-Average Specific Absorption Rate (SAR) in the Human Body Due to Wireless Communications Devices: Experimental Techniques.

They specify the measurement method for demonstration of compliance with the SAR limits for such equipments.

6 LABORATORY ENVIRONMENT

Table: The Ambient Conditions during SAR Test

Temperature	Min. = 15 ° C, Max. = 30 ° C
Relative humidity	Min. = 30%, Max. = 70%
Ground system resistance	< 0.5 Ω
Ambient noise is checked and found very low and in compliance with requirement of standards. Reflection of surrounding objects is minimized and in compliance with requirement of standards.	

7 TEST RESULTS

7.1 Dielectric Performance

The measured 1-gram averaged SAR values of the device against the head and the body are provided in Tables 1 and 2 respectively. The humidity and ambient temperature of test facility were 54% ~60% and 23.0 °C ~23.9°C respectively. The SAM head phantom (SN 0380 SH and SN 0381 SH) were full of the head tissue simulating liquid. The depth of the body tissue was 15.1cm. The distance between the back of the device and the bottom of the flat phantom is 1.5cm. A base station simulator was used to control the device during the SAR measurement. The phone was supplied with full-charged battery for each measurement.

For head measurement, the device was tested at the lowest, middle and highest frequencies in the transmit band.

Table 1: Dielectric Performance of Head Tissue Simulating Liquid

Temperature: 23.0~23.9° C, humidity: 54~60%.			
/	Frequency	Permittivity ϵ	Conductivity σ (S/m)
Target value	850 MHZ	41.5	0.9
Validation value (Jan 6,2007)	850 MHZ	41.58	0.902
Target value	1900 MHz	40.0	1.40
Validation value (Jan 5,2007)	1900 MHz	40.12	1.394

For body-worn measurements, the device was tested against flat phantom representing the user body. Under measurement phone was put on in the belt holder.

Table 2: Dielectric Performance of Body Tissue Simulating Liquid

Temperature: 23.0~23.9° C, humidity: 54~60%.			
/	Frequency	Permittivity ϵ	Conductivity σ (S/m)
Target value	850 MHz	55.0	1.05
Validation value (Jan 11,2007)	850 MHz	55.47	0.972
Target value	1900 MHz	53.3	1.52
Validation value (Jan 11,2007)	1900 MHz	54.13	1.526

7.2 Summary of Measurement Results (GSM 850MHz and GSM 1900 MHz Band)

Table 3: SAR Values (GSM 850 MHz Band), Measured against the head.

Temperature: 23.0 °C ~23.8°C, humidity: 54~59%.		
Limit of SAR (W/kg)	1 g Average	
	1.6	
Test Case	Measurement Result (W/kg)	
	1 g Average (W/kg)	Power level (dBm)
Left head, Touch cheek, Bottom Channel	0.568	31.93
Left head, Touch cheek, Mid Channel	0.531	31.65
Left head, Touch cheek, Top Channel	0.464	31.12
Left head, Tilt 15 Degree, Bottom Channel	0.317	31.93
Left head, Tilt 15 Degree, Mid Channel	0.280	31.65
Left head, Tilt 15 Degree, Top Channel	0.271	31.12
Right head, Touch cheek, Bottom Channel	0.548	31.93
Right head, Touch cheek, Mid Channel	0.493	31.65
Right head, Touch cheek, Top Channel	0.465	31.12
Right head, Tilt 15 Degree, Bottom Channel	0.521	31.93
Right head, Tilt 15 Degree, Mid Channel	0.407	31.65
Right head, Tilt 15 Degree, Top Channel	0.328	31.12

Table 4: SAR Values (GSM 1900MHz Band), Measured against the head.

Temperature: 23.0 °C ~23.8°C, humidity: 54~59%.		
Limit of SAR (W/kg)	1 g Average	
	1.6	
Test Case	Measurement Result (W/kg)	
	1 g Average (W/kg)	Power level (dBm)
Left head, Touch cheek, Bottom Channel	0.401	31.34
Left head, Touch cheek, Mid Channel	0.388	31.84
Left head, Touch cheek, Top Channel	0.431	32.98
Left head, Tilt 15 Degree, Bottom Channel	0.064	31.34
Left head, Tilt 15 Degree, Mid Channel	0.087	31.84
Left head, Tilt 15 Degree, Top Channel	0.091	32.98
Right head, Touch cheek, Bottom Channel	0.224	31.34
Right head, Touch cheek, Mid Channel	0.573	31.84
Right head, Touch cheek, Top Channel	0.662	32.98
Right head, Tilt 15 Degree, Bottom Channel	0.089	31.34
Right head, Tilt 15 Degree, Mid Channel	0.112	31.84
Right head, Tilt 15 Degree, Top Channel	0.128	32.98



Table 5: SAR Values (GSM 850 MHz Band), Measured against the body

Temperature: 23.0 °C ~23.8°C, humidity: 48~58%.		
Limit of SAR (W/kg)	1 g Average	
	1.6	
Test Case	Measurement Result (W/kg)	
	1 g Average (W/kg)	Power level (dBm)
Side, Bottom Channel	0.243	31.93
Side, Mid Channel	0.194	31.65
Side , Top Channel	0.181	31.12
Side , Bottom Channel(Face to Bottom)	0.353	31.93
Side , Bottom Channel(With Headphone)	0.298	31.93

Table 6: SAR Values (GSM1900 MHz Band), Measured against the body

Temperature: 21.0~21.9° C, humidity: 48~58%.		
Limit of SAR (W/kg)	1 g Average	
	1.6	
Test Case	Measurement Result (W/kg)	
	1 g Average (W/kg)	Power level (dBm)
Side, Bottom Channel	0.174	31.34
Side, Mid Channel	0.228	31.84
Side , Top Channel	0.234	32.98
Side , Top Channel(face to bottom)	0.317	32.98
Side , Top Channel(With Headphone)	0.408	32.98



7.3 Conclusion

Localized Specific Absorption Rate (SAR) of this portable wireless device has been measured in all cases requested by the relevant standards cited in Clause 5.2 of this report. Maximum localized SAR is **below** exposure limits specified in the relevant standards cited in Clause 5.1 of this test report.

8 Measurement Uncertainty

No	Uncertainty Component	Type	Uncertainty Value (%)	Probability Distribution	k	c_i	Standard Uncertainty (%) $u_i(\%)$	Degree of freedom V_{eff} or v_i
Measurement System								
1	–Probe Calibration	B	3.6	N	1	1	3.60	∞
2	–Axial isotropy	B	4.23	R	$\sqrt{3}$	$\sqrt{1-cp}$	0.00	∞
3	–Hemispherical Isotropy	B	10.7	R	$\sqrt{3}$	\sqrt{cp}	6.18	∞
4	–Boundary Effect	B	1.7	R	$\sqrt{3}$	1	0.98	∞
5	–Linearity	B	2.98	R	$\sqrt{3}$	1	1.69	∞
6	–System Detection Limits	B	1.00	R	$\sqrt{3}$	1	0.60	∞
7	–Readout Electronics	B	1.00	N	1	1	1.00	∞
8	–Response Time	B	0.80	R	$\sqrt{3}$	1	0.50	∞
9	–Integration Time	B	2.60	R	$\sqrt{3}$	1	1.50	∞
10	–RF Ambient Conditions	B	3.00	R	$\sqrt{3}$	1	1.70	∞
11	–Probe Position Mechanical tolerance	B	1.14	R	$\sqrt{3}$	1	0.33	∞
12	–Probe Position with respect to Phantom Shell	B	2.86	R	$\sqrt{3}$	1	0.83	∞
13	–Extrapolation, Interpolation and Integration Algorithms for Max. SAR evaluation	B	3.6	R	$\sqrt{3}$	1	2.08	∞
Uncertainties of the DUT								
14	–Position of the DUT	A	2.90	N	1	1	2.90	0
15	–Holder of the DUT	A	3.60	N	1	1	3.60	0
16	–Output Power Variation – SAR drift measurement	B	5.0	R	$\sqrt{3}$	1	2.89	∞



No. SAR07-011

Phantom and Tissue Parameters								
17	–Phantom Uncertainty(shape and thickness tolerances)	B	1.43	R	$\sqrt{3}$	1	0.83	∞
18	–Liquid Conductivity Target – tolerance	B	5.0	R	$\sqrt{3}$	0.7	2.02	∞
19	–Liquid Conductivity – measurement Uncertainty)	B	2.0	R	$\sqrt{3}$	0.7	0.81	∞
20	–Liquid Permittivity Target tolerance	B	5.0	R	$\sqrt{3}$	0.6	1.73	∞
21	–Liquid Permittivity – measurement uncertainty	B	1.0	R	$\sqrt{3}$	0.6	0.35	∞
Combined Standard Uncertainty					RSS			±8.95%
Expanded uncertainty (Confidence interval of 95 %)					K= 2.003935			±17.9%

9 MAIN TEST INSTRUMENTS

No.	EQUIPMENT	TYPE	Due Date
1	E-Field SAR Probe	IXP-050 (SN 0177)	2007-03-28
2	Six-axis AC Servo industrial robot	RV-2A (SN AN406018)	2007-03-28
3	Mobile Phone Tester	4405 (SN 0811211)	2007-03-28
4	System Validation Dipole 1900MHz	IXD-080 (SN 0112)	2007-03-28
5	Probe Amplifier and PC Interface	IFA-010 (SN 0027)	2007-03-28
6	SAM Head Phantom	SN 0380 SH	2007-03-28
7	SAM Head Phantom	SN 0381 SH	2007-03-28
8	Box Phantom	IXB-070	2007-03-28



ANNEX A
of
ShenZhen Electronic Product Quality Testing Center
CONFORMANCE TEST REPORT FOR
HUMAN EXPOSURE TO ELECTROMAGNETIC FIELDS

SAR07-011
QINGDAO HAIER TELECOM CO., LTD.
GSM
Accreditation Certificate

This Annex consists of 2 pages
Date of Report: 2007-03-13





**ACCREDITATION CERTIFICATE
OF CHINA NATIONAL ACCREDITATION BOARD
FOR LABORATORIES
(No.L1659)**

This is to certify that

Shenzhen Electronic Product Quality Testing Center
Electronic Testing Building, Shahe Road, Xili, Nanshan District,
Shenzhen, Guangdong, China

has been assessed and proved to be in compliance with CNAL/AC01:
2003 Accreditation Criteria for Testing and Calibration Laboratories
(identical to ISO/IEC17025: 1999 *General Requirements for the
Competence of Testing and Calibration Laboratories*).

Accreditation scope of the laboratory is listed in the attachment.

Date of Issue: 2004.10.09

Date of Expiry: 2009.10.08

Wei Hao

Secretary General of CNAL



ANNEX B
of
ShenZhen Electronic Product Quality Testing Center

CONFORMANCE TEST REPORT FOR
HUMAN EXPOSURE TO ELECTROMAGNETIC FIELDS

SAR07-011

QINGDAO HAIER TELECOM CO., LTD.

GSM

Type Name: HG-A7I

Hardware Version: P1
Software Version: H01-S003-NA

TEST LAYOUT

This Annex consists of 7 pages
Date of Report: 2007-03-13





Fig.1 SARA2 System Test Layout



Fig.2 The depth of head tissue in SAM



Fig.3 EUT Left Head Touch Cheek Position



Fig.4 EUT Left Head Tilt15 Position



Fig.5 EUT Right Head Touch Cheek Position



Fig.6 EUT Right Head Tilt15 Position



Fig.7 spacer 1.5cm

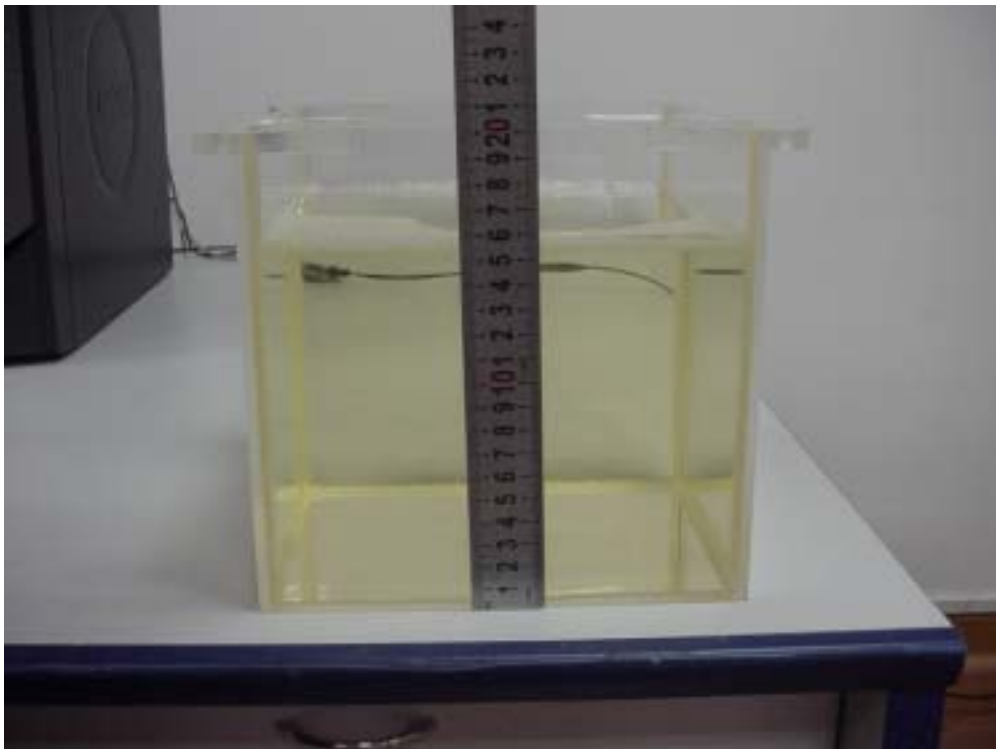

Fig.8 the depth of body tissue

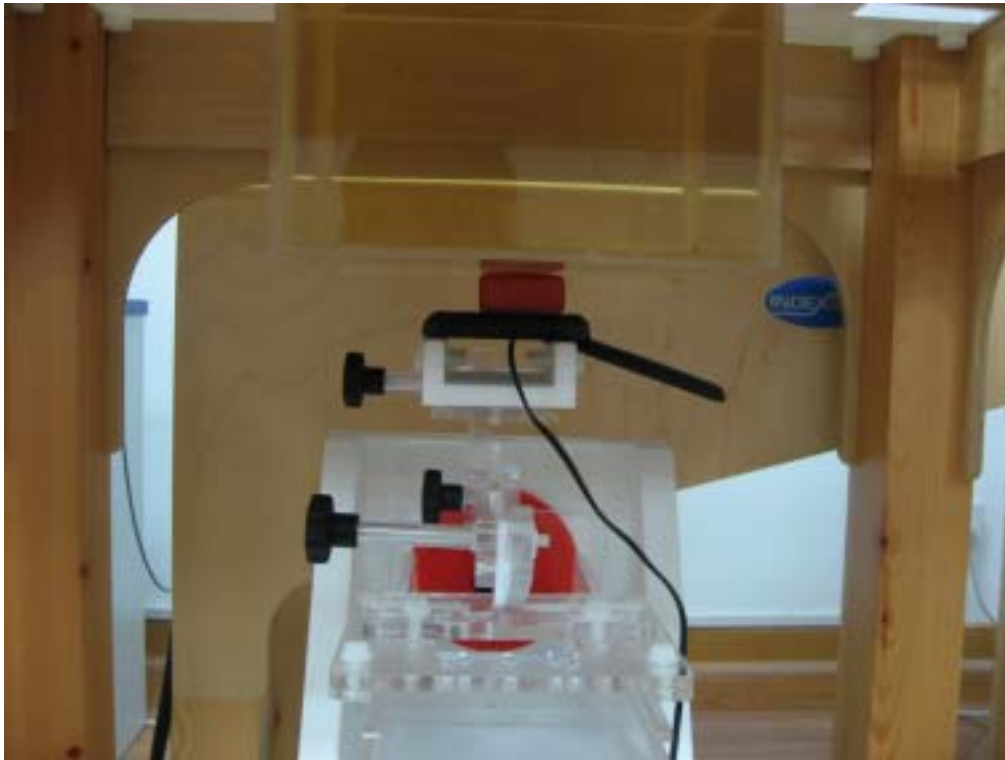

Fig.10 Side Position

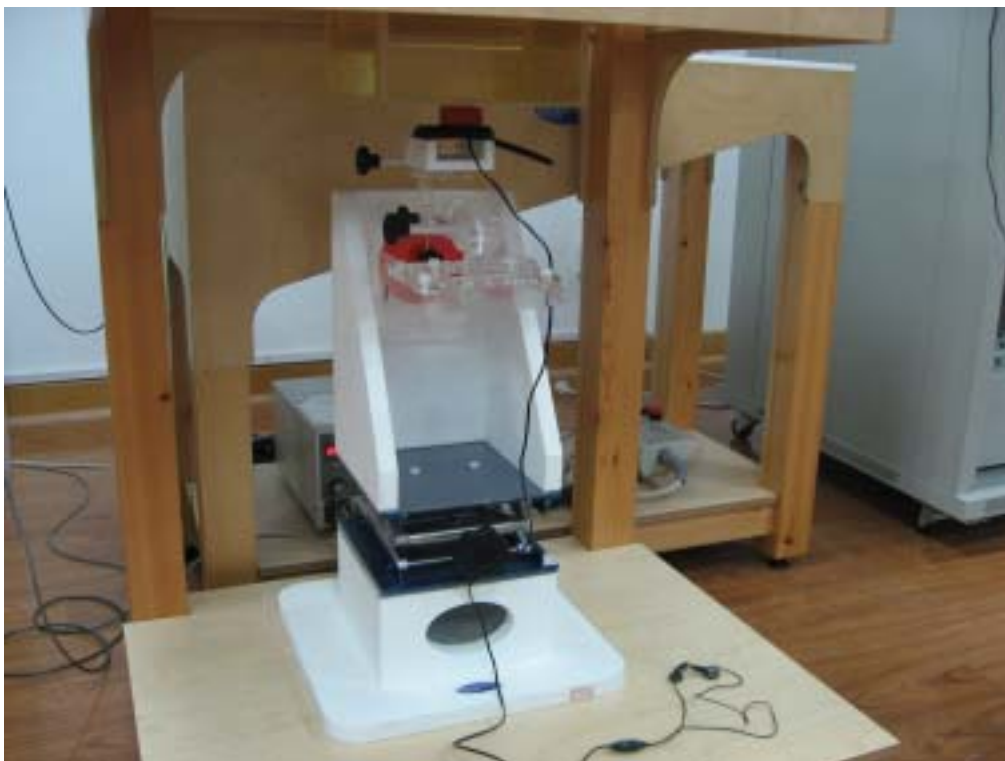

Fig.10 Side Position WITH HEADPHONE



ANNEX C
of
ShenZhen Electronic Product Quality Testing Center

CONFORMANCE TEST REPORT FOR
HUMAN EXPOSURE TO ELECTROMAGNETIC FIELDS

SAR07-011

QINGDAO HAIER TELECOM CO., LTD.

GSM

Type Name: HG-A7I

Hardware Version: P1

Software Version: H01-S003-NA.

Sample Photographs

This Annex consists of 5 pages

Date of Report: 2007-03-13



No. SAR07-011

Photograph of the Equipment under Test1.

1. Appearance of the EUT



No. SAR07-011

2. Inside of the EUT





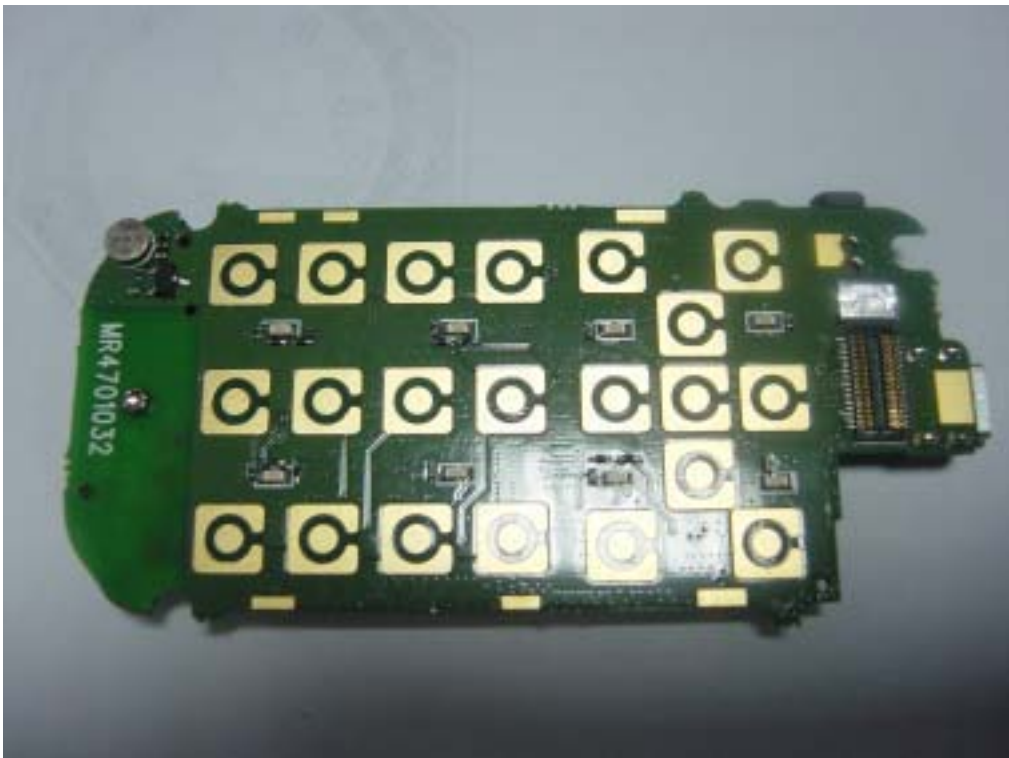



ANNEX D
of
ShenZhen Electronic Product Quality Testing Center
CONFORMANCE TEST REPORT FOR
HUMAN EXPOSURE TO ELECTROMAGNETIC FIELDS

SAR07-011

QINGDAO HAIER TELECOM CO., LTD.

GSM

Type Name: HG-A7I

Hardware Version: P1
Software Version: H01-S003-NA

Graph Test Results

This Annex consists of 35 pages
Date of Report: 2007-03-13



SAR Test GSM 850 LH_TouchCheek (Top Channel)

System / software:	SARA2 / 2.40 VPM	Input Power Drift:	0.01dB
Date / Time:	2007-2-12 10:26:30	DUT Battery Model/No:	
Filename:	HG-A7_850_LH_TOUCHC HEEK_T.txt	Probe Serial Number:	0177
Ambient Temperature:	20.0°C	Liquid Simulant:	HEAD tissue
Device Under Test:	HG-A7	Relative Permittivity:	41.58
Relative Humidity:	44%	Conductivity:	.902
Phantom S/No:	Head_381SH.csv	Liquid Temperature:	20.1°C
Phantom Rotation:	0°	Max SAR Y-axis Location:	-57.00 mm
DUT Position:	HG-A7_LH_TOUCHCHEEK_T	Max SAR Z-axis Location:	-164.50 mm
Antenna Configuration:	BUILD INSIDE	Max E Field:	23.17 V/m
Test Frequency:	850MHz	SAR 1g:	0.464 W/kg
Air Factors:	417.2 / 368.0 / 414.8	SAR 10g:	0.362 W/kg
Conversion Factors:	.287 / .287 / .287	SAR Start:	0.360 W/kg
Type of Modulation:	GMSK	SAR End:	0.366 W/kg
Modn. Duty Cycle:	8	SAR Drift during Scan:	1.42 %
Diode Compression Factors (V*200):	20 / 20 / 20	Probe battery last changed:	20/05/05
Input Power Level:	33dBm	Extrapolation:	poly4

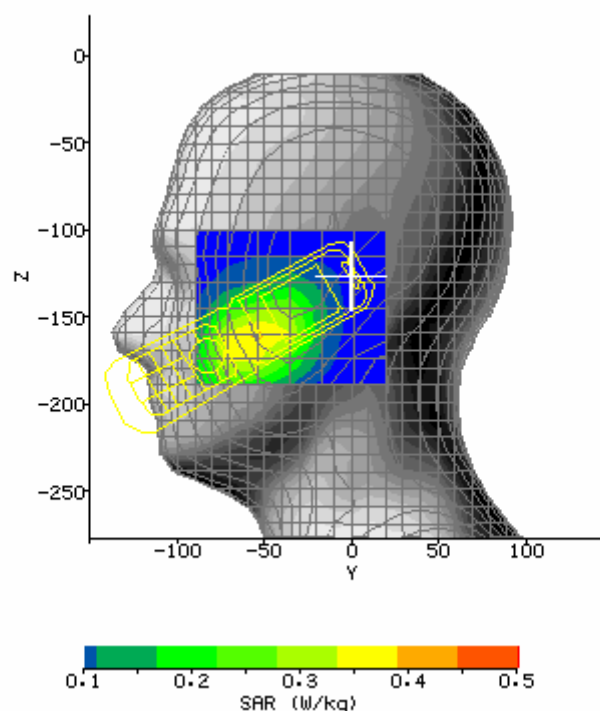

SAR Test GSM 850 LH_TouchCheek (Middle Channel)

System / software:	SARA2 / 2.40 VPM	Input Power Drift:	0.01dB
Date / Time:	2007-2-12 10:37:06	DUT Battery Model/No:	
Filename:	HG-A7_850_LH_TOUCHC HEEK_M.txt	Probe Serial Number:	0177
Ambient Temperature:	20.0°C	Liquid Simulant:	HEAD tissue
Device Under Test:	HG-A7	Relative Permittivity:	41.58
Relative Humidity:	44%	Conductivity:	.902
Phantom S/No:	Head_381SH.csv	Liquid Temperature:	20.1°C
Phantom Rotation:	0°	Max SAR Y-axis Location:	-55.17 mm
DUT Position:	HG-A7_LH_TOUCHCHEEK _M	Max SAR Z-axis Location:	-164.50 mm
Antenna Configuration:	BUILD INSIDE	Max E Field:	25.64 V/m
Test Frequency:	850MHz	SAR 1g:	0.531 W/kg
Air Factors:	417.2 / 368.0 / 414.8	SAR 10g:	0.413 W/kg
Conversion Factors:	.287 / .287 / .287	SAR Start:	0.414 W/kg
Type of Modulation:	GMSK	SAR End:	0.419 W/kg
Modn. Duty Cycle:	8	SAR Drift during Scan:	1.28 %
Diode Compression Factors (V*200):	20 / 20 / 20	Probe battery last changed:	20/05/05
Input Power Level:	33dBm	Extrapolation:	poly4

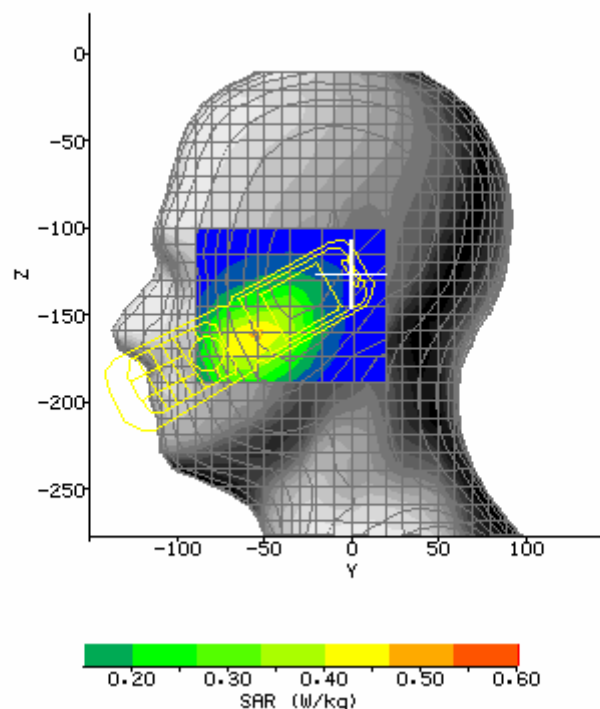

SAR Test GSM 850 LH_TouchCheek (Bottom Channel)

System / software:	SARA2 / 2.40 VPM	Input Power Drift:	0.01dB
Date / Time:	2007-2-12 10:47:44	DUT Battery Model/No:	
Filename:	HG-A7_850_LH_TOUCHC HEEK_B.txt	Probe Serial Number:	0177
Ambient Temperature:	20.0°C	Liquid Simulant:	HEAD tissue
Device Under Test:	HG-A7	Relative Permittivity:	41.58
Relative Humidity:	44%	Conductivity:	.902
Phantom S/No:	Head_381SH.csv	Liquid Temperature:	20.1°C
Phantom Rotation:	0°	Max SAR Y-axis Location:	-53.33 mm
DUT Position:	HG-A7_LH_TOUCHCHEEK _B	Max SAR Z-axis Location:	-163.00 mm
Antenna Configuration:	BUILD INSIDE	Max E Field:	25.70 V/m
Test Frequency:	850MHz	SAR 1g:	0.568 W/kg
Air Factors:	417.2 / 368.0 / 414.8	SAR 10g:	0.445 W/kg
Conversion Factors:	.287 / .287 / .287	SAR Start:	0.439 W/kg
Type of Modulation:	GMSK	SAR End:	0.452 W/kg
Modn. Duty Cycle:	8	SAR Drift during Scan:	2.97 %
Diode Compression Factors (V*200):	20 / 20 / 20	Probe battery last changed:	20/05/05
Input Power Level:	33dBm	Extrapolation:	poly4

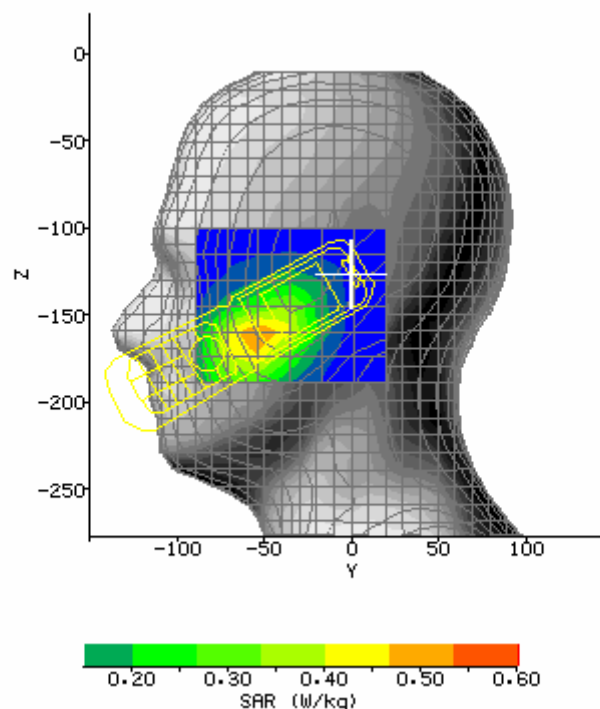

SAR Test GSM 850 LH_Tilt15 (Top Channel)

System / software:	SARA2 / 2.40 VPM	Input Power Drift:	0.01dB
Date / Time:	2007-2-12 11:27:03	DUT Battery Model/No:	
Filename:	HG-A7_850_LH_TILT15_T.txt	Probe Serial Number:	0177
Ambient Temperature:	20.0°C	Liquid Simulant:	HEAD tissue
Device Under Test:	HG-A7	Relative Permittivity:	41.58
Relative Humidity:	44%	Conductivity:	.902
Phantom S/No:	Head_381SH.csv	Liquid Temperature:	20.1°C
Phantom Rotation:	0°	Max SAR Y-axis Location:	-36.83 mm
DUT Position:	HG-A7_LH_TILT15_T	Max SAR Z-axis Location:	-146.50 mm
Antenna Configuration:	BUILD INSIDE	Max E Field:	17.45 V/m
Test Frequency:	850MHz	SAR 1g:	0.271 W/kg
Air Factors:	417.2 / 368.0 / 414.8	SAR 10g:	0.223 W/kg
Conversion Factors:	.287 / .287 / .287	SAR Start:	0.238 W/kg
Type of Modulation:	GMSK	SAR End:	0.240 W/kg
Modn. Duty Cycle:	8	SAR Drift during Scan:	1.66 %
Diode Compression Factors (V*200):	20 / 20 / 20	Probe battery last changed:	20/05/05
Input Power Level:	33dBm	Extrapolation:	poly4

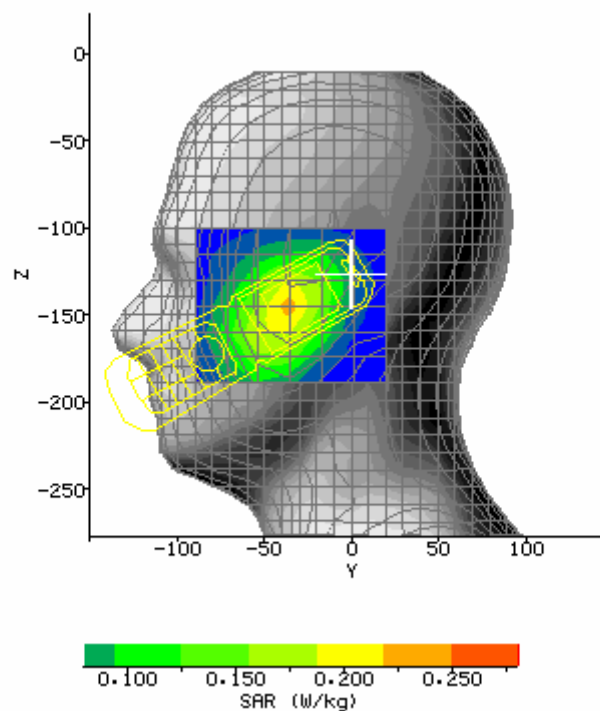



SAR Test GSM 850 LH_Tilt15 (Middle Channel)

System / software:	SARA2 / 2.40 VPM	Input Power Drift:	0.00dB
Date / Time:	2007-2-12 11:15:46	DUT Battery Model/No:	
Filename:	HG-A7_850_LH_TILT15_M.txt	Probe Serial Number:	0177
Ambient Temperature:	20.0°C	Liquid Simulant:	HEAD tissue
Device Under Test:	HG-A7	Relative Permittivity:	41.58
Relative Humidity:	44%	Conductivity:	.902
Phantom S/No:	Head_381SH.csv	Liquid Temperature:	20.1°C
Phantom Rotation:	0°	Max SAR Y-axis Location:	-38.67 mm
DUT Position:	HG-A7_LH_TILT15_M	Max SAR Z-axis Location:	-149.50 mm
Antenna Configuration:	BUILD INSIDE	Max E Field:	17.31 V/m
Test Frequency:	850MHz	SAR 1g:	0.280 W/kg
Air Factors:	417.2 / 368.0 / 414.8	SAR 10g:	0.221 W/kg
Conversion Factors:	.287 / .287 / .287	SAR Start:	0.225 W/kg
Type of Modulation:	GMSK	SAR End:	0.223 W/kg
Modn. Duty Cycle:	8	SAR Drift during Scan:	-0.56 %
Diode Compression Factors (V*200):	20 / 20 / 20	Probe battery last changed:	20/05/05
Input Power Level:	33dBm	Extrapolation:	poly4

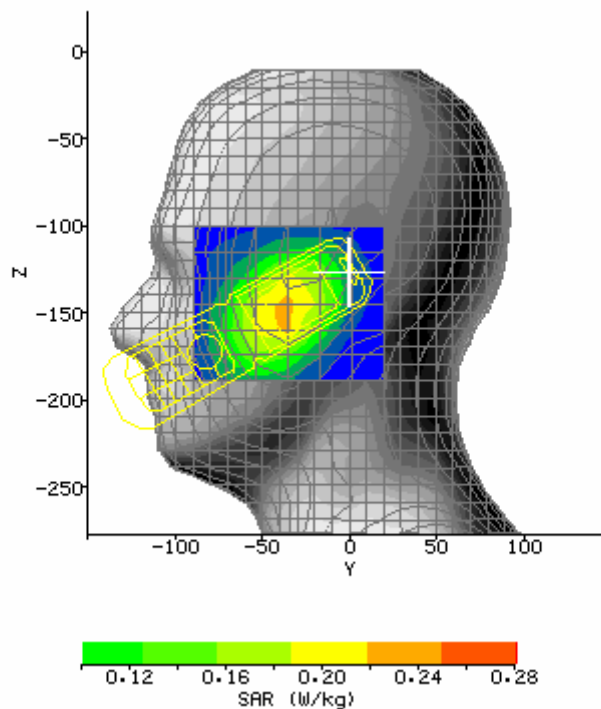



SAR Test GSM 850 LH_Tilt15 (Bottom Channel)

System / software:	SARA2 / 2.40 VPM	Input Power Drift:	0.01dB
Date / Time:	2007-2-12 10:59:26	DUT Battery Model/No:	
Filename:	HG-A7_850_LH_TILT15_B.txt	Probe Serial Number:	0177
Ambient Temperature:	20.0°C	Liquid Simulant:	HEAD tissue
Device Under Test:	HG-A7	Relative Permittivity:	41.58
Relative Humidity:	44%	Conductivity:	.902
Phantom S/No:	Head_381SH.csv	Liquid Temperature:	20.1°C
Phantom Rotation:	0°	Max SAR Y-axis Location:	-36.83 mm
DUT Position:	HG-A7_LH_TILT15_B	Max SAR Z-axis Location:	-148.00 mm
Antenna Configuration:	BUILD INSIDE	Max E Field:	18.84 V/m
Test Frequency:	850MHz	SAR 1g:	0.317 W/kg
Air Factors:	417.2 / 368.0 / 414.8	SAR 10g:	0.244 W/kg
Conversion Factors:	.287 / .287 / .287	SAR Start:	0.234 W/kg
Type of Modulation:	GMSK	SAR End:	0.232 W/kg
Modn. Duty Cycle:	8	SAR Drift during Scan:	-0.99 %
Diode Compression Factors (V*200):	20 / 20 / 20	Probe battery last changed:	20/05/05
Input Power Level:	33dBm	Extrapolation:	poly4

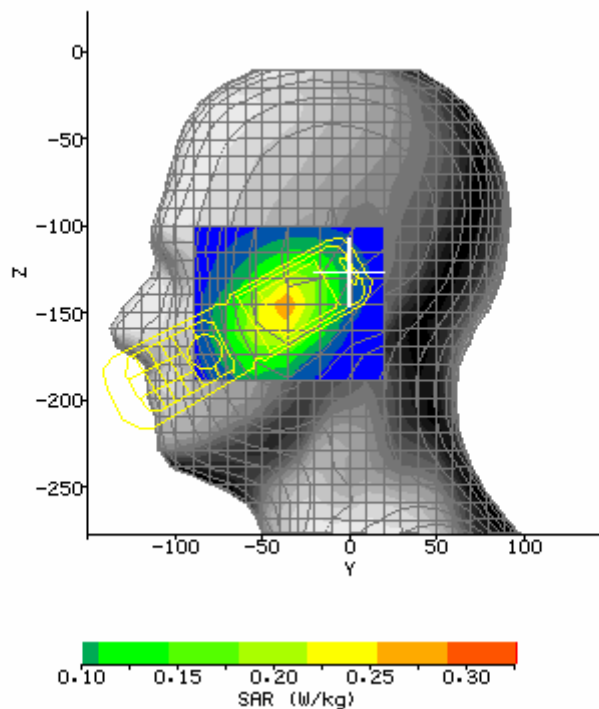



SAR Test GSM 850 RH_TouchCheek (Top Channel)

System / software:	SARA2 / 2.40 VPM	Input Power Drift:	0.02dB
Date / Time:	2007-2-12 9:07:12	DUT Battery Model/No:	
Filename:	HG-A7_850_RH_TOUCHC HEEK_T.txt	Probe Serial Number:	0177
Ambient Temperature:	20.0°C	Liquid Simulant:	HEAD tissue
Device Under Test:	HG-A7	Relative Permittivity:	41.58
Relative Humidity:	44%	Conductivity:	.902
Phantom S/No:	Head_381SH.csv	Liquid Temperature:	20.1°C
Phantom Rotation:	180°	Max SAR Y-axis Location:	57.00 mm
DUT Position:	HG-A7_RH_TOUCHCHEE K_T	Max SAR Z-axis Location:	-160.00 mm
Antenna Configuration:	BUILD INSIDE	Max E Field:	23.32 V/m
Test Frequency:	850MHz	SAR 1g:	0.465 W/kg
Air Factors:	417.2 / 368.0 / 414.8	SAR 10g:	0.367 W/kg
Conversion Factors:	.287 / .287 / .287	SAR Start:	0.389 W/kg
Type of Modulation:	GMSK	SAR End:	0.376 W/kg
Modn. Duty Cycle:	8	SAR Drift during Scan:	-3.47 %
Diode Compression Factors (V*200):	20 / 20 / 20	Probe battery last changed:	20/05/05
Input Power Level:	33dBm	Extrapolation:	poly4

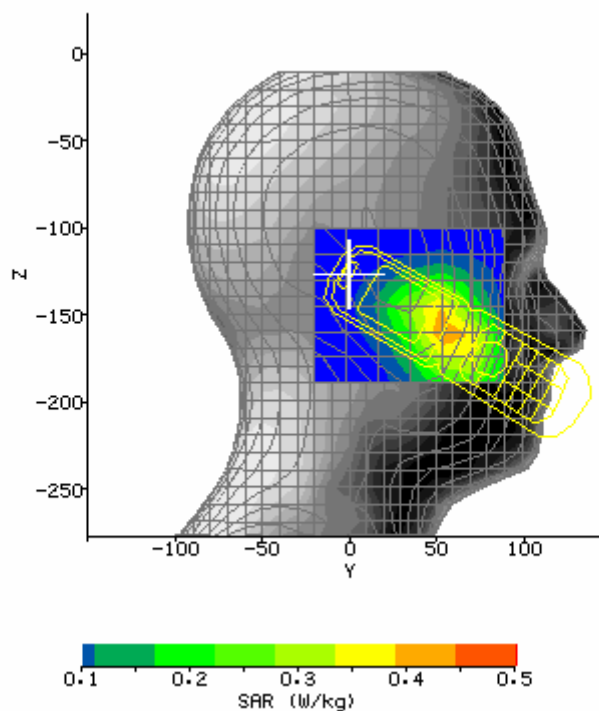

SAR Test GSM 850 RH_TouchCheek (Middle Channel)

System / software:	SARA2 / 2.40 VPM	Input Power Drift:	0.01dB
Date / Time:	2007-2-12 9:18:38	DUT Battery Model/No:	
Filename:	HG-A7_850_RH_TOUCHC HEEK_M.txt	Probe Serial Number:	0177
Ambient Temperature:	20.0°C	Liquid Simulant:	HEAD tissue
Device Under Test:	HG-A7	Relative Permittivity:	41.58
Relative Humidity:	44%	Conductivity:	.902
Phantom S/No:	Head_381SH.csv	Liquid Temperature:	20.1°C
Phantom Rotation:	180°	Max SAR Y-axis Location:	58.83 mm
DUT Position:	HG-A7_RH_TOUCHCHEE K_M	Max SAR Z-axis Location:	-161.50 mm
Antenna Configuration:	BUILD INSIDE	Max E Field:	24.24 V/m
Test Frequency:	850MHz	SAR 1g:	0.493 W/kg
Air Factors:	417.2 / 368.0 / 414.8	SAR 10g:	0.394 W/kg
Conversion Factors:	.287 / .287 / .287	SAR Start:	0.426 W/kg
Type of Modulation:	GMSK	SAR End:	0.430 W/kg
Modn. Duty Cycle:	8	SAR Drift during Scan:	1.04 %
Diode Compression Factors (V*200):	20 / 20 / 20	Probe battery last changed:	20/05/05
Input Power Level:	33dBm	Extrapolation:	poly4

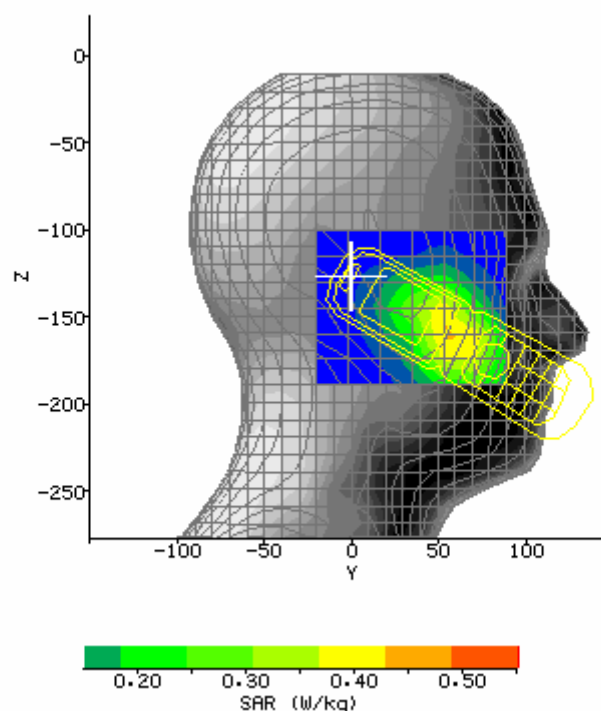

SAR Test GSM 850 RH_TouchCheek (Bottom Channel)

System / software:	SARA2 / 2.40 VPM	Input Power Drift:	0.01dB
Date / Time:	2007-2-12 9:29:05	DUT Battery Model/No:	
Filename:	HG-A7_850_RH_TOUCHC HEEK_B.txt	Probe Serial Number:	0177
Ambient Temperature:	20.0°C	Liquid Simulant:	HEAD tissue
Device Under Test:	HG-A7	Relative Permittivity:	41.58
Relative Humidity:	44%	Conductivity:	.902
Phantom S/No:	Head_381SH.csv	Liquid Temperature:	20.1°C
Phantom Rotation:	180°	Max SAR Y-axis Location:	57.00 mm
DUT Position:	HG-A7_RH_TOUCHCHEE K_B	Max SAR Z-axis Location:	-160.00 mm
Antenna Configuration:	BUILD INSIDE	Max E Field:	27.42 V/m
Test Frequency:	850MHz	SAR 1g:	0.548 W/kg
Air Factors:	417.2 / 368.0 / 414.8	SAR 10g:	0.503 W/kg
Conversion Factors:	.287 / .287 / .287	SAR Start:	0.565 W/kg
Type of Modulation:	GMSK	SAR End:	0.570 W/kg
Modn. Duty Cycle:	8	SAR Drift during Scan:	1.77 %
Diode Compression Factors (V*200):	20 / 20 / 20	Probe battery last changed:	20/05/05
Input Power Level:	33dBm	Extrapolation:	poly4

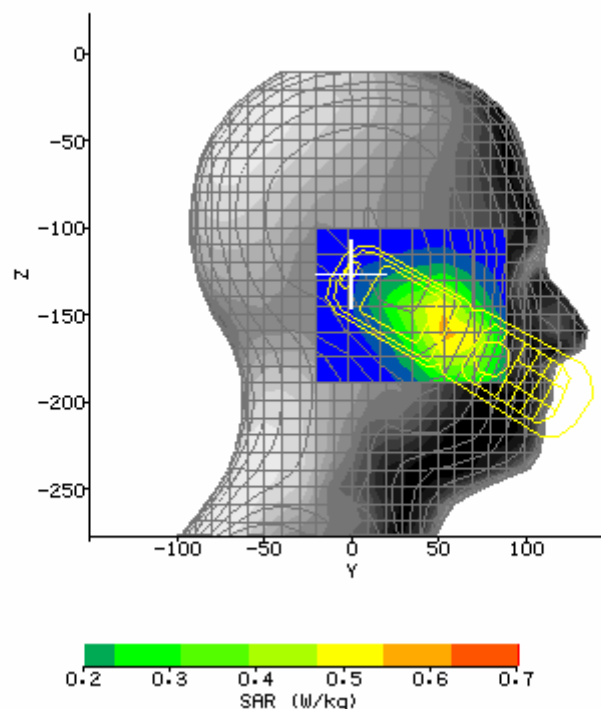

SAR Test GSM 850 RH_Tilt15 (Top Channel)

System / software:	SARA2 / 2.40 VPM	Input Power Drift:	0.00dB
Date / Time:	2007-2-12 10:08:20	DUT Battery Model/No:	
Filename:	HG-A7_850_RH_TILT15_T.txt	Probe Serial Number:	0177
Ambient Temperature:	20.0°C	Liquid Simulant:	HEAD tissue
Device Under Test:	HG-A7	Relative Permittivity:	41.58
Relative Humidity:	44%	Conductivity:	.902
Phantom S/No:	Head_381SH.csv	Liquid Temperature:	20.1°C
Phantom Rotation:	180°	Max SAR Y-axis Location:	33.17 mm
DUT Position:	HG-A7_RH_TILT15_T	Max SAR Z-axis Location:	-149.50 mm
Antenna Configuration:	BUILD INSIDE	Max E Field:	19.31 V/m
Test Frequency:	850MHz	SAR 1g:	0.328 W/kg
Air Factors:	417.2 / 368.0 / 414.8	SAR 10g:	0.280 W/kg
Conversion Factors:	.287 / .287 / .287	SAR Start:	0.307 W/kg
Type of Modulation:	GMSK	SAR End:	0.304 W/kg
Modn. Duty Cycle:	8	SAR Drift during Scan:	-0.88 %
Diode Compression Factors (V*200):	20 / 20 / 20	Probe battery last changed:	20/05/05
Input Power Level:	33dBm	Extrapolation:	poly4

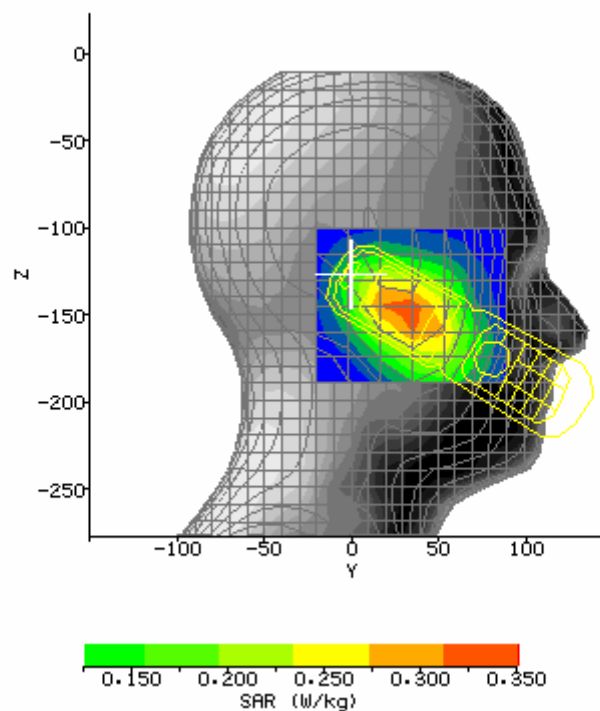

SAR Test GSM 850 RH_Tilt15 (Middle Channel)

System / software:	SARA2 / 2.40 VPM	Input Power Drift:	0.00dB
Date / Time:	2007-2-12 9:57:09	DUT Battery Model/No:	
Filename:	HG-A7_850_RH_TILT15_M.txt	Probe Serial Number:	0177
Ambient Temperature:	20.0°C	Liquid Simulant:	HEAD tissue
Device Under Test:	HG-A7	Relative Permittivity:	41.58
Relative Humidity:	44%	Conductivity:	.902
Phantom S/No:	Head_381SH.csv	Liquid Temperature:	20.1°C
Phantom Rotation:	180°	Max SAR Y-axis Location:	33.17 mm
DUT Position:	HG-A7_RH_TILT15_M	Max SAR Z-axis Location:	-148.00 mm
Antenna Configuration:	BUILD INSIDE	Max E Field:	21.87 V/m
Test Frequency:	850MHz	SAR 1g:	0.407 W/kg
Air Factors:	417.2 / 368.0 / 414.8	SAR 10g:	0.344 W/kg
Conversion Factors:	.287 / .287 / .287	SAR Start:	0.370 W/kg
Type of Modulation:	GMSK	SAR End:	0.372 W/kg
Modn. Duty Cycle:	8	SAR Drift during Scan:	0.40 %
Diode Compression Factors (V*200):	20 / 20 / 20	Probe battery last changed:	20/05/05
Input Power Level:	33dBm	Extrapolation:	poly4

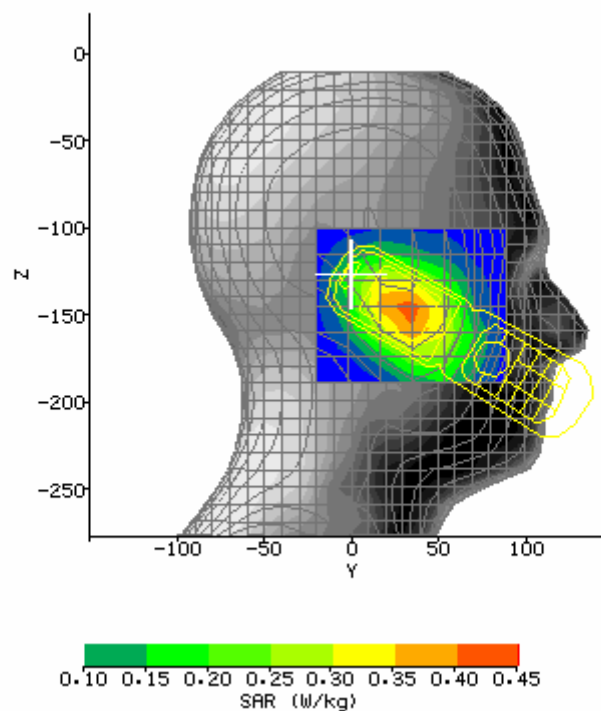



SAR Test GSM 850 RH_Tilt15 (Bottom Channel)

System / software:	SARA2 / 2.40 VPM	Input Power Drift:	0.00dB
Date / Time:	2007-2-12 9:45:48	DUT Battery Model/No:	
Filename:	HG-A7_850_RH_TILT15_B.txt	Probe Serial Number:	0177
Ambient Temperature:	20.0°C	Liquid Simulant:	HEAD tissue
Device Under Test:	HG-A7	Relative Permittivity:	41.58
Relative Humidity:	44%	Conductivity:	.902
Phantom S/No:	Head_381SH.csv	Liquid Temperature:	20.1°C
Phantom Rotation:	180°	Max SAR Y-axis Location:	29.50 mm
DUT Position:	HG-A7_RH_TILT15_B	Max SAR Z-axis Location:	-146.50 mm
Antenna Configuration:	BUILD INSIDE	Max E Field:	24.47 V/m
Test Frequency:	850MHz	SAR 1g:	0.521 W/kg
Air Factors:	417.2 / 368.0 / 414.8	SAR 10g:	0.425 W/kg
Conversion Factors:	.287 / .287 / .287	SAR Start:	0.439 W/kg
Type of Modulation:	GMSK	SAR End:	0.438 W/kg
Modn. Duty Cycle:	8	SAR Drift during Scan:	-0.09 %
Diode Compression Factors (V*200):	20 / 20 / 20	Probe battery last changed:	20/05/05
Input Power Level:	33dBm	Extrapolation:	poly4

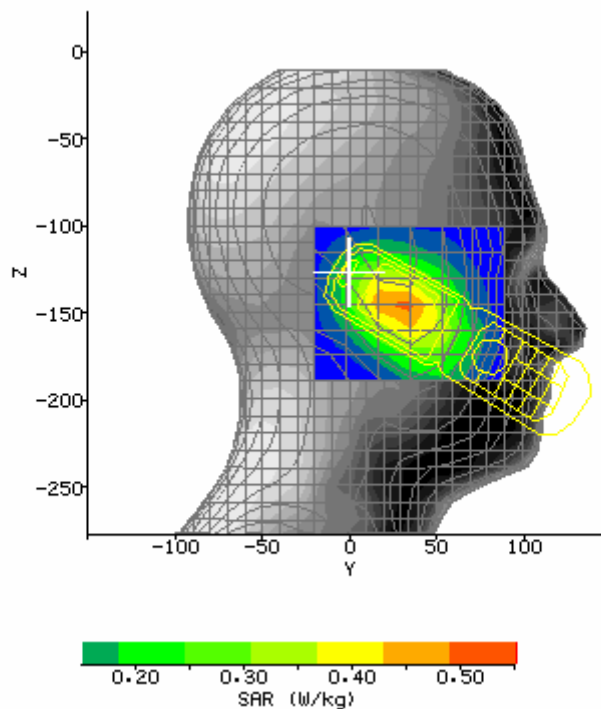

SAR Test GSM 850 Side (Top Channel)

System / software:	SARA2 / 2.40 VPM	Input Power Drift:	0.02dB
Date / Time:	2007-2-13 14:08:53	DUT Battery Model/No:	
Filename:	HG- A7_850_BODY_T.txt	Probe Serial Number:	0177
Ambient Temperature:	21.3°C	Liquid Simulant:	Body tissue
Device Under Test:	HG-A7	Relative Permittivity:	55.47
Relative Humidity:	54%	Conductivity:	.972
Phantom S/No:	HeadBox75mm.csv	Liquid Temperature:	21.4°C
Phantom Rotation:	0°	Max SAR X-axis Location:	6.86 mm
DUT Position:	BODY	Max SAR Y-axis Location:	10.29 mm
Antenna Configuration:	BUILD INSIDE	Max E Field:	13.37 V/m
Test Frequency:	850MHz	SAR 1g:	0.181 W/kg
Air Factors:	417 / 368 / 414	SAR 10g:	0.139 W/kg
Conversion Factors:	.271 / .271 / .271	SAR Start:	0.073 W/kg
Type of Modulation:	GMSK	SAR End:	0.076 W/kg
Modn. Duty Cycle:	8	SAR Drift during Scan:	3.53 %
Diode Compression Factors (V*200):	20 / 20 / 20	Probe battery last changed:	20/05/05
Input Power Level:	Max Power	Extrapolation:	poly4

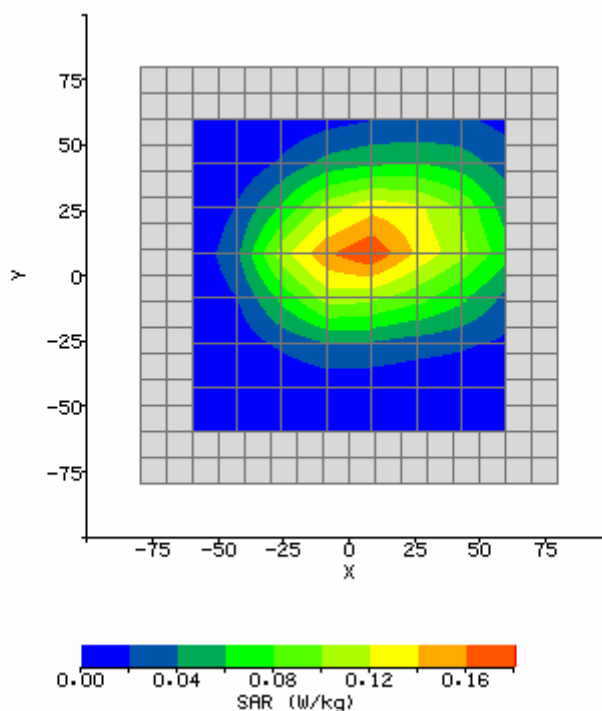

SAR Test GSM 850 Side (Middle Channel)

System / software:	SARA2 / 2.40 VPM	Input Power Drift:	0.01dB
Date / Time:	2007-2-13 14:19:00	DUT Battery Model/No:	
Filename:	HG- A7_850_BODY_M.txt	Probe Serial Number:	0177
Ambient Temperature:	21.3°C	Liquid Simulant:	Body tissue
Device Under Test:	HG-A7	Relative Permittivity:	55.47
Relative Humidity:	54%	Conductivity:	.972
Phantom S/No:	HeadBox75mm.csv	Liquid Temperature:	21.4°C
Phantom Rotation:	0°	Max SAR X-axis Location:	1.71 mm
DUT Position:	BODY	Max SAR Y-axis Location:	8.57 mm
Antenna Configuration:	BUILD INSIDE	Max E Field:	13.38 V/m
Test Frequency:	850MHz	SAR 1g:	0.194 W/kg
Air Factors:	417 / 368 / 414	SAR 10g:	0.141 W/kg
Conversion Factors:	.271 / .271 / .271	SAR Start:	0.070 W/kg
Type of Modulation:	GMSK	SAR End:	0.071 W/kg
Modn. Duty Cycle:	8	SAR Drift during Scan:	1.39 %
Diode Compression Factors (V*200):	20 / 20 / 20	Probe battery last changed:	20/05/05
Input Power Level:	Max Power	Extrapolation:	poly4

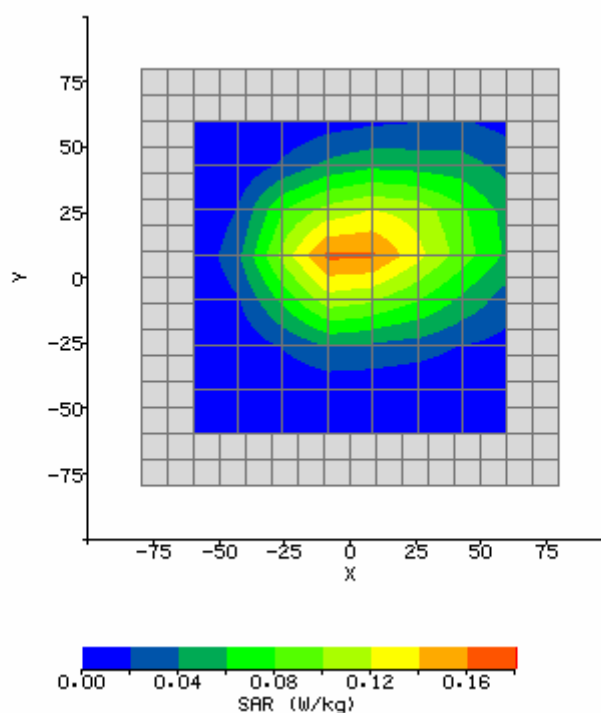

SAR Test GSM 850 Side (Bottom Channel)

System / software:	SARA2 / 2.40 VPM	Input Power Drift:	0.01dB
Date / Time:	2007-2-13 14:28:40	DUT Battery Model/No:	
Filename:	HG- A7_850_BODY_B.txt	Probe Serial Number:	0177
Ambient Temperature:	21.3°C	Liquid Simulant:	Body tissue
Device Under Test:	HG-A7	Relative Permittivity:	55.47
Relative Humidity:	54%	Conductivity:	.972
Phantom S/No:	HeadBox75mm.csv	Liquid Temperature:	21.4°C
Phantom Rotation:	0°	Max SAR X-axis Location:	12.00 mm
DUT Position:	BODY	Max SAR Y-axis Location:	10.29 mm
Antenna Configuration:	BUILD INSIDE	Max E Field:	14.56 V/m
Test Frequency:	850MHz	SAR 1g:	0.243 W/kg
Air Factors:	417 / 368 / 414	SAR 10g:	0.169 W/kg
Conversion Factors:	.271 / .271 / .271	SAR Start:	0.099 W/kg
Type of Modulation:	GMSK	SAR End:	0.100 W/kg
Modn. Duty Cycle:	8	SAR Drift during Scan:	1.08 %
Diode Compression Factors (V*200):	20 / 20 / 20	Probe battery last changed:	20/05/05
Input Power Level:	Max Power	Extrapolation:	poly4

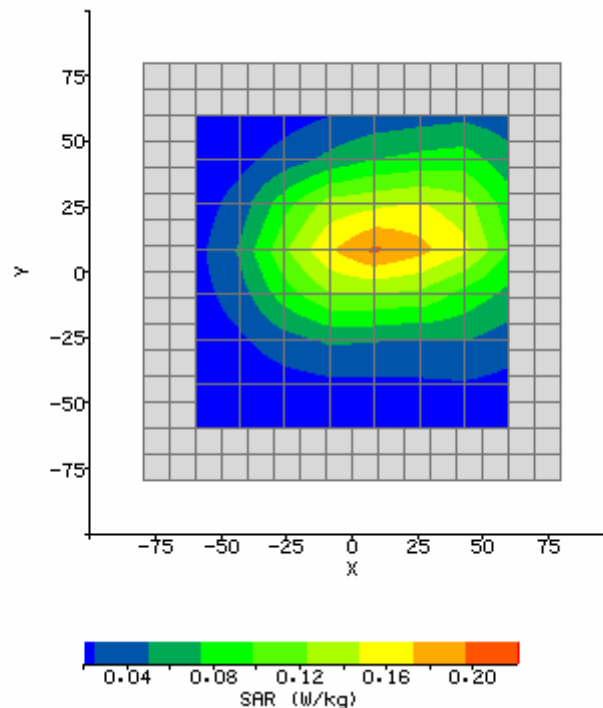

SAR Test GSM 850 Side (Bottom Channel, face to bottom)

System / software:	SARA2 / 2.40 VPM	Input Power Drift:	0.01dB
Date / Time:	2007-2-13 14:49:29	DUT Battery Model/No:	
Filename:	HG- A7_850_BODY_B_FAC ETOBOTTOM.txt	Probe Serial Number:	0177
Ambient Temperature:	21.3°C	Liquid Simulant:	Body tissue
Device Under Test:	HG-A7	Relative Permittivity:	55.47
Relative Humidity:	54%	Conductivity:	.972
Phantom S/No:	HeadBox75mm.csv	Liquid Temperature:	21.4°C
Phantom Rotation:	0°	Max SAR X-axis Location:	20.57 mm
DUT Position:	BODY	Max SAR Y-axis Location:	5.14 mm
Antenna Configuration:	BUILD INSIDE	Max E Field:	17.65 V/m
Test Frequency:	850MHz	SAR 1g:	0.353 W/kg
Air Factors:	417 / 368 / 414	SAR 10g:	0.255 W/kg
Conversion Factors:	.271 / .271 / .271	SAR Start:	0.148 W/kg
Type of Modulation:	GMSK	SAR End:	0.143 W/kg
Modn. Duty Cycle:	8	SAR Drift during Scan:	-2.15 %
Diode Compression Factors (V*200):	20 / 20 / 20	Probe battery last changed:	20/05/05
Input Power Level:	Max Power	Extrapolation:	poly4

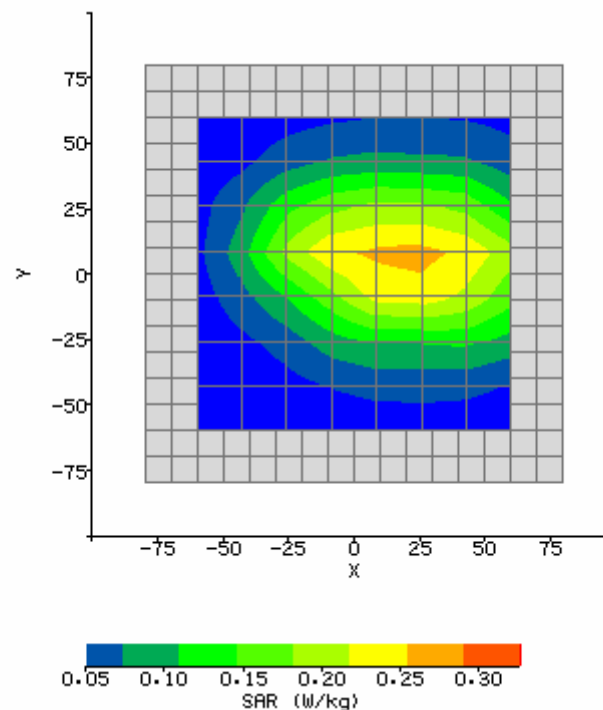

SAR Test GSM 850 Side (Bottom Channel, With Headphone)

System / software:	SARA2 / 2.40 VPM	Input Power Drift:	0.01dB
Date / Time:	2007-2-13 14:39:30	DUT Battery Model/No:	
Filename:	HG-A7_850_BODY_B_WIT HHEADPHONE.txt	Probe Serial Number:	0177
Ambient Temperature:	21.3°C	Liquid Simulant:	Body tissue
Device Under Test:	HG-A7	Relative Permittivity:	55.47
Relative Humidity:	54%	Conductivity:	.972
Phantom S/No:	HeadBox75mm.csv	Liquid Temperature:	21.4°C
Phantom Rotation:	0°	Max SAR X-axis Location:	8.57 mm
DUT Position:	BODY	Max SAR Y-axis Location:	6.86 mm
Antenna Configuration:	BUILD INSIDE	Max E Field:	17.10 V/m
Test Frequency:	850MHz	SAR 1g:	0.298W/kg
Air Factors:	417 / 368 / 414	SAR 10g:	0.216 W/kg
Conversion Factors:	.271 / .271 / .271	SAR Start:	0.123 W/kg
Type of Modulation:	GMSK	SAR End:	0.121 W/kg
Modn. Duty Cycle:	8	SAR Drift during Scan:	-2.01 %
Diode Compression Factors (V*200):	20 / 20 / 20	Probe battery last changed:	20/05/05
Input Power Level:	Max Power	Extrapolation:	poly4

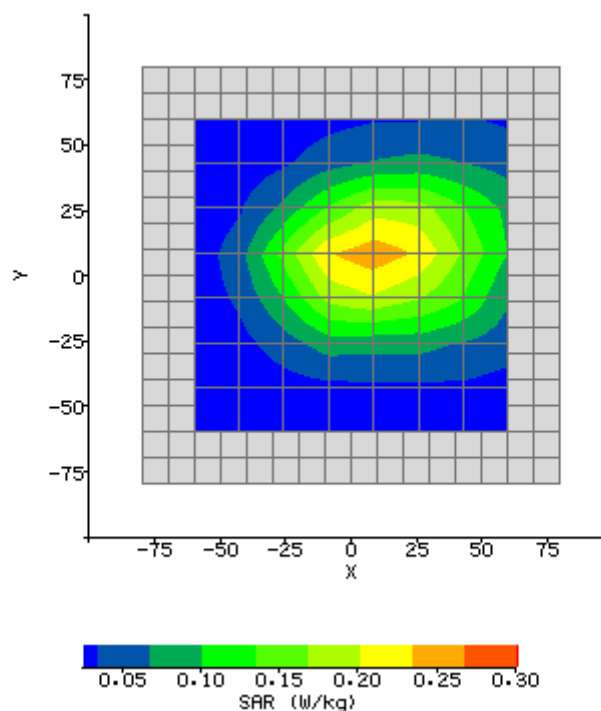

SAR Test GSM 1900 LH_TouchCheek (Top Channel)

System / software:	SARA2 / 2.40 VPM	Input Power Drift:	0.02dB
Date / Time:	2007-2-13 8:40:01	DUT Battery Model/No:	
Filename:	HG-A7_1900_LH_TOUCHC HEEK_T.txt	Probe Serial Number:	0177
Ambient Temperature:	19.7°C	Liquid Simulant:	HEAD tissue
Device Under Test:	HG-A7	Relative Permittivity:	40.12
Relative Humidity:	49%	Conductivity:	1.394
Phantom S/No:	Head_381SH.csv	Liquid Temperature:	19.8°C
Phantom Rotation:	0°	Max SAR Y-axis Location:	-66.17 mm
DUT Position:	HG-A7_LH_TOUCHCHEEK _T	Max SAR Z-axis Location:	-178.00 mm
Antenna Configuration:	BUILD INSIDE	Max E Field:	23.17 V/m
Test Frequency:	1900MHz	SAR 1g:	0.431 W/kg
Air Factors:	417 / 368 / 414	SAR 10g:	0.250 W/kg
Conversion Factors:	.325 / .325 / .325	SAR Start:	0.267 W/kg
Type of Modulation:	GMSK	SAR End:	0.279 W/kg
Modn. Duty Cycle:	8	SAR Drift during Scan:	4.68 %
Diode Compression Factors (V*200):	20 / 20 / 20	Probe battery last changed:	20/05/05
Input Power Level:	30dBm	Extrapolation:	poly4

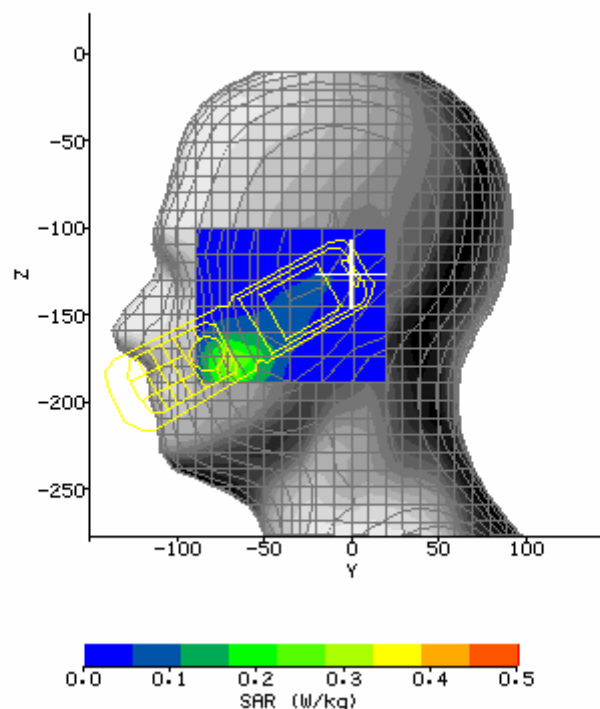

SAR Test GSM 1900 LH_TouchCheek (Middle Channel)

System / software:	SARA2 / 2.40 VPM	Input Power Drift:	0.01dB
Date / Time:	2007-2-13 8:51:24	DUT Battery Model/No:	
Filename:	HG-A7_1900_LH_TOUCHC HEEK_M.txt	Probe Serial Number:	0177
Ambient Temperature:	19.7°C	Liquid Simulant:	HEAD tissue
Device Under Test:	HG-A7	Relative Permittivity:	40.12
Relative Humidity:	49%	Conductivity:	1.394
Phantom S/No:	Head_381SH.csv	Liquid Temperature:	19.8°C
Phantom Rotation:	0°	Max SAR Y-axis Location:	-66.17 mm
DUT Position:	HG-A7_LH_TOUCHCHEEK_M	Max SAR Z-axis Location:	-179.50 mm
Antenna Configuration:	BUILD INSIDE	Max E Field:	22.20 V/m
Test Frequency:	1900MHz	SAR 1g:	0.388 W/kg
Air Factors:	417 / 368 / 414	SAR 10g:	0.227 W/kg
Conversion Factors:	.325 / .325 / .325	SAR Start:	0.258 W/kg
Type of Modulation:	GMSK	SAR End:	0.260 W/kg
Modn. Duty Cycle:	8	SAR Drift during Scan:	0.97 %
Diode Compression Factors (V*200):	20 / 20 / 20	Probe battery last changed:	20/05/05
Input Power Level:	30dBm	Extrapolation:	poly4

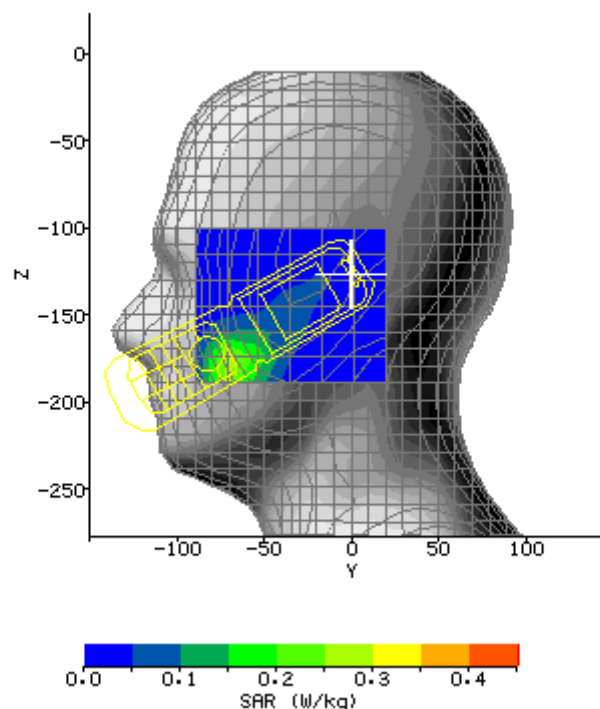

SAR Test GSM 1900 LH_TouchCheek (Bottom Channel)

System / software:	SARA2 / 2.40 VPM	Input Power Drift:	0.00dB
Date / Time:	2007-2-13 9:01:17	DUT Battery Model/No:	
Filename:	HG-A7_1900_LH_TOUCHC HEEK_B.txt	Probe Serial Number:	0177
Ambient Temperature:	19.7°C	Liquid Simulant:	HEAD tissue
Device Under Test:	HG-A7	Relative Permittivity:	40.12
Relative Humidity:	49%	Conductivity:	1.394
Phantom S/No:	Head_381SH.csv	Liquid Temperature:	19.8°C
Phantom Rotation:	0°	Max SAR Y-axis Location:	-64.33 mm
DUT Position:	HG-A7_LH_TOUCHCHEEK _B	Max SAR Z-axis Location:	-178.00 mm
Antenna Configuration:	BUILD INSIDE	Max E Field:	21.89 V/m
Test Frequency:	1900MHz	SAR 1g:	0.401 W/kg
Air Factors:	417 / 368 / 414	SAR 10g:	0.227 W/kg
Conversion Factors:	.325 / .325 / .325	SAR Start:	0.254 W/kg
Type of Modulation:	GMSK	SAR End:	0.254 W/kg
Modn. Duty Cycle:	8	SAR Drift during Scan:	-0.02 %
Diode Compression Factors (V*200):	20 / 20 / 20	Probe battery last changed:	20/05/05
Input Power Level:	30dBm	Extrapolation:	poly4

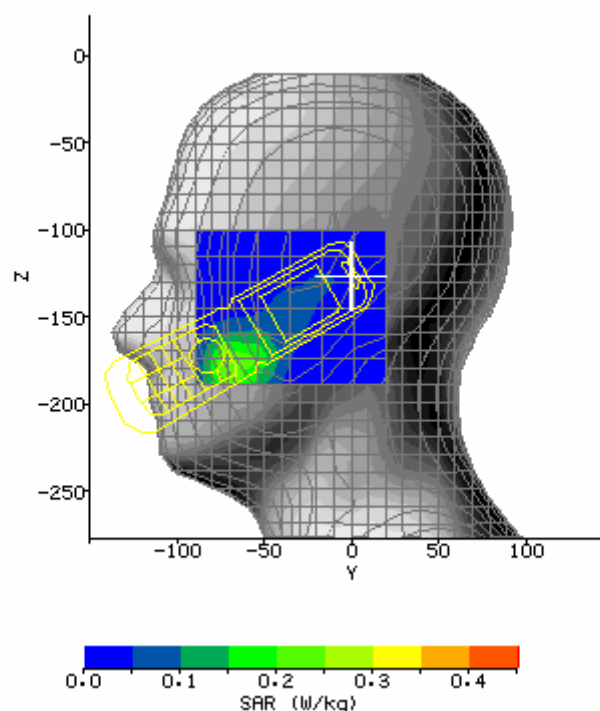



SAR Test GSM 1900 LH_Tilt15 (Top Channel)

System / software:	SARA2 / 2.40 VPM	Input Power Drift:	0.02dB
Date / Time:	2007-2-13 9:35:20	DUT Battery Model/No:	
Filename:	HG-A7_1900_LH_TILT15_T.txt	Probe Serial Number:	0177
Ambient Temperature:	19.7°C	Liquid Simulant:	HEAD tissue
Device Under Test:	HG-A7	Relative Permittivity:	39.87
Relative Humidity:	49%	Conductivity:	1.394
Phantom S/No:	Head_381SH.csv	Liquid Temperature:	19.8°C
Phantom Rotation:	0°	Max SAR Y-axis Location:	-46.00 mm
DUT Position:	HG-A7_LH_TILT15_T	Max SAR Z-axis Location:	-166.00 mm
Antenna Configuration:	BUILD INSIDE	Max E Field:	7.86 V/m
Test Frequency:	1900MHz	SAR 1g:	0.091 W/kg
Air Factors:	417 / 368 / 414	SAR 10g:	0.056 W/kg
Conversion Factors:	.325 / .325 / .325	SAR Start:	0.049 W/kg
Type of Modulation:	GMSK	SAR End:	0.051 W/kg
Modn. Duty Cycle:	8	SAR Drift during Scan:	4.22 %
Diode Compression Factors (V*200):	20 / 20 / 20	Probe battery last changed:	20/05/05
Input Power Level:	30dBm	Extrapolation:	poly4

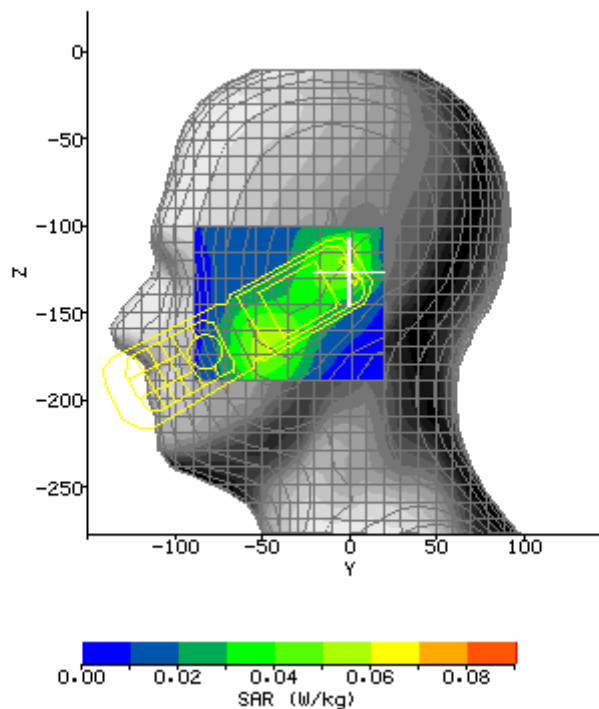



SAR Test GSM 1900 LH_Tilt15 (Middle Channel)

System / software:	SARA2 / 2.40 VPM	Input Power Drift:	0.01dB
Date / Time:	2007-2-13 9:24:14	DUT Battery Model/No:	
Filename:	HG-A7_1900_LH_TILT15_M.txt	Probe Serial Number:	0177
Ambient Temperature:	19.7°C	Liquid Simulant:	HEAD tissue
Device Under Test:	HG-A7	Relative Permittivity:	39.87
Relative Humidity:	49%	Conductivity:	1.394
Phantom S/No:	Head_381SH.csv	Liquid Temperature:	19.8°C
Phantom Rotation:	0°	Max SAR Y-axis Location:	-46.00 mm
DUT Position:	HG-A7_LH_TILT15_M	Max SAR Z-axis Location:	-166.00 mm
Antenna Configuration:	BUILD INSIDE	Max E Field:	7.81 V/m
Test Frequency:	1900MHz	SAR 1g:	0.087 W/kg
Air Factors:	417 / 368 / 414	SAR 10g:	0.054 W/kg
Conversion Factors:	.325 / .325 / .325	SAR Start:	0.045 W/kg
Type of Modulation:	GMSK	SAR End:	0.046 W/kg
Modn. Duty Cycle:	8	SAR Drift during Scan:	3.08 %
Diode Compression Factors (V*200):	20 / 20 / 20	Probe battery last changed:	20/05/05
Input Power Level:	30dBm	Extrapolation:	poly4

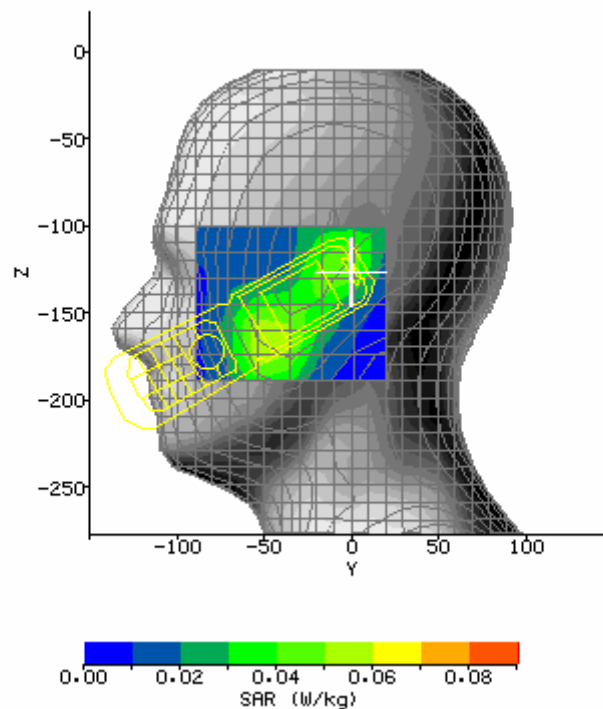

SAR Test GSM 1900 LH_Tilt15 (Bottom Channel)

System / software:	SARA2 / 2.40 VPM	Input Power Drift:	0.02dB
Date / Time:	2007-2-13 9:13:22	DUT Battery Model/No:	
Filename:	HG-A7_1900_LH_TILT15_T.txt	Probe Serial Number:	0177
Ambient Temperature:	19.7°C	Liquid Simulant:	HEAD tissue
Device Under Test:	HG-A7	Relative Permittivity:	39.87
Relative Humidity:	49%	Conductivity:	1.394
Phantom S/No:	Head_381SH.csv	Liquid Temperature:	19.8°C
Phantom Rotation:	0°	Max SAR Y-axis Location:	-36.83 mm
DUT Position:	HG-A7_LH_TILT15_T	Max SAR Z-axis Location:	-155.50 mm
Antenna Configuration:	BUILD INSIDE	Max E Field:	6.26 V/m
Test Frequency:	1900MHz	SAR 1g:	0.064 W/kg
Air Factors:	417 / 368 / 414	SAR 10g:	0.038 W/kg
Conversion Factors:	.325 / .325 / .325	SAR Start:	0.027 W/kg
Type of Modulation:	GMSK	SAR End:	0.028 W/kg
Modn. Duty Cycle:	8	SAR Drift during Scan:	4.60 %
Diode Compression Factors (V*200):	20 / 20 / 20	Probe battery last changed:	20/05/05
Input Power Level:	30dBm	Extrapolation:	poly4

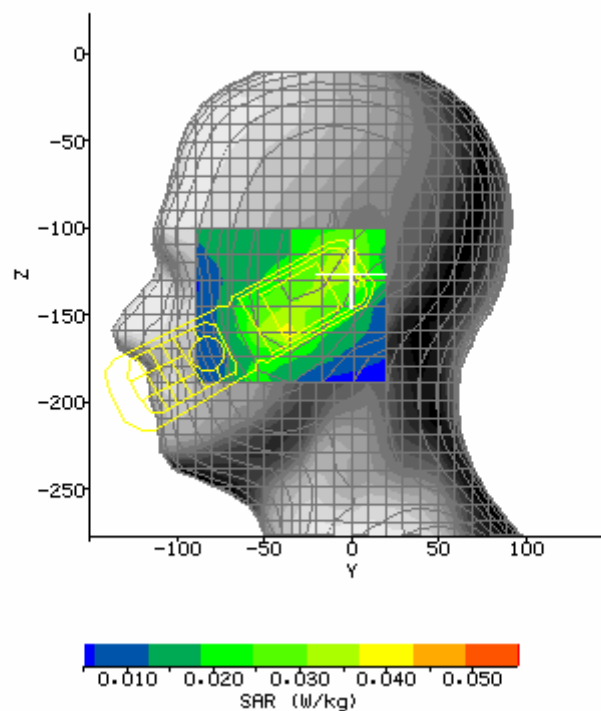

SAR Test GSM 1900 RH_TouchCheek (Top Channel)

System / software:	SARA2 / 2.40 VPM	Input Power Drift:	0.02dB
Date / Time:	2007-2-13 9:53:08	DUT Battery Model/No:	
Filename:	HG-A7_1900_RH_TOUCH_CHEEK_T.txt	Probe Serial Number:	0177
Ambient Temperature:	19.7°C	Liquid Simulant:	HEAD tissue
Device Under Test:	HG-A7	Relative Permittivity:	39.87
Relative Humidity:	49%	Conductivity:	1.394
Phantom S/No:	Head_381SH.csv	Liquid Temperature:	19.8°C
Phantom Rotation:	180°	Max SAR Y-axis Location:	71.67 mm
DUT Position:	HG-A7_RH_TOUCHCHEEK_T	Max SAR Z-axis Location:	-169.00 mm
Antenna Configuration:	BUILD INSIDE	Max E Field:	21.65 V/m
Test Frequency:	1900MHz	SAR 1g:	0.662 W/kg
Air Factors:	417 / 368 / 414	SAR 10g:	0.364 W/kg
Conversion Factors:	.325 / .325 / .325	SAR Start:	0.379 W/kg
Type of Modulation:	GMSK	SAR End:	0.391 W/kg
Modn. Duty Cycle:	8	SAR Drift during Scan:	3.11 %
Diode Compression Factors (V*200):	20 / 20 / 20	Probe battery last changed:	20/05/05
Input Power Level:	30dBm	Extrapolation:	poly4

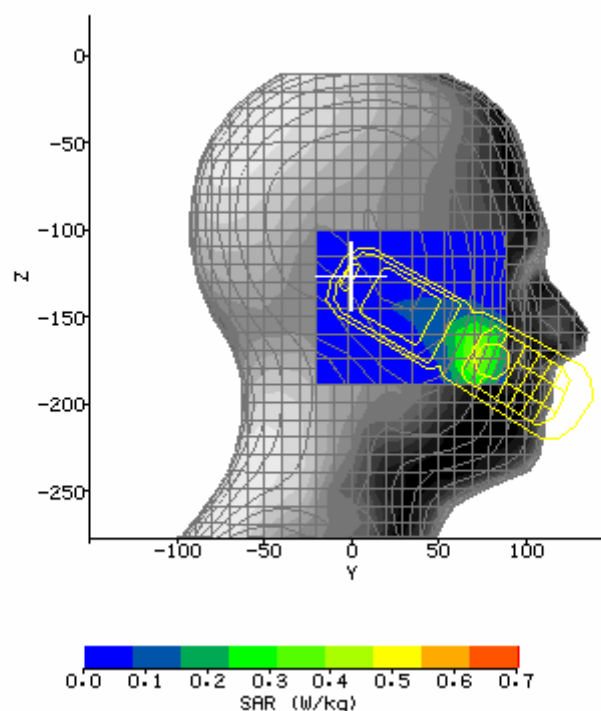

SAR Test GSM 1900 RH_TouchCheek (Middle Channel)

System / software:	SARA2 / 2.40 VPM	Input Power Drift:	0.00dB
Date / Time:	2007-2-13 10:04:47	DUT Battery Model/No:	
Filename:	HG-A7_1900_RH_TOUCH_CHEEK_M.txt	Probe Serial Number:	0177
Ambient Temperature:	19.7°C	Liquid Simulant:	HEAD tissue
Device Under Test:	HG-A7	Relative Permittivity:	39.87
Relative Humidity:	49%	Conductivity:	1.394
Phantom S/No:	Head_381SH.csv	Liquid Temperature:	19.8°C
Phantom Rotation:	180°	Max SAR Y-axis Location:	71.67 mm
DUT Position:	HG-A7_RH_TOUCHCHEEK_M	Max SAR Z-axis Location:	-169.00 mm
Antenna Configuration:	BUILD INSIDE	Max E Field:	20.72 V/m
Test Frequency:	1900MHz	SAR 1g:	0.573 W/kg
Air Factors:	417 / 368 / 414	SAR 10g:	0.331 W/kg
Conversion Factors:	.325 / .325 / .325	SAR Start:	0.362 W/kg
Type of Modulation:	GMSK	SAR End:	0.365 W/kg
Modn. Duty Cycle:	8	SAR Drift during Scan:	0.93 %
Diode Compression Factors (V*200):	20 / 20 / 20	Probe battery last changed:	20/05/05
Input Power Level:	30dBm	Extrapolation:	poly4

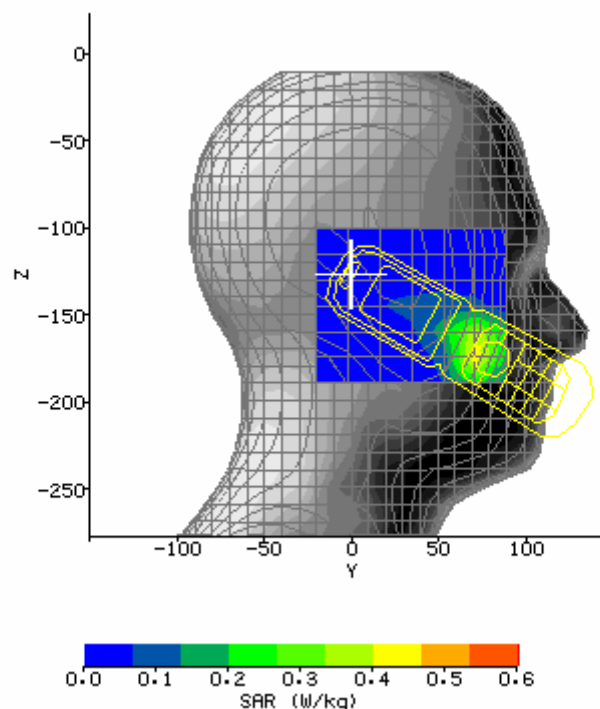

SAR Test GSM 1900 RH_TouchCheek (Bottom Channel)

System / software:	SARA2 / 2.40 VPM	Input Power Drift:	0.01dB
Date / Time:	2007-2-13 10:29:56	DUT Battery Model/No:	
Filename:	HG-A7_1900_RH_TOUCH_CHEEK_B.txt	Probe Serial Number:	0177
Ambient Temperature:	19.7°C	Liquid Simulant:	HEAD tissue
Device Under Test:	HG-A7	Relative Permittivity:	39.87
Relative Humidity:	49%	Conductivity:	1.394
Phantom S/No:	Head_381SH.csv	Liquid Temperature:	19.8°C
Phantom Rotation:	180°	Max SAR Y-axis Location:	68.00 mm
DUT Position:	HG-A7_RH_TOUCHCHEEK_B	Max SAR Z-axis Location:	-166.00 mm
Antenna Configuration:	BUILD INSIDE	Max E Field:	13.49 V/m
Test Frequency:	1900MHz	SAR 1g:	0.224 W/kg
Air Factors:	417 / 368 / 414	SAR 10g:	0.132 W/kg
Conversion Factors:	.325 / .325 / .325	SAR Start:	0.125 W/kg
Type of Modulation:	GMSK	SAR End:	0.128 W/kg
Modn. Duty Cycle:	8	SAR Drift during Scan:	2.43 %
Diode Compression Factors (V*200):	20 / 20 / 20	Probe battery last changed:	20/05/05
Input Power Level:	30dBm	Extrapolation:	poly4

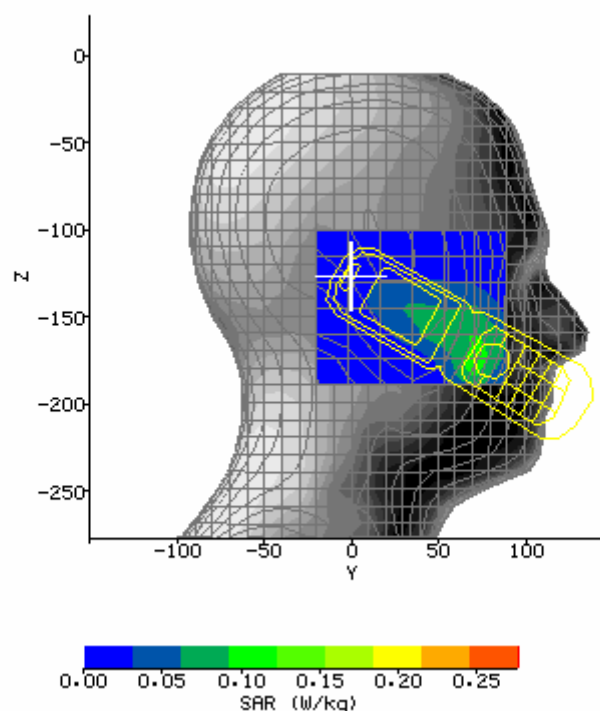

SAR Test GSM 1900 RH_Tilt15 (Top Channel)

System / software:	SARA2 / 2.40 VPM	Input Power Drift:	0.02dB
Date / Time:	2007-2-13 11:04:52	DUT Battery Model/No:	
Filename:	HG-A7_1900_RH_TILT15_T.txt	Probe Serial Number:	0177
Ambient Temperature:	19.7°C	Liquid Simulant:	HEAD tissue
Device Under Test:	HG-A7	Relative Permittivity:	39.87
Relative Humidity:	49%	Conductivity:	1.394
Phantom S/No:	Head_381SH.csv	Liquid Temperature:	19.8°C
Phantom Rotation:	180°	Max SAR Y-axis Location:	2.17 mm
DUT Position:	HG-A7_RH_TILT15_T	Max SAR Z-axis Location:	-123.17 mm
Antenna Configuration:	BUILD INSIDE	Max E Field:	9.38 V/m
Test Frequency:	1900MHz	SAR 1g:	0.128 W/kg
Air Factors:	417 / 368 / 414	SAR 10g:	0.075 W/kg
Conversion Factors:	.325 / .325 / .325	SAR Start:	0.062 W/kg
Type of Modulation:	GMSK	SAR End:	0.064 W/kg
Modn. Duty Cycle:	8	SAR Drift during Scan:	4.10 %
Diode Compression Factors (V*200):	20 / 20 / 20	Probe battery last changed:	20/05/05
Input Power Level:	30dBm	Extrapolation:	poly4

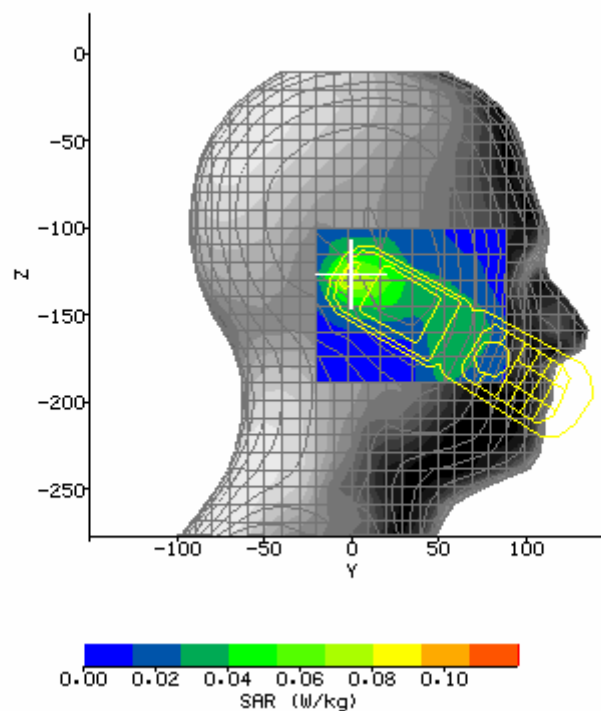

SAR Test GSM 1900 RH_Tilt15 (Middle Channel)

System / software:	SARA2 / 2.40 VPM	Input Power Drift:	0.02dB
Date / Time:	2007-2-13 10:53:59	DUT Battery Model/No:	
Filename:	HG-A7_1900_RH_TILT15_M.txt	Probe Serial Number:	0177
Ambient Temperature:	19.7°C	Liquid Simulant:	HEAD tissue
Device Under Test:	HG-A7	Relative Permittivity:	39.87
Relative Humidity:	49%	Conductivity:	1.394
Phantom S/No:	Head_381SH.csv	Liquid Temperature:	19.8°C
Phantom Rotation:	180°	Max SAR Y-axis Location:	7.50 mm
DUT Position:	HG-A7_RH_TILT15_M	Max SAR Z-axis Location:	-130.00 mm
Antenna Configuration:	BUILD INSIDE	Max E Field:	9.16 V/m
Test Frequency:	1900MHz	SAR 1g:	0.112 W/kg
Air Factors:	417 / 368 / 414	SAR 10g:	0.065 W/kg
Conversion Factors:	.325 / .325 / .325	SAR Start:	0.055 W/kg
Type of Modulation:	GMSK	SAR End:	0.057 W/kg
Modn. Duty Cycle:	8	SAR Drift during Scan:	4.33 %
Diode Compression Factors (V*200):	20 / 20 / 20	Probe battery last changed:	20/05/05
Input Power Level:	30dBm	Extrapolation:	poly4

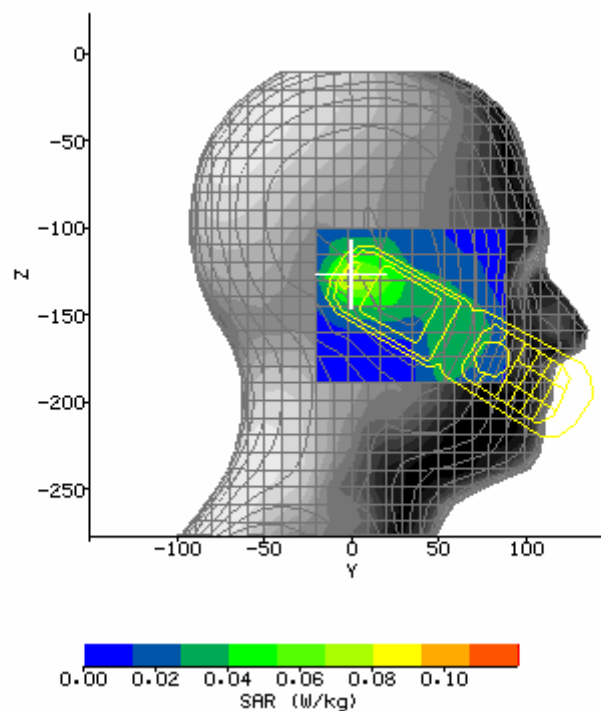

SAR Test GSM 1900 RH_Tilt15 (Bottom Channel)

System / software:	SARA2 / 2.40 VPM	Input Power Drift:	0.01dB
Date / Time:	2007-2-13 10:41:52	DUT Battery Model/No:	
Filename:	HG-A7_1900_RH_TILT15_B.txt	Probe Serial Number:	0177
Ambient Temperature:	19.7°C	Liquid Simulant:	HEAD tissue
Device Under Test:	HG-A7	Relative Permittivity:	39.87
Relative Humidity:	49%	Conductivity:	1.394
Phantom S/No:	Head_381SH.csv	Liquid Temperature:	19.8°C
Phantom Rotation:	180°	Max SAR Y-axis Location:	7.50 mm
DUT Position:	HG-A7_RH_TILT15_B	Max SAR Z-axis Location:	-130.00 mm
Antenna Configuration:	BUILD INSIDE	Max E Field:	6.39 V/m
Test Frequency:	1900MHz	SAR 1g:	0.089 W/kg
Air Factors:	417 / 368 / 414	SAR 10g:	0.035 W/kg
Conversion Factors:	.325 / .325 / .325	SAR Start:	0.027 W/kg
Type of Modulation:	GMSK	SAR End:	0.028 W/kg
Modn. Duty Cycle:	8	SAR Drift during Scan:	1.86 %
Diode Compression Factors (V*200):	20 / 20 / 20	Probe battery last changed:	20/05/05
Input Power Level:	30dBm	Extrapolation:	poly4

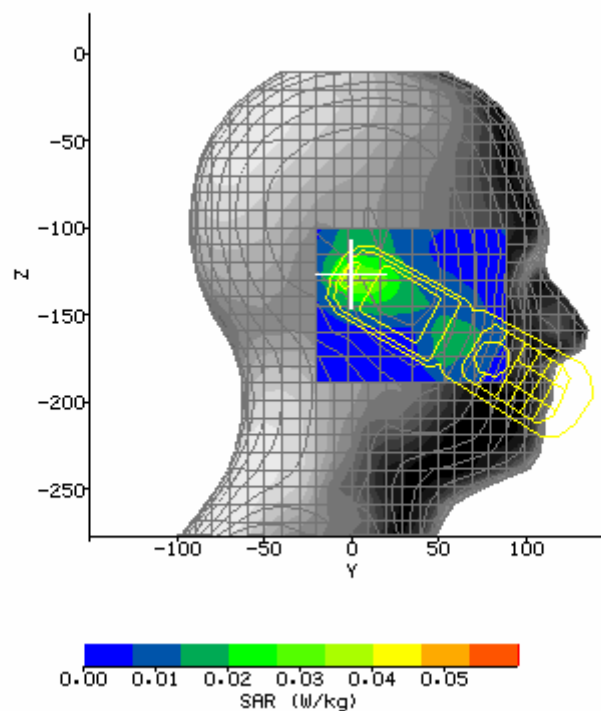

SAR Test GSM 1900 Side (Top Channel)

System / software:	SARA2 / 2.40 VPM	Input Power Drift:	0.01dB
Date / Time:	2007-2-13 15:04:23	DUT Battery Model/No:	
Filename:	HG- A7_1900_BODY_T.txt	Probe Serial Number:	0177
Ambient Temperature:	21.3°C	Liquid Simulant:	Body tissue
Device Under Test:	HG-A7	Relative Permittivity:	54.13
Relative Humidity:	54%	Conductivity:	1.526
Phantom S/No:	HeadBox75mm.csv	Liquid Temperature:	21.4°C
Phantom Rotation:	0°	Max SAR X-axis Location:	6.86 mm
DUT Position:	BODY	Max SAR Y-axis Location:	3.43 mm
Antenna Configuration:	BUILD INSIDE	Max E Field:	10.88 V/m
Test Frequency:	1900MHz	SAR 1g:	0.234 W/kg
Air Factors:	417 / 368 / 414	SAR 10g:	0.138 W/kg
Conversion Factors:	.356 / .356 / .356	SAR Start:	0.044 W/kg
Type of Modulation:	GMSK	SAR End:	0.045 W/kg
Modn. Duty Cycle:	8	SAR Drift during Scan:	2.19 %
Diode Compression Factors (V*200):	20 / 20 / 20	Probe battery last changed:	20/05/05
Input Power Level:	Max Power	Extrapolation:	poly4

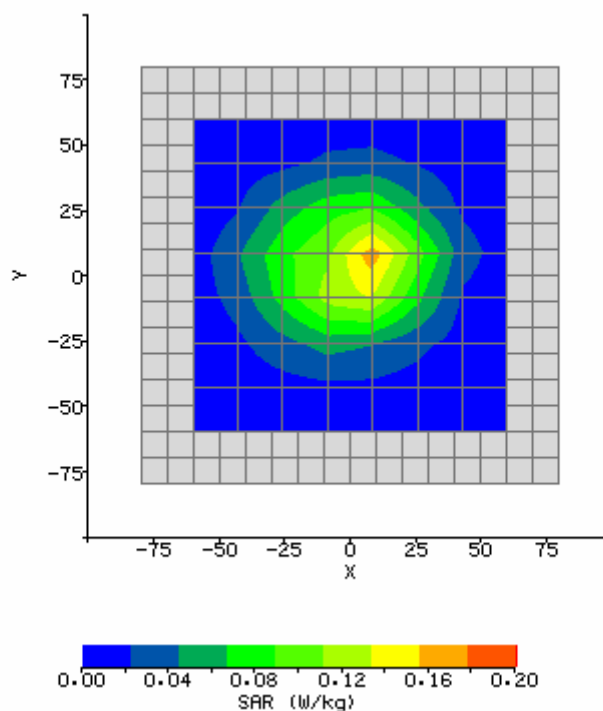

SAR Test GSM 1900 Side (Middle Channel)

System / software:	SARA2 / 2.40 VPM	Input Power Drift:	0.02dB
Date / Time:	2007-2-13 15:16:33	DUT Battery Model/No:	
Filename:	HG- A7_1900_BODY_M.txt	Probe Serial Number:	0177
Ambient Temperature:	21.3°C	Liquid Simulant:	Body tissue
Device Under Test:	HG-A7	Relative Permittivity:	54.13
Relative Humidity:	54%	Conductivity:	1.526
Phantom S/No:	HeadBox75mm.csv	Liquid Temperature:	21.4°C
Phantom Rotation:	0°	Max SAR X-axis Location:	6.86 mm
DUT Position:	BODY	Max SAR Y-axis Location:	3.43 mm
Antenna Configuration:	BUILD INSIDE	Max E Field:	10.85 V/m
Test Frequency:	1900MHz	SAR 1g:	0.228 W/kg
Air Factors:	417 / 368 / 414	SAR 10g:	0.124 W/kg
Conversion Factors:	.356 / .356 / .356	SAR Start:	0.039 W/kg
Type of Modulation:	GMSK	SAR End:	0.041 W/kg
Modn. Duty Cycle:	8	SAR Drift during Scan:	4.96 %
Diode Compression Factors (V*200):	20 / 20 / 20	Probe battery last changed:	20/05/05
Input Power Level:	Max Power	Extrapolation:	poly4

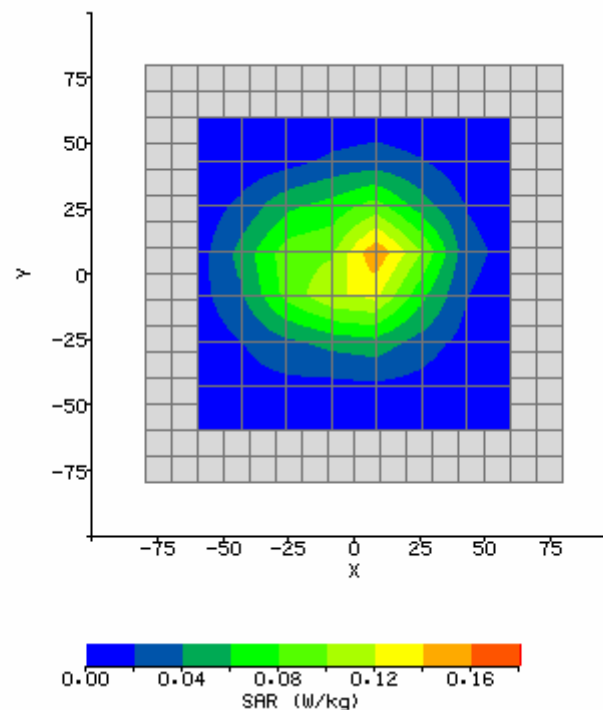

SAR Test GSM 1900 Side (Bottom Channel)

System / software:	SARA2 / 2.40 VPM	Input Power Drift:	0.00dB
Date / Time:	2007-2-13 15:26:14	DUT Battery Model/No:	
Filename:	HG- A7_1900_BODY_B.txt	Probe Serial Number:	0177
Ambient Temperature:	21.3°C	Liquid Simulant:	Body tissue
Device Under Test:	HG-A7	Relative Permittivity:	54.13
Relative Humidity:	54%	Conductivity:	1.526
Phantom S/No:	HeadBox75mm.csv	Liquid Temperature:	21.4°C
Phantom Rotation:	0°	Max SAR X-axis Location:	6.86 mm
DUT Position:	BODY	Max SAR Y-axis Location:	1.71 mm
Antenna Configuration:	BUILD INSIDE	Max E Field:	8.50 V/m
Test Frequency:	1900MHz	SAR 1g:	0.174 W/kg
Air Factors:	417 / 368 / 414	SAR 10g:	0.077 W/kg
Conversion Factors:	.356 / .356 / .356	SAR Start:	0.023 W/kg
Type of Modulation:	GMSK	SAR End:	0.023 W/kg
Modn. Duty Cycle:	8	SAR Drift during Scan:	-0.26 %
Diode Compression Factors (V*200):	20 / 20 / 20	Probe battery last changed:	20/05/05
Input Power Level:	Max Power	Extrapolation:	poly4

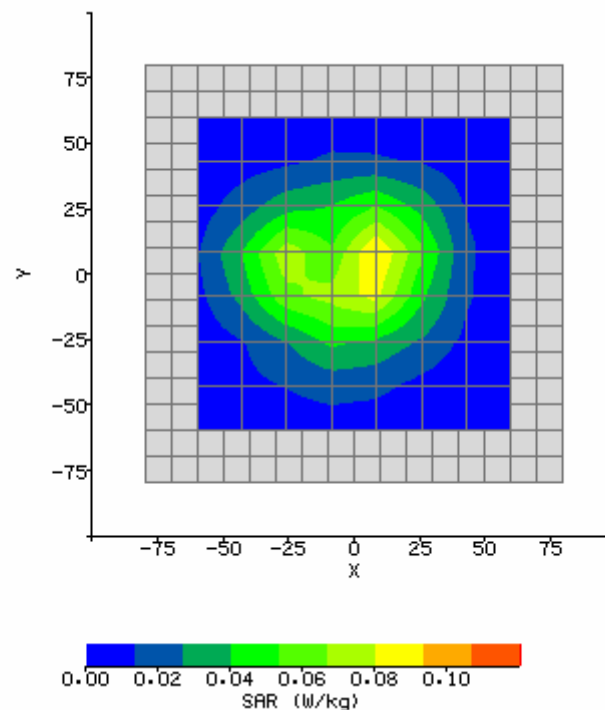

SAR Test GSM 1900 Side (Top Channel, face to bottom)

System / software:	SARA2 / 2.40 VPM	Input Power Drift:	0.00dB
Date / Time:	2007-2-13 15:54:42	DUT Battery Model/No:	
Filename:	HG- A7_1900_BODY_T_FA CETOBOTTOM.txt	Probe Serial Number:	0177
Ambient Temperature:	21.3°C	Liquid Simulant:	Body tissue
Device Under Test:	HG-A7	Relative Permittivity:	54.13
Relative Humidity:	54%	Conductivity:	1.526
Phantom S/No:	HeadBox75mm.csv	Liquid Temperature:	21.4°C
Phantom Rotation:	0°	Max SAR X-axis Location:	-24.00 mm
DUT Position:	BODY	Max SAR Y-axis Location:	5.14 mm
Antenna Configuration:	BUILD INSIDE	Max E Field:	12.25 V/m
Test Frequency:	1900MHz	SAR 1g:	0.317 W/kg
Air Factors:	417 / 368 / 414	SAR 10g:	0.162 W/kg
Conversion Factors:	.356 / .356 / .356	SAR Start:	0.034 W/kg
Type of Modulation:	GMSK	SAR End:	0.034 W/kg
Modn. Duty Cycle:	8	SAR Drift during Scan:	-0.71 %
Diode Compression Factors (V*200):	20 / 20 / 20	Probe battery last changed:	20/05/05
Input Power Level:	Max Power	Extrapolation:	poly4

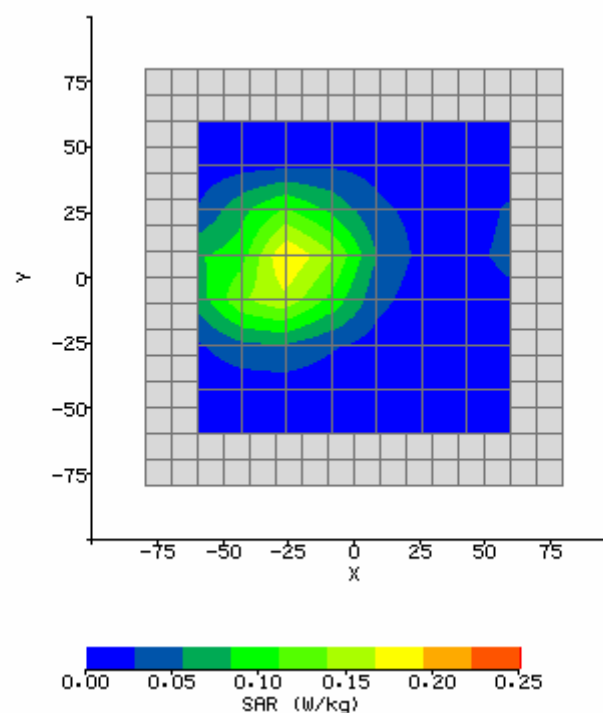

SAR Test GSM 1900 Side (Top Channel, With Headphone)

System / software:	SARA2 / 2.40 VPM	Input Power Drift:	0.02dB
Date / Time:	2007-2-13 15:39:07	DUT Battery Model/No:	
Filename:	HG-A7_1900_BODY_B_WI THHEADPHONE.txt	Probe Serial Number:	0177
Ambient Temperature:	21.3°C	Liquid Simulant:	Body tissue
Device Under Test:	HG-A7	Relative Permittivity:	54.13
Relative Humidity:	54%	Conductivity:	1.526
Phantom S/No:	HeadBox75mm.csv	Liquid Temperature:	21.4°C
Phantom Rotation:	0°	Max SAR X-axis Location:	-8.57 mm
DUT Position:	BODY	Max SAR Y-axis Location:	5.14 mm
Antenna Configuration:	BUILD INSIDE	Max E Field:	13.52 V/m
Test Frequency:	1900MHz	SAR 1g:	0.408 W/kg
Air Factors:	417 / 368 / 414	SAR 10g:	0.194 W/kg
Conversion Factors:	.356 / .356 / .356	SAR Start:	0.046 W/kg
Type of Modulation:	GMSK	SAR End:	0.044 W/kg
Modn. Duty Cycle:	8	SAR Drift during Scan:	-4.74 %
Diode Compression Factors (V*200):	20 / 20 / 20	Probe battery last changed:	20/05/05
Input Power Level:	Max Power	Extrapolation:	poly4

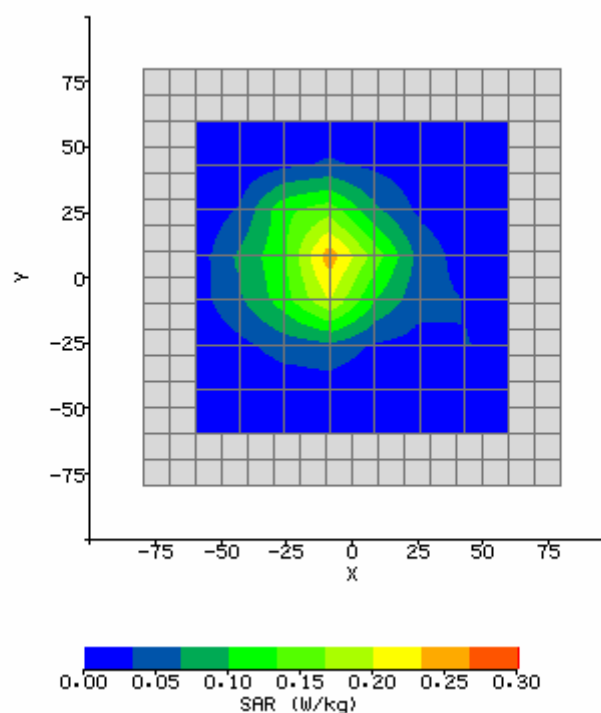



ANNEX E
of
ShenZhen Electronic Product Quality Testing Center
CONFORMANCE TEST REPORT FOR
HUMAN EXPOSURE TO ELECTROMAGNETIC FIELDS

SAR07-011

QINGDAO HAIER TELECOM CO., LTD.

GSM

Type Name: HG-A7I

Hardware Version: P1

Software Version: H01-S003-NA

System Performance Check Data

This Annex consists of 5 pages

Date of Report: 2007-03-13





System Performance Check Data

System / software:	SARA2 / 2.40 VPM	Input Power Drift:	-0.03dB
Date / Time:	2007-2-12 8:15:12	DUT Battery Model/No:	
Filename:	System Cheek_Head _850MHz.txt	Probe Serial Number:	0177
Ambient Temperature:	23.3°C	Liquid Simulant:	Head tissue
Device Under Test:	IXD-090antenna (250mw)	Relative Permittivity:	41.58
Relative Humidity:	59%	Conductivity:	0.902
Phantom S/No:	HeadBox75mm.csv	Liquid Temperature:	21.3°C
Phantom Rotation:	0°	Max SAR Y-axis Location:	5.35 mm
DUT Position:	850_Head	Max SAR Z-axis Location:	-213.02 mm
Antenna Configuration:	IXD-090antenna	Max E Field:	47.03 V/m
Test Frequency:	850MHz	SAR 1g:	2.632 W/kg
Air Factors:	417.2 / 368.0 / 414.8	SAR 10g:	1.753 W/kg
Conversion Factors:	.287 / .287 / .287	SAR Start:	0.605 W/kg
Type of Modulation:	/	SAR End:	0.596 W/kg
Modn. Duty Cycle:	1	SAR Drift during Scan:	-1.51 %
Diode Compression Factors (V*200):	20 / 20 / 20	Probe battery last changed:	20/05/05
Input Power Level:	24dBm	Extrapolation:	poly4

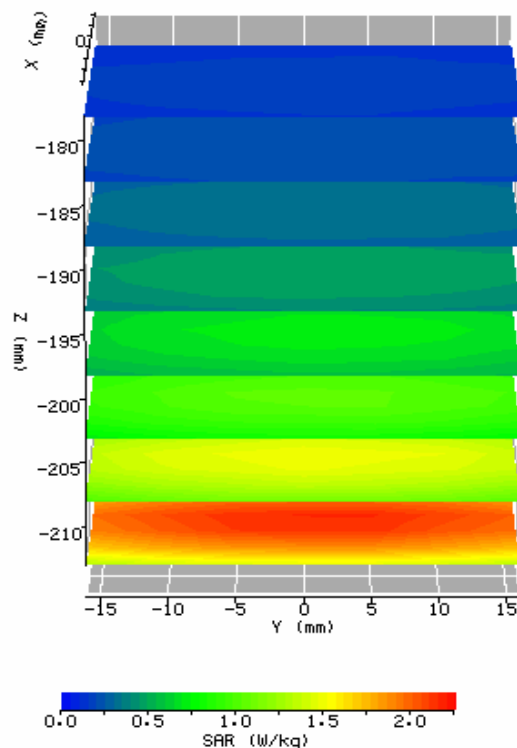

System / software:	SARA2 / 2.40 VPM	Input Power Drift:	0.02dB
Date / Time:	2007-2-13 9:20:12	DUT Battery Model/No:	
Filename:	System Cheek_Body _850MHz.txt	Probe Serial Number:	0177
Ambient Temperature:	23.5°C	Liquid Simulant:	Body tissue
Device Under Test:	IXD-090antenna (250mw)	Relative Permittivity:	55.47
Relative Humidity:	57%	Conductivity:	0.972
Phantom S/No:	HeadBox75mm.csv	Liquid Temperature:	21.3°C
Phantom Rotation:	0°	Max SAR X-axis Location:	0.00 mm
DUT Position:	850_Body	Max SAR Y-axis Location:	0.00 mm
Antenna Configuration:	IXD-090antenna	Max E Field:	44.80 V/m
Test Frequency:	850MHz	SAR 1g:	2.566 W/kg
Air Factors:	417 / 368 / 414	SAR 10g:	1.670W/kg
Conversion Factors:	.271 / .271 / .271	SAR Start:	0.538 W/kg
Type of Modulation:	/	SAR End:	0.541 W/kg
Modn. Duty Cycle:	1	SAR Drift during Scan:	0.52 %
Diode Compression Factors (V*200):	20 / 20 / 20	Probe battery last changed:	20/05/05
Input Power Level:	24dBm	Extrapolation:	poly4

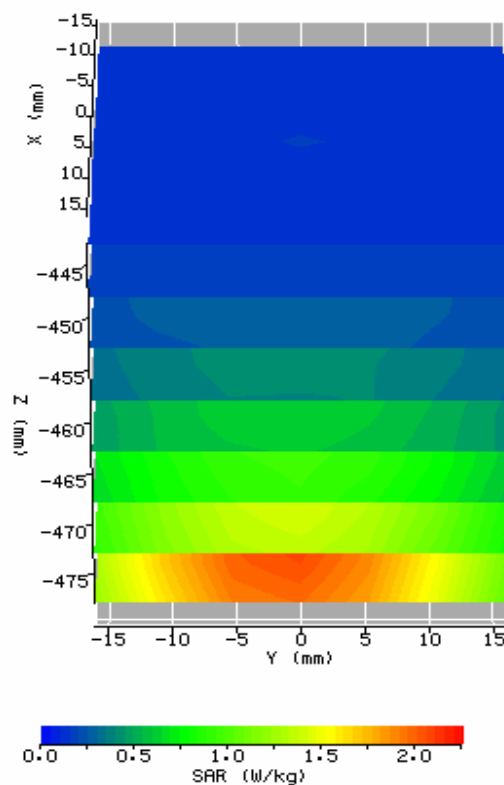

System / software:	SARA2 / 2.40 VPM	Input Power Drift:	-0.01dB
Date / Time:	2007-2-13 7:38:15	DUT Battery Model/No:	
Filename:	System Check_Head _1900MHz.txt	Probe Serial Number:	0177
Ambient Temperature:	23.6°C	Liquid Simulant:	Head tissue
Device Under Test:	IXD-080antenna (250mw)	Relative Permittivity:	40.12
Relative Humidity:	56%	Conductivity:	1.394
Phantom S/No:	HeadBox75mm.csv	Liquid Temperature:	19.8°C
Phantom Rotation:	0°	Max SAR Y-axis Location:	0.00 mm
DUT Position:	1900_Head	Max SAR Z-axis Location:	-213.09 mm
Antenna Configuration:	IXD-080antenna	Max E Field:	76.86 V/m
Test Frequency:	1900MHz	SAR 1g:	10.288 W/kg
Air Factors:	417 / 368 / 414	SAR 10g:	5.715 W/kg
Conversion Factors:	.325 / .325 / .325	SAR Start:	1.600 W/kg
Type of Modulation:	/	SAR End:	1.596 W/kg
Modn. Duty Cycle:	1	SAR Drift during Scan:	-0.19 %
Diode Compression Factors (V*200):	20 / 20 / 20	Probe battery last changed:	20/05/05
Input Power Level:	24dBm	Extrapolation:	poly4

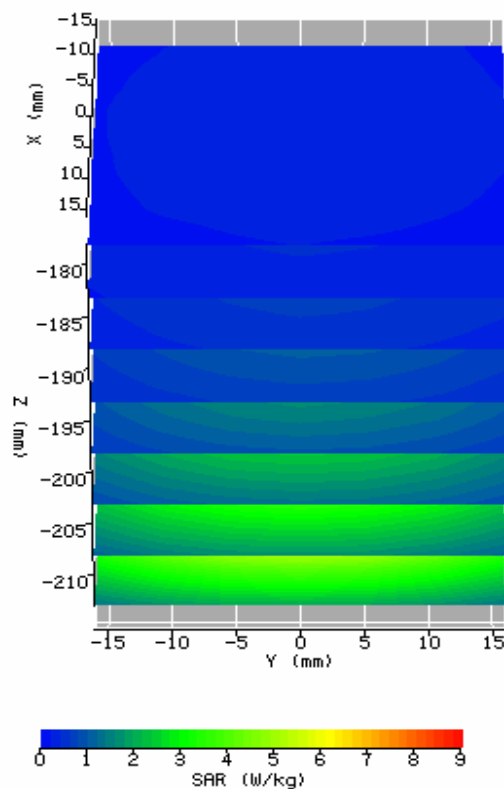

System / software:	SARA2 / 2.40 VPM	Input Power Drift:	0.01dB
Date / Time:	2007-2-13 8:15:23	DUT Battery Model/No:	
Filename:	System Check_Body _1900MHz.txt	Probe Serial Number:	0177
Ambient Temperature:	23.6°C	Liquid Simulant:	BODY tissue
Device Under Test:	IXD-080antenna (250mw)	Relative Permittivity:	54.13
Relative Humidity:	57%	Conductivity:	1.526
Phantom S/No:	HeadBox75mm.csv	Liquid Temperature:	21.4°C
Phantom Rotation:	0°	Max SAR X-axis Location:	0.00 mm
DUT Position:	1900_Body	Max SAR Y-axis Location:	0.00 mm
Antenna Configuration:	IXD-080antenna	Max E Field:	73.06 V/m
Test Frequency:	1900MHz	SAR 1g:	10.081 W/kg
Air Factors:	417 / 368 / 414	SAR 10g:	5.480 W/kg
Conversion Factors:	.356 / .356 / .356	SAR Start:	1.568 W/kg
Type of Modulation:	/	SAR End:	1.572 W/kg
Modn. Duty Cycle:	1	SAR Drift during Scan:	0.25 %
Diode Compression Factors (V*200):	20 / 20 / 20	Probe battery last changed:	20/05/05
Input Power Level:	24dBm	Extrapolation:	poly4

