



47 CFR PART 22 SUBPART H

TEST REPORT

of

850/1900 Dual-band Handset

Model Name: HG-A7I
Trade Name: Haier
Report No.: SZ07010069E02
FCC ID: SG70701HG-A7I

prepared for

Qingdao Haier Telecom Co., Ltd.

No.1,Haier Road,Hi-tech Zone,Qingdao,266101,P.R.China

prepared by

Shenzhen Morlab Communications Technology Co., Ltd.

3/F, Electronic Testing Building, Shahe Road, Xili,
Nanshan District, Shenzhen, 518055 P. R. China

Tel: +86 755 86130398

Fax: +86 755 86130218



NOTE: This test report can be duplicated completely for the legal use with the approval of the applicant, it shall not be reproduced except in full, without the written approval of Shenzhen Morlab Communications Technology Co., Ltd. Any objections should be raised to us within thirty workdays since the date of issue.



TABLE OF CONTENTS

1.	TEST RESULT CERTIFICATION	4
2.	GENERAL INFORMATION	5
2.1	Equipment under Test (EUT) Description	5
2.2	Test Standards and Results	6
2.3	Facilities and Accreditations	7
2.3.1	Facilities	7
2.3.2	Test Equipments	7
2.3.3	Test Environment Conditions	8
3.	47 CFR PART 2, PART 22H REQUIREMENTS	9
3.1	General Information.....	9
3.1.1	Conducted Related Tests	9
3.1.2	Radiated Power and Spurious Emission Tests	10
3.1.3	Frequency Stability Test.....	11
3.2	Frequencies.....	12
3.2.1	Requirement	12
3.2.2	Test Procedure	12
3.2.3	Test Result.....	12
3.3	Conducted RF Output Power	14
3.3.1	Requirement	14
3.3.2	Test Procedure	14
3.3.3	Test Result.....	14
3.4	Occupied Bandwidth	17
3.4.1	Occupied Bandwidth Definition	17
3.4.2	Test Procedure	17
3.4.3	Test Result.....	17
3.5	Conducted Spurious Emission.....	20
3.5.1	Requirement	20
3.5.2	Test Procedure	20
3.5.3	Test Result.....	20
3.6	Transmitter Radiated Power (EIRP/ERP).....	26

3.6.1	Requirement	26
3.6.2	Test Procedure	26
3.6.3	Test Result	26
3.7	Radiated Spurious Emission	29
3.7.1	Requirement	29
3.7.2	Test Procedure	29
3.7.3	Test Result	29
3.8	Frequency Stability	31
3.8.1	Frequency Stability Requirement	31
3.8.2	Test Procedure	31
3.8.3	Test Result	32
I	PHOTOGRAPH OF THE TEST SETUP	33
II	PHOTOGRAPH OF THE EUT	34

1. Test Result Certification

Equipment under Test: 850/1900 Dual-band Handset

Trade Name: Haier
Model Name: HG-A7I
FCC ID: SG70701HG-A7I

Applicant: Qingdao Haier Telecom Co., Ltd.
No.1,Haier Road,Hi-tech Zone,Qingdao,266101,P.R.China
Manufacturer: Qingdao Haier Telecom Co., Ltd.
No.1,Haier Road,Hi-tech Zone,Qingdao,266101,P.R.China

Test Standards: 47 CFR Part 2
47 CFR Part 22 Subpart H
Test Result: PASS

* We hereby certify that:

The equipment under test was tested by Shenzhen Morlab Communications Technology Co., Ltd. The test data, data evaluation, test procedures and equipment configurations shown in this report were made in accordance with the requirement of related FCC rules.

The test results of this report only apply for the tested sample equipment identified above. The test report shall be invalid without all the signatures of the test engineer, the reviewer and the approver.

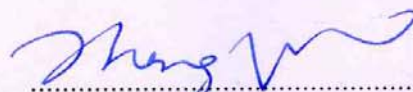
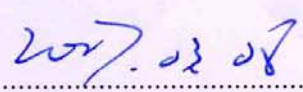
Tested by:  Dated: 
Zhang Weimin

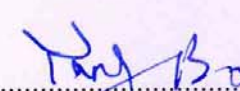
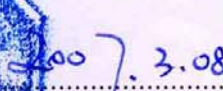
Reviewed by:  Dated: 
Yang Bo

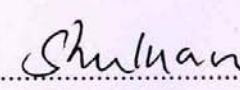
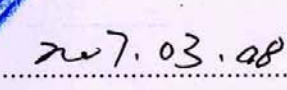
Approved by:  Dated: 
Shu Luan



2. General Information

2.1 Equipment under Test (EUT) Description

Description: 850/1900 Dual-band Handset
Model Name: HG-A7I
Serial No.....: N/A
IMEI: N/A
Hardware Version: P1
Software Version: H01-S003-NA
Emission Designator.....: 300KGXW
Modulation: GSM
Frequency: Tx: 824.20 - 848.80MHz
Rx: 869.20 - 893.80MHz
Power.....: 2Watt

NOTE:

1. The EUT is Tri-band GSM Mobile Phone, here only Cellular 850MHz band was tested in this report.
2. The normal configuration for the EUT is the Mobile Phone (MS) associated with ancillary equipments e.g. the Battery and/or the AC Adapter (Charger).
3. The transmitter (Tx) frequency arrangement of the Cellular 850MHz band for the EUT can be represented with a formula $F(n)=824.2+0.2*(n-128)$, $128 \leq n \leq 251$.
4. The normal, high and low voltage supply for the Battery of the EUT is separately 3.7V, 4.2V and 3.6V, which are specified by the applicant.
5. For detailed features about the EUT, please see user manual supplied by the applicant.



2.2 Test Standards and Results

The objective of the report is to perform tests according to 47 CFR Part 2, Part 22 for FCC ID Certification:

No.	Identity	Document Title
1	47 CFR Part 2 (10-1-05 Edition)	Frequency Allocations and Radio Treaty Matters; General Rules and Regulations
2	47 CFR Part 22 (10-1-05 Edition)	Public Mobile Services

Test detailed items and the results are as below:

No.	Rules	Test Type	Result	Date of Test
1	§2.106 §22.905	Frequencies	PASS	2007-1-31
2	§2.1046	Conducted RF Output Power at Antenna Terminal	PASS	2007-1-31
3	§2.1049	Occupied Bandwidth	PASS	2007-1-31
4	§2.1051 §2.1057 §22.917	Conducted Spurious Emission at Antenna Terminal	PASS	2007-1-31
5	§22.913	Transmitter Radiated Power (EIPR/ERP)	PASS	2007-1-31
6	§2.1053 §2.1057 §22.917	Radiated Spurious Emission	PASS	2007-1-31
7	§2.1055 §22.355	Frequency Stability	PASS	2007-1-31

2.3 Facilities and Accreditations

2.3.1 Facilities

Shenzhen Electronic Product Quality Testing Center (Morlab) is a testing organization accredited by China National Accreditation Board for Laboratories (CNAL) according to ISO/IEC 17025. The accreditation certificate number is L1659.

All measurement facilities used to collect the measurement data are located at Electronic Testing Building, Shahe Road, Xili, Nanshan District, Shenzhen, P. R. China. The site was constructed in conformance with the requirements of ANSI C63.7, ANSI C63.4 and CISPR Publication 22, the FCC registration number is 741109.

2.3.2 Test Equipments

No.	Description	Specification
1	System Simulator	Manufacturer: Rohde&Schwarz Model No.: CMU200 Serial No.: 100448
2	System Simulator	Manufacturer: Agilent Model No.: E5515C Serial No.: GB43130131
3	Spectrum Analyzer	Manufacturer: Agilent Model No.: E7405A Serial No.: US44210471
4	Telecommunication Antenna	Manufacturer: European Antennas Model No.: PSA-45010R/356 Serial No.: 403688-001
5	Trilogy Antenna	Manufacturer: Schwarzbeck Model No.: VULB 9163 Serial No.: 9163-274
6	Horn Antenna	Manufacturer: Schwarzbeck Model No.: BBHA 9120C Serial No.: 9120C-384
7	Power Splitter	Manufacturer: WEINSCHEL Model No.: 1506A Serial No.: NW521
8	Anechoic Chamber	Manufacturer: Albatross Projects GmbH
9	DC Power Supply	Manufacturer: Good Will Instrument Co., Ltd.
10	Temperature Chamber	Manufacturer: Chongqing YinHe Experimental Equip. Co., Ltd.

NOTE:

1. Equipments listed above have been calibrated and are in the period of validation.

2.3.3 Test Environment Conditions

During the measurement, the environmental conditions were within the listed ranges:

Temperature:	20 - 25°C
Relative Humidity:	40 - 50%
Atmospheric Pressure:	96kPa

3. 47 CFR Part 2, Part 22H Requirements

3.1 General Information

3.1.1 Conducted Related Tests

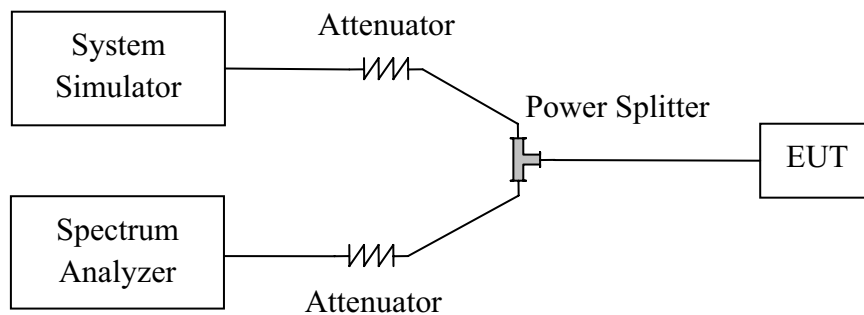

1. The EUT is coupled to the Spectrum Analyzer and the System Simulator with the suitable Attenuators through the Power Splitter; the path loss is calibrated to correct the reading.
2. The EUT is configured here as MS + Battery.
3. The EUT is commanded via the System Simulator (SS) to operate at the maximum output power i.e. Power Control Level (PCL) = 5 and Power Class = 4.
4. The BCCH number of the SS used here is 200. A communication link is established between the EUT and the SS.
5. The Spectrum Analyzer is set to max-peak detector function and maximum hold mode.

3.1.2 Radiated Power and Spurious Emission Tests

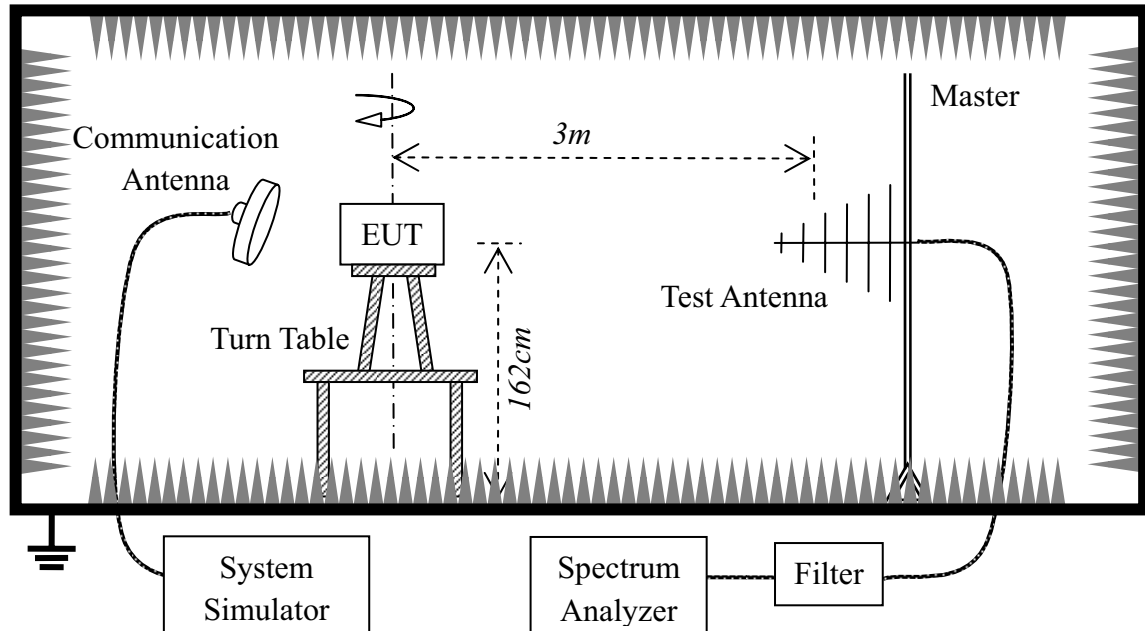

1. The test is performed in a full-Anechoic Chamber; the air loss of the site and the factors of the test system are pre-calibrated using the substitution method.
2. The EUT is configured as MS + Battery.
3. The EUT is placed on the vertical axis of a Turn Table 1.62 meters above the ground.
4. The Test Antenna is a bi-log one or a horn one, and the Test Antenna is at the same height as the EUT.
5. The EUT is commanded via the System Simulator (SS) to operate at the maximum output power i.e. Power Control Level (PCL) = 5 and Power Class = 4.
6. The BCCH number of the SS used here is 200. A communication link is established between the EUT and the SS.
7. The Spectrum Analyzer is set to max-peak detector function and maximum hold mode.

3.1.3 Frequency Stability Test

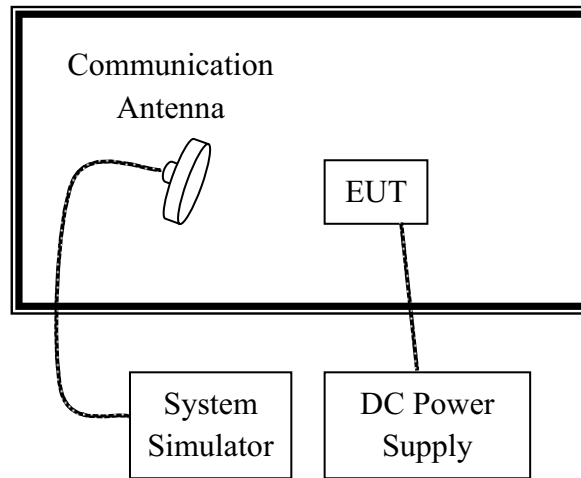

1. The test is performed in a Temperature Chamber.
2. The EUT is configured as MS + DC Power Supply.
3. The BCCH number of the SS used here is 200.

3.2 Frequencies

3.2.1 Requirement

According to FCC §22.905, the frequencies blocks assignment for the Cellular Radiotelephone Service are listed as below.

- (a) Channel Block A:
 - Mobile 824 - 835MHz, Base 869 - 880MHz;
 - Mobile 845 - 846.5MHz, Base 890 - 891.5MHz
- (b) Channel Block B:
 - Mobile 835 - 845 MHz, Base 880 - 890MHz;
 - Mobile 846.5 - 849 MHz, Base 891.5 - 894MHz

3.2.2 Test Procedure

1. Perform test system setup as section 3.1.1.
2. Perform test configuration as section 3.
3. The resolution bandwidth (RBW) of the Spectrum Analyzer was set to at least 1% of the emission bandwidth of the fundamental emission of the transmitter, e.g. for GSM modulated signal (here used): $RBW=VBW=3kHz$, for CDMA modulated signal: $RBW=VBW=30kHz$.
4. The transmitter frequency arrangement of the GSM850MHz band is $F(n)=824.2+0.2*(n-128)$, $128 \leq n \leq 251$. The lowest and the highest channel were selected to perform tests respectively. Set the TCH number to 128.
5. Set the Spectrum Analyzer suitably to capture the waveform, search peak and mark, and then record the plot.
6. Set the TCH number to 251, then repeat step 5.

3.2.3 Test Result

The transmitter (Tx) frequency arrangement of the Cellular 850MHz band is represented with a formula $F(n)= 824.2+0.2*(n-128)$, $128 \leq n \leq 251$. The frequencies of the lowest channel and the highest channel are listed as follows.

1. Plot when the TCH number set to 128:

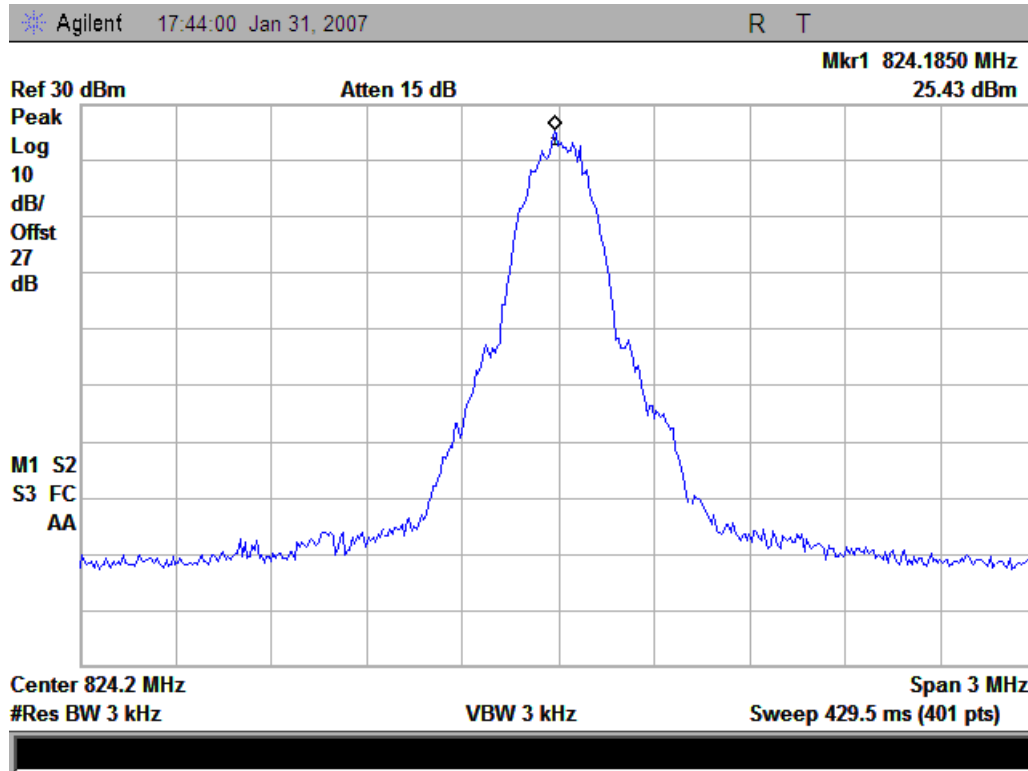

2. Plot when the TCH number set to 251:

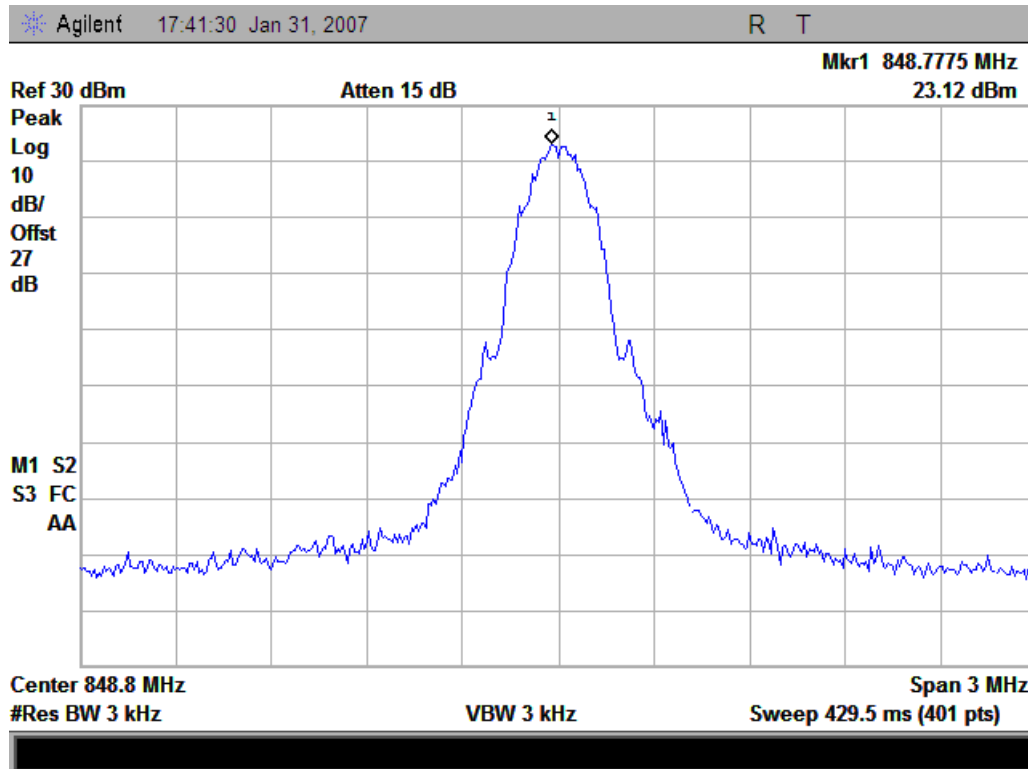

3.3 Conducted RF Output Power

3.3.1 Requirement

According to FCC §2.1046 (a), for transmitters other than single sideband, independent sideband and controlled carrier radiotelephone, power output shall be measured at the RF output terminals when the transmitter is adjusted in accordance with the tune-up procedure to give the values of current and voltage on the circuit elements specified in §2.1033 (c)(8). The electrical characteristics of the radio frequency load attached to the output terminals when this test is made shall be stated.

3.3.2 Test Procedure

1. Perform test system setup as section 3.1.1 (the radio frequency load attached to the EUT antenna terminal is 50Ω).
2. The resolution bandwidth of the Spectrum Analyzer is set to be comparable to the emission bandwidth of the transmitter, e.g. for GSM modulated signal (here used): RBW=VBW=1MHz, for CDMA modulated signal: RBW=VBW=3MHz.
3. The low, middle and the high channels are selected to perform tests respectively. Set the TCH number to 128 as the low channel.
4. Set the frequency range of the Spectrum Analyzer suitably to capture the waveform; search peak and mark it; finally record the peak and the plot.
5. Set the TCH number to 190 as the middle channel, then repeat step 4.
6. Set the TCH number to 251 as the high channel, then repeat step 4.

3.3.3 Test Result

No.	Channel Number	Frequency (MHz)	Measured Power		Rated Power	
			dBm	W	dBm	W
1	128	824.2	31.93	1.56	33	2
2	190	836.6	31.65	1.46	33	2
3	251	848.8	31.12	1.29	33	2

1. Plot when the TCH number set to 128:

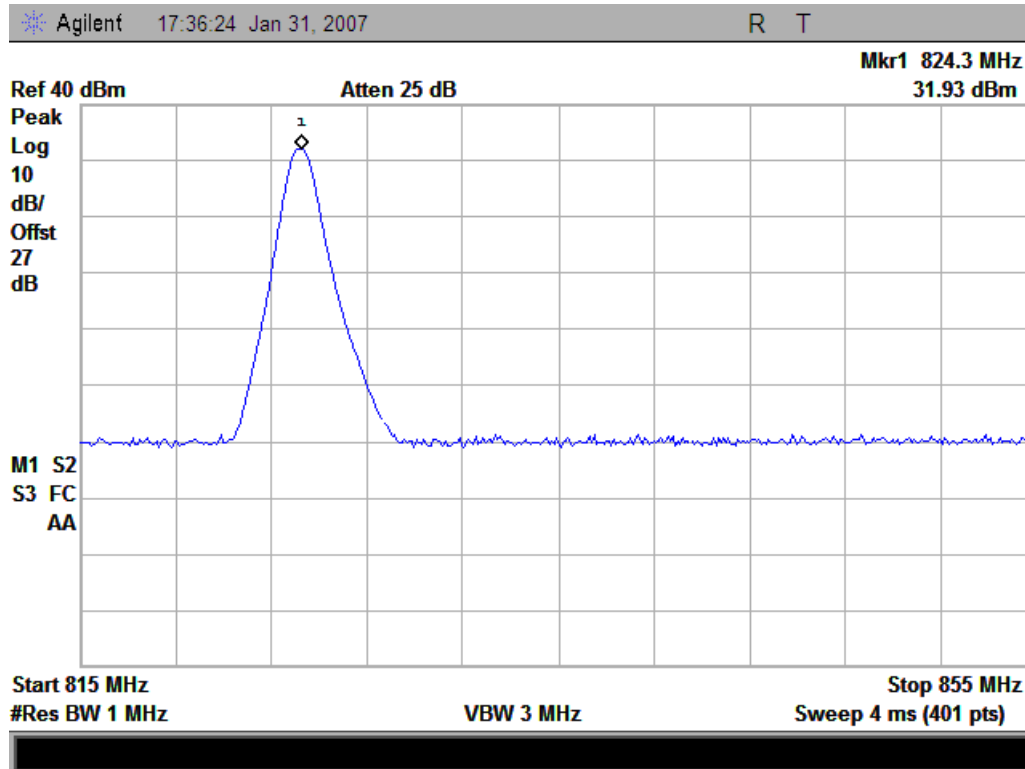

2. Plot when the TCH number set to 190:

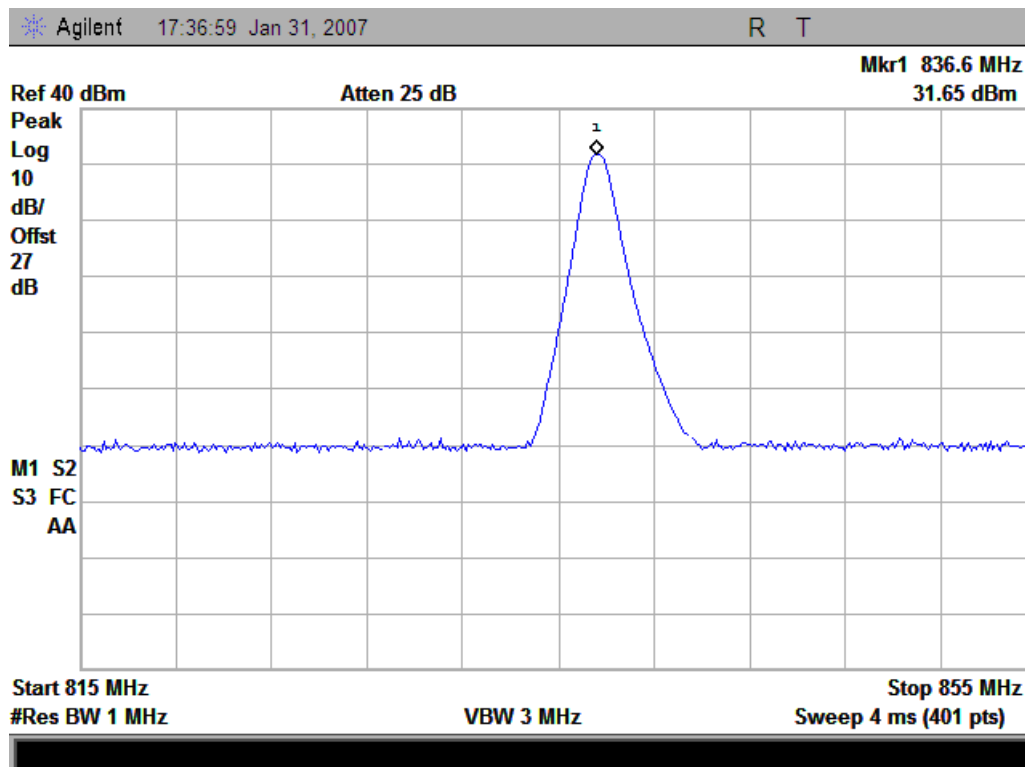

3. Plot when the TCH number set to 251:

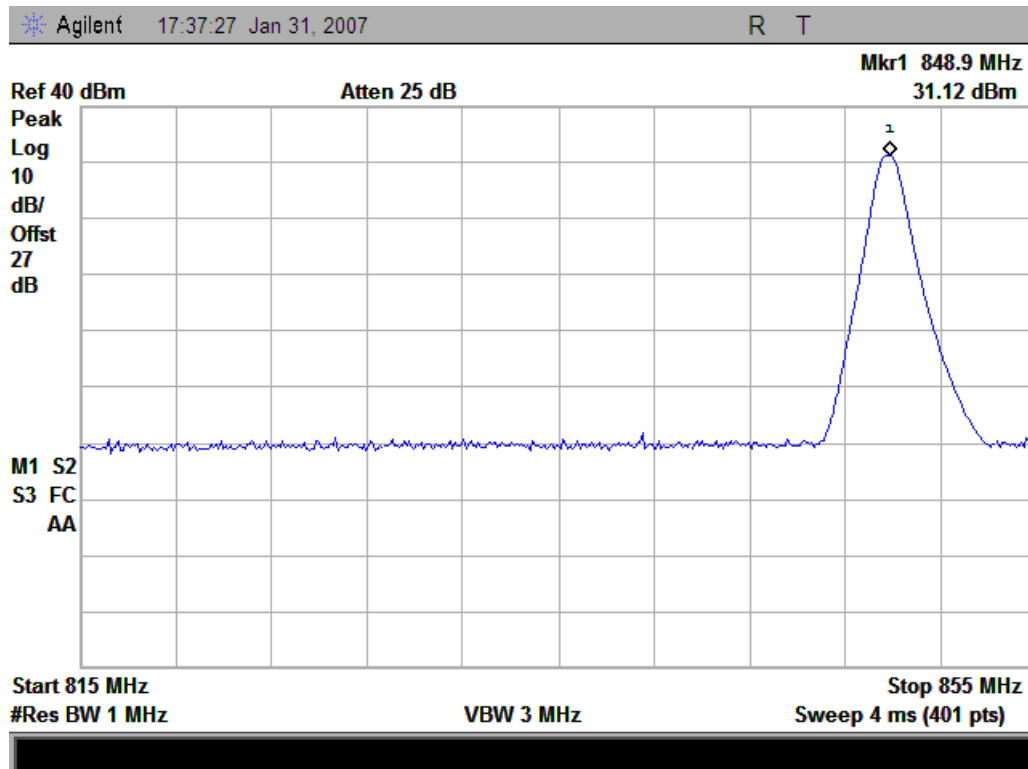

3.4 Occupied Bandwidth

3.4.1 Occupied Bandwidth Definition

According to FCC §2.1049, the occupied bandwidth is the frequency bandwidth such that, below its lower and above its upper frequency limits, the mean powers radiated are each equal to 0.5 percent of the total mean power radiated by a given emission.

Occupied bandwidth is also known as the 99% emission bandwidth, or 20dB bandwidth ($10 \cdot \log 1\%$ is equal to 20dB) taking the total RF output power as reference.

3.4.2 Test Procedure

1. Perform test system setup as section 3.1.1.
2. The resolution bandwidth of the Spectrum Analyzer is set to at least one percent of the emission bandwidth, e.g. for GSM modulated signal (here used): RBW=VBW=3kHz, for CDMA modulated signal: RBW=VBW=30kHz.
3. The low, middle and the high channels are selected to perform tests respectively. Set the TCH number to 128 as the low channel.
4. Set the frequency range of the Spectrum Analyzer suitably to capture the waveform; search peak; make a line whose value is 20dB lower than the peak; mark two points which the line intersected the waveform at; finally record the delta of the two points as the occupied bandwidth and the plot.
5. Set the TCH number to 190 as middle channel, then repeat step 4.
6. Set the TCH number to 251 as high channel, then repeat step 4.

3.4.3 Test Result

No.	Channel	Frequency (MHz)	Measured Occupied Bandwidth (kHz)
1	128	824.2	285.0
2	190	836.6	285.0
3	251	848.8	292.5

1. Plot when the TCH number set to 128:

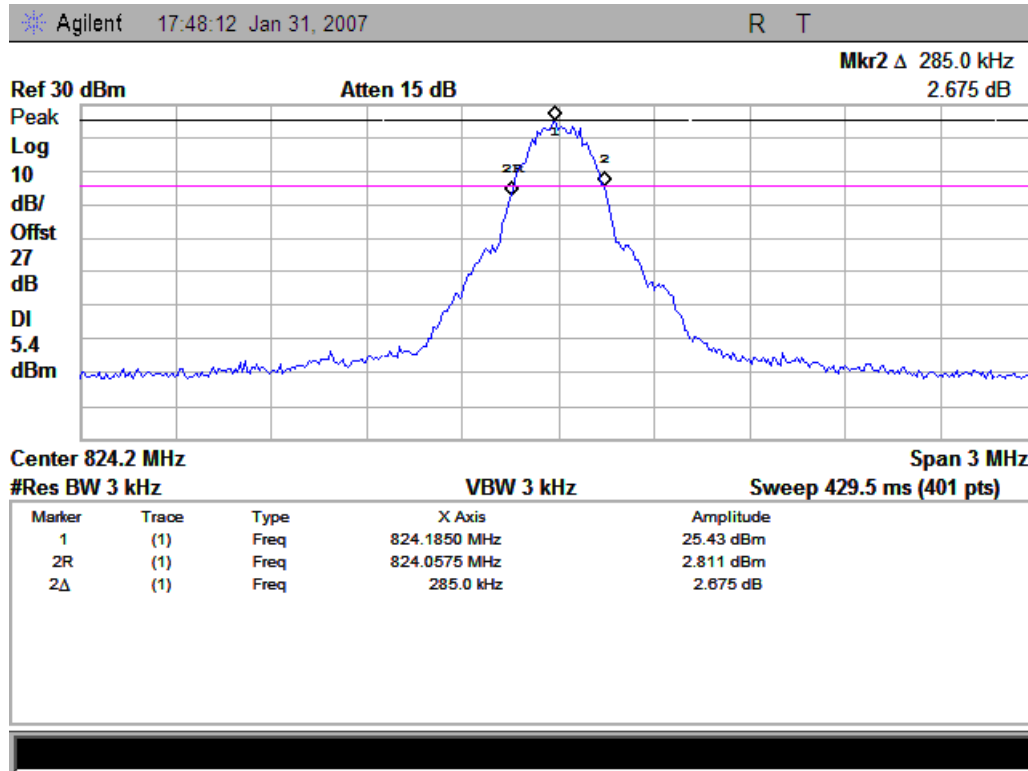

2. Plot when the TCH number set to 190:

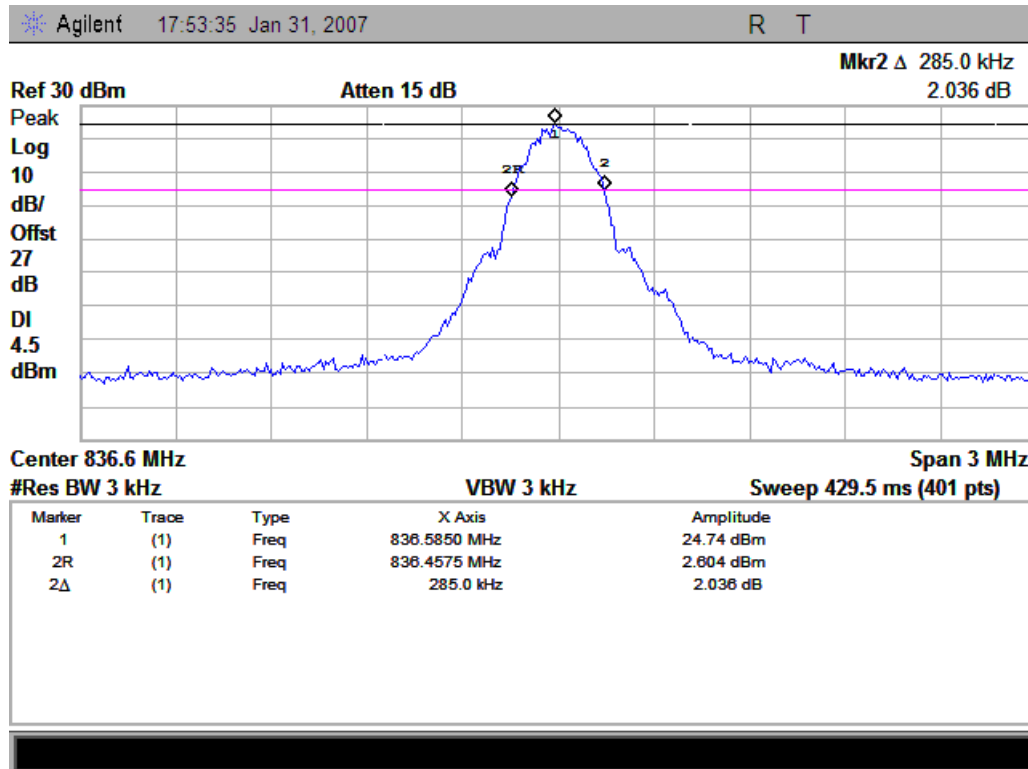

3. Plot when the TCH number set to 810:

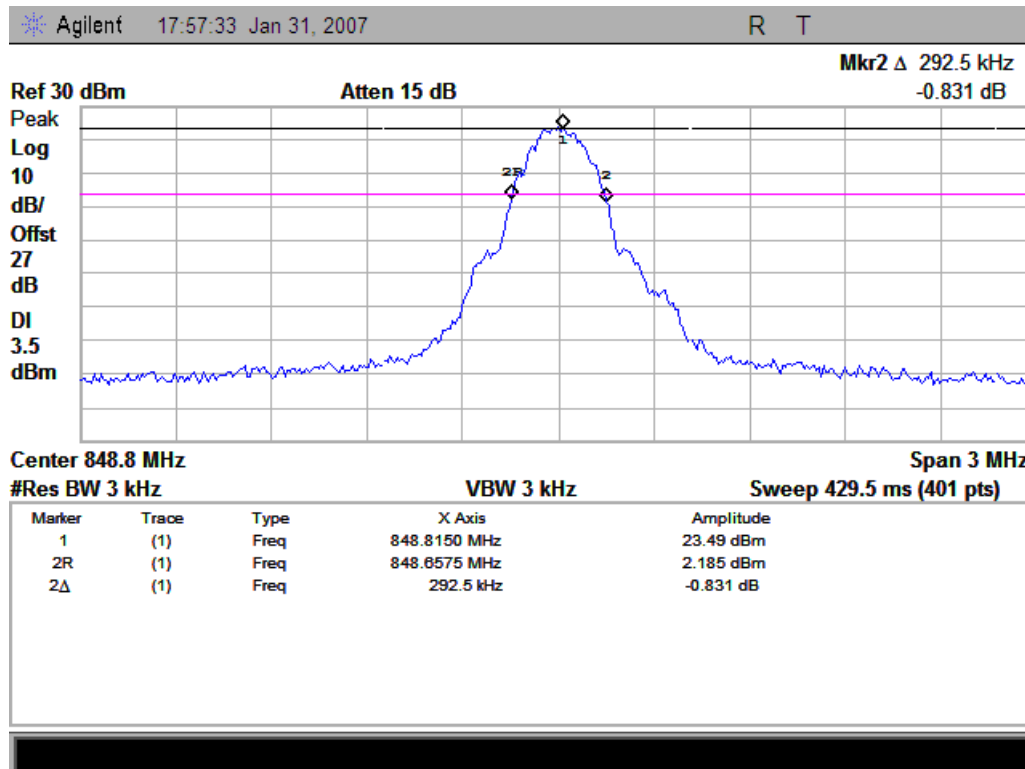

3.5 Conducted Spurious Emission

3.5.1 Requirement

According to FCC §22.917(a), the power of any emission outside of the authorized operating frequency ranges must be attenuated below the transmitting power (P) by a factor of at least $43+10*\log(P)$ dB. This calculated to be -13dBm.

According to FCC §22.917 (a), in the 1MHz bands immediately outside and adjacent to the frequency block a resolution bandwidth of at least one percent of the emission bandwidth of the fundamental emission of the transmitter may be employed. Thus the 26dB emission bandwidth is measurement for showing compliance at the band-edge.

3.5.2 Test Procedure

1. Perform test system setup as section 3.1.1.
2. Make a limit line whose value is -13dBm on the Spectrum Analyzer.
3. The lowest, middle and the highest channels are selected to perform tests respectively. Set the TCH number to 128 as the lowest channel.
4. Set the RBW of the Spectrum Analyzer to 1MHz, and the measuring frequency range from 9kHz to 10th harmonic of the fundamental frequency (here used 26.5GHz); mark the fundamental frequency and the harmonics thereof; finally record the harmonics and the plot. Note, the measuring frequency range can be divided into several parts to perform tests.
5. In the 1MHz bands immediately outside and adjacent to the frequency black, the RBW of the Spectrum Analyzer was set to at least one percent of the emission bandwidth of the fundamental emission of the transmitter, e.g. for GSM modulated signal (here used): RBW=3kHz, for CDMA modulated signal: RBW=30kHz.
6. Set the TCH number to 190 as the middle channel, then repeat step 4.
7. Set the TCH number to 251 as the highest channel, then repeat step 4 and 5.

3.5.3 Test Result

3.5.3.1 Table for the Harmonics and Plots for the Spurious Emission

1. Table for the Harmonics:

NOTE: “---” in the table following means that the emission power was too small to be measured and was at least 12dB below the limit.

No.	Frequency (MHz)	Emission Power (dBm)	Limit (dBm)
TCH number set to 128 (824.20MHz)			
1	1648.40	---	-13
2	2472.60	-22.76	-13
3	3296.80	---	-13
4	4121.00	---	-13
5	4945.20	---	-13
6	5769.40	---	-13
7	6593.60	---	-13
8	7417.80	---	-13
9	8242.00	---	-13
TCH number set to 190 (836.60MHz)			
10	1673.20	---	-13
11	2509.80	-23.82	-13
12	3346.40	---	-13
13	4183.00	---	-13
14	5019.60	---	-13
15	5856.20	---	-13
16	6692.80	---	-13
17	7529.40	---	-13
18	8366.00	---	-13
TCH number set to 251 (848.80MHz)			
19	1697.60	---	-13
20	2546.40	-25.05	-13
21	3395.20	---	-13
22	4244.00	---	-13
23	5092.80	---	-13
24	5941.60	---	-13
25	6790.40	---	-13
26	7639.20	---	-13
27	8488.00	---	-13

2. Plot for Spurious Emission:

The measuring frequency range was from 9kHz to 10GHz.

NOTE: The marker points are the Mobile Phone and/or System Simulator transmitting frequencies which should be ignored.

2.1 Plot when the TCH number set to 128:

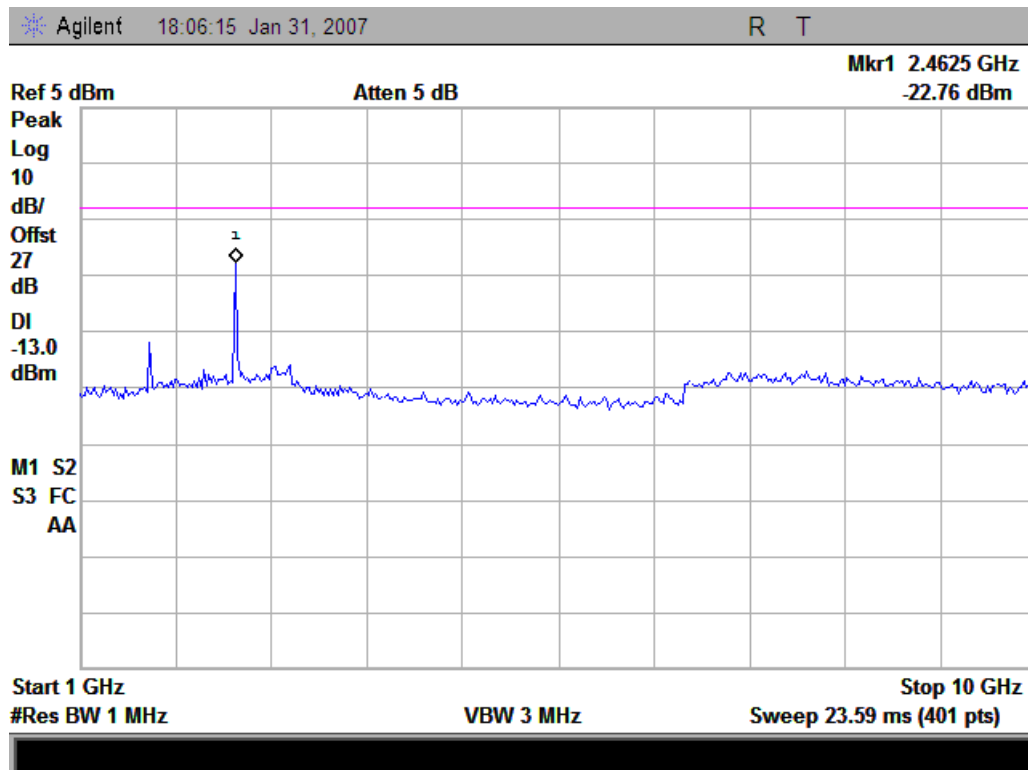
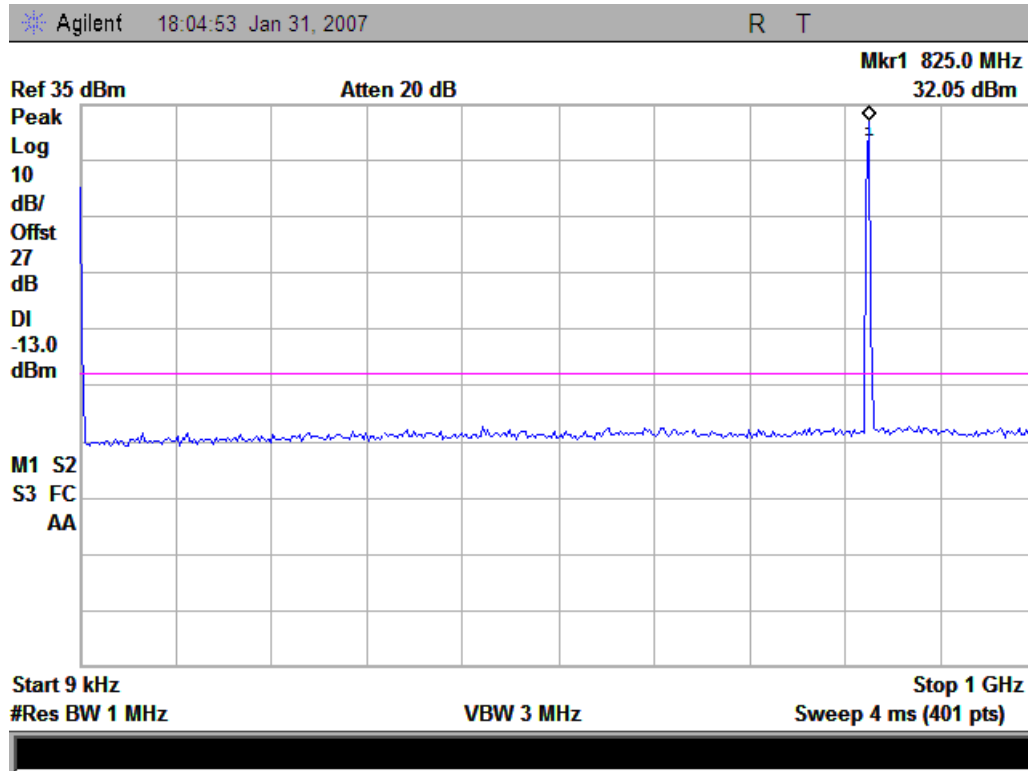

2.2 Plot when the TCH number set to 190:

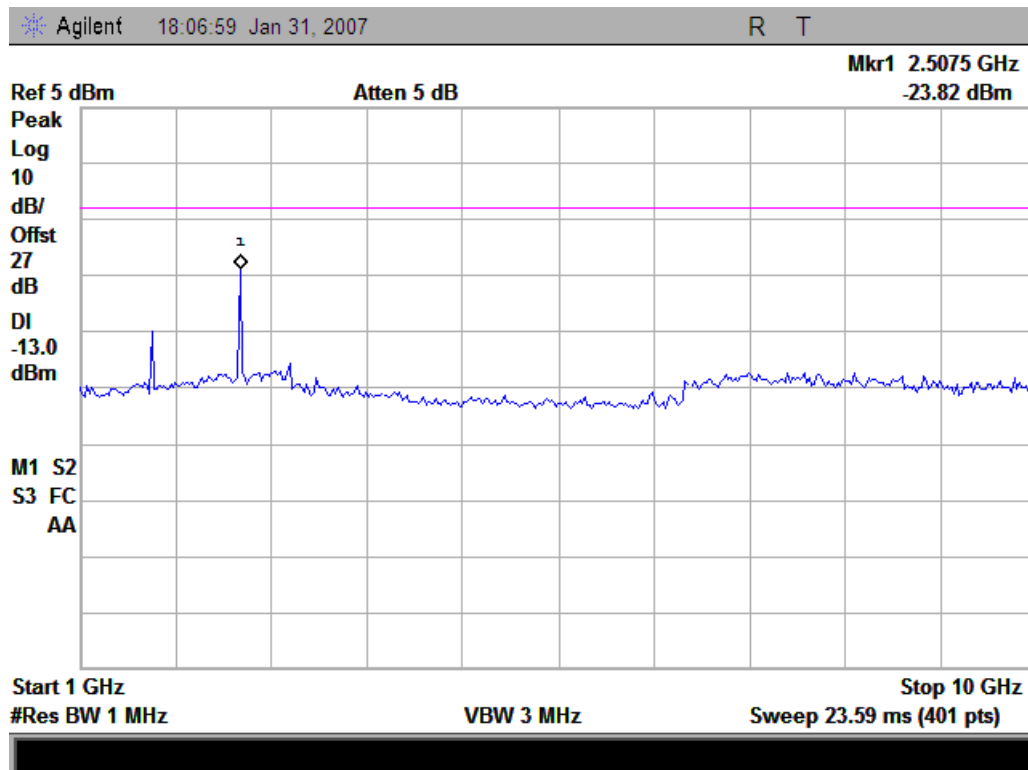
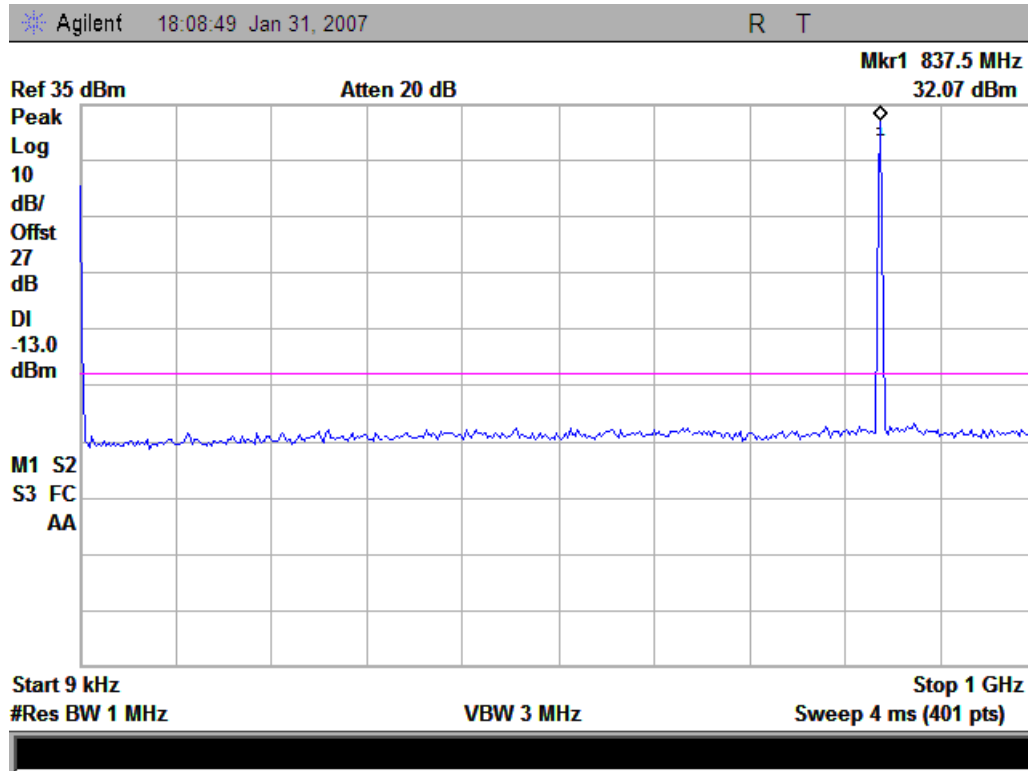

2.3 Plot when the TCH number set to 251:

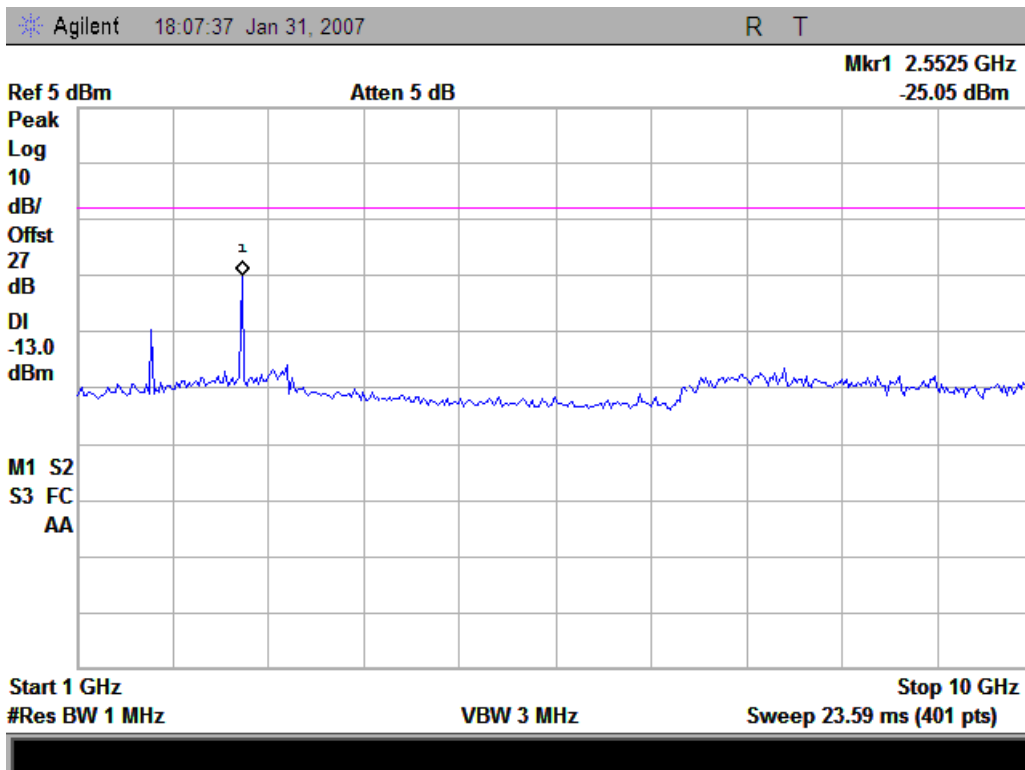
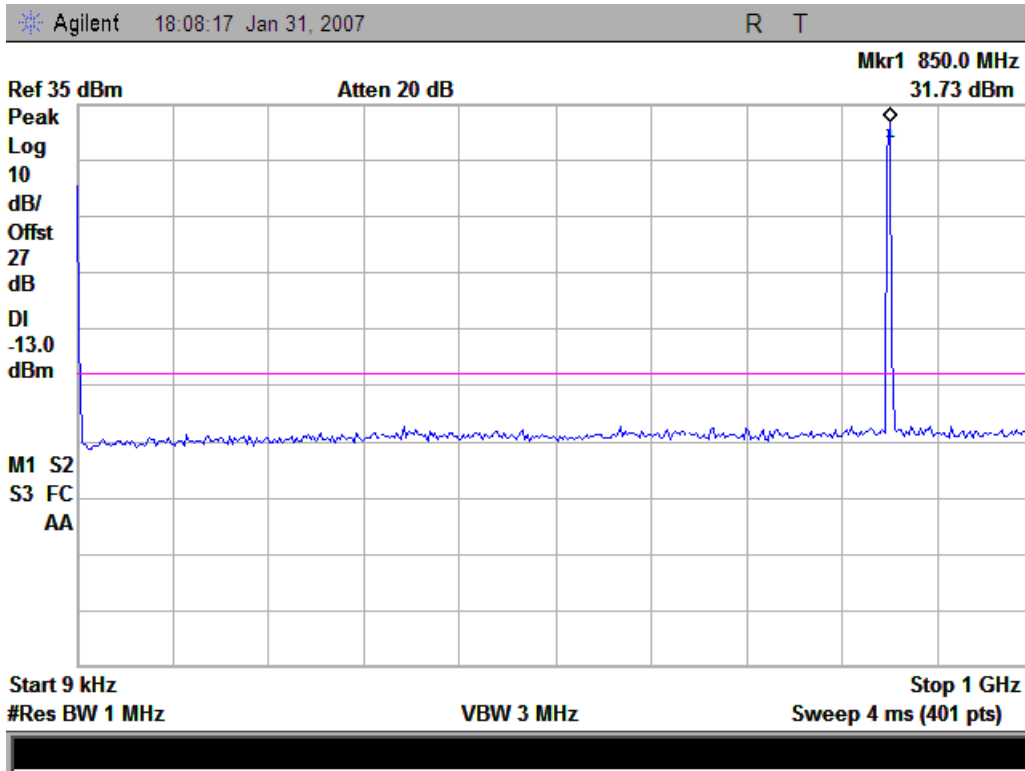

3.5.3.2 Plot for Band-edge

- Plot when the TCH number set to 128:

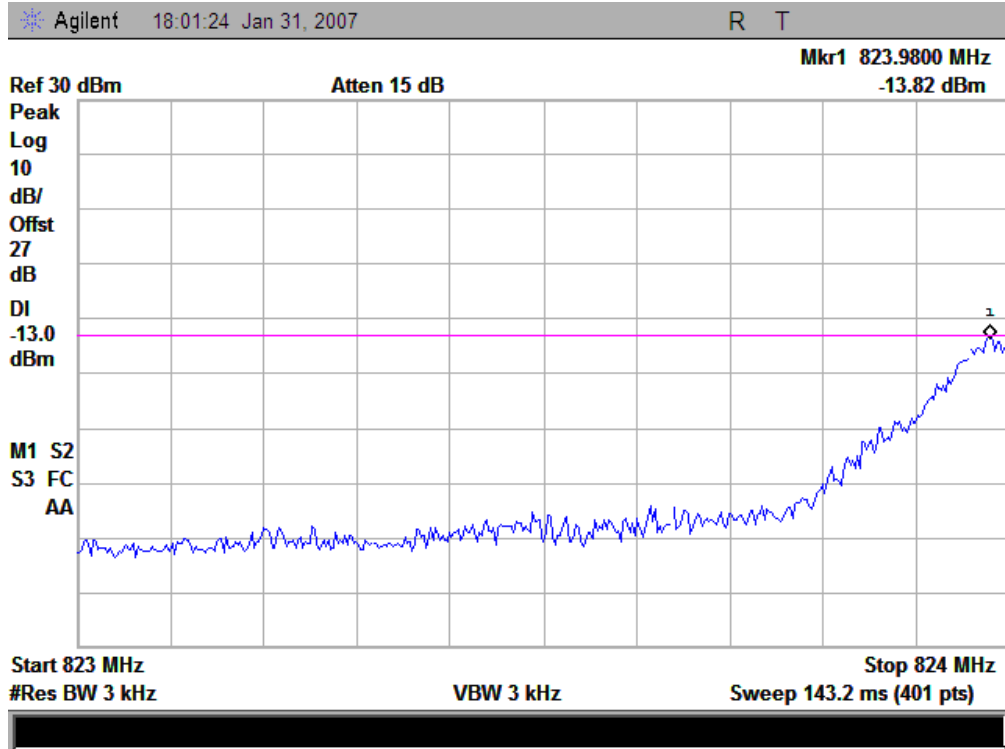

- Plot when the TCH number set to 251:

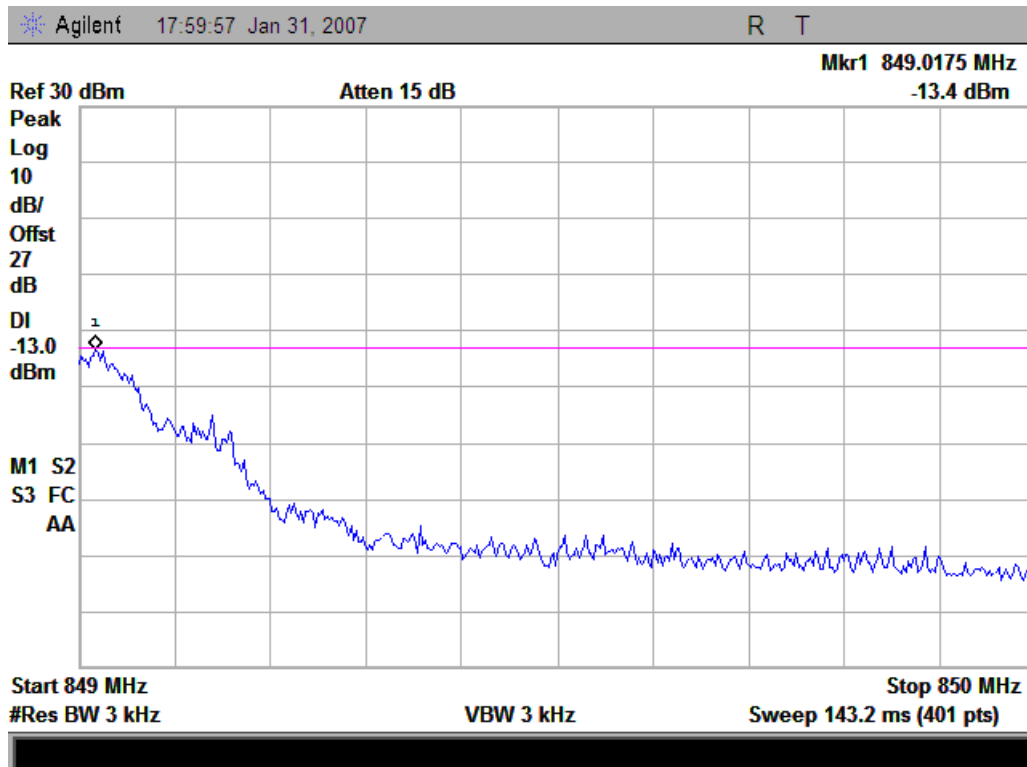

3.6 Transmitter Radiated Power (EIRP/ERP)

3.6.1 Requirement

According to FCC §22.913, the ERP of Cellular mobile transmitters must not exceed 7 Watts (38.5dBm).

3.6.2 Test Procedure

1. Perform test system setup as section 3.1.2.
2. The resolution bandwidth of the Spectrum Analyzer is set to be comparable to the emission bandwidth of the transmitter, e.g. for GSM modulated signal (here used): RBW=VBW=1MHz, for CDMA modulated signal: RBW=VBW=3MHz.
3. The low, middle and the high channels are selected to perform tests respectively. Set the TCH number to 128 as the low channel.
4. Employ the bi-log Test Antenna as the test system receiving antenna; set the polarization of the Test Antenna to be the same as that of the EUT transmitting antenna.
5. Set the frequency range of the Spectrum Analyzer suitably to capture the waveform; actuate the Turn Table to turn from 0 degrees to 360 degrees to find the maximum reading via the Spectrum Analyzer, mark the peak; finally record the peak and the plot.
6. Set the TCH number to 190 as the middle channel, then repeat step 5.
7. Set the TCH number to 251 as the high channel, then repeat step 5.

3.6.3 Test Result

No.	Channel	Frequency (MHz)	Measured ERP		Limit ERP		Result
			dBm	W	dBm	W	
1	128	824.20	16.56	0.045	< 38.5	< 7	PASS
2	190	836.60	16.66	0.046	< 38.5	< 7	PASS
3	251	848.80	16.82	0.048	< 38.5	< 7	PASS

1. Plot when the TCH number set to 128:

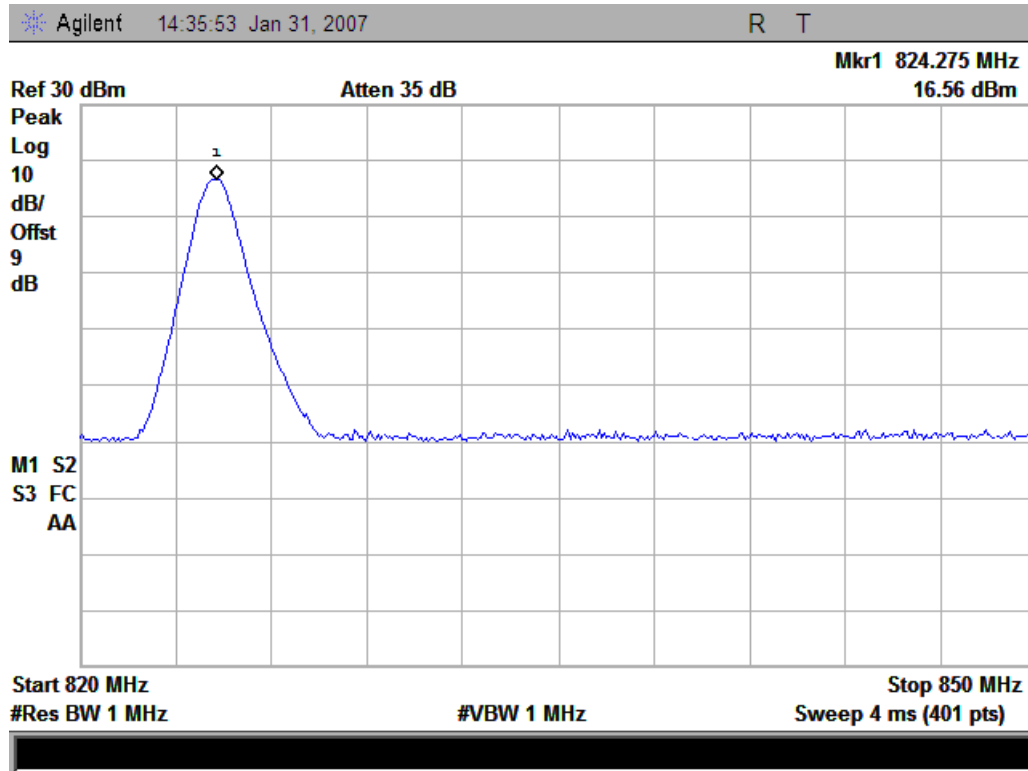

2. Plot when the TCH number set to 190:

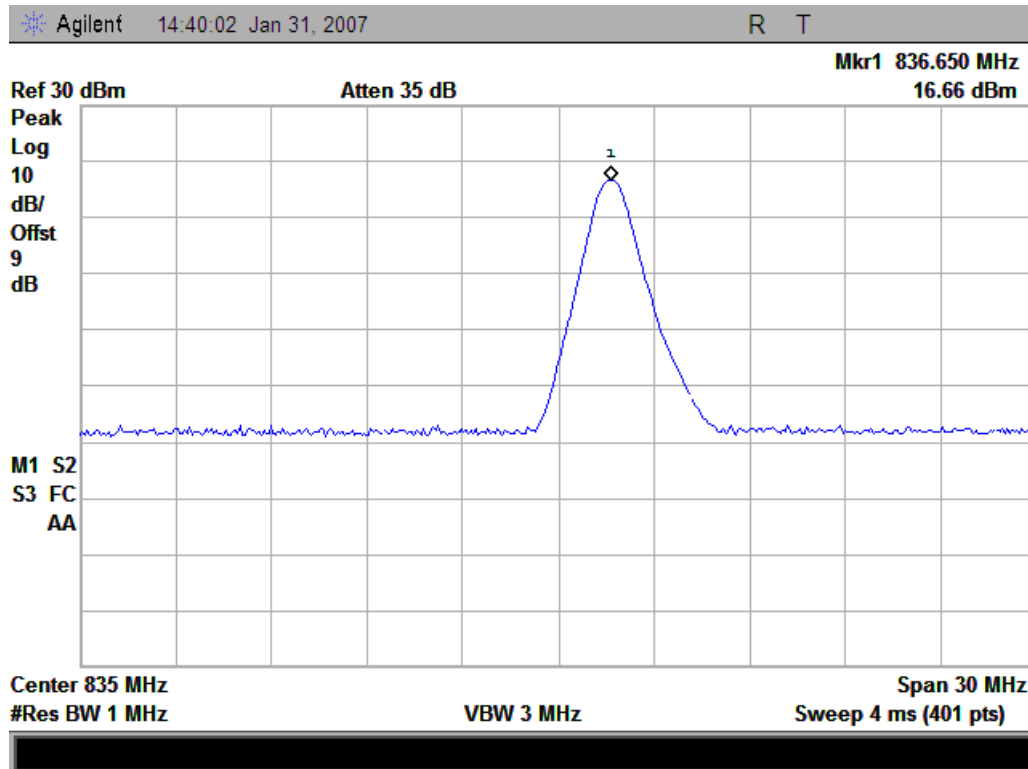

3. Plot when the TCH number set to 251:

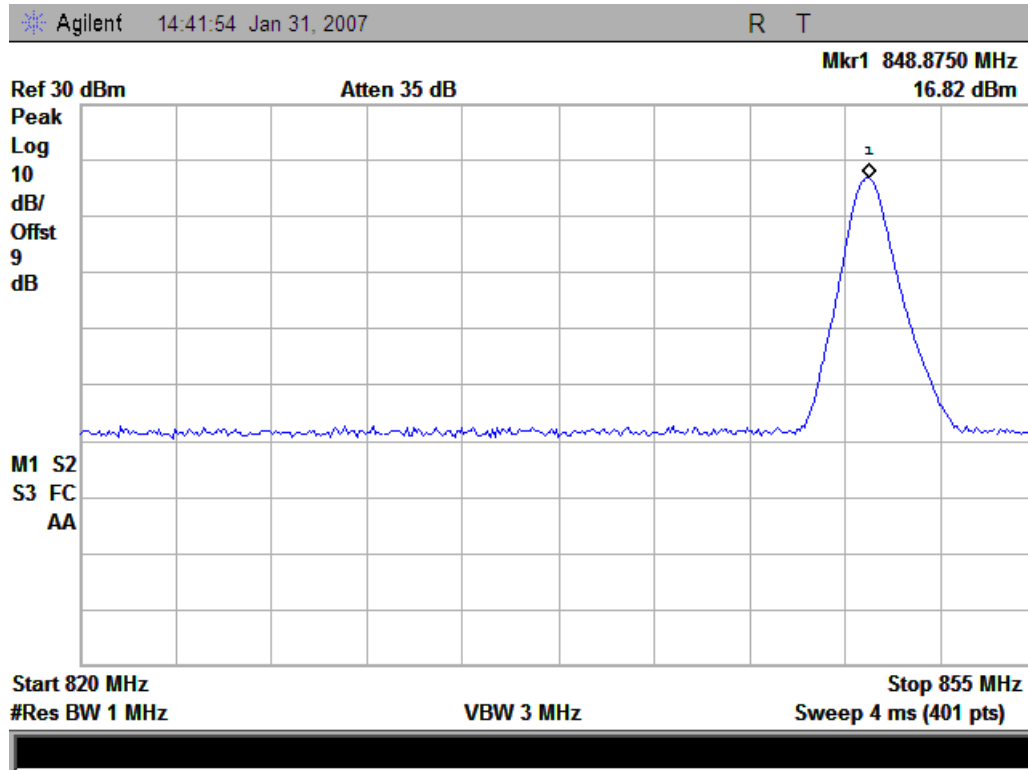

3.7 Radiated Spurious Emission

3.7.1 Requirement

According to FCC §22.917(a), the power of any emission outside of the authorized operating frequency ranges must be attenuated below the transmitting power (P) by a factor of at least $43+10*\log(P)$ dB. This calculated to be -13dBm.

3.7.2 Test Procedure

1. Perform test system setup as section 3.1.2.
2. Make a limit line whose value is -13dBm on the Spectrum Analyzer, and set the RBW of the Spectrum Analyzer to 1MHz.
3. The low, middle and the high channels are selected to perform tests respectively. Set the TCH number to 128 as the low channel.
4. Employ the bi-log Test Antenna as the test system receiving antenna and set the frequency range of the Spectrum Analyzer from 30MHz to 3GHz.
5. The measurement is performed with the Test Antenna at both horizontal and vertical polarization respectively. Set the polarization of the Test Antenna to be horizontal.
6. Actuate the Turn Table to turn from 0 degrees to 360 degrees to find the maximum reading via the Spectrum Analyzer, mark the fundamental frequency and the harmonics thereof, after then record the harmonics and the plot.
7. Set the polarization of the Test Antenna to be vertical, then repeat step 6.
8. Employ the horn Test Antenna as the test system receiving antenna and set the frequency range of the Spectrum Analyzer from 3GHz to 10th harmonic of the fundamental frequency (here used 10GHz), then repeat step 5 to 7.
9. Set the TCH number to 190 as the middle channel, then repeat step 4 to 8.
10. Set the TCH number to 251 as the high channel, then repeat step 4 to 8.

3.7.3 Test Result

3.7.3.1 Table for the Harmonics

NOTE: “---” in the table following means that the emission power was too small to be measured and was at least 12dB below the limit.



No.	Frequency (MHz)	Emission Power (dBm)		Limit (dBm)
		Test Antenna Vertical	Test Antenna Horizontal	
TCH number set to 128 (824.20MHz)				
1	1648.40	-40.26	-44.01	-13
2	2472.60	-47.11	-50.34	-13
3	3296.80	---	---	-13
4	4121.00	---	---	-13
5	4945.20	---	---	-13
6	5769.40	---	---	-13
7	6593.60	---	---	-13
8	7417.80	---	---	-13
9	8242.00	---	---	-13
TCH number set to 190 (836.60MHz)				
10	1673.20	-42.06	-44.57	-13
11	2509.80	-48.15	-52.23	-13
12	3346.40	---	---	-13
13	4183.00	---	---	-13
14	5019.60	---	---	-13
15	5856.20	---	---	-13
16	6692.80	---	---	-13
17	7529.40	---	---	-13
18	8366.00	---	---	-13
TCH number set to 251 (848.80MHz)				
19	1697.60	-41.73	-45.68	-13
20	2546.40	-49.25	-52.54	-13
21	3395.20	---	---	-13
22	4244.00	---	---	-13
23	5092.80	---	---	-13
24	5941.60	---	---	-13
25	6790.40	---	---	-13
26	7639.20	---	---	-13
27	8488.00	---	---	-13

3.8 Frequency Stability

3.8.1 Frequency Stability Requirement

According to FCC §22.355, the frequency stability shall be sufficient to ensure that the fundamental emission stays within the authorized frequency block.

According to FCC §2.1055, the test conditions are:

- (a) Temperature:
The temperature is varied from -30°C to $+50^{\circ}\text{C}$ at intervals of not more than 10°C .
- (b) Primary Supply Voltage:
For hand carried battery powered equipment, the primary supply voltage is reduced to the battery operating end point which shall be specified by the manufacture. The supply voltage shall be measured at the input to the cable normally provided with the equipment, or at the power supply terminals if cables are not normally provided.

3.8.2 Test Procedure

1. Perform test system setup as section 3.1.3.
2. Set the voltage of the DC Power Supply to normal supply voltage (here used 3.7V) and the temperature of the Temperature Chamber to vary from -30°C to $+50^{\circ}\text{C}$ at intervals of 10°C .
3. At each temperature level, the EUT is powered off and kept in the Temperature Chamber for two hours. After sufficient stabilization, turn on the EUT, command it via the System Simulator (SS) to operate at the maximum output power i.e. Power Control Level (PCL) = 0 and Power Class = 1, and then establish a communication link between the EUT and the SS.
4. The low, middle and the high channels are selected to perform tests respectively. Set the TCH number to 128 as the low channel.
5. The frequency deviation is measured (directly read from the SS, which can report the parameter) within three minutes.
6. Set the TCH number to 190 as the middle channel, then repeat step 5.
7. Set the TCH number to 251 as the high channel, then repeat step 5.
8. Adjust the temperature of the Temperature Chamber as specified in step 2, then repeat step 3 to 7.
9. Set the voltage of the DC Power Supply to high extreme supply voltage (here used 4.2V) and the temperature of the Temperature Chamber to normal (here used $+22^{\circ}\text{C}$), then repeat step 3 to 8.
10. Set the voltage of the DC Power Supply to low extreme supply voltage (here used 3.6V) and the temperature of the Temperature Chamber to normal (here used $+22^{\circ}\text{C}$), then repeat step 3 to 8.

3.8.3 Test Result

No.	Test Conditions		Frequency Deviation (Hz) at Channels Used			
	Voltage	Temperature	128	190	251	Limit (± 2.5 ppm)
1	3.7V	-30°C	-25.34	-27.16	-31.62	(a) ± 2060 Hz for 128 Channel (b) ± 2096 Hz for 190 Channel (c) ± 3055 Hz for 251 Channel
2		-20°C	-34.65	-28.34	-21.89	
3		-10°C	-10.86	14.37	-12.64	
4		0°C	30.52	-30.25	-33.54	
5		+10°C	-25.35	-32.51	-20.78	
6		+20°C	20.11	-24.50	-25.13	
7		+30°C	-30.10	-17.36	-30.53	
8		+40°C	-20.59	-25.92	-40.25	
9		+50°C	-35.16	40.25	-45.18	
10	4.2V	+22°C	-30.13	-22.16	-30.11	
11	3.6V	+22°C	25.12	-28.02	-20.63	
Result: PASS						

I Photograph of the test setup

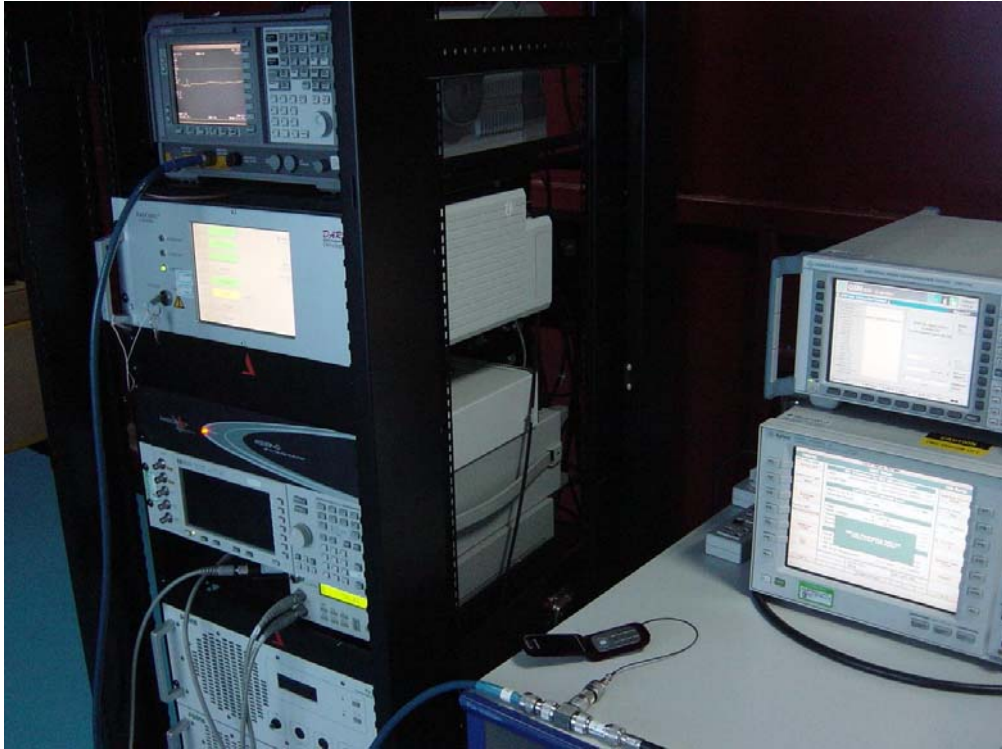

II Photograph of the EUT

1. Appearance of the EUT









2. Appearance of the Adapter





3. Inside of the Adapter



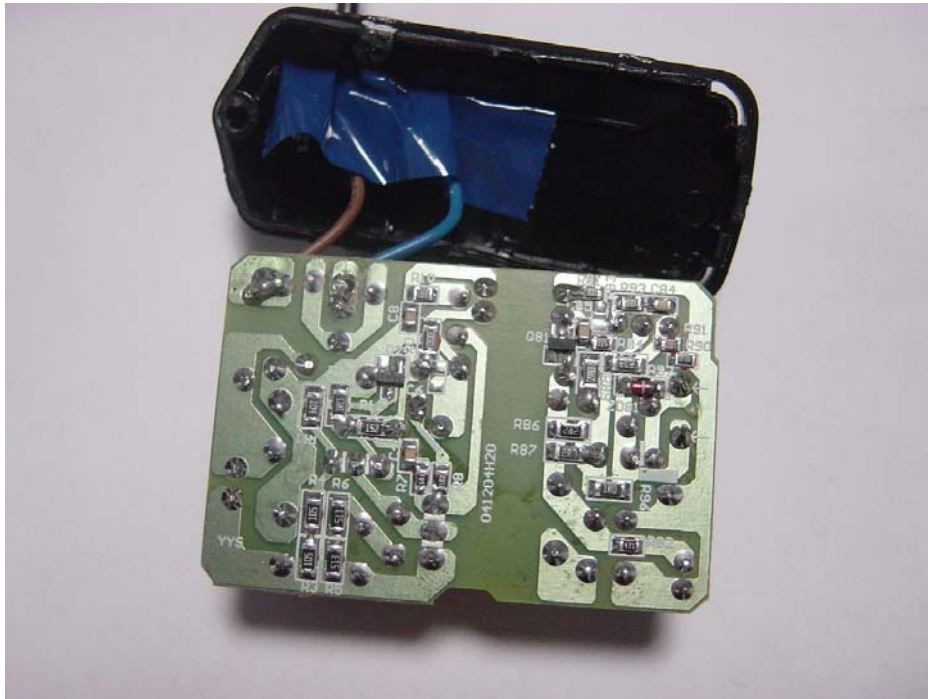

4. Inside of the EUT



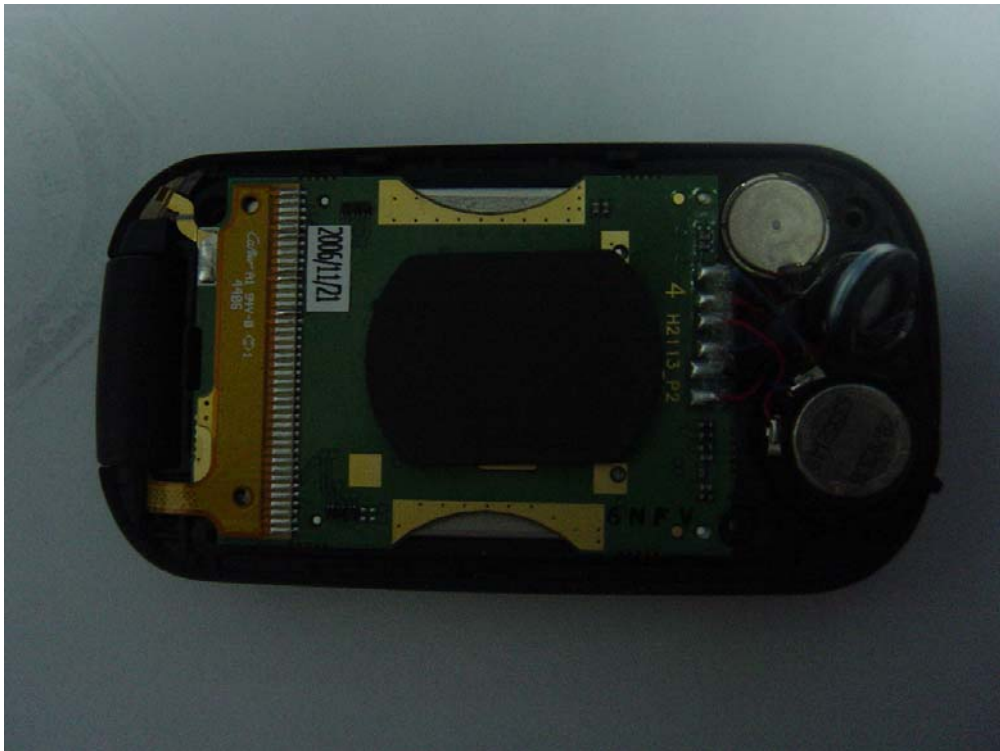



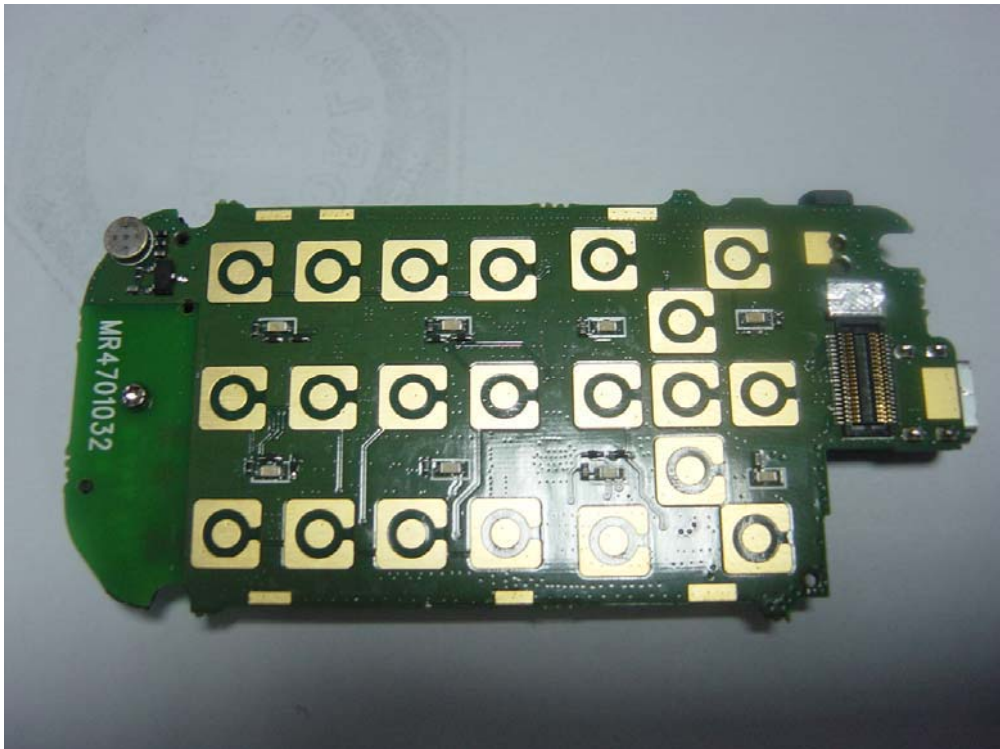

5. Appearance of the headset

