



TEST REPORT

Test report no.: 1-8298/19-01-03

BNetzA-CAB-02/21-102

Testing laboratory

CTC advanced GmbH

Untertuerkheimer Strasse 6 – 10

66117 Saarbruecken / Germany

Phone: + 49 681 5 98 - 0

Fax: + 49 681 5 98 - 9075

Internet: <http://www.ctcadvanced.com>

e-mail: mail@ctcadvanced.com

Accredited Testing Laboratory:

The testing laboratory (area of testing) is accredited according to DIN EN ISO/IEC 17025 (2005) by the Deutsche Akkreditierungsstelle GmbH (DAkkS)

The accreditation is valid for the scope of testing procedures as stated in the accreditation certificate starting with the registration number: D-PL-12076-01

Applicant

Trackman

Stubbeled 2

2950 Vedbæk / DENMARK

Phone: +45 4557 0850

Contact: Soeren Carlsen

e-mail: scr@trackman.com

Phone:

Manufacturer

Trackman

Stubbeled 2

2950 Vedbæk / DENMARK

Test standard/s

FCC - Title 47 CFR Part 15

FCC - Title 47 of the Code of Federal Regulations; Chapter I; Part 15 - Radio frequency devices

RSS - 210 Issue 9 Annex F

Spectrum Management and Telecommunications Radio Standards Specification - Licence-Exempt Radio Apparatus: Category I Equipment

RSS - Gen Issue 5

Spectrum Management and Telecommunications Radio Standards Specification - General Requirements for Compliance of Radio Apparatus

For further applied test standards please refer to section 3 of this test report.

Test Item

Kind of test item: Field Disturbance Sensor

Model name: TMC3G

FCC ID: SFX-TMC3G

IC: 10140A-TMC3G

Frequency: 10.50 – 10.55 GHz

Antenna: Integrated antenna

Power supply: 125 V AC

Temperature range: -15°C to +50°C



This test report is electronically signed and valid without handwritten signature. For verification of the electronic signatures, the public keys can be requested at the testing laboratory.

Test report authorized:

p.o.

Karsten Gerald
Lab Manager
Radio Communications & EMC

Test performed:

Meheza Walla
Lab Manager
Radio Communications & EMC

1 Table of contents

1	Table of contents	2
2	General information	3
2.1	Notes and disclaimer	3
2.2	Application details.....	3
2.3	Test laboratories sub-contracted	3
3	Test standard/s, references and accreditations.....	4
4	Test environment.....	5
5	Test item.....	5
5.1	General description.....	5
5.2	Additional information	5
6	Description of the test setup.....	6
6.1	Shielded semi anechoic chamber.....	7
6.2	Shielded fully anechoic chamber	9
6.3	Radiated measurements > 18 GHz.....	10
6.4	Radiated measurements > 50/85 GHz.....	10
6.5	AC conducted	12
7	Sequence of testing	13
7.1	Sequence of testing radiated spurious 9 kHz to 30 MHz.....	13
7.2	Sequence of testing radiated spurious 30 MHz to 1 GHz.....	14
7.3	Sequence of testing radiated spurious 1 GHz to 18 GHz	15
7.4	Sequence of testing radiated spurious above 18 GHz	16
7.5	Sequence of testing radiated spurious above 50 GHz with external mixers	17
8	Measurement uncertainty	18
9	Summary of measurement results	19
10	Measurement results	20
10.1	Field strength of emissions (wanted signal).....	20
10.2	Occupied bandwidth (99% bandwidth).....	23
10.3	Field strength of emissions and band edge (radiated spurious).....	24
10.4	Conducted spurious emissions < 30 MHz.....	44
Annex A	Glossary.....	47
Annex B	Document history	48
Annex C	Accreditation Certificate – D-PL-12076-01-04	48
Annex D	Accreditation Certificate – D-PL-12076-01-05	49

2 General information

2.1 Notes and disclaimer

The test results of this test report relate exclusively to the test item specified in this test report. CTC advanced GmbH does not assume responsibility for any conclusions and generalizations drawn from the test results with regard to other specimens or samples of the type of the equipment represented by the test item.

The test report may only be reproduced or published in full. Reproduction or publication of extracts from the report requires the prior written approval of CTC advanced GmbH.

The testing service provided by CTC advanced GmbH has been rendered under the current "General Terms and Conditions for CTC advanced GmbH".

CTC advanced GmbH will not be liable for any loss or damage resulting from false, inaccurate, inappropriate or incomplete product information provided by the customer.

Under no circumstances does the CTC advanced GmbH test report include any endorsement or warranty regarding the functionality, quality or performance of any other product or service provided.

Under no circumstances does the CTC advanced GmbH test report include or imply any product or service warranties from CTC advanced GmbH, including, without limitation, any implied warranties of merchantability, fitness for purpose, or non-infringement, all of which are expressly disclaimed by CTC advanced GmbH.

All rights and remedies regarding vendor's products and services for which CTC advanced GmbH has prepared this test report shall be provided by the party offering such products or services and not by CTC advanced GmbH. In no case this test report can be considered as a Letter of Approval.

This test report is electronically signed and valid without handwritten signature. For verification of the electronic signatures, the public keys can be requested at the testing laboratory.

2.2 Application details

Date of receipt of order:	2019-09-16
Date of receipt of test item:	2019-09-18
Start of test:	2019-09-18
End of test:	2019-09-27
Person(s) present during the test:	Mr. Becker Saul Morten, Mr. Carlsen Soeren





2.3 Test laboratories sub-contracted

None

3 Test standard/s, references and accreditations

Test standard	Date	Description
FCC - Title 47 CFR Part 15		FCC - Title 47 of the Code of Federal Regulations; Chapter I; Part 15 - Radio frequency devices
RSS - 210 Issue 9 Annex F	08-2016	Spectrum Management and Telecommunications Radio Standards Specification - Licence-Exempt Radio Apparatus: Category I Equipment
RSS - Gen Issue 5	04-2018	Spectrum Management and Telecommunications Radio Standards Specification - General Requirements for Compliance of Radio Apparatus

Guidance	Version	Description
ANSI C63.4-2014	-/-	American National Standard for Methods of Measurement of Radio-Noise Emissions from Low-Voltage Electrical and Electronic Equipment in the Range of 9 kHz to 40 GHz
ANSI C63.10-2013	-/-	American National Standard of Procedures for Compliance Testing of Unlicensed Wireless Devices
ANSI C63.26-2015	-/-	American National Standard for Compliance Testing of Transmitters Used in Licensed Radio Services

Accreditation	Description	
D-PL-12076-01-04	Telecommunication and EMC Canada https://www.dakks.de/as/ast/d/D-PL-12076-01-04.pdf	  Deutsche Akkreditierungsstelle D-PL-12076-01-04
D-PL-12076-01-05	Telecommunication FCC requirements https://www.dakks.de/as/ast/d/D-PL-12076-01-05.pdf	  Deutsche Akkreditierungsstelle D-PL-12076-01-05

4 Test environment

Temperature	:	T _{nom}	+22 °C during room temperature tests
Relative humidity content	:		55 %
Power supply	:	V _{nom}	125 V AC

5 Test item

5.1 General description

Kind of test item	:	Field Disturbance Sensor	
Type identification	:	TMC3G	
HMN	:	N/A	
PMN	:	Baseball Field	
HVIN	:	TMC3G	
FVIN	:	N/A	
S/N serial number	:	EP1698380	
Hardware status	:	-/-	
Software status	:	-/-	
Frequency band	:	10.50 – 10.55 GHz	
Type of modulation	:	CW	
Number of channels	:	1	
Antenna	:	Integrated antenna	
Power supply	:	125 V AC	
Temperature range	:	-15°C to +50°C	

N/A: Not applicable

5.2 Additional information

Special test software was used to change from normal operation mode to test mode (low / middle / high) as required by CFR 47 Part 15.31(m). Each frequency consist of 2 simultaneous CW signals.

Low Channel F1 = 10.510 000 GHz and F2 = 10.518 500 GHz

Middle Channel F1 = 10.521 000 GHz and F2 = 10.529 500 GHz

High Channel F1 = 10.532 000 GHz and F2 = 10.540 500 GHz

Test setup and EUT photos are included in test report:

- 1-8298/19-01-01_AnnexA
- 1-8298/19-01-01_AnnexB
- 1-8298/19-01-01_AnnexC

6 Description of the test setup

Typically, the calibrations of the test apparatus are commissioned to and performed by an accredited calibration laboratory. The calibration intervals are determined in accordance with the DIN EN ISO/IEC 17025. In addition to the external calibrations, the laboratory executes comparison measurements with other calibrated test systems or effective verifications. Weekly chamber inspections and range calibrations are performed. Where possible, RF generating and signaling equipment as well as measuring receivers and analyzers are connected to an external high-precision 10 MHz reference (GPS-based or rubidium frequency standard).

In order to simplify the identification of the equipment used at some special tests, some items of test equipment and ancillaries can be provided with an identifier or number in the equipment list below (Lab/Item).

Agenda: Kind of Calibration

k	calibration / calibrated	EK	limited calibration
ne	not required (k, ev, izw, zw not required)	zw	cyclical maintenance (external cyclical maintenance)
ev	periodic self verification	izw	internal cyclical maintenance
Ve	long-term stability recognized	g	blocked for accredited testing
v/k!	Attention: extended calibration interval		
NK!	Attention: not calibrated	*)	next calibration ordered / currently in progress

6.1 Shielded semi anechoic chamber

The radiated measurements are performed in vertical and horizontal plane in the frequency range from 30 MHz to 1 GHz in semi-anechoic chambers. The EUT is positioned on a non-conductive support with a height of 0.80 m above a conductive ground plane that covers the whole chamber. The receiving antennas are conform to specifications ANSI C63. These antennas can be moved over the height range between 1.0 m and 4.0 m in order to search for maximum field strength emitted from EUT. The measurement distances between EUT and receiving antennas are indicated in the test setups for the various frequency ranges. For each measurement, the EUT is rotated in all three axes until the maximum field strength is received. The wanted and unwanted emissions are received by spectrum analyzers where the detector modes and resolution bandwidths over various frequency ranges are set according to requirement ANSI C63.

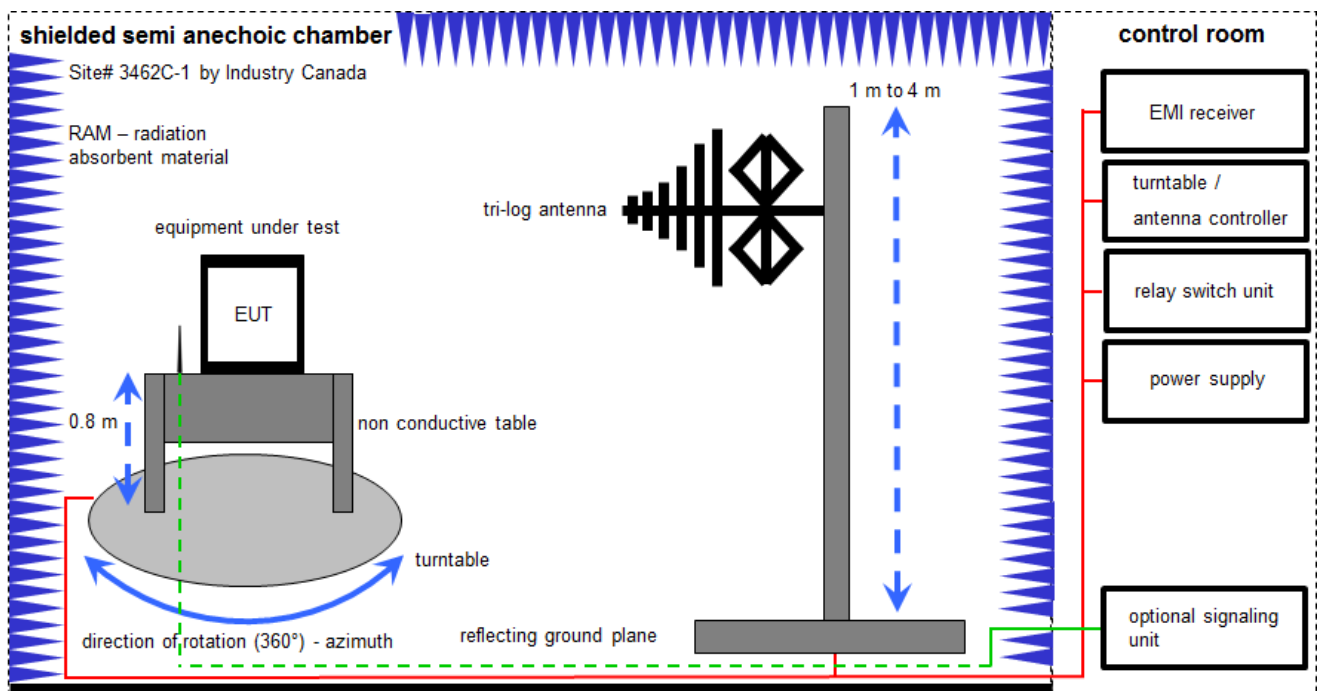

Measurement distance: tri-log antenna 10 meter
EMC32 software version: 10.30.0

$FS = UR + CL + AF$
(FS-field strength; UR-voltage at the receiver; CL-loss of the cable; AF-antenna factor)

Example calculation:

$FS [dB\mu V/m] = 12.35 [dB\mu V/m] + 1.90 [dB] + 16.80 [dB/m] = 31.05 [dB\mu V/m] (35.69 \mu V/m)$

Equipment table:

No.	Lab / Item	Equipment	Type	Manufacturer	Serial No.	INV. No.	Kind of Calibration	Last Calibration	Next Calibration
1	45	Switch-Unit	3488A	HP	2719A14505	300000368	ev	-/-	-/-
2	50	DC power supply, 60Vdc, 50A, 1200 W	6032A	HP	2920A04466	300000580	ne	-/-	-/-
3	93	Meißkabine 1	HF-Absorberhalle	MWB AG 300023		300000551	ne	-/-	-/-
4	n. a.	EMI Test Receiver	ESCI 3	R&S	100083	300003312	k	12.12.2018	11.12.2019
5	n. a.	Analyzer-Reference-System (Harmonics and Flicker)	ARS 16/1	SPS	A3509 07/0 0205	300003314	vKI!	15.01.2018	14.01.2020
6	n. a.	Antenna Tower	Model 2175	ETS-Lindgren	64762	300003745	izw	-/-	-/-
7	n. a.	Positioning Controller	Model 2090	ETS-Lindgren	64672	300003746	izw	-/-	-/-
8	n. a.	Turntable Interface-Box	Model 105637	ETS-Lindgren	44583	300003747	izw	-/-	-/-
9	n. a.	TRILOG Broadband Test-Antenna 30 MHz - 3 GHz	VULB9163	Schwarzbeck Mess - Elektronik	371	300003854	vKI!	24.11.2017	23.11.2020
10	n. a.	Spectrum-Analyzer	FSU26	R&S	200809	300003874	k	17.12.2018	16.12.2019

6.2 Shielded fully anechoic chamber

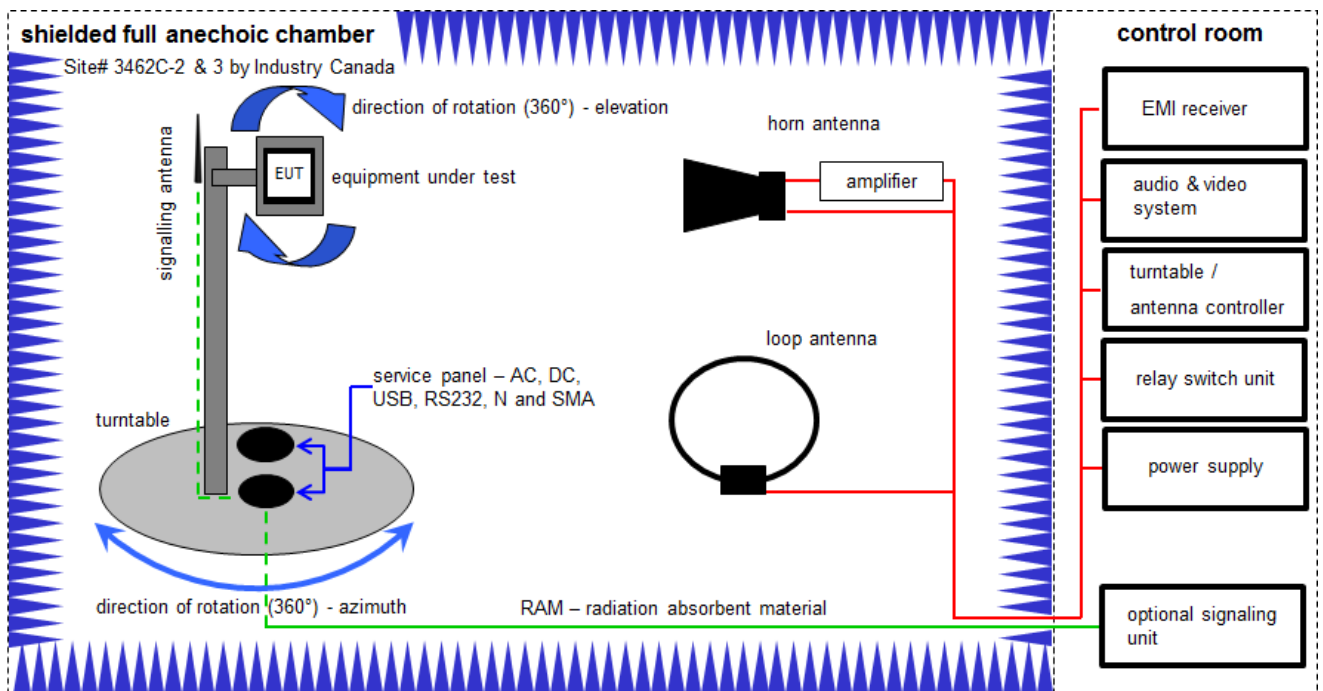

Measurement distance: horn antenna 3 meter; loop antenna 3 meter / 1 meter

$$FS = UR + CA + AF$$

(FS-field strength; UR-voltage at the receiver; CA-loss of the signal path; AF-antenna factor)

Example calculation:

$$FS \text{ [dB}\mu\text{V/m]} = 40.0 \text{ [dB}\mu\text{V/m]} + (-35.8) \text{ [dB]} + 32.9 \text{ [dB/m]} = 37.1 \text{ [dB}\mu\text{V/m]} \text{ (71.61 } \mu\text{V/m)}$$

Equipment table:

No.	Lab / Item	Equipment	Type	Manufacturer	Serial No.	INV. No.	Kind of Calibration	Last Calibration	Next Calibration
1	n. a.	Double-Ridged Waveguide Horn Antenna 1-18.0GHz	3115	EMCO	9107-3697	300001605	vKI!	27.02.2019	26.02.2021
2	n. a.	Active Loop Antenna 9 kHz to 30 MHz	6502	EMCO	2210	300001015	vKI!	13.06.2019	12.06.2021
3	n. a.	DC power supply, 60Vdc, 50A, 1200 W	6032A	HP	2920A04590	300001041	vKI!	14.12.2017	13.12.2020
4	n. a.	Highpass Filter	WHKX7.0/18G-8SS	Wainwright	18	300003789	ne	-/-	-/-
5	n. a.	Broadband Amplifier 0.5-18 GHz	CBLU5184540	CERNEX	22051	300004483	ev	-/-	-/-
6	n. a.	4U RF Switch Platform	L4491A	Agilent Technologies	MY50000032	300004510	ne	-/-	-/-
7	n. a.	Computer	Intel Core i3 3220/3,3 GHz, Prozessor		2V2403033A54 21	300004591	ne	-/-	-/-
8	n. a.	NEXIO EMV-Software	BAT EMC V3.16.0.49	EMCO		300004682	ne	-/-	-/-
9	n. a.	Anechoic chamber		TDK		300003726	ne	-/-	-/-
10	n. a.	EMI Test Receiver 9kHz-26,5GHz	ESR26	R&S	101376	300005063	k	19.12.2018	18.12.2019
11	n. a.	RF Amplifier	AFS4-00100800-28-20P-4-R	MITEQ	2008992	300005204	ne	-/-	-/-
12	n. a.	RF-Amplifier	AMF-6F06001800-30-10P-R	NARDA-MITEQ Inc	2011571	300005240	ev	-/-	-/-

6.3 Radiated measurements > 18 GHz

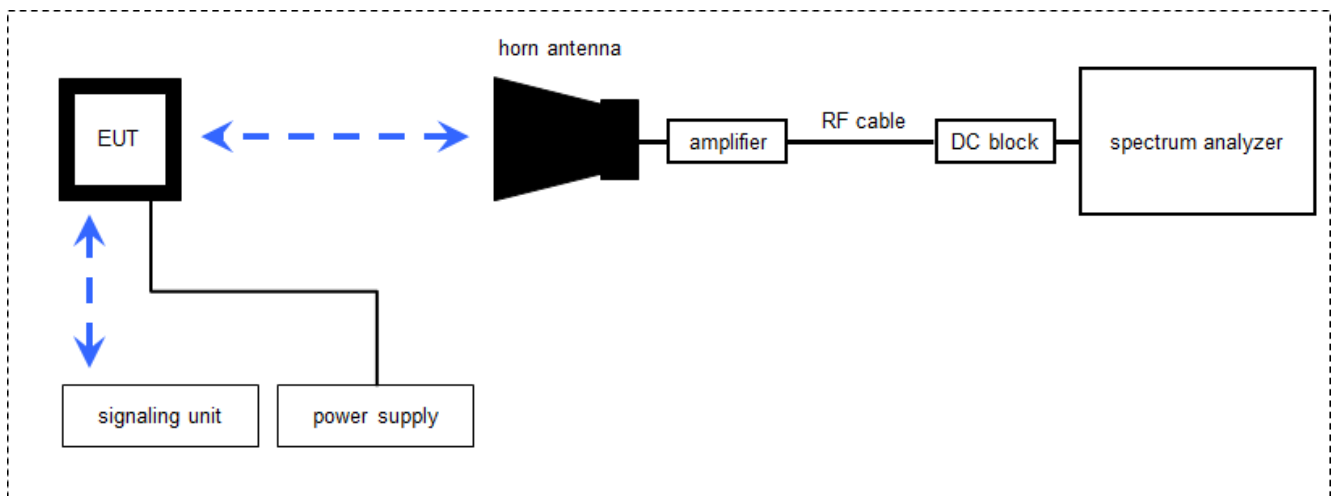

6.4 Radiated measurements > 50/85 GHz

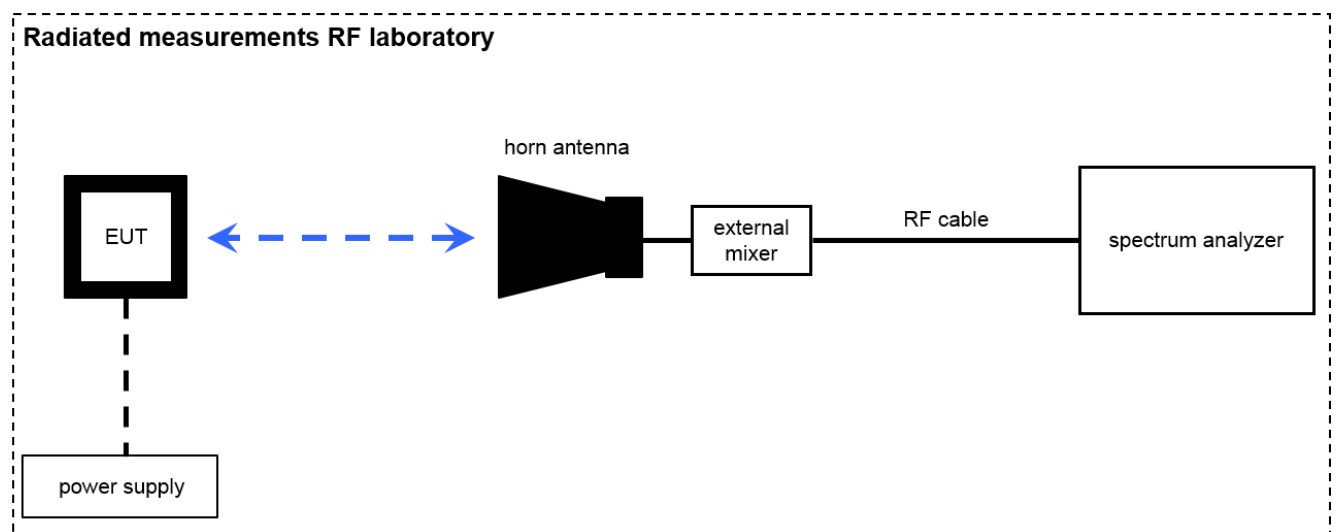

$$OP = AV + D - G$$

(OP-rad. output power; AV-analyzer value; D-free field attenuation of measurement distance; G-antenna gain)

Example calculation:

$$OP \text{ [dBm]} = -54.0 \text{ [dBm]} + 64.0 \text{ [dB]} - 20.0 \text{ [dBi]} = -10 \text{ [dBm]} \text{ (100 } \mu\text{W)}$$

Note: conversion loss of mixer is already included in analyzer value.

Equipment table:

No.	Lab / Item	Equipment	Type	Manufacturer	Serial No.	INV. No.	Kind of Calibration	Last Calibration	Next Calibration
1	n. a.	Std. Gain Horn Antenna 18.0-26.5 GHz	638	Narda		300000486	vKI!	13.12.2017	12.12.2019
2	n. a.	Std. Gain Horn Antenna 26.5-40.0 GHz	V637	Narda	7911	300001751	ne	-/-	-/-
3	n. a.	Std. Gain Horn Antenna 39.3-59.7 GHz	2424-20	Flann	75	300001979	ne	-/-	-/-
4	n. a.	Std. Gain Horn Antenna 49.9-75.8 GHz	2524-20	Flann	*	300001983	ne	-/-	-/-
5	n. a.	Broadband LNA 18-50 GHz	CBL18503070PN	CERNEX	25240	300004948	ev	-/-	-/-
6	n. a.	Harmonic Mixer 2-Port, 50-75 GHz	FS-Z75	R&S	101578	-/-	k	29.05.2019	28.05.2020
7	n. a.	Spectrum Analyzer 20 Hz - 50 GHz	FSU50	R&S	200012	300003443	k	03.01.2019	02.01.2021

6.5 AC conducted

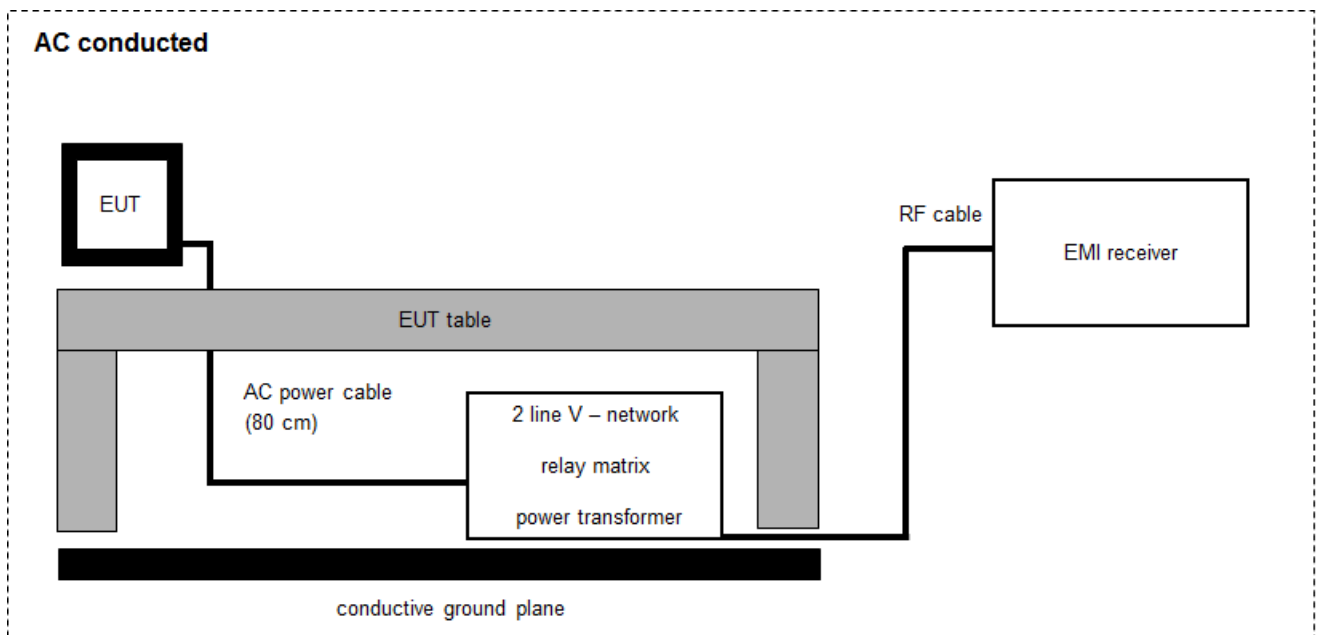

$$FS = UR + CF + VC$$

(FS-field strength; UR-voltage at the receiver; CR-loss of the cable and filter; VC-correction factor of the ISN)

Example calculation:

$$FS [dB\mu V/m] = 37.62 [dB\mu V/m] + 9.90 [dB] + 0.23 [dB] = 47.75 [dB\mu V/m] (244.06 \mu V/m)$$

Equipment table:

No.	Lab / Item	Equipment	Type	Manufacturer	Serial No.	INV. No.	Kind of Calibration	Last Calibration	Next Calibration
1	101	Two-line V-Network (LISN) 9 kHz to 30 MHz	ESH3-Z5	R&S	892475/017	300002209	vKI!	13.12.2017	12.12.2019
2	67	RF-Filter-section	85420E	HP	3427A00162	300002214	NK!	-/-	-/-
3	27	EM-Injection Clamp	FCC-203i	emv	232	300000626	ev	-/-	-/-
4	n. a.	Magnetfeldantenne	MS 100	EM-Test	-----	300002659	ev	-/-	-/-
5	n. a.	AC-Spannungsquelle variabel	MV2616-V	EM-Test	0397-12	300003259	vKI!	18.12.2017	17.12.2019
6	n. a.	Analyzer-Reference-System (Harmonics and Flicker)	ARS 16/1	SPS	A3509 07/0 0205	300003314	vKI!	15.01.2018	14.01.2020
7	n. a.	Hochpass 150 kHz	EZ-25	R&S	100010	300003798	ev	-/-	-/-
8	n. a.	Power Supply DC	NGSM 32/10	Rohde & Schwarz	3939	400000192	vKI!	31.01.2017	30.01.2020
9	n. a.	MXE EMI Receiver 20 Hz to 26,5 GHz	N9038A	Agilent Technologies	MY51210197	300004405	k	12.12.2018	11.12.2019

7 Sequence of testing

7.1 Sequence of testing radiated spurious 9 kHz to 30 MHz

Setup

- The equipment is set up to simulate normal operation mode as described in the user manual or defined by the manufacturer.
- If the EUT is a tabletop system, it is placed on a table with 0.8 m height.
- If the EUT is a floor standing device, it is placed directly on the turn table.
- Auxiliary equipment and cables are positioned to simulate normal operation conditions as described in ANSI C 63.4.
- The AC power port of the EUT (if available) is connected to a power outlet below the turntable.
- Measurement distance is 3 m (see ANSI C 63.4) – see test details.
- EUT is set into operation.

Premeasurement*

- The turntable rotates from 0° to 315° using 45° steps.
- The antenna height is 1 m.
- At each turntable position the analyzer sweeps with positive-peak detector to find the maximum of all emissions.

Final measurement

- Identified emissions during the pre-measurement are maximized by the software by rotating the turntable from 0° to 360°.
- Loop antenna is rotated about its vertical axis for maximum response at each azimuth about the EUT. (For certain applications, the loop antenna plane may also need to be positioned horizontally at the specified distance from the EUT)
- The final measurement is done in the position (turntable and elevation) causing the highest emissions with quasi-peak (as described in ANSI C 63.4).
- Final levels, frequency, measuring time, bandwidth, turntable position, correction factor, margin to the limit and limit will be recorded. A plot with the graph of the premeasurement and the limit is stored.

*)Note: The sequence will be repeated three times with different EUT orientations.

7.2 Sequence of testing radiated spurious 30 MHz to 1 GHz

Setup

- The equipment is set up to simulate normal operation mode as described in the user manual or defined by the manufacturer.
- If the EUT is a tabletop system, a table with 0.8 m height is used, which is placed on the ground plane.
- If the EUT is a floor standing device, it is placed on the ground plane with insulation between both.
- Auxiliary equipment and cables are positioned to simulate normal operation conditions as described in ANSI C 63.4.
- The AC power port of the EUT (if available) is connected to a power outlet below the turntable.
- Measurement distance is 10 m or 3 m (see ANSI C 63.4) – see test details.
- EUT is set into operation.

Premeasurement

- The turntable rotates from 0° to 315° using 45° steps.
- The antenna is polarized vertical and horizontal.
- The antenna height changes from 1 m to 3 m.
- At each turntable position, antenna polarization and height the analyzer sweeps three times in peak to find the maximum of all emissions.

Final measurement

- The final measurement is performed for at least six highest peaks according to the requirements of the ANSI C63.4.
- Based on antenna and turntable positions at which the peak values are measured the software maximize the peaks by changing turntable position $\pm 45^\circ$ and antenna height between 1 and 4 m.
- The final measurement is done with quasi-peak detector (as described in ANSI C 63.4).
- Final levels, frequency, measuring time, bandwidth, antenna height, antenna polarization, turntable angle, correction factor, margin to the limit and limit are recorded. A plot with the graph of the premeasurement with marked maximum final results and the limit is stored.

7.3 Sequence of testing radiated spurious 1 GHz to 18 GHz

Setup

- The equipment is set up to simulate normal operation mode as described in the user manual or defined by the manufacturer.
- If the EUT is a tabletop system, a 2-axis positioner with 1.5 m height is used.
- If the EUT is a floor standing device, it is placed directly on the turn table.
- Auxiliary equipment and cables are positioned to simulate normal operation conditions as described in ANSI C 63.4.
- The AC power port of the EUT (if available) is connected to a power outlet below the turntable.
- Measurement distance is 3 m (see ANSI C 63.4) – see test details.
- EUT is set into operation.

Premeasurement

- The turntable rotates from 0° to 315° using 45° steps.
- The antenna is polarized vertical and horizontal.
- The antenna height is 1.5 m.
- At each turntable position and antenna polarization the analyzer sweeps with positive peak detector to find the maximum of all emissions.

Final measurement

- The final measurement is performed for at least six highest peaks according to the requirements of the ANSI C63.4.
- Based on antenna and turntable positions at which the peak values are measured the software maximizes the peaks by rotating the turntable from 0° to 360°. This measurement is repeated for different EUT-table positions (0° to 150° in 30°-steps) and for both antenna polarizations.
- The final measurement is done in the position (turntable, EUT-table and antenna polarization) causing the highest emissions with Peak and AVERAGE detector (as described in ANSI C 63.4).
- Final levels, frequency, measuring time, bandwidth, turntable position, EUT-table position, antenna polarization, correction factor, margin to the limit and limit are recorded. A plot with the graph of the premeasurement with marked maximum final results and the limit is stored.

7.4 Sequence of testing radiated spurious above 18 GHz

Setup

- The equipment is set up to simulate normal operation mode as described in the user manual or defined by the manufacturer.
- Auxiliary equipment and cables are positioned to simulate normal operation conditions as described in ANSI C 63.4.
- The AC power port of the EUT (if available) is connected to a power outlet.
- The measurement distance is as appropriate (e.g. 0.5 m).
- The EUT is set into operation.

Premeasurement

- The test antenna is handheld and moved carefully over the EUT to cover the EUT's whole sphere and different polarizations of the antenna.

Final measurement

- The final measurement is performed at the position and antenna orientation causing the highest emissions with Peak and AVERAGE detector (as described in ANSI C 63.4).
- Final levels, frequency, measuring time, bandwidth, correction factor, margin to the limit and limit are recorded. A plot with the graph of the premeasurement and the limit is stored.

7.5 Sequence of testing radiated spurious above 50 GHz with external mixers

Setup

- The equipment is set up to simulate normal operation mode as described in the user manual or defined by the manufacturer.
- Auxiliary equipment and cables are positioned to simulate normal operation conditions as described in ANSI C 63.4.
- The AC power port of the EUT (if available) is connected to a power outlet.
- The measurement distance is as appropriate for far field (e.g. 0.25 m).
- The EUT is set into operation.

Premeasurement

- The test antenna with external mixer is handheld and moved carefully over the EUT to cover the EUT's whole sphere and different polarizations of the antenna.
- Caution is taken to reduce the possible overloading of the external mixer.

Final measurement

- The final measurement is performed at the position and antenna orientation causing the highest emissions with Peak and AVERAGE detector (as described in ANSI C 63.4).
- As external mixers may generate false images care is taken to ensure that any emission measured by the spectrum analyzer does indeed originate in the EUT. Signal identification feature of spectrum analyzer is used to eliminate false mixer images (i.e., it is not the fundamental emission or a harmonic falling precisely at the measured frequency).
- Final levels, frequency, measuring time, bandwidth, correction factor, margin to the limit and limit are recorded. A plot with the graph of the premeasurement and the limit is stored.

8 Measurement uncertainty

Test case	Uncertainty
Equivalent isotropically radiated power (e.i.r.p.)	Conducted value ± 1 dB Radiated value ± 3 dB
Permitted range of operating frequencies	± 100 kHz
Conducted unwanted emissions in the spurious domain (up to 40 GHz)	± 1 dB
Radiated unwanted emissions in the spurious domain (up to 40 GHz)	± 3 dB
Conducted unwanted emissions in the spurious domain (40 to 50 GHz)	± 4 dB
Radiated unwanted emissions in the spurious domain (40 to 50 GHz)	± 4 dB
Conducted unwanted emissions in the spurious domain (50 to 300 GHz)	± 5 dB
Radiated unwanted emissions in the spurious domain (50 to 300 GHz)	± 5 dB
DC and low frequency voltages	± 3 %
Temperature	± 1 °C
Humidity	± 3 %

9 Summary of measurement results

<input checked="" type="checkbox"/>	No deviations from the technical specifications were ascertained
<input type="checkbox"/>	There were deviations from the technical specifications ascertained
<input type="checkbox"/>	This test report is only a partial test report. The content and verdict of the performed test cases are listed below.

TC Identifier	Description	Verdict	Date	Remark
RF-Testing	47 CFR Part 15 RSS 210, Issue 9, Annex F	see table	2019-10-11	-/-

Test specification clause	Test case	Temperature conditions	Power source voltages	C	NC	NA	NP	Results (max.)
§15.245 (b) RSS-210 F1 RSS-Gen	Field strength of emissions (wanted signal)	Nominal	Nominal	<input checked="" type="checkbox"/>	<input type="checkbox"/>	<input type="checkbox"/>	<input type="checkbox"/>	126.7 dBµV (PEAK) 126.6 dBµV (AVG)
§2.1049	Occupied bandwidth (99% bandwidth)	Nominal	Nominal	<input checked="" type="checkbox"/>	<input type="checkbox"/>	<input type="checkbox"/>	<input type="checkbox"/>	11.22 MHz
§15.209 (a) §15.245 (a) §15.245 (b)(3) RSS-210 F1 (a) RSS-210 F1 (b) RSS-210 F1 (c) RSS-210 F1 (e) RSS-Gen	Field strength of emissions (band edge / spurious / harmonics)	Nominal	Nominal	<input checked="" type="checkbox"/>	<input type="checkbox"/>	<input type="checkbox"/>	<input type="checkbox"/>	complies
§15.207 (a) ICES-003	Conducted emissions < 30 MHz	Nominal	Nominal	<input checked="" type="checkbox"/>	<input type="checkbox"/>	<input type="checkbox"/>	<input type="checkbox"/>	Complies

Note: C = Compliant; NC = Not compliant; NA = Not applicable; NP = Not performed

10 Measurement results

10.1 Field strength of emissions (wanted signal)

Description:

Measurement of the maximum radiated field strength of the wanted signal.

Measurement:

Measurement parameter	
Detector:	Pos-Peak / AVERAGE
Sweep time:	Auto
Resolution bandwidth:	1 MHz
Video bandwidth:	3 MHz
Span:	100 MHz
Trace-Mode:	Max Hold

Limits:

FCC	IC	
CFR Part 15.245 (b)	RSS - 210, F.1 (a)	
Field strength of emissions		
The field strength of emissions from intentional radiators operated within these frequency bands shall comply with the following:		
Frequency [GHz]	Field Strength [dB μ V/m]	Measurement distance [m]
10.500 – 10.550	128 (Average) / 148 (Peak)	3

Result:

Test condition T _{nom} / V _{nom}	Maximum field strength [dB μ V/m @ 3 m]
Low Channel	126.60 (Peak) / 126.55 (Average)
Middle Channel	126.55 (Peak) / 126.50 (Average)
High Channel	126.65 (Peak) / 126.53 (Average)
Measurement uncertainty	\pm 3 dB

Plot No. 1: Field Strength Low Ch., Peak and Average detector, T_{nom} / V_{nom}

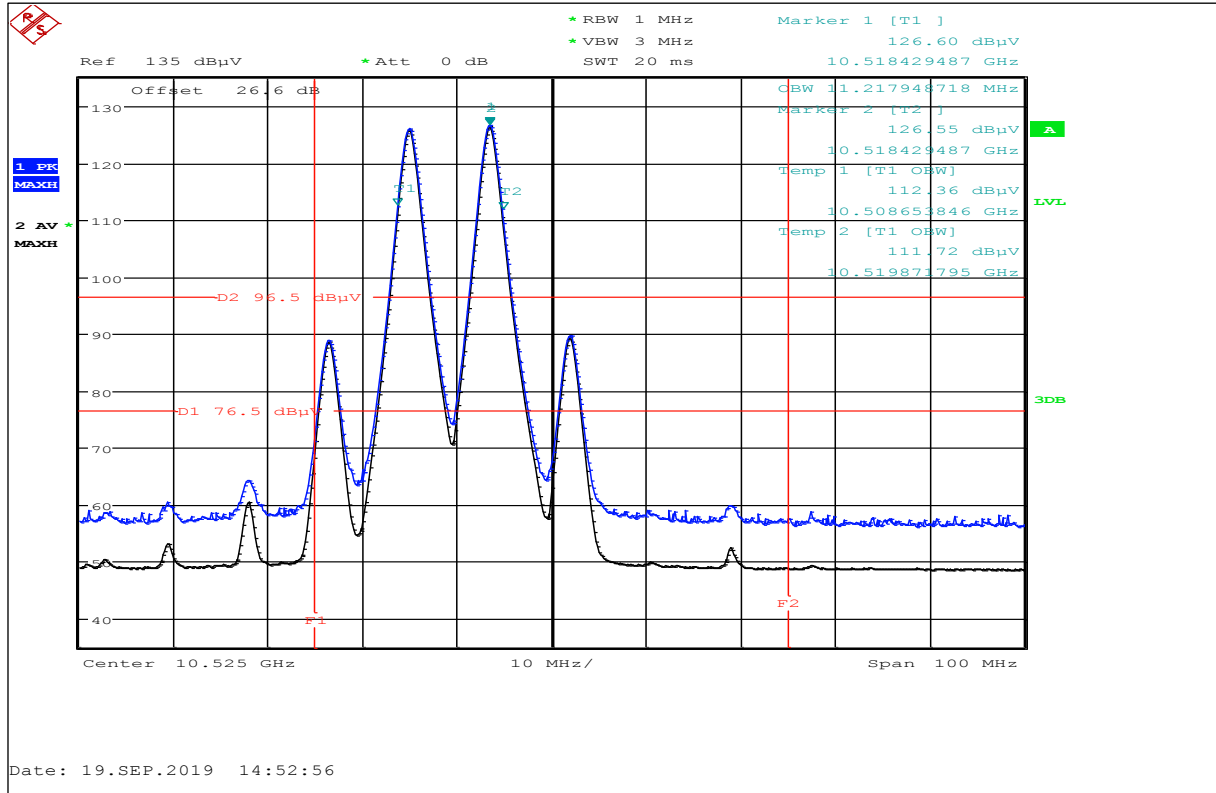

Plot No. 2: Field Strength Middle Ch., Peak and Average detector, T_{nom} / V_{nom}

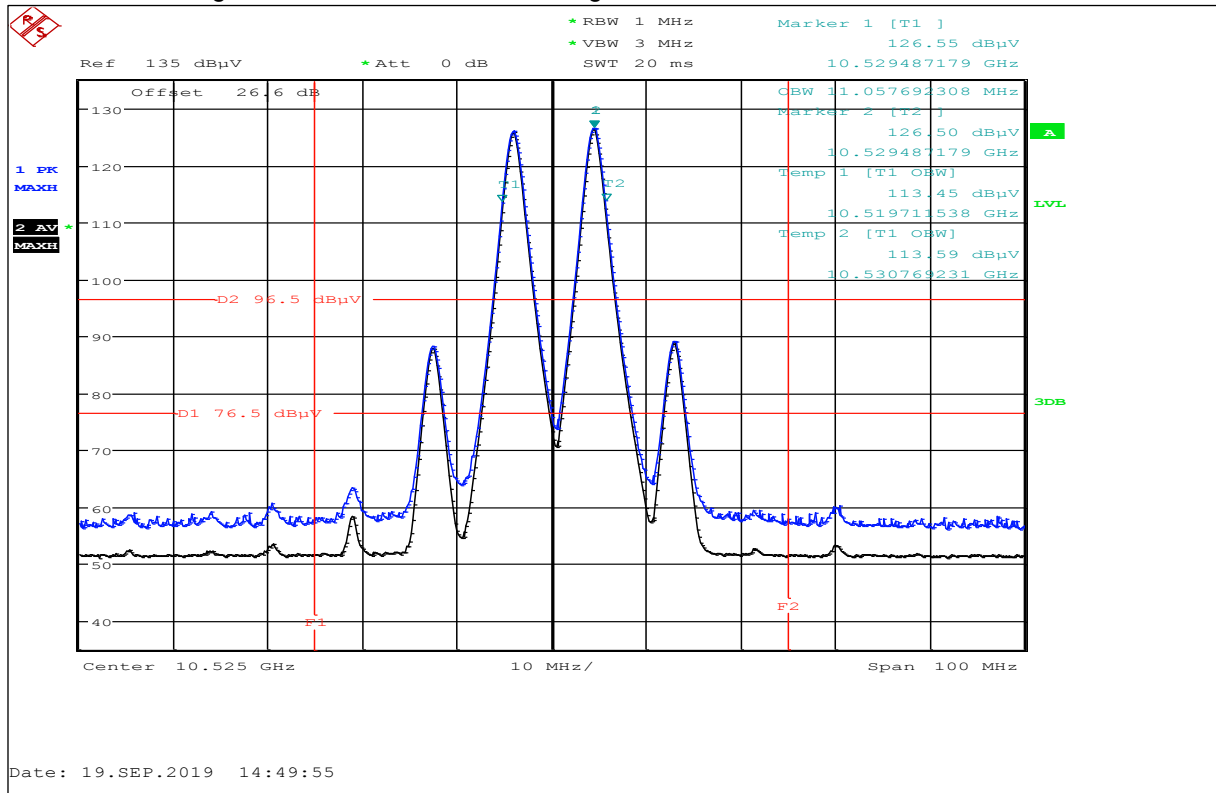

Plot No. 3: Field Strength High Ch., Peak and Average detector, T_{nom} / V_{nom}

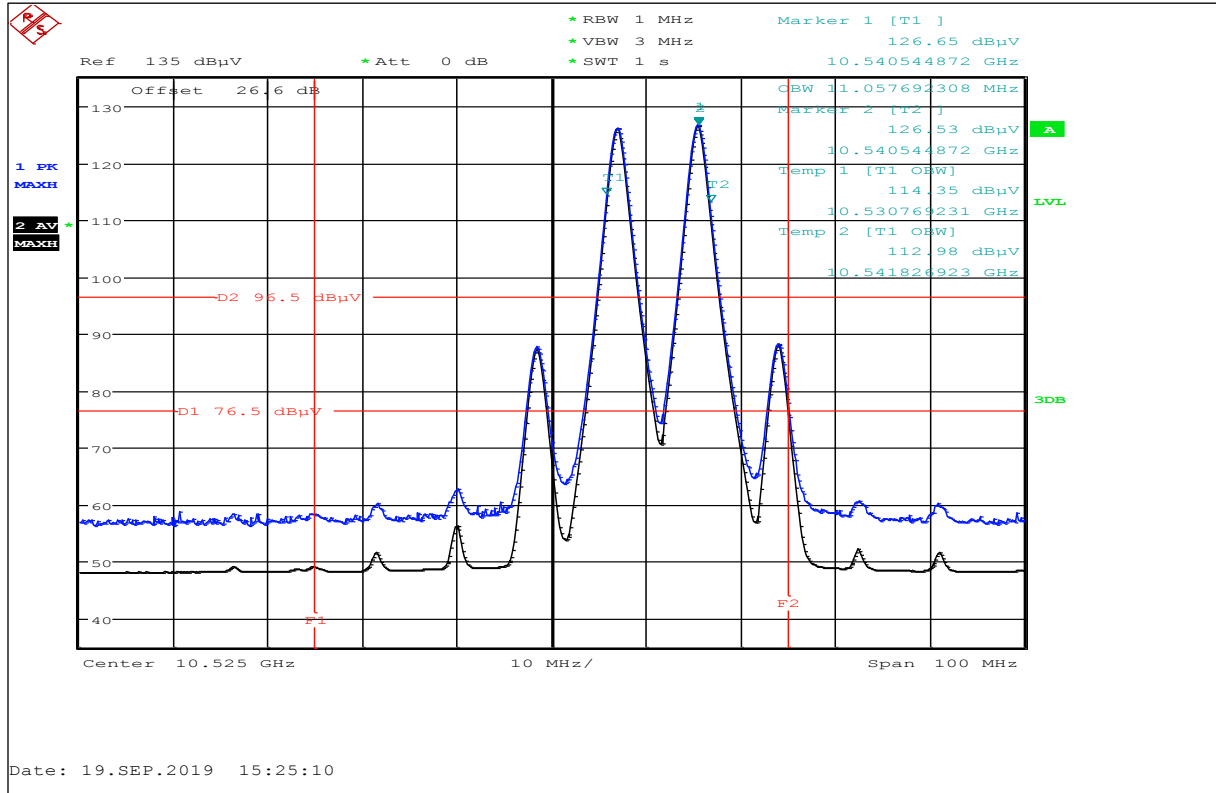

10.2 Occupied bandwidth (99% bandwidth)

Definition:

The occupied bandwidth is defined as the 99% bandwidth.

Measurement:

The EUT is powered on and set up to transmit its normal signal modulation sequence(s).
 A spectrum analyzer with the following settings is used:

The test was performed under normal and extreme test conditions.

Measurement parameter	
Detector:	Pos-Peak / AVERAGE
Sweep time:	Auto
Resolution bandwidth:	1 MHz
Video bandwidth:	3 MHz
Span:	100 MHz
Trace-Mode:	Max Hold

Limits:

FCC	IC
CFR Part 15.245 (b)	RSS - 210, F.1 (a)
Fundamental frequency	
10.500 GHz – 10.550 GHz (50 MHz):	

Results:

Test condition T_{nom} / V_{nom}	99% Occupied bandwidth [MHz]
Low Channel	11.22
Middle Channel	11.06
High Channel	11.06
Measurement uncertainty	$\pm \text{span}/1000$

10.3 Field strength of emissions and band edge (radiated spurious)

Description:

Measurement of the radiated spurious emissions in transmit mode.

Measurement:

Measurement parameter	
Detector:	F < 1 GHz: Quasi-Peak F > 1 GHz: Pos-Peak / AVERAGE
Sweep time:	Auto
Video bandwidth:	Auto
Resolution bandwidth:	F < 1 GHz: 100 kHz F > 1 GHz: 1 MHz
Trace-Mode:	Max-Hold

Limits:

FCC	IC	
CFR Part 15.209 (a) / CFR Part 15.245 (b)(1)(ii)	RSS-210 F.1 (a)(b)(c) / RSS - GEN	
Field strength of harmonics		
The field strength of harmonics from intentional radiators shall comply with the following:		
Harmonics: PEAK → 108 dBµV/m / Average → 88 dBµV/m (at a distance of 3 m)		
Harmonic emissions falling into restricted bands listed in RSS-Gen and which are at and above 17.7 GHz shall not exceed the following field strength limits measured at a distance of 3 m: PEAK → 97.5 dBµV/m / Average → 77.5 dBµV/m		
CFR Part 15.209 (a) / CFR Part 15.245 (b)(3)	RSS-210 F.1 (e) / RSS - GEN	
Radiated Spurious Emissions		
Emissions radiated outside of the specified frequency bands, except for harmonic emissions shall be attenuated by at least 50 dB below the level of the fundamental emissions or to the general field strength limits specified in RSS-Gen, whichever is less stringent PEAK → 96.5 dBµV/m / Average → 76.5 dBµV/m		
Frequency (MHz)	Field Strength (dBµV/m)	Measurement distance
0.009 – 0.490	2400/F(kHz)	300
0.490 – 1.705	24000/F(kHz)	30
1.705 – 30.0	30	30
30 – 88	30.0	10
88 – 216	33.5	10
216 – 960	36.0	10
Above 960	54.0	3

Results:

TX Spurious Emissions Radiated [dB μ V/m]								
Low Channel			Middle Channel			High Channel		
Frequency [GHz]	Detector	Level [dB μ V/m]	Frequency [GHz]	Detector	Level [dB μ V/m]	Frequency [GHz]	Detector	Level [dB μ V/m]
21.0	PK	73.40	21.1	PK	74.18	21.1	PK	74.81
21.0	AVG	73.27	21.1	AVG	74.04	21.1	AVG	74.68
31.5	PK	69.76	31.6	PK	68.16	31.6	PK	68.06
31.5	AVG	69.45	31.6	AVG	67.78	31.6	AVG	67.67
42.0	PK	69.31	42.1	PK	65.45	42.2	PK	64.70
42.0	AVG	68.92	42.1	AVG	64.89	42.2	AVG	64.03
Measurement uncertainty			± 3 dB					

Plot No. 4: Low Ch., Magnetic: 9 kHz - 30 MHz

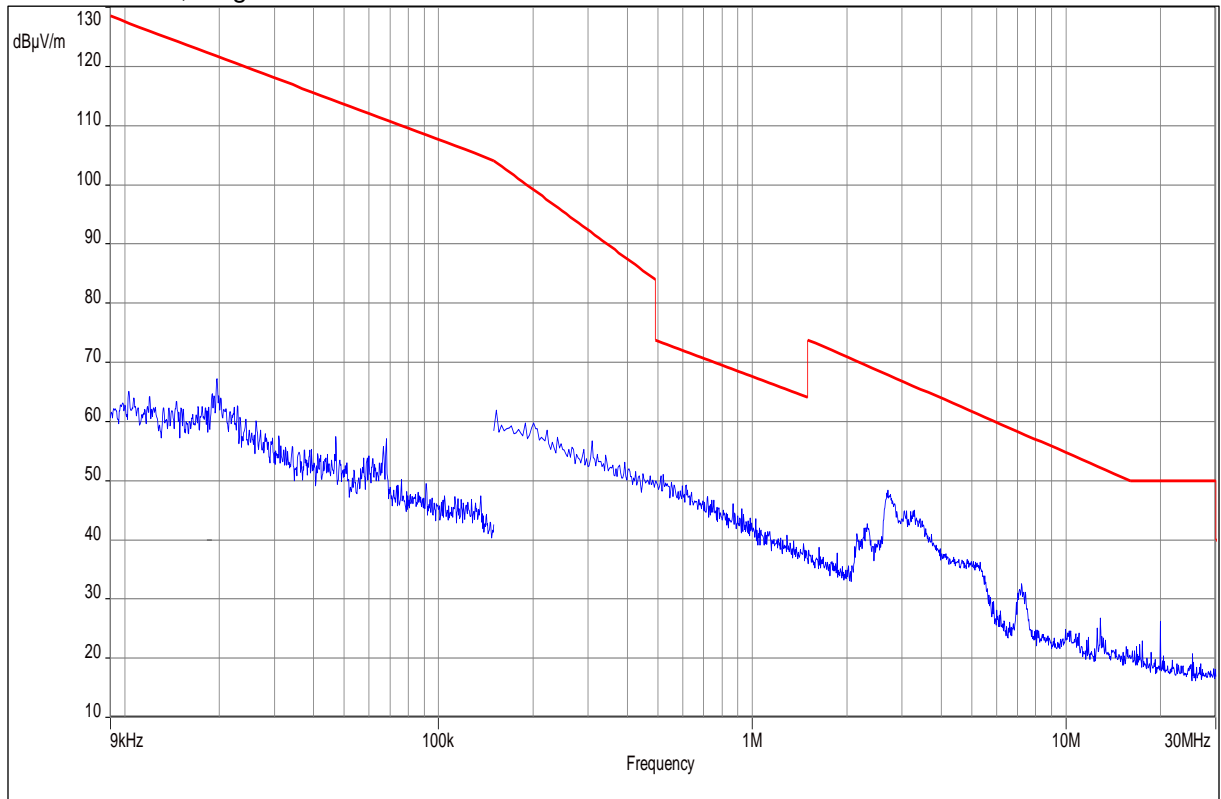

Plot No. 5: Middle Ch., Magnetic: 9 kHz - 30 MHz

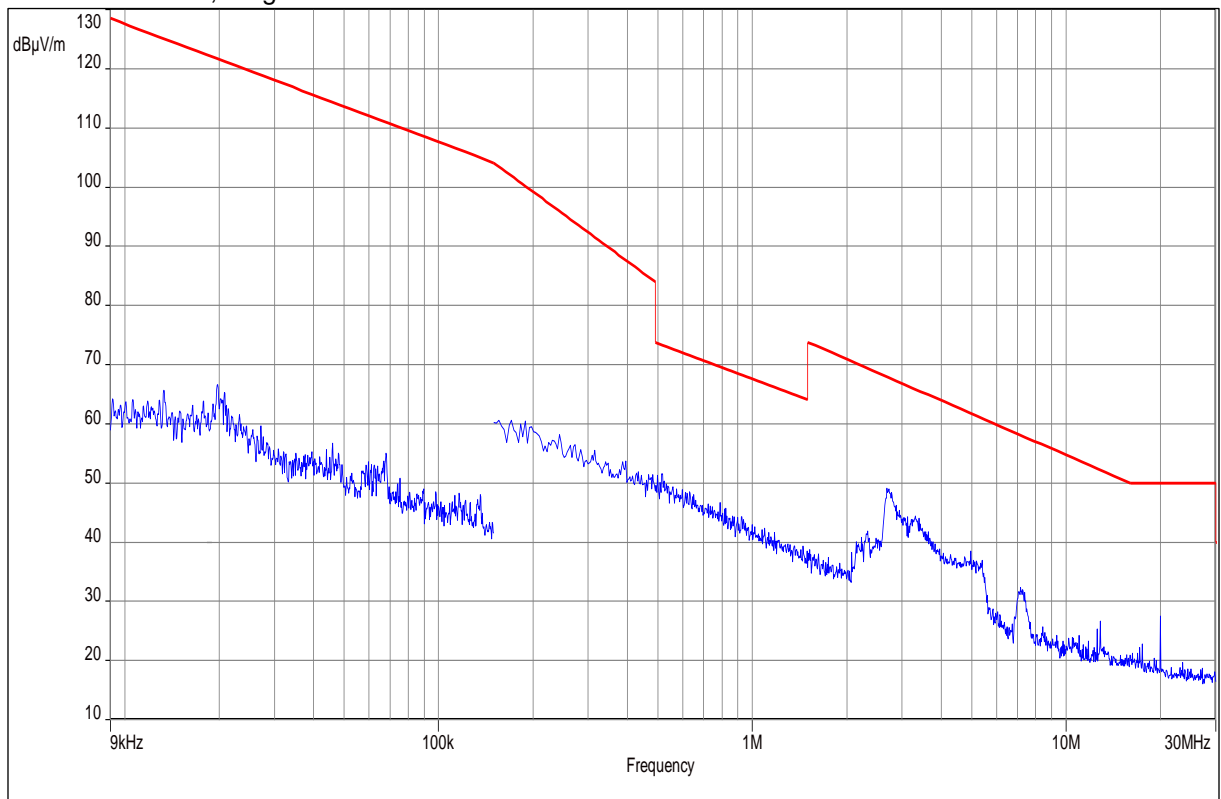

Plot No. 6: High Ch., Magnetic: 9 kHz - 30 MHz

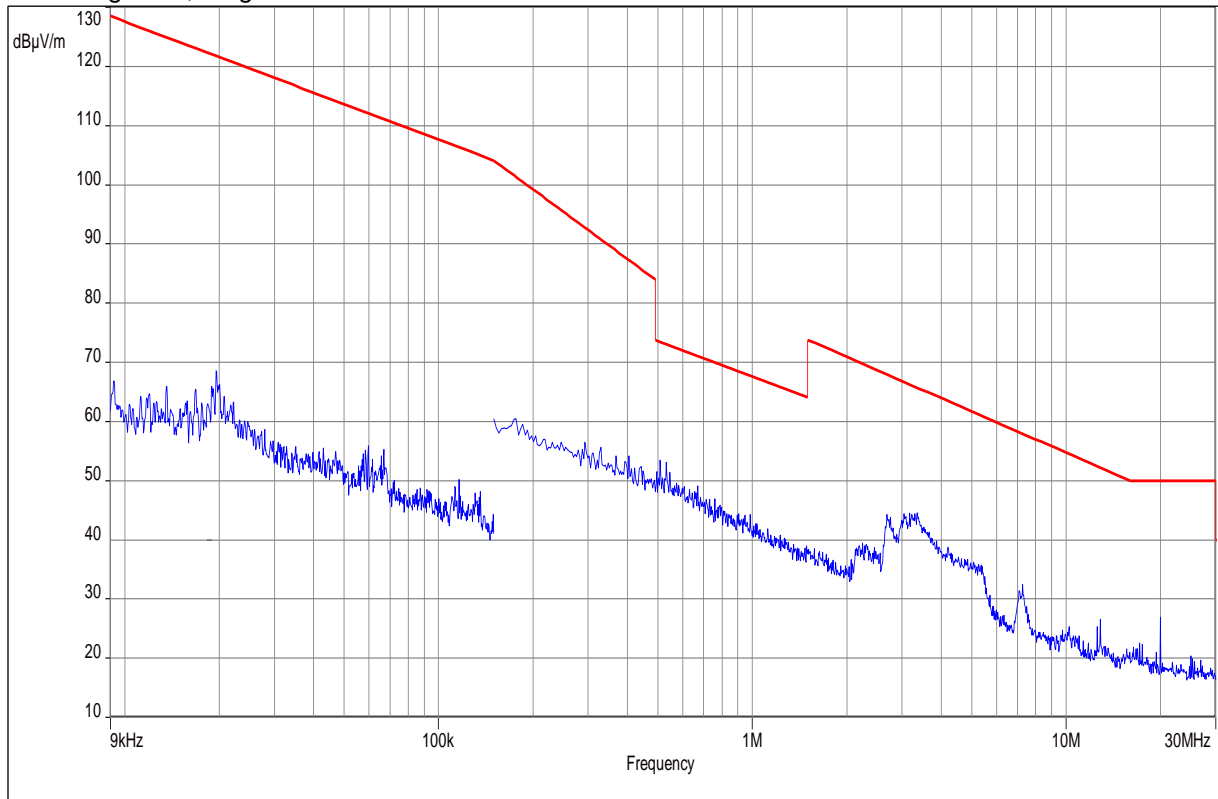

Plot No. 7: Low Ch., 30 MHz to 1 GHz, horizontal / vertical polarization

EUT:	Trackman TMC3G + Connection Box (Extention Box)
Test description:	FCC part 15.245 @ 10 m
Operating condition:	TX Low Channel
Operator name:	Wolsdorfer
Comment:	AC: 115 V / 60 Hz

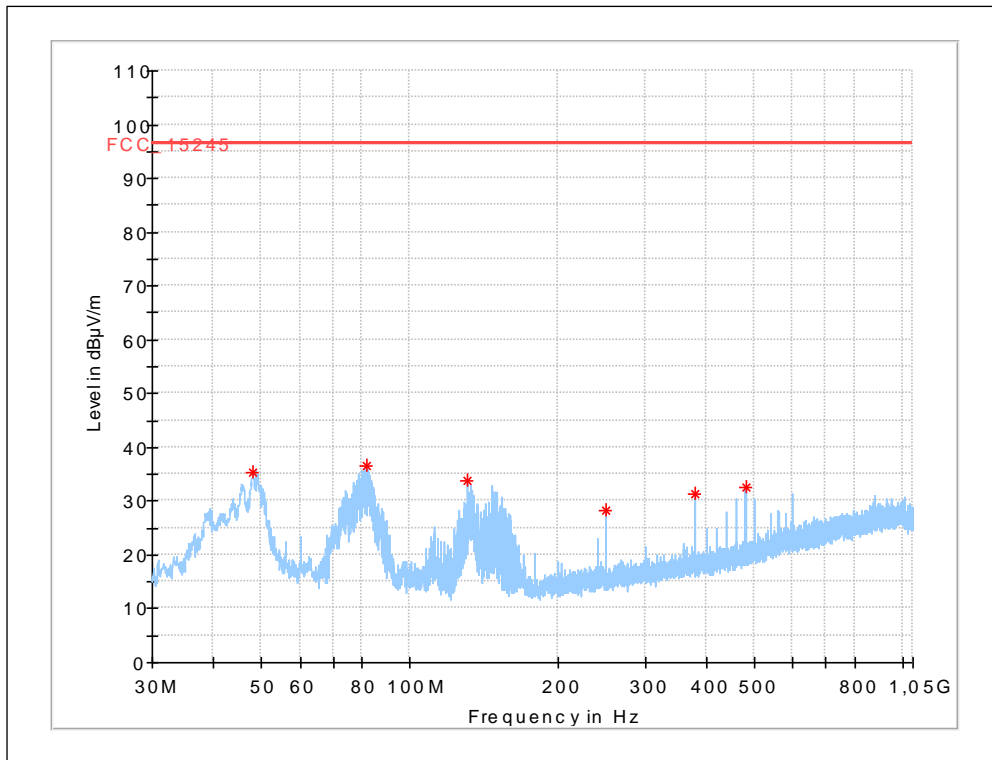

Frequency (MHz)	QuasiPeak (dBµV/m)	Limit (dBµV/m)	Margin (dB)	Meas. Time (ms)	Bandwidth (kHz)	Height (cm)	Pol	Azimuth (deg)	Corr. (dB/m)
47.952	35.31	96.5	61.19	200	120	100.0	V	135.0	15
81.561	36.58	96.5	59.92	200	120	300.0	V	225.0	11
131.235	33.66	96.5	62.84	200	120	100.0	V	90.0	10
250.014	28.14	96.5	68.36	200	120	300.0	H	0.0	14
379.962	31.39	96.5	65.11	200	120	100.0	V	315.0	16
480.024	32.45	96.5	64.05	200	120	100.0	H	315.0	18

FCC part 15.245 most stringent limit is met (PEAK → 96.5 dBµV/m / Average → 76.5 dBµV/m)

Plot No. 8: Middle Ch., 30 MHz to 1 GHz, horizontal / vertical polarization

EUT:	Trackman TMC3G + Connection Box (Extension Box)
Test description:	FCC part 15.245 @ 10 m
Operating condition:	TX Middle Channel
Operator name:	Wolsdorfer
Comment:	AC: 115 V / 60 Hz

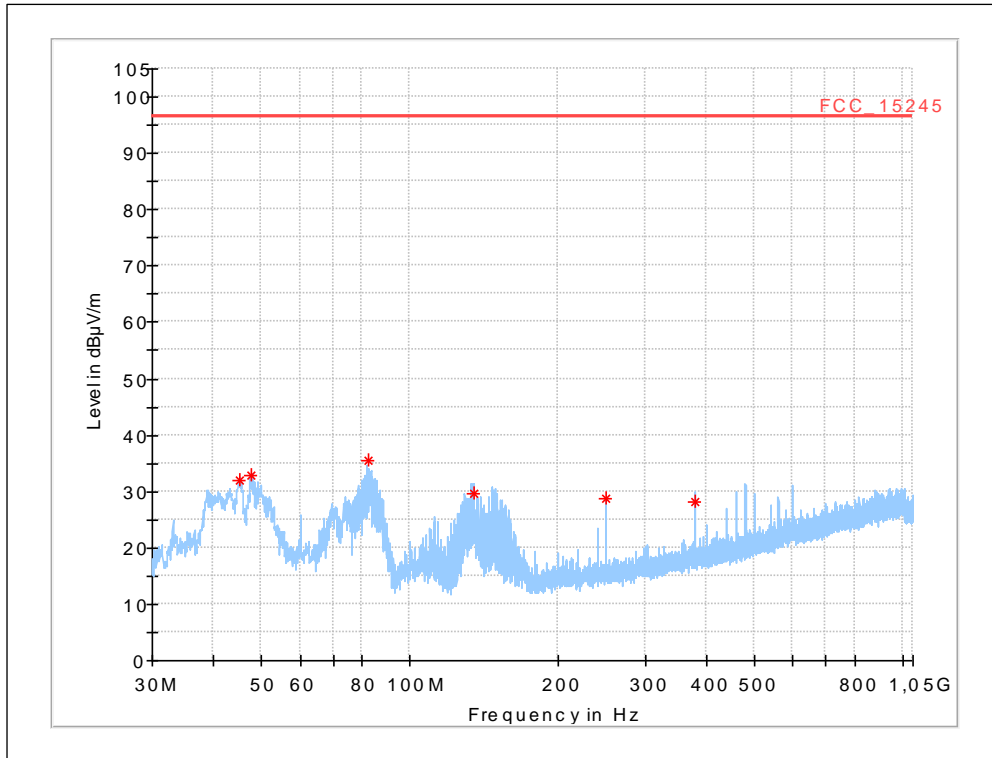

Frequency (MHz)	QuasiPeak (dBµV/m)	Limit (dBµV/m)	Margin (dB)	Meas. Time (ms)	Bandwidth (kHz)	Height (cm)	Pol	Azimuth (deg)	Corr. (dB/m)
134.986	29.62	96.5	64.99	200	120	100.0	V	0.0	10
82.177	35.53	96.5	62.36	200	120	200.0	V	254.0	11
380.004	28.20	96.5	66.85	200	120	100.0	V	313.0	16
44.994	31.98	96.5	64.52	200	120	100.0	V	90.0	15
47.493	32.80	96.5	63.70	200	120	100.0	V	90.0	15
249.963	28.71	96.5	67.79	200	120	300.0	H	0.0	14

FCC part 15.245 most stringent limit is met (PEAK → 96.5 dBµV/m / Average → 76.5 dBµV/m)

Plot No. 9: High Ch., 30 MHz to 1 GHz, horizontal / vertical polarization

EUT:	Trackman TMC3G + Connection Box (Extention Box)
Test description:	FCC part 15.245 @ 10 m
Operating condition:	TX High Channel
Operator name:	Wolsdorfer
Comment:	AC: 115 V / 60 Hz

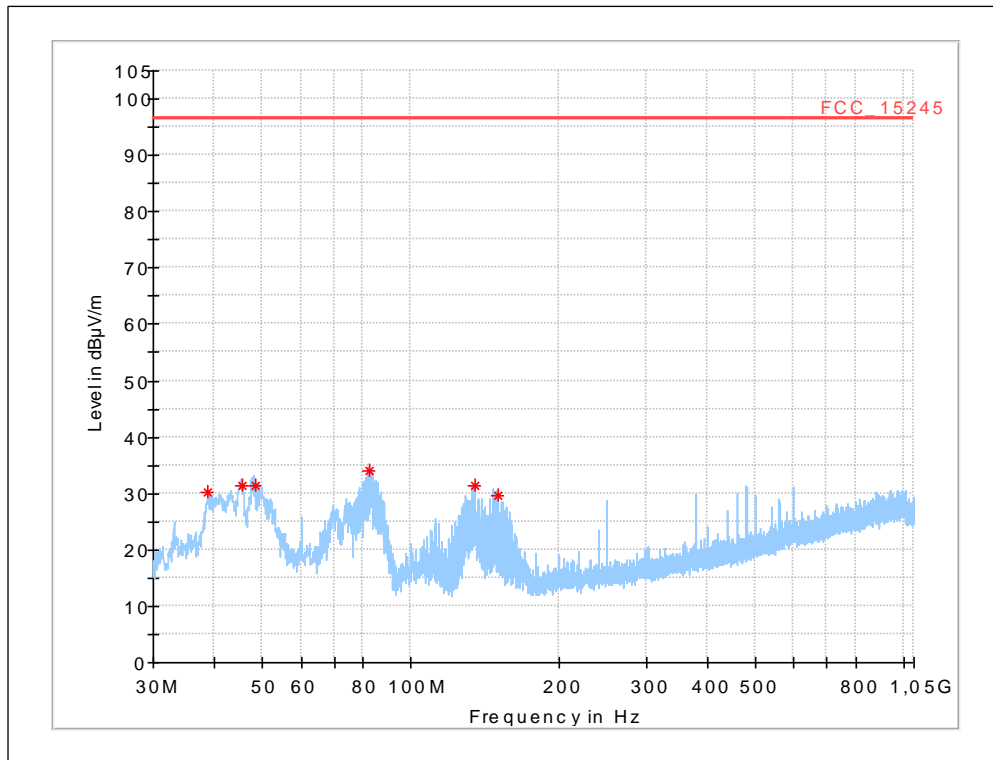

Frequency (MHz)	QuasiPeak (dBµV/m)	Limit (dBµV/m)	Margin (dB)	Meas. Time (ms)	Bandwidth (kHz)	Height (cm)	Pol	Azimuth (deg)	Corr. (dB/m)
38.823	30.16	96.5	66.34	200	120	100.0	V	90.0	14
45.504	31.50	96.5	65.00	200	120	100.0	V	90.0	15
48.309	31.51	96.5	64.99	200	120	100.0	V	90.0	15
82.632	34.14	96.5	62.36	200	120	100.0	V	270.0	11
135.264	31.31	96.5	65.19	200	120	100.0	V	315.0	10
150.615	29.74	96.5	66.76	200	120	100.0	V	45.0	10

FCC part 15.245 most stringent limit is met (PEAK → 96.5 dBµV/m / Average → 76.5 dBµV/m)

Plot No. 10: Low Ch., 30 MHz to 1 GHz, horizontal / vertical polarization

EUT:	Trackman TMC3G + Connection Box (Backfield)
Test description:	FCC part 15.245 @ 10 m
Operating condition:	TX Low Channel
Operator name:	Wolsdorfer
Comment:	AC: 115 V / 60 Hz

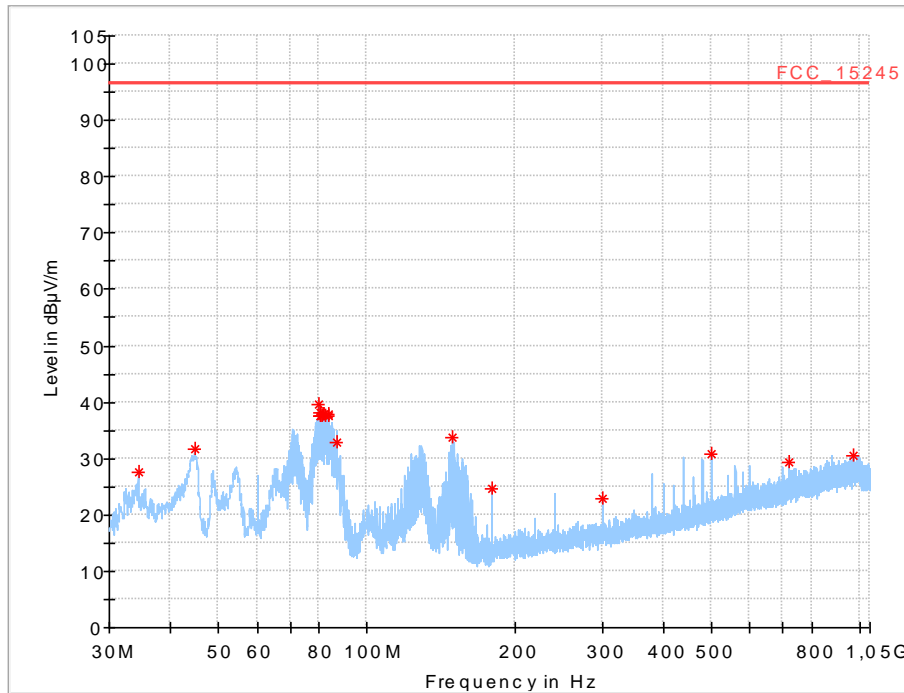

Frequency (MHz)	QuasiPeak (dBµV/m)	Limit (dBµV/m)	Margin (dB)	Meas. Time (ms)	Bandwidth (kHz)	Height (cm)	Pol	Azimuth (deg)	Corr. (dB/m)
34.335	27.44	96.5	69.06	200	120	100.0	V	90.0	14
44.688	31.79	96.5	64.71	200	120	300.0	V	180.0	15
79.980	39.57	96.5	56.93	200	120	300.0	V	45.0	11
80.286	38.10	96.5	58.40	200	120	300.0	V	135.0	11
80.541	37.40	96.5	59.10	200	120	300.0	V	180.0	11
80.796	37.56	96.5	58.94	200	120	300.0	V	90.0	11
81.051	37.50	96.5	59.00	200	120	300.0	V	45.0	11
81.561	37.71	96.5	58.79	200	120	300.0	V	90.0	11
81.867	37.87	96.5	58.63	200	120	300.0	V	135.0	11
82.122	37.60	96.5	58.90	200	120	300.0	V	0.0	11
83.448	37.90	96.5	58.60	200	120	300.0	V	225.0	11
83.703	37.47	96.5	59.03	200	120	300.0	V	225.0	11
87.171	32.86	96.5	63.64	200	120	300.0	V	270.0	11
148.728	33.75	96.5	62.75	200	120	100.0	V	45.0	10
179.991	24.49	96.5	72.01	200	120	100.0	V	45.0	11
299.994	22.88	96.5	73.62	200	120	300.0	V	45.0	15
500.016	30.79	96.5	65.71	200	120	100.0	H	45.0	18
721.764	29.36	96.5	67.14	200	120	100.0	H	180.0	22
973.602	30.59	96.5	65.91	200	120	300.0	V	180.0	24

FCC part 15.245 most stringent limit is met (PEAK → 96.5 dBµV/m / Average → 76.5 dBµV/m)

Plot No. 11: Middle Ch., 30 MHz to 1 GHz, horizontal / vertical polarization

EUT:	Trackman TMC3G + Connection Box (Backfield)
Test description:	FCC part 15.245 @ 10 m
Operating condition:	TX Middle Channel
Operator name:	Wolsdorfer
Comment:	AC: 115 V / 60 Hz

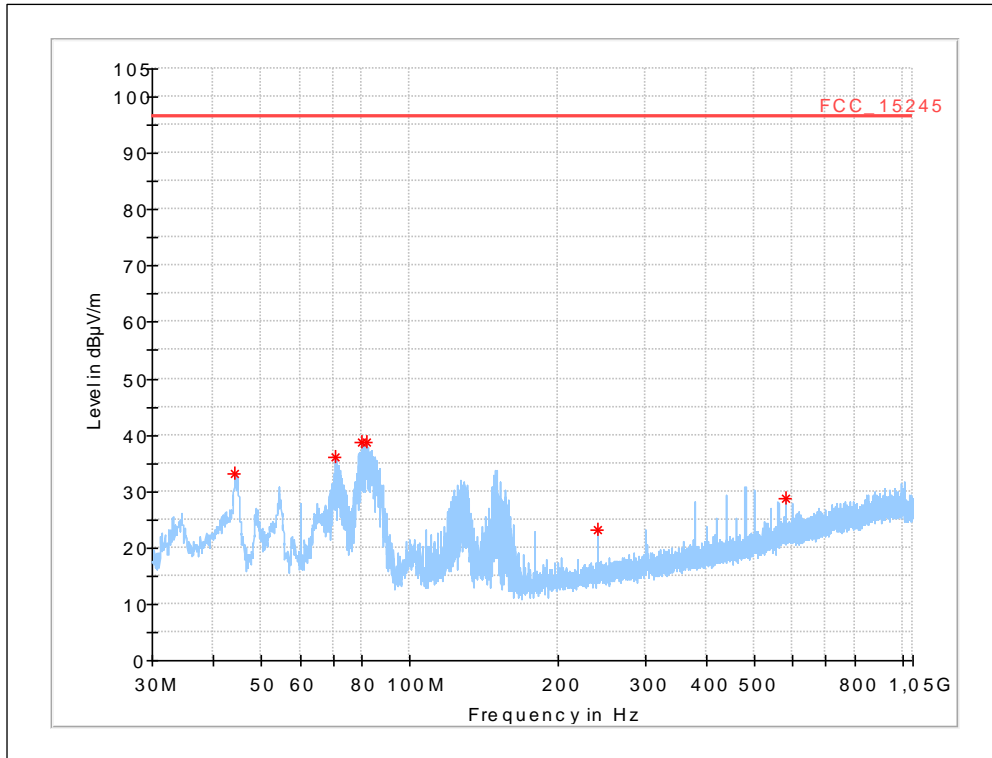

Frequency (MHz)	QuasiPeak (dBµV/m)	Limit (dBµV/m)	Margin (dB)	Meas. Time (ms)	Bandwidth (kHz)	Height (cm)	Pol	Azimuth (deg)	Corr. (dB/m)
44.280	33.26	96.5	63.24	200	120	100.0	V	315.0	15
70.851	35.95	96.5	60.55	200	120	300.0	V	90.0	11
80.031	38.65	96.5	57.85	200	120	300.0	V	135.0	11
81.867	38.77	96.5	57.73	200	120	300.0	V	0.0	11
239.967	23.24	96.5	73.26	200	120	300.0	H	45.0	13
579.984	28.85	96.5	67.65	200	120	300.0	H	0.0	20

FCC part 15.245 most stringent limit is met (PEAK → 96.5 dBµV/m / Average → 76.5 dBµV/m)

Plot No. 12: High Ch., 30 MHz to 1 GHz, horizontal / vertical polarization

EUT:	Trackman TMC3G + Connection Box (Backfield)
Test description:	FCC part 15.245 @ 10 m
Operating condition:	TX High Channel
Operator name:	Wolsdorfer
Comment:	AC: 115 V / 60 Hz

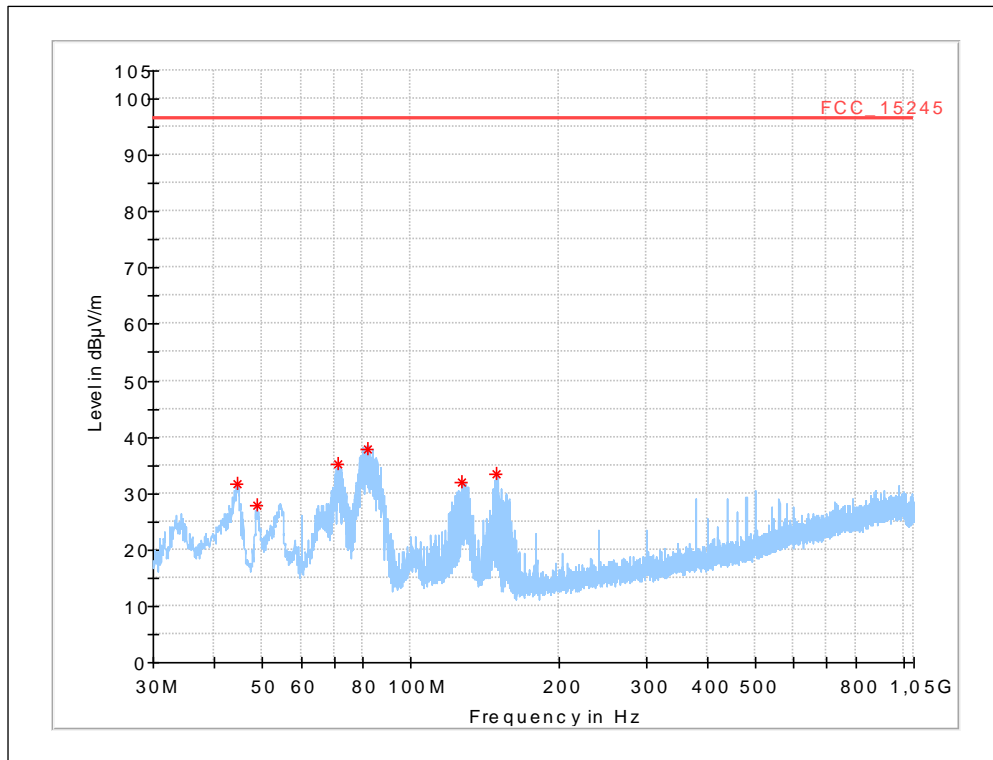

Frequency (MHz)	QuasiPeak (dBµV/m)	Limit (dBµV/m)	Margin (dB)	Meas. Time (ms)	Bandwidth (kHz)	Height (cm)	Pol	Azimuth (deg)	Corr. (dB/m)
44.484	31.59	96.5	64.91	200	120	100.0	V	180.0	15
48.768	27.75	96.5	68.75	200	120	100.0	V	0.0	15
71.208	35.06	96.5	61.44	200	120	300.0	V	90.0	11
81.612	37.83	96.5	58.67	200	120	300.0	V	135.0	11
127.155	32.04	96.5	64.46	200	120	100.0	V	0.0	11
148.728	33.33	96.5	63.17	200	120	100.0	V	45.0	10

FCC part 15.245 most stringent limit is met (PEAK → 96.5 dBµV/m / Average → 76.5 dBµV/m)

Plot No. 13: Low Ch., 1 GHz to 7 GHz, horizontal / vertical polarization

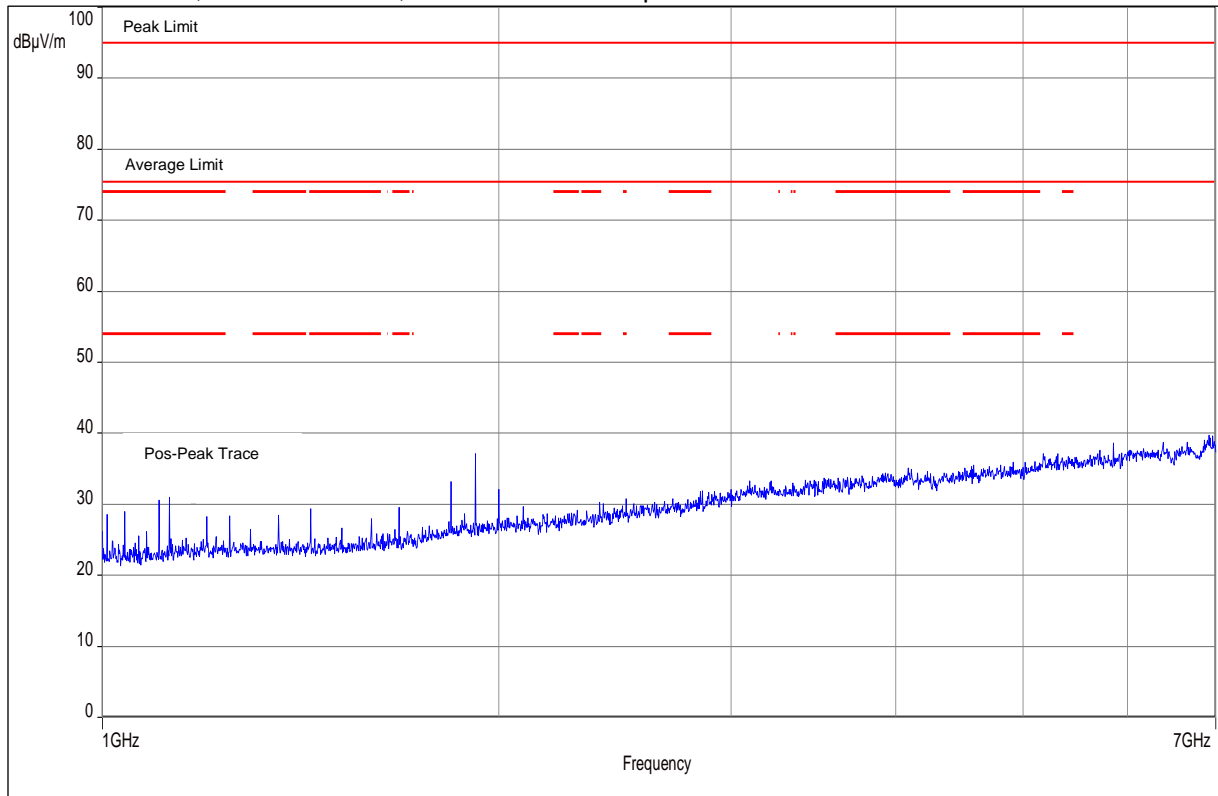

FCC part 15.245 most stringent limit is met (PEAK → 96.5 dBµV/m / Average → 76.5 dBµV/m)

Plot No. 14: Middle Ch., 1 GHz to 7 GHz, horizontal / vertical polarization

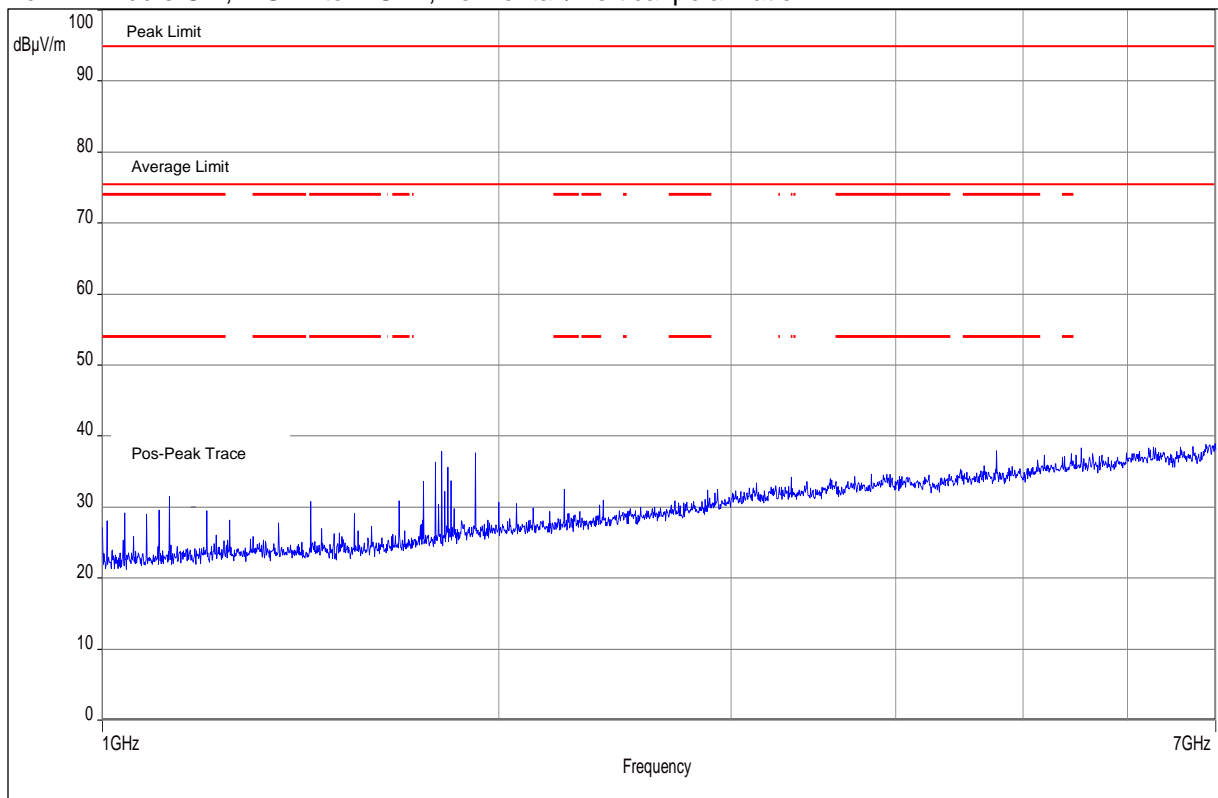

FCC part 15.245 most stringent limit is met (PEAK → 96.5 dBµV/m / Average → 76.5 dBµV/m)

Plot No. 15: High Ch., 1 GHz to 7 GHz, horizontal / vertical polarization

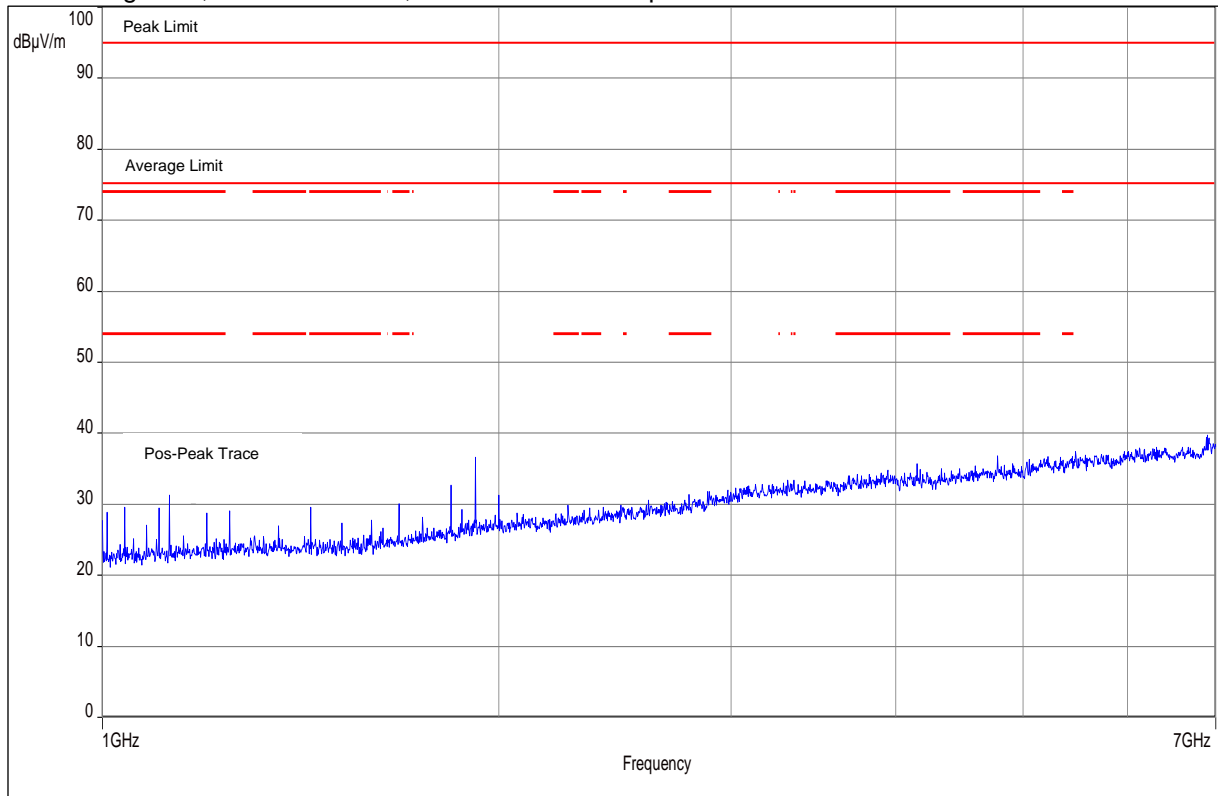

FCC part 15.245 most stringent limit is met (PEAK → 96.5 dBµV/m / Average → 76.5 dBµV/m)

Plot No. 16: High Ch., 7 GHz to 18 GHz, horizontal / vertical polarization

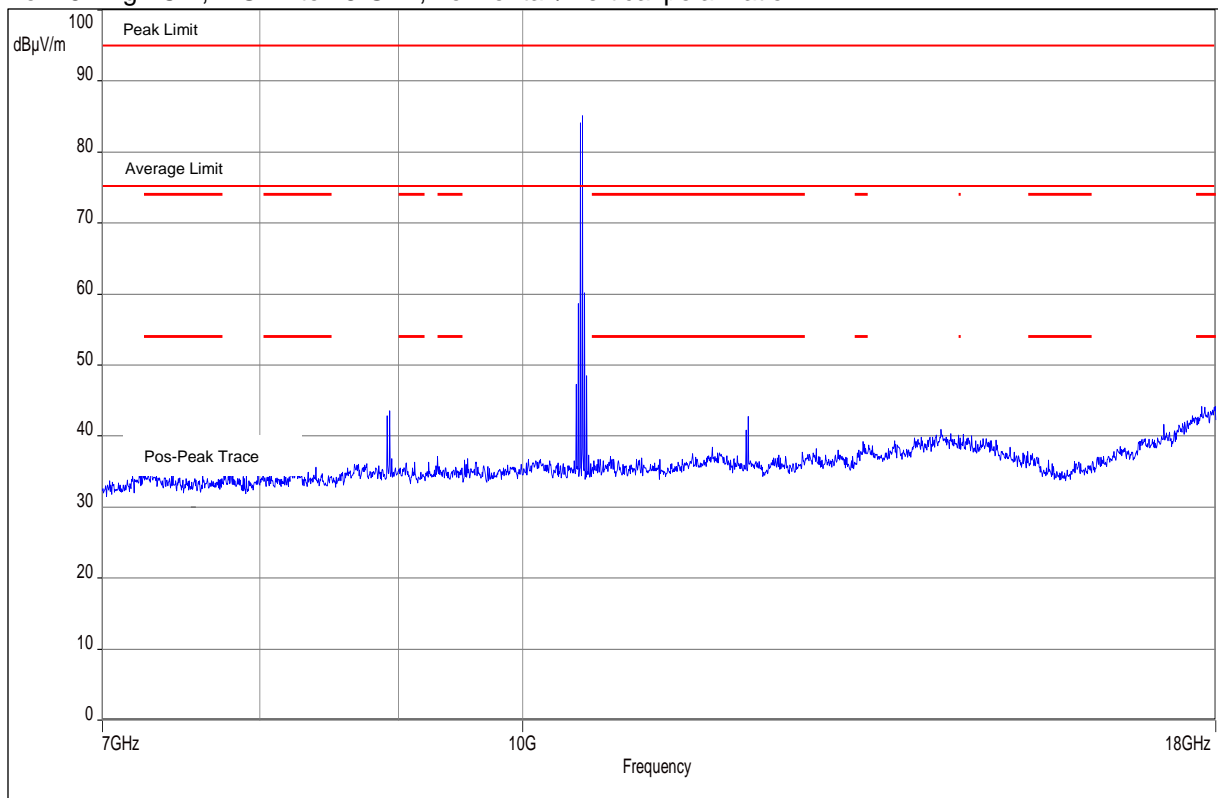

Plot shows the wanted signal at Low Channel

Plot No. 17: High Ch., 1 GHz to 10 GHz, horizontal / vertical polarization

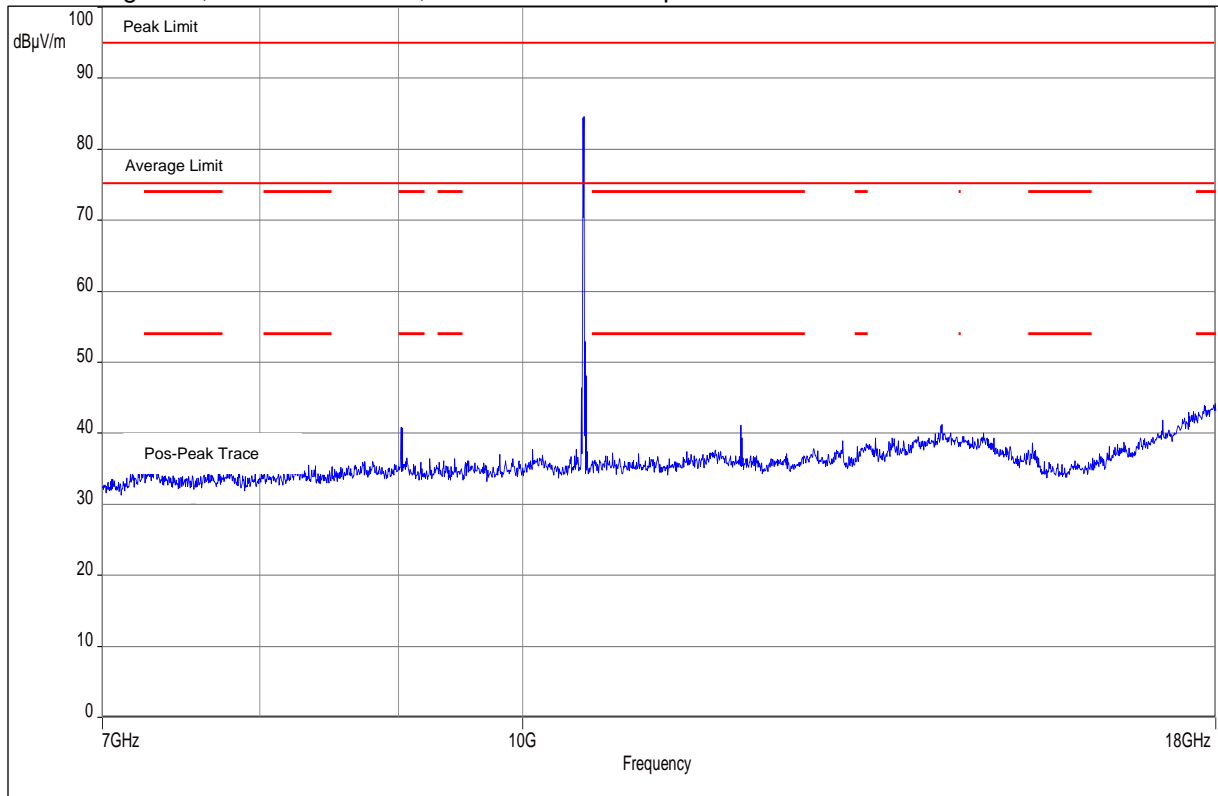

Plot shows the wanted signal at Middle Channel

Plot No. 18: High Ch., 1 GHz to 10 GHz, horizontal / vertical polarization

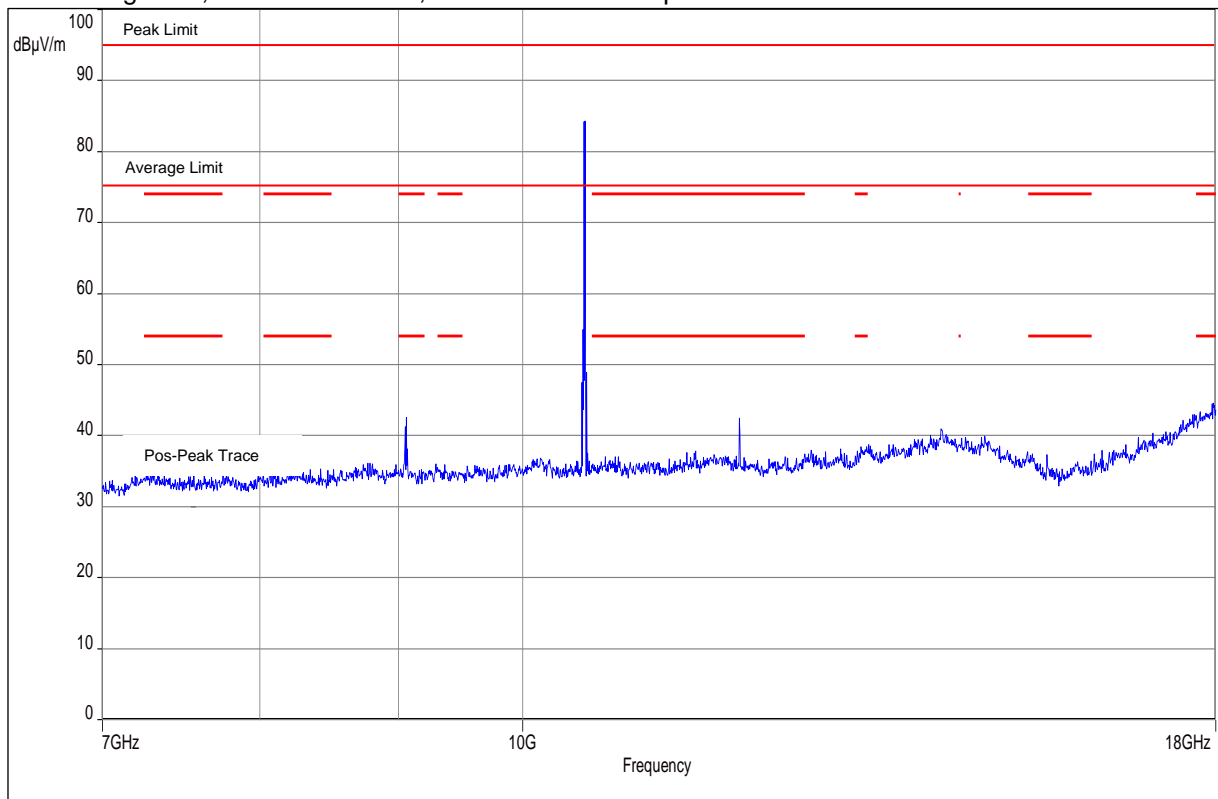

Plot shows the wanted signal at High Channel

Plot No. 19: Valid for all Channels, 18 GHz to 26.5 GHz, horizontal / vertical polarization

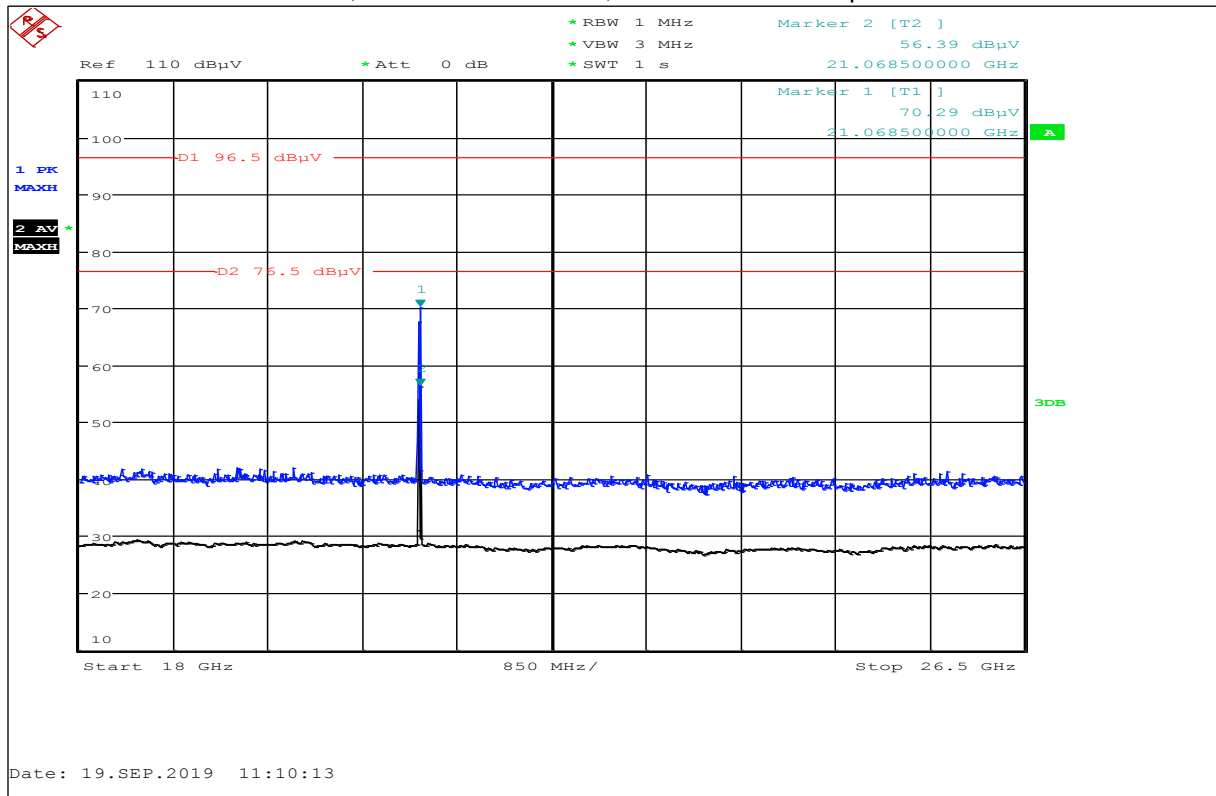

See next Plots, Plot 20 – Plot 21 – Plot 22

Plot No. 20: Low Ch., Harmonic @ 21 GHz (restricted band 17.7-21.4 GHz), horizontal / vertical polarization

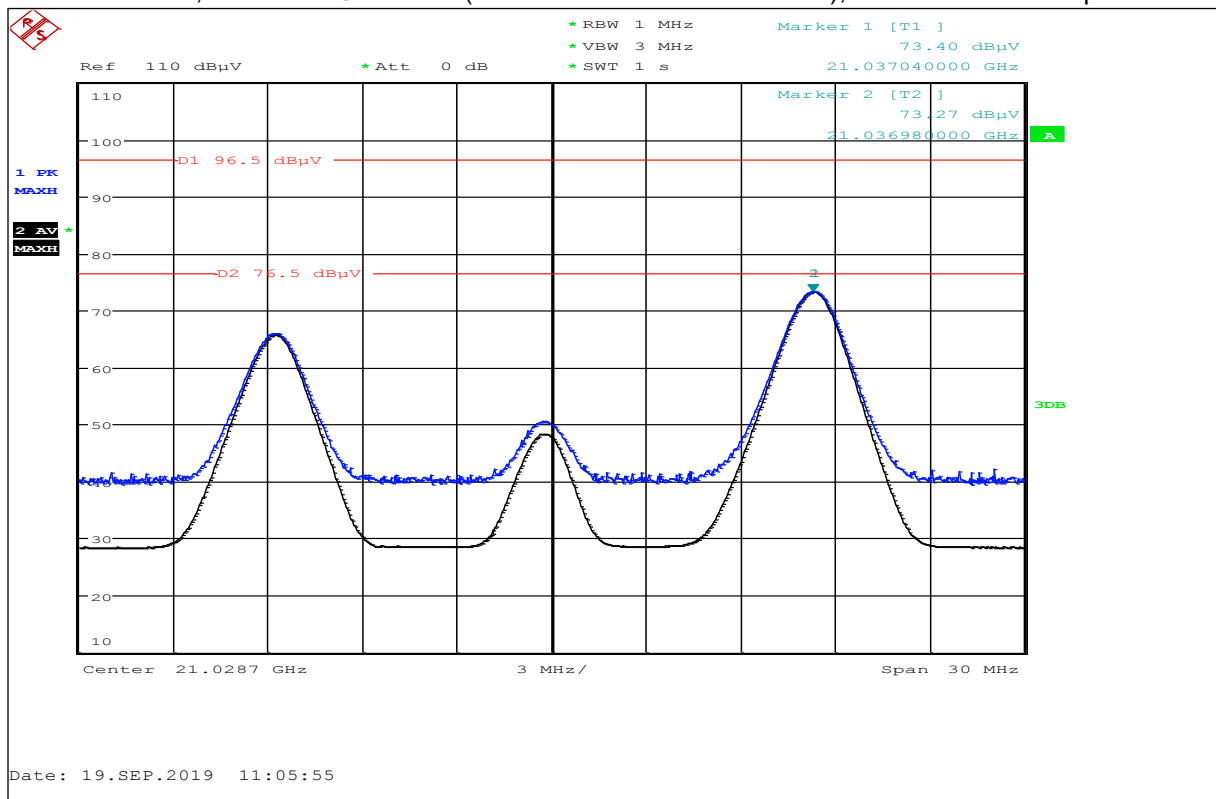

Peak Value: 73.40 dBµV/m (Limit 97.5 dBµV/m) / Average 73.27 dBµV/m (Limit 77.5 dBµV/m)

Plot No. 21: Middle Ch., Harmonic @ 21 GHz (restricted band 17.7-21.4 GHz), horizontal / vertical polarization

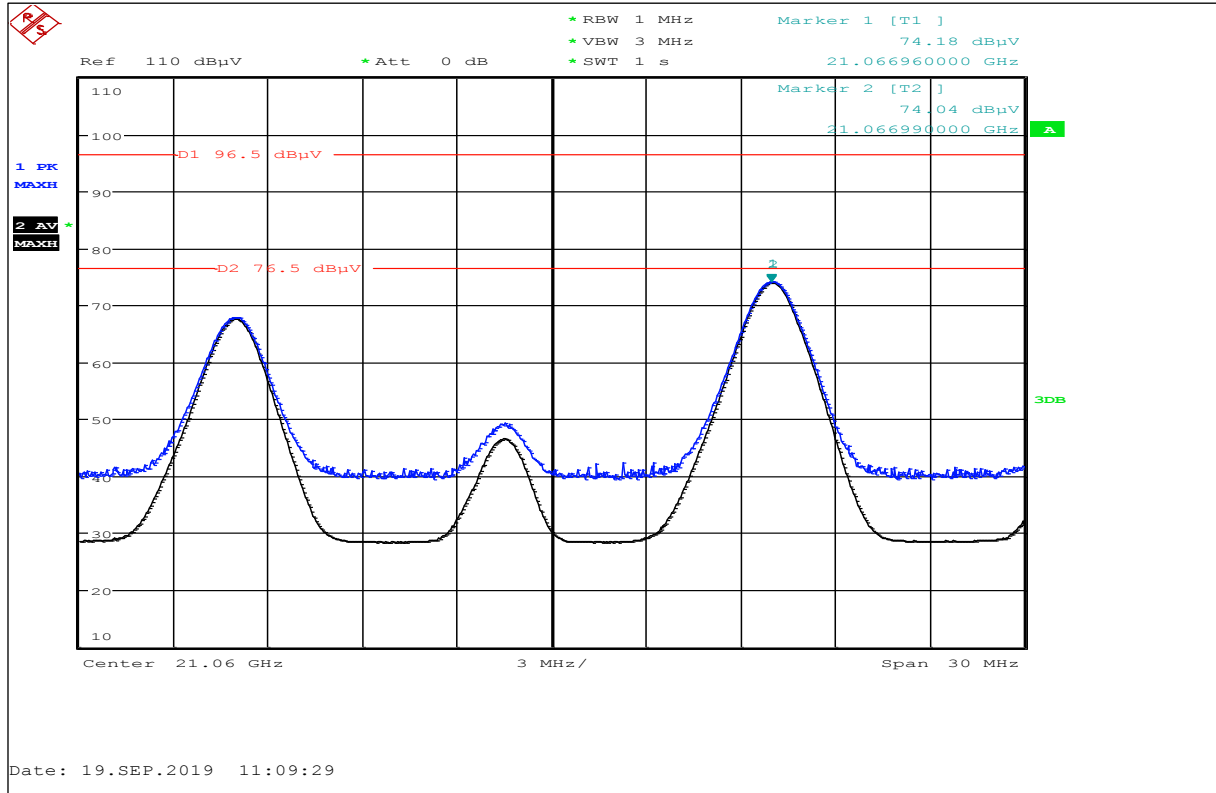

Peak Value: 74.18 dBµV/m (Limit 97.5 dBµV/m) / Average 74.04 dBµV/m (Limit 77.5 dBµV/m)

Plot No. 22: High Ch., Harmonic @ 21 GHz (restricted band 17.7-21.4 GHz), horizontal / vertical polarization

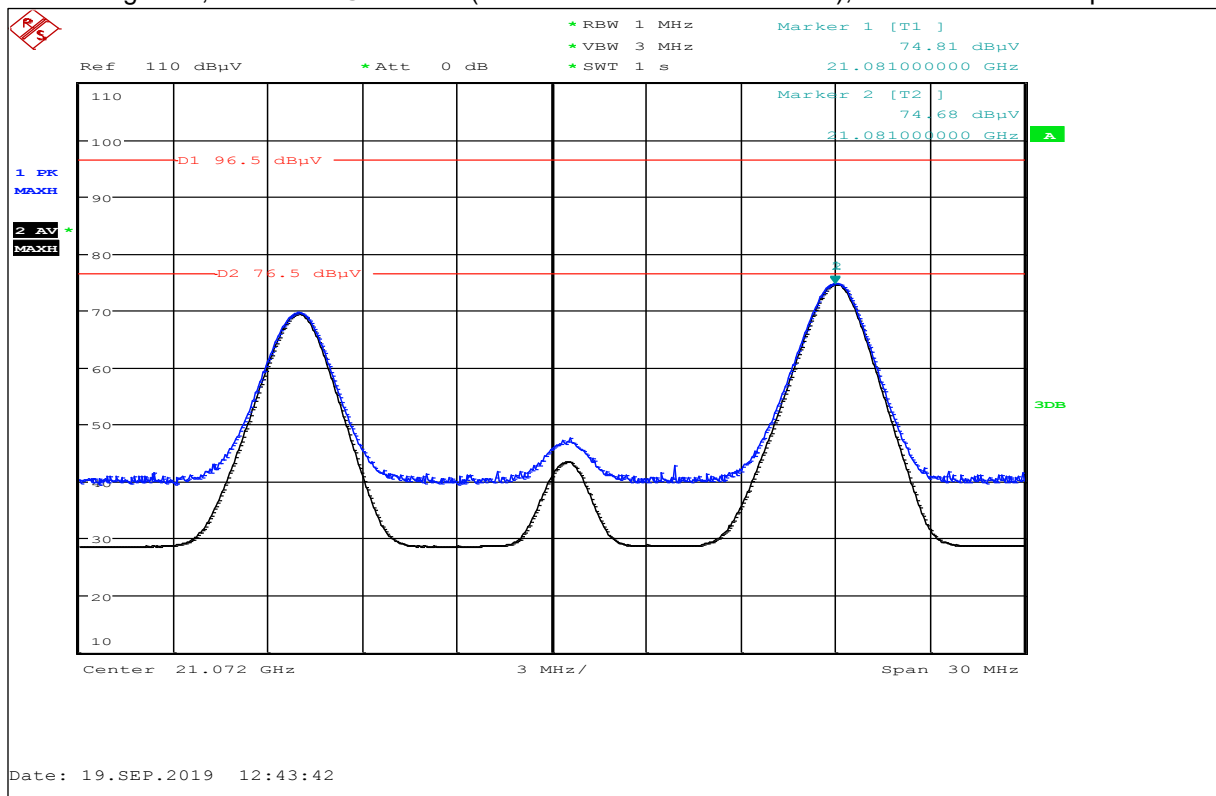

Peak Value: 74.81 dBµV/m (Limit 97.5 dBµV/m) / Average 74.68 dBµV/m (Limit 77.5 dBµV/m)

Plot No. 23: Valid for all Channels, 26.5 GHz to 40 GHz, horizontal / vertical polarization

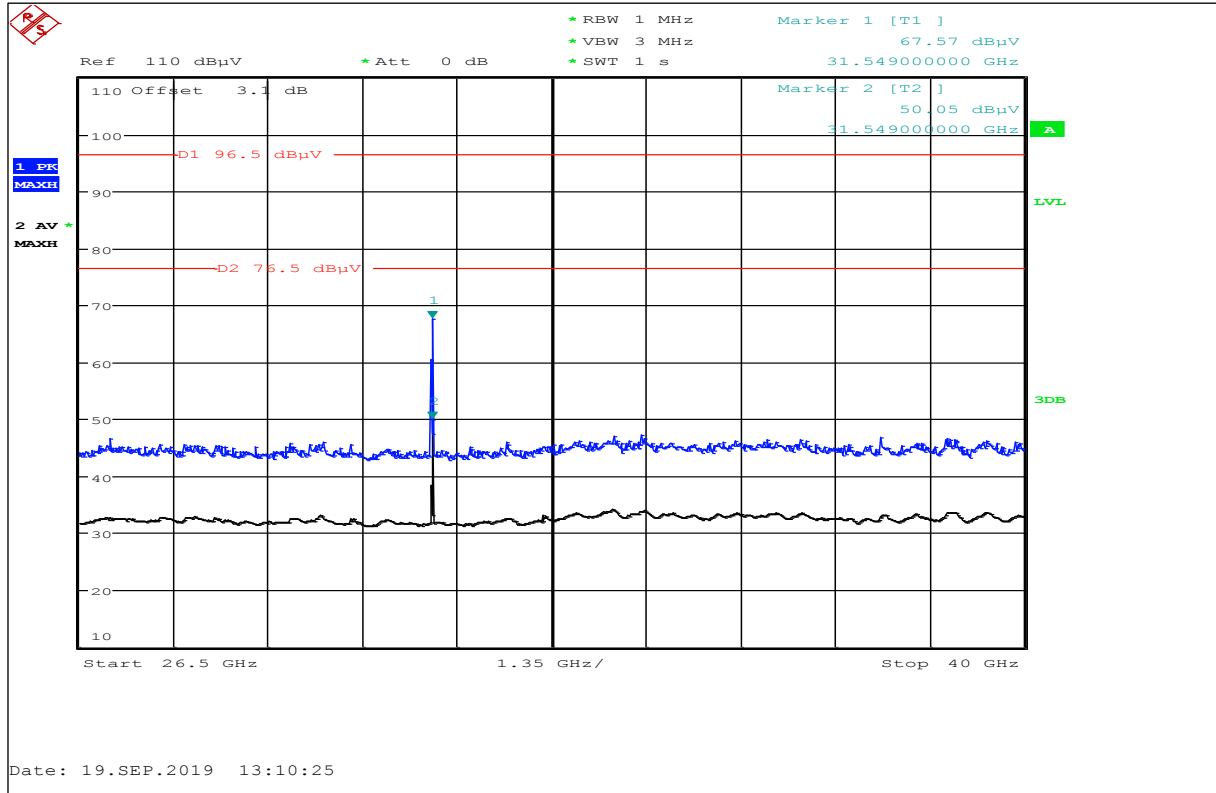

See next Plots, Plot 24 – Plot 25 – Plot 26

Plot No. 24: Low Ch., Harmonic @ 31 GHz (restricted band 31.2-31.8 GHz), horizontal / vertical polarization

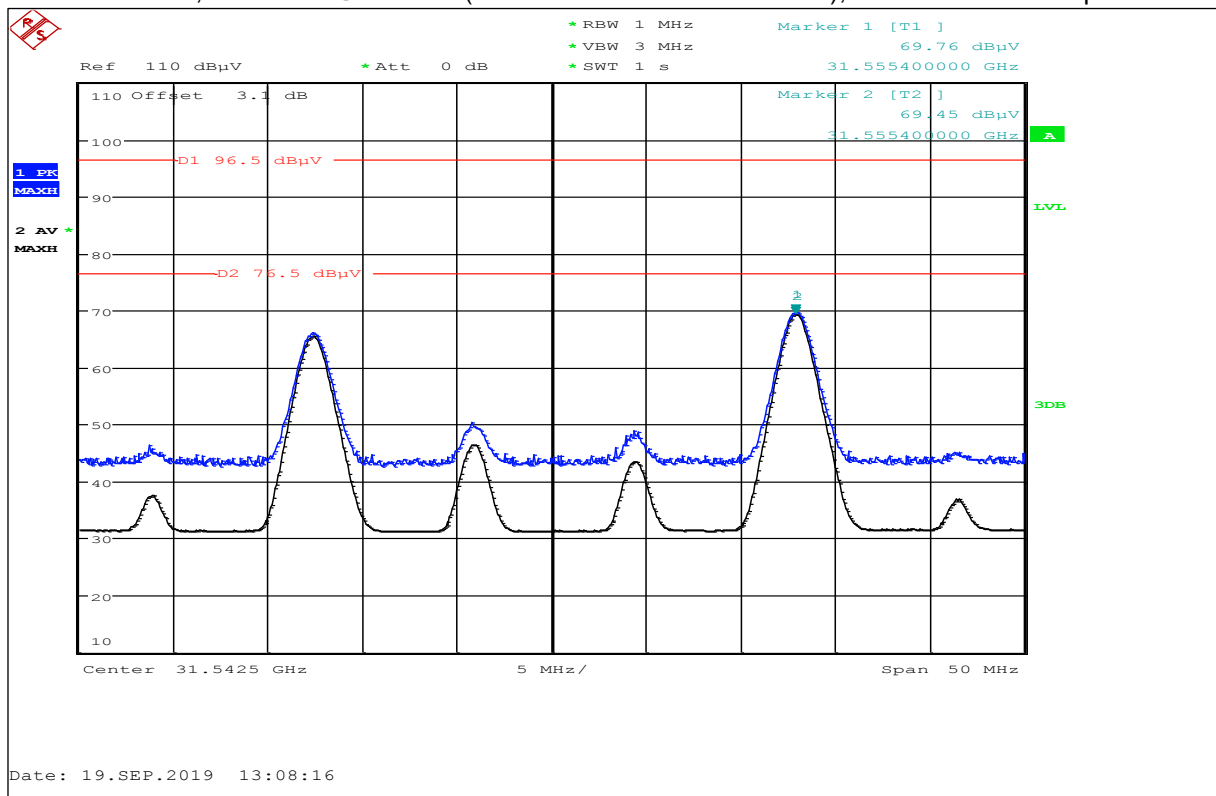

Peak Value: 69.76 dBµV/m (Limit 97.5 dBµV/m) / Average 69.45 dBµV/m (Limit 77.5 dBµV/m)

Plot No. 25: Middle Ch., Harmonic @ 31 GHz (restricted band 31.2-31.8 GHz), horizontal / vertical polarization

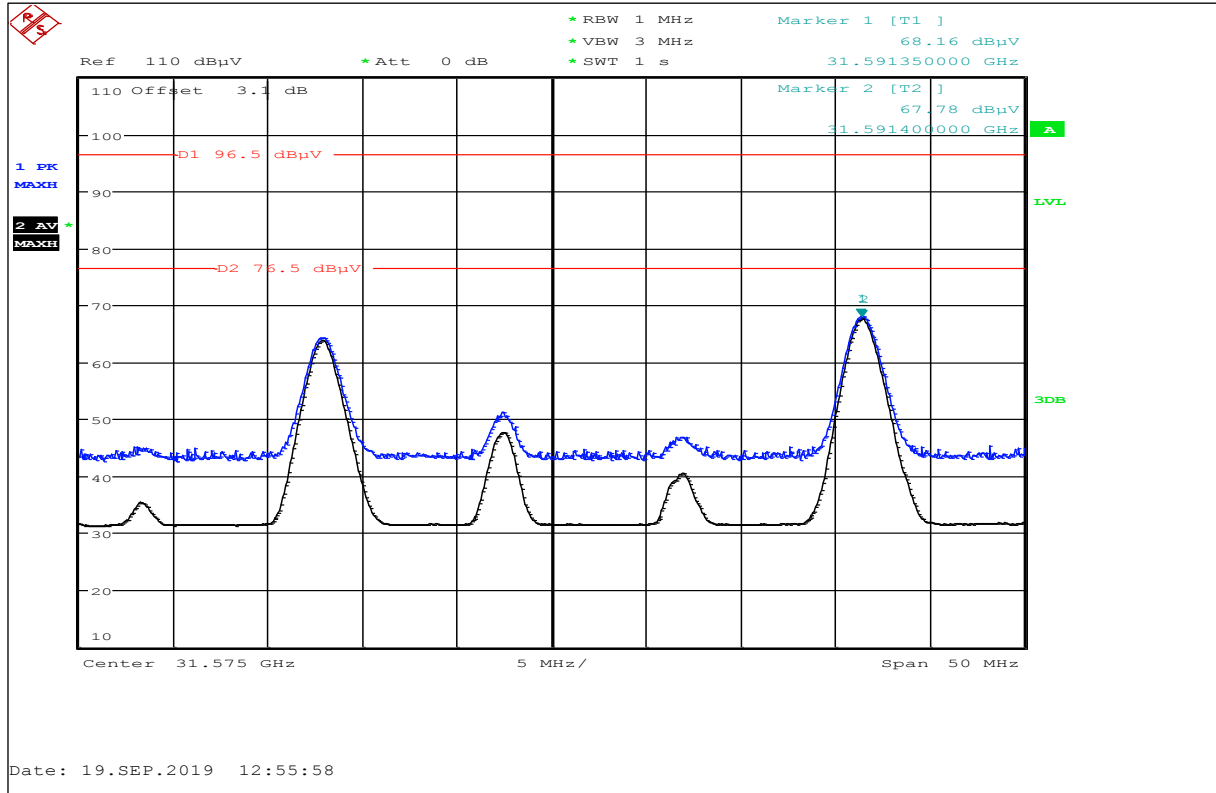

Peak Value: 68.16 dBµV/m (Limit 97.5 dBµV/m) / Average 67.78 dBµV/m (Limit 77.5 dBµV/m)

Plot No. 26: High Ch., Harmonic @ 31 GHz (restricted band 31.2-31.8 GHz), horizontal / vertical polarization

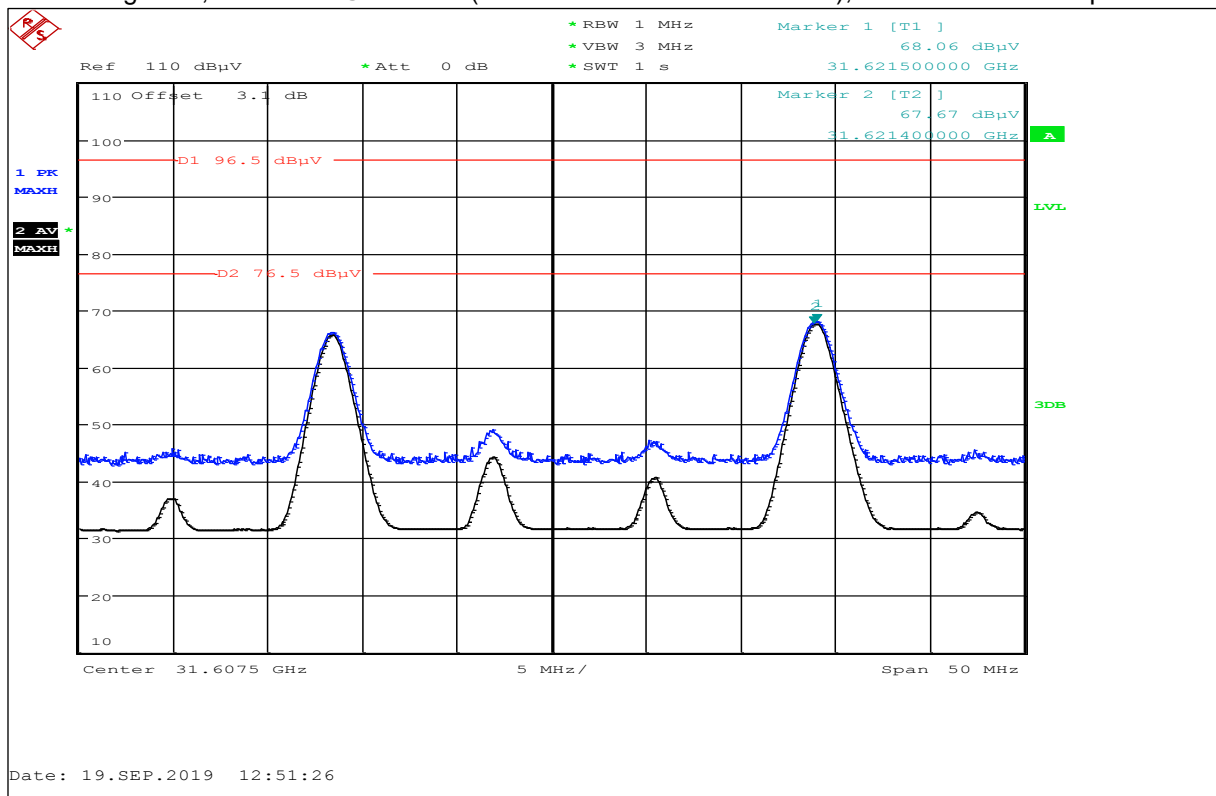

Peak Value: 68.06 dBµV/m (Limit 97.5 dBµV/m) / Average 67.67 dBµV/m (Limit 77.5 dBµV/m)

Plot No. 27: Valid for all Channels, 40 GHz to 50 GHz, horizontal / vertical polarization

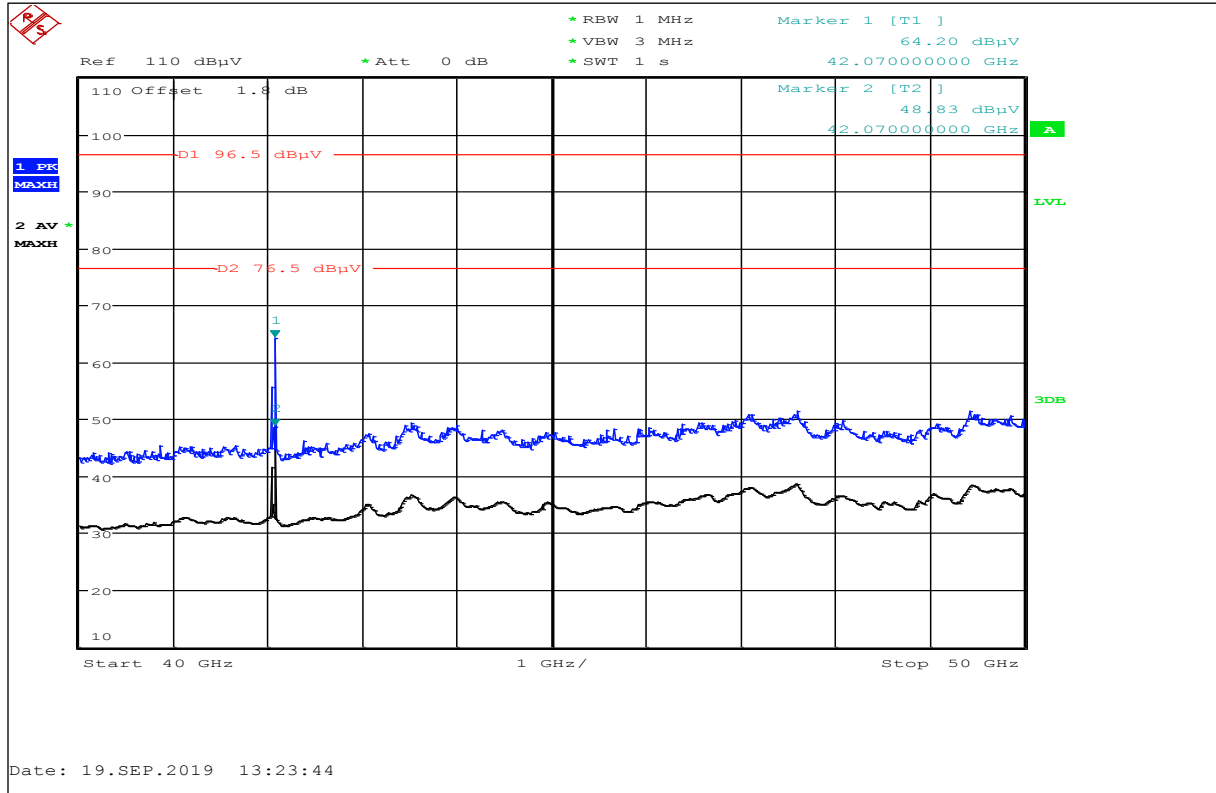

See next Plots, Plot 28 – Plot 29 – Plot 30

Plot No. 28: Low Ch., Harmonic@42 GHz (restricted band above 38.6 GHz), horizontal / vertical polarization

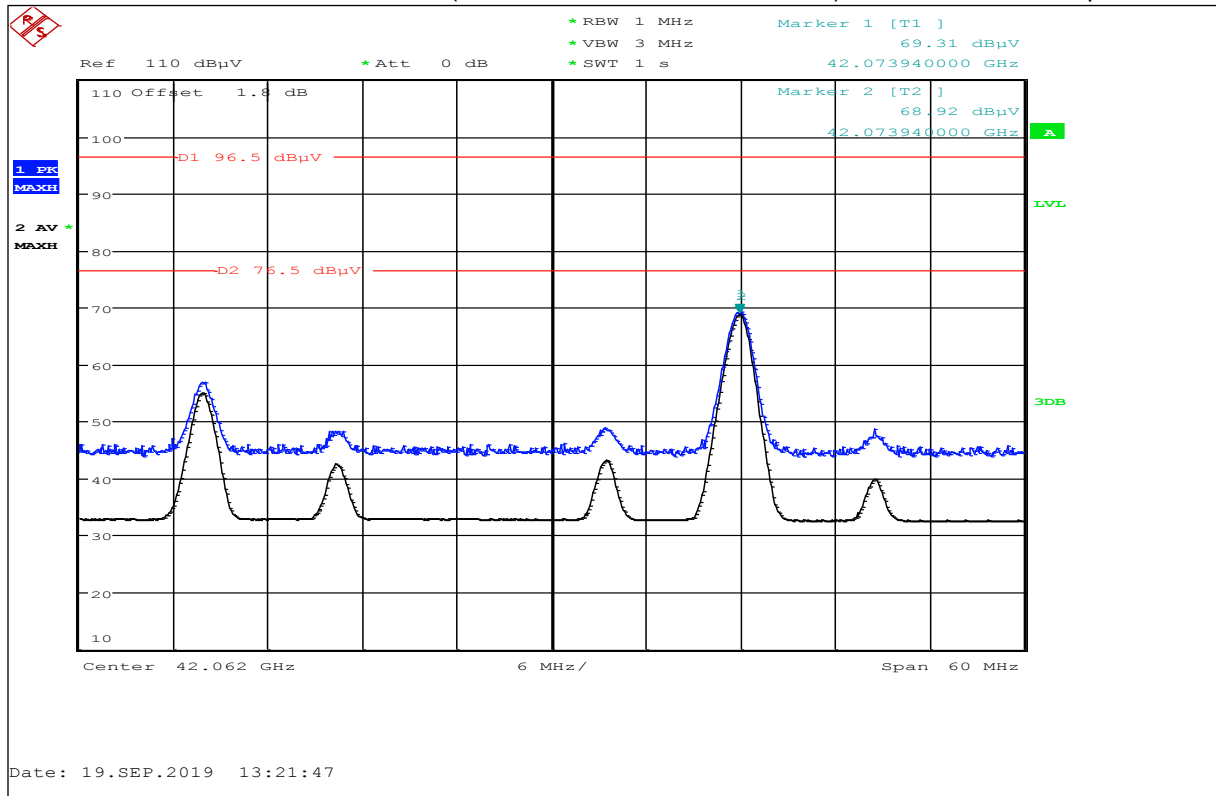

Peak Value: 69.31 dBµV/m (Limit 97.5 dBµV/m) / Average 68.92 dBµV/m (Limit 77.5 dBµV/m)

Plot No. 29: Middle Ch., Harmonic@42 GHz (restricted band above 38.6 GHz), horizontal / vertical polarization

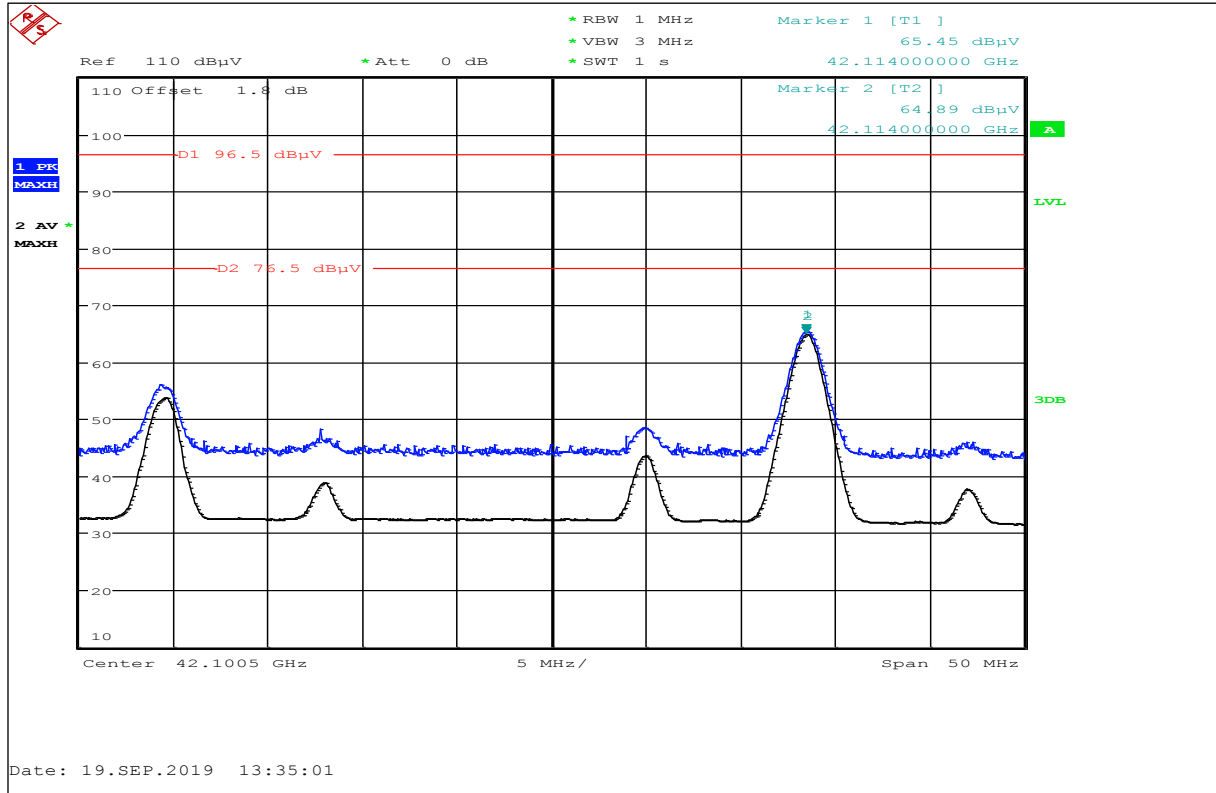

Peak Value: 65.45 dBµV/m (Limit 97.5 dBµV/m) / Average 64.89 dBµV/m (Limit 77.5 dBµV/m)

Plot No. 30: High Ch., Harmonic@42 GHz (restricted band above 38.6 GHz), horizontal / vertical polarization

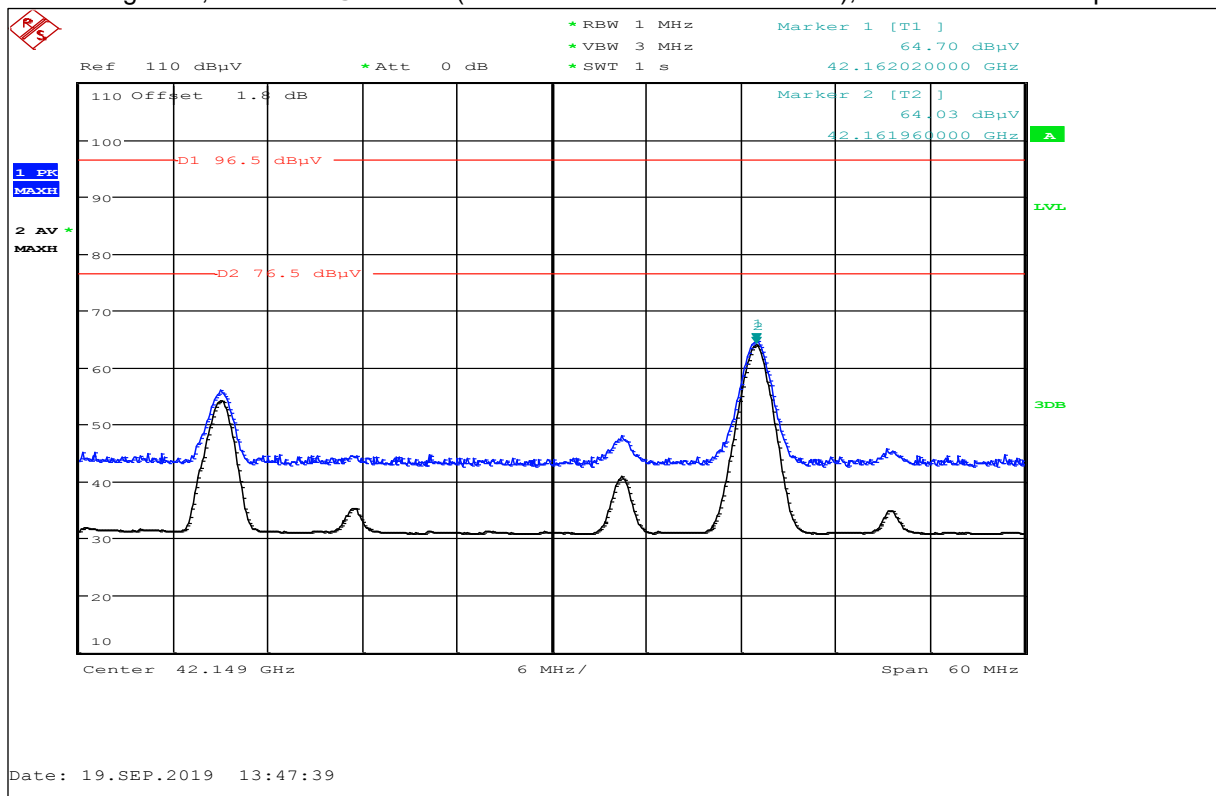

Peak Value: 64.70 dBµV/m (Limit 97.5 dBµV/m) / Average 64.03 dBµV/m (Limit 77.5 dBµV/m)

Plot No. 31: Valid for all Channels, 50 GHz to 75 GHz, horizontal / vertical polarization

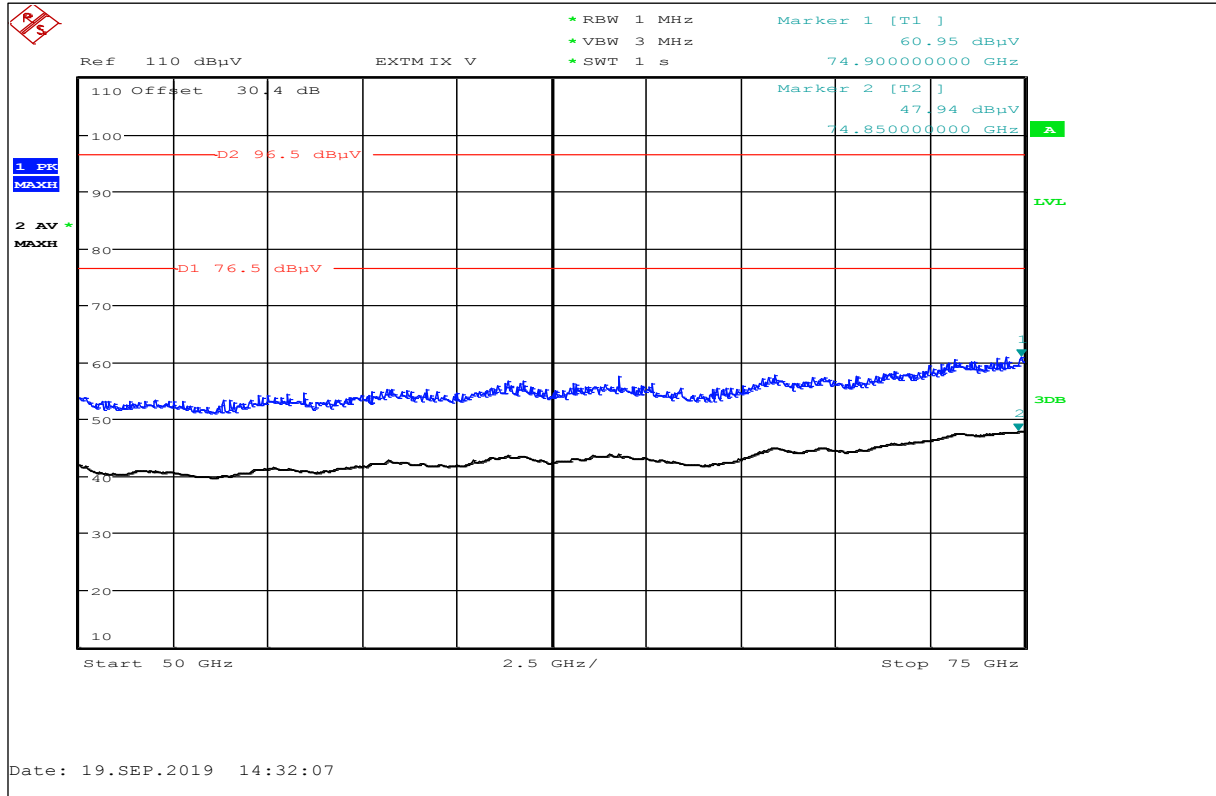

10.4 Conducted spurious emissions < 30 MHz

Description:

Measurement of the conducted spurious emissions in transmit mode below 30 MHz. Both power lines, phase and neutral line, are measured. Found peaks are re-measured with average and quasi peak detection to show compliance to the limits.

Measurement:

Measurement parameter	
Detector:	Peak - Quasi Peak / Average
Sweep time:	Auto
Video bandwidth:	F < 150 kHz: 200 Hz F > 150 kHz: 9 kHz
Resolution bandwidth:	F < 150 kHz: 1 kHz F > 150 kHz: 100 kHz
Span:	9 kHz to 30 MHz
Trace-Mode:	Max Hold

Limits:

FCC	IC	
CFR Part 15.207(a)	RSS-Gen 8.8	
Conducted Spurious Emissions < 30 MHz		
Frequency (MHz)	Quasi-Peak (dBµV/m)	Average (dBµV/m)
0.15 – 0.5	79 to 69* (Class A) 66 to 56* (Class B)	79 to 69* (Class A) 56 to 46* (Class B)
0.5 – 5	73 (Class A) 56 (Class B)	63 (Class A) 46 (Class B)
5 – 30.0	73 (Class A) 60 (Class B)	63 (Class A) 50 (Class B)

*Decreases with the logarithm of the frequency

Measurement results:

See plots below.

Plot No. 32: Phase line

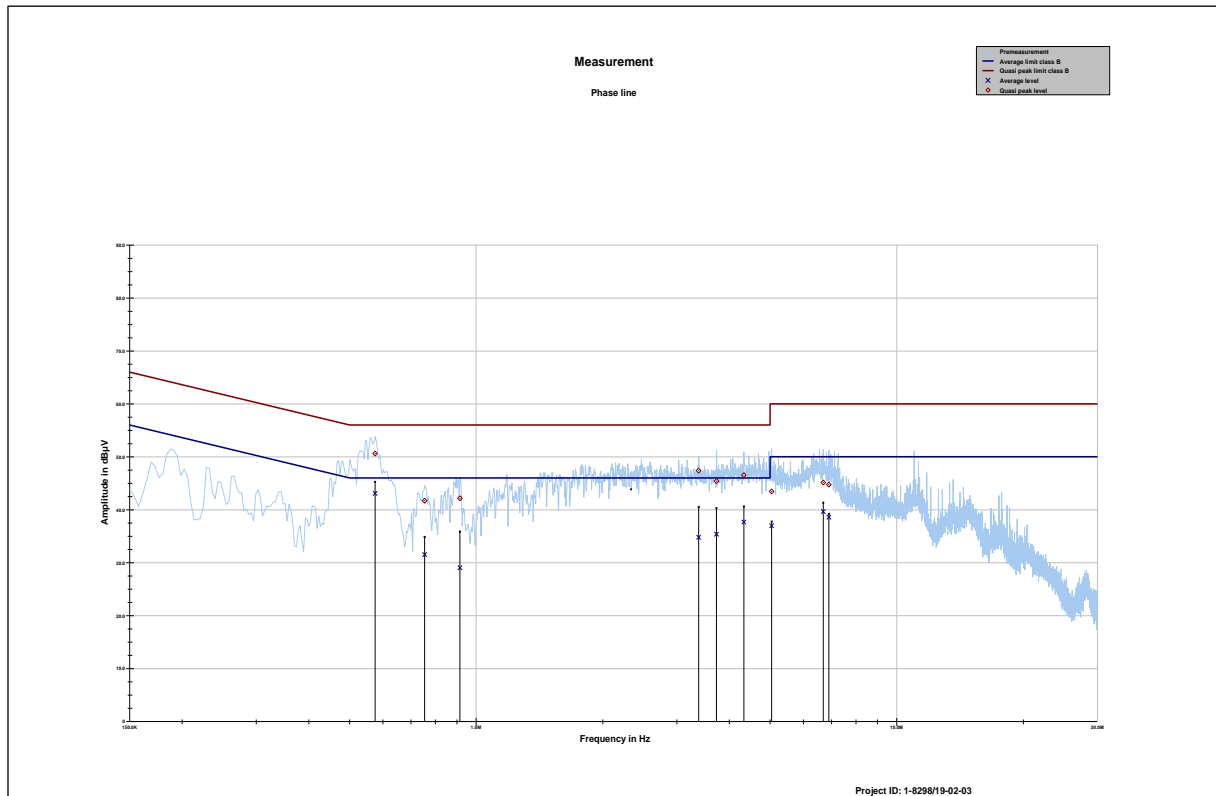

Project ID: 1-8298/19-02-03

Frequency	Quasi peak level	Margin quasi peak	Limit QP	Average level	Margin average	Limit AV
MHz	dBµV	dB	dBµV	dBµV	dB	dBµV
0.575362	50.62	5.38	56.000	43.09	2.91	46.000
0.754463	41.70	14.30	56.000	31.53	14.47	46.000
0.914906	42.16	13.84	56.000	29.02	16.98	46.000
3.381263	47.38	8.62	56.000	34.78	11.22	46.000
3.728269	45.42	10.58	56.000	35.38	10.62	46.000
4.332731	46.53	9.47	56.000	37.66	8.34	46.000
5.041669	43.45	16.55	60.000	36.97	13.03	50.000
6.690881	45.13	14.87	60.000	39.64	10.36	50.000
6.896100	44.74	15.26	60.000	38.58	11.42	50.000

Plot No. 33: Neutral line

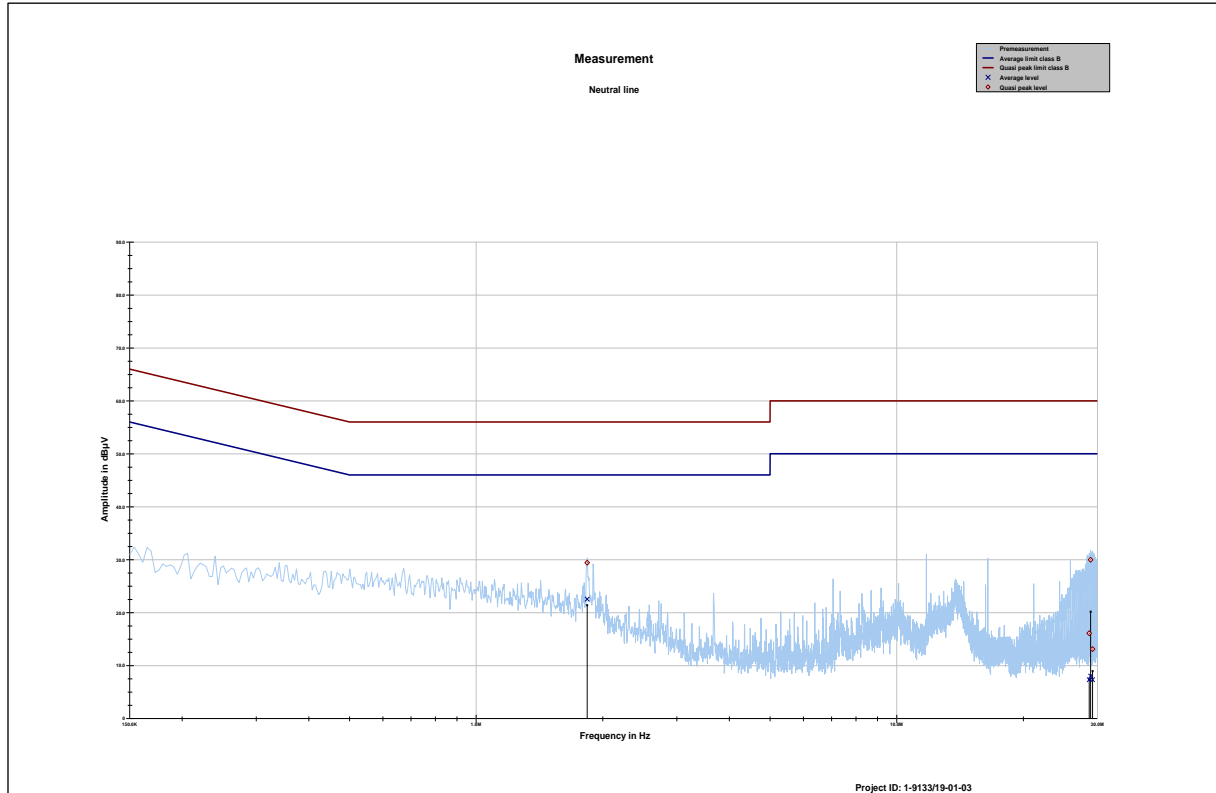

Frequency MHz	Quasi peak level dBµV	Margin quasi peak dB	Limit QP dBµV	Average level dBµV	Margin average dB	Limit AV dBµV
0.545512	50.71	5.29	56.000	41.24	4.76	46.000
0.747000	46.48	9.52	56.000	34.48	11.52	46.000
0.881325	46.10	9.90	56.000	33.77	12.23	46.000
1.164900	46.89	9.11	56.000	35.54	10.46	46.000
1.414894	45.96	10.04	56.000	32.55	13.45	46.000
1.802944	46.39	9.61	56.000	34.26	11.74	46.000
11.780306	45.27	14.73	60.000	42.91	7.09	50.000
12.563869	42.20	17.80	60.000	39.60	10.40	50.000
12.828788	45.42	14.58	60.000	40.18	9.82	50.000

Annex A Glossary

EUT	Equipment under test
DUT	Device under test
UUT	Unit under test
GUE	GNSS User Equipment
ETSI	European Telecommunications Standards Institute
EN	European Standard
FCC	Federal Communications Commission
FCC ID	Company Identifier at FCC
IC	Industry Canada
PMN	Product marketing name
HMN	Host marketing name
HVIN	Hardware version identification number
FVIN	Firmware version identification number
EMC	Electromagnetic Compatibility
HW	Hardware
SW	Software
Inv. No.	Inventory number
S/N or SN	Serial number
C	Compliant
NC	Not compliant
NA	Not applicable
NP	Not performed
PP	Positive peak
QP	Quasi peak
AVG	Average
OC	Operating channel
OCW	Operating channel bandwidth
OBW	Occupied bandwidth
OOB	Out of band
DFS	Dynamic frequency selection
CAC	Channel availability check
OP	Occupancy period
NOP	Non occupancy period
DC	Duty cycle
PER	Packet error rate
CW	Clean wave
MC	Modulated carrier
WLAN	Wireless local area network
RLAN	Radio local area network
DSSS	Dynamic sequence spread spectrum
OFDM	Orthogonal frequency division multiplexing
FHSS	Frequency hopping spread spectrum
GNSS	Global Navigation Satellite System
C/N₀	Carrier to noise-density ratio, expressed in dB-Hz

Annex B Document history

Version	Applied changes	Date of release
-/-	Initial release - DRAFT	2019-10-01
-/-	Minor changes	2019-10-11

Annex C Accreditation Certificate – D-PL-12076-01-04

first page

last page



Deutsche Akkreditierungsstelle GmbH

Entrusted according to Section 8 subsection 1 AkkStelleG in connection with Section 1 subsection 1 AkkStelleGBV
Signatory to the Multilateral Agreements of EA, ILAC and IAF for Mutual Recognition

Accreditation



The Deutsche Akkreditierungsstelle GmbH attests that the testing laboratory

CTC advanced GmbH
Untertürkheimer Straße 6-10, 66117 Saarbrücken

is competent under the terms of DIN EN ISO/IEC 17025:2005 to carry out tests in the following fields:

Telecommunication (TC) and Electromagnetic Compatibility (EMC) for Canadian Standards

The accreditation certificate shall only apply in connection with the notice of accreditation of 11.01.2019 with the accreditation number D-PL-12076-01 and is valid until 21.04.2021. It comprises the cover sheet, the reverse side of the cover sheet and the following annex with a total of 7 pages.

Registration number of the certificate: **D-PL-12076-01-04**

Frankfurt am Main, 11.01.2019

Dipl.-Ing. Uwe Zimmermann
Head of Division

See notes (continued)

Deutsche Akkreditierungsstelle GmbH

Office Berlin
Spittelmarkt 10
10117 Berlin

Office Frankfurt am Main
Europa-Allee 52
60327 Frankfurt am Main

Office Braunschweig
Bundesallee 100
38116 Braunschweig

The publication of extracts of the accreditation certificate is subject to the prior written approval by Deutsche Akkreditierungsstelle GmbH (DAkKS). Exempted is the unchanged form of separate disseminations of the cover sheet by the conformity assessment body mentioned overleaf.

No impression shall be made that the accreditation also extends to fields beyond the scope of accreditation attested by DAkKS.

The accreditation was granted pursuant to the Act on the Accreditation Body (AkkStelleG) of 31 July 2009 (Federal Law Gazette I p. 2625) and the Regulation (EC) No 765/2008 of the European Parliament and of the Council of 9 July 2008 setting out the requirements for accreditation and market surveillance relating to the marketing of products (Official Journal of the European Union L 218 of 9 July 2008, p. 30). DAkKS is a signatory to the Multilateral Agreements for Mutual Recognition of the European co-operation for Accreditation (EA), International Accreditation Forum (IAF) and International Laboratory Accreditation Cooperation (ILAC). The signatories to these agreements recognise each other's accreditations.

The up-to-date state of membership can be retrieved from the following websites:
EA: www.european-accreditation.org
ILAC: www.ilac.org
IAF: www.iaf.nu

Note: The current certificate annex is published on the website (link see below) of the Accreditation Body DAkKS or may be received by CTC advanced GmbH on request

<https://www.dakks.de/as/ast/d/D-PL-12076-01-04.pdf>

Annex D Accreditation Certificate – D-PL-12076-01-05

first page

last page



Deutsche Akkreditierungsstelle GmbH

Entrusted according to Section 8 subsection 1 AkkStelleG in connection with Section 1 subsection 1 AkkStelleGBV Signatory to the Multilateral Agreements of EA, ILAC and IAF for Mutual Recognition

Accreditation



The Deutsche Akkreditierungsstelle GmbH attests that the testing laboratory

CTC advanced GmbH Untertürkheimer Straße 6-10, 66117 Saarbrücken

is competent under the terms of DIN EN ISO/IEC 17025:2005 to carry out tests in the following fields:

Telecommunication (FCC Requirements)

The accreditation certificate shall only apply in connection with the notice of accreditation of 11.01.2019 with the accreditation number D-PL-12076-01 and is valid until 21.04.2021. It comprises the cover sheet, the reverse side of the cover sheet and the following annex with a total of 5 pages.

Registration number of the certificate: D-PL-12076-01-05

Frankfurt am Main, 11.01.2019

Dr. Bodo Lüse Zimmermann Head of Division

Deutsche Akkreditierungsstelle GmbH

Office Berlin Spittelmarkt 10 10117 Berlin

Office Frankfurt am Main Europa-Allee 52 60327 Frankfurt am Main

Office Braunschweig Bundesallee 100 38116 Braunschweig

The publication of extracts of the accreditation certificate is subject to the prior written approval by Deutsche Akkreditierungsstelle GmbH (DAkkS). Exempted is the unchanged form of separate disseminations of the cover sheet by the conformity assessment body mentioned overleaf.

No impression shall be made that the accreditation also extends to fields beyond the scope of accreditation attested by DAkkS.

The accreditation was granted pursuant to the Act on the Accreditation Body (AkkStelleG) of 31 July 2009 (Federal Law Gazette I p. 2625) and the Regulation (EC) No 765/2008 of the European Parliament and of the Council of 9 July 2008 setting out the requirements for accreditation and market surveillance relating to the marketing of products (Official Journal of the European Union L 218 of 9 July 2008, p. 30). DAkkS is a signatory to the Multilateral Agreements for Mutual Recognition of the European co-operation for Accreditation (EA), International Accreditation Forum (IAF) and International Laboratory Accreditation Cooperation (ILAC). The signatories to these agreements recognise each other's accreditations.

The up-to-date state of membership can be retrieved from the following websites:

EA: www.european-accreditation.org
ILAC: www.ilac.org
IAF: www.iaf.nu

Note: The current certificate annex is published on the website (link see below) of the Accreditation Body DAkkS or may be received by CTC advanced GmbH on request

https://www.dakks.de/as/ast/d/D-PL-12076-01-05.pdf

END OF TEST REPORT